

EPSON®

EMP-7850

- Setup 1
- Connections 1
- Projection preparation and adjustments 3
- Turning the projector off 6
- Functions for Enhancing Projection 7
- List of configuration setting menus 11
- Troubleshooting 12
- Replacing the Lamp 15
- List of Supported Monitor Displays Last page

Be sure to read the User's Guide carefully before using the projector.

WARNING

Do not look directly into the projector's lens.

Quick Reference Guide

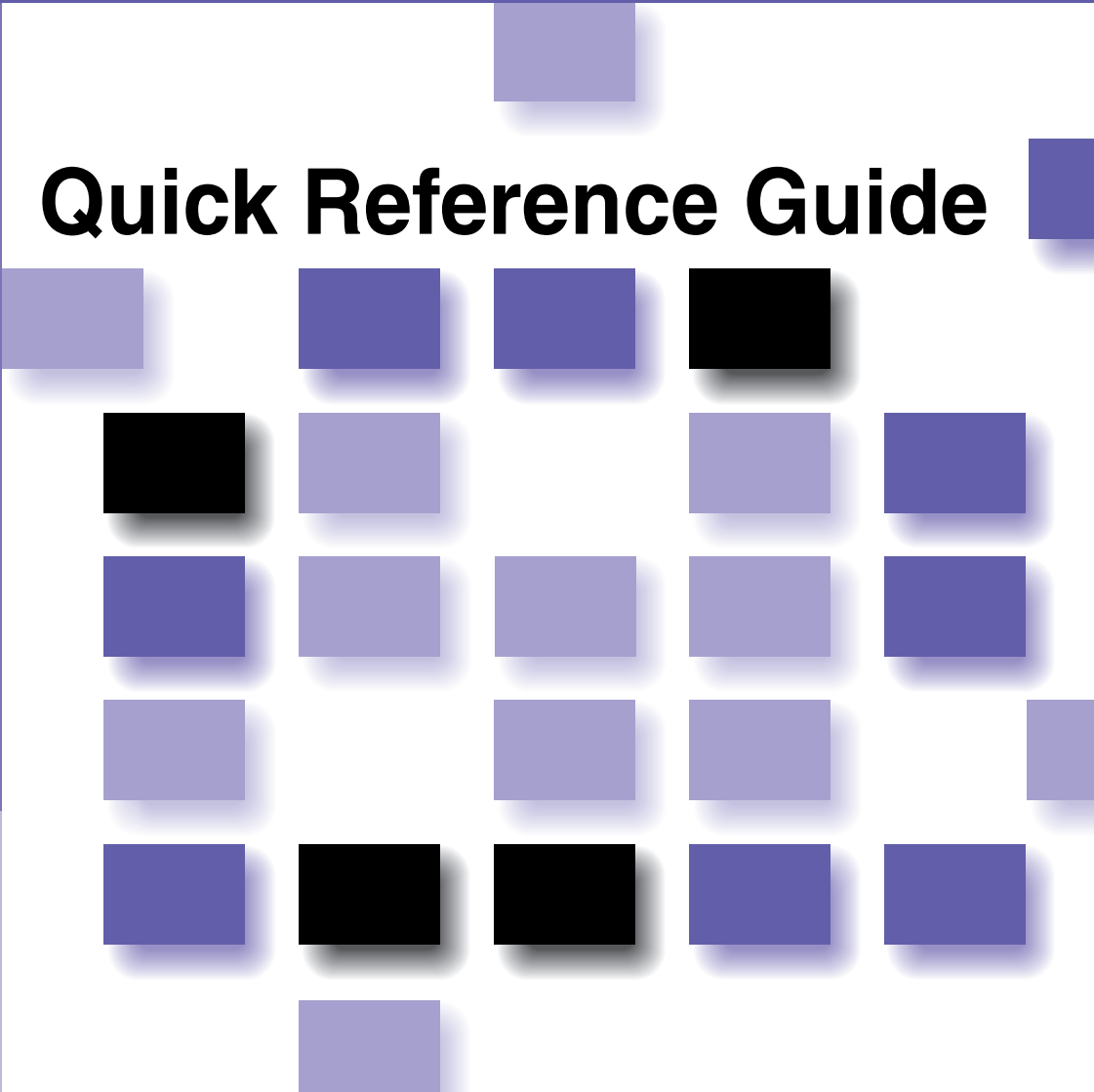

Setup

Set up the projector so that the distance from the screen to the projector's lens is 77–1113 cm. The shorter the distance between the two, the smaller will be the images, and the greater the distance, the larger will be the images. Adjust the distance in accordance with the size of the screen. If using an optional lens, refer to the documentation for the lens.

 **User's Guide**
"Screen Size and
Projection Distance"

Connections

Be sure to turn the power for all components off before making any of the following connections.

 **User's Guide** "Connecting to a Computer"
"Connecting to a Video Source"

Connecting to a computer

The [Audio] port is the port that is in the same box as the port being used to input the video signals.

If the source is connected to the [Computer] port or [DVI] port, the audio signals will be output according to the "Computer/DVI Audio Input" setting in the "Audio" menu.

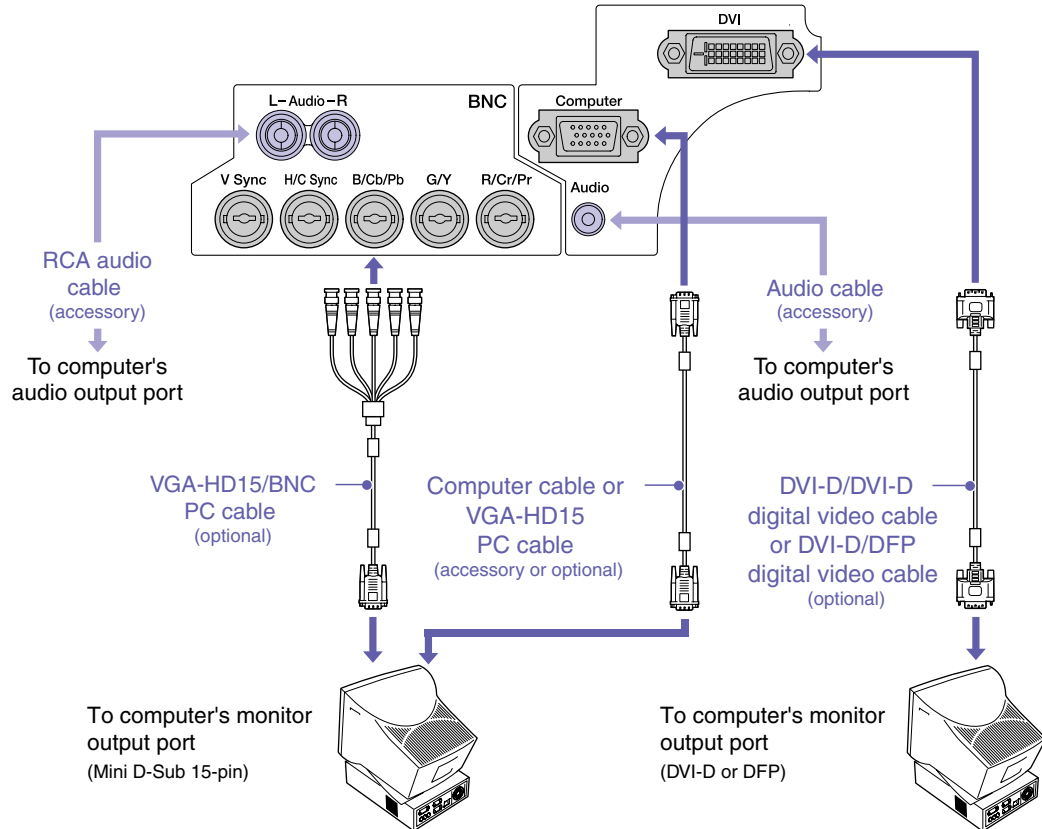

Connecting to video equipment

The [Audio] port to use is the port that is in the same box as the port being used to input the video signals.

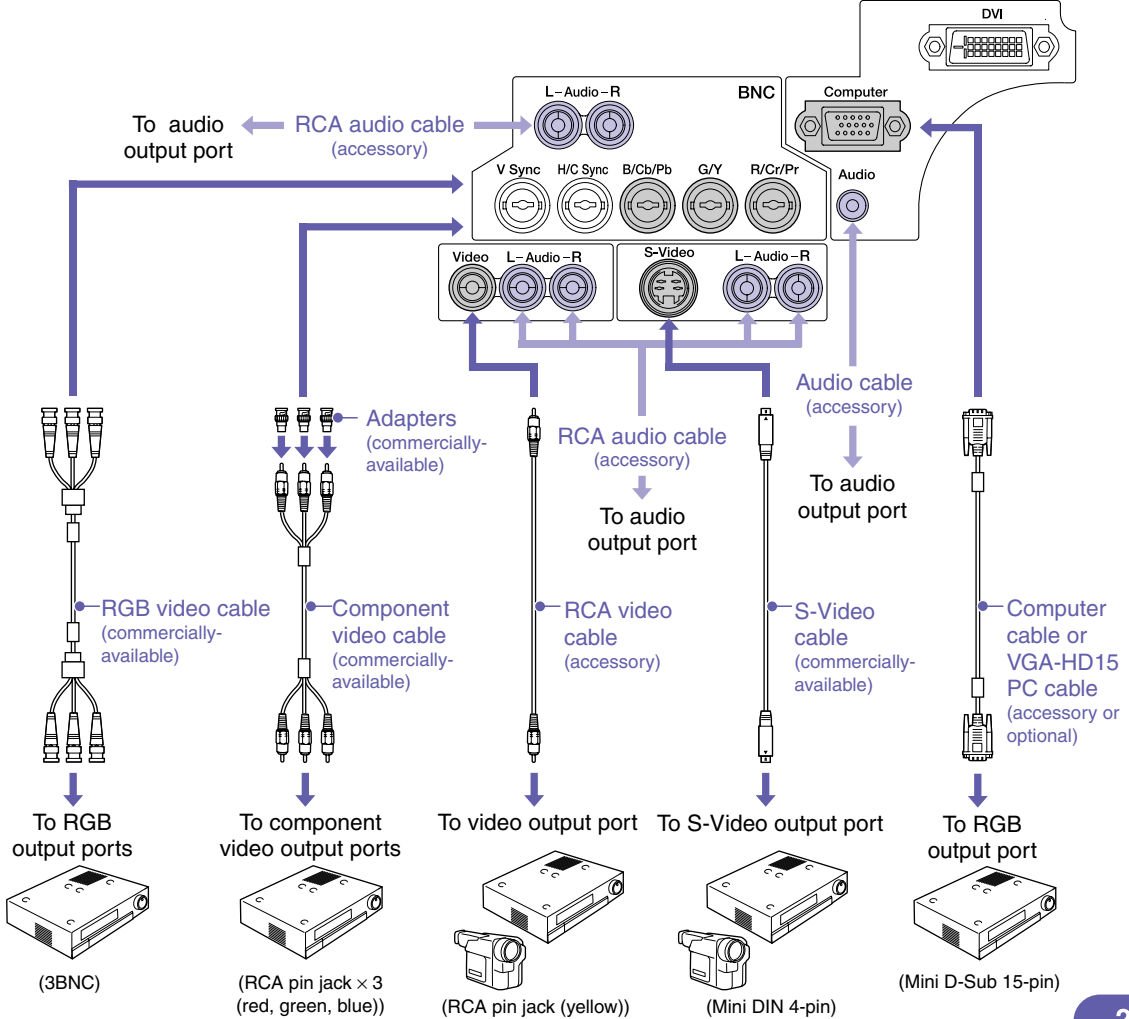

Projection preparation and adjustments

1 Set the [R/C] switch to "ON".

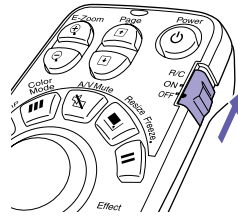

Check that the power cable is connected to the projector and to the electrical outlet.

2 Turn the power on for all input equipment.



For a video source, press the [Play] button.

3 Press the  button.

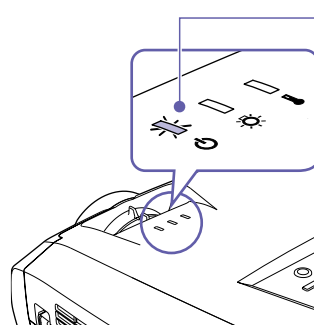

Projection starts after a short period.

 **(Operation) indicator**

Flashes green (warm-up in progress/approx. 40 seconds)
→ Lights green (projection in progress)

If "Password Protect" has been enabled, the "Password Protect Release" screen will be displayed when the power is turned on for the first time after the power plug is connected to an electrical outlet. Type in the password.

 User's Guide "Preventing theft (Password Protect)"

4 Select the images to be projected.

- If only one signal source is connected, images from that source will be projected automatically.
- If more than one device is connected to the projector, use the [Source] button to select the image source to be projected.

If using the  or  buttons to select the source, you can change the signal setting by pressing the button repeatedly.

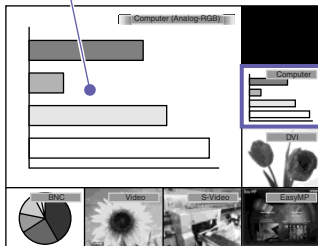

To select images to be projected while viewing all images being input. (Preview Function)

Active window



1. Press the  button.

The image can be changed directly by selecting the desired image source with the [Source] button.







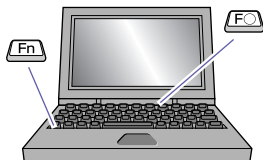





2. To view the images in more detail, switch to the active window. Tilt the  button to select an image and then press the  button.
3. Project the images in the active window. Press the  button.

User's Guide "Selecting an Image Source While Viewing Projected Images (Preview Function)"





If the source does not change to the laptop PC connected by a computer cable.



Examples of changing output

NEC	 + 
Panasonic	 + 
TOSHIBA	 + 
IBM	 + 
SONY	 + 
FUJITSU	 + 
Macintosh	After startup, change the Control Panel adjustments so that mirroring is active

You may need to change the output destination using the keyboard or by changing settings.

To change, hold down the  key and press the  key (with a symbol such as  or  on it).

Once the setting is changed, projection will start after a short period.

Computer documentation

If images are still not projected after carrying out the above, see p.12.

Adjusting projected images

Adjusting the projection angle

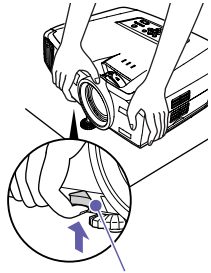

Foot adjust lever

While pulling the foot adjust lever, lift up the front of the projector so that the front adjustable foot can extend. The Auto Keystone function will operate when the projector is tilted.

To retract the front adjustable foot, gently push down on the projector while pulling the foot adjust lever.

User's Guide
"Adjusting the Feet"

Adjusting the image size and focus

Focus adjustment

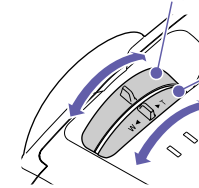

Fine adjustments to image size

Enlarge: Turn to "W"
Reduce: Turn to "T"

User's Guide "Zoom Function"
"Focus Adjustment"

- If tilted horizontally, adjust using the left and right rear adjustable feet.

Rear adjustable foot

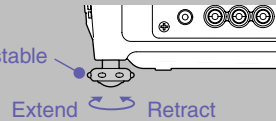

- If the height of the image is too short after Auto Keystone is carried out, adjust the height as follows. For adjustment using the configuration menus: "Setting" - "Keystone" - "H/V-Keystone" - "Height"

User's Guide "Height Correction"

Fitting the image size to the projection screen (Quick Corner)

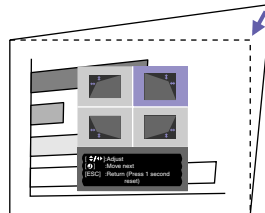

The four corners of the image can be adjusted so that the image fits the screen exactly. This cannot be used together with Auto Keystone.

1. Press the button.

Select "Quick Corner" from the "Keystone" sub-menu of the "Setting" menu.

2. Select the corner to be adjusted.

Press the button.

3. Adjust the corner to the desired position.

Tilt the button.

Once the adjustment is complete, press the button.

User's Guide

"Correcting Keystone Distortion so that the Projection Area Fits the Screen Exactly (Quick Corner)"

If projecting onto a blackboard or wall

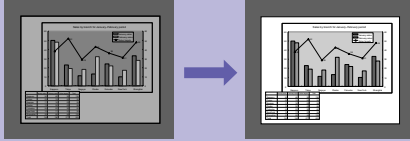

Wall Shot

Images can be automatically corrected and projected without loss of original colour onto surfaces which are not white. In addition, the tints can be adjusted in accordance with the brightness of the room.

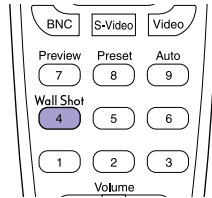

1. Press the ^{Wall Shot} 4 button.

The current status is displayed on the screen.

2. Press the ^{Wall Shot} 4 button while the status is displayed to change it to "Wall Shot ON".

Colours in the order red → green → blue → black will be projected for approximately five seconds, and then the corrected images will be displayed.

User's Guide "Wall Shot"

When the projector's power is turned off, images will be projected next time with the status set to "Wall Shot OFF". If projecting in the same location as before, press the ^{Wall Shot} 4 button twice, you can project images using the previous adjustment values without needing to repeat the measurements. The status will change in the order "Wall Shot OFF" → "Wall Shot ON" → "Wall Shot Memory Call" each time the ^{Wall Shot} 4 button is pressed.

Turning the projector off

User's Guide "Turning the Projector Off"

1 Turn the power off for the equipment that is connected to the projector.

2 Press the ^{Power} button twice to turn the power off.

3 Set the [R/C] switch to "OFF".

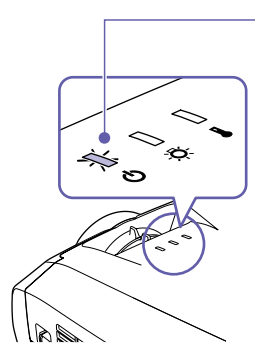

(Operation) indicator

Flashes orange* (cool-down in progress/approx. 30 seconds)

→ Lights orange

* Do not disconnect the power cable while the indicator is still flashing orange, otherwise it may result in errors in projector operation.

If the message "The projector is overheated. Clean or replace the air filter and lower the room temperature." appears during projection of images, press the ^{Enter} button to turn the power off and then clean or replace the air filters.

User's Guide "Cleaning the Air Filters and Air Intake Vent" "Replacing the Air Filters"

If not using for a long period, disconnect the power cable from the electrical outlet.

Functions for Enhancing Projection

Using the remote control for one-person presentations

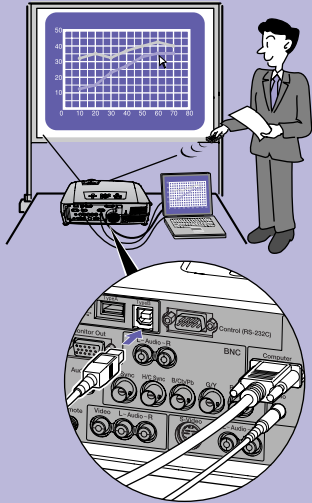

To use the wireless mouse function, you need to connect the computer using a USB cable in addition to the computer cable.

Use the accessory USB cable to connect the USB port of a computer to the projector's [USB TypeB] port.

■ Wireless Mouse Function

When projecting images from a computer, the accessory projector's remote control can be used to operate the computer's mouse pointer.

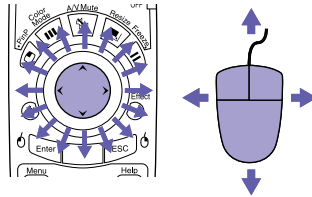

Moving the mouse pointer



Drag and drop

1. Hold down the  button for approx. 1.5 seconds.

The  button lights and drag and drop mode is enabled.

2. Tilt the  button to drag an item.
3. Press the  button to drop the item.

You can also drag and drop in the same way using the  button.

The wireless mouse function may not operate correctly depending on the computer version or function being used.



User's Guide

"Using the Remote Control to Operate the Mouse Pointer (Wireless Mouse Function)"

Mouse clicks

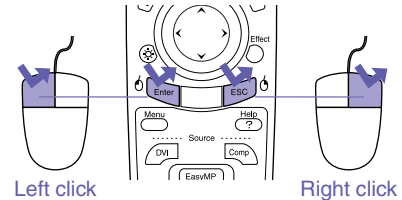

Left click

Right click

Double-click: Press twice in rapid succession.

Displaying previous or next slides in a PowerPoint slideshow

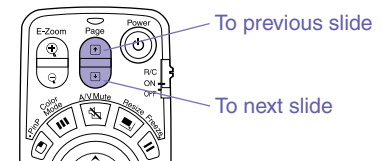

To previous slide

To next slide



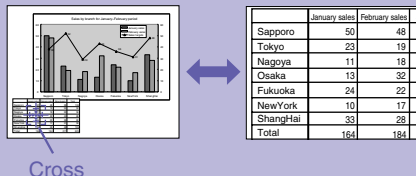

Enlarging parts of an image

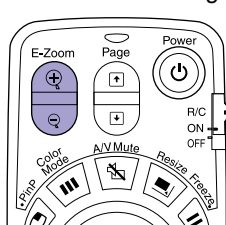

E-Zoom Function

This function lets you enlarge and reduce parts of images such as graphs and tables that you would like to view in greater detail.



1. Press the  button.
A cursor (cross) will appear on the screen.
2. Move the cross to the area of the image that is to be enlarged.
Tilt the  button.
3. To enlarge: Press the  button.
To reduce the enlarged area size: Press the  button.
Press the  button to cancel.

 User's Guide "E-Zoom Function"

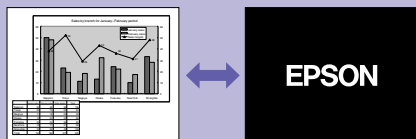

Momentarily turning off images and sound

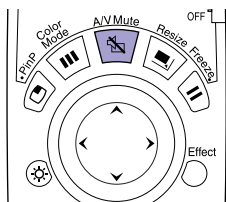

A/V Mute Function

You can use this function when you do not wish to show details of operations such as selecting different files.



- Press the  button.
The images and sound are turned off (A/V mute active).
- Press the  button once more.
The A/V mute is cancelled.

 User's Guide "A/V Mute Function"

- If you use this function when projecting moving images, the images and sound will still continue to be played back by the source, and you cannot return to the point where the A/V mute function was activated.
- You can use the "A/V Mute" command in the "Setting" menu to set the screen appearance when the images and sound have been paused to "Black", "Blue" or "User's Logo".

Emphasising parts of an image

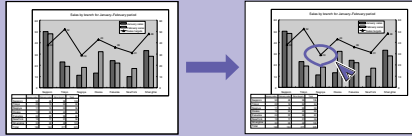

Effect Function

You can display a pointer icon and draw lines on the image being projected to emphasise parts of the image that you want to draw attention to.

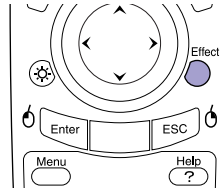

Using the pointer icon

1. Press the  button.

The pointer icon will appear.



The pointer type changes to one of three types each time the  button is pressed.

2. The pointer icon moves when the  button is tilted.

Drawing straight lines

1. Press the  button.





The pointer icon will appear.

2. Move the pointer icon to the starting point for the line.
3. Press the  button to set the starting point.
4. Move the pointer icon to the ending point for the line and press the  button to draw the line.

Drawing freehand curves

1. Press the  button.

The pointer icon will appear.

2. Move the pointer icon to the starting point for the line.
3. Press the  button for approximately 1.5 seconds so that the  button lights.
4. Tilt the  button to move the pointer icon and draw the line.
5. When the ending point is reached, press the  button.

Press the  button to clear effects. The pointer icon and lines will all be cleared.

 **User's Guide "Effect Function"**

The type, size and movement speed of the pointer icon and the colours and thicknesses of the lines drawn can be set using the "Effect" menu.

Other useful functions

Network Correspondence

Some examples of the projector's many useful functions include projecting images from a computer connected via a network and automatically sending email notifications if errors occur with the projector, such as if the lamp cuts out during projection.

👉 EasyMP Setup Guide
EasyMP Operation Guide

Color Mode



The colour mode changes as follows each time this button is pressed.



👉 User's Guide
"Selecting the Projection Quality (Colour Mode Selection)"

Preset Function



The "Video" menu settings (such as input resolution and tracking) for the respective preset number are retrieved each time this button is pressed. (Adjustment is only possible when analogue RGB signals are being input from a computer connected by a computer cable.)

👉 User's Guide
"Preset Function"

Freeze Function



The images are paused and unpaused each time this button is pressed.

👉 User's Guide
"Freeze Function"

P in P Function



This function lets you display separate images in a smaller screen (sub-screen) over the top of the images that are currently being projected (main screen).

👉 User's Guide
"P in P (Picture in Picture) Function"

Brightness Control

This lets you set the lamp brightness to one of two settings. Select "Low" if the images being projected are too bright such as when projecting images in a dark room or onto a small screen. When used at low brightness, the life of the lamp will be extended.

👉 User's Guide
"Advanced2 Menu"

List of configuration setting menus

Main menu Sub-menu (Video)

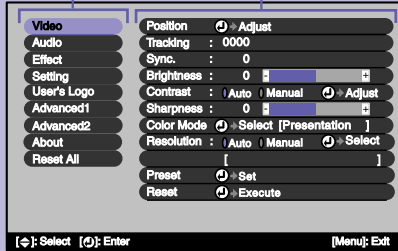

Video	During computer (analogue RGB) input	During computer (digital RGB) input or EasyMP	During component video (YCbCr or YPbPr) input	During S-Video or composite video input	During RGB video input
	Position Tracking Sync. Brightness Contrast Sharpness Color Mode Resolution Preset Reset	Brightness Contrast Sharpness Color Mode Reset	Position Brightness Contrast Color Tint Sharpness Color Mode Reset	Position Brightness Contrast Color Tint Sharpness Color Mode Video Signal Reset	Position Brightness Contrast Sharpness Color Mode Reset

Audio
Computer/DVI Audio Input Volume Treble Bass Reset

Effect
Pointer/Line1 Pointer/Line2 Pointer/Line3 Pointer Speed Reset

Setting
Keystone P in P No-Signal Msg. Message A/V Mute Computer Input BNC Input Sleep Mode Reset

User's Logo
Execute

Advanced 1
Startup Screen Progressive Color Adjustment Rear Proj. Ceiling Standby Mode Language Reset

Advanced 2
Brightness Control Projector ID COM Port Auto Setup BNC Sync Termination Reset

About	During computer (analogue RGB, digital RGB) / component video (YCbCr, YPbPr) / RGB video input or EasyMP	During S-Video or composite video input
	Lamp Reset Lamp Timer Source Input Signal* Frequency SYNC Polarity SYNC Mode Resolution Refresh Rate	Lamp Reset Lamp Timer Source Video Signal

Reset All
Execute

*Not displayed when running EasyMP.

If you cannot select images from a computer connected by a computer cable, or the images do not project correctly

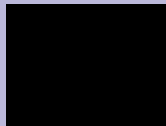

The computer cannot be selected as the image source

If a problem occurs with the projected images even though the projector is set up and connected correctly, check the following points.

If the following does not solve the problem

 **User's Guide "When the Indicators Provide No Help"**

Was the projector and computer connected while their power was already turned on?

If the connection is made while the power is already turned on, the function [Fn] key that switches the computer's video signal to external output may not work. Turn the power for the connected computer and the projector back on.

Is the computer display output set to only the computer's accessory screen?

The image signals need to be output to the projector. Change the output setting to an external destination only or to an external destination as well as the computer's own monitor.
 **Computer documentation, under a title such as "External output" or "Connecting an external monitor"**

Do the input signal settings match the projector settings? (When connected to the [BNC] port)

Repeatedly press the  button on the remote control or use the "BNC Input" command in the "Setting" menu to select the format that matches the equipment signal.



Images appear greenish or purplish

Do the input signal settings match the projector settings? (When connected to the [BNC] port)

Repeatedly press the  button on the remote control or use the "BNC Input" command in the "Setting" menu to select the format that matches the equipment signal.

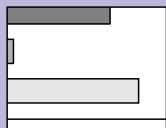

Only part of the image is displayed
Only part of the images are projected

Has the computer been set for dual display?

Cancel the dual display setting in the connected computer's Control Panel.
 **Computer documentation, under a title such as "Video driver"**

Using the help function

If a problem occurs with the projector, the Help function uses on-screen displays to assist you in solving the problem.

Press the  button and answer the questions that are displayed to proceed through the help screens.

 **User's Guide "Using the Help"**

Reading the Indicators

The projector is provided with indicators to notify you of the operating status of the projector.

The following tables show what the indicators mean and how to remedy the problems that they indicate.

If all indicators are switched off, check that the power cable is connected correctly and that power is being supplied normally.

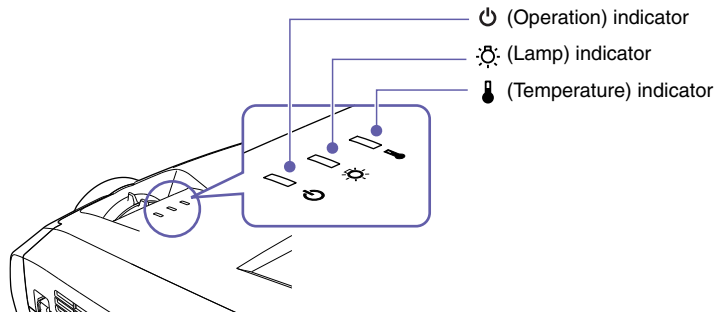

👉 User's Guide "Reading the Indicators"

If the ⏻ indicator is flashing or lit red **Problem/Warning**

lit
 flashing
 off

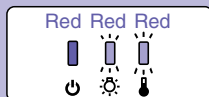

Internal error

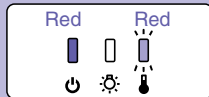

**Fan related error/
Sensor error**

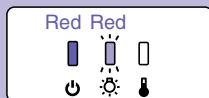

**Lamp cover is open error/
Lamp timer failure/Lamp out**



Disconnect the power cable from the electrical outlet. Then contact your dealer or the nearest address provided in the "International Warranty Conditions" section of the *Safety Instructions/World Wide Warranty Terms* booklet.



Check if the lamp is broken. Disconnect the power plug from the electrical outlet and wait for the lamp to cool down sufficiently (takes about one hour) before checking.

👉 User's Guide "Replacing the Lamp"

If the lamp is not broken





Replace the lamp and then turn the power on.

If the lamp still does not turn on, replace it with a new lamp.



If the problem is still not solved after the lamp is replaced, stop using the projector and disconnect the power cable from the electrical outlet. Then contact your dealer or the nearest address provided in the "International Warranty Conditions" section of the *Safety Instructions/World Wide Warranty Terms* booklet.

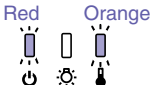

If the lamp is broken

Contact your local dealer for further advice.



	<p>Internal temperature error (overheating)</p>	<p> The lamp will switch off automatically and projection will stop. Wait for approximately 5 minutes. Then disconnect the power cable and check the points to the right.</p>	<ul style="list-style-type: none"> • If the projector is close to a wall, move it away from the wall. • Clean the air filters if they are blocked. 	<p>If the problem is not fixed, stop using the projector and disconnect the power plug from the electrical outlet. Then contact your dealer or the nearest address provided in the "International Warranty Conditions" section of the <i>Safety Instructions/World Wide Warranty Terms</i> booklet.</p>
	<p>High-speed cooling in progress</p>	<p> If you continue using the projector and the temperature rises again, the lamp will switch off automatically. Check the points to the right.</p>		





If the  indicator is flashing orange Warning

 lit  flashing  off

	<p>Lamp replacement notification</p>	<p> The lamp is near the end of its operating life. Replace the lamp with a new one as soon as possible. If you continue to use the old lamp, the possibility that the lamp may break will increase.</p> <p> User's Guide "Replacing the Lamp"</p>
---	---	--

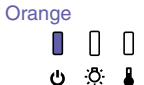
 Indicator is lit or flashing green or orange Normal

 lit  flashing  off

	<p>Standby condition</p>	<p>If you press the  button, projection will start after warm-up is complete.</p>
	<p>Warm-up in progress</p>	<p>Warm-up time is approximately 40 seconds. After warm-up is complete, the indicator will change to steady green and projection will start.</p>
	<p>Projection in progress</p>	<p>Normal operation is in progress.</p>
	<p>Cool-down in progress</p>	<p>Cool-down time is approximately 30 seconds. After cool-down is complete, the projector goes into standby mode. You cannot use the remote control or the projector's control panel during cool-down.</p>

How to replace the lamp

You will need the provided accessory screwdriver or another flathead screwdriver.

1 Disconnect the power cable.

2 Remove the lamp cover from the underside of the projector.

Turn off the power, wait for the cool down period to end (about 30 seconds) then disconnect the power cable.

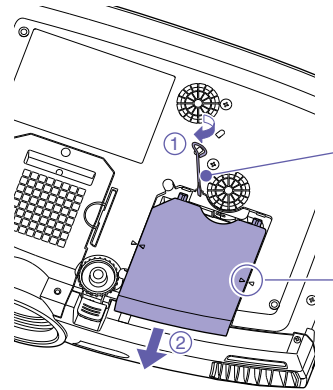

Remove the cover when the projector has sufficiently cooled down. It takes about a further one hour from when the cool down period has finished for the lamp to be cool enough.

Insert a screwdriver into the hole and turn it to release the lock.

Slide the lamp cover until the [▷] and [◁] marks line up, then lift up the lamp cover to remove it.

3 Loosen the two lamp fixing screws.

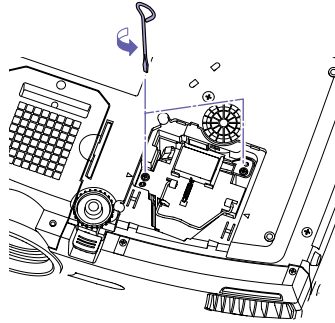

4 Lift the handle and pull out the old lamp.

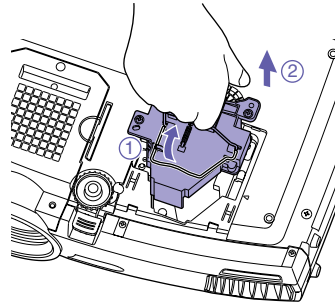

If the lamp has broken, request a replacement lamp from EPSON, or the place of purchase.

 Safety Instructions/Worldwide Warranty Terms

5 Install the new lamp.

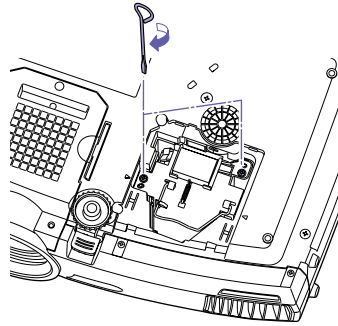

Holding the lamp facing the correct way, insert the lamp until it clicks into place then tighten the two fixing screws.

6 Install the lamp cover.

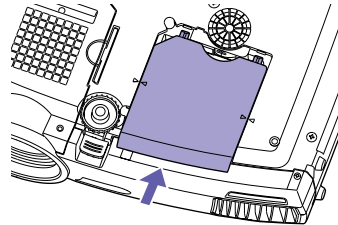

Slide the cover until it clicks into place.

- Install the lamp securely. If the lamp cover is removed, the lamp turns off automatically as a safety precaution. Moreover, the lamp will not turn on if the lamp or the lamp cover is not installed correctly.
- Dispose of used lamps properly in accordance with local regulations.

Proceed to reset the Lamp Operating Time.

Resetting the Lamp Operating Time

After replacing the lamp, be sure to reset the Lamp Operating Time from the configuration menu.

Do not reset the Lamp Operating Time except after the lamp has been replaced. If you do, the Lamp Operating Time will no longer be displayed correctly.

1 Press **Menu** .

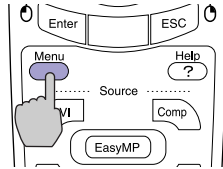

The configuration menu is displayed.

2 Select "About" → "Reset Lamp Timer" and press **Enter** .

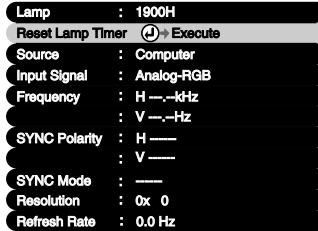

3 Select "Yes" then press **Enter** .



The Lamp Operating Time is reset.

List of Supported Monitor Displays

Signal	Refresh rate (Hz)	Resolution (dots)	Resolutions for resized display (dots)
VGAEGA		640 × 350	1024 × 560
VGA	60/72/75/85/100/120, iMac ^{*1}	640 × 480	1024 × 768
SVGA	56/60/72/75/85/100/120, iMac ^{*1}	800 × 600	1024 × 768
XGA	60/70/75/85/100/120, iMac ^{*1}	1024 × 768	1024 × 768
SXGA	70/75/85/100	1152 × 864 ^{*2}	1024 × 768
SXGA	60/75/85	1280 × 960 ^{*2}	1024 × 768
		1280 × 1024 ^{*2}	960 × 768
SXGA+	60/75/85	1400 × 1050 ^{*2}	1024 × 768
UXGA	60/65/70/75/80/85	1600 × 1200 ^{*2}	1024 × 768
MAC13"		640 × 480	1024 × 768
MAC16"		832 × 624	1024 × 768
MAC19"		1024 × 768	1024 × 768
MAC21"		1152 × 870 ^{*2}	1016 × 768
SDTV (525i,525p,625i,625p)			1024 × 768 (4:3 aspect ratio) 1024 × 576 (16:9 aspect ratio)
HDTV(750p)			1024 × 576
HDTV(1125i,1125p)			1024 × 576

*1 Connection is not possible if the equipment does not have a VGA output port.

*2 The resolution for real display is the virtual (window) display resolution.

It may be possible to project signals which are not listed in the above table.

However, not all functions may be supportable with such signals.

