

Basic Operation Guide



Introduction 2
 Parts 2
 Control Panel 3



Loading Paper 4
 Selecting Paper 4
 Loading Paper in Your EPSON STYLUS PHOTO RX 4



Copying 6
 Placing Your Original on the Document Table 6
 Copying Text and Graphics 7
 Copying a Photo 8
 Selecting Copy Quality 9



Making Prints From Your Digital Camera 10
 Compatible Cards and Inserting Positions 10
 Inserting a Memory Card 11
 Printing Snapshots 11
 Connecting Your Camera 15



Making Prints From Slides or Negatives 16
 Removing the Document Mat and Film Holder 16
 Placing 35-mm Slides in the Holder 17
 Placing 35-mm Film Strips in the Holder 17
 Printing Snapshots 18



Maintaining and Transporting Your EPSON STYLUS PHOTO RX ... 19
 Replacing Ink Cartridges 19
 Checking and Cleaning the Print Head 21
 Aligning the Print Head 22
 Transporting Your EPSON STYLUS PHOTO RX 23



Solving Problems 24
 LCD Messages 24
 Problems and Solutions 25
 Customer Support 26



Notices 27
 Important Safety Instructions 27
 Copyright Notice 28

Index 30

Introduction

After you have set up your EPSON STYLUS™ PHOTO RX as described on the *Start Here* sheet, turn here to:

- Load paper
- Make a quick copy of a document or photo
- Print photos stored on a memory card
- Print photos from slides and negatives
- Print photos from a digital camera
- Perform routine maintenance
- Solve simple problems

This book tells you how to do these things without ever turning on your computer! Of course your EPSON STYLUS PHOTO RX can do lots more when you connect it to your Windows® or Macintosh® computer—Such as improving the color and quality of your prints and scanned images, or restoring the color in faded photographs.

For complete instructions on using the EPSON STYLUS PHOTO RX with your computer, see the on-screen *User's Guide*. An icon for the guide was automatically placed on your desktop when you installed the software.

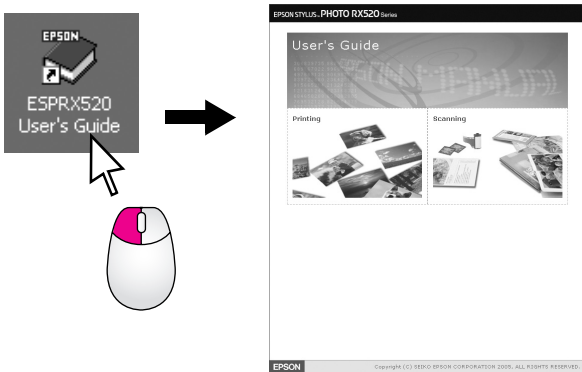

Please follow these guidelines as you read your instructions:

Warning:
Warnings must be followed carefully to avoid bodily injury.

Caution:
Cautions must be observed to avoid damage to your equipment.

Note:
Notes contain important information about your EPSON STYLUS PHOTO RX.

Tip:
Tips contain hints for better copying, scanning, and printing.

Parts

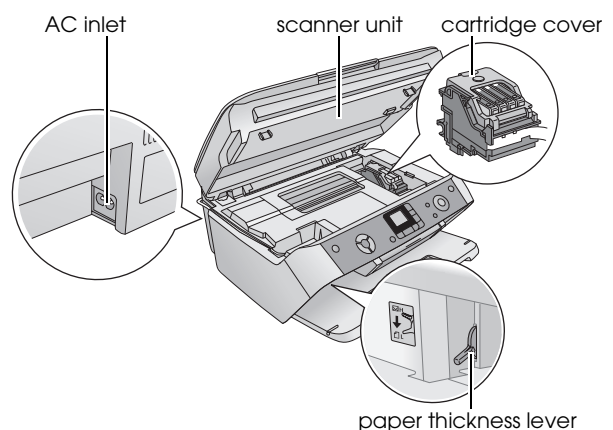
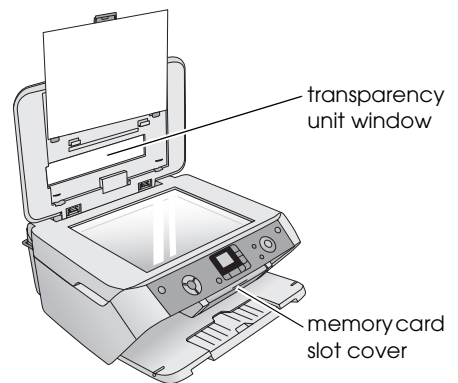
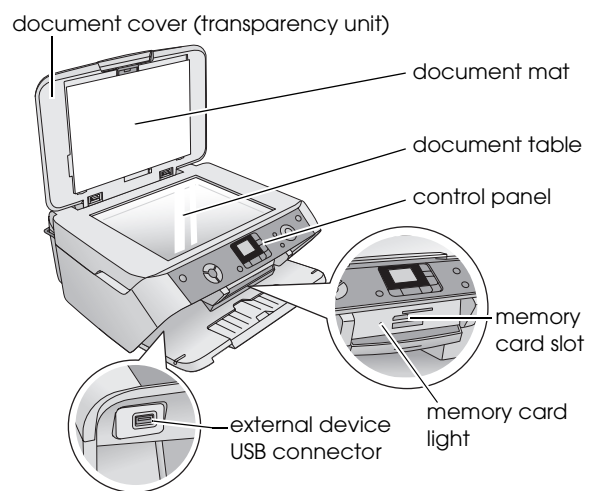
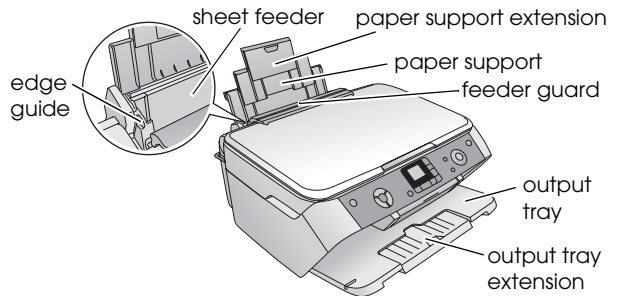

Control Panel

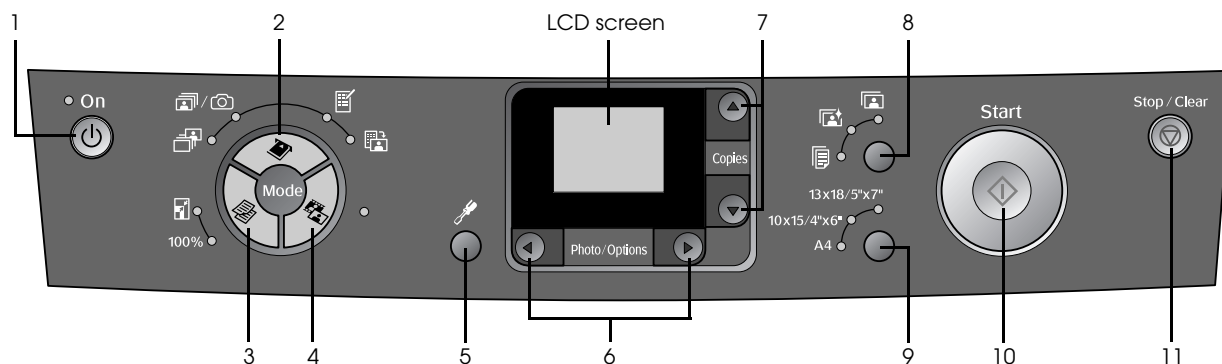

Buttons

	Buttons	Function
1	On	Press to turn the EPSON STYLUS PHOTO RX on and off.
2	Memory card 	<p>Press to print photos from a memory card.</p> <p>The memory card print options are:</p> <p>Print Select: Select this option to choose the photos you want to print.</p> <p>Print All/PictBridge: Select this option to print all the photos on a memory card, or to print photos using the DPOF information stored on the memory card.</p> <p>Note: <i>DPOF mode is only available when the photos on the memory card contain DPOF information. To print all photos on the memory card, turn off DPOF mode on your camera.</i></p> <p>Print Index Sheet: Select this option to print thumbnails of the photos on your memory card.</p> <p>Print from Index Sheet: Select this option to print the photos you chose on the index sheet. This is selected automatically after printing the index sheets for a memory card.</p>
3	Copy 100% 	<p>Press to select the copy mode.</p> <p>The copy mode options are:</p> <p>100%: Select this option to print your photo at the actual size.</p> <p>Fit to Page: Select this option to reduce or enlarge the copied photo to fit the selected paper size.</p>
4	Film/Photo	Press to print from photos, negatives, films, or slides. You can print them as they are, or with color restoration.

	Buttons	Function
5	Setup/Utilities	Press to run maintenance programs or adjust miscellaneous settings.
6	Photo/Options	Press to select the photo you want to print, to select color or black-and-white copy, or to select the setup and utility functions.
7	Copies	Press to select the number of copies, to select the numbers when using the Head Alignment Utility, or to select the functions for Auto Photo Fine.
8	Paper type	Press to select the type of paper loaded in the sheet feeder. You can select Plain Paper , Photo Paper , or Matte Paper .
		Matte Paper
		Photo Paper
9	Paper size	Press to select the size of the paper loaded in the sheet feeder. You can select A4 , 10 × 15 / 4" × 6" , or 13 × 18 / 5" × 7" .
10	Start	Press to start scanning, printing, or copying.
11	Stop/Clear	Press to stop scanning, printing, copying, or reset the settings you have made.

LCD screen

The screen displays a preview of the selected photos, or displays settings that you can change with the buttons.



Loading Paper

Epson offers an extensive line of specialty papers that provide outstanding results when used with Epson printers and ink. The type of paper you choose affects the way your printout looks, so be sure to select the correct paper for your job.

Selecting Paper

Before printing, you need to select the correct paper type setting on the control panel. This important setting tells the EPSON STYLUS PHOTO RX what kind of paper you are using so it can adjust how to apply the ink.

Choose from the following Epson papers and settings.

Paper Type	Size	Paper Type Setting	Loading Capacity
EPSON Bright White Ink Jet Paper	A4	Plain Paper	80
EPSON Premium Glossy Photo Paper	A4 10 × 15 cm	Photo Paper	20
EPSON Semigloss Photo Paper	A4 10 × 15 cm	Photo Paper	20
EPSON Matte Paper Heavyweight	A4	Matte Paper	20

Make sure you return unused paper to the original package as soon as you finish printing. Store your printouts in a photo album, resealable plastic bag, or protective plastic sleeves. Keep them away from high temperature, humidity, and direct sunlight.

Loading Paper in Your EPSON STYLUS PHOTO RX

Follow the steps below to load A4, 10 × 15 cm (4 × 6 in.), and 13 × 18 cm (5 × 8 in.) paper in your EPSON STYLUS PHOTO RX. (➔ See the *User's Guide* for instructions on loading other types of paper.)

1. Open the paper support and output tray, then slide out the extensions.

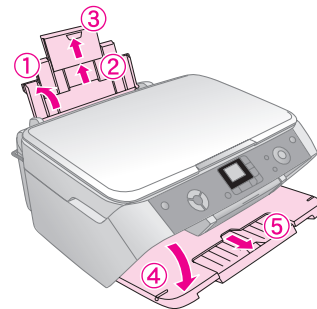

2. Flip the feeder guard forward.

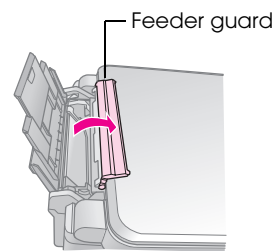

3. Slide the edge guide to the left.

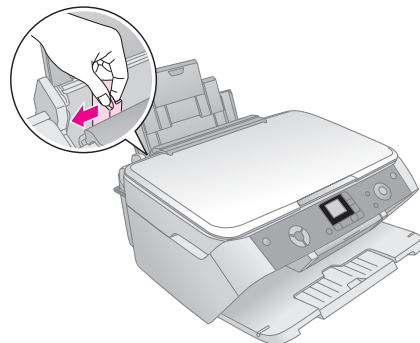

- Load the paper against the right side of the sheet feeder, with the printable side up.

Place the stack of paper behind the tabs and make sure it fits under the  arrow mark inside the left edge guide. Always load paper short edge first, even for landscape printing.

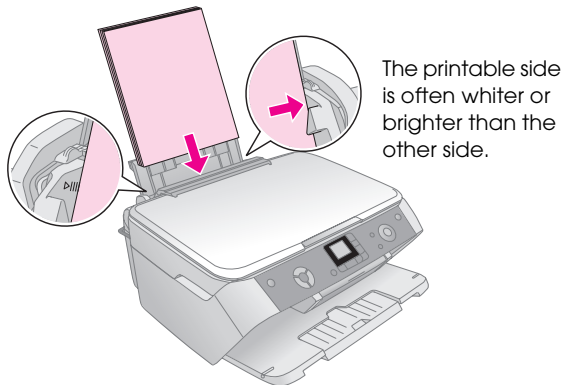

The printable side is often whiter or brighter than the other side.

10 × 15 cm (4 × 6 in.) and
13 × 18 cm (5 × 7 in.)

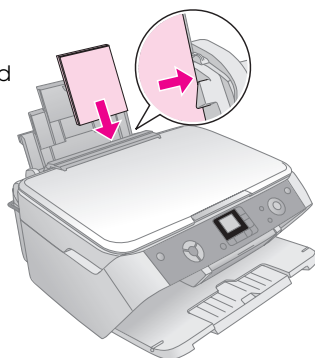

- Slide the edge guide against the left side of the paper, but not too tightly.

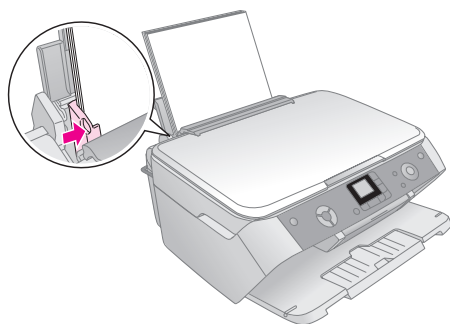

Note:

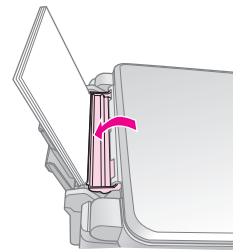

If you are using special Epson paper, follow any instructions that came with it. Make sure you do not load more than the recommended number of sheets. Check the Paper Type setting before printing to make sure it matches the type of paper you have loaded (➔ page 4).

- Flip the feeder guard back.



Also make sure the paper thickness lever is set down to the  position.



An icon showing you which setting is selected appears briefly on the LCD screen when you move the lever to the  or  position.

Copying

You can use your EPSON STYLUS PHOTO RX to copy documents and photos without a computer. If you have photos that have become faded over time, you can even bring them back to life with color restoration.

See these sections:

- “Placing Your Original on the Document Table” on page 6
- “Copying Text and Graphics” on page 7
- “Copying a Photo” on page 8
- “Selecting Copy Quality” on page 9

Notes for copying

- The copied photo may not be exactly the same size as the original.
- Depending on the type of paper used, print quality may decline in the top and bottom areas of the printout, or these areas may be smeared.
- If the EPSON STYLUS PHOTO RX runs out of paper while copying, make sure you replace the paper as soon as possible. Color accuracy may be affected if you leave the EPSON STYLUS PHOTO RX without paper for a long period of time.
- If you see the low ink icon Δ while you are copying, you can either continue copying until the ink runs out, or stop and replace the cartridge.
- Keep the document table clean.
- Make sure the document or photo is flat against the document table; otherwise, the copy will be out of focus.
- If a moire pattern (cross-hatch) appears on your copy, shift the position of your original.

Placing Your Original on the Document Table

1. Open the document cover and place your original face-down on the document table, in the upper left corner.

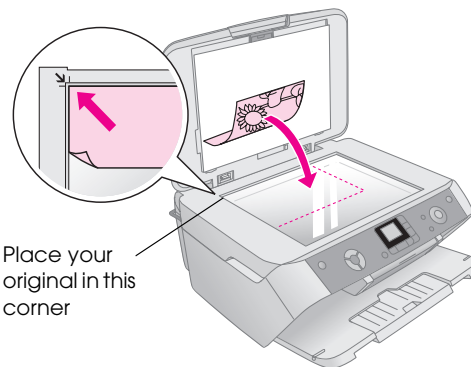

If you need to copy or scan a book or large document, you can open the document cover and gently slide up the hinges.

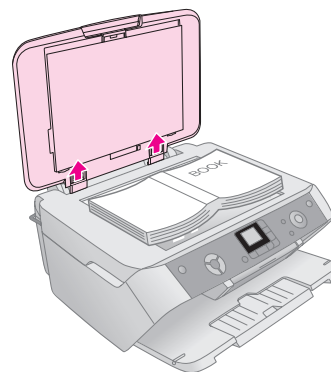

If you need to press the document flat while you copy or scan it, do not press too hard and be careful not to move it.

⚠ Caution:

Do not use excessive force on the document cover, and do not twist it diagonally. Otherwise, you may damage the cover.

Note:

If the edges of the copy are cropped off, move the original away from the corner slightly.

2. Close the cover gently so you do not move the original.

When you finish copying, slide the document cover back into the slots.

Copying Text and Graphics



You can copy black-and-white materials such as books and newspaper clippings—or materials with colorful graphic designs such as magazine articles and scrapbook elements.

Tip:

Plain photocopier paper works well for making everyday copies. For crisper text and more vivid colors, try one of the special Epson papers listed on page 4.

1. Make sure the EPSON STYLUS PHOTO RX is turned on.
2. Load several sheets of A4-size plain paper; ➔ page 4.
3. Place your original on the document table; ➔ page 6.
4. Press the Copy Mode button until the **100%** light comes on.
5. Select **Plain Paper**.

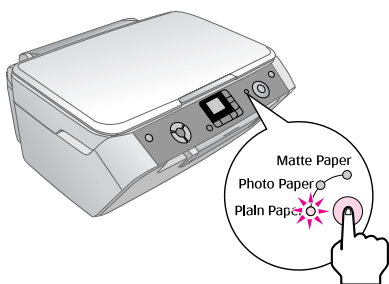

6. Select **A4**.

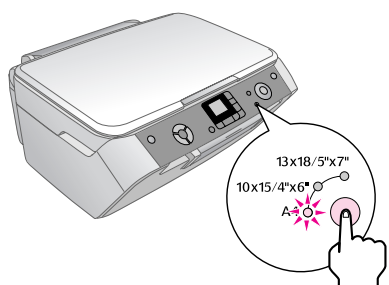

7. If you need to, select **Fit to Page** to automatically resize the copy to the size of paper that you loaded. Select **100%** to copy the document at its original size.

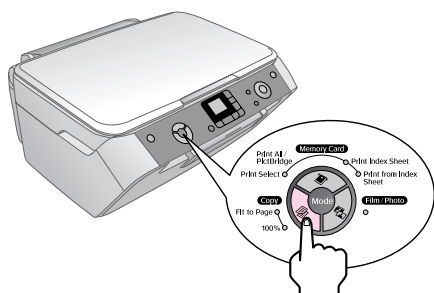

8. Use the ▲ or ▼ button to set the number of copies on the LCD panel.

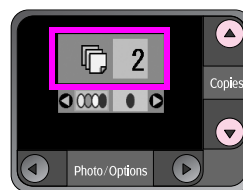

9. Use the ◀ or ▶ button to select color or black-and-white copy.

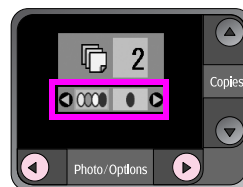

10. Press the ◊ **Start** button. Your document is copied.

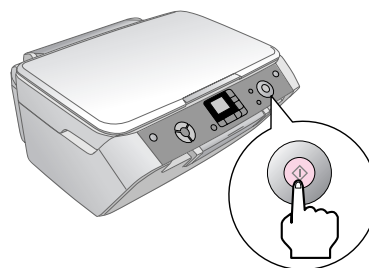

Caution:

To avoid damaging the EPSON STYLUS PHOTO RX, never open the scanner unit while scanning or copying.

If you need to stop copying, press the ⏏ **Stop/Clear Settings** button.

Tip:

If you need to make a draft or photo quality copy, press the **Setup/Utilities** button and select the copy quality as shown below. Adjust the setting, then press ◊ **Start** to apply the setting. ➔ page 9



Copying a Photo



To print long-lasting photos with a professional finish, choose an Epson paper specially designed for photos (➔ page 4).

1. Make sure the EPSON STYLUS PHOTO RX is turned on.
2. Load several sheets of 10 × 15 cm (4 × 6 in.) or 13 × 18 cm (5 × 7 in.) photo paper.
3. Place your original on the document table; ➔ page 6.

If you want to scan more than one photo at a time (➔ page 9).

4. Press the **Film/Photo Mode** button.

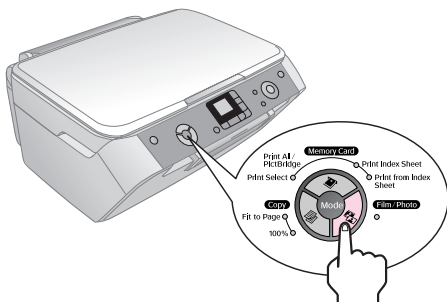

5. Use the ◀ or ▶ button to select copy photo.



When color restoration is selected, as shown below, the photo is copied with color restoration on; (➔ page 8).

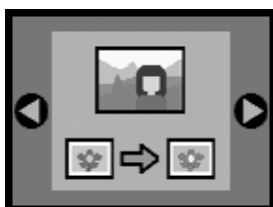

You can also use this function to restore the color to faded slides, films, or negatives. For more information on handling and restoring these kinds of documents, (➔ page 16).

6. Press the **Start** button. The photo is scanned and a preview is displayed on the LCD screen.

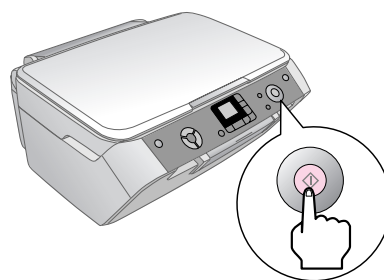

7. Use the ▲ or ▼ button to set the number of copies.
8. On the control panel, select the paper type and the paper size that you loaded.
9. Press the **Start** button again.

If you need to stop copying, press the **Stop/Clear Settings** button.

Restoring Color in Faded Documents

If you have documents such as photos, negatives, films, or slides, that have become faded over time, you can bring them back to life with color restoration.

1. Load one or more sheets of suitable paper; ➔ page 4.
2. Place your document on the document table making sure that it is aligned correctly. For photos; ➔ page 6. For negatives, positives, films, or slides; ➔ page 16.
3. Press the **Film/Photo Mode** button.
4. Use the ◀ or ▶ button to view the types of documents you can restore.

Setting	Description
	Copy a photograph with color restoration.
	Copy a color negative with color restoration.
	Copy a positive color film with color restoration.
	Copy a slide with color restoration.
	Copy a black-and-white negative with color restoration.

If you want to copy a photo without color restoration, select the document type without the color restoration icon. For example the screen below shows copy photo without color restoration.



Press the **Start** button to choose your document type. The document is scanned and a preview of the photo appears on the LCD screen.

Note:

When color restoration is on, the icon appears in the top left of the LCD screen.



- Use the **Left** or **Right** button to view the photos. Use the **Up** or **Down** button to set the number of copies.
- On the control panel, select the paper type and the paper size that you loaded.
- Press the **Start** button again. Your photo is copied.

Copying Multiple Photos

Place each photo vertically as shown in the illustration below.

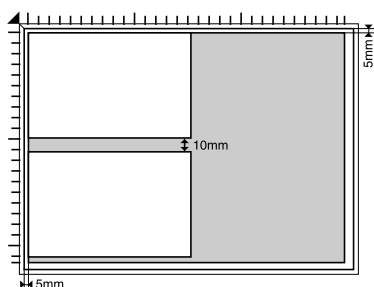

- You can copy photos from 30 × 40 mm to 127 × 178 mm.
- Position each photo at least 10 mm away from the adjacent photo.
- You can copy two 10 × 15 cm (4 × 6 in.) size photos at a time.
- You can copy different-sized photos at the same time.



Selecting Copy Quality

If you want to make a copy quickly and do not need high quality, you can print a "Draft" copy. Alternatively, if you want to print high quality photos, you can print a "Photo" copy.

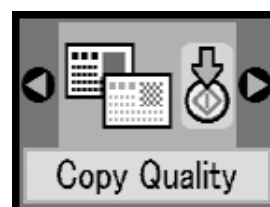
- Load plain paper and select **Plain Paper** and **A4** on the control panel.
- Press the **Setup/Utilities** button to enter the setup mode. Use the **Left** or **Right** button to select copy quality.

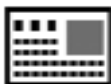
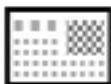

- Press the **Start** button to confirm your selection.
- Use the **Up** or **Down** button to select **Normal**, **Draft**, or **Photo**.

Setting	Description
	This is automatically selected when you turn the printer on.
	Select this if you want to make a quick copy and quality is not important.
	Select this if you want to print high quality photos.

- Press the **Start** button again to confirm your selection.

Press the **Setup/Utilities** button or the **Copy Mode** button to return to the previous mode.

Making Prints From Your Digital Camera

You can print photos from your digital camera by inserting its memory card in your EPSON STYLUS PHOTO RX. If you have a PictBridge- or USB Direct Print-enabled camera, you can connect it to the EPSON STYLUS PHOTO RX with a USB cable; ➔ page 15.

After inserting your memory card, you can select photos by viewing them on the LCD screen or by printing and scanning an index sheet.

Note:

If your camera supports DPOF (Digital Print Order Format), you can pre-select the photos you want to print while the card is still in your camera; ➔ page 12.



See these sections:



- “Compatible Cards and Inserting Positions” on page 10
- “Inserting a Memory Card” on page 11
- “Printing Snapshots” on page 11
- “Printing from an index sheet” on page 13
- “Connecting Your Camera” on page 15

For instructions on copying memory card files between your EPSON STYLUS PHOTO RX and a computer see the *User’s Guide*.

Compatible Cards and Inserting Positions

You can use the following types of memory cards with your EPSON STYLUS PHOTO RX.

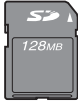
Slot	Type of Card
	 Smart Media  xD-Picture Card xD-Picture Card Type M

Slot	Type of Card
	 Memory Stick Memory Stick PRO MagicGate Memory Stick MagicGate Memory Stick Duo* Memory Stick Duo* Memory Stick PRO Duo*
	 SD Card MultiMedia Card miniSD™ Card* *Adapter required
	 Compact Flash  Microdrive

Make sure the photos on your card meet the following requirements.

Media format	DCF (Design rule for Camera File system) version 1.0 or 2.0 compliant.
File format	JPEG, DOS FAT (FAT 12 or 16, one partition) taken with a DCF version 1.0 or 2.0 compliant digital camera. Supports Exif Versions 2.21.
Image size	80 × 80 pixels to 9200 × 9200 pixels.
Number of files	Up to 999.

Inserting a Memory Card

When you are printing directly from a memory card, it is best if the EPSON STYLUS PHOTO RX is not connected to your computer or your computer is turned off. Otherwise, printing may take longer.

1. Make sure the EPSON STYLUS PHOTO RX is turned on.
2. Open the output tray, and then open the memory card cover.

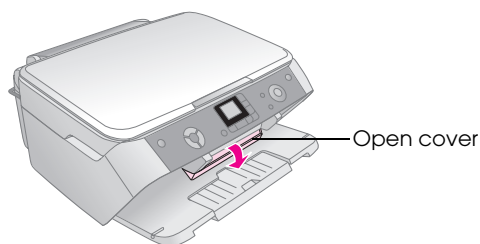

3. Make sure the memory card light (next to the card slots) is off and all the slots are empty. Then insert your card; ➔ page 10.

The memory card light flashes, then stays on.

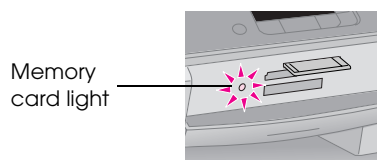

4. Close the memory card cover.

⚠ Caution:

- ❑ Do not try to force the card into the slot. Cards will not go all the way in. Forcing a card may damage the EPSON STYLUS PHOTO RX, the memory card, or both.
- ❑ Keep the memory card cover closed while a card is inserted. This protects the card and the slot from dust and static; otherwise data on the memory card may be lost, or the EPSON STYLUS PHOTO RX may be damaged.
- ❑ The static charge on some memory cards may cause the EPSON STYLUS PHOTO RX to malfunction.

Removing a Memory Card

1. Make sure all print jobs are finished and the memory card light is not flashing.
2. Open the output tray, and then open the memory card cover.
3. Remove the memory card by pulling it straight out of its slot.
4. Close the memory card slot cover.

⚠ Caution:

- ❑ Wait for the memory card light to stop flashing before removing your card or turning off the EPSON STYLUS PHOTO RX, otherwise you may lose data on the card.
- ❑ If your computer uses Windows 2000 or XP, never turn off the EPSON STYLUS PHOTO RX or disconnect the USB cable when a memory card is inserted; you may lose data on the card. See your on-screen *User's Guide* for details.

Printing Snapshots

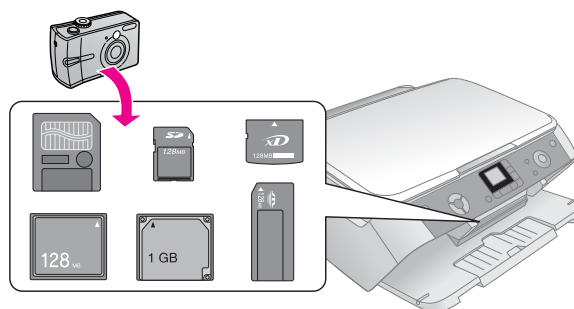

After inserting a memory card you can:

- View and select the photos you want to print.
- Print all the photos on the card or print the photos with DPOF information.
- Print an index sheet of the photos on the card.
- Print the photos you select from the index sheet.

Setting	Description
Print Select	Prints only the photos that you choose.
Print All/PictBridge*	Prints all the photos on your card, or prints the photos with DPOF information.
Print Index Sheet	Prints an index sheet of the photos on your card.
Print from Index Sheet	Prints the photos you selected on the index sheet.

* If there is DPOF information on the memory card, you cannot print all of the photos on the card, even if **Print All/PictBridge** is selected. To print all of the photos on the memory card, cancel the DPOF information from your digital camera.

Printing selected photos

Follow the steps below to select the photos you want to print from your memory card.

1. Insert the memory card (➔ page 11).
2. Load the type of paper you want to use (➔ page 4). Load enough sheets for the number of photos you want to print.
3. Press the **Memory Card Mode** button until the **Print Select** light comes on.

Note:

If your camera supports DPOF, you can use it to select the photos you want to print and the number of copies. ➔ page 12.

Depending on the data on your card, you see a screen like this:



4. Use the ◀ or ▶ button to select a photo; use the ▼ or ▲ button to set the number of copies.
5. On the control panel, select the paper type and the paper size that you loaded.
6. Press the **Start** button to start printing.

Note:

If you need to cancel printing, press the **Stop/Clear Settings** button.

7. When you are done printing, remove the memory card by pulling it straight out of its slot.

Printing All Photos or DPOF Photos

Follow the steps below to print one copy of each photo on the card or to print only those photos that were pre-selected with your camera's DPOF feature.

1. Insert the memory card (➔ page 11).
2. Load the type of paper you want to use (➔ page 4). Load enough sheets for the number of photos you want to print.
3. Press the **Memory Card Mode** button until the **Print All/PictBridge** light comes on.

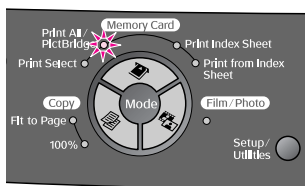

If the memory card contains DPOF information, the following screen appears.



Note:

If the memory card does not contain DPOF information, you can choose how many copies of the photos on the card you want to print.

4. On the control panel, select the paper type and the paper size that you loaded.
 5. Press the **Start** button to start printing.
- ### Note:
- If you need to stop printing, press the **Stop/Clear Settings** button.
6. When you are done printing, remove the memory card by pulling it straight out of its slot.

Printing from an index sheet

Overview of printing from an index sheet

You can print an index sheet to see small “thumbnail” images of all the pictures on your card. Then you mark the pictures on the index sheet that you want to print, scan the sheet, and let the EPSON STYLUS PHOTO RX automatically print the selected photos.

Printing an index sheet.

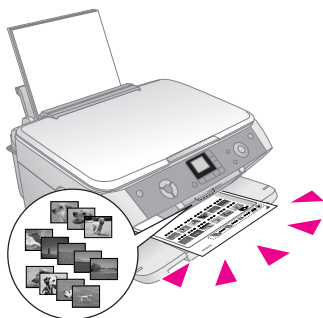

Selecting photos on the index sheet.

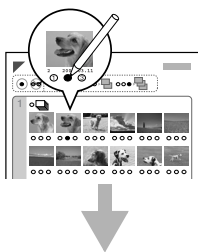

Scanning the index sheet.

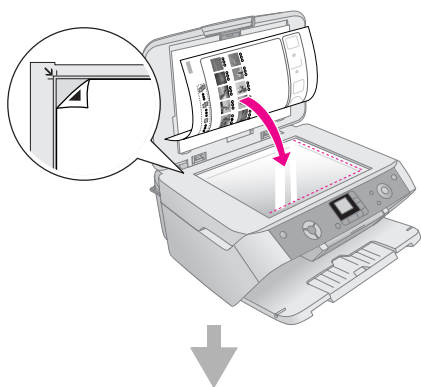

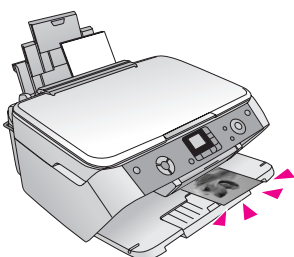

Printing the selected photos.

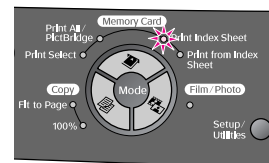

Printing an index sheet

1. Load several sheets of A4-size plain paper. (If there are more than 36 photos on your memory card, you will need more than one sheet to print the index.)
2. Press the  **Memory Card Mode** button until the **Print Index Sheet** light comes on.



3. Press the  **Start** button to print the index.

Note:

If you need to cancel printing, press the  **Stop/Clear Settings** button. If there are a lot of photos on your card, allow time for them to be processed before printing begins.

Selecting photos from the index sheet

Once you have printed the index sheet, use a dark pen or pencil to mark the photos you want to print.

- Fill in one of the circles beneath each photo to indicate how many copies you want (1, 2, or 3).
- If you want one copy of all the photos on the index sheet, fill in the All circle at the top of the page.

OK:



No good:



Make sure just one circle is filled in for each selected photo, and mark the sheet carefully. Once it has been scanned you will not be able to change your selections.

Scanning the index sheet and printing

1. Place the index sheet face-down on the document table, in the upper left corner, so that the top of the sheet is aligned against the left edge of the document table.

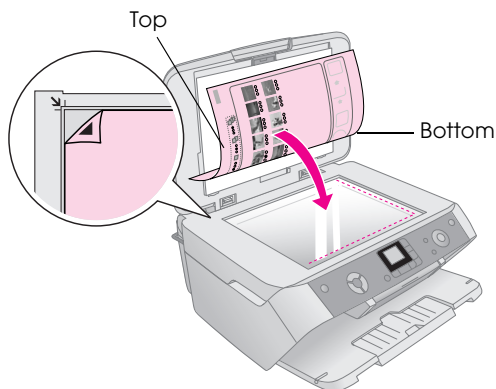

2. Close the document cover.
3. Load the type of paper you want to use (➔ page 4). Load enough sheets for the number of photos you want to print.
4. Make sure the **Print from Index Sheet** light is on.

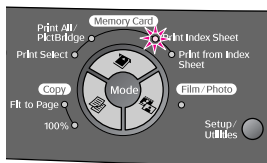

5. On the control panel, select the paper type and the paper size that you loaded.
6. Press the **Start** button to start printing.

Note:

- If you need to stop printing, press the **Stop/Clear Settings** button.
 - If you have more than one index sheet, wait for the EPSON STYLUS PHOTO RX to finish printing. Then repeat the steps above to scan and print from each additional sheet.
7. When you are done printing, remove the memory card by pulling it straight out of its slot.

Selecting Auto Correct

With auto correct you can make adjustments to your photos using the P.I.M. or Exif data on your camera, or by using the PhotoEnhance setting.

Setting	Description
OFF	Prints with no automatic correction.
P.I.M.*	Prints using the PRINT Image Matching function. If the photo data does not include P.I.M., try printing with PhotoEnhance.
PhotoEnhance	Prints enhanced photos automatically. It requires longer time, but gives better quality.
Exif*	Prints using the Exif Print function. It provides you with high-quality printouts.

* These options are automatically selected when your pictures contain P.I.M. or Exif data.

1. Press the **Setup/Utilities** button.

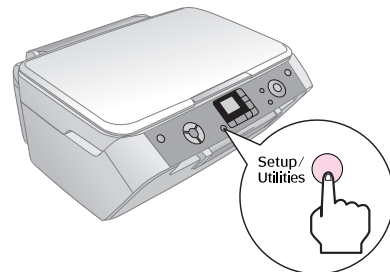

2. Use the **Left** or **Right** button to select auto correct, as shown below.

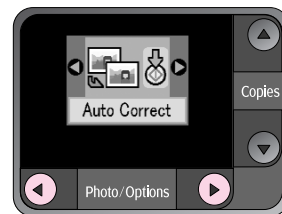

3. Press the **Start** button to confirm your selection.

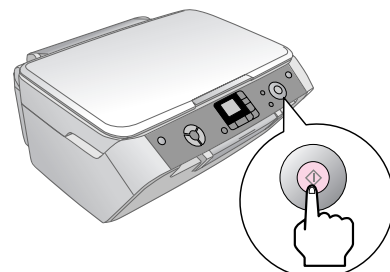

4. Use the **Up** or **Down** button to select the mode.



5. Press the **Start** button again to confirm your selection.

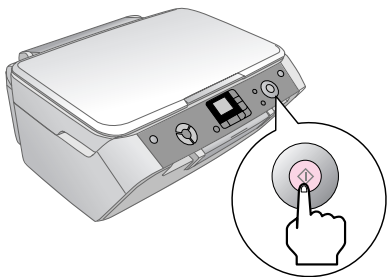

6. Press the **Setup/Utilities** button to return to the previous mode.

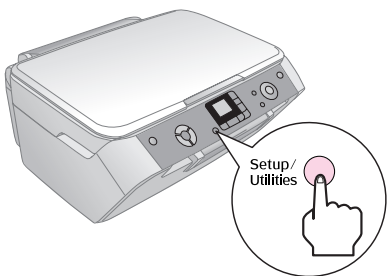

Connecting Your Camera

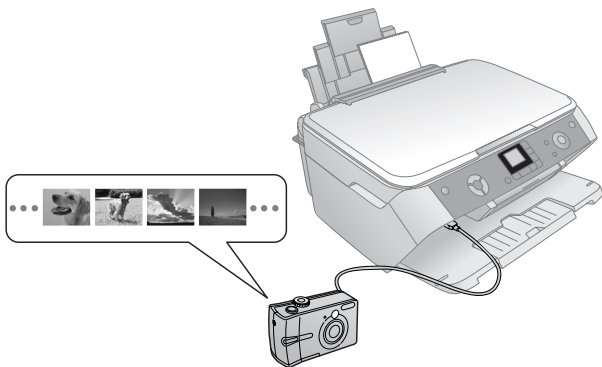

PictBridge and USB Direct Print let you print your photos by connecting your digital camera directly to the EPSON STYLUS PHOTO RX.

Make sure your photos meet the following requirements.

File format	JPEG.
Image size	80 × 80 pixels to 9200 × 9200 pixels.

1. Make sure your EPSON STYLUS PHOTO RX is not printing from a computer.
2. Load the type of paper you want to print on; ➔ page 4.
3. On the control panel, select the paper type and the paper size that you loaded.

4. Connect the USB cable that came with your camera to the external device USB connector on the front of the EPSON STYLUS PHOTO RX.

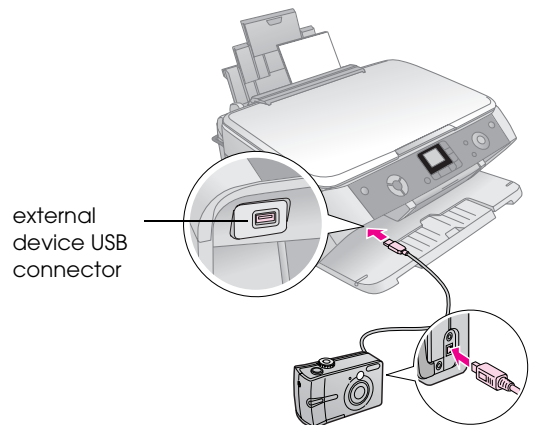

5. Make sure your camera is turned on. The **Print All/Pict Bridge** LED turns on, and one of the following icons is displayed on the LCD screen.



PictBridge

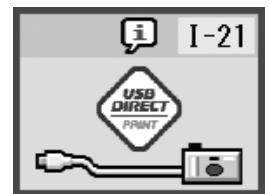

USB DIRECT PRINT

6. Use your camera to select the photos you want to print, adjust any necessary settings, and print your photos. See your camera's manual for details.

Note:

- ❑ If your camera is not compatible with PictBridge or USB Direct Print, the icon shown below appears on the LCD screen. Epson cannot guarantee the compatibility of any cameras.

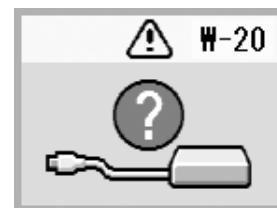

- ❑ Some of the settings on your digital camera may not be reflected in the output.
- ❑ Depending on the EPSON STYLUS PHOTO RX and the digital camera settings, there may be some combinations of paper type, size, and layout that are not supported.

Making Prints From Slides or Negatives

You can use the film holder that came with your EPSON STYLUS PHOTORX to scan 35-mm slides and strips of negatives or positive film. You can then print directly from the scanned images.

To get professional results that look and feel like traditional photos, try one of the special Epson photo papers listed on page 4.

See these sections:

- “Removing the Document Mat and Film Holder” on page 16
- “Placing 35-mm Slides in the Holder” on page 17
- “Placing 35-mm Film Strips in the Holder” on page 17
- “Printing Snapshots” on page 18

⚠ Caution:

Make sure you handle film or negative strips by the edges or wear gloves. Touching the film surface with bare hands can leave fingerprints or other marks on the film.

Removing the Document Mat and Film Holder

1. Open the document cover and remove the document mat.

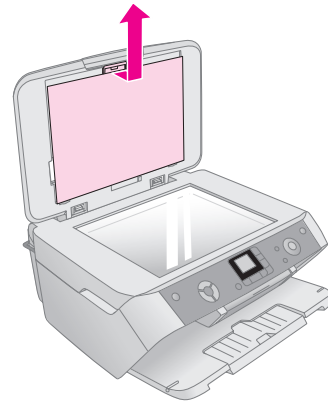

2. If you have stored the film holder in the document cover, remove it as shown.

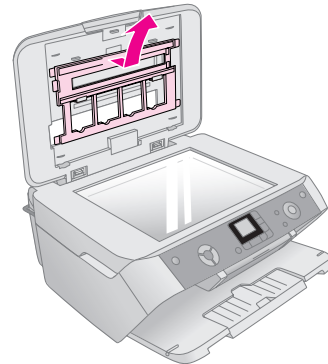

3. Place your film in the holder as described on the following pages.

Placing 35-mm Slides in the Holder

1. Fit the holder's tabs into the two small holes at the rear edge of the document table.

Make sure the cutouts for 35-mm slides are in the upper-left corner of the document table (not at the rear edge) to align them with the transparency unit window when you close the cover.

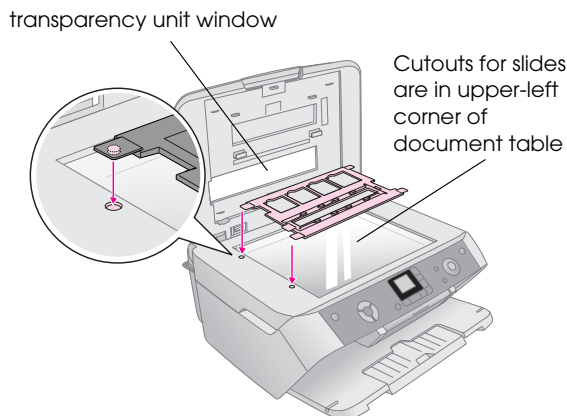

2. Place your slides in the film holder as shown and make sure there is no gap between the slides and the document table.

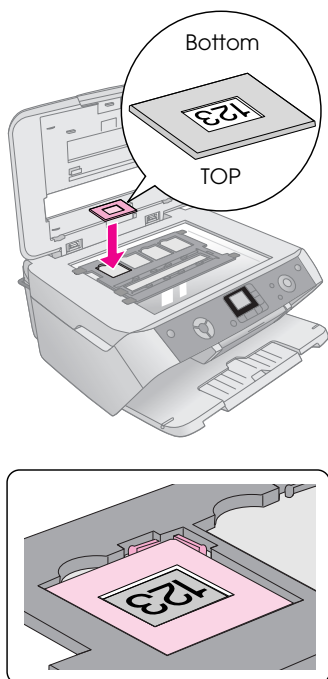

Note:

- ❑ The photos should be the right way up when viewed from overhead. (The shinier side faces up; the duller side faces down.)
- ❑ Make sure you do not press too hard on the document table.
- ❑ Make sure there is no gap between the holder and the document table, otherwise the photos may not be clear.

3. Close the document cover completely.

Continue with the steps on page 18 to scan and print your photos.

Placing 35-mm Film Strips in the Holder

1. Open the film strip cover.

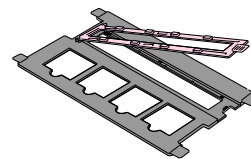

2. Slide your negative or positive film strip into the holder, under the tabs.

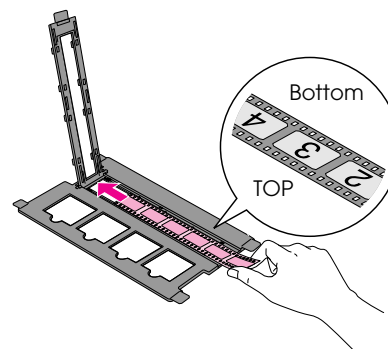

Note:

The photos should be the right way up when viewed from overhead. (The shinier side faces up; the duller side faces down.)

3. Close the film strip cover.
4. Fit the holder's tabs into the two small holes at the left edge of the document table.

Make sure the film strip is in the middle of the document table (not at the rear edge) to align it with the transparency unit window when you close the cover.

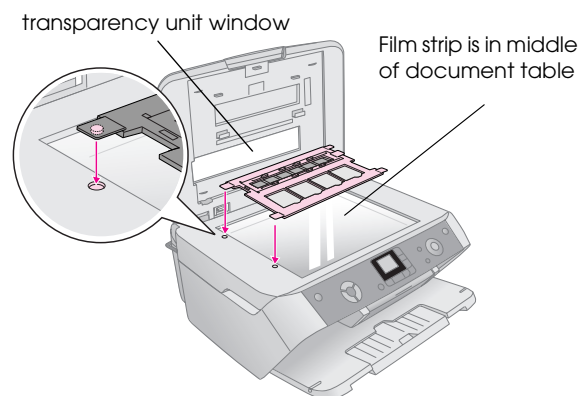

Caution:

Make sure you do not press too hard on the document table.

5. Close the document cover.

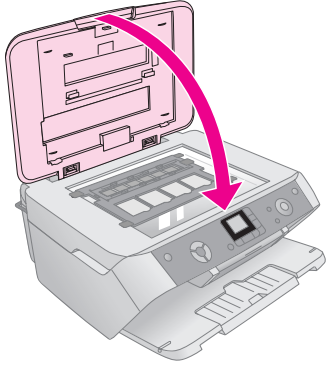





Continue with the steps in the next section to scan and print your photos.

Printing Snapshots

Once you have placed your slides, negatives, or film strips on the scanner as described above, you can scan and print quick snapshots.

1. Load one or more sheets of suitable paper; ➔ page 4.
2. Press the  **Film/Photo Mode** button.
3. Use the ◀ or ▶ buttons to view the types of documents you can copy.

Setting	Description
	Copy a color negative (used in most cases).
	Copy a positive color film.
	Copy a slide.
	Copy a black-and-white negative.

Tip:

If your documents are faded you can bring them back to life with color restoration; ➔ page 8.

Press the  **Start** button to choose your document type. The document is scanned and a preview of the photo appears on the LCD screen.

4. Use the ◀ or ▶ buttons to view the photos. Use the ▲ or ▼ buttons to set the number of copies.
5. On the control panel, select the paper type and the paper size that you loaded.
6. Press the  **Start** button again. Your document is copied.

Maintaining and Transporting Your EPSON STYLUS PHOTO RX

Follow the instructions in this chapter for:

- “Replacing Ink Cartridges” on page 19
- “Checking and Cleaning the Print Head” on page 21
- “Aligning the Print Head” on page 22
- “Transporting Your EPSON STYLUS PHOTO RX” on page 23

Replacing Ink Cartridges

When an ink cartridge is low, you see this icon in the upper-left corner of the LCD screen.

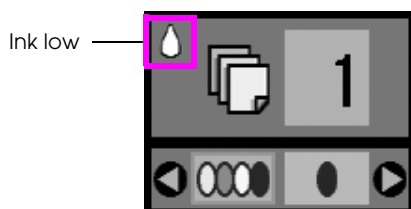

When printing or copying, a bar showing which ink cartridge is low appears next to the Ink Low icon.

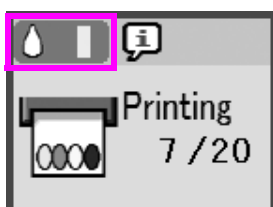

When an ink cartridge is empty, you see this LCD screen.

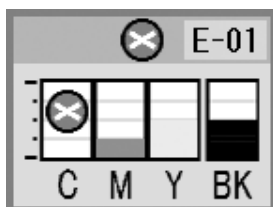

When a cartridge is more than six months old, print quality may decline. If necessary, try cleaning the print head; ➔ page 21. If printouts still do not look their best, you may need to replace the cartridge.

Checking the Ink Supply

To check your ink supply, do the following:

1. Press the **Setup/Utilities** button.
2. Use the ◀ or ▶ button to select the check ink supply icon, as shown below.



3. Press the ◊ **Start** button.

You see a graphic showing the amount of ink available in each cartridge:

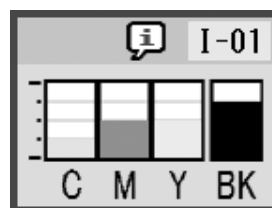

4. When you are done checking the ink levels, press the ◊ **Start** button.

When your ink starts getting low, make sure you have replacement cartridges available. You cannot print if a cartridge is empty.

Purchasing Ink Cartridges

Use these Epson ink cartridges within six months of installing them and before the expiration date.

Color	Part number
Black	T0551
Cyan	T0552
Magenta	T0553
Yellow	T0554

Caution:

To ensure good results, use genuine Epson ink cartridges and do not refill them. Other products not manufactured by Epson may cause damage that is not covered by Epson's warranties, and under certain circumstances, may cause your EPSON STYLUS PHOTO RX to behave erratically.

Ink Cartridge Precautions

Warning:

If ink gets on your hands, wash them thoroughly with soap and water. If ink gets in your eyes, flush them immediately with water. If you still have discomfort or vision problems, see a doctor immediately.

Caution:

- ❑ To avoid damaging the printer, never move the print head by hand.
- ❑ When an ink cartridge is empty, you cannot continue copying or printing even if the other cartridges still contain ink.
- ❑ Leave the empty cartridge installed in the EPSON STYLUS PHOTO RX until you have obtained a replacement. Otherwise the ink remaining in the print head nozzles may dry out.
- ❑ An IC chip on each ink cartridge accurately monitors the amount of ink used from the cartridge. Even if a cartridge is removed and then inserted again, all of its ink can be used. However, some ink is consumed each time the cartridge is inserted because the EPSON STYLUS PHOTO RX automatically checks its reliability.

Removing and Installing Ink Cartridges

Make sure you have a new ink cartridge before you begin. Once you start replacing a cartridge, you must complete all the steps in one session.

1. Do one of the following:

- **If an ink cartridge is empty:**

Look at the icon on the LCD screen to find out which cartridge is empty, then press the **Start** button.

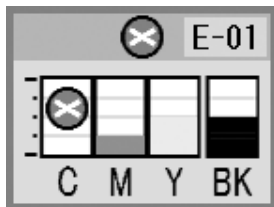

- **If an ink cartridge is low:**

Check the ink levels; ➔ page 19. Then press the **Setup/Utilities** button. Use the **◀** or **▶** button to select the ink exchange icon, as shown below, then press **Start**. At the confirmation screen, press **Start** again.

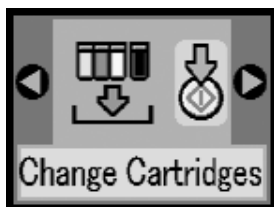

2. Lift up the scanner unit to access the printer area.

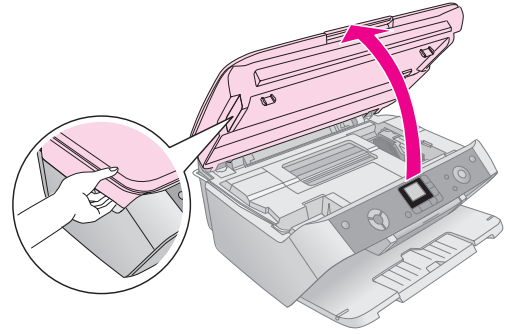

3. Open the cartridge cover.

Caution:

Never attempt to open the cartridge cover while the print head is moving. Wait until the cartridges have moved to the replacement position.

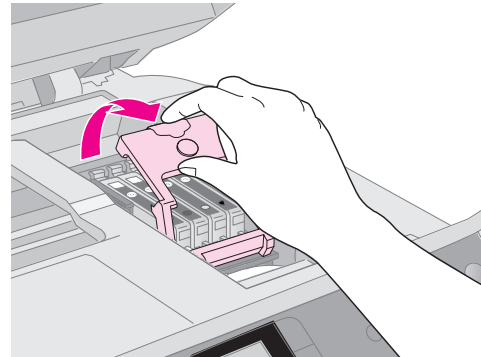

4. Remove the cartridge you need to replace. Squeeze the tab at the back of the cartridge and lift it straight out. Dispose of it carefully. Do not take the used cartridge apart or try to refill it.

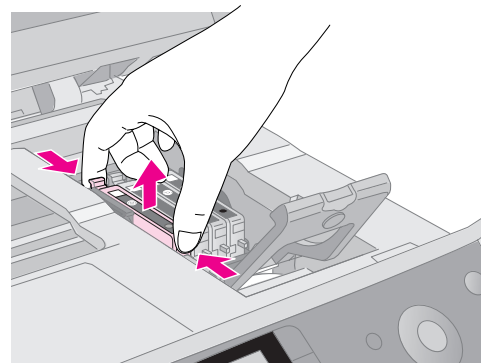

5. Unwrap the new cartridge.

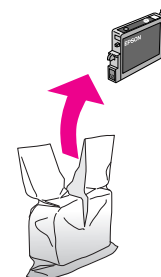

6. Place the new cartridge into the holder and push it down until it clicks into place.

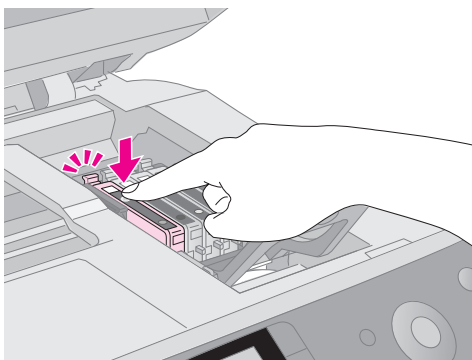

If you need to replace other ink cartridges, repeat steps 4 through 6 before continuing with the next step.

7. Close the ink cartridge cover and press it until it clicks into place.

Caution:

If you find it difficult to close the cover, make sure all the cartridges are firmly seated. Press down on each cartridge until you hear it click into place. Do not attempt to force the cover closed.

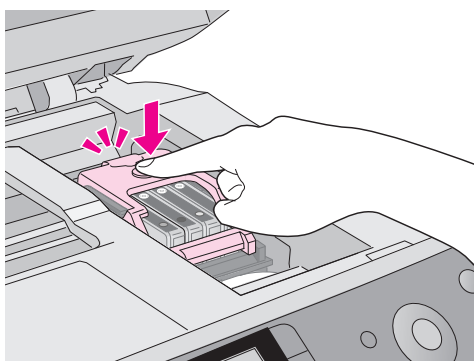

8. Close the scanner unit and then press the **Start** button.

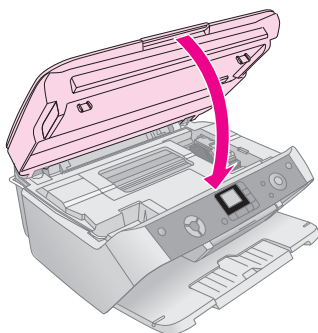

The EPSON STYLUS PHOTO RX begins charging ink and the On light starts flashing. This takes about one minute. When it is finished, the On light stops flashing.

If you replace ink cartridges while you are printing, press the **Start** button when the ink charging finishes to continue printing.

9. When the EPSON STYLUS PHOTO RX finishes charging ink, press the **Setup/Utilities** button to return to the previous mode.

Caution:

Never turn off the EPSON STYLUS PHOTO RX during ink charging or you will waste ink.

Checking and Cleaning the Print Head

If your printouts are unexpectedly light, colors are missing, or you see light or dark lines across the page, you may need to clean the print head. This clears the print head nozzles, which can become clogged if you do not use the printer for a long time.

Tip:

It is a good idea to turn on your EPSON STYLUS PHOTO RX at least once a month to maintain good print quality.

Checking the Print Head

You can print a nozzle check pattern to see if any print head nozzles are clogged, or to check the results after cleaning the print head.

1. Press the **Setup/Utilities** button.
2. Use the **Left** or **Right** button to select the nozzle check icon, as shown below, and then press the **Start** button.

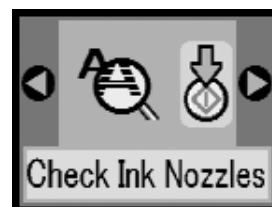

3. Load A4-size plain paper in the sheet feeder, then press the **Start** button again to print the nozzle check.
4. Examine the nozzle check pattern you printed. Each staggered line should be solid, with no gaps, as shown.



- If your printout looks okay, press the **Setup/Utilities** button to return to the previous mode.
- If you see any gaps, as shown below, clean the print head as described in the next section.



Cleaning the Print Head

Follow these steps to clean the print head so it can deliver ink properly. Print head cleaning uses ink, so clean it only if quality declines.

Note:

If a message on the LCD screen tells you that a cartridge is empty or low on ink, you cannot clean the print head. You must first replace the indicated ink cartridge.

1. Make sure the EPSON STYLUS PHOTO RX is turned on but not printing.
2. Press the **Setup/Utilities** button.
3. Use the ◀ or ▶ button to select the head cleaning icon, as shown below, and then press the ⬡ **Start** button.



4. Press the ⬡ **Start** button again to start cleaning the print head.

Cleaning takes about 30 seconds, during which the processing icon appears on the LCD screen.



Caution:

To avoid damaging the EPSON STYLUS PHOTO RX, never turn it off while head cleaning is in progress.

5. When cleaning finishes, print a nozzle check pattern to check the results; ➔ page 21.

If you do not see any improvement after cleaning three or four times, check the solutions beginning on page 25. You can also turn the EPSON STYLUS PHOTO RX off and wait overnight to allow any dried ink to soften. Then try cleaning the print head again.

Aligning the Print Head

If your printouts look grainy or vertical lines appear jagged, you may need to align the print head.

1. Make sure the EPSON STYLUS PHOTO RX is turned on and not printing.
2. Load several sheets of plain paper.

3. Press the **Setup/Utilities** button.
4. Use the ◀ or ▶ button to select the aligning the print head icon, as shown below, and then press the ⬡ **Start** button.



5. The following alignment sheet is printed.

Note:

Do not press the Ⓞ **Stop/Clear Settings** button while printing an alignment pattern.

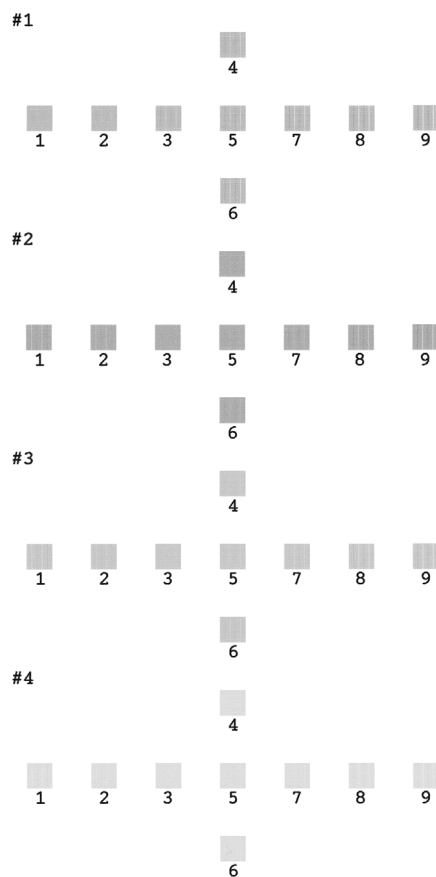

6. Look at pattern #1 and find the patch that is most evenly printed, with no noticeable streaks or lines.
7. Press the ▲ or ▼ button until the number for that patch appears on the LCD screen



8. Press the ⬡ **Start** button.

9. Repeat steps 5 through 7 for each of the other three alignment patterns.
10. Press the **Setup/Utilities** button to return to the previous mode.

Transporting Your EPSON STYLUS PHOTO RX

If you need to move your EPSON STYLUS PHOTO RX some distance, you need to prepare it for transportation in its original box or one of a similar size.

1. Remove all paper from the sheet feeder and make sure the EPSON STYLUS PHOTO RX is off.
2. Open the scanner unit and make sure the print head is in the home position on the right. Secure the ink cartridge holder to the case with tape as shown, then close the scanner unit.

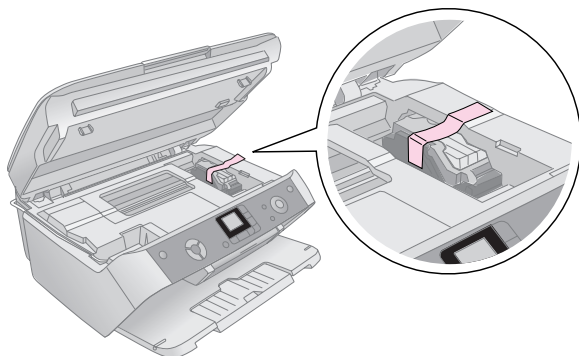

3. Unplug the power cord from the electrical outlet, then disconnect the USB cable from your computer.

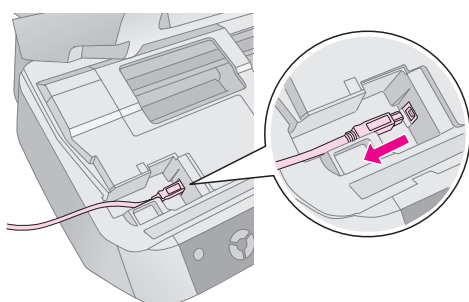

Warning:

Be careful not to trap your fingers when closing the scanner unit.

4. Close the paper support, feeder guard, and output tray.

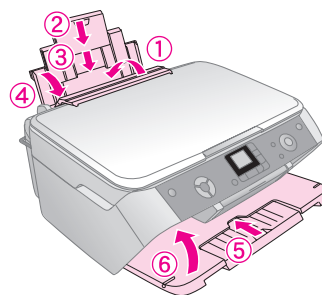

5. Repack the EPSON STYLUS PHOTO RX in the original box using the protective materials that came with it.

As you transport the EPSON STYLUS PHOTO RX, make sure you keep it level. After you move it, remove the tape securing the print head. If you notice a decline in print quality, run a cleaning cycle (➔ page 21) or align the print head (➔ page 22).

Solving Problems

If you have a problem with your EPSON STYLUS PHOTO RX, check the messages on the LCD screen, run a nozzle check (➔ page 21), or see “Problems and Solutions” on page 25.

See these sections:







- “LCD Messages” on page 24 below
- “Problems and Solutions” on page 25
- “Customer Support” on page 26











LCD Messages

You can diagnose and solve most problems by checking the messages on the LCD screen. If you cannot solve the problems by checking the messages, use the following table and try the recommended solution.

Note:

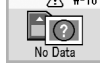
The solutions are for problems that happen when using this product stand alone. Refer to the online *User's Guide* for detailed solutions for printing, scanning, print quality, or computer-related problems.

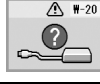
Icon	Cause	Solution
	Ink end.	Change the empty ink cartridges.
	The ink cartridge is not installed or not installed correctly.	Install the ink cartridge correctly.
	No paper is loaded in the sheet feeder.	Load paper in the sheet feeder. Then press Start to continue or Stop/Clear Settings to cancel. ➔ page 4
	Paper is jammed.	Clear the jam, then press Start . ➔ page 25
	The index sheet was not recognized because it is not positioned correctly.	Position the index sheet correctly on the document table, aligning the top of it with the left edge of the glass. Then press Start to continue or Stop/Clear Settings to cancel.
	The index sheet is marked incorrectly.	Remove the index sheet, mark it correctly, and try again. ➔ page 13

	The index sheet does not match the photos on the memory card.	Remove the memory card and insert the card used to print the index sheet—or place the correct index sheet on the document table. Then press Start to continue or Stop/Clear Settings to cancel.
	An error occurred during photo pre-scanning.	Check that the photo is placed correctly and try again. ➔ page 6
	An error occurred during film pre-scanning.	Check that the film is placed correctly and try again. ➔ page 17
	Not enough ink to perform head cleaning.	Replace with new ink cartridges.
	There is a problem with the EPSON STYLUS PHOTO RX.	Turn the EPSON STYLUS PHOTO RX off and then back on. If the error does not clear, contact your local authorized service center or contact Epson for a referral. ➔ page 26
	A part on the EPSON STYLUS PHOTO RX needs to be replaced.	Contact your local authorized service center or contact Epson for a referral. ➔ page 26
	The waste ink pad is nearly full.	Contact your local authorized service center or contact Epson for a referral. ➔ page 26
	The memory card does not contain any valid photos.	Remove the memory card and see ➔ page 10.
	Memory card error.	Remove the memory card and see ➔ page 10.
	The connected camera is not recognized.	Check the connection and try again. ➔ page 15
	The paper thickness lever is set to the wrong position.	Set the paper thickness lever to the correct position and try again.
	No memory card is inserted.	Insert a valid memory card and try again. ➔ page 10



Problems and Solutions

Check the solutions below if you are having trouble using your EPSON STYLUS PHOTO RX.

Copying Problems

- Make sure your original is positioned in the top left corner of the document table.
- If the edges of the copy are cropped off, move the original away from the corner slightly.
- Make sure your paper is loaded short edge first, all the way to the right, with the left edge guide against its left side. Do not load paper above the  arrow mark inside the left edge guide.

Paper Feeding Problems



- Remove the paper from the sheet feeder. Flip through the stack to separate the sheets. Then reload the paper against the right edge, and slide the left edge guide against the paper (but not too tightly). Make sure the paper is not in front of the feeder guard.
- Do not load too many sheets at once. ➔ page 4 for information about the number of sheets you can load.
- If paper is jammed, follow these steps to clear the jam:
 1. Press the  **Start** button to eject the jammed paper. If the jammed paper is not ejected, go on to the next step.
 2. If the paper is stuck near the sheet feeder or output tray, gently pull it out then press the  **Start** button.

If the paper is stuck inside the EPSON STYLUS PHOTO RX, press the  **On** button to turn it off. Open the scanner unit and remove any paper inside, including any torn pieces. Do not pull it backward; this can damage the sheet feeder. Close the scanner unit, then turn the EPSON STYLUS PHOTO RX back on.

Print Quality Problems

If you have any problems with the copy or print quality, try these solutions:

- Make sure the document is placed flat against the document table and the EPSON STYLUS PHOTO RX is not tilted or placed on an uneven surface.
- Load the paper printable side up (usually the whiter, brighter, or glossy side).

- Make sure your paper is not damp or curled.
- Load your paper one sheet at a time. Remove sheets from the output tray so not too many collect at a time.
- Make the paper size and paper type settings on the control panel match the type of paper you loaded (➔ page 4).
- For the best print quality, use Epson paper (➔ page 4) and genuine Epson ink cartridges (➔ page 19).
- Set the paper thickness lever to the  position for most paper types. If you are printing on envelopes, set the lever to the  position.
- If you notice light or dark bands across your printouts or they are too faint, you may need to clean the print head. Run a nozzle check as described on page 21 to see if the print head needs cleaning.
- Clean the print head as described on page 21.
- If you notice jagged vertical lines, you may need to align the print head. ➔ page 22 for instructions.
- The ink cartridges may be old or low on ink. ➔ page 22 instructions on replacing an ink cartridge.
- If a dotted line appears in the photo, clean the document table with a soft, dry, lint-free cloth (paper towels are not recommended), or use a small amount of glass cleaner on a soft cloth, if necessary. **Do not spray glass cleaner directly on the document table.**
- If you notice smears on the paper, make several copies without placing a document on the document table.
- Make sure your film or slides are placed on the scanner correctly and the film holder is properly positioned on the document table (➔ page 17).
- Printing film or slides in a low-temperature environment can cause discoloration in the scanned or printed image if the EPSON STYLUS PHOTO RX is not fully warmed up. If this happens, leave the EPSON STYLUS PHOTO RX for approximately 10 minutes without turning it off or changing the scan mode, and then try again.

Print Head Problem

If the ink cartridge cover does not close or the print head does not move to its home position, open the cover and push the ink cartridges down until they click into place.

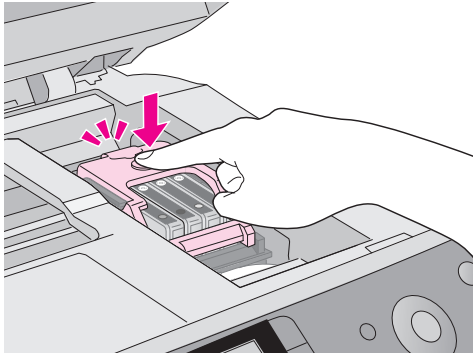

Customer Support

Contacting Customer Support

If your Epson product is not operating properly and you cannot solve the problem using the troubleshooting information in your product documentation, contact customer support services for assistance. Check your Pan-European Warranty Document for information on how to contact EPSON Customer support. They will be able to help you much more quickly if you give them the following information:

- Product serial number
(The serial number label is usually on the back of the product.)
- Product model
- Product software version
(Click **About**, **Version Info**, or similar button in the product software.)
- Brand and model of your computer
- Your computer operating system name and version
- Names and versions of the software applications you normally use with your product

Technical Support Web Site

Go to <http://www.epson.com> and select the Support section of your local EPSON web site for the latest drivers, FAQs, manuals and other downloadables.

Epson's Technical Support Web Site provides help with problems that cannot be solved using the troubleshooting information in your printer documentation.

Important Safety Instructions

Before using your EPSON STYLUS PHOTO RX, read and follow these safety instructions:

- Use only the power cord that comes with the EPSON STYLUS PHOTO RX. Use of another cord may cause fire or shock. Do not use the cord with any other equipment.
 - Make sure the power cord meets all relevant local safety standards.
 - Use only the type of power source indicated on the label.
 - Place the EPSON STYLUS PHOTO RX near a wall outlet where the plug can be easily unplugged.
 - Do not let the power cord become damaged or frayed.
 - If you use an extension cord with the EPSON STYLUS PHOTO RX, make sure the total ampere rating of the devices plugged into the extension cord does not exceed the cord's ampere rating. Also, make sure the total ampere rating of all devices plugged into the wall outlet does not exceed the wall outlet's ampere rating.
 - Avoid locations that are subject to rapid changes in heat or humidity, shocks or vibrations, or dust.
 - Leave enough room around the EPSON STYLUS PHOTO RX for sufficient ventilation.
 - Do not place the EPSON STYLUS PHOTO RX near a radiator or heating vent or in direct sunlight.
 - Place the EPSON STYLUS PHOTO RX on a flat, stable surface that extends beyond its base in all directions. It will not operate properly if it is tilted or at an angle.
 - Make sure the back of the EPSON STYLUS PHOTO RX is at least 10 cm away from the wall.
 - Do not spill liquid on the EPSON STYLUS PHOTO RX.
 - Never open the document cover beyond where it stops, and do not place heavy objects on top of the EPSON STYLUS PHOTO RX.
 - Do not block or cover openings in the case or insert objects through the slots.
 - Except as specifically explained in your documentation, do not attempt to service the EPSON STYLUS PHOTO RX yourself.
- Unplug the EPSON STYLUS PHOTO RX and refer servicing to qualified service personnel under the following conditions: if the power cord or plug is damaged; if liquid has entered the product; if the product has been dropped or the case damaged; if the product does not operate normally or exhibits a distinct change in performance. Adjust only those controls that are covered by the operating instructions.
 - When storing or transporting the EPSON STYLUS PHOTO RX, do not tilt it, stand it on its side, or turn it upside down. Otherwise ink may leak from the cartridges.

Ink Cartridge Safety Instructions

- Keep ink cartridges out of the reach of children and do not drink the ink.
- Be careful when you handle used ink cartridges; there may be ink remaining around the ink supply port. If ink gets on your skin, wash it off with soap and water. If it gets in your eyes, flush them immediately with water. If you still have discomfort or vision problems, see a doctor immediately.
- Do not put your hand inside the EPSON STYLUS PHOTO RX or touch the cartridges during printing.
- Do not shake cartridges this might cause leakage.
- Install an ink cartridge immediately after you remove it from its package. Leaving the cartridge unpacked for a long time before use may result in reduced print quality.
- Do not remove or tear the label on an ink cartridge; this can cause leakage.
- Do not touch the green IC chip on the side of the cartridge. This may affect normal operation and printing.



- If you remove an ink cartridge for later use, protect the ink supply area from dirt and store it in the same environment as the EPSON STYLUS PHOTO RX. There is a valve in the ink supply port, making covers or plugs unnecessary, but care is needed to prevent the ink from staining items that the cartridge touches. Do not touch the ink supply port or surrounding area.

ENERGY STAR® Compliance



As an ENERGY STAR® Partner, Epson has determined that this product meets the ENERGY STAR® guidelines for energy efficiency.

The International ENERGY STAR® Office Equipment Program is a voluntary partnership with the computer and office equipment industry to promote the introduction of energy-efficient personal computers, monitors, printers, fax machines, copiers, scanners, and multi function devices in an effort to reduce air pollution caused by power generation. Their standards and logos are uniform among participating nations.

Copyright Notice

All rights reserved. No part of this publication may be reproduced, stored in a retrieval system, or transmitted in any form or by any means, electronic, mechanical, photocopying, recording, or otherwise, without the prior written permission of Seiko Epson Corporation. The information contained herein is designed only for use with this product. Epson is not responsible for any use of this information as applied to other printers.

Neither Seiko Epson Corporation nor its affiliates shall be liable to the purchaser of this product or third parties for damages, losses, costs, or expenses incurred by the purchaser or third parties as a result of accident, misuse, or abuse of this product or unauthorized modifications, repairs, or alterations to this product, or (excluding the U.S.) failure to strictly comply with Seiko Epson Corporation's operating and maintenance instructions.

Seiko Epson Corporation shall not be liable for any damages or problems arising from the use of any options or any consumable products other than those designated as Original Epson Products or Epson Approved Products by Seiko Epson Corporation.

Seiko Epson Corporation shall not be held liable for any damage resulting from electromagnetic interference that occurs from the use of any interface cables other than those designated as Epson Approved Products by Seiko Epson Corporation.

EPSON® is a registered trademark and EPSON STYLUS™ is a trademark of Seiko Epson Corporation.

Copyright 2001 Seiko Epson Corporation. All rights reserved. PRINT Image Matching™ is a trademark of Seiko Epson Corporation. The PRINT Image Matching logo is a trademark of Seiko Epson Corporation.

Copyright 2002 Seiko Epson Corporation. All rights reserved. USB DIRECT-PRINT™ is a trademark of Seiko Epson Corporation. The USB DIRECT-PRINT logo is a trademark of Seiko Epson Corporation.

Microsoft® and Windows® are registered trademarks of Microsoft Corporation.

DPOF™ is a trademark of CANON INC., Eastman Kodak Company, Fuji Photo Film Co., Ltd. and Matsushita Electric Industrial Co., Ltd.

SD™ is a trademark.

Memory Stick, Memory Stick Duo, Memory Stick PRO, and Memory Stick PRO Duo are trademarks of Sony Corporation.

xD-Picture Card™ is a trademark of Fuji Photo Film Co.,Ltd.

General Notice: Other product names used herein are for identification purposes only and may be trademarks of their respective owners. Epson disclaims any and all rights in those marks.

Copyright © 2005 Seiko Epson Corporation. All rights reserved.

Index

A

Aligning print head, 22 to 23

B

Brightness
copies, 7
Buttons, 3

C

Camera
connecting to printer, 15
printing from, 10 to 15
Canceling
copying, 7, 8
printing, 12, 13
Cartridge cover, 2
Cartridges, replacing, 19 to 21
Checking print nozzles, 21
Cleaning print head, 22
Contacting EPSON, 26
Contact sheet, 13 to 14
Control panel, 3
Copy Density setting, 7
Copying
brightness, adjusting, 7
canceling, 7, 8
multiple photos, 9
photos, 8
slides and negatives, 16 to 18
text and graphics, 7
thick document, 6
Customer support, 26

D

Darkening copies, 7
Density setting, 7
Digital camera
compatible file types, 15
connecting to printer, 15
printing from, 10 to 15
Document
placing on glass, 6
Document cover, 2, 6
Document mat, 2, 16

E

Edge guide, 2
Empty ink, 20
Epson
paper, 4
Error messages, 24

F

Feeder guard, 2
File types, memory card, 10
Film
printing from, 16 to 18
Film holder
loading film, 17 to 18
loading slides, 17
removing from document cover, 16

I

Image quality problems, 25
Index sheet, 13 to 14
Ink cartridges
checking levels, 19
empty, 20
purchasing, 19
replacing, 19 to 21
safety instructions, 28
Ink nozzle check, 21
Installing ink cartridges, 20 to 21

J

JPEG file requirements, 15

L

Lightening copies, 7
Low ink, 20

M

Memory card light, 11
Memory cards
compatible, 10
index sheet of photos on, 13 to 14
inserting, 11
removing, 11
supported file types, 10
Memory card slot, 2
Menu button, 7
Messages, error, 24

N

Negatives
loading, 17
printing from, 16 to 18
Nozzle check, 21

O

Output tray, 2

P

Paper

- loading, 4 to 5
- selecting, 4

Paper support, 2

Paper Type setting, 4

Photos

- copying, 8
- multiple, 9
- placing on glass, 6
- supported file types, 10

PictBridge, 15

Print head

- aligning, 22 to 23
- cleaning, 22

Printing

- from camera, 10 to 15
- from index sheet, 13 to 14
- from memory card, 10 to 14

Problems

- printing, 21
- solving, 24 to 26

Proof sheet, 13 to 14

R

Removing ink cartridges, 20 to 21

Replacing ink cartridges, 19 to 21

S

Safety instructions, 27 to 28

Scanner unit, 2

Scanning

- problems, 25

Sheet feeder, 2

Slides

- printing from, 16 to 18

Solving problems, 24 to 26

Stopping

- copying, 7, 8
- printing, 12, 13

T

Technical support, 26

Thick document, copying, 6

Thumbnail printing, 13 to 14

Transparency unit window, 17

Troubleshooting, 24 to 26

- image quality, 25
- scanning, 25

U

USB Direct Print, 15

EPSON



MEMORY STICK PRO TM



410180200