

Basic Operation Guide

Notices	2	Improving Print Quality	19
Introduction	4	Touching Up Your Photos.....	19
Printer Parts and Control Panel	5	Cropping and Sizing Your Photos	20
Loading Paper.....	7	Adding the Date or Time	20
Accessing Images to Print.....	9	Printing Photos in Black and White or Sepia.....	21
Inserting a Memory Card.....	9	Fit to Frame.....	21
Connecting an External Device	9	Setting the Printer Preferences	22
Printing Directly from a Digital Camera	10	Adjusting the LCD Brightness.....	22
Printing Photos	11	Restoring to Default Settings	22
Introducing Photo Printing	11	Setting the Screen Saver.....	22
Printing several photos (View and Print Photos).....	11	Replacing Ink Cartridges.....	23
Printing all photos (Print All Photos)....	11	Maintenance and Transporting	25
Printing a range of photos (Print Range of Photos)	12	Improving Print Quality	25
Printing photos searching by date (Print by Date).....	12	Cleaning the Printer.....	26
Printing an Index Sheet of photos.....	12	Transporting the Printer	26
Printing a Photo With a Frame Specified by Camera.....	13	Troubleshooting.....	27
Printing with DPOF Settings	13	Error Messages	27
Changing the View of Photos on the LCD Panel.....	13	Print Quality Problems	27
Viewing a slide show	13	Miscellaneous Printout Problems.....	28
Other Creative Printing Options	14	Smudges or blots appear on the printout.....	28
Printing on a CD/DVD	14	Paper Does Not Feed Correctly.....	28
Printing a CD Jacket	16	Printer Does Not Print.....	29
Printing with Frames.....	16	Canceling Printing	29
Printing on Stickers	16	Using the Paper Feed/Paper Eject function	30
Printing on EPSON Iron-On Cool Peel Transfer Paper	17	Customer Support.....	30
Photo Printing Options.....	18	Appendix	31
Making the Paper and Layout Settings.....	18	Options, Ink, and Paper	31
		Printer Specifications	31
		Summary of Panel Settings	34
		Index.....	36

Notices

Safety Instructions

Read all of the instructions in this section before using your printer. Also, be sure to follow all warnings and instructions marked on the printer.

When setting up your printer

- Do not block or cover the vents and openings in the printer.
- Use only the type of power source indicated on the printer's label.
- Use only the power cord that comes with this printer. Use of another cord may result in fire or electric shock.
- Be sure your AC power cord meets the relevant local safety standard.
- Do not use a damaged or frayed power cord.
- If you use an extension cord with the printer, make sure that the total ampere rating of the devices plugged into the extension cord does not exceed the cord's ampere rating. Also, make sure that the total ampere rating of all devices plugged into the wall outlet does not exceed the wall outlet's ampere rating.
- Do not attempt to service the printer yourself.
- Unplug the printer and refer servicing to qualified service personnel under the following conditions:

The power cord or plug is damaged; liquid has entered the printer; the printer has been dropped or the casing damaged; the printer does not operate normally or exhibits a distinct change in performance.

When choosing a place for the printer

- Place the printer on a flat, stable surface that extends beyond the base of the printer in all directions. If you place the printer by the wall, leave more than 10 cm between the back of the printer and the wall. The printer will not operate properly if it is tilted at an angle.
- When storing or transporting the printer, do not tilt it, stand it on its side, or turn it upside down. Otherwise, ink may leak from the cartridges.
- Avoid places subject to rapid changes in temperature and humidity. Also, keep the printer away from direct sunlight, strong light, or heat sources.

- Leave enough room around the printer to allow for sufficient ventilation.
- Place the printer near a wall outlet where the plug can be easily unplugged.

When using the printer

Take care not to spill liquid on the printer.

When using a memory card

- Do not remove the memory card or turn off the printer while the computer and the memory card are communicating (when the memory card lights is flashing.).
- The methods for using memory cards vary according to card type. Be sure to refer to the documentation packaged with your memory card for details.
- Use only memory cards compatible with the printer. Refer to Loading Memory Cards.

When using LCD panel

- The LCD panel may contain a few small bright or dark spots. These are normal and do not mean that they are damaged in any way.
- Only use a dry, soft cloth to clean the LCD panel. Do not use liquid or chemical cleansers.
- If the LCD panel on your printer's control panel is damaged, contact your dealer. If the liquid crystal solution gets on your hands, wash them thoroughly with soap and water. If the liquid crystal solution gets into your eyes, flush them immediately with water. If discomfort or vision problems remain after a thorough flushing, see a doctor immediately.

When using the optional Bluetooth Photo Print Adapter

Refer to the Bluetooth Photo Print Adapter's documentation for the safety instructions.

When handling the ink cartridges

- Keep ink cartridges out of the reach of children. Do not allow children to drink from or handle the cartridges.
- Do not shake the ink cartridges; this can cause leakage.

- Be careful when you handle used ink cartridges, as there may be some ink remaining around the ink supply port. If ink gets on your skin, wash the area thoroughly with soap and water. If ink gets into your eyes, flush them immediately with water. If discomfort or vision problems remain after a thorough flushing, see a doctor immediately.
- Do not remove or tear the label on the cartridge; this can cause leakage.
- Install the ink cartridge immediately after you remove it from its package. If you leave a cartridge unpacked for a long time before using it, normal printing may not be possible.
- Do not touch the green IC chip on the back of the cartridge. Doing so may prevent normal operation and printing.

ENERGY STAR® Compliance



As an ENERGY STAR Partner, Epson has determined that this product meets the ENERGY STAR guidelines for energy efficiency.

The International ENERGY STAR Office Equipment Program is a voluntary partnership with the computer and office equipment industry to promote the introduction of energy-efficient personal computers, monitors, printers, fax machines, copiers, scanners, and multifunction devices in an effort to reduce air pollution caused by power generation. Their standards and logos are uniform among participating nations.

Copyrights and Trademarks

No part of this publication may be reproduced, stored in a retrieval system, or transmitted in any form or by any means, electronic, mechanical, photocopying, recording, or otherwise, without the prior written permission of Seiko Epson Corporation. The information contained herein is designed only for use with this Epson printer. Epson is not responsible for any use of this information as applied to other printers.

Neither Seiko Epson Corporation nor its affiliates shall be liable to the purchaser of this product or third parties for damages, losses, costs, or expenses incurred by the purchaser or third parties as a result of accident, misuse, or abuse of this product or unauthorized modifications, repairs, or alterations to this product, or (excluding the U.S.) failure to strictly comply with Seiko Epson Corporation's operating and maintenance instructions.

Seiko Epson Corporation shall not be liable for any damages or problems arising from the use of any options or any consumable products other than those designated as Original Epson Products or Epson Approved Products by Seiko Epson Corporation.

Seiko Epson Corporation shall not be held liable for any damage resulting from electromagnetic interference that occurs from the use of any interface cables other than those designated as Epson Approved Products by Seiko Epson Corporation.

EPSON® is a registered trademark and EPSON STYLUS™ is a trademark of Seiko Epson Corporation.

PRINT Image Matching™ is a trademark of Seiko Epson Corporation. The PRINT Image Matching logo is a trademark of Seiko Epson Corporation.

USB DIRECT-PRINT™ is a trademark of Seiko Epson Corporation. The USB DIRECT-PRINT logo is a trademark of Seiko Epson Corporation.

The *Bluetooth* word mark and logos are owned by the Bluetooth SIG, Inc. and any use of such marks by Seiko Epson Corporation is under license.

Microsoft® and Windows® are registered trademarks of Microsoft Corporation.

Apple® and Macintosh® are registered trademarks of Apple Computer, Inc.

Part of the photo data stored on the Printer Software CD-ROM is licensed from Design Exchange Co., Ltd. Copyright © 2000 Design Exchange Co., Ltd. All rights reserved.

DPOF™ is a trademark of CANON INC., Eastman Kodak Company, Fuji Photo Film Co., Ltd. and Matsushita Electric Industrial Co., Ltd.

Zip® is a registered trademark of Iomega Corporation.

SD™ is a trademark.

Memory Stick, Memory Stick Duo, Memory Stick PRO, and Memory Stick PRO Duo are trademarks of Sony Corporation.

xD-Picture Card™ is a trademark of Fuji Photo Film Co., Ltd.

General Notice: Other product names used herein are for identification purposes only and may be trademarks of their respective owners. Epson disclaims any and all rights in those marks.

Copyright © 2005 Seiko Epson Corporation. All rights reserved.

Introduction

After you have set up your printer as described on the *Start Here* sheet, refer to this book to:

- Load paper
- Print photos stored on a memory card
- Print photos from an external device
- Save photos from a memory card to an external device
- Perform routine maintenance
- Solve most problems

This book tells you how to do these things without ever turning on your computer! Of course your printer can do lots more when you connect it to your Windows or Macintosh computer.

For complete instructions on using the printer with your computer, see the on-screen *User's Guide*. An icon for the guide was automatically placed on your desktop when you installed the software.

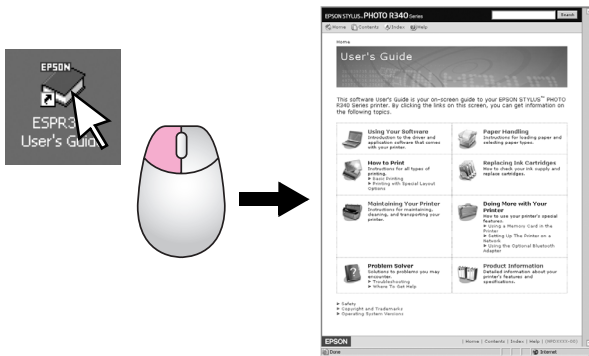

Please follow these guidelines as you read your instructions:

Warning:
Warnings must be followed carefully to avoid bodily injury.

Caution:
Cautions must be observed to avoid damage to your printer.

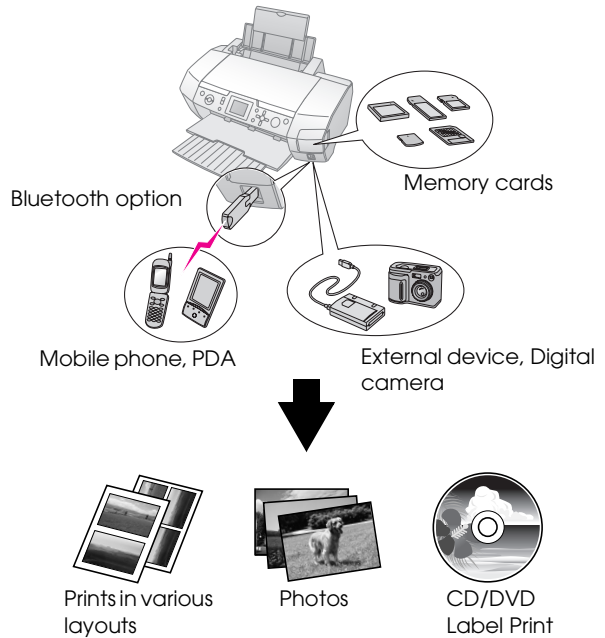

Note:
Notes contain important information about your printer.

3-way direct access

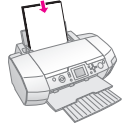
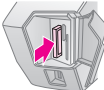

For details on using an optional Bluetooth Adapter, see the on-screen *User's Guide*.

Basic Printing Procedure

<p>1. Load paper</p> 	<p>Load paper printable side up, then fit the edge guide to the paper.</p> <p>See "Loading Paper in the Sheet Feeder" on page 7. for details.</p>
<p>2. Insert a memory card</p> 	<p>See "Inserting a Memory Card" on page 9.</p>
<p>3. Select Photos</p>	<p>Select photos using the control panel.</p> <p>"Printing all photos (Print All Photos)" on page 11.</p> <p>"Printing several photos (View and Print Photos)" on page 11.</p> <p>"Printing a range of photos (Print Range of Photos)" on page 12.</p>
<p>4. Print</p> 	<p>Press the Start button.</p>

Printer Parts and Control Panel

Printer Parts

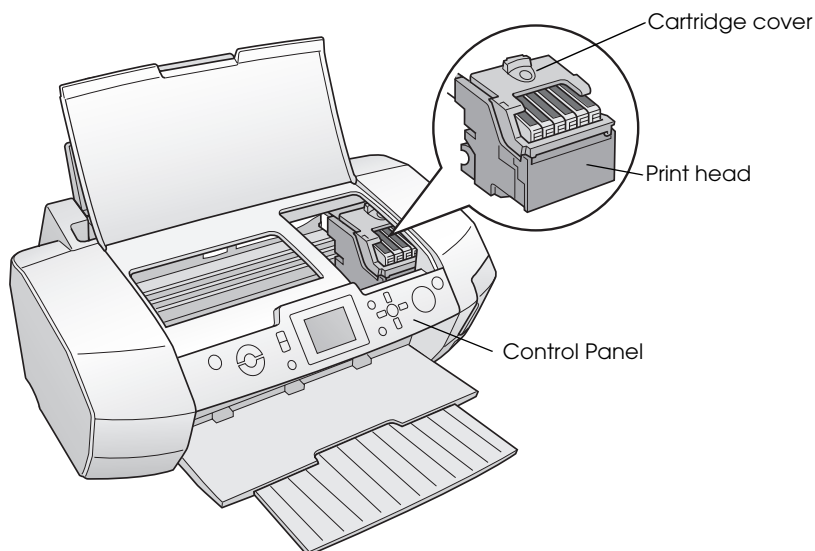
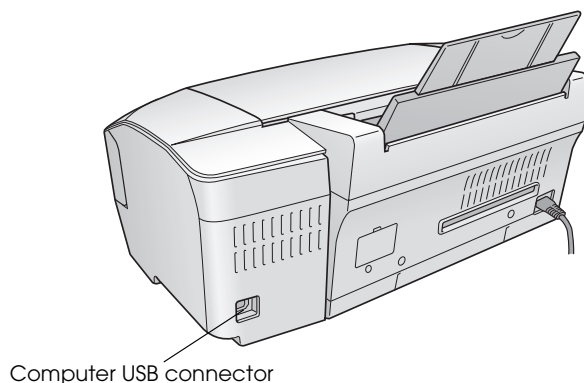
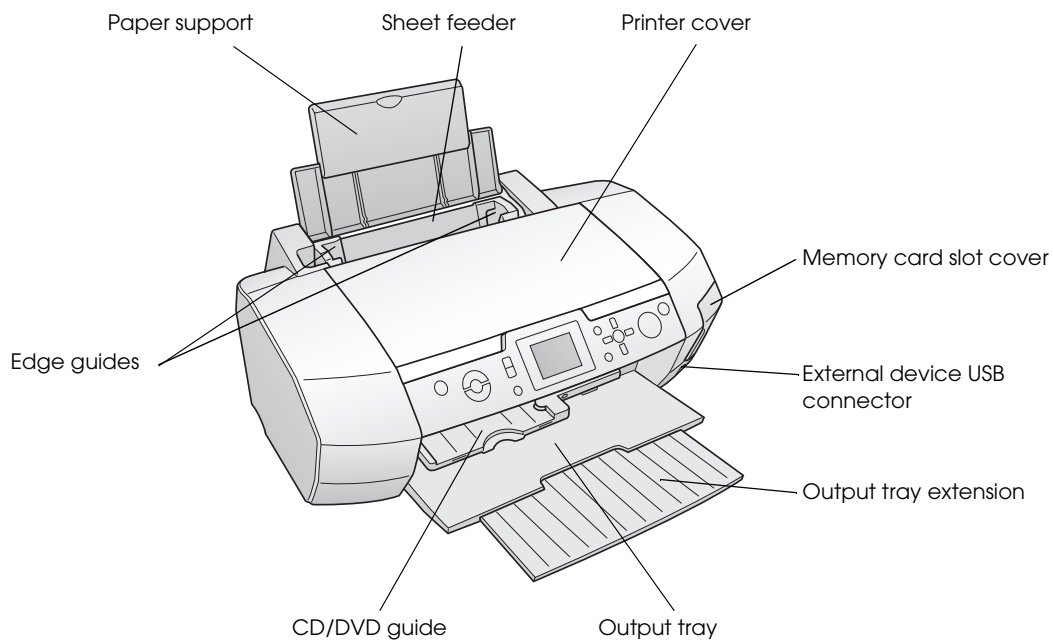

Control Panel Buttons

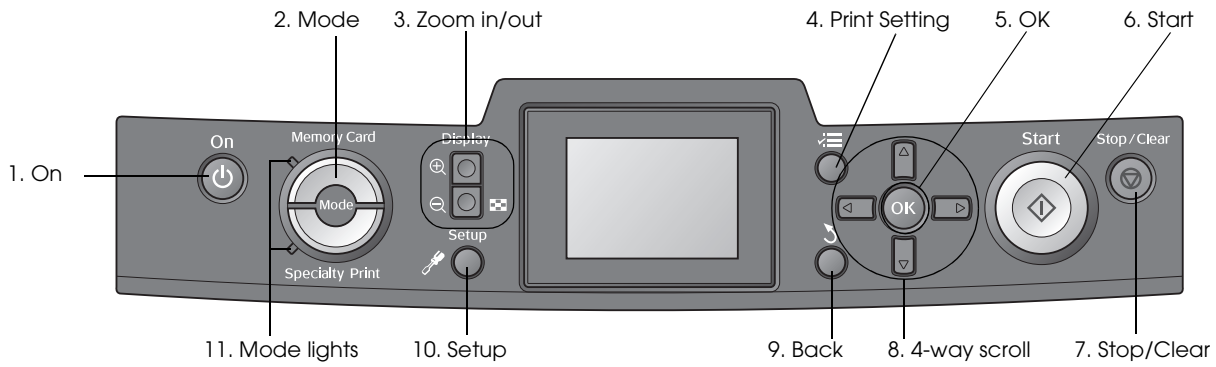

	Buttons and Lights	Function
1	⏻ On	Turns the printer on and off.
2	Mode*	Switches between Memory Card mode and Specialty Print mode. (Lights show which mode is selected.)
3	⏏ Zoom in / ⏏ Zoom out	Enlarges or reduces photos, or changes the view of the photos on the LCD panel.
4	⏏ Print Setting*	Displays print setting options.
5	OK	Opens the setting menu and selects the item to be set on the LCD panel.
6	⏏ Start	Starts printing with the settings on the LCD panel selected via the buttons on the control panel.
7	⏏ Stop/Clear	Cancels print operations or the settings on the LCD panel. Resets all printer settings when you press and hold this button for three seconds or more.
8	4-way scroll	Moves the cursor on the LCD panel. Increases and decreases numbers being entered.
9	⏏ Back	Returns to the main menu on the LCD panel.
10	⏏ Setup*	Displays setup and maintenance options.
11	Mode lights	Shows which mode is selected.

*For details on the items in each menu, see “Summary of Panel Settings” on page 34.

Note:

With the exception of the ⏏ Stop/Clear button and the ⏻ On button, the control panel buttons are used only with direct printing from a memory card.

Loading Paper

Loading Paper in the Sheet Feeder

Follow these steps to load paper.

1. Open the paper support, then slide out the extension.

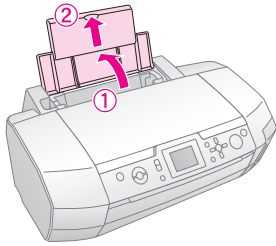

2. Lower the output tray and slide out the extension.

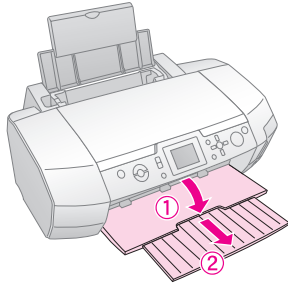

3. Slide the edge guide to the left.

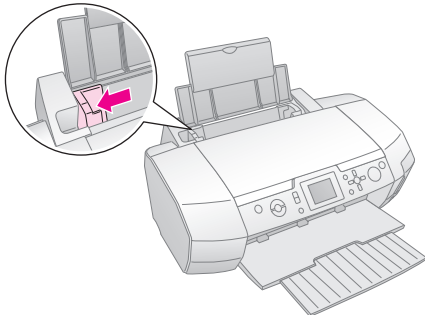

4. Fan a stack of paper, then tap it on a flat surface to even the edges.

5. Load the paper against the right side of the sheet feeder, with the printable side up. Place the stack of paper behind the tabs and make sure it fits under the \equiv mark inside the left edge guide. Always load paper short edge first, even for landscape printing.

A4

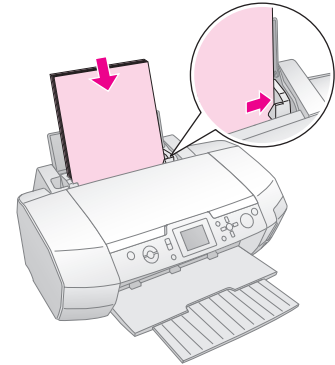

10 × 15 cm (4 × 6 in),
13 × 18 cm (5 × 7 in),
and A6

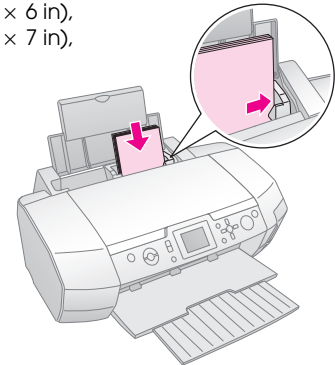

6. Slide the edge guide against the left edge guide of the paper (but not too tightly).

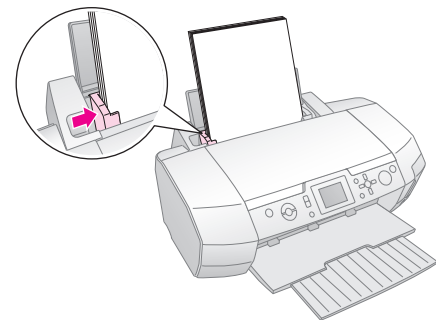

The loading capacity for each paper type is as follows.

Media Type	Loading Capacity
Epson Photo Quality Ink Jet Paper Epson Premium Ink Jet Plain Paper Plain paper	Up to 100 sheets
Epson Bright White Ink Jet Paper	Up to 80 sheets
Epson Premium Glossy Photo Paper Epson Premium Semigloss Photo Paper Epson Photo Paper Epson Economy Photo Paper Epson Matte Paper-Heavyweight Epson Ultra Glossy Photo Paper	Up to 20 sheets
Epson Photo Stickers Epson Iron-on Cool Peel Transfer Paper	One sheet at a time

Note:

- Leave enough space in front of the printer for the paper to be fully ejected.
- Always load paper into the sheet feeder short edge first, even when you're printing landscape-oriented pictures.
- Make sure the paper stack fits under the  arrow mark inside the left edge guide.
- Make sure the CD/DVD tray is not inserted in the printer and the CD/DVD guide is up.

Storing Your Printouts

With proper care, photographs from your printer will last for many years. The special Epson inks designed for your printer are formulated to achieve improved light fastness when used with Epson paper and the prints are properly displayed or stored.

As with traditional photos, proper care will minimize color changes and lengthen display life:

- For display, Epson recommends that prints be framed under glass or a protective plastic sleeve to protect them from atmospheric contaminants like humidity, cigarette smoke, and high levels of ozone.
- As with all photographs, keep your prints away from high temperatures and humidity and out of direct sunlight.
- For proper storage, Epson recommends that you keep prints in a photo album or plastic photo storage box in acid-free, archival sleeves commonly available at most camera stores.

Be sure to follow any other storage and display instructions included in the paper package.

Accessing Images to Print

Inserting a Memory Card

Precautions:

- ❑ Insert a memory card so that the top of the card faces the right side, as shown in the illustration.
- ❑ Loading a memory card in ways other than those shown here may damage the printer, memory card, or both.
- ❑ Use only one type of memory card at a time. Eject the loaded memory card before inserting another kind of memory card.
- ❑ Close the memory card slot cover when the memory card is in operation to protect the memory card from static electricity. If you touch the memory card when it is inserted in the printer, it may cause the printer to malfunction.
- ❑ Before loading the Memory Stick Duo, Memory Stick PRO Duo, miniSD card, and MagicGate Memory Stick Duo, attach the adapter provided with it.

Inserting a Memory Card

1. Press the **On** button to turn on your printer.
2. Open the memory card slot cover.
3. Insert the memory card as far as it can go into the appropriate slot as shown below. When it is in, the card light comes on.

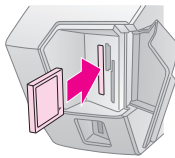
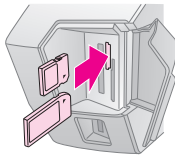
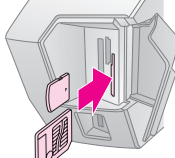
<p>CompactFlash/ Microdrive</p>	
<p>Memory Stick/ Memory Stick PRO/ Memory Stick Duo*/ Memory Stick PRO Duo*/ MagicGate Memory Stick/ MagicGate Memory Stick Duo*/ SD Card/ miniSD card*/ MultiMediaCard</p>	
<p>xD-Picture Card/ xD-Picture Card Type M/ SmartMedia</p>	

*Requires an adapter.

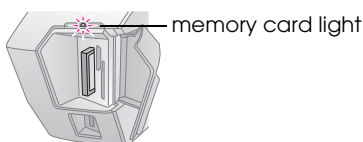

4. Close the memory card slot cover.

After a moment, the printer reads and counts the number of images on your card. When it's done, your images are available for printing (see page 11).

Removing a memory card

Make sure the card light is not flashing, then pull the card straight out of the slot.

Caution:

Do not remove a card while the card light is flashing; you may lose images on your card.

Connecting an External Device

You can connect external devices to the printer, such as an MO drive, CD-R drive, or USB flash drive, with a USB cable.

For details on printing with a Bluetooth Photo Print Adapter, see the on-screen *User's Guide*.

Note:

Not all devices that can be connected with a USB cable are supported. Contact your regional Customer Support for details.

Connecting

1. Remove any memory cards from the printer.

Note:

If you leave a card in the printer, images will be read from the card instead of your camera or storage drive.

2. Connect the USB cable from your storage device to the **EXT I/F** USB port on the front of the printer.

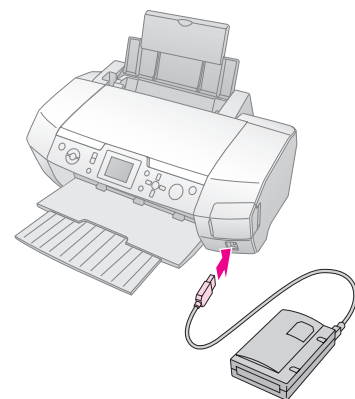

3. Turn on the printer and your storage device.

After a moment, the printer reads and counts the number of images on your card. When it's done, your images are available for printing (see page 11).

Saving your photos to an external device

If you don't have a computer, you can save photos that are on your camera's memory card to an external device that you connect directly to your printer. This lets you delete the images on your memory card and reuse it without losing your original photos. Follow the steps below to save your photos to a Zip disk, CD-R, DVD-R, or thumb drive:

Note:

Epson cannot guarantee the compatibility of any cameras or drives. If you're not sure about your camera or drive, you can try connecting it. If it's not compatible, you'll see a screen saying that the connected device cannot be used.

1. Make sure the printer is turned on and the memory card you want to back up is inserted in the printer.
2. If you are using a CD-R/RW drive or Zip drive, plug it into an electrical outlet if required.
3. Connect a USB cable from your drive to the **EXT I/F** USB port on the front of the printer (see page 9).
4. Press the **Setup** button on the printer.
5. Press the **▲** or **▼** button to highlight **Backup**, then press the **▶** button.
6. Press the **OK** button. When you see the "Starting backup" message, press the **OK** button again to start the backup procedure. You may have to follow additional instructions on the printer screen. All the photos on your card are copied to your external storage drive. Depending on how many photos there are, this may take several minutes.

Note:

- Do not perform backup while printing from the computer to the printer.
- Do not connect the external storage drive while the computer is accessing the memory card in the printer.
- The format for writing to CD-R is Multisession (Mode 1) and the file system is ISO 9660. Due to the ISO 9660 file system, the contents of a memory card that has 8 or more folder levels cannot be backed up to CD-R.
- The characters that can be used for folder and file names on the CD-R are capitals and the underscore (_). Other characters are changed to underscores when backing up to CD-R.

Printing Directly from a Digital Camera

PictBridge and USB DIRECT-PRINT lets you print your photos by connecting your digital camera directly to the printer.

Connecting and Printing

1. Make sure your printer is not printing from a computer.
2. Make sure that no memory card is loaded.
3. Turn the printer and load the type of paper you want to use. (see page 7)
4. Use the printer's control panel to adjust the print setting. (e.g. Paper Type, Paper Size, and Layout)
5. Turn the digital camera, then connect the printer and the digital camera with a USB cable.

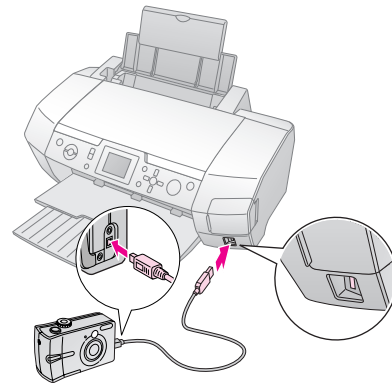

6. Use the digital camera to select the photo you want to print. Be sure to make the desired setting on the digital camera because the digital camera settings generally take precedence over the printer settings.
7. Print from the digital camera.



Note:

- Do not backup before or while a digital camera is connected to the printer.
- Some of the setting on your digital camera may not be reflected in the output because of the printer's specifications.
- Depending on the type of digital camera, images containing DPOF information may not be available for CD/DVD printing.

Printing Photos

Introducing Photo Printing

In the  **Memory Card** mode, you can print photos in various layouts.



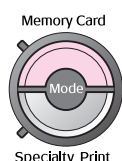



Before you begin, make sure the printer is in  **Memory Card** mode (The **Memory Card** mode light is on). If the printer is in  **Specialty Print** mode, press the **Memory Card** button to select  Memory Card mode.



The mode is set to print photos on 10×15 cm (4×6 in.) Premium Glossy Photo Paper, Borderless by default.



The first screen lets you choose which photos to print. You can choose how to select and print photos in the next table by pressing the  button.

For optional setting information, see “Photo Printing Options” on page 18.



	View and Print Photos: Select several photos, with one or more copies for each (page 11).
	Print All Photos: Print all the photos on your memory card (page 11).
	Print Range of Photos: Choose a sequence of photos on your memory card (page 12).
	Print by Date: Search photos by the date they were taken, and select the photos you want (page 12).
	Print Index Sheet: Print a thumbnail view of all the photos stored in your memory card (page 12).
	Play Slide Show: View all photos on your memory card in sequence like a slide show.
	Camera-selected DPOF Photos: Print a set of photos that you pre-selected in your digital camera using DPOF. This option appears by default and is available when photos have been selected with DPOF only. (See “Printing with DPOF Settings” on page 13.)

Printing several photos (View and Print Photos)



The following example shows you how to print a single borderless photo.



1. Press the  or  button to highlight **View and Print Photos** on the first screen, then press the **OK** button.





2. Press the  or  button to select the photo to print.

Note:

You can switch the view of photos by pressing the  Zoom out or  Zoom in button.

3. Press the  or  button to choose the number of copies for that photo (up to 99).
 4. Repeat steps 2 and 3 for additional photos.
 5. Make the paper settings. See “Making the Paper and Layout Settings” on page 18. The printer is set to print on 10×15 cm (4×6 in.) Premium Glossy Photo Paper, Borderless by default.
- Note:**
You can confirm the print settings by pressing the **OK** button.
6. Press the  **Start** button to print.

Printing all photos (Print All Photos)

1. Press the  or  button to highlight **Print All Photos** on the first screen, then press the **OK** button.



- Press the ▲ or ▼ button to select the number of copies.
- Make the paper settings, if necessary. See “Making the Paper and Layout Settings” on page 18. The printer is set to print on 10×15 cm (4×6 in.) Premium Glossy Photo Paper, Borderless by default.

Note:

You can confirm the print settings by pressing the **OK** button.

- Press the ⬠ **Start** button to print.

Printing a range of photos (Print Range of Photos)

Follow the steps below to choose a range (or sequence) of consecutive photos from your camera’s memory card.

- Press the ◀ or ▶ button to highlight **Print Range of Photos** on the first screen, then press the **OK** button.



- Press the ◀ or ▶ button to choose the first photo. Then press **OK**. The photo you select is highlighted in blue.

Note:

You can switch the view of photos by pressing the 🔍 Zoom out or 🔍 Zoom in button.

- Press the ◀, ▶, ▲ or ▼ button to choose the last photo. Then, press **OK**.
- Press the ▲ or ▼ button to select the number of copies.
- Make the paper settings. See “Making the Paper and Layout Settings” on page 18. The printer is set to print on 10×15 cm (4×6 in.) Premium Glossy Photo Paper, Borderless by default.

Note:

You can confirm the print settings by pressing the **OK** button.

- Press the ⬠ **Start** button to print.

Printing photos searching by date (Print by Date)

If you know the date the photos were taken, you can find and print them easily using this menu.

- Press the ◀ or ▶ button to highlight **Print by Date** on the first screen, then press the **OK** button.



- Press the ▲ or ▼ button to highlight the date you want, then the ▶ button to check the date. To clear the check, press the ◀ button.



- Press the **OK** button.
- Press the ◀ or ▶ button to select the photo you want.

Note:

You can switch the view of photos by pressing the 🔍 Zoom out or 🔍 Zoom in button.

- Press the ▲ or ▼ button to select the number of copies.
- Repeat steps 4 and 5 for additional photos.

Note:

You can confirm the print settings by pressing the **OK** button.

- Press the ⬠ **Start** button to print.

Printing an Index Sheet of photos

Note:

When printing an index sheet, the **Auto Correct** and **Filter** functions are not available.



Follow the steps below to print thumbnails with the photo number and the date the photo was taken.

1. Press the ◀ or ▶ button to highlight **Print Index Sheet** on the first screen, then press the **OK** button.



2. Press the ≡ Print Settings button.
3. Make the Paper Type setting.
4. Make the Paper Size setting.

The layout printed in this print mode is fixed by the paper size as follows.

10x15cm	13x18cm	A4
 20-up	 30-up	 80-up

Note:

You can confirm the print settings by pressing the **OK** button.

5. Press the ⬠ **Start** button to print.

Printing a Photo With a Frame Specified by Camera

If you want to print a photo with a frame you previously specified by EPSON camera, follow the steps below. When the photo data includes P.I.F. data, this **P.I.F.** icon appears on the LCD panel.

1. On the main menu, or after selecting photos, press the ≡ Print Setting button.

Note:

Select the photos from the View and Print Photos, Print All Photos, Print Range of Photos, or Print by Date menu.

2. Press the ▲ or ▼ button to select **Keep P.I.F. Frame with Photo**, then press the ▶ button.
3. Press the ▲ or ▼ to select **On**, then press the **OK** button.
4. Press the **OK** button to confirm the setting, and press the **OK** again to close the menu.
5. Print.

Note:

When **Keep P.I.F. Frame with Photo** is set to **On** and frames are specified for the photos, the **Layout** setting is ignored.

Printing with DPOF Settings

If your camera supports DPOF (Digital Print Order Format), you can use it to pre-select which photos and how many copies you want to print. See your digital camera's manual to choose photos for printing with DPOF, then insert your memory card in this printer. This printer automatically reads your pre-selected photos.

1. Load a memory card which contains DPOF data, and then press the **OK** button.
2. When this message appears, select **Yes**, and then press the **OK** button.



3. Make Paper Type, Paper Size, and Layout settings. For details, see "Making the Paper and Layout Settings" on page 18. The Total copies menu shows the number of sheets of paper required for the selected layout.

Note:

The Layout setting is not available when the DPOF settings are for an Index print.

4. Press the ⬠ **Start** button to start printing.

Changing the View of Photos on the LCD Panel

You can change the view to 9 photos on the LCD panel by pressing the Ⓞ Zoom out button when selecting photos. To change back to one photo, press the Ⓜ Zoom in button.

Note:

It is useful to view 9 photos when you choose photos to print in the Print Range of Photos or View and Print Photos settings.

Viewing a slide show

1. Press the ▲ or ▼ button to highlight **Play Slide Show** at the first screen, then press the **OK** button. Your printer shows the photos in the memory card in sequence.
2. Press the ↶ Back button to finish or the **OK** button to pause the slide show. Press the **OK** button again to resume.

Other Creative Printing Options

In Specialty Print mode, you can print on a CD/DVD, iron-on paper, stickers, or print with P.I.F. Frames.



Before you begin, make sure the printer is in **Specialty Print** mode (The Specialty Print mode light is on). If the printer is in **Memory Card** mode, press the **Specialty Print** button to select the Specialty Print mode.

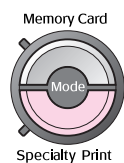

Printing on a CD/DVD

This section provides information on how to use the LCD panel to print directly onto a CD/DVD, without the use of a computer. It provides step-by-step instructions on how to load the CD/DVD in the printer, how to select the print layout, and how to adjust the print settings.

Use *EPSON Print CD* software if you are printing from a computer connected to the printer.

When printing on CD/DVD, keep the following points in mind:

Note:

- Use only CD/DVD media labeled as suitable for printing, for example "Printable on the label surface" or "Printable with ink jet printers."
- The printed surface is easily smeared immediately after printing.
- Be sure to let a CD/DVD dry completely before using it or touching the printed surface.
- Do not allow the printed CD/DVD to dry in direct sunlight.
- Moisture on the printable surface may cause smearing.
- If the CD/DVD tray or the internal transparent compartment are accidentally printed on, immediately wipe off the ink.
- Reprinting on the same CD/DVD may not improve the print quality.
- You can set the printable area of a CD/DVD using EPSON Print CD. Set the printable area to fit the printable area of the CD/DVD that you are printing on. When you make settings, note that improper settings may stain the CD/DVD tray, CD, or DVD.

Preparing to print on a CD/DVD

1. Open the output tray, then open the CD/DVD guide.

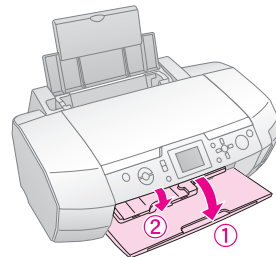

2. Place the CD/DVD on the CD/DVD tray with the label surface up.

Note:

Only load one disc at a time.

3. Insert the CD/DVD tray into the CD/DVD guide.

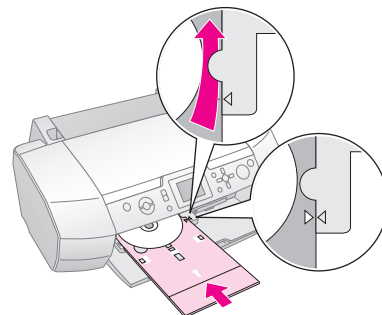

Note:

- Align the ► mark on the CD/DVD tray with the ► mark on the CD/DVD guide.
- Insert the CD/DVD tray so that the CD/DVD tray passes under the small rollers on both sides of the CD/DVD slot.

4. Insert the memory card containing the photos you want to print into the memory card slot.

Making the settings and printing

1. Press the **Specialty Print** button.
2. Press the ◀ or ▶ button to select **CD/DVD Print**, then press the **OK** button.



- Press the Print Settings button to open the menu. Make the Layout setting and press the **OK** button.

You can select the following layout options when printing on a CD/DVD.

1-up		One photo will be printed on the CD/DVD, centered on the hole in the middle of the disc.
4-up		Four photos will be printed on the CD/DVD, with one photo in each of the four quarters.
8-up		8 photos will be printed on the CD/DVD, arranged in a circle around the outer edge of the disc.
12-up		12 photos will be printed on the CD/DVD, arranged in a circle around the outer edge of the disc.

- Press the or button to select the photos you want to print.
- Press the button to specify the number of copies for each photo if you selected the 4-up, 8-up, or 12-up option for the Layout setting.

Note:

- To select more than one photo, repeat steps 4 and 5 to select other photos and the number of times to print them.
- The total number of images that will be printed is displayed at the bottom of the LCD display.
- When selecting photos for the 4-up, 8-up, or 12-up layout setting, you can select a number of photos less than the total. Unused areas of the layout will be left blank. If you specify a number of photos greater than will fit on one CD/DVD, the extra images will be added to a layout for an extra CD/DVD and the printer will ask you to load another CD/DVD after printing the CD/DVD.
- You can confirm the print settings by pressing the **OK** button.

- Adjust the printing area (inside and outside diameter) if needed. For details, see the following section.
- Press the **Start** button to print.

Note:

- We recommend that you print a test of the layout on a test CD/DVD, before printing on a real CD/DVD.
- Allow CDs and DVDs to dry for 24 hours.
- If necessary, you can adjust the print position. See “If the printing is misaligned” on page 15 for details.
- If an error message appears on the LCD panel, follow the instructions on the LCD panel to clear the error.

Adjusting the printing area

Follow the steps below to adjust the diameter of the printing area on a CD or DVD.

- Press the **Setup** button to open the Setup menu.

- To adjust the inside diameter of the printing area, select **CD/DVD Position Inside**. To adjust the outside diameter of the printing area, select **CD/DVD Position Outside**, then press the button.

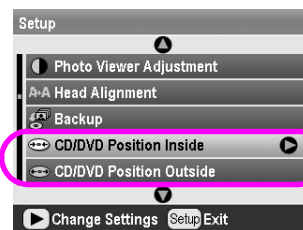

- Set the appropriate value. You can adjust the inside diameter between 18 to 46 mm, and the outside diameter between 114 to 120 mm, at intervals of 1 mm.
- Press the **OK** button to set the changes you made and return to the Setup menu.

If the printing is misaligned

Follow the steps below to adjust the print position, if necessary.

- Press the **Setup** button to open the Setup menu.
- To move the image up or down, select **CD/DVD Position Up/Down**. To move the image to the left or right, select **CD/DVD Position Left/Right**, then press the button.



- Select the amount to move the image. Set a minus quantity (button) when moving the image down or left, or a plus quantity (button) when moving it up or right. Then press the **OK** button. You can select from -2.0mm to 2.0mm.

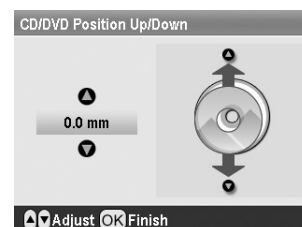

- Press the **OK** button to set the changes you made and return to the Setup menu.

Note:

The printer remembers the print adjustment setting even after it has been turned off, so you do not need to adjust the position each time you use the CD/DVD function.

Printing a CD Jacket

You can print a CD jacket on A4 paper in either upper half print format or in index style in Memory Card mode. You can print up to 24 photos on one sheet.

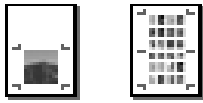

1. Load A4 size paper.
2. Press the **Memory Card** button.
3. Press the ◀ or ▶ button to select **View and Print Photos**, then press the **OK** button.
4. Press the **Print Setting** button.
5. Select the appropriate Paper Type setting for the paper loaded.
6. Select **A4** as the Paper Size setting.
7. Select **Jewel Case Upper 1/2** or **Jewel Case Index** and press the **OK** button.
8. Press the ◀ or ▶ button to select the photos you want to print for your print layout.
9. Press the ▲ or ▼ button to select the number of copies for each photo.
10. Press the **Start** button to print.

Printing with Frames

You can decorate your photo by printing it with a frame! In this mode, the photo is printed borderless. As well as the preset frames, you can add frames from the memory card by using PIF DESIGNER and EPSON PRINT Image Framer Tool software contained in the software CD-ROM. For details on using the software, see the on-screen *User's Guide*.

1. Insert the memory card containing digital photo data and PRINT Image Framer data (P.I.F. Frame) into the memory card slot.

Note:

- ❑ If you have saved or deleted data on the memory card via your computer and have not ejected the memory card from the printer since, eject and reinsert the memory card before printing.
 - ❑ Be sure to save the PRINT Image Framer data to the memory card using the EPSON PRINT Image Framer Tool; otherwise the P.I.F. file name will not appear on the LCD panel.
2. Press the **Specialty Print** button.

3. Press the ◀ or ▶ button to select **P.I.F. Print**, then press the **OK** button.



4. Press the ▶ button to select the P.I.F. Frame you want to use, then press the **OK** button.

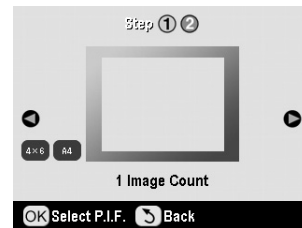

Note:

The available paper sizes to print with the selected P.I.F. Frame appear at the bottom left of the panel.

5. Press the ◀ or ▶ button to select the photo you want to print, and then press the **OK** button.

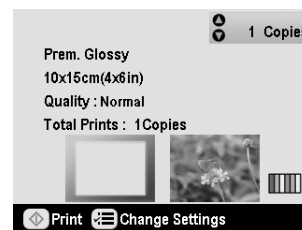

6. Press the ▲ or ▼ button to select the number of copies for each photo.
7. Confirm the layout and number of prints on the LCD panel.
8. Load appropriate paper.
9. Press the **Start** button to print.

Printing on Stickers

You can print up to 16 stickers on one Photo Stickers paper.

Note:

You can also print on Stickers in **Memory Card** mode by choosing **Photo Stickers** as the Paper Type.

1. Load EPSON Photo Stickers paper.
2. Press the **Specialty Print** button.

- Press the **▶** or **◀** button to select **Photo Stickers**, then press the **OK** button.



- Press the **◀** or **▶** button to select the photos you want to print.
- Press the **▲** or **▼** button to select the number of copies for each photo.

Note:

You can confirm the print settings by pressing the **OK** button.

- Press the **◊ Start** button to print.

If the printing is misaligned

Follow the steps below to adjust the print position, if necessary.

- Press the **Setup** button to open the Setup menu.
- To move the image up or down, select **Photo Sticker Position Up/Down**. To move the image to the left or right, select **Photo Sticker Position Left/Right**, then press the **▶** button.



- Select the amount to move the image. Set a minus quantity when moving the image down or left, or a plus quantity when moving it up or right. Then press the **OK** button.
You can select from -2.5mm to 2.5mm.

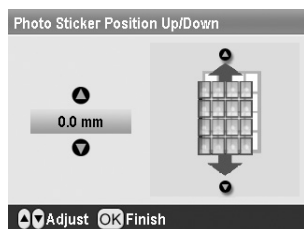

- Press the **OK** button to return to the main screen, then press the **◊ Start** button to print.

Note:

The printer remembers the print adjustment setting even after it has been turned off, so you do not need to adjust the position each time.

Printing on EPSON Iron-On Cool Peel Transfer Paper

You can print an image on EPSON Iron-On Cool Peel Transfer Paper and copy the printed image onto fabric using an iron.

Note:

You can also print on Iron-On Paper in **Memory Card** mode by choosing **Iron-on** as the Paper Type.

- Load EPSON Iron-On Cool Peel Transfer Paper.
- Press the **Specialty Print** button.
- Press the **◀** or **▶** button to select **Iron on**, then press the **OK** button.



- Make the Layout setting. See "Making the Paper and Layout Settings" on page 18.
- Press the **◀** or **▶** button to select the photos you want to print.
- Press the **▲** or **▼** button to select the number of copies for each photo.

Note:

You can confirm the print settings by pressing the **OK** button.





- Press the **◊ Start** button to print.

Photo Printing Options



After selecting the photos to print, press the  Print Setting button to see the optional setting menus where you can make paper, layout, color or other optional settings.

Making the Paper and Layout Settings

After selecting photos to print, set the Paper Size, Paper Type, and Layout for the selected photos and loaded paper.

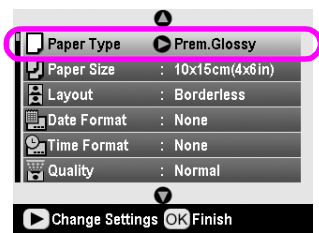
1. Press the  Print Setting button. The optional menu appears.
2. Press the  or  button to select **Paper Type** and press the  button.



3. Press the  or  button to select the setting from the following table that matches the type of paper you loaded, then press the **OK** button.

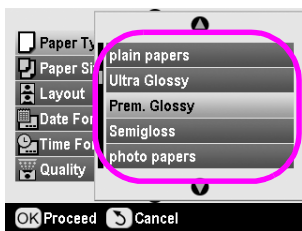



Paper Type List

For this paper	Select this Paper Type setting
Plain paper	plain papers
Epson Ultra Glossy Photo Paper	Ultra Glossy
Epson Premium Glossy Photo Paper	Prem. Glossy
Epson Premium Semigloss Photo Paper	Semigloss
Epson Economy Photo Paper	photo papers
Epson Matte Paper-Heavyweight	Matte
Epson Photo Quality Ink Jet Paper	PQIJ
Epson Photo Stickers 16	Photo Stickers
Epson Iron-On Cool Peel Transfer Paper	Iron-on

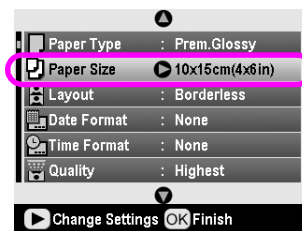
4. Press the  or  button to select **Paper Size**, then press the  button.



5. Press the  or  button to select a paper size from the list below, then press the **OK** button to set.

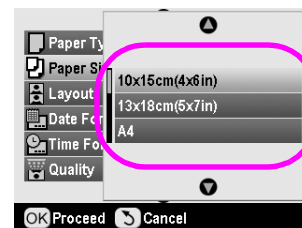

Paper Size List





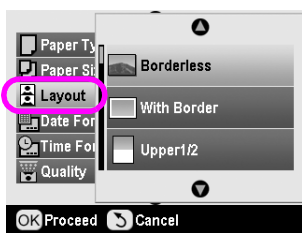







10 × 15 cm (4 × 6 in)
13 × 18 cm (5 × 7 in)
A4
A6

6. Press the ▼ or ▲ button to select **Layout** and press the ► button.



7. Select one of the following layout options, then press the **OK** button. You have now finished paper and layout settings.

Layout List

Borderless		Prints without a margin.
With Border		Prints with a 3-mm margin on all sides.
Upper 1/2		Prints on upper half of paper without a margin.
2-up 	4-up 	Prints multiple photos on one sheet. In 20-up layout, the numbers and photo dates are printed. The size of each photo is adjusted automatically according to the number of photos to print and the size of paper.
8-up 	20-up 	
Jewel Case Upper 1/2 	Jewel Case Index 	
20-up 	30-up 	Prints thumbnails with numbers and the date the photos were taken. These index layouts are only available when Print Index Sheet is selected on the main menu.
80-up 		

When Borderless printing, note the following:

- Because this setting enlarges the image to a size slightly larger than the paper size, the portion of the image that extends beyond the edges of the paper will not be printed.
- Print quality may decline in the top and bottom areas of the printout, or the area may be smeared when printing.

Improving Print Quality

You can adjust the quality of your printouts.

Note:

Higher quality printing takes longer to print.

- After selecting the photos, number of copies, paper type, paper size, and layout as described on page 18, press the  Print Setting button.
- Select **Quality**, then press the ► button to open the menu.
- Press the ▲ or ▼ button to choose the **High** or **Highest**, then press the **OK** button.
- Press the **OK** button.

Touching Up Your Photos

This printer lets you correct the color and improve the image quality of your photos without using a computer. Two basic types of adjustments are available:

■ Automatic adjustments

If your camera supports PRINT Image Matching or Exif Print, you can use the printer's P.I.M. or Exif Print setting to automatically adjust your photos for the best results.

If your camera doesn't support PRINT Image Matching or Exif Print, you can use PhotoEnhance™ to make adjustments for the type of environment in which your photos were taken.

■ Manual adjustments

If your photos are too light or too dark, you can adjust their brightness or control the saturation and sharpness.

If you want, you can make manual adjustments while P.I.M., Exif Print, or PhotoEnhance are turned on in order to fine-tune your automatic settings.

Note:

- These settings affect only your printed pictures. They do not change your original image files.
- These settings are saved when you turn off the printer or choose a different set of photos, so remember to turn off the settings when you're done.

Automatically adjusting your photos

When you use the printer's automatic image adjustments, the adjustments are applied to all your photos.

1. Press the Print Setting button.
2. Press the or button to highlight **Auto Correct**, then press the button.
3. Select from these options, then press the **OK** button twice.

Setting item	Function
P.I.M.	Uses your camera's PRINT Image Matching settings (this option is automatically selected when your pictures contain P.I.M. data).
PhotoEnhance	Adjusts the brightness, contrast, and saturation of your photos.
Exif	Uses your camera's Exif Print settings (this option is automatically selected when your pictures contain Exif Print data).
None	Select this if you don't want to use P.I.M., Exif, or PhotoEnhance.

To make manual adjustments in addition to the automatic ones, follow the steps in the next section.

Manually adjusting your photos

1. Press the Print Setting button.
2. Press the or button to highlight, **Brightness**, **Contrast**, **Saturation**, or **Sharpness**, then press the button.
3. Adjust any settings as necessary, then press the **OK** button twice.

Cropping and Sizing Your Photos

You can print just part of a photo, cropping out the area that you do not want. You can choose only one photo to crop at a time.

1. Choose the photo you want to crop with the **View and Print Photos** option. See "Printing several photos (View and Print Photos)" on page 11.

2. Press the Zoom in button to crop a photo. You will see an orange frame around the cropped area.

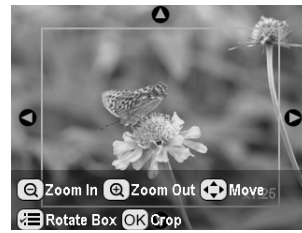

3. Use the following button to set the area you want to crop.
 - Press the Zoom in or Zoom out button to change the frame size.
 - Press the , , or button to move the frame.
 - Press the Print Setting button to rotate the frame.

4. Press the **OK** button to confirm the cropped image.

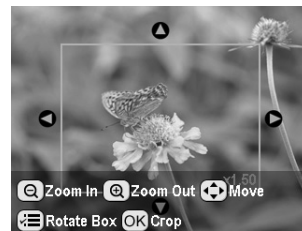

Note:

This setting remains in effect until you print or press the Stop/Clear button.

5. After checking the cropped image, press the **OK** button.
6. If you do not need to change any other settings, press the **OK** button or close the menu.

Adding the Date or Time

You can print the date and/or time the photo was originally taken on the bottom right of your print.

1. After selecting the photos, number of copies, paper type, paper size, and layout as described on page 18, press the Print Setting button.
2. To print the date, select **Date Format**, then press the button to open the menu.

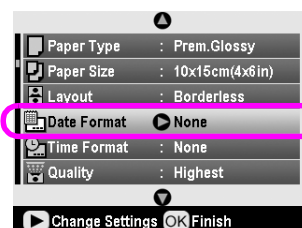

3. Press the ▲ or ▼ button to choose a setting:

None (default, turns off the date stamp)
yyyy.mm.dd (2005.09.01)
mmm.dd.yyyy (Sep.01.2005)
dd.mm.yyyy (01.Sep.2005)

4. Press the **OK** button.
5. To print the time, select **Time Format**, then press the ► button to open the menu.

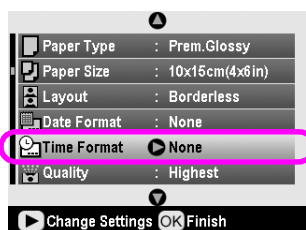

6. Press the ▼ or ▲ button to choose a setting:

None (default, turns off the time stamp)
12-hour system (03:00 for 3:00 pm)
24-hour system (15:00 for 3:00 pm)

7. Press the **OK** button.

When **Date Format** or **Time Format** is turned on, the information is printed on all photos in any layout for which the information is allowed.

Note:

These settings are saved when you turn off the printer or choose a different set of photos, so remember to change the settings back to **Off** when you are done.

Printing Photos in Black and White or Sepia

You can print your photo in black and white or in a sepia tone without changing the original photo.

Note:

A sepia print has a brownish tone, for an old-fashioned photo look.

1. After selecting the photos, number of copies, paper type, paper size, and layout as described on page 18, press the ≡ Print Setting button.
2. Select **Filter**, then press the ► button to open the menu.
3. Press the ▲ or ▼ button to choose the **B&W** or **Sepia**, then press the **OK** button.
4. Press the **OK** button.

Fit to Frame

This setting automatically trims the parts of an image that extend beyond the margins of the selected print size. Either the top and bottom areas or the left and right areas of the image will be trimmed, depending on the aspect ratio of the original photo and the selected print size. The default setting is On.

On	Trims the image.
Off	Does not trim the image

Resize each photo (without trimming it) so that it fits inside the print area specified on the Layout menu. Margins may appear at the left and right of the photo, depending on the print size and aspect ratio.

Setting the Printer Preferences

Adjusting the LCD Brightness

If the LCD panel is difficult to read, you can adjust the brightness.

1. Press the **Setup** button to open the Setup menu.
2. Press the **▲** or **▼** button to select **Photo Viewer Adjustment**, then press the **▶** button.
3. Press the **▲** or **▼** button to adjust the brightness, then press the **OK** button.

Restoring to Default Settings

After you change your settings, you may want to reset the printer's settings (such as the layout, color effects, or crop settings) to the default settings before printing other photos.

1. Press the **Setup** button to open the Setup menu.
2. Press the **▲** or **▼** button to select **Restore to Factory Settings**, then press the **▶** button.
3. Press the **OK** button to restore the settings to their defaults.

Note:

Not all settings are returned to their defaults using the Restore Factory Settings function.

Setting the Screen Saver

You can set photos on the inserted memory card as the screen saver on the LCD panel. After about 3 minutes of inactivity the screen saver comes on. After about 10 minutes the printer enters sleep mode.

1. Press the **Setup** button to open the Setup menu.
2. Press the **▲** or **▼** button to select **Screen Saver Settings**, then press the **▶** button.
3. Select **Card Data** and press the **OK** button.

Replacing Ink Cartridges

Checking the ink supply

You can check the ink supply in the right bottom on LCD panel as an icon.



To check the details, do the following:

1. Press the **Setup** button, press the **▲** or **▼** button to highlight **Ink Levels**, then press the **▶** button.

You see a graphic showing the amount of ink available in each cartridge.

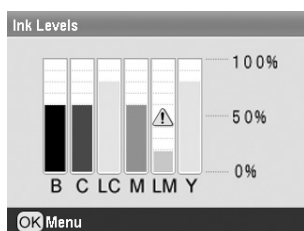

B (Black) **C** (Cyan), **LC** (Light Cyan), **M** (Magenta), **LM** (Light Magenta), and **Y** (Yellow).

When your ink starts getting low, this mark  is displayed.

2. Press the **OK** button to return to the previous screen once you have checked the ink levels.

When your ink starts getting low, make sure you have replacement cartridges available. You can not print if a cartridge is empty.

Precautions on ink cartridge replacement

Read all of the instructions in this section before replacing the ink cartridges.

Warning:

If ink gets on your hands, wash them thoroughly with soap and water. If ink gets in your eyes, flush them immediately with water. If you still have discomfort or vision problems, see a doctor immediately.

Caution:

- ❑ To avoid damaging the printer, never move the print head by hand.
- ❑ When an ink cartridge is empty, you cannot continue printing even if the other cartridges still contain ink.
- ❑ Leave the empty cartridge installed in the printer until you have obtained a replacement. Otherwise the ink remaining in the print head nozzles may dry out.
- ❑ An IC chip on each ink cartridge accurately monitors the amount of ink used from the cartridge. Even if a cartridge is removed and then inserted again, all of its ink can be used. However, some ink is consumed each time the cartridge is inserted because the automatically checks its reliability.
- ❑ Epson recommends the use of genuine Epson ink cartridges. Other products not manufactured by Epson may cause printer damage that is not covered by Epson's warranties, and under certain circumstances, may cause erratic printer behavior.

Replacing an ink cartridge

1. Make sure that the printer is on but not printing, then open the printer cover.

Note:

Make sure the CD/DVD tray is not inserted in the printer before you replace the ink cartridge.

2. Check that the message "Ink out" is displayed on the LCD panel and press the **OK** button.

Note:

The message is not displayed if there is some ink left. In this case, press the **Setup** button, select **Ink Cartridge Replacement**, then press the **▶** button. Next, press the **OK** button. To find out which cartridge requires replacing, see "Checking the ink supply" on page 23.

The ink cartridge moves slowly to the replacement position.

Caution:

Do not move the print head by hand, as this may damage the printer. Always press the **OK** button to move it.

- Remove the new ink cartridge from the package.

Caution:

- Be careful not to break the hooks on the side of the ink cartridge when you remove it from the package.
- Do not remove or tear the label on the cartridge; otherwise, ink will leak.
- Do not touch the green IC chip on the front of the cartridge. This can damage the ink cartridge.

* Do not touch this part.

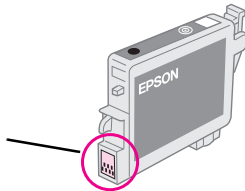

- Be sure to always install an ink cartridge into the printer immediately following the removal of the current ink cartridge. If the ink cartridge is not installed promptly, the print head may dry out, rendering it unable to print.

- Open the cartridge cover.

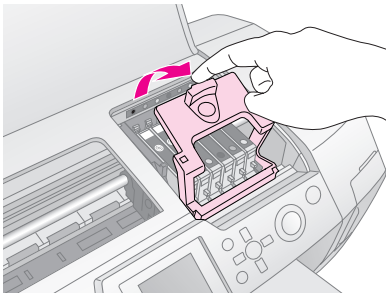

- Pinch the sides of the ink cartridge that you want to replace. Lift the cartridge out of the printer and dispose of it properly. Do not take the used cartridge apart or try to refill it.

The illustration shows replacement of the black ink cartridge.

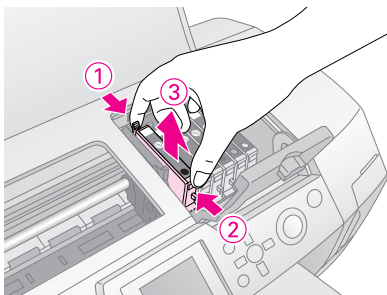

- Place the ink cartridge vertically into the cartridge holder. Then, push the ink cartridge down until it clicks into place.

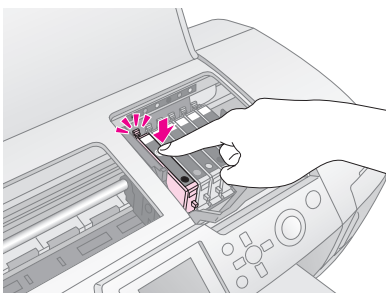

- When you have finished replacing the cartridge, close the cartridge cover and the printer cover.
- Press the **OK** button. The print head will move and charging of the ink delivery system will begin. When the ink charging process is finished, the print head will return to its home position.

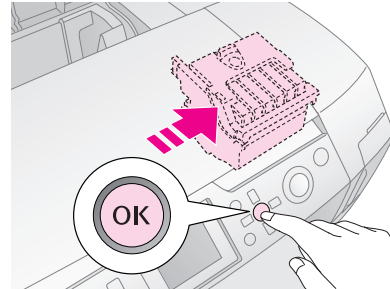

Caution:

Never turn off the power supply to the printer before the completion message is displayed. Doing so can result in incomplete charging of ink.

- When the message "Ink cartridge replacement is complete" is displayed on the LCD panel, press the **OK** button.

Note:

If the ink end error occurs after the print head moves to its home position, the ink cartridge may not be installed properly. Press the **OK** button again, and reinstall the ink cartridge until it clicks into place.

Maintenance and Transporting

Improving Print Quality

Cleaning the print head

If your printouts are unexpectedly light or faint, or dots or lines are missing, you may need to clean the print head. This unclogs the nozzles so they can deliver ink properly. Print head cleaning uses ink, so clean it only if quality declines.

Caution:

When you don't turn on your printer for a long time, the print quality can decline, so turn it on at least once a month to maintain good print quality.

Follow these steps to clean the print head from the printer's control panel:

1. Make sure the printer is turned on but not printing, and no error is displayed. If the ink low or ink end error is displayed, you may need to replace an ink cartridge; see page 23 for details.
2. Press the **Setup** button, press the **▲** or **▼** button to highlight **Head Cleaning**, then press the **▶** button.
3. To begin cleaning, press the **Start** button. The printer makes noise and you see a progress bar on the LCD panel. Cleaning takes about 30 seconds.

Caution:

Do not turn off the printer or interrupt the cleaning process.

4. When cleaning is done, run a nozzle check to confirm the print head nozzles are clean. Make sure A4 plain paper is loaded in the printer, then press the **OK** button.
5. Press the **Start** button. The nozzle check pattern is printed.
6. Examine the nozzle check pattern you printed. Each staggered horizontal and straight vertical line should be complete, with no gaps in the pattern, as shown below:

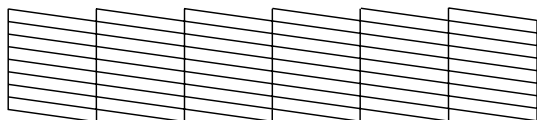

- If your printout looks okay, you are done. Press the **Back** button to finish.

- If there are any gaps (as shown below), press the **OK** button to clean the print head again.

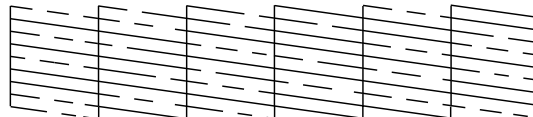

If you do not see any improvement after cleaning three or four times, check the solutions beginning on page 29. You can also turn the printer off and wait overnight—this allows any dried ink to soften—and then try cleaning the print head again.

Aligning the print head

If your printouts contain misaligned vertical lines or horizontal banding, you may need to align the print head.

You can align the print head either from the printer's control panel or using your printer software.

Note:

For the best results, load A4 Epson Photo Quality Ink Jet Paper in the printer whenever you check the print head alignment.

1. Make sure the printer is turned on but not printing, and A4 paper is loaded.
2. Press the **Setup** button, press the **▲** or **▼** button to highlight **Head Alignment**, then press the **▶** button.
3. Press the **Start** button to print the alignment pattern.
4. The following alignment sheet is printed.

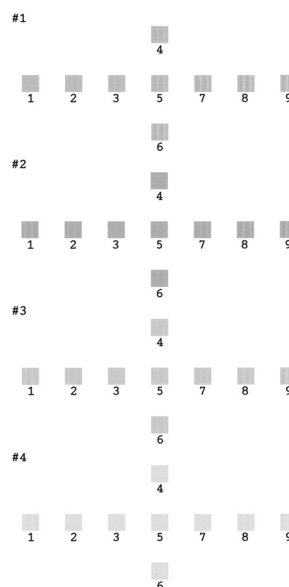

5. Look at the alignment pattern in each set and find the patch which is most evenly printed, with no noticeable streaks or lines.
6. Press the ► button, then press the ▲ or ▼ button to highlight the number for the best pattern (1 to 9) in set #1, then press the OK button.
7. Repeat step 6 to select the best pattern for sets #2, #3, and #4.
8. When you have finished, press the OK button.

Cleaning the Printer

To keep your printer working at its best, you should clean it several times a year. Follow these steps:

1. Turn off the printer, unplug the power cord, and disconnect the printer cable.
2. Remove all paper, then use a soft brush to clean any dust or dirt from the sheet feeder.
3. Clean the exterior of the printer with a soft, damp cloth.
4. Use a soft, dry cloth to clean the LCD panel. Do not use liquid or chemical cleaners on the LCD panel.
5. If ink has spilled inside the printer, wipe it off only in the area shown below using a soft, damp cloth.

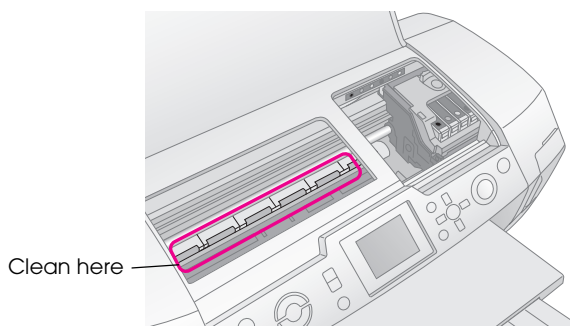

⚠ Warning:

Do not touch the gears inside the printer.

⚠ Caution:

- ❑ Be careful not to wipe away lubricating grease inside the printer.
- ❑ Never use a hard or abrasive brush, or alcohol or thinner for cleaning; they can damage the printer components and case.
- ❑ Do not get water on the printer components and do not spray lubricants or oils inside the printer.
- ❑ Do not apply grease to the metal parts under the print head carriage.

Transporting the Printer

If you move your printer some distance, you need to prepare it for transportation in its original box or one of a similar size.

⚠ Caution:

To avoid damage, always leave the ink cartridges installed when transporting the printer.

1. Turn on the printer, wait until the print head locks in the far right position, then turn off the printer.
2. Unplug the power cord from the electrical outlet. Then disconnect the printer cable from the printer.
3. Remove any memory cards from the printer and close the memory card cover.
4. Remove any paper from the printer, push down the paper support extension, and close the paper support.
5. Open the printer cover. Secure the ink cartridge holder to the printer with tape as shown, then close the printer cover.

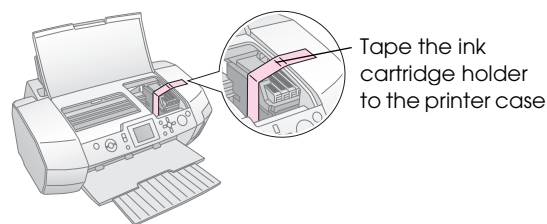

6. Make sure the CD/DVD tray guide is closed, then push in the output tray extension and close the output tray.
7. Repack the printer and its attachments in the original box using the protective materials that came with them.

Keep the printer level as you transport it. After transporting the printer, remove the tape securing the print head and test your printer. If you notice a decline in print quality, clean the print head (see page 25); if output is misaligned, align the print head (see page 25).

Troubleshooting

If you have a problem with your printer, check the messages on the LCD panel screen.

Error Messages

You can diagnose and solve most problems by checking the error messages on the LCD screen. If you cannot solve the problems by checking the messages, use the following table and try the recommended solution.

Note:

The solutions are for the problems that happen when using this product.

Error Messages	Solution
No memory card or disk inserted, or it cannot be recognized.	Make sure the memory card or storage disk has been inserted correctly. If so, check to see if there is a problem with the card or disk and try again. Make sure the card or disk contains images.
Cannot recognize the memory card or disk.	Make sure the memory card or storage disk has been inserted correctly. If so, check to see if there is a problem with the card or disk and try again.
Cannot recognize the device.	Make sure the memory card has been inserted correctly. If you connected a USB device, make sure the disk has been inserted correctly.
Printer error occurred. Please see your manual.	Turn the printer off and then back on. If the error message still appears, contact your dealer.
Service required. See your manual for details.	Contact your dealer.
Cannot perform the print head cleaning due to low ink level.	You need enough ink to perform print head cleaning. Replace the ink cartridge that is low.

Print Quality Problems

You see banding (light lines) in your printouts or copies.

- Make sure that the printable side of the paper is face up in the sheet feeder. Run the Head Cleaning utility to clear any clogged ink nozzles.
➔ See “Cleaning the print head” on page 25
- Run the Print Head Alignment utility.
➔ See “Aligning the print head” on page 25
- Use up ink cartridges within six months after opening their packages.
- Check the LCD panel. If the ink low message is displayed, replace the appropriate ink cartridge.
➔ See “Replacing Ink Cartridges” on page 23
- Make sure that the Paper Type selected on the LCD panel is appropriate for the type of media loaded in the printer.

Your printout is faint or has gaps.

- Make sure that the printable side of the paper is face up in the sheet feeder.
- When you set the **Quality** setting on the **Print Setting** menu to **High** or **Normal**, set the **Bidirectional** setting to **Off**. Bidirectional printing decreases print quality.
- Run the Head Cleaning utility to clear any clogged ink nozzles.
➔ See “Cleaning the print head” on page 25
- Run the Print Head Alignment utility.
➔ See “Aligning the print head” on page 25
- Make sure that the Paper Type selected on the LCD panel is appropriate for the type of media loaded in the printer.
- The ink cartridge may be old or low on ink.
➔ See “Replacing Ink Cartridges” on page 23

You see wrong or missing colors.

- Run the Head Cleaning utility.
➔ See “Cleaning the print head” on page 25

- If colors are still incorrect or missing, replace the color ink cartridges. If the problem persists, replace the black ink cartridge.
➔ See “Replacing Ink Cartridges” on page 23
- If you have just replaced an ink cartridge, make sure the date on the box has not expired. Also, if you have not used the printer for a long time, replace the ink cartridges with new cartridges.
➔ See “Replacing Ink Cartridges” on page 23
- Make sure that the Paper Type selected on the LCD panel is appropriate for the type of media loaded in the printer.
Make sure you are not using a special effect that alters image colors, like Sepia.

Your printout is blurry or smeared.

- Make sure that the Paper Type setting on the LCD panel is correct. Remove each sheet from the output tray as it is printed.
If you are printing on glossy media, place a support sheet (or a sheet of plain paper) beneath the stack, or load only one sheet at a time. Do not touch or allow anything to come into contact with the printed side of paper with a shiny finish. After printing documents on glossy media, allow the ink to set for a few hours before handling them.
Run the Head Cleaning utility.
➔ See “Cleaning the print head” on page 25
- Run the Print Head Alignment utility.
➔ See “Aligning the print head” on page 25
- Load and eject dry paper several times.
➔ See “Using the Paper Feed/Paper Eject function” on page 30
- If the problem persists, ink may have leaked inside the printer. In this case, wipe the inside of the printer with a soft, clean cloth.
➔ See “Cleaning the Printer” on page 26

Miscellaneous Printout Problems

Blank pages print

- Run the Head Cleaning utility to clear any clogged nozzles.
➔ See “Cleaning the print head” on page 25

Margins appear or the outer edge is cut off on borderless photos

- Change the **Borderless Expansion** setting on the  **Print Setting** menu to adjust the amount of image that extends beyond the paper size during borderless printing.

Paper is rubbed during printing





When you print on thick paper, change the **Thick Paper** setting to **On** in the  **Print Settings** menu. This widens the gap where the paper feeds.

Smudges or blots appear on the printout

Feed paper and clean the roller inside.
➔ See “Using the Paper Feed/Paper Eject function” on page 30

Paper Does Not Feed Correctly

Paper does not feed correctly or is jammed



- If paper does not feed, remove it from the sheet feeder. Fan the paper. Load it against the right side, and slide the left edge guide against the paper (but not too tightly). Do not load too many sheets at once (do not go past the  arrow mark on the left edge guide) ➔ page 7 for more information.
- If paper is jammed, press the  **Start** button to eject the jammed paper. If the paper is not ejected, turn off the power, then open the printer cover and the CD/DVD guide. Remove all of the paper inside, including any torn pieces, then close the CD/DVD guide. Reload paper, turn the power back on, and press the  **Start** button to resume printing.
- If paper jams frequently, make sure the left edge guide is not pushed too tightly against the paper. Try loading fewer sheets of paper. The stack should never be above the  arrow mark on the left edge guide. ➔ page 7 for more information and follow the instructions that came with your paper.
You may also have pushed the paper down too far into the sheet feeder. Turn the power off and carefully remove the paper. Then reload the paper.

The CD/DVD tray is ejected when sending a CD/DVD print job

If the CD/DVD tray is ejected when you send a CD/DVD print job and an error message appears on the LCD panel or computer screen, follow the instructions on the LCD panel to clear the error.

Printer Does Not Print

LCD panel is off

- If the Screen Saver function is set to On, press any button except the  **On** button to “wake” the screen.
- Press the  **On** button to make sure that the printer is on.
- Turn off the printer and make sure that the power cord is securely plugged in.
- Make sure that your outlet works and is not controlled by a wall switch or timer.

LCD panel displays a warning or error message

If the LCD panel displays a warning or error message, follow the instructions. See “Error Messages” on page 27 for an explanation of warnings and error messages.

LCD panel and the mode light came on and then went out

The printer’s voltage may not match the outlet rating. Turn off the printer and unplug it immediately. Then, check the printer labels.

Caution:

If the voltage does not match, DO NOT PLUG YOUR PRINTER BACK IN. Contact your dealer.

Print head carriage problem





If the Cartridge cover does not close or the print head carriage does not move to its home position, open the cartridge cover and push the ink cartridges down until they click into place.

Canceling Printing

If you encounter problems while printing, you may need to cancel printing.

To stop printing in progress, press the  **Stop/Clear** button. The printer will cancel all print jobs, stop printing, and eject any page or CD/DVD tray that was printing. Depending on the printer’s status, printing may not stop immediately.

Using the Paper Feed/Paper Eject function

1. Load several sheets of A4 size paper.
2. Press the  **Setup** button to open the Setup menu.
3. Press the  or  button to select **Paper Feed/Paper Eject**, then press the  button.
4. Press the **OK** button and follow the instructions on the LCD panel.

Repeat Steps 2 to 4 if needed.

Customer Support

Contacting Customer Support

If your Epson product is not operating properly and you cannot solve the problem using the troubleshooting information in your product documentation, contact customer support services for assistance. Check your Pan-European Warranty Document for information on how to contact EPSON Customer support. They will be able to help you much more quickly if you give them the following information:

- Product serial number
(The serial number label is usually on the back of the product.)
- Product model
- Product software version
(Click **About**, **Version Info**, or similar button in the product software.)
- Brand and model of your computer
- Your computer operating system name and version
- Names and versions of the software applications you normally use with your product

Technical Support Web Site

Go to <http://www.epson.com> and select the Support section of your local EPSON web site for the latest drivers, FAQs, manuals and other downloadables.

Epson's Technical Support Web Site provides help with problems that cannot be solved using the troubleshooting information in your printer documentation.

Options, Ink, and Paper

Options

Bluetooth Photo Print Adapter

The optional Bluetooth Photo Print Adapter is a wireless communication module used to print from digital still cameras, digital video cameras, PDAs, Mobile PCs, and other devices that support Bluetooth wireless technology without cables when connected to the printer.

Bluetooth unit C12C824***

Note:

The asterisk is a substitute for the last digit of the product number, which varies by location.

➔ See your online User's Guide for using the Bluetooth Photo Print Adapter.

Ink

Cartridge	Part number
Black	T0481
Cyan	T0482
Magenta	T0483
Yellow	T0484
Light Cyan	T0485
Light Magenta	T0486

Paper

Epson offers specially designed media for ink jet printers to meet most high-quality printing needs.

Paper name	Sizes	Part number
Epson Ultra Glossy Photo Paper	10 × 15 cm (4 × 6in.)	S041926 S041943
	13 × 18 cm (5 × 7in.)	S041944
	A4	S041927
Epson Premium Glossy Photo Paper	A4	S041285 S041297
	A5	S041706, S041729, S041730, S041750
Epson Premium Semigloss Photo Paper	A4	S041332
Epson Economy Photo Paper	A4	S041579

Paper name	Sizes	Part number
Epson Matte Paper-Heavyweight	A4	S041258, S041259
Epson Photo Stickers	A6	S041144
Epson Iron-On Cool Peel Transfer Paper	A4	S041154

Note:

- The availability of special media varies by location.
- For the latest information on media available in your area, contact the EPSON customer support web site.
 - ➔ See "Contacting Customer Support" on page 30

Printer Specifications

These specifications are only for standalone operation.

Printing

Printing method	On-demand ink jet
Nozzle configuration	Monochrome (black) 90 nozzles Color (cyan, magenta, yellow, light cyan, light magenta) 450 nozzles (90 × 5 colors)
Printable area	Border printing: 3-mm margin for all sides of paper Borderless printing: No margin

Paper

Note:

Since the quality of any particular brand or type of paper may be changed by the manufacturer at any time, Epson cannot attest to the quality of any non-EPSON brand or type of paper. Always test samples of paper stock before purchasing large quantities or printing large jobs.

Paper specifications

Single sheet:

Size	A4 (210 × 297 mm), 10 × 15 cm(4 × 6in.), 13 × 18 cm(5 × 7in.), A6
Paper types	Plain bond paper, special paper distributed by Epson
Thickness (for plain bond paper)	0.08 to 0.11 mm (0.003 to 0.004 inch.)
Weight (for plain bond paper)	64 g/m ² (17 lb) to 90 g/m ² (24 lb)

CD/DVD:

Size	12 cm
-------------	-------

Note:

- Poor quality paper may reduce print quality and cause paper jams or other problems. If you encounter problems, switch to a higher grade of paper.
- Do not load curled or folded paper.
- Use paper under normal conditions:
Temperature 15 to 25° C (59 to 77° F)
Humidity 40 to 60% RH

Ink Cartridge

Cartridge life	Within 6 months of opening the package, at 25°C [77°F]
Temperature	Storage: -20 to 40°C (-4 to 104°F) 1 month at 40°C (104°F)

Caution:

- Epson recommends the use of genuine Epson ink cartridges. Epson warranties do not cover damage to your printer caused by the use of ink cartridges not manufactured by Epson.
- Do not use an ink cartridge if the date on the package has expired.
- Do not refill the ink cartridge. The printer calculates the amount of ink remaining using an IC chip on the ink cartridge, so even if the cartridge is refilled, the IC chip will report that it is empty.

Printer

Sheet feeder capacity	About 100 sheets at 64 g/m ² (17 lb) paper
Dimensions	Storage Width: 483 mm (19.0 inches) Depth: 300 mm (11.8 inches) Height: 188 mm (7.4 inches)
	Printing Width: 483 mm (19.0 inches) Depth: 478 mm (18.8 inches) Height: 297 mm (11.7 inches)
Weight	6.1 kg (13.4 lb) without the ink cartridges

Electrical

	120 V Model	220-240 V Model
Input voltage range	99 to 132 V	198 to 264 V
Rated frequency range	50 to 60 Hz	

Input frequency range	49.5 to 60.5 Hz	
Rated current	0.4 A (Max.0.7 A)	0.2 A (Max.0.4 A)
Power consumption	Approx. 13 W (ISO 10561 Letter Pattern) Approx. 2.2 W in Sleep mode Approx. 0.2 W in Power Off mode	Approx. 13 W (ISO 10561 Letter Pattern) Approx. 2.3 W in Sleep mode Approx. 0.3 W in Power Off mode

Note:

Check the label on the back of the printer for the voltage of your printer.

Environmental

Temperature	Operation: 10 to 35°C (50 to 95°F)
Humidity	Operation: 20 to 80% RH

Compatible Memory Cards

See “Inserting a Memory Card” on page 9.

Note:

For the latest information on memory cards available for your printer, contact your dealer or regional Epson sales office.

Memory Card Data Format

You can use image files that meet the following requirements.

Digital camera	DCF (Design rule for Camera File system) Version 1.0 or 2.0 compliant.
File format	JPEG or TIFF format image files taken with a DCF compliant digital camera. Supports Exif Version 2.1/2.2/2.21
Image size	80 × 80 to 9200 × 9200 pixels
Number of files	Up to 999.

Note:

File names containing double-byte characters are not valid when printing directly from a memory card.

External Storage Devices

Connectivity	Universal Serial Bus* Bit rate: 12 Mbps (Full speed device) Connector type: USB Series A Recommended cable length: Less than 2 meters
---------------------	--

* Not all USB devices are supported. Contact your regional customer support for details.

Standards and Approvals

U.S. model:

Safety	UL 60950 CSA No.60950
EMC	FCC Part 15 Subpart B Class B CAN/CSA-CEI/IEC CISPR22 Class B

European model:

Low Voltage Directive 73/23/EEC	EN 60950
EMC Directive 89/336/EEC	EN 55022 Class B EN 61000-3-2 EN 61000-3-3 EN 55024

Australian model:

EMC	AS/NZS CISPR22 Class B
-----	------------------------

Summary of Panel Settings





Memory Card mode

On the first screen, you can select how to print or show data stored on a memory card.

	View and Print Photos: Select several photos, with one or more copies for each (page 11).
	Print All Photos: Print all the photos on your memory card (page 11).
	Print Range of Photos: Choose a sequence of photos on your memory card (page 12).
	Print by Date: Search photos by the date they are taken, and select the photos you want.
	Print Index Sheet: Print a thumbnail view of all the photos stored in your memory card. (page 12)
	Play Slide Show: View all photos on your memory card in sequence like a slide show (page 13).
	Camera-selected DPOF Photos: Print a set of photos that you pre-selected in your digital camera using DPOF. This option appears by default and is only available when photos have been selected with DPOF. (Refer to "Printing with DPOF Settings" on page 13.)

Specialty Print mode

On the first screen, you can select how to print or show data stored on a memory card.

	CD/DVD Print: Print on a 12-cm CD or DVD.
	P.I.F. Print: Print photos with picture frames.
	Photo Stickers: Print on EPSON Stickers.
	Iron on: Print on EPSON Iron-On Cool Peel Transfer Paper.

Print Settings

Paper Type	For details, see page 18.
Paper Size	For details, see page 18.
Layout	For details, see page 18.
Date Format	Print with captured date information. For details, see page 20.
Time Format	Print with captured time information. For details, see page 20.
Quality	Choose from High , Highest , or Normal .
Filter	Print in B&W or Sepia.
Auto Correct	For details, see "Automatically adjusting your photos" on page 20.
Brightness	For details, see "Manually adjusting your photos" on page 20.
Contrast	
Sharpness	
Saturation	
Print Info.	Print the exposure time/shutter speed, F number, and ISO speed rate information based on the Exif information of the image data. This setting is not cleared even after turning off the printer.
Small Image	Remove digital noise or interference from photos, and increase the resolution for small images so that they can be printed at larger sizes when set to On .
Fit to Frame	Enlarge or reduce the image to fit to the frame when set to On . The longer side that extends beyond the printable area is not printed.
Bidirectional	Activate bidirectional printing so your printer prints both left-to-right and right-to-left. Bidirectional printing speeds up printing, but decreases print quality.
Borderless Expansion	Adjust the amount of image that extends beyond the paper size during borderless printing.
Keep P.I.F. Frame with Photo	Print a photo with a frame you previously specified by EPSON digital camera.

Setup menu

Make the settings below if necessary by pressing the  Setup button.

Paper Feed/Paper Eject	Feeds or ejects paper.
Ink Levels	For details, see Checking the ink supply.
Ink Cartridge Replacement	For details, see "Replacing an ink cartridge" on page 23.
Nozzle check	For details, see "Cleaning the print head" on page 25.
Head Cleaning	For details, see "Cleaning the print head" on page 25.
Photo Viewer Adjustment	For details, see "Adjusting the LCD Brightness" on page 22.
Head Alignment	For details, see "Aligning the print head" on page 25.
Backup	For details, see "Saving your photos to an external device" on page 10.
PictBridge Setup	You can use this feature with digital cameras which support the USB DIRECT-PRINT or PictBridge functions.
Select Folder	Select a folder in the external storage device.
Photo Sticker Position Up/Down	Adjust the print position for Photo Stickers. For details, see "If the printing is misaligned" on page 17.
Photo Sticker Position Left/Right	
CD/DVD Position Inside	Adjust the inside or outside diameter to print on a CD or DVD. For details, see "Adjusting the printing area" on page 15.
CD/DVD Position Outside	
CD/DVD Position Up/Down	Adjusts the print position for CD/DVD. For details, see "If the printing is misaligned" on page 15.
CD/DVD Position Left/Right	
BT Printer ID Set	Settings are available when the optional Bluetooth Photo Print Adapter is connected to the printer. For more details, refer to the "Using the Bluetooth Photo Printer Adapter" in the online User's Guide.
BT Connectivity Mode	
BT Encryption	
BT PIN Code Set	
BT Device Address	

Thick Paper	If your printouts are rubbed during printing, set this to On to widen the distance between the paper and the print head. This setting is switched OFF when the printer is turned off.
Language	Select the language displayed on the LCD panel. This setting is not available in some areas.
Restore to Factory Settings	Reset to default settings. For details, see "Restoring to Default Settings" on page 22.
All File Clear	Delete all images on the memory card or the connected drive.
Screen Saver Settings	Set to Card Data to run the screen saver using the photos on the memory card.

Index

B

Brightness
 LCD panel, 22
 photo, 20

C

Camera
 Printing from, 10
CD/DVD
 available size, 32
 Printing, 14
 Printing a Jacket, 16
Cleaning
 printer, 26
 print head, 25
Contacting EPSON, 30
Contrast, 20
Cropping, 20
Customer support, 30

D

Date
 search photo, 12
 stamp, 20
Display Setting, 22

E

Epson
 paper, 31
Exif Print, 19 to 20
External devices
 connecting, 9
 saving files to, 10
 storage devices, 33

H

Head Cleaning utility, 25

I

Ink Cartridge
 part number, 31
 replacing, 23

K

Keep P.I.F. Frame with Photo, 13

L

Language setting, 35
Layout setting, 18

M

Maintaining printer, 25 to 26
Memory cards
 compatible, 9
 delete files, 35
 inserting, 9
 Moving printer, 26
 removing, 9, 10

N

Nozzle Check, 25

P

P.I.F. Frame
 Print with P.I.F. Frame, 16
 specified by camera, 13
PAD, 31
Paper
 purchasing, 31
 Specifications, 31
Paper jam, 28
Paper Setting, 18
Photo
 adjusting quality, 19
 cropping, 20
 sizing, 20
Photo Stickers
 part number, 31
 Printing, 16
PictBridge, 10, 35
Printer
 cleaning, 26
 maintaining, 25 to 26
 transporting, 26
Print head
 aligning, 25
 cleaning, 25
PRINT Image Matching
 printing photos with, 19

S

Saturation, 20
Screen Saver settings, 22
Sharpness, 20
Sizing photos, 20
Slideshow, 13
Stamp
 Date and Time, 20

T

Technical support, 30
Transporting printer, 26

U

USB Direct Print, 10, 35



MEMORY STICK PRO™



410318100