

# EPL-N2550 Paper Jam Guide



Warnings must be followed carefully to avoid bodily injury.

Notes contain information and useful tips on the operation of your printer.

When the LCD panel displays the Jam XXX error message, choose the appropriate description to clear the jammed paper.  
For more information, see the Online User's Guide.

## Jam MP A, Jam C1 A, Jam C2 A, Jam C3 A (All paper cassettes and Cover A)

1

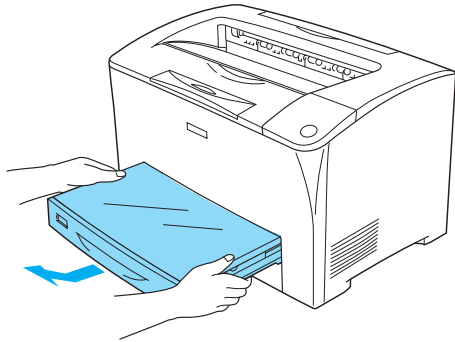

2

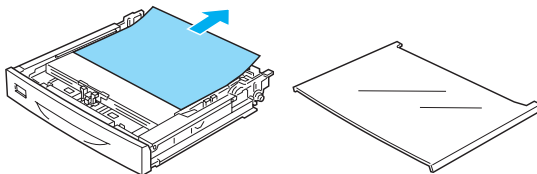

3

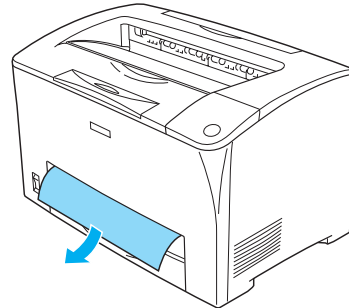

**Note:**

Confirm that the jammed paper is not still deep inside the printer.

4

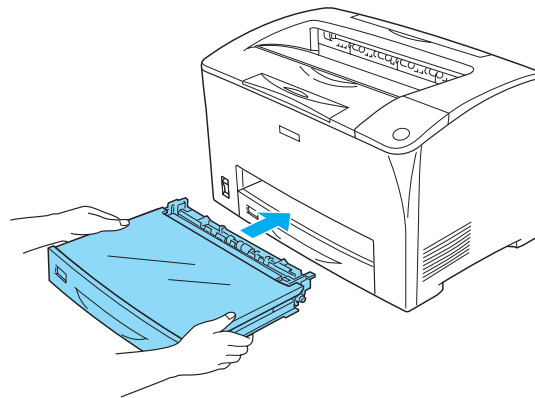

5

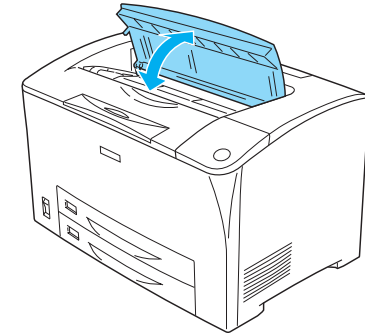

**Note:**

After opening and closing Cover A, the error message is cleared.

## Jam A (Cover A)



### Warning:

Unless specifically instructed in this guide, be careful not to touch the fuser, which is marked CAUTION HOT SURFACE and CAUTION HIGH TEMPERATURE, or the surrounding areas. If the printer has been in use, the fuser and the surrounding areas may be very hot. If you must touch one of these areas, wait 40 minutes to allow the heat to subside before doing so.

1

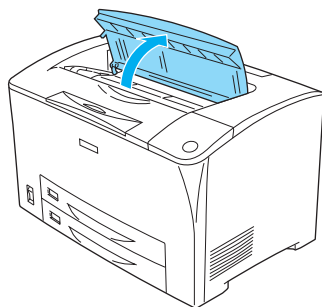

2

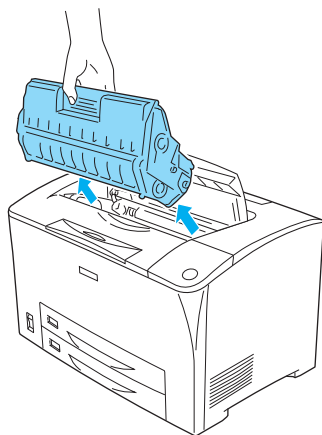

### Note:

Place the cartridge on a clean, flat surface.

3

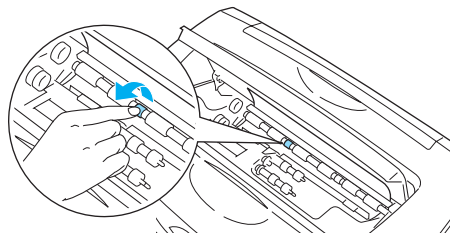

### Note:

Only touch the green part of the pickup roller. Touching any other parts may cause a paper jam.

4

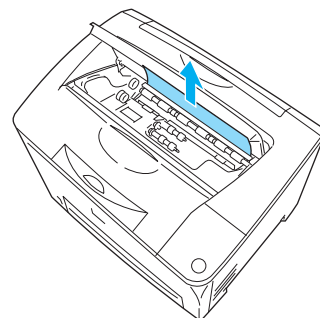

5

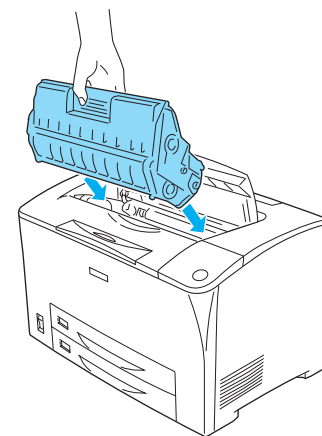

### Note:

Insert the cartridge with the arrow mark on the top of the imaging cartridge facing toward Cover A.

6

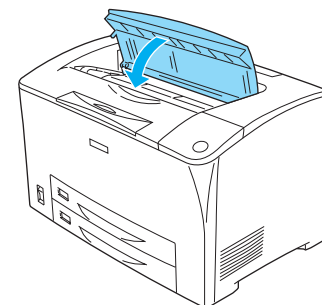

## Jam A B (Cover A or B)



### Warning:

Unless specifically instructed in this guide, be careful not to touch the fuser, which is marked CAUTION HOT SURFACE and CAUTION HIGH TEMPERATURE, or the surrounding areas. If the printer has been in use, the fuser and the surrounding areas may be very hot. If you must touch one of these areas, wait 40 minutes to allow the heat to subside before doing so.

1

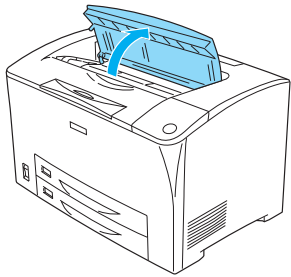

2

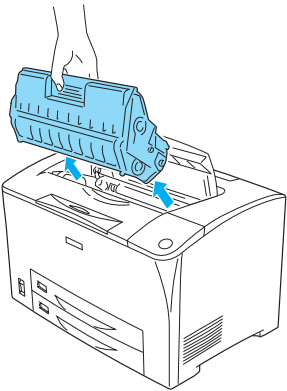

**Note:**  
Place the cartridge on a clean, flat surface.

3

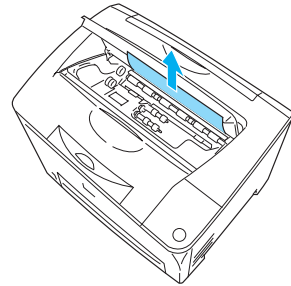

### Note:

When jammed paper cannot be removed easily, turn the roller to take tension off the paper, then pull it straight out.

4

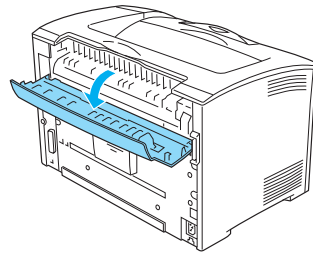

### Note:

When the optional Duplex Unit is installed, open the Duplex Unit's cover before opening Cover B.

5

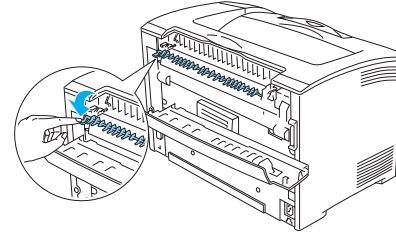

### Warning:

Be careful not to touch the rollers in the fuser unit, they may be very hot.

6

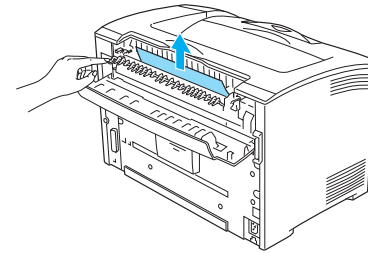

7

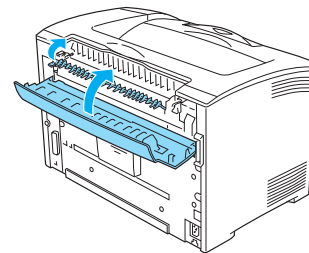

### Note:

If you installed the Duplex Unit, close the Duplex Unit's cover after closing Cover B.

8

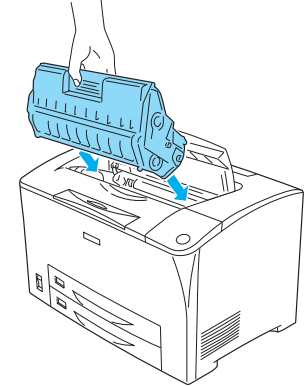

### Note:

Insert the cartridge with the arrow mark on the top of the imaging cartridge facing toward Cover A.

9

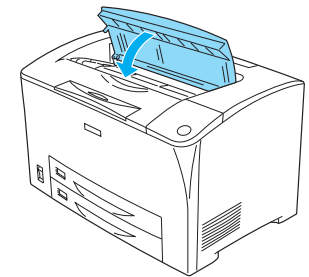

## Jam DM (Cover DM)

1

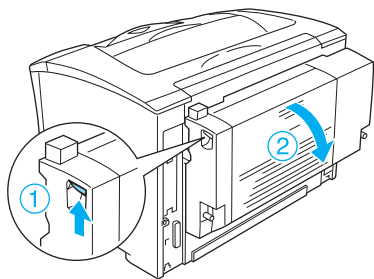

2

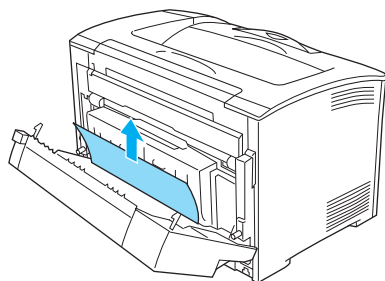

### Note:

- ❑ If paper is torn, be sure to remove all torn pieces.
- ❑ When you cannot remove jammed paper by this procedure, open Cover A or Cover B and remove the jammed paper as described in "Jam A B (Cover A or B)".

3

