

LX-300+II/LX-1170II

EN	Setup Guide
DE	Installationshandbuch
FR	Guide d'installation
IT	Guida di installazione
ES	Guía de instalación
CA	Manual d'instal·lació
PT	Manual de instalação
NL	Installatiehandleiding
DA	Installationsvejledning
FI	Asennusopas
NO	Installeringshåndbok
SV	Installationshandbok
CS	Instalační příručka
HU	Üzembe helyezési útmutató
PL	Podręcznik konfiguracji i instalacji
SK	Inštalčná príručka
BG	Ръководство за инсталация
RO	Ghid de instalare
EE	Seadistusjuhend
LV	Uzstādīšanas instrukcija
LT	Parengties vadovas
EL	Οδηγός εγκατάστασης
TR	Kurulum kılavuzu
SL	Priročnik za namestitev
HR	Vodič za postavu
MK	Упатство за поставување
SR	Uputstvo za postavljanje
RU	Руководство по установке
AR	
FA	

دليل الإعداد
راهنمای تنظیم

LX-300+II

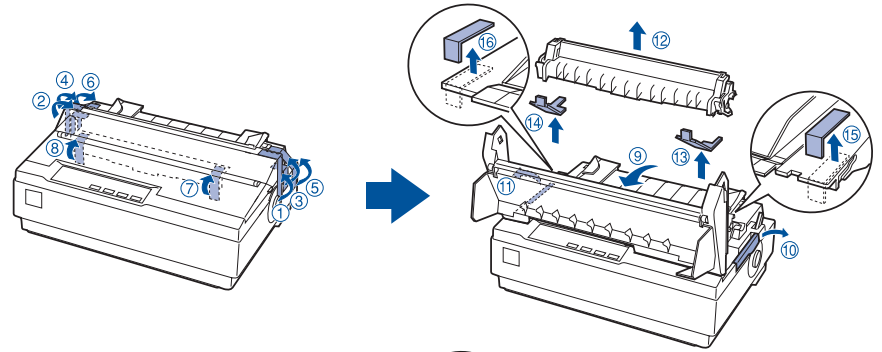

LX-1170II

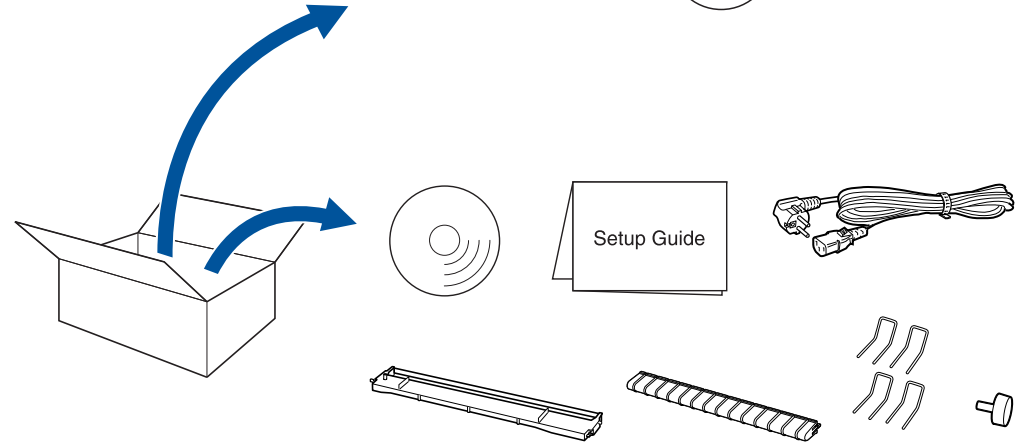
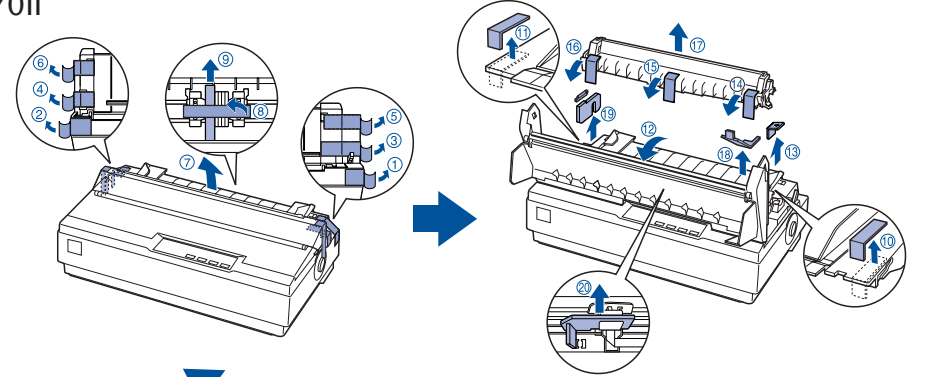

DE: Maschinenlärminformations-Verordnung 3. GPSGV: Der höchste Schalldruckpegel beträgt 70 dB(A) oder weniger gemäss EN ISO 7779.



EN
DE
FR
IT
ES
CA
PT
NL
DA
FI
NO
SV
CS
HU
PL
SK
BG
RO
EE
LV
LT
EL
TR
SL
HR
MK
SR
RU
AR
FA

For detailed information and safety recommendations, refer to the User's Guide (installed with the software).

Ausführliche Informationen und Sicherheitsempfehlungen finden Sie im Benutzerhandbuch, das mit der Software installiert wurde.

Pour plus d'informations et des recommandations concernant la sécurité, reportez-vous au Guide de l'utilisateur (installé avec le logiciel).

Per informazioni dettagliate e suggerimenti sulla sicurezza consultare la Guida per l'utente installata con il software.

Para obtener información detallada y recomendaciones sobre seguridad consulte la Guía de usuario (instalada con el software).

Per obtenir informació detallada consulti el Manual d'usuari (instal·lada amb el software).

Para mais informações e recomendações sobre segurança, consulte o Manual do Utilizador (instalado com o software).

Raadpleeg de gebruikershandleiding (geïnstalleerd met de software) voor meer informatie en veiligheidsvoorschriften.

Der findes yderligere oplysninger og anbefalinger om sikkerhed i brugervejledningen (installeres sammen med softwaren).

Lisätietoja ja turvaohjeita on Käyttöoppaassa (asennetaan ohjelmiston kanssa).

Hvis du vil ha mer detaljert informasjon og sikkerhetsanbefalinger, kan du se i brukerveiledningen (som installeres med programvaren).

Detaljerad information och säkerhetsföreskrifter finns i Användarhandboken (installeras tillsammans med programmet).

Podrobné informácie a bezpečnostní doporučení najdete v Uživatelské příručce (instaluje se společně se softwarem).

Részletes információk és a biztonsággal kapcsolatos tudnivalók a szoftverrel együtt telepített használati útmutatóban találhatóak.

Szczegółowe informacje oraz zalecenia dotyczące bezpieczeństwa zawiera Podręcznik użytkownika (instalowany razem z oprogramowaniem).

Podrobné informácie a bezpečnostné odporúčanie nájdete v Uživatelskej príručke (inštaluje sa spolu so softvérom).

Подробна информация и препоръки за безопасност ще намерите в Ръководството за потребителя (инсталирано със софтуера).

Pentru informații detaliate și recomandări cu privire la siguranță, consultați User's Guide (Ghidul utilizatorului instalat cu software-ul).

Lähemat teavet ja ohutusalaheid soovitusi vt (koos tarkvaraga installeeritud) kasutusjuhendist User's Guide.

Sīkāku informāciju un ieteikumus par drošību skat. Lietotāja rokasgrāmātā (tiek instalēta kopā ar programmu).

Detalesnės informacijos ir saugos patarimų ieškokite vartotojo vadove (įdiegtame kartu su programine įranga).

Για περισσότερες πληροφορίες και συστάσεις για την ασφάλεια, ανατρέξτε στον Οδηγό χρήσης (εγκαταστάθηκε μαζί με το λογισμικό).

Ayrıntılı bilgi ve güvenlik önerileri için lütfen (yazılımla yüklenmiş olan) Kullanım Kılavuzu'na bakın.

Podrobnejše informacije in varnostna priporočila najdete v uporabniškem priročniku (namesti se skupaj s programsko opremo).

Detaljne informacije i preporuke o sigurnosti pogledajte u Korisničkom priručniku (instaliranom sa softverom).

За подетални информации и препораки за безбедноста видете во „Корисничкиот прирачник“ (што се инсталира заедно со софтверот).

Za detaljne informacije i mere bezbednosti pogledajte Korisničko uputstvo (instalirano zajedno sa softverom).

Для получения подробных сведений и рекомендаций по безопасности см. Руководство пользователя (поставляется вместе с программным обеспечением).

للحصول على معلومات مفصلة وتوصيات الأمان، ارجع إلى User's Guide (دليل المستخدم) (المثبت مع البرنامج).

برای اطلاعات مشروح به راهنمای مراجعه (با نرم افزار نصب شده) رجوع شود.

1

1

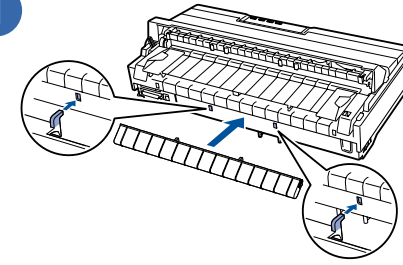

2

3

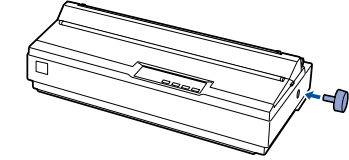
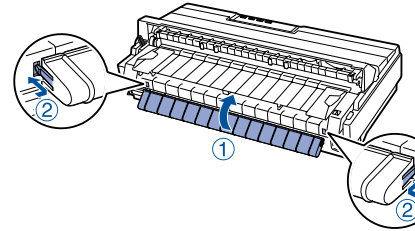

4

5

6

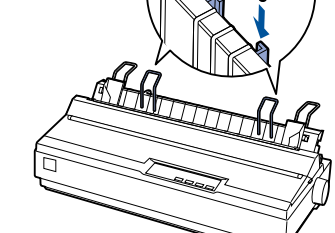
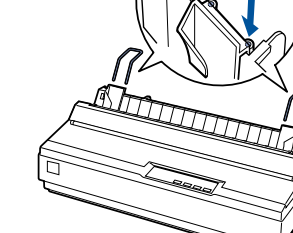
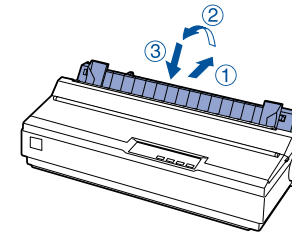

2

1

2

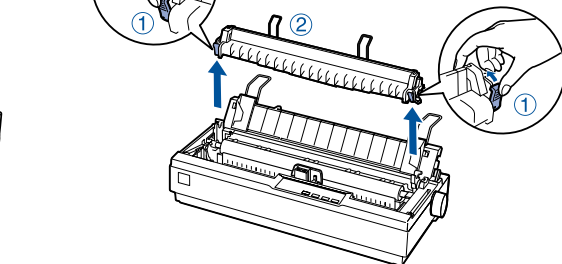
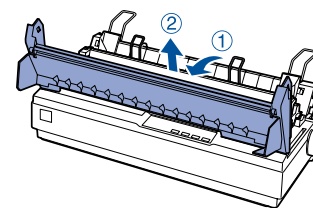

3

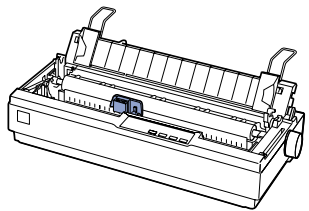

4

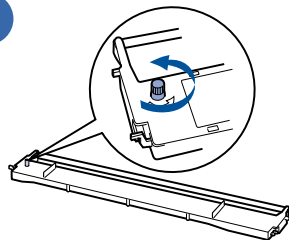

5

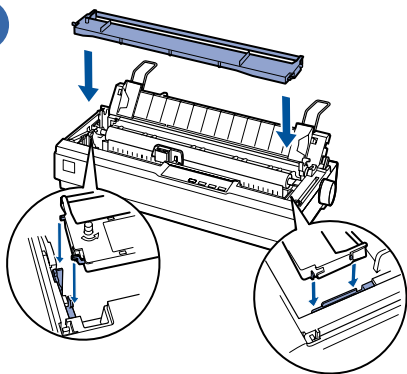

6

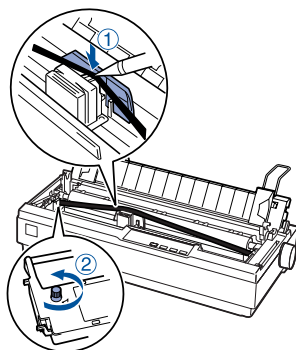

7

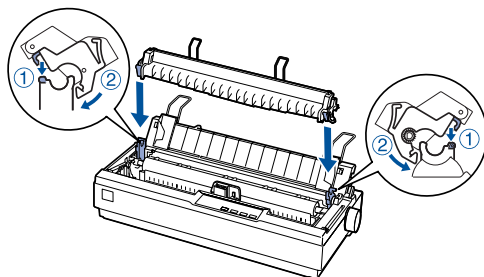

8

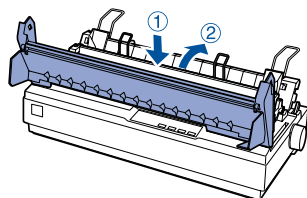

4

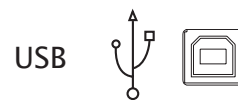

1

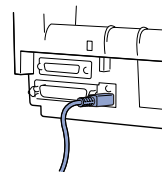

2

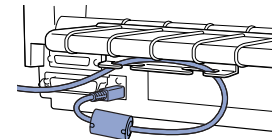

3

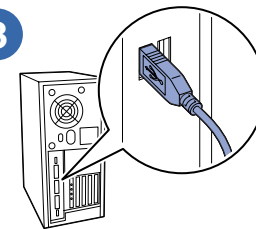

IEEE1284

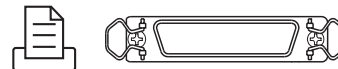

1

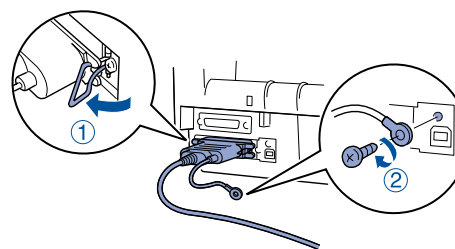

2

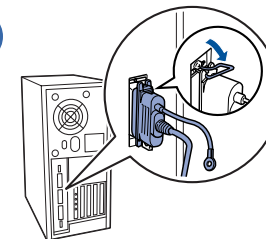

RS-232C



1

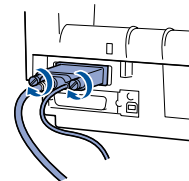

2

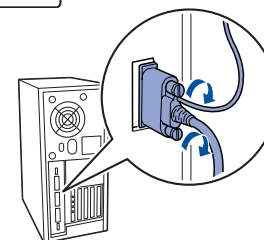

3

1

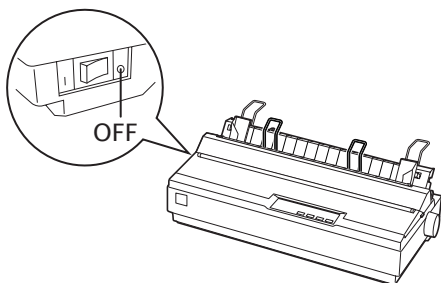

2

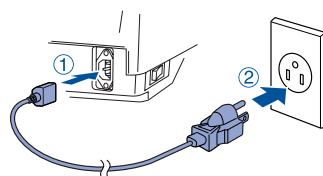

5

DOS



- Ⓞ LX-300+II
- Ⓞ LX-300+
- Ⓞ LX-300
- Ⓞ LX-810/850
- Ⓞ LX-800/860
- Ⓞ FX-850
- Ⓞ FX-860/800
- Ⓞ JX-80
- Ⓞ EX-800
- Ⓞ Any FX Printer
- Ⓞ EPSON Printer
- Ⓞ Draft Printer

- Ⓞ LX-1170II
- Ⓞ LX-1170
- Ⓞ FX-1180
- Ⓞ FX-1050
- Ⓞ FX-1000
- Ⓞ FX-105
- Ⓞ FX-100+
- Ⓞ FX-100
- Ⓞ Any FX Printer
- Ⓞ EPSON Printer
- Ⓞ Draft Printer

Windows

1 Turn the printer power switch to OFF.

2 Open the front cover of the printer.

3 Run the CD Installer. Click **Start Easy Install**.

4 Run the EPSON Printer Utilities Setup. Click **Retry** if the printer is not connected properly.

5 Turn the printer power switch to ON.

4 Remove the top cover of the printer.

5 Remove the top cover of the printer.

6 Remove the top cover of the printer.

7 Remove the top cover of the printer.

8 Remove the top cover of the printer.

9 Remove the top cover of the printer.

6 Insert a sheet of paper into the printer.

1 Load the paper into the paper tray.

2 Load the paper into the paper tray.

1 Turn the printer power switch to OFF.

2 Remove the top cover of the printer.

3 Remove the top cover of the printer.

For more information, visit <http://www.epson.com>.

No part of this publication may be reproduced, stored in a retrieval system, or transmitted in any form or by any means, electronic, mechanical, photocopying, recording, or otherwise, without the prior written permission of Seiko Epson Corporation. No patent liability is assumed with respect to use of the information contained herein. Neither is any liability assumed for damages resulting from the use of the information contained herein. Neither Seiko Epson Corporation nor its affiliates shall be liable to the purchaser of this product or third parties for damages, losses, costs, or expenses incurred by the purchaser or third parties as a result of: accident, misuse, or abuse of this product or unauthorized modifications, repairs, or alterations to this product, or (excluding the U.S.) failure to strictly comply with Seiko Epson Corporation's operating and maintenance instructions. Seiko Epson Corporation and its affiliates shall not be liable against any damages or problems arising from the use of any options or any consumable products other than those designated as Original Epson Products or Epson Approved Products by Seiko Epson Corporation. EPSON is a registered trademark of Seiko Epson Corporation. Microsoft®, Windows®, and Windows NT® are registered trademarks of Microsoft Corporation in the United States and/or other countries.

General Notice: Other product names used herein are for identification purposes only and may be trademarks of their respective owners. Epson disclaims any and all rights in those marks.