

EPSON

dreamio™

Home Projector

EMP-TW700

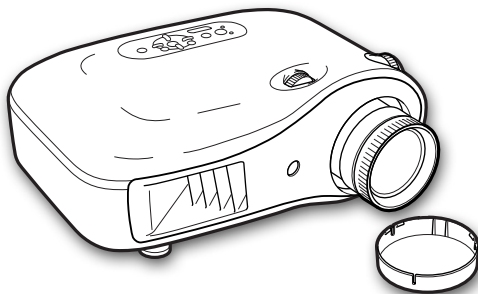

EN Quick Start Guide

DE Kurzanleitung

FR Guide de démarrage rapide

IT Guida di avvio rapido

ES Guía de inicio rápido

PT Guia de Referência Rápida

NL Introductiehandleiding

DA Introduktion

FI Pika-aloitusopas

NO Hurtigveiledning

SV Snabbstartsguide

CS Úvodní příručka

HU Bevezetés

PL Przewodnik szybkiego startu

SK Stručná príručka

BG Ръководство за бърз старт

RO Ghid de pornire rapidă

EE Lühijuhend

LV Ātrās darba uzsākšanas pamācība

LT Trumpas pradžios vadovas

EL Οδηγός γρήγορης εκκίνησης

TR Hızlı Başlangıç Kılavuzu

SL Priročnik za hitri zagon

HR Kratke upute

MK Прирачник брз почеток

SR Uputstvo za brz početak

RU Руководство по быстрой установке

AR دليل البداية السريعة

FA راهنمای سریع برای شروع بکار

EN	For detailed information, refer to the User's Guide.
DE	Ausführliche Informationen finden Sie im Benutzerhandbuch.
FR	Pour plus d'informations, reportez-vous au guide utilisateur.
IT	Per informazioni dettagliate, consultare la guida per l'utente.
ES	Para obtener información detallada, consulte la guía del usuario.
PT	Para mais informações, consulte o Manual do Utilizador.
NL	Raadpleeg de gebruikershandleiding voor uitgebreide informatie.
DA	Se brugervejledningerne for at få yderligere oplysninger.
FI	Lisätietoja on käyttöoppaassa.
NO	Hvis du vil ha mer detaljert informasjon, kan du se brukerhåndboken.
SV	Detaljerad information finns i användarhandboken.
CS	Podrobné informace naleznete v Uživatelské příručce.
HU	Részletes ismertetés a Használati útmutatóban található.
PL	Szczegółowe informacje zawiera Przewodnik użytkownika.
SK	Podrobné informácie nájdete v Príručke používateľa.

BG	За подробна информация направете справка с Ръководството за потребителя.
RO	Pentru informații detaliate, consultați User's Guide (Ghidul utilizatorului).
EE	Täpsemat teavet vt kasutusjuhendist.
LV	Sīkāka informāciju skatīt lietošanas instrukcijā.
LT	Detalios informacijos ieškokite Vartotojo vadove.
EL	Για περισσότερες πληροφορίες, δείτε τον Οδηγό χρήσης.
TR	Ayrıntılı bilgi için Kullanım Kılavuzuna başvurun.
SL	Podrobnejše informacije lahko najdete v navodilih za uporabo.
HR	Detaljnije informacije, potražite u vodiču za korisnike.
MK	За подетални информации видете во Упатството за чпотреба.
SR	Za detaljnije informacije pogledajte Korisničko uputstvo.
RU	Для получения дополнительной информации см. Руководство пользователя.
AR	للحصول على المعلومات التفصيلية، ارجع إلى "دليل المستخدم".
FA	برای اطلاعات مشروح به راهنمای کاربر رجوع شود.

EN	Content of the box
DE	Packungsinhalt
FR	Contenu de la boîte
IT	Contenuto della confezione
ES	Contenido del paquete
PT	Conteúdo da embalagem
NL	Inhoud van de doos
DA	Æskens indhold
FI	Laatikon sisältö
NO	Innholdet i esken
SV	Innehåll i lådan
CS	Obsah balení
HU	A doboz tartalma
PL	Zawartość opakowania
SK	Obsah balenia

BG	Съдржание на кутията
RO	Conținutul cutiei
EE	Kasti sisu
LV	Komplektācija
LT	Dėžės turinys
EL	Περιεχόμενα της συσκευασίας
TR	Kutunun içeriği
SL	Vsebina paketa
HR	Sadržaj paketa
MK	Содржина на кутијата
SR	Sadržaj kutije
RU	Содержимое упаковки
AR	محتوى الصندوق
FA	محتویات جعبه

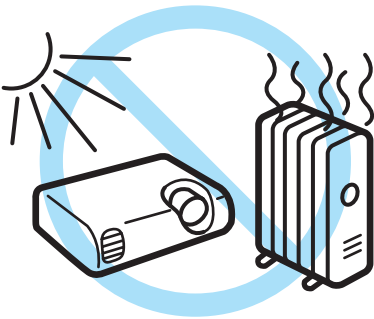
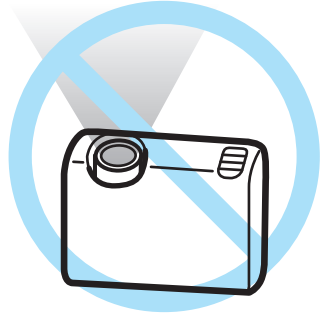
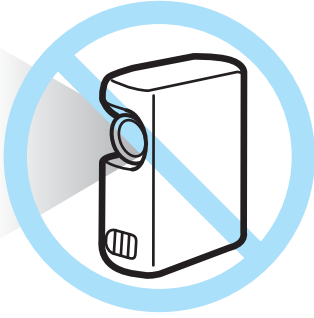

16 : 9

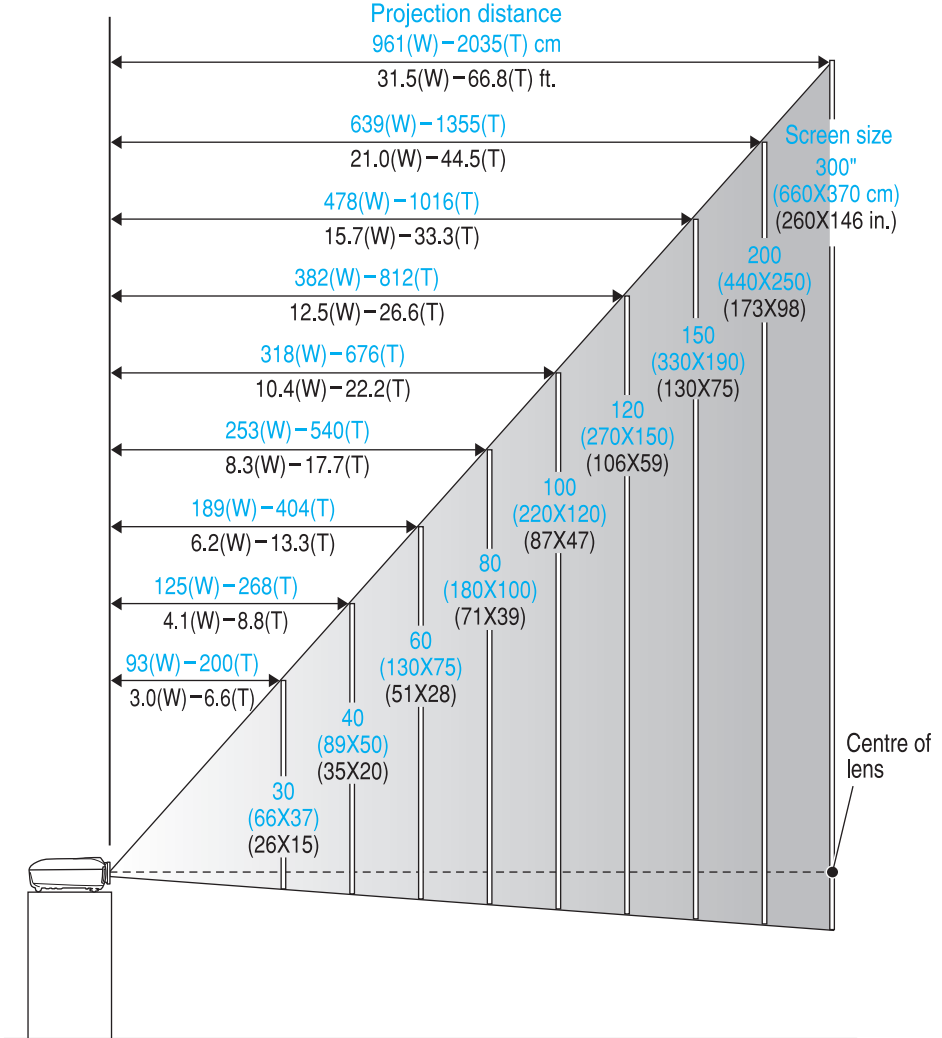

4 : 3

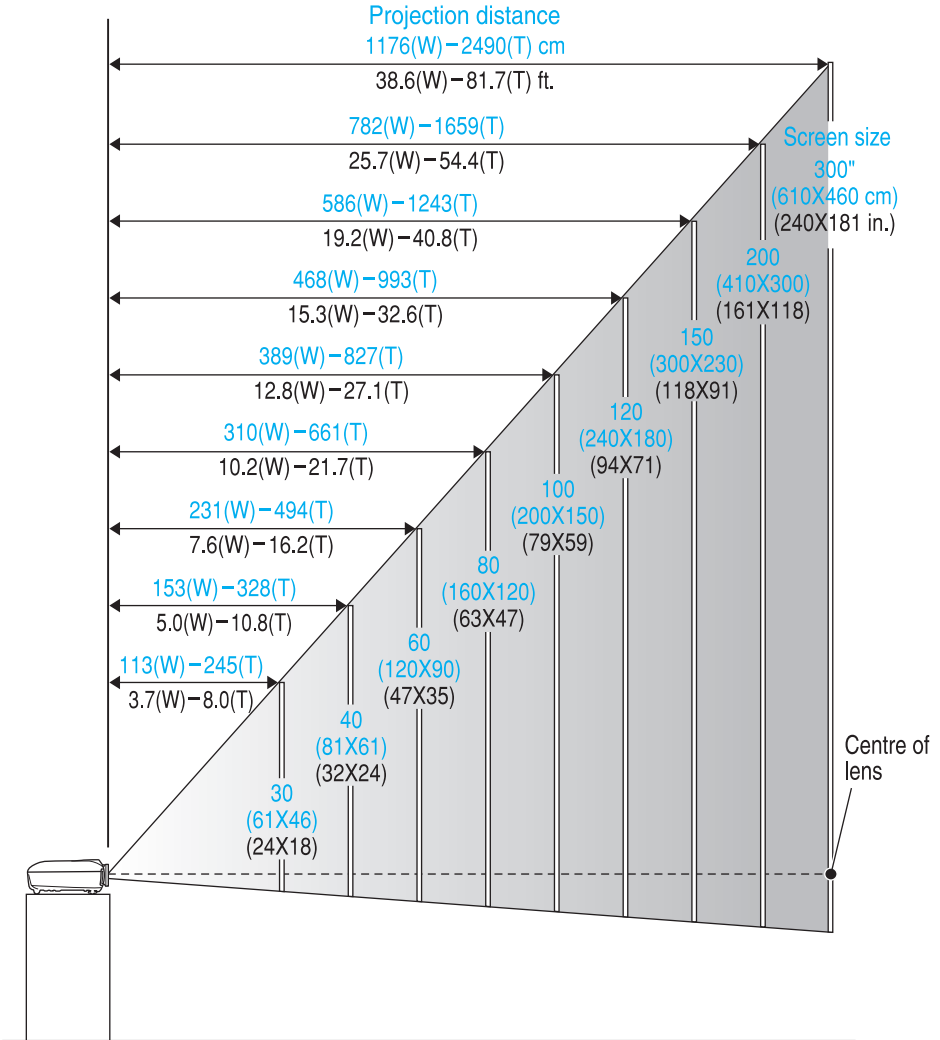

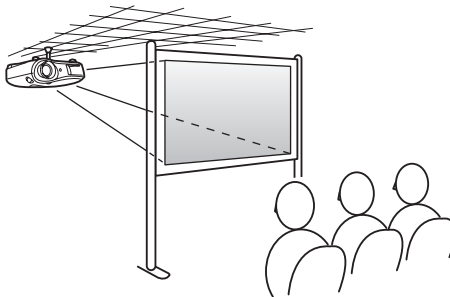
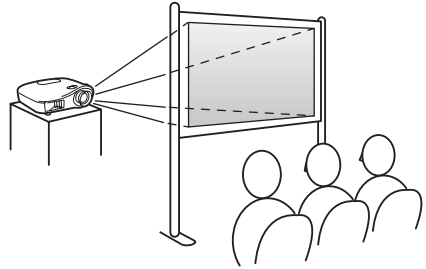
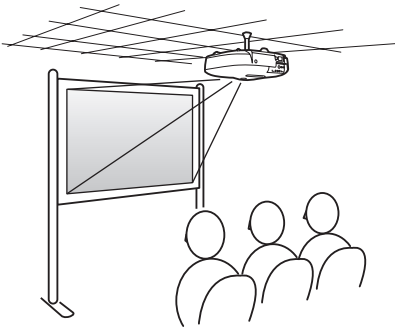
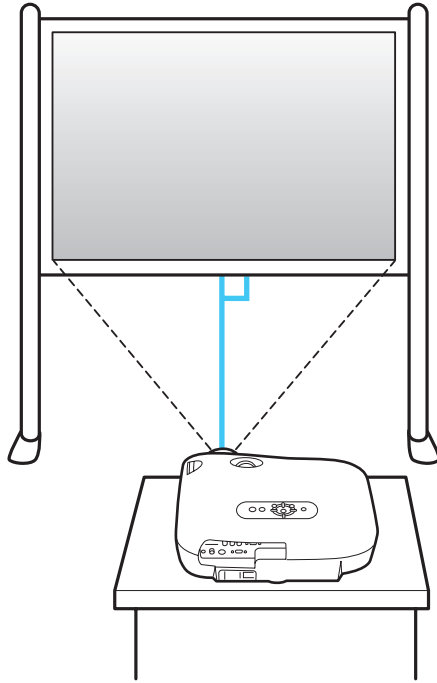

2

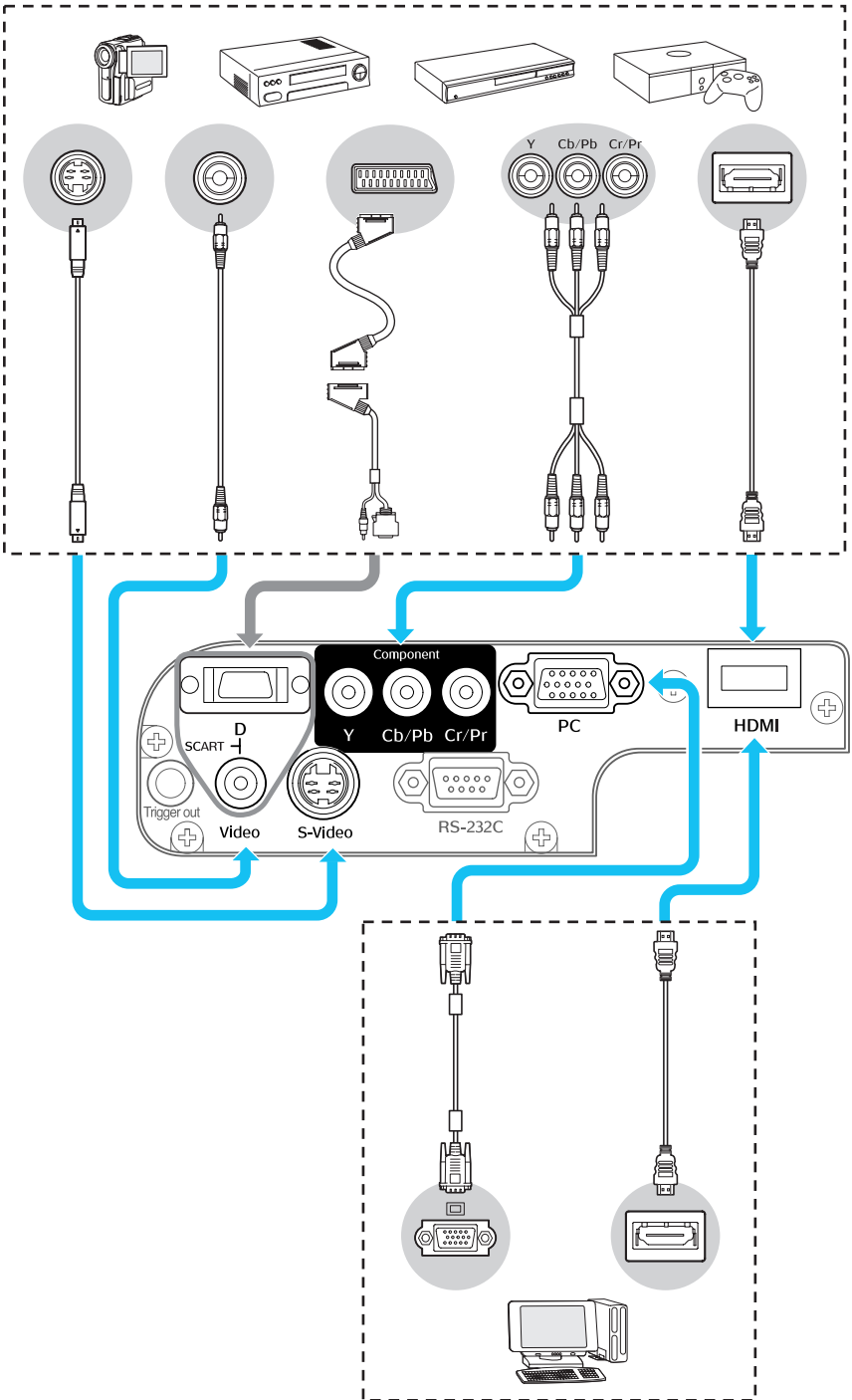

3

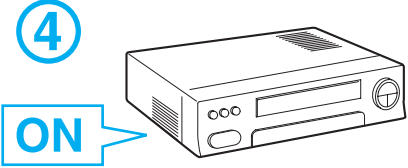
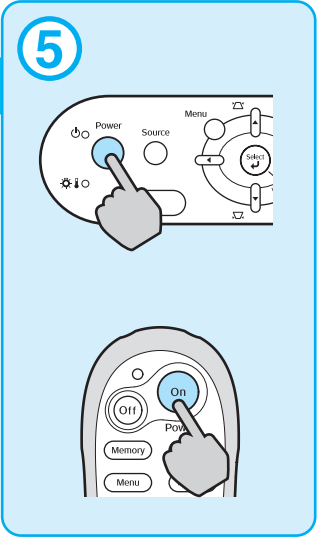
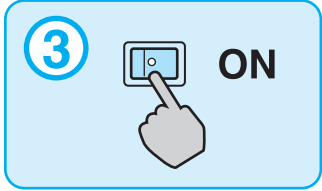
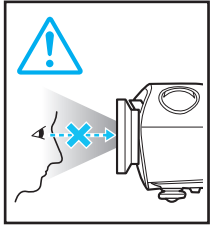
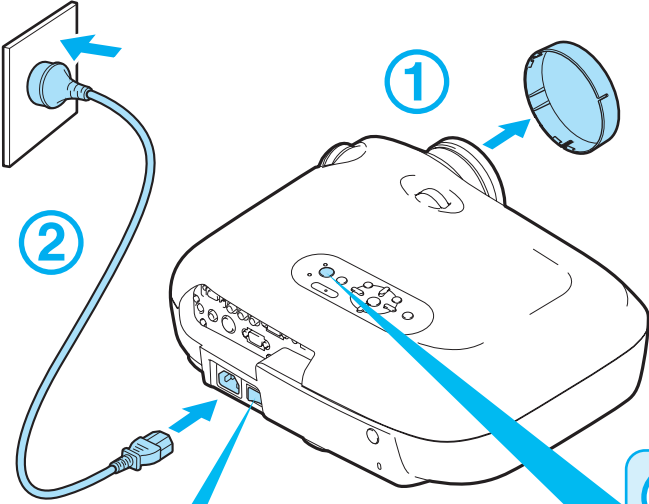

4

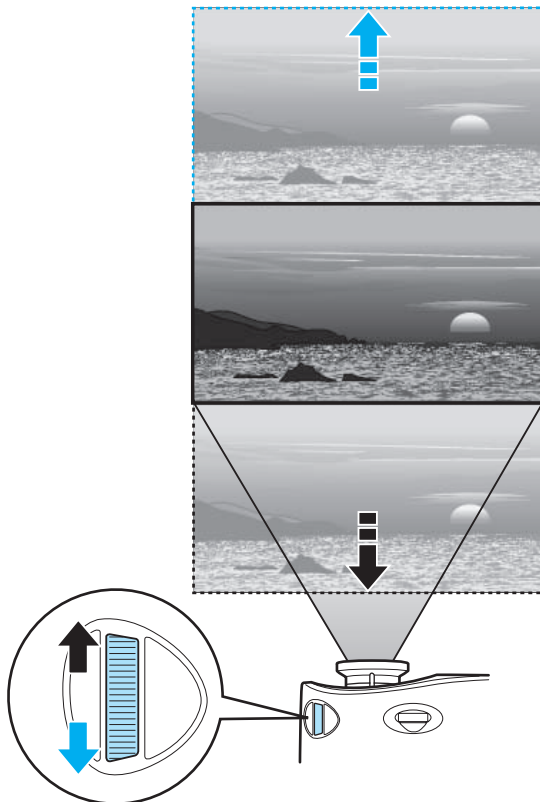
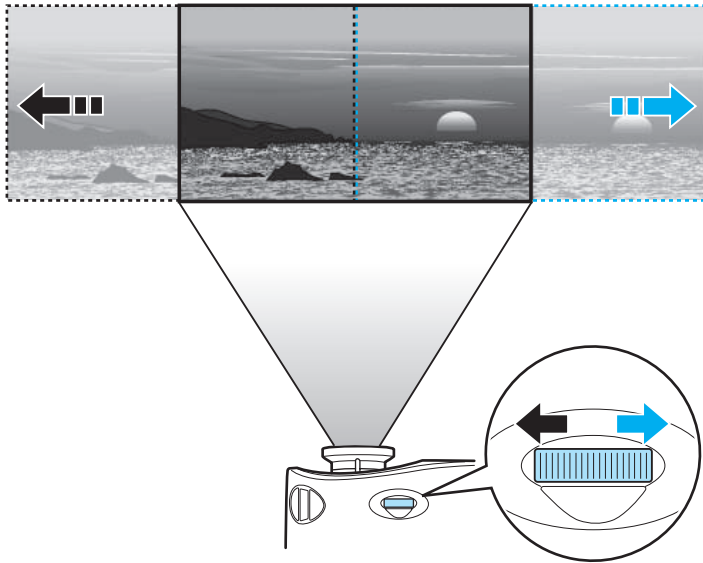

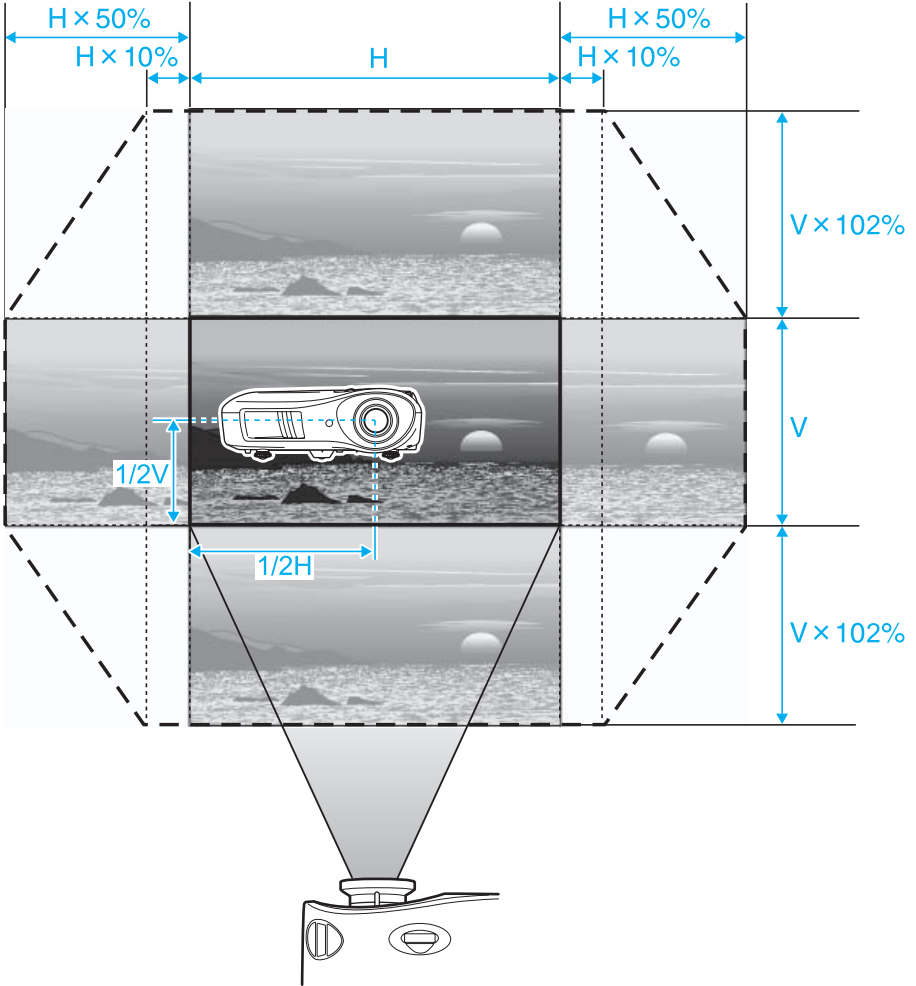

5

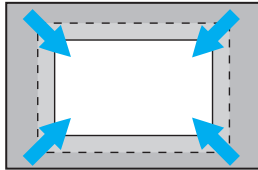
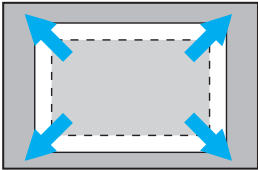
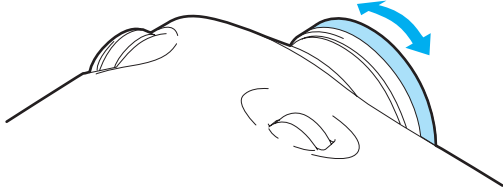
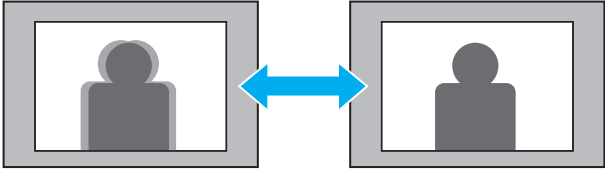

6

1

OFF



2

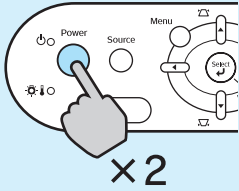

x2

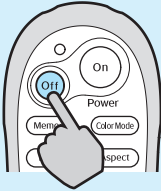

4

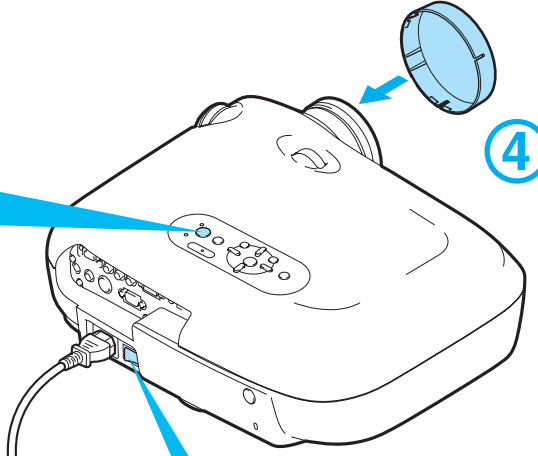
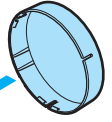

3



30 Sec.

