

EPSON STYLUS™ CX4080 Series

Start Here • Démarrez ici • Hier starten • Hier beginnen



Printed in XXXXXX XX.XX-XX XXX



1.

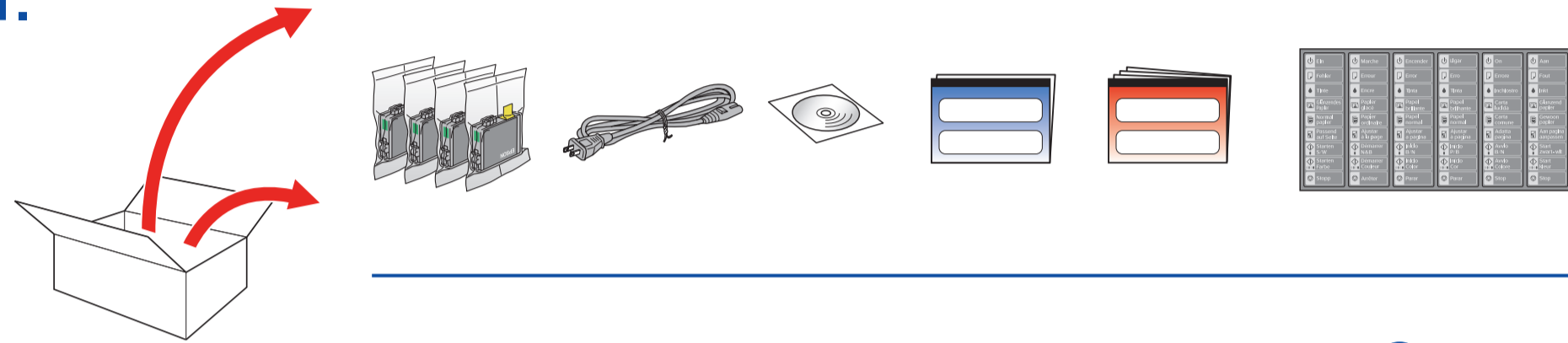

1

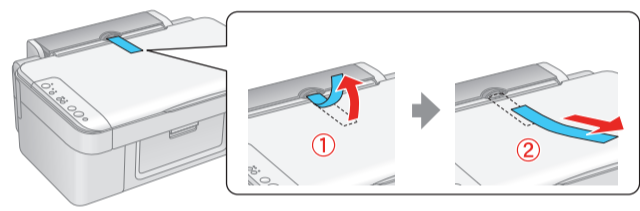

2

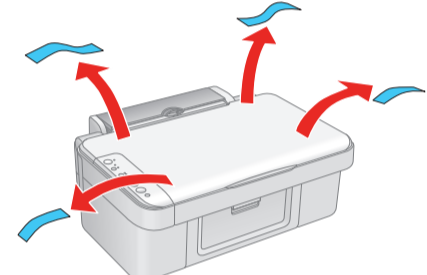

3

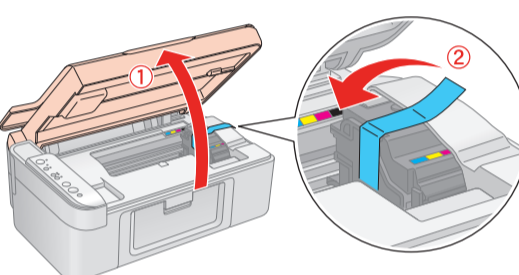

4

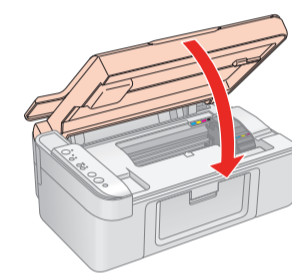

2.

1

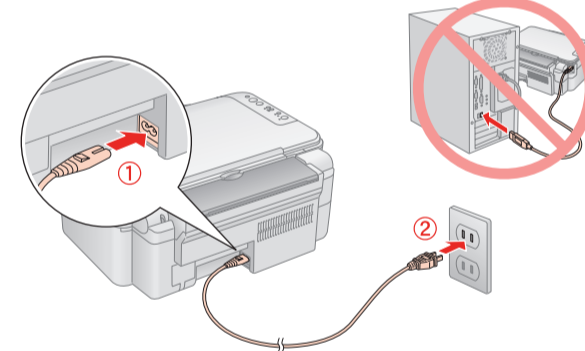

2

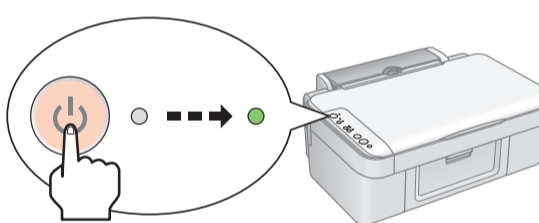

3.

1

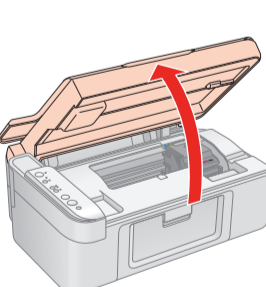

2

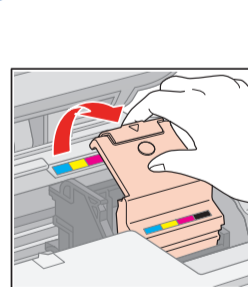

3

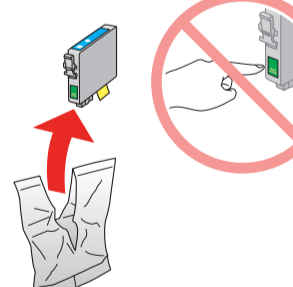

4

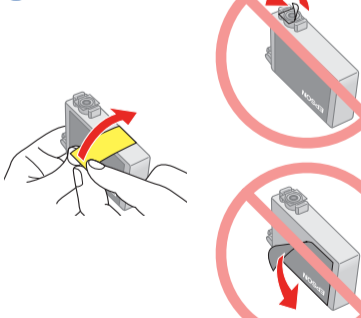

5

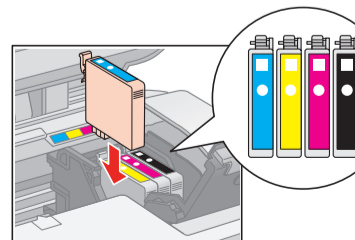

6

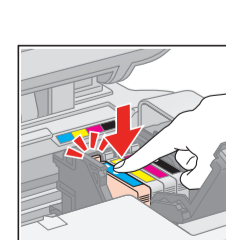

7

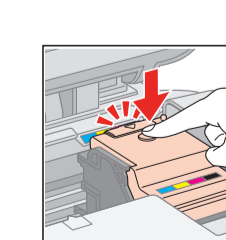

8

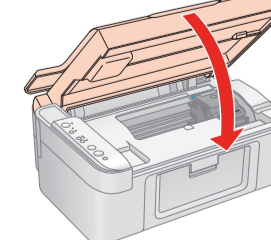

9

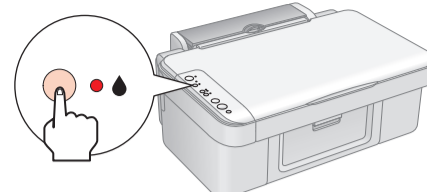

10

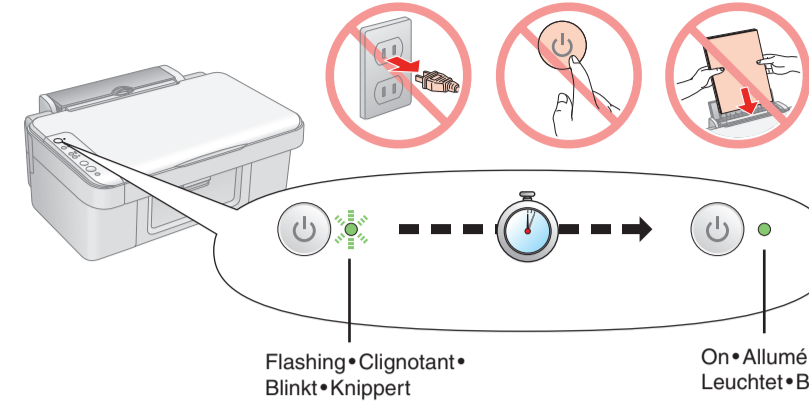

Wait about 1.5 min
Attendez environ 1,5 minute
Warten Sie ca. 1,5 Min.
Circa 1,5 min. wachten

Flashing • Clignotant • Blinkt • Knippert

On • Allumé • Leuchtet • Brandt

Note: The ink cartridges first installed in your Epson Stylus will be partly used to charge the print head. Subsequent ink cartridges will last for their full rated life.
Remarque : les premières cartouches d'encre installées dans le combiné multifonction Epson Stylus sont partiellement utilisées pour charger la tête d'impression. Les cartouches d'encre installées par la suite sont entièrement utilisées pour l'impression.
Hinweis: Die zuerst in den Epson Stylus eingesetzten Tintenpatronen werden zum Teil zum Befüllen des Druckkopfs genutzt. Anschließend eingesetzte Tintenpatronen halten über die gesamte angegebene Nutzungsdauer.
Opmerking: De eerste cartridges die u in de Epson Stylus installeert, worden deels verbruikt om de printkop te vullen met inkt. De daaropvolgende cartridges hebben wel de volledige levensduur.

4.

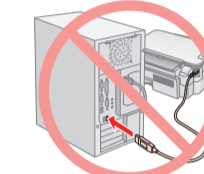

Do not connect the USB cable until you are instructed to do so.
Ne connectez pas le câble USB avant que les instructions ne vous l'indiquent.
Schließen Sie das USB-Kabel erst an, wenn Sie dazu aufgefordert werden.
Sluit de USB-kabel pas aan wanneer u daartoe opdracht krijgt.

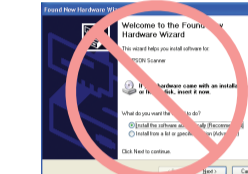

If this screen appears, click **Cancel**.
Si cet écran apparaît, cliquez sur **Annuler (Cancel)**.
Wenn dieses Fenster angezeigt wird, klicken Sie auf **Cancel (Abbrechen)**.
Klik op **Cancel (Annuleren)** als dit venster verschijnt.

1

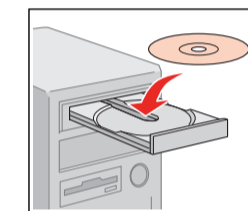

2

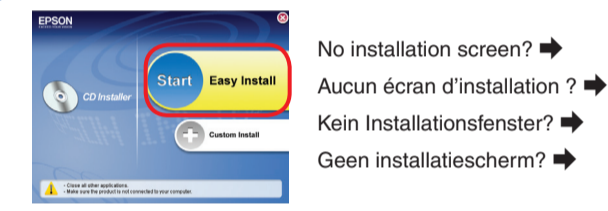

No installation screen? →
Aucun écran d'installation? →
Kein Installationsfenster? →
Geen installatiescherm? →

3

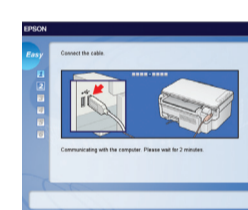

4

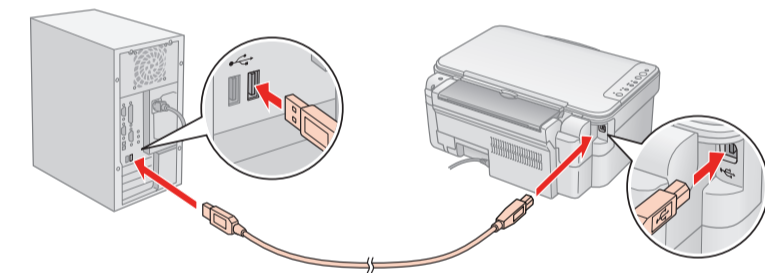

5



1

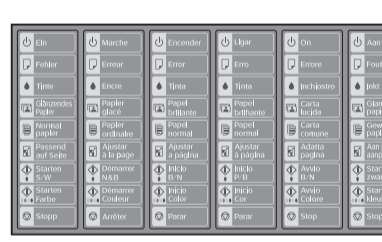

2

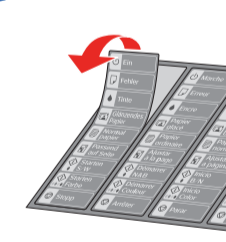

3

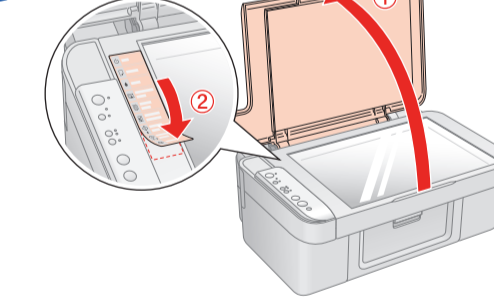

Getting More Information • Pour obtenir plus d'informations • Weitere Informationen erhalten • Meer informatie

