

EPSON® **PhotoPC** 600

COLOR DIGITAL CAMERA

On-line User's Guide



▶ ▶ [Point & Click here for tips on using this On-line Guide](#)

[Important Notice & Declaration of Conformity](#)

[Contents](#)

[Introduction](#)

[Getting Started](#)

[Taking Pictures with PhotoPC 600](#)

[Using PhotoPC 600 with Your Computer](#)

[Using the LCD Monitor Menus](#)

[Using the Uploader Utilities](#)

[Camera Options](#)

[Maintenance and Troubleshooting](#)

[Using the Direct Print Kit](#)

[Specifications](#)

[Contacting Customer Support](#)

[Glossary](#)

[Index](#)

IMPORTANT NOTICE

All rights reserved. No part of this publication may be reproduced, stored in a retrieval system, or transmitted in any form or by any means, electronic, mechanical, photocopying, recording, or otherwise, without the prior written permission of SEIKO EPSON CORPORATION. No patent liability is assumed with respect to the use of the information contained herein. Neither is any liability assumed for damages resulting from the use of the information contained herein.

Neither SEIKO EPSON CORPORATION nor its affiliates shall be liable to the purchaser of this product or third parties for damages, losses, costs, or expenses incurred by the purchaser or third parties as a result of: accident, misuse, or abuse of this product or unauthorized modifications, repairs, or alterations to this product, or (excluding the U.S.) failure to strictly comply with SEIKO EPSON CORPORATION's operating and maintenance instructions.

SEIKO EPSON CORPORATION shall not be liable against any damages or problems arising from the use of any options or any consumable products other than those designated as Original EPSON Products or EPSON Approved Products by SEIKO EPSON CORPORATION.

EPSON is a registered trademark of SEIKO EPSON CORPORATION. PhotoPC is a trademark of SEIKO EPSON CORPORATION. Macintosh is a registered trademark of Apple Computer, Inc. Microsoft and Windows are registered trademarks of Microsoft Corporation.

CompactFlash™ is a trademark of SanDisk Corporation.

General Notice: *Other product names used herein are for identification purposes only and may be trademarks of their respective owners. EPSON disclaims any and all rights in those marks.*

Copyright©1997 by SEIKO EPSON CORPORATION, Nagano, Japan.

Declaration of Conformity

According to ISO/IEC Guide 22 and EN 45014

Manufacturer: SEIKO EPSON CORPORATION
Address: 3-5, Owa 3-chome, Suwa-shi, Nagano-ken 392 Japan
Representative: EPSON EUROPE B.V.
Address: Prof. J. H. Bavincklaan 5 1183 AT Amstelveen
The Netherlands

Declares that the Product:

Product Name: Digital Still Camera
Type Name: EPSON PhotoPC 600
Model: G660A

Conforms to the following Directive(s) and Norm(s):

Directive 89/336/EEC:
EN 55022 Class B
EN 50082-1
IEC 801-2
IEC 801-3
IEC 801-4
EN 61000-3-2 (Using AC Adapter Model EU-20)
EN 61000-3-3 (Using AC Adapter Model EU-20)

July, 1997

Y. Ishii
President of EPSON EUROPE B. V .

A NOTE CONCERNING RESPONSIBLE USE OF COPYRIGHTED MATERIALS

Like photocopiers, digital cameras can be misused by improper photographing of copyrighted material. Unless you have the advice of a knowledgeable attorney, be responsible and respectful by not photographing published material without the permission of the copyright holder.



Contents

Introduction

PhotoPC 600 Features	7
Options	8
For United Kingdom users - use of options	8
System Requirements	8
PCs	8
Macintosh Computers	9
Safety Instructions	9
Warnings, Cautions, and Notes	11

Chapter 1 Getting Started

Unpacking Your PhotoPC 600	12
Getting to Know the Camera	13
Installing Batteries	15
Handling batteries	16
Attaching the Hand Strap	17
Installing EPSON Photo!2 Software	17
Installing the software in your Macintosh	18
Installing EPSON Photo File Uploader	18
Installing the software in your PC	19
Installing the software in your Macintosh	19
Setting the Language	20
Setting the Date and Time	20

Chapter 2 Taking Pictures with PhotoPC 600

Turning the Camera On and Off	22
Auto Shut-off	23
The Display Panel	24
Checking the Battery	24
Clicking the Shutter	24
Using the viewfinder	24
Using the LCD monitor	25
Picture-taking Range	26
Adjusting Settings	27
Image quality	28
Flash	29
Self timer	29
Macro mode	30
Special photo formats	30
Checking the Picture Counter	32
Playing Back Your Photos	33
Displaying photos on a television	34



Chapter 3 Using PhotoPC 600 with Your Computer

Connecting PhotoPC 600 to Your Computer	36
Connecting to a PC	37
Connecting to a Macintosh	38
Accessing EPSON Photo!2	40
For Windows users	40
For Macintosh users	41
Working with EPSON Photo!2	41
Closing EPSON Photo!2	42
Getting help	42
Getting status and progress information	42
Using the Camera Menu	43
Selecting images	43
Transferring selected photos	44
Saving selected photos to a folder	44
File names	45
Transferring pictures to your documents	45
Erasing selected pictures from your camera	48
Getting photo information	48
Using the Folder Menu	48
Selecting images	49
Transferring photos	49
Finding the folder containing your photos	50
Uploading photos	50
Transferring pictures to your documents	51
Erasing selected files from a folder	51
Getting photo information	51
Using the Controls Menu	52
Controlling the camera from your computer	52

Taking pictures from your computer	53
Erasing photos	54
Using the Setup Menu	55
Making computer connection settings	55
Making camera settings	56

Chapter 4 Using the LCD Monitor Menus

Working with LCD Monitor Menus	58
Using the Settings Menu	60
Setting the clock	60
Setting the alert beep	61
Setting LCD brightness	61
Setting the multi-frame shooting time	62
Using the Information Menu	62
Using the Playback Mode Menu	62
Using the Erase Photo Menu	63
Using the Photo Control Menu	63
Erasing photos	63
Locking photos	65
Getting memory information	66
Copying photos	66
Formatting memory cards	67
Using the Slide Show Menu	68
Using the Option Menu	68
Using the Language Menu	69



Chapter 5 Using the Uploader Utilities

Uploading Images to the Camera	70
Uploading images from your PC	71
Uploading images from your Macintosh	73
Making Screen Copies	75
For Windows users	75
For Macintosh users	77
Uploading Programs to the Camera	78
Uploading programs	78
Removing programs	79

Chapter 6 Camera Options

Using CompactFlash Memory Cards	80
Installing a CompactFlash Card	81
Removing a CompactFlash Card	82
Using the optional PCMCIA adapter	82
Using the AC Adapter	83
For United Kingdom users - safety information	85

Chapter 7 Maintenance and Troubleshooting

Caring for the Camera	86
Caution	86
Cleaning the camera	86
Storing the camera	86
Camera Problems	87
Picture Problems	90

Chapter 8 Using the Direct Print Kit

Preparing to Use the Direct Print Kit	92
Connecting Your Camera to the Printer	93
Paper Types	94
Using the Direct Print Kit	95
Accessing the Direct Print program	95
Printing your images	95
LCD Screen and Display Panel Messages	101
Printed Image Dimensions	102

Appendix A Specifications

Camera	103
Product type	103
Recorded Image	103
Optical	103
Functional	104
Interface	104
Power	105
Physical Dimensions	105
Optional CompactFlash Card	105
Optional PCMCIA Adapter	106
Optional AC Adapter	106



Appendix B Contacting Customer Support

For United Kingdom and the Republic of Ireland Users	107
Customer Support	108
Faxon EPSON	108
EPtec - Bulletin Board Service for latest drivers and utilities	108
World Wide Web	108
For United States Users	109
Electronic support services	109
For Australian Users	110
EPSON FAXBACK	110
EPSON Bulletin Board System	110
Internet URL http://www.epson.com.au	110
Your dealer	110
EPSON Helpdesk	110
For Hong Kong Users	111
Internet home page	111
Electronic bulletin board system	111
Technical Support Hotline	111
For Philippines Users	111
For Singapore Users	112

Glossary

.	113
-----------	-----

Index

.	114
-----------	-----

Introduction

Your new EPSON® PhotoPC 600™ is a revolutionary, easy-to-use digital camera that enables you to take full-color pictures and immediately use them with your computer. PhotoPC 600 comes with everything you need, including EPSON Photo!2 software that lets you transfer your pictures to your computer's hard disk drive. You can then edit, enhance, and organize your pictures or simply place them into your documents.

Create professional letters, documents, and presentations with real life images right on your desktop. Share pictures with business colleagues or friends over the Internet. Add color and visual appeal to your newsletters, flyers, and brochures. Anything you can display on your screen or print will look better with PhotoPC 600 pictures.

PhotoPC 600 Features

PhotoPC 600 is a complete system for capturing digital images, and includes the following features:

- 24-bit color image capture
- High resolution (1024 × 768 pixels)
- 4MB internal memory holds approximately 8 super fine quality color or monochrome images, 18 fine quality color or monochrome images, or 56 standard quality color images.
- Three color and two monochrome image quality settings
- Built-in color LCD monitor for previewing and playing back pictures
- Optical viewfinder
- Macro, zoom, panorama, and multi-frame photo formats
- Automatic date and time recording for each picture
- Video cable for displaying your pictures on a television monitor
- Built-in flash with automatic, forced flash, and flash off settings
- Self timer
- Automatic shut-off to save batteries
- Serial cables for transferring photos to your computer

- ❑ EPSON Photo!2 software lets you transfer your pictures to your computer.
- ❑ EPSON Photo File Uploader software allows you to convert images stored in your computer to EPSON Photo file format and upload them to your camera.
- ❑ EPSON Photo!2 Program Uploader software lets you upload optional programs to the camera from your computer.
- ❑ Use your pictures with Windows® and Macintosh® applications

Options

The following PhotoPC 600 options are available from EPSON:

- ❑ CompactFlash™ Cards (4MB: B808311, 15MB: B808301)
- ❑ PCMCIA adapter (B867041)
- ❑ AC Adapter (B86703*) for use with a standard electrical outlet

Note:

The asterisk is a substitute for the last digit of the product number, which varies by country.

For United Kingdom users - use of options

Epson (UK) Limited shall not be liable against any damages or problems arising from the use of any options or consumable products other than those designated as Original EPSON Products or EPSON Approved Products by Epson (UK) Limited.

System Requirements

PCs

IBM®-compatible PC with 386 or higher processor (with Windows NT®, 486 or higher processor is required)

Serial port with standard RS-232C interface and a communication speed of 19200 bps or higher

8MB RAM (with Windows NT, at least 16MB is required)

Hard disk drive with at least 30MB free space

VGA or SVGA monitor with at least 16-color display

Microsoft® Windows 3.1 or later, Microsoft Windows for Workgroups® 3.11 or later, Windows 95, or Windows NT Version 3.51 or later

Macintosh Computers

Macintosh with 68040 or Power PC processor

Serial port and a communication speed of 19200 bps or higher

8MB RAM

Hard disk drive with at least 30MB free space

Monitor with minimum resolution of 640x480

Macintosh System 7.1 or later (System 7.5 or later is required to access optional CompactFlash Card memory directly from the Macintosh)

Safety Instructions

Read all of these instructions and save them for later reference. Follow all warnings and instructions marked on the camera and its options.

- ❑ To reduce the risk of electric shock, do not remove the cover of the camera or any of its options and do not open any compartments except as instructed in this *User's Guide*.
- ❑ Do not insert objects through any openings.

- ❑ To prevent fire or electric shock, do not expose the camera or its options to rain or moisture.
- ❑ To prevent fire or explosion, do not use the camera where inflammable or volatile gas is stored.
- ❑ Do not use outdoors during a thunderstorm.
- ❑ If the camera or any of its options shows unusual signs such as noise, odor, or smoke, stop using it and turn the camera off immediately. Remove the batteries and/or disconnect the AC adapter, and unplug the AC adapter from the electrical outlet.
- ❑ Do not use harsh or abrasive cleaners. Wipe off dust with a clean, dry cloth.
- ❑ To avoid damage to the optics of the camera, do not expose the lens to direct sunlight for extended periods of time.
- ❑ Handle the camera gently and avoid subjecting it to strong shocks or vibrations. If the camera is dropped or otherwise jarred, the following errors may occur even if the camera is not permanently damaged:

The camera's date and time settings may be lost.

If the camera is jarred while processing an image, the camera may fail to record the image in its memory.

- ❑ Do not store the camera or its options near sources of bright light, direct sunlight, high humidity, heat, excessive dirt or dust, or where they will be exposed to strong vibrations or magnetic fields.
- ❑ Always keep your camera in its case when you're not using it.
- ❑ To prevent possible eye injury, do not take flash pictures of faces at close range.
- ❑ Avoid sudden temperature changes, which can cause moisture to condense on the camera and its options. Keep the camera and its options in a case or bag if you need to move them from a cold environment to a warm one. Allow time for the camera and its options to adjust to temperature changes before using them.
- ❑ Use only the type of power source indicated in this *User's Guide*.
- ❑ Do not use a damaged or frayed power cord.
- ❑ If you use an extension cord with the optional AC adapter, make sure the total ampere rating of the devices plugged into the extension cord does not exceed the cord's ampere rating. Also, make sure the total ampere rating of all devices plugged into the wall outlet does not exceed the wall outlet's ampere rating.
- ❑ Remove the batteries and/or unplug the camera and refer servicing to qualified service personnel under the following conditions:
 - If the power cord or plug is damaged; if liquid has entered the camera or its options; if the camera or its options have been dropped or the case damaged; if the camera or its options do not operate normally or exhibit a distinct change in performance. Adjust only those controls that are covered by the operating instructions.
- ❑ If you plan to use the camera and its options in Germany, observe the following:
 - To provide adequate short-circuit protection and over-current protection for the products, the building installation must be protected by a 16 Amp circuit breaker.
 - Bei Anschluß des Produkts an die Stromversorgung muß sichergestellt werden, daß die Gebäudeinstallation mit einem 16 A-Überstromschalter abgesichert ist.
- ❑ If the liquid crystal solution contained in the display panel or in the screen on the LCD monitor leaks out and gets on your hands, wash them thoroughly with soap and water. If it gets into your eyes, flush them immediately with water.

Warnings, Cautions, and Notes



***Warnings** must be followed carefully to avoid bodily injury.*



***Cautions** must be observed to avoid damage to your equipment.*

***Notes** contain important information and useful tips on the operation of your camera and its options.*

Chapter 1

Getting Started

This chapter helps you get ready to use your PhotoPC 600. It covers the following:

- Unpacking your PhotoPC 600
- Getting to know the camera
- Installing the batteries
- Attaching the hand strap
- Installing your EPSON Photo!2 software
- Installing your EPSON Photo File Uploader software

Unpacking Your PhotoPC 600

Make sure you have all the parts shown below.

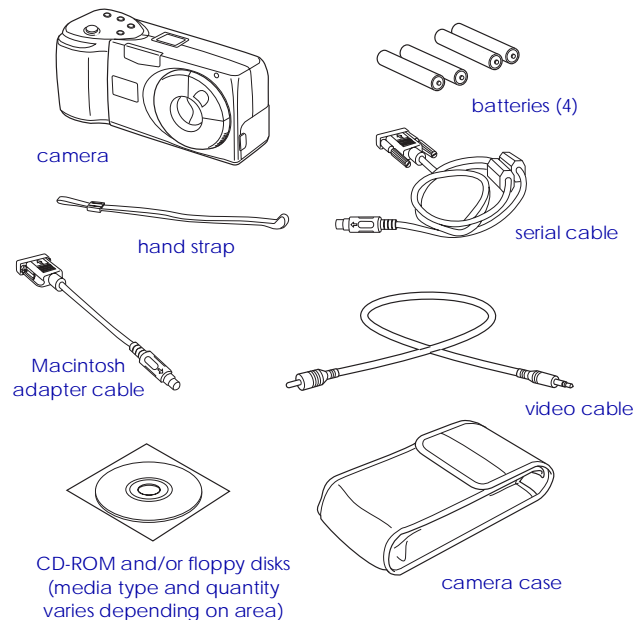

Getting to Know the Camera

After you unpack your PhotoPC 600, take a few minutes to learn about its features, as shown below.

Front view

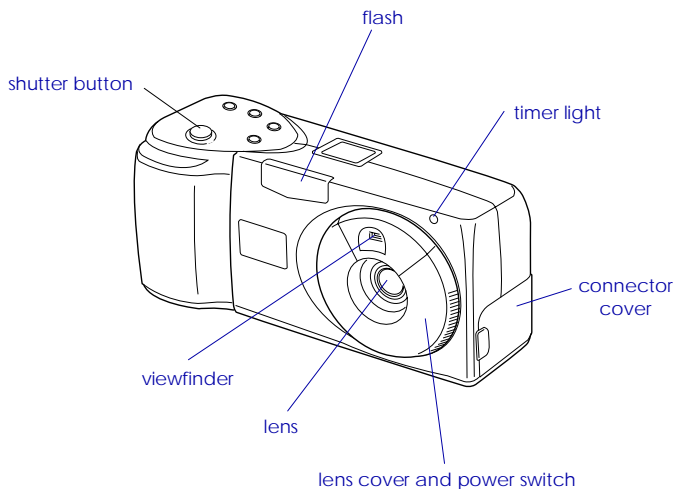

Back view

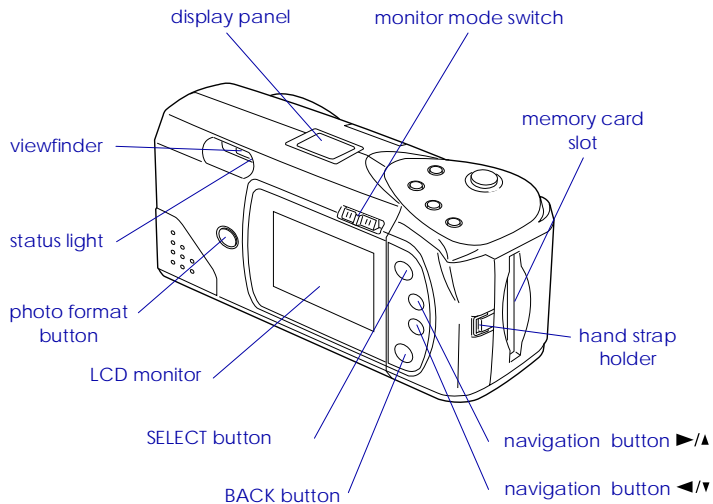

Bottom view

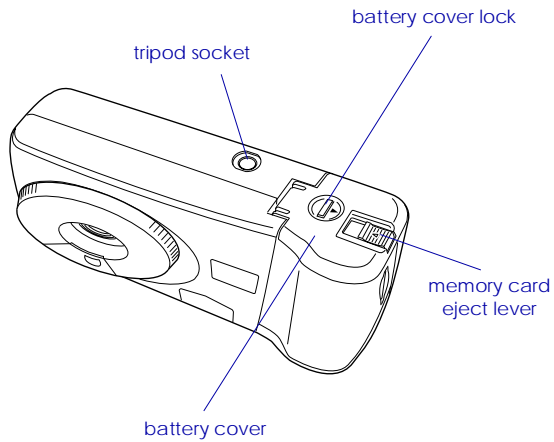

Top view

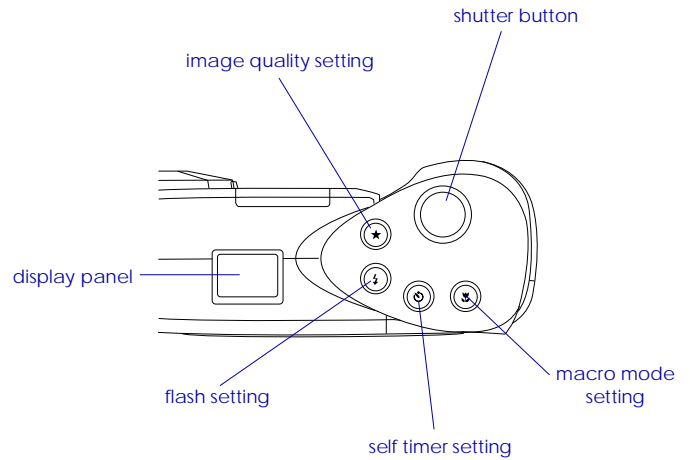

Installing Batteries

Your PhotoPC 600 comes with four AA (LR6) alkaline batteries. Make sure the camera is off, and follow these steps to insert the batteries:

1. Turn the camera upside down with the lens facing you. Push the battery cover lock down and slide it to the right, then open the cover.

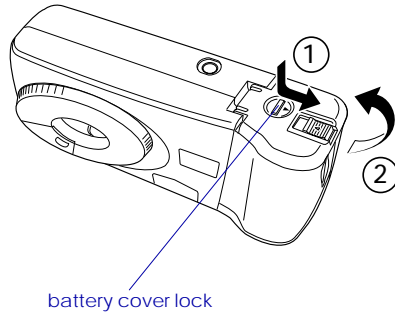

2. Insert all four batteries into the compartment, positioning the + and - ends as shown below.

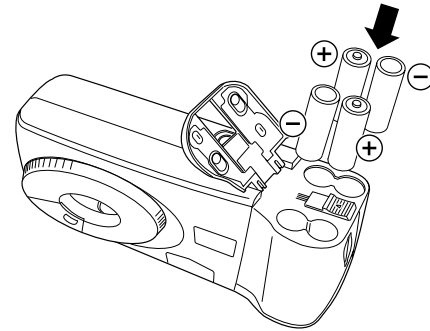

3. Close the battery cover and make sure the lock snaps into place as shown below.

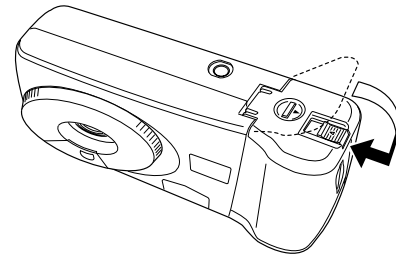

Handling batteries

When your PhotoPC 600 batteries wear out, you can replace them with any of the following:

Single-use AA (LR6) alkaline batteries

Single-use AA (FR6) lithium batteries
(longest battery life)

Rechargeable AA Ni-Cd batteries

Rechargeable AA Ni-MH batteries



Warning:

To avoid the danger of fire or explosion, do not mix different types of batteries. Do not allow the battery contacts to touch metal objects such as coins or keys, which could short out the battery's circuits.

Note the following when handling batteries:

- ❑ Do not use manganese batteries.
 - ❑ Replace all four batteries at the same time.
 - ❑ Do not drop, puncture, disassemble, or mutilate batteries. Do not get them wet or expose them to fire.
- ❑ When the camera is not used for long periods of time, remove the batteries and store them at a low temperature in a dry location.
 - ❑ Dispose of used batteries according to the battery manufacturer's instructions and in compliance with all applicable laws. Contact your local government agency for information about battery recycling and disposal.
 - ❑ If you use rechargeable Ni-Cd or Ni-MH batteries, replace them with four fully-charged batteries. If you find that your batteries run out faster after you recharge them a number of times, make sure you discharge them completely before recharging.
 - ❑ Battery life varies depending on the battery type and the manufacturer.

Attaching the Hand Strap

To attach the hand strap, loop the strap around the holder on the side of the camera as shown below.

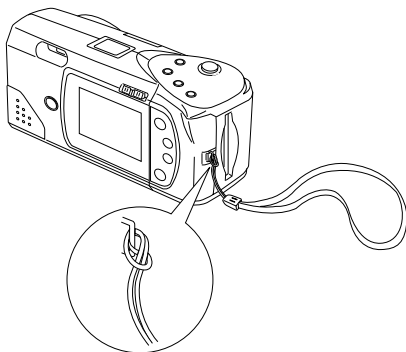

Installing EPSON Photo!2 Software

PhotoPC 600 comes with EPSON Photo!2 software that lets you transfer your pictures from the camera to your computer and place them into documents. You can also use this software to take pictures and change camera settings from your computer.

Note:

When you install EPSON Photo!2, the EPSON Photo!2 Program Uploader utility is also installed automatically.

Installing the software in your PC

Follow the steps in this section to install your EPSON Photo!2 software.

For Windows 95 or NT 4.0

1. Insert the camera software CD shipped with your camera in the CD-ROM drive. (If you use the floppy disk version, insert it in a disk drive.)
2. Double-click the My Computer icon.
3. Double-click the CD-ROM icon. You see the EPSON folder. (If you use the floppy disk version, double-click the floppy disk icon.)
4. Open the EPSON folder and double-click Disk 1.

Depending on the country, the EPSON folder may contain multiple-language versions of the software. Double-click the folder for your preferred language and double-click Disk 1.

5. Double-click the SETUP.EXE icon. Follow the instructions on the screen.

For Windows 3.1x or NT 3.51

1. Insert the camera software CD shipped with your camera in the CD-ROM drive. (If you use the floppy disk version, insert it in a disk drive.)
2. Open File Manager, then click the CD-ROM drive. (If you use the floppy disk version, click the floppy disk drive.)
3. Open the EPSON directory and the Disk 1 subdirectory.

Depending on the country, the EPSON directory may contain multiple-language versions of the software. Double-click the subdirectory for your preferred language and double-click Disk 1.

4. Double-click SETUP.EXE. Follow the instructions on the screen.

Installing the software in your Macintosh

Follow the steps below to install EPSON Photo!2 software in your Macintosh.

1. Insert the camera software CD shipped with your camera in the CD-ROM drive. (If you use the floppy disk version, insert it in a disk drive.)

2. Double-click the CD-ROM icon. (If you use the floppy disk version, double-click the floppy disk icon.)

3. Double-click the EPSON Photo!2 folder.

Depending on the country, the EPSON Photo!2 folder may contain multiple-language versions of the software. Double-click the folder for your preferred language.

4. Double-click the Photo!2 Installer - Part 1 icon to start the installation program. Follow the instructions on the screen.

Installing EPSON Photo File Uploader

PhotoPC 600 also comes with EPSON Photo File Uploader software that lets you convert digital images to EPSON Photo file format and transfer them from the computer to your camera. You can then display the images on the camera's LCD screen or on a television monitor.

Installing the software in your PC

Follow the steps in this section to install the EPSON Photo File Uploader software for Windows.

For Windows 95 or NT 4.0

1. Insert the camera software CD shipped with your camera in the CD-ROM drive. (If you use the floppy disk version, insert it in a disk drive.)
2. Double-click the My Computer icon.
3. Double-click the CD-ROM icon. You see the FUPLOAD folder. (If you use the floppy disk version, double-click the floppy disk icon.)
4. Open the FUPLOAD folder and double-click Disk 1.

Depending on the country, the FUPLOAD folder may contain multiple-language versions of the software. Double-click the folder for your preferred language and double-click Disk 1.

5. Double-click the SETUP.EXE icon. Follow the instructions on the screen.

For Windows 3.1x or NT 3.51

1. Insert the camera software CD shipped with your camera in the CD-ROM drive. (If you use the floppy disk version, insert it in a disk drive.)
2. Open File Manager, then click the CD-ROM drive. (If you use the floppy disk version, click the floppy disk drive.)
3. Open the FUPLOAD directory and double-click Disk 1.

Depending on the country, the CD-ROM may contain multiple-language versions of the software. Double-click the subdirectory for your preferred language and double-click Disk 1.
4. Double-click SETUP.EXE. Follow the instructions on the screen.

Installing the software in your Macintosh

Follow the steps below to install EPSON Photo File Uploader Software in your Macintosh.

1. Insert the camera software CD shipped with your camera in the CD-ROM drive. (If you use the floppy disk version, insert it in a disk drive.)

2. Double-click the CD-ROM icon. (If you use the floppy disk version, double-click the floppy disk icon.)
3. Double-click the File Uploader folder.

Depending on the country, the File Uploader folder may contain multiple-language versions of the software. Double-click the folder for your preferred language.

4. Drag the contents of the folder to the folder on your hard drive where you want to install the software.

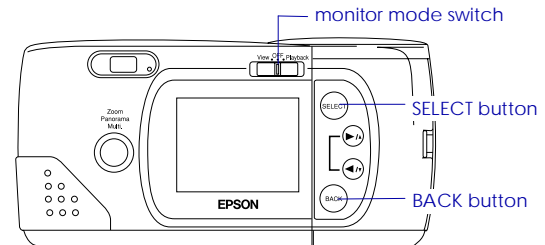

2. Press the SELECT button until the language you want is highlighted.
3. Press the BACK button to save your selection and return to the View or Playback mode.

If you want to change the language setting, see page 69 for instructions.

Setting the Language

You need to set the language for messages displayed on the LCD monitor the first time you use it. Depending on your country, you can choose English, Japanese, French, German, Italian, Portuguese, or Spanish.

Follow these steps to set the language.

1. Slide the monitor mode switch on the back of the camera to View or Playback.

A message in English stating that you need to set the language appears on the LCD screen. Press any of the monitor control buttons to the right of the screen, or wait 5 seconds. The language setting screen appears.

Setting the Date and Time

When you install the batteries for the first time or when you replace them, you need to set the date (year, month, and day) and time (hour and minute).

After installing the batteries, follow these steps to set the clock on the LCD monitor and to have the time and date of each picture automatically recorded.

Note:

If you connect PhotoPC 600 to your computer when the camera's clock is not set, the camera is set to your computer's time and date automatically. For instructions on connecting the camera to the computer, see page 36.

1. Slide the monitor mode switch on the back of the camera to View or Playback. A message stating that you need to reset the clock appears on the screen.
2. Press the SELECT button to set the clock. The clock setting screen appears with the setting for the year highlighted in red.

Note:

If you do not want to set the clock, press the BACK button to return to the View or Playback mode.

3. Press the ►/▲ button to increase the number, or the ◀/▼ button to decrease the number, until the year is correct.
4. Press the SELECT button. The year setting is saved and the month setting is highlighted.

5. Adjust the month, day, hour, and minute settings as described above until the date and time are correctly adjusted and saved.

Note:

If you want to reset any previous item, simply press the BACK button until the item you want to reset turns red.

When you finish making the minute setting and press the SELECT button, the LCD screen returns to the View or Playback mode.

You're now ready to take pictures with your PhotoPC 600. Turn to Chapter 2 for simple, step-by-step instructions.

Chapter 2

Taking Pictures with PhotoPC 600

Using PhotoPC 600 to take pictures is similar to using a traditional "point and shoot" camera. This chapter tells you everything you need to know about the following:

Turning the camera on and off

Auto shut-off

The display panel

Checking the battery

Clicking the shutter

Picture-taking range

Adjusting settings

Checking the picture counter

Playing back your photos

Displaying photos on a television

Turning the Camera On and Off

To turn the camera on, simply rotate the lens cover counterclockwise. The lens cover opens and the display panel on the top of the camera lights up. The status light on the back of the camera flashes red for a few seconds, then turns green. The camera is ready to take pictures.

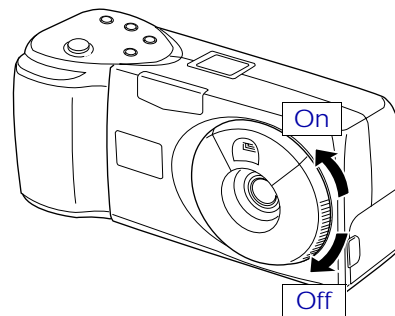

Rotate the lens cover clockwise to turn off the camera. The lens cover closes and the display panel turns off.

Auto Shut-off

To save battery power, the camera turns itself off automatically after 60 seconds if no buttons are pressed. To turn the camera back on, close the lens cover then open it again.

When your camera is connected to the optional AC adapter, the auto shut-off feature is disabled.

Note:

- ❑ *If you want, you can change the 60 second time period for auto shut-off by using your EPSON Photo!2 software. For more information, see page 57.*
- ❑ *When the camera is connected to your computer, it shuts itself off after 5 minutes of inactivity. It comes back on automatically when you use any of the software camera controls in your EPSON Photo!2 software.*

LCD monitor power saving features

Because the LCD monitor consumes additional power, the LCD monitor turns off automatically in the following cases:

- ❑ When you turn off the camera with the LCD monitor in View mode

- ❑ When the camera is not used for 30 seconds with the LCD monitor in View mode
- ❑ When the camera is not used for 5 minutes with the LCD monitor in Playback mode
- ❑ When the camera is not turned on within 15 seconds of switching the LCD monitor to View mode
- ❑ When the camera is connected to a computer with the LCD monitor in View mode
- ❑ When the camera is connected to a television

To turn the LCD monitor back on, slide the monitor mode switch to OFF then slide it back to View or Playback.

When your camera is connected to the optional AC adapter, the LCD monitor auto shut-off feature is disabled.

The Display Panel

The display panel keeps track of how many pictures you can take and gives you information on camera settings and the battery level.

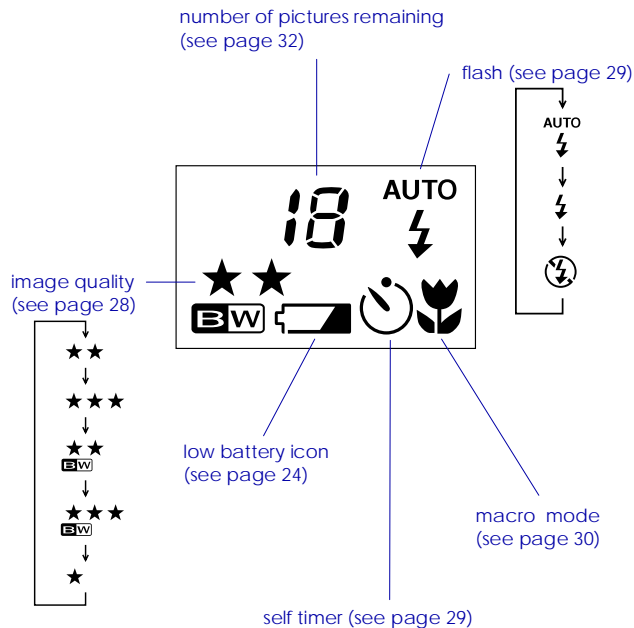

Checking the Battery

When the battery power is almost out, a low battery icon  appears on the display panel. When this icon is flashing, you cannot take pictures until you change the batteries. When the battery power runs out with the LCD monitor in the Playback or View mode, the low battery icon appears on the LCD screen for five seconds, then the monitor and the camera turn off automatically.

You should use the low battery icon only as a rough guide to remaining power. Note that several factors can affect battery life, including the surrounding temperature and the type of batteries you use. Low temperatures (especially below 10°C) will drain your batteries more rapidly. See page 15 for information about changing batteries.

Clicking the Shutter

Follow the steps below to take photos using the viewfinder or the LCD monitor.

Using the viewfinder

1. Turn the camera on and wait until the status light beside the viewfinder turns green.

2. Look straight through the viewfinder and center your subject in the cross-hairs.

Note:

The frame in the viewfinder indicates the area captured when taking pictures at close range.

3. Hold the shutter button halfway down to lock the auto focus. The status light beside the viewfinder changes from green to orange. If you wish, you can now move your subject off-center without altering the focus. Press the shutter button the rest of the way down to take the photo.
4. Hold the camera still until the status light starts flashing red and the camera beeps.

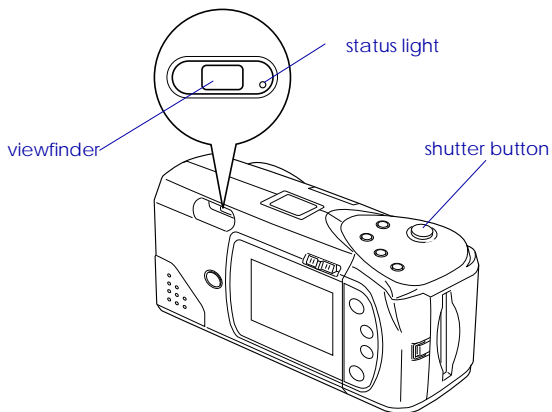

The flashing red light indicates that the image is captured and the camera is processing it. (If you try to press the shutter button while the status light is flashing red, you will hear two “error” beeps.) When the light stops flashing and turns green, the image is saved. Saved images remain in memory for years, even when the camera is turned off and the batteries are removed. You can take another photo when the status light turns green.

Using the LCD monitor

1. Turn the camera on and slide the monitor mode switch on the back of the camera to View. You will see a live preview on the LCD screen. Center your subject on the screen.

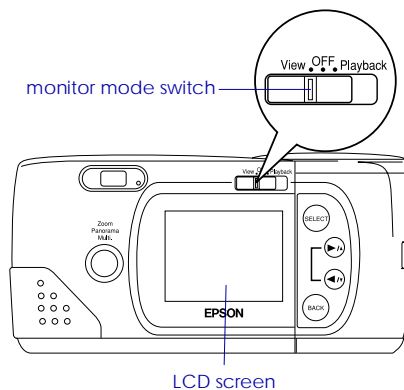

Note:

Icons indicating the image quality setting ★ , the number of photos you can take ☐ , and the number of photos taken 📷 appear at the bottom of the LCD screen.

2. Hold the shutter button halfway down to lock the auto focus. A small green circle appears on the corner of the LCD screen, and the status light beside the viewfinder changes from green to orange. If you wish, you can now move your subject off-center without altering the focus. Press the shutter button the rest of the way down to take the photo.
3. Hold the camera still until the status light starts flashing red and the camera beeps.

When you press the shutter button, the LCD monitor displays the picture you took with a processing icon ☐ in the center of the screen until the camera finishes processing it, then the monitor returns to live preview.

Note:

- ☐ *When battery power is low and the flash was used to take the picture, the return to live preview may be delayed while the camera recharges the flash. The LCD screen will be blank during this period.*
- ☐ *The live preview image may appear to flicker when viewed under strong fluorescent lighting, depending on the lighting's frequency. This is normal.*

Picture-taking Range

When composing a shot through the viewfinder, you should be at least 50 cm away from your subject. When using the LCD monitor, you can use the camera's macro mode to take photos as close as 20 cm. See page 30 for instructions.

You can take flash pictures within a range of 20 cm to 2.4 m. See page 29 for more information on using the built-in flash.

Note:

When you are taking pictures outdoors, make sure the sun is at your back. In very bright light (at the beach or in snow, for example) your pictures may come out too light. However, you can correct most over-exposure problems from your computer using image-editing software.

Adjusting Settings

The buttons on the top of the camera allow you to control the following PhotoPC 600 features:

Image quality (see page 28)

Flash (see page 29)

Self timer (see page 29)

Macro mode (see page 30)

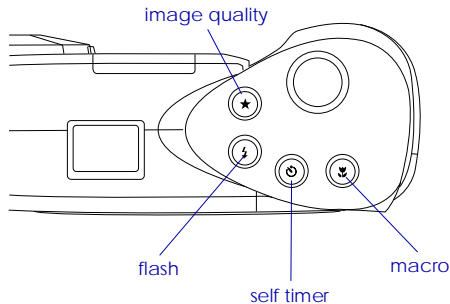

All control button settings (except the self timer) remain in effect even after you turn off the camera.

When the LCD monitor on the back of your camera is switched to View, you can use the buttons surrounding the monitor to select these special photo formats:

Zoom

Panorama

Multi-frame

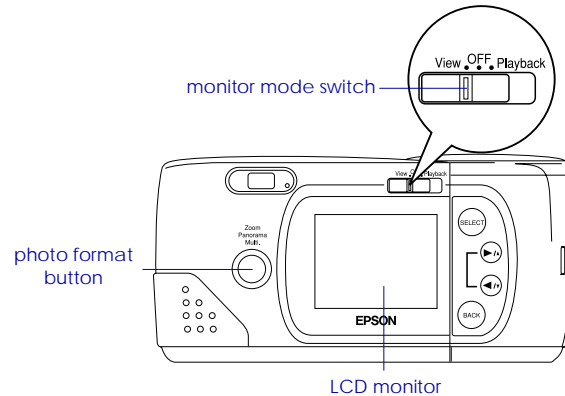

Note:

All camera settings return to their factory defaults when you remove or change the batteries.

Image quality



PhotoPC 600 has three color and two monochrome image quality settings. Press the image quality control button to cycle from one setting to another. The settings appear on the display panel as shown below.

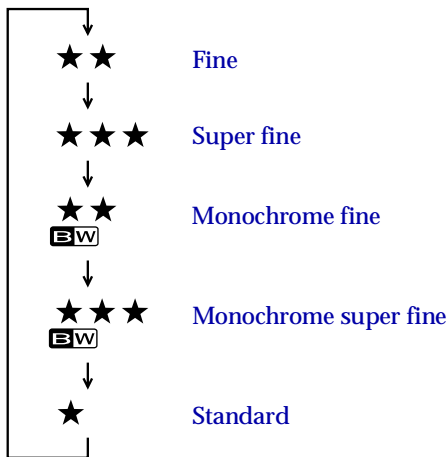

Fine

Images are captured in color at 1024 x 768 pixels. Your pictures include moderate detail, and the camera holds approximately 18 pictures.



Super fine

Images are captured in color at 1024 x 768 pixels. Your pictures include greater detail, but the camera only holds approximately 8 pictures.



Monochrome fine

Images are captured in black and white at 1024 x 768 pixels. Your pictures include moderate detail, and the camera holds approximately 18 pictures.



Monochrome super fine

Images are captured in black and white at 1024 x 768 pixels. Your pictures include greater detail, but the camera only holds approximately 8 pictures.



Standard

Images are captured at 640 x 480 pixels. The camera holds approximately 56 pictures, but the images include less detail.

Note:

If you select one of the monochrome image quality settings when the LCD monitor is in View mode, the image turns from color to black and white, a blue frame appear around the image, and MONOCHROME appears briefly on the screen.

You can switch freely between these settings and mix pictures of varying quality in the camera. The camera's image capacity will vary accordingly.

Flash

 PhotoPC 600's built-in flash is effective within a range of 20 cm to 2.4 m. Press the flash control button to cycle through the three flash settings. The settings appear on the display panel as shown below.

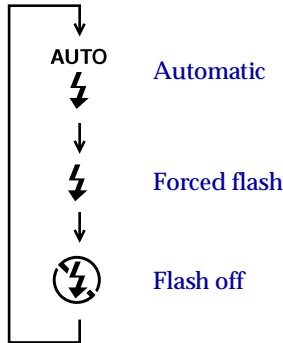

AUTO
 Automatic
The flash fires automatically whenever it is needed for adequate lighting (factory setting).



Forced flash
The flash fires with every picture you take. Use this setting to compensate for backlighting; for example, when you are facing the sun.



Flash off
The flash is disabled, even when adequate lighting is not available. Use this setting for special effects, or where flash photography is prohibited.

Note:

After taking a flash photo, the flash icon blinks until the flash is fully recharged.

Self timer



Setting the self timer creates a 10-second delay between the time you press the shutter button and the actual image capture. This allows you to take a picture of yourself. The timer icon appears on the display panel when you use the timer. Follow these steps to take a picture with the timer:

1. Secure the camera on a flat surface or a tripod.
2. Turn on the camera and wait until the status light turns green.

3. Press the timer button. The timer icon appears on the display panel.
4. Press the shutter button. The timer icon and the red timer light on the front of the camera flash slowly for eight seconds, then rapidly for two seconds before the shutter releases.

The camera beeps when the image is captured. The status light on the back of the camera flashes red as PhotoPC 600 processes the image. When the status light stops flashing and turns green, you can take another picture. You need to press the timer button again each time you want to take a picture using the self timer.

Macro mode



Use the macro mode to take pictures at close range. This mode enables you to take pictures within a range of 20 cm to 50 cm. Follow these steps to take a picture in the macro mode:

1. Turn the camera on and slide the monitor mode switch to View. A live preview appears on the LCD screen.
2. Press the macro button. The macro mode icon appears on the display panel. A green frame appears around the previewed image and MACRO appears briefly on the LCD screen.

3. Press the shutter button.

Note:

To make sure your subject is framed accurately, we recommend that you use the LCD monitor rather than the viewfinder when taking a photo in macro mode.

To turn off macro mode, simply press the macro button again.

Special photo formats

Your camera features three special photo format modes: zoom, panorama, and multi-frame. Zoom mode allows you to enlarge the image by as much as three times. In panorama mode you can shoot wide-angle panoramas. Shooting in multi-frame mode causes the shutter to release nine times in rapid sequence, producing a single image composed of nine stop-action frames. This mode can be useful if you want to break down a complex motion, such as your golf swing, into a series of easy-to-see steps.

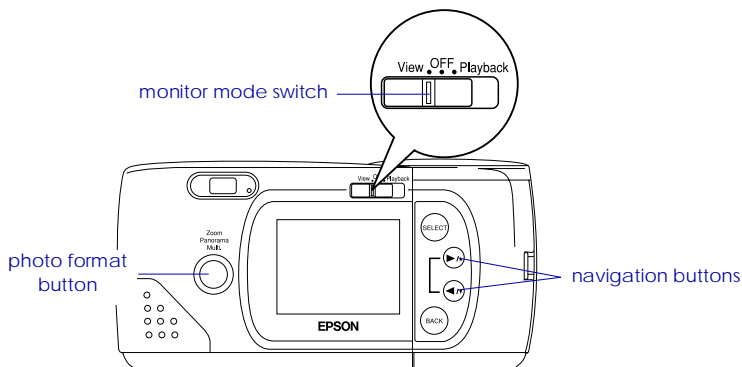

To use these special photo formats, follow these steps:

1. Turn the camera on and slide the monitor mode switch to View. A live preview appears on the LCD screen.
2. Use the photo format button and navigation buttons surrounding the LCD monitor to control the photo format modes, as described below.





Zoom

To select the zoom mode, press the photo format button. An orange frame appears around the previewed image, and ZOOM is displayed briefly on the screen along with the zoom power and a zoom icon .



You can increase the zoom rate from 1 (normal) to 1.3, 1.6, 2, 2.5, or 3 times normal by pressing the  button. To decrease the rate from 3 back down to 1, press the  button. (If the zoom rate is already 1, pressing the  button switches the photo format mode to panorama.) In zoom mode, images are captured at standard image quality (640 x 480 pixels).

Panorama

To select the panorama mode, press the photo format button, then press the  button once. PANORAMA appears briefly on the screen along with a panorama icon  and the LCD screen is framed with black margins at the top and bottom.

While in panorama mode, you can use the image quality control button on top of the camera to select fine or super fine image quality (1024 x 384 pixels). See page 28 for more information on image quality settings.

Multi-frame

To select the multi-frame mode, press the photo format button, then press the  button twice. A red frame appears around the previewed image, and MULTI is displayed briefly on the screen along with a multi-frame icon . Images are captured at standard image quality (640 x 480 pixels).

Note:

You can switch freely between these settings and mix these formats in the camera.

- Once you have selected a photo format mode, press the shutter button. In multi-frame mode, the LCD screen goes black for a moment, then displays the nine stop-action frames one by one. When all nine frames appear, you have finished taking the multi-frame picture.

Note:

If your camera is for use with PAL television broadcasting standard, when you press and release the shutter button, the LCD screen goes black and the status light flashes red. When all nine frames are captured, the camera beeps. After a few seconds, the multi-frame image appears on the LCD screen. When the camera finishes processing the image, the monitor returns to live preview and the status light turns green. You can then take another photo.

To exit the photo format mode, simply press the photo format button again.

Checking the Picture Counter

The large number in the center of the camera's display panel shows you how many pictures you can take.

number of pictures remaining



The number of pictures remaining depends on the image quality setting you have chosen. If you change this setting, the number of pictures remaining will change.

When the camera's memory is full, the number on the display panel reads 0. The status light on the back of the camera turns red, and you cannot press the shutter button. You need to erase some or all of the images in your camera before you can take any more pictures. See page 63 for instructions on erasing photos using the LCD monitor. If you want to save your photos before you erase them, connect the camera to your computer and transfer the photos as described in Chapter 4.

If you install an optional CompactFlash Card, the number of pictures you can store in the memory card appears in brackets on the camera's display panel as shown below. For instructions on using optional memory cards, see page 80.

number of pictures remaining in the memory card

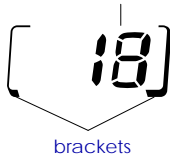

You can use the LCD monitor to find out how many photos you have already taken. See page 25 for instructions.

Playing Back Your Photos

When the LCD monitor is in Playback mode, you can play back photos on your camera's LCD screen or on a regular television set.

To play back your photos, follow the steps below.

Note:

Since you do not need to turn on the camera to play back your photos, we recommend leaving the camera off to save battery power.

1. Slide the monitor mode switch to Playback. The last photo you took appears on the LCD screen along with the date and time that the photo was taken. Icons indicating the image quality setting ★, frame number □, and the number of photos taken 📷 appear at the bottom of the screen.

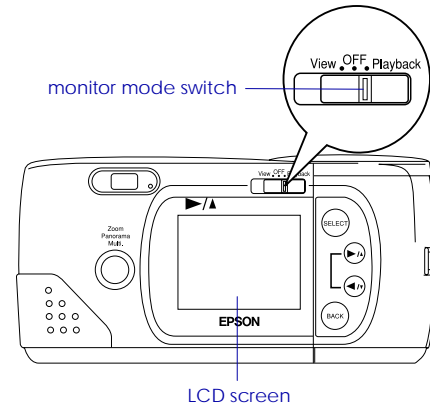

2. Press the ►/▲ or ◀/▼ button to display the previous or next photos.

Note:

You can also display up to nine consecutive "thumbnail" images at a time using the Multi-photo Playback mode, or automatically play back your photos in sequence using the Slide Show feature. See Chapter 4 for instructions.

Displaying photos on a television

You can display the pictures in your camera on a regular television just as you can on the LCD screen simply by using the video cable that came with your PhotoPC 600.

Note:

Color television telecasting specifications are different depending on the country. If you have an NTSC camera model, your television must meet NTSC color television telecasting specifications. If you have a PAL camera model, your television must meet PAL specifications.

Follow these steps to connect PhotoPC 600 to your television:

1. Make sure the camera and television are turned off.
2. Open the connector cover on the side of the camera.

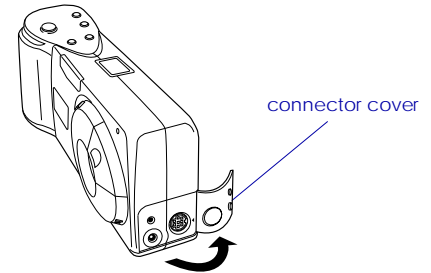

3. Connect the video cable to the Video Out port on the camera as shown below.

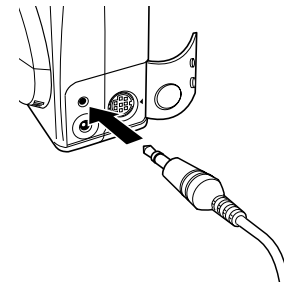

4. Connect the other end of the video cable to the video input port on the television.

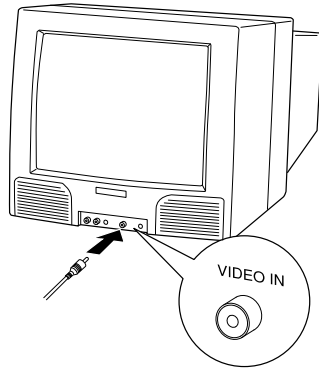

5. Turn on the television and switch it to video mode.
6. Slide the monitor mode switch to Playback.

The last picture you took appears on the television instead of the LCD monitor screen.

Note:

If you use the optional AC adapter, you can see the pictures on both the television and the LCD screen.

Chapter 3

Using PhotoPC 600 with Your Computer

When you are finished taking pictures, you can connect the camera to your computer and transfer the images. Then you can use them in your letters, presentations, or just about anything you create on your computer. This chapter tells you how, including:

Connecting PhotoPC 600 to your computer

Transferring pictures to your computer

Erasing pictures from the camera

Using pictures in your documents

Uploading EPSON Photo images to the camera

Connecting PhotoPC 600 to Your Computer

Before you start, make sure the camera is finished processing, then locate the serial cables that came with your PhotoPC 600. The long cable is for connecting the camera to a PC, and both the long and short cables are needed to connect it to a Macintosh computer. If you have the optional AC adapter, you can save on batteries by using the adapter whenever you connect the camera to your computer.

Note:

When the camera is connected to your computer, you cannot use any of the control buttons or the shutter button on the camera. You can only operate the camera through your computer.

The camera's auto shut-off feature remains in effect when the camera is connected to your computer, but it takes place after 5 minutes of inactivity. To turn the camera back on, you can close and reopen the lens cover, or you can use any of the software camera controls on your computer.

Connecting to a PC

Follow these steps to connect the camera:

1. Make sure the camera and your computer are turned off. Also make sure the LCD monitor is turned off.
2. Locate a serial port on the back of your computer. You may have two serial ports labeled COM1 and COM2, or the ports may be labeled with icons. If you have two serial ports available, use port 1 to connect your camera.

3. Line up the serial connector on the cable with one of the serial ports on your computer, and insert the connector. Then tighten the screws.

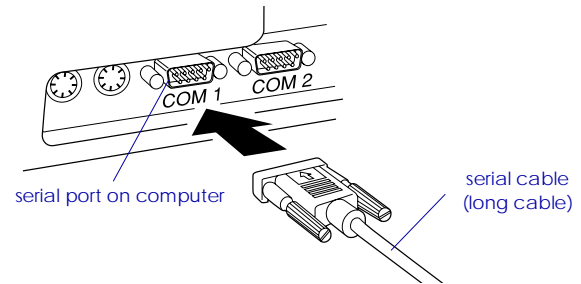

4. Open the connector cover on the side of the camera.

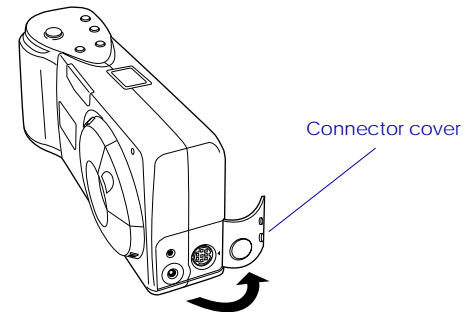

- Depending on the type of cable you have, line up either the arrow or the flat surface of the cable connector with the mark on the camera's serial port. Then insert the connector.

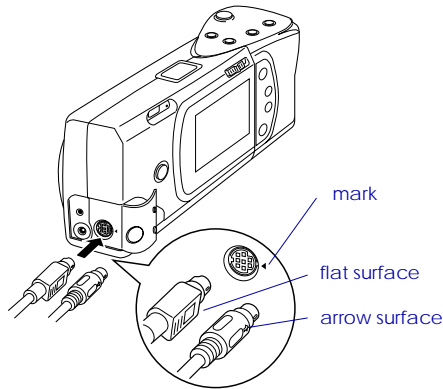

- Turn on the camera and your computer system.



Caution:

Keep the entire computer system away from potential sources of electromagnetic interference, such as loudspeakers or the base units of cordless telephones.

Connecting to a Macintosh

Follow these steps to connect the camera:

- Make sure the camera and your computer are turned off. Also make sure the LCD monitor is off.
- Locate the modem port and the printer port on the back of your computer. The ports should be labeled with icons.



modem port



printer port

3. Connect the long cable to the short cable (Macintosh adapter cable), then tighten the screws. Line up the serial connector on the short cable with either the modem or the printer port on your computer, and insert the connector.

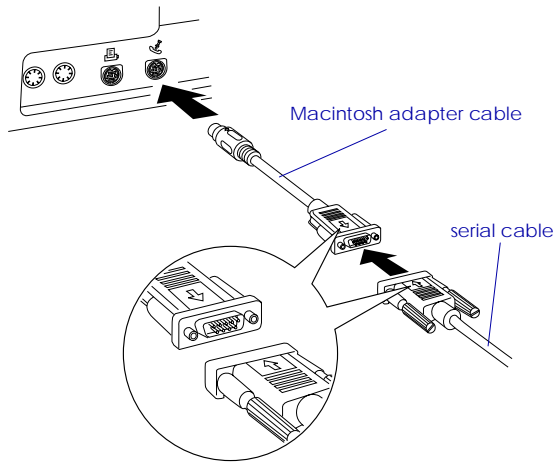

4. Open the connector cover on the side of the camera.

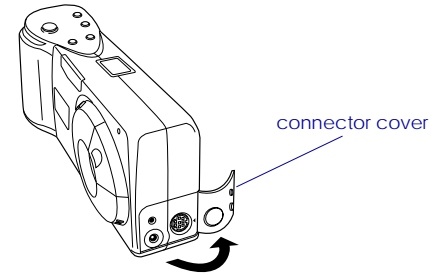

5. Depending on the type of cable you have, line up either the arrow or the flat surface of the long cable connector with the mark on the camera's serial port. Then insert the connector.

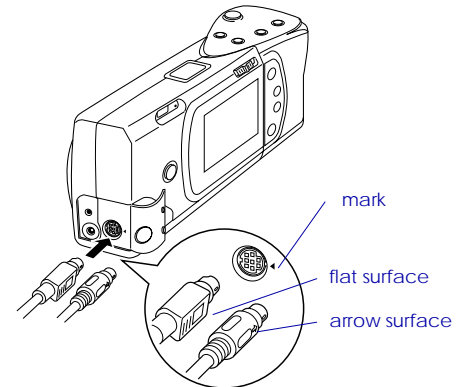

6. Turn on the camera and your computer system.



Caution:

- ❑ *If you connected the camera to a serial port that you use for another device and AppleTalk is turned on, turn off AppleTalk. The computer may not recognize the camera if AppleTalk is turned on.*

- ❑ *Keep the entire computer system away from potential sources of electromagnetic interference, such as loudspeakers or the base units of cordless telephones.*

Accessing EPSON Photo!2

Once your camera and computer are connected and turned on, you are ready to start working with the EPSON Photo!2 software that came with PhotoPC 600. This software allows you to download your photos to your computer so that you can use them in your documents.

If you have not installed EPSON Photo!2 yet, do so now, following the instructions on page 17. Then follow the instructions in this section to access the software.

Note:

If the camera's clock was not set when you connected it to your computer, the camera is set to your computer's date and time automatically after opening EPSON Photo!2.

For Windows users

To open EPSON Photo!2 directly, simply double-click its icon in the EPSON Photo!2 program group (for Windows 3.1x and NT 3.51) or click its icon in the EPSON Photo!2 folder (for Windows 95 and NT 4.0).

To access EPSON Photo!2 from an application program that supports the TWAIN image acquisition standard, choose EPSON PhotoPC 600 as the TWAIN data source on your application's File menu, then acquire the image.

To access EPSON Photo!2 from an application that supports OLE2 (object linking and embedding), choose EPSON PhotoPC 600 Object on the Insert Object menu and click OK.

For Macintosh users

To open EPSON Photo!2 directly, simply double-click its icon, located in the EPSON Photo!2 folder.

To access EPSON Photo!2 from an application program that supports the TWAIN image acquisition standard, choose PhotoPC 600 as the TWAIN data source from your application's File menu, then acquire the image.

Note:

The exact way to access EPSON Photo!2 from TWAIN- or OLE2-compliant applications varies depending on your software. Refer to your software manual for detailed instructions on selecting TWAIN data sources or inserting OLE objects.

Working with EPSON Photo!2

When you open EPSON Photo!2, an introductory screen appears briefly in the EPSON Photo!2 window, then the Camera menu appears, indicating your camera and computer are connected properly.



3

If the Setup menu appears in place of the Camera menu, your camera and computer may not be properly connected. Make sure your camera is correctly connected to your computer. If the Camera menu still does not appear, see page 55 for instructions on using the Setup menu to establish the proper connection.

Note:

While the camera and the computer are communicating, star icons move across the camera's display panel. Avoid opening or using other applications during this time; otherwise the communications may be interrupted.

Click the menu tabs along the top of the EPSON Photo!2 window to open the following four menus:

Camera

The Camera menu displays small thumbnail images of all the photos stored in the camera so you can easily select which images you want to transfer to the computer or erase from the camera.

If an optional CompactFlash Card is installed in the camera, the Camera menu displays the images stored in the card instead of the images stored in the camera's internal memory.

Folder

The Folder menu displays thumbnail images of photos that have been saved to a folder. From this menu you can select thumbnails and transfer photos to your application or erase them from the folder. Also, you can upload images from your computer to your camera.

Controls

The Controls menu allows you to see a live preview on your computer screen, take photos from your computer, and change the camera settings.

Setup

The Setup menu allows you to make the communication link settings needed to connect the computer to the camera. From this menu you can also make the camera's internal time, date, and identification settings, and change the camera's auto shut-off time.

Closing EPSON Photo!2

You can close EPSON Photo!2 by clicking Close on any of the menus.

Getting help

Click Help on any of the EPSON Photo!2 menus for help related to the items on that menu.

Getting status and progress information

In addition to the Close and Help buttons, EPSON Photo!2 displays the status bar and progress meter no matter what menu is currently displayed.

Status bar

The status bar tells you what operation EPSON Photo!2 is currently performing.

Progress meter

The progress meter shows the progress of lengthy operations, such as downloading images from the camera.

Using the Camera Menu

When you open EPSON Photo!2, the Camera menu appears and EPSON Photo!2 starts downloading thumbnail images of the photos stored in your camera. The images are downloaded in the order that they were taken and are displayed in the image selection window. You can change the downloading order by clicking on the blank thumbnail frames for the photos you want to see first.

Note:

If the camera is not connected properly, the Setup menu will appear instead of the Camera menu. Check the serial port settings of your computer to confirm the settings are appropriate and the port is working. See page 55 for more information on using the Setup menu.

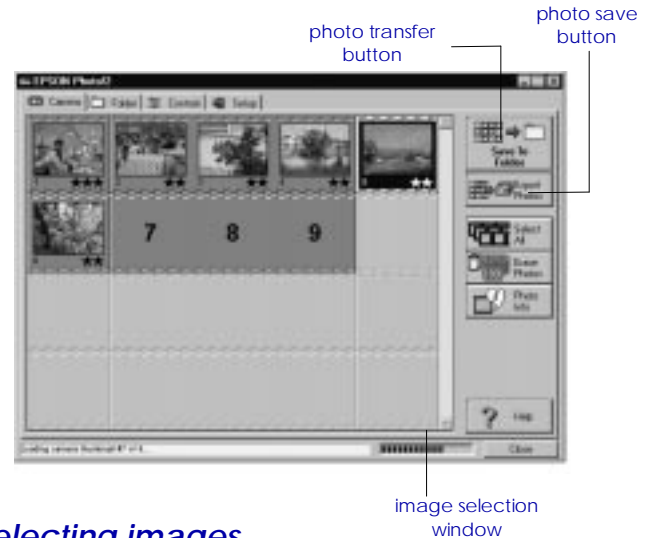

Selecting images



You can use the Select All button to select all the photos in your camera at once, or you can select individual photos by clicking the thumbnail images in the image selection window. Blue borders appear around selected images. You can click the Select All button even while EPSON Photo!2 is still downloading your images, so they appear in the image selection window pre-selected and ready to be transferred to your application or to a folder.

You can select individual photos or groups of photos in a number of ways depending on your system, as described in this table:

	Windows	Macintosh
Selecting a single thumbnail	Click	Click
Selecting multiple thumbnails	CTRL + click	COMMAND + click
Selecting a continuous range of thumbnails	Click the first image in the range. Then SHIFT + click the last image in the range.	Click the first image in the range. Then SHIFT + click the last image in the range.
Cancelling the selection of a single thumbnail in a selected group	CTRL + click	COMMAND + click



Transferring selected photos

The name and function of the photo transfer button located in the top right corner of the Camera menu varies depending on whether EPSON Photo!2 is opened directly, or from a TWAIN- or OLE2-compliant application program. The following table describes the characteristics of the photo transfer button depending on how EPSON Photo!2 is opened.

	TWAIN	OLE	Stand Alone
Button Name	Get Photos 	Get Photo 	Save To Folder 
Button Function	Transfers selected photos from the camera to your application.	Transfers a selected photo from the camera to your application.	Displays a dialog box that allows you to save selected photos as EPSON Photo files in JPEG format.
Notes	Some TWAIN applications will only accept one image at a time.	Only one image can be transferred at a time.	File names are created automatically.

Saving selected photos to a folder

The name and function of the photo save button located below the photo transfer button on the Camera menu varies depending on whether EPSON Photo!2 is opened directly, or from a TWAIN- or OLE2-compliant application program. The following table describes the characteristics of the photo save button depending on how EPSON Photo!2 is opened.

	TWAIN	OLE	Stand Alone
Button Name	Save To Folder 	Save To Folder 	Export Photos 
Button Function	Displays a dialog box that allows you to save selected photos as EPSON Photo files in JPEG format.	Displays a dialog box that allows you to save selected photos as EPSON Photo files in JPEG format.	Displays a dialog box that allows you to name and save photos in JPEG, BMP, or PCX format. On the Macintosh the PICT format is also supported.
Notes	File names are created automatically.	File names are created automatically.	If you assign a single file name to more than one photo, a counter is added to each file sharing the same name.

File names

When you transfer a picture to your computer using the Save To Folder button, EPSON Photo!2 saves it as an EPSON Photo file in JPEG format, and names it with the date and order in which it was taken.

When you transfer a picture to your computer using the Export Photos button, you can name the file yourself and save it as a JPEG, BMP, or PCX file. On the Macintosh you can also choose the PICT file format.

Transferring pictures to your documents

After you select pictures in the image selection window, you can insert them in your documents. You can use your pictures in many different types of application programs, such as word processors, presentation programs, spreadsheets, database managers, page layout and desktop publishing packages.

If your application supports OLE2 or TWAIN, EPSON Photo!2 allows you to directly transfer your photos from your camera to your document. If your application does not support OLE2 or TWAIN, you need to save your photos as JPEG, BMP, or PCX files, and then open them from your application. On the Macintosh, you can also save photos as PICT files.

Inserting photos directly into documents

You can use two methods to add pictures directly to your documents:

- ❑ Photo transfer button
- ❑ Drag and drop (Windows only)

Transferring pictures with the photo transfer button

You can use this method to transfer pictures to Windows applications supporting OLE2 (object linking and embedding), or Windows and Macintosh applications supporting TWAIN. Some examples of applications supporting OLE2 are Microsoft Word 6.0 & 7.0 and WordPerfect® 6.1. Some examples of applications supporting TWAIN are HotShots, Photoshop, PicturePublisher and Photostyler.

If you are not sure whether your application supports OLE2 or TWAIN, give it a try. If it does not work, you can always insert the photo by first saving it in EPSON Photo!2 as a JPEG, BMP, or PCX file and opening it from your application. On the Macintosh, you can also save the photo as a PICT file.

Following is a typical procedure for directly transferring a photo to an OLE2- or TWAIN-compliant application:

1. Start your word processor or other application.
2. Open the document or file where you want to use the picture.
3. Position the cursor where you want to insert the picture.
4. For OLE2-compliant applications, choose Object from the Insert menu and double-click EPSON PhotoPC 600 Object in the Object Type list box.

For TWAIN-compliant applications, select EPSON PhotoPC 600 (or PhotoPC 600 for Macintosh) as the TWAIN data source, then acquire the image.

Note:

The exact method for accessing EPSON Photo!2 varies depending on the application. Please refer to your software manual for detailed instructions.

5. Select the picture you want use. Then click the photo transfer button. A copy of the picture appears in your document.

Transferring a picture with drag and drop (Windows only)

You can use this method to transfer a picture to any Windows application supporting OLE2 (object linking and embedding).

1. Make sure EPSON Photo!2 is open and the picture you want to use is in the image selection window.
2. Start your word processor or other application.
3. Open the document or file where you want to use the picture.
4. Arrange your screen so that both the application window and the EPSON Photo!2 window can be seen.
5. Select the picture you want to use.
6. Drag the picture from the image selection window to your document. After a few seconds you see the drop cursor. If your application does not support drag and drop, the drop cursor will not appear.
7. Position the drop cursor where you want the picture and release the mouse button. A copy of the picture appears in your document.

Inserting a picture by importing

If your application program does not support OLE2 or TWAIN, you need to export your photos to a folder, and open them from your application. If your application cannot handle JPEG files, you need to change the picture's file type to BMP or PCX. (On the Macintosh, you can also change the file type to PICT.) Follow these steps to insert a picture by importing:

1. Open EPSON Photo!2 by clicking its icon.
2. Select the picture you want to use in the image selection window.
3. Click the Export Photos button. A dialog box appears in which you can select a folder, specify a file name, select a file format, and save the photos.
4. Start your application.
5. Open the document or file where you want to use the picture.
6. Position the cursor where you want to insert the picture.
7. Choose the Insert Picture or Import File command. The command may have a different name in your application. It may appear on the File menu, the Insert menu, or another menu.

After you choose the command, you see a box where you can enter the file name of your picture or choose from a list of files.

8. Enter the file name or use the list to locate and select your picture.
9. Click OK. The picture appears in your document.

Erasing selected pictures from your camera

You can use the Camera menu's Erase Photos button to erase selected images from your camera, as described below:

1. Select the images you want to erase.
2. Click the Erase Photos button. A dialog box appears asking you to confirm that you want to erase these photos.
3. Click Yes. The image you selected are erased.

If any of the photos are locked, a dialog box appears asking you whether you want to leave the photos in your camera or erase them. Click Yes to leave the photos in your camera, or click No to erase them.

Getting photo information

The thumbnail images in the image selection window are quite small and you may have problems seeing what is actually in the picture. Click the Photo Info button on the Camera menu to see a double-size view of a selected thumbnail image along with the date, time, image quality setting, and zoom rate, as well as the flash ⚡, macro 🌸, and lock 🔒 symbols when applicable.

You can also get this enlarged view by clicking the image with the right mouse button when running Windows, or on a Macintosh by clicking the image while the control key is pressed. The Photo Info button is disabled when multiple images are selected.

Using the Folder Menu

When you click the Folder menu, the Folder menu opens and thumbnails of images in the currently selected folder appear in the image selection window. The name of the currently selected folder is displayed below the image selection window.

The images displayed in the Folder menu's image selection window can be transferred to your application using the methods described on page 51.

The only differences between the Folder menu and the Camera menu are that the Folder menu does not have a photo save button, and does have a Browse button and an Upload Photos button. The Browse button allows you to select the folder containing the image files you want to display in the image selection window. The Upload Photos button allows you to upload images saved in EPSON Photo file format from your computer to your camera.





Selecting images

Click on an image in the image selection window to select it. The border around an image turns blue when it is selected. Click the Select All button to select all the photos at once.

You can use the same methods to select multiple images on the Folder menu as you can on the Camera menu. See page 44 for details.

Transferring photos

As on the Camera menu, the name and function of the Folder menu's photo transfer button varies depending how you open your EPSON Photo!2 software. See the table on the next page for a summary.

	TWAIN	OLE	Stand Alone
Button Name	Get Photos 	Get Photo 	Export Photos 
Button Function	Transfers selected photos to your application.	Transfers a selected photo to your application.	Displays a dialog box that allows you to name and save photos in JPEG, BMP, or PCX format. On the Macintosh the PICT format is also supported.
Notes	Some TWAIN applications will only accept one image at a time.	Only one image can be transferred at a time.	If you assign a single file name to more than one photo, a counter is added to each file sharing the same name.

Finding the folder containing your photos

Click the Browse button to open a dialog box that allows you to locate the folder containing the images you downloaded from your PhotoPC 600. Select the folder where you stored the photos and click OK.

Uploading photos

Click the Upload Photos button to upload selected photos to the camera or to an optional CompactFlash memory card installed in your computer. When you click this button, the following dialog box appears.



Uploaded images are added to the camera or the memory card in the order they appear in the Folder menu's image selection window.

Note:

Image files that were not originally downloaded from the camera using the Save To Folder button or were not converted to EPSON Photo file format using the EPSON Photo File Uploader utility cannot be uploaded using this button. For instructions on using this utility to convert files to EPSON Photo file format, see "Uploading Images to the Camera" on page 70.

Transferring pictures to your documents

After you select pictures in the Folder menu's image selection window, you can insert them in your documents. You can use your pictures in many different types of application programs, such as word processors, presentation programs, spreadsheets, database managers, page layout and desktop publishing packages.

If your application supports OLE2 or TWAIN, you can directly transfer your photos. If it does not, you need to save your photos in a file format your application can use, and open the file from the application.



You can use the same methods to transfer and insert your photos as described in the Camera menu section on page 45. However, from the Folder menu, images are not transferred from your camera but from the folder where you downloaded the images.

Erasing selected files from a folder

Click the Erase Files button to erase selected pictures from a folder. A dialog box appears asking you to confirm that you want to erase these pictures.

If any of the photos are locked, a dialog box appears asking you whether you want to leave the photos in your camera or erase them. Click Yes to leave the photos in your camera, or click No to erase them.

Getting photo information

The thumbnail images in the image selection window are quite small and you may have problems seeing what is actually in the picture. Click the Photo Info button to see a double-size view of a selected thumbnail image along with the date, time, image quality setting, and zoom rate, as well as the flash , macro , and lock  symbols when applicable.

You can also get this enlarged view by clicking the image with the right mouse button when running Windows, or on a Macintosh by clicking the image while the control key is pressed. The Photo Info button is disabled when multiple images are selected.

Using the Controls Menu

When you click the Controls tab, the Controls menu appears. The Controls menu allows you to see a live preview on your computer screen, take photos from your computer, and change the camera settings. When your camera is not connected to the computer, this menu is not accessible.



Controlling the camera from your computer

The Control Options box contains a display panel and settings that correspond to the control buttons on the top of your camera. You can change camera settings by using the controls in this box, just as you would use the control buttons on the top of the camera. When the camera is connected to the computer, the only control you can use on the camera itself is the power switch.

The display panel in this box and the display panel on the camera are updated whenever the image quality setting, flash mode, or picture count changes.

The auto shut-off feature remains in effect when the camera is connected to your computer (except when you use live preview). However, it takes place after 5 minutes of inactivity. Any action you take with the camera via EPSON Photo!2, for example clicking the Start button, will wake the camera up. Or you can close and open the lens cover again to turn the camera back on.

Selecting the image quality setting

Use the arrow beside the Mode list to select the following settings:

- Standard (640 x 480 pixels)
- Fine (1024 x 768 pixels)
- Super Fine (1024 x 768 pixels)
- Monochrome Fine (1024 x 768 pixels)
- Monochrome Super Fine (1024 x 768 pixels)

You can switch freely between these settings and mix pictures of varying image quality in the camera. Keep in mind that the camera's picture capacity will vary accordingly. See page 28 for more information on the image quality settings.

Selecting the flash mode

You can use the arrow beside the Flash list to select the following settings:

- Off
- Automatic
- Forced

See page 29 for more details on the flash modes.

Setting the self timer

Click the Self Timer check box to activate the self timer. See page 29 for more information on using the self timer.

Selecting macro mode

Click the Macro check box to select macro mode. See page 30 for details on the macro mode.

Taking pictures from your computer

When the camera is connected to your computer, you can take pictures and use PhotoPC 600 features through the EPSON Photo!2 software on your computer. The only control you can use on the camera itself is the power switch.

When you take pictures from your computer, you can use the camera's viewfinder to set up your shot, or you can see a live preview of the shot on your computer screen before you capture it. This live preview feature works something like a video camera, except that the image moves more slowly. See the next section for details on using the live preview feature.

Displaying a live preview on your screen

Position the camera facing the subject. Using a tripod will give you maximum flexibility in setting up your shots. Click the Start button in the Live Preview box on the Controls menu to display your image in the Live Preview window. To stop the live preview, click the Stop button in the Live Preview box, or select another menu tab.

Note:

- ❑ *Using the live preview feature uses a lot of battery power. Use of the optional AC adapter is recommended. See page 83 for more information about using the AC adapter.*
- ❑ *You cannot turn off the camera when you are using live preview. Click the Stop button in the Live Preview box on the Controls menu to turn off the live preview feature, and then turn off the camera.*

Setting the auto-stop timer

You can move or tilt the camera until you see the image you want to capture in the window. EPSON Photo!2 updates the live preview image every few seconds for the amount of time specified in the Auto-Stop Timer list. The settings available for the auto-stop timer are:

- 30 Seconds
- 1 Minute (default value)
- 3 Minutes
- 5 Minutes

Clicking the shutter

To take a picture from your computer, simply click the Take a Picture button on the Controls menu. The status light beside the viewfinder on your camera flashes red and the camera beeps. When the light stops flashing and turns green, the image is saved and you can shoot another picture.

Erasing photos

To erase the last picture you took, click the Erase Last button.

To erase all the photos in your camera, click the Erase All button.

Using the Setup Menu

When you click the Setup tab, the Setup menu appears. The Setup menu allows you to change computer connection settings and to make other camera settings, such as the date and time.



Making computer connection settings

You can change settings for communication between your computer and camera with the Port and Speed options. You can also test the connection and establish communication by clicking the Test Connection button. Connection information appears in the Computer Connection window.

Note:

Do not change the Port and Speed settings from Auto unless you know the configuration of the serial port you want to use. If you change the Port and Speed settings, you may lose the connection between the camera and your computer.

Computer Connection window

The window in the Computer Connection box displays the current status of the camera and its connection to the computer. If there is a problem with the connection, EPSON Photo!2 provides information in this window to help you solve the problem.

Note:

If you get an error message in the Computer Connection window:

1. Make sure that both Port and Speed are set to Auto.

2. *Make sure that the cable is connected correctly, as described on page 36.*
3. *Make sure the camera is turned on and the batteries have enough power.*
4. *Make sure the serial port to which you connected the camera is enabled and properly configured on your computer.*
5. *Click the Test Connection button to confirm the connection between your camera and the computer.*

Test Connection button

Click the Test Connection button to update information on the camera's status and its connection to the computer. This information appears in the Computer Connection window.

Port

The Port option allows you to change the communication port that is connected to the camera. When Auto is selected, EPSON Photo!2 automatically selects the port that is connected to the camera. If the port is changed, EPSON Photo!2 tests the connection and reports the results in the Computer Connection window.

The port choices for Windows are Auto, COM1, COM2, COM3 and COM4. For Macintosh, the choices are Auto, Modem Port and Printer Port.

Speed

The Speed option allows you to change the speed at which EPSON Photo!2 communicates with the camera. When Auto is selected, EPSON Photo!2 automatically selects the fastest possible communication speed. If the speed is changed, EPSON Photo!2 tests the communication link with the camera and reports the results in the Computer Connection window.

The speed choices for Windows are Auto, 19200, 38400, 57600, and 115200 bps. For Macintosh, the choices are Auto, 19200, 38400, and 57600 bps.

Making camera settings

You can see the camera's internal time and date settings in the Time and Date fields, and you can change these settings with the Set Time button. You can also change the camera's auto shut-off time by clicking the arrow beside the Auto Shut-off Time list. The Camera ID edit box allows you to change the camera's internal identification setting.

Setting the clock

PhotoPC 600 can record the date and time of your pictures automatically. When you transfer the pictures from the camera to your computer, you can see exactly when each shot was taken.

In order to have the time and date recorded, you need to set the camera's clock by using the camera's LCD monitor or by using the Set Time feature described below. The PhotoPC 600 clock will continue to keep time accurately until you replace the batteries. See page 20 for instructions on setting the camera's clock by using the LCD monitor.

Follow these steps to set the camera's clock from your computer:

1. Click the Set Time button. The Set Camera Time and Date dialog box below appears. The way the time and date are displayed in this dialog box depends on the time and date display settings for your computer.



2. Use the arrows to change the time and date. Or you can just click the Copy From Computer button to set your camera to your computer's current date and time.
3. Click OK. EPSON Photo!2 updates the date and time in your camera.

Setting auto shut-off time

PhotoPC 600's power-saving feature automatically shuts off the camera if you wait more than 60 seconds before taking a picture. You can adjust this time period by connecting the camera to your computer. Click the arrow on the Auto Shut-off Time list to change the setting. You can select from 1 to 5 minutes.

Auto shut-off takes place after 5 minutes when the camera is connected to your computer. You cannot change this time period.

Changing the camera ID

If you want to change the name that is used to identify the camera when it is connected to a computer, simply type a new name into the Camera ID edit box.

The camera name appears on the introductory screen when you start EPSON Photo!2 and in the About dialog box.

Chapter 4

Using the LCD Monitor Menus

When the LCD monitor is in Playback mode, you can access the LCD monitor menus, where you can erase selected photos and make a variety of camera and option settings. This chapter explains how, including:

Working with LCD monitor menus

Using the Settings menu

Using the Information menu

Using the Playback Mode menu

Using the Erase Photo menu

Using the Photo Control menu

Using the Slide Show menu

Using the Option menu

Using the Language menu

Working with LCD Monitor Menus



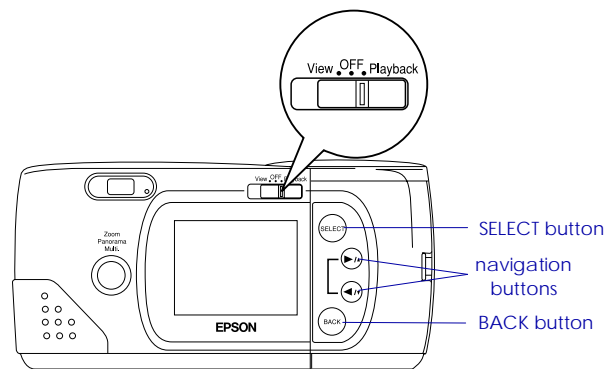

The LCD monitor features eight menus that allow you to delete selected photos from the camera, and to make a variety of camera and option settings. You can open all of the menus described in this chapter from the monitor's Playback mode. The Settings and Information menus can also be accessed from the View mode. By pressing the SELECT, BACK, and navigation buttons as described in this chapter, you can access and make settings on each menu.



Following are the eight LCD monitor menus:

Settings
 See page 60

You can change the following settings:

-  clock
-  alert beep
-  LCD brightness
-  multi-frame shooting time



Information
 See page 62

You can choose whether or not to have photo information displayed on the LCD screen by switching between ON and OFF .



Playback Mode
 See page 62

You can choose to display a single photo or 9 photos at a time by switching between Normal and Multi.



Erase Photo
 See page 63

This menu allows you to erase the currently displayed photo.



Photo control
 See page 63

This menu allows you to do the following:

- erase photos
- lock photos
- get memory information
- copy images
- format memory cards



Slide Show
 See page 68

This menu let you play back all the photos in your camera one-by-one automatically.



Option Menu
 See page 68

This menu allows you to install, use, and delete optional programs available for use with your camera.



Language
 See page 69

Depending on the country, you can choose one of the following languages for displaying information on the LCD screen:

- English, Japanese,
- French, German,
- Italian, Portuguese,
- or Spanish



Follow these steps to access the LCD monitor menus:

1. Slide the monitor mode switch to Playback, then press the SELECT button. Menu icons appear at the top of the LCD screen with the currently selected menu framed in orange. The settings for this menu are displayed on the screen.
2. Press the ►/▲ and ◀/▼ buttons to view the settings for other menus. The orange frame indicates the currently selected menu.

Note:

To exit the LCD monitor menus, press the BACK button until the menu icons and settings disappear. (Depending on the menu, you may have to press this button several times to return to the Playback mode.)

Read the following menu descriptions for instructions on changing the settings for each menu.

Using the Settings Menu



The Settings menu allows you to change settings for the camera's internal clock, the alert beep, the LCD brightness level, and the shooting time for the multi-frame photo format. (See page 30 for details on the multi-frame photo format).

You can also access the Settings menu from the LCD monitor's View mode.

Follow the instructions below for the settings you want to change.

Setting the clock



Follow these steps to adjust the date (year, month, day) and the time (hour and minute).

1. With the Settings menu selected, press the SELECT button. Icons for each setting appear on the screen, with the clock icon ⌚ highlighted in orange.
2. Press SELECT again to enter the clock setting mode.
3. Press the SELECT button until the item you want to adjust is selected. The selected item turns red.

4. Press the ►/▲ button to increase the number, or the ◀/▼ button to decrease the number, until the item you want to adjust is correct.
5. Repeat steps 3 and 4 until the date and time are correctly adjusted and saved. Press the SELECT button or BACK button to return to the Settings menu.

Note:

You need to reset the time and date whenever you replace the camera's batteries. In this case, you can enter the clock setting mode directly rather than going through the Settings menu. See page 20 for instructions.

Setting the alert beep

 To turn the camera's alert beep on or off, follow these steps:

1. With the Settings menu selected, press the SELECT button. Icons for each setting appear on the screen, with the clock icon ☰ highlighted in orange.
2. Press the ◀/▼ button to select the beep setting icon ; then press the SELECT button to select ON or OFF. The current selection is highlighted.

3. Press the BACK button to save your setting and return to the Settings menu.

Setting LCD brightness



To adjust the brightness of the LCD screen, follow the steps below:

1. With the Settings menu selected, press the SELECT button. Icons for each setting appear on the screen, with the clock icon ☰ highlighted in orange.
2. Press the button until the brightness icon  is highlighted in orange, then press the SELECT button again. The mark on the brightness setting slide bar turns orange.





3. Slide the mark on the bar by press the ►/▲ and ◀/▼ buttons to adjust the screen brightness.
4. Press the SELECT or BACK button to save your setting and return to the Settings menu.

Setting the multi-frame shooting time



Follow these steps to set the total time the camera takes to shoot nine frames in multi-frame photo format.

1. With the Settings menu selected, press the SELECT button. Icons for each setting appear on the screen, with the clock icon  highlighted in orange.
2. Press the  button until the multi-frame icon  is highlighted. Then press the SELECT button to select 0.5, 1, 2, or 3 seconds as the total shooting time. The current selection is highlighted.
3. Press the BACK button to save your setting and return to the Settings menu.

Using the Information Menu



On this menu you can choose whether or not to have photo information displayed on the LCD screen. Choosing ON for this setting allows you to get information on the date and time that the photo was taken, the image quality setting, frame number, and the number of photos taken.

The current setting is highlighted. To change the setting, press the SELECT button. Then press the BACK button to save your setting.



This menu is also accessible when the LCD monitor is in View mode. In this case, choosing ON allows you to get information on the image quality setting, the number of photos you can take, and the number of photos taken.

Using the Playback Mode Menu



This menu allows you to switch between Normal and Multi-photo Playback modes. Press SELECT to make your setting, and press BACK to save your setting and exit this menu.

If you switch to Multi-photo Playback mode, small "thumbnail" images of the last photos you took appear on the screen, with the currently selected image framed in white.

Press the  and  buttons to move the white selection frame forward and back through the images on screen. When the frame reaches the first or last photo of the current group, the previous or next group of up to nine images is displayed.

Using the Erase Photo Menu



This menu allows you to erase the currently displayed image. Before accessing the LCD monitor menus, make sure the photo you want to erase is displayed and is not locked. (See page 65 for instructions on locking and unlocking photos.) Then select the Erase Photo menu as described on page 60, and press the SELECT button. A message appears asking you confirm that you want erase the image. Press SELECT again to erase the image, or press BACK to preserve the image and return to the Playback mode.

Note:

If you try to erase a locked photo, a message stating that the photo is locked appears on the screen. Press any of the monitor control buttons to the right of the LCD screen to exit the Erase Photo menu, then open the Photo Control menu and unlock the photo as described on page 65.

Using the Photo Control Menu



You can use the Photo Control menu to erase, lock, or unlock images in your camera and to get information on the camera's internal and CompactFlash card memory. This menu also allows you to format memory cards and copy images between the camera and the card.

Access the LCD monitor menus and select the Photo Control menu as described on page 60, then follow the instructions below for the Photo Control feature you want to use.

Erasing photos

This mode gives you two ways to erase photos from your camera: Select Photo or Erase All. Use Select Photo to erase one or several photos at a time; use Erase All to erase all photos from the camera's memory. Follow the steps below for the method you want to use.

Note:

Be sure to unlock the photos before erasing them. See "Locking photos" on page 65 for instructions.

Select Photo

1. With the Photo Control menu selected, press the SELECT button. The Photo Control features appear on the screen, with the Erase option highlighted in orange.
2. Press the SELECT button to enter the Erase mode, then press the ►/▲ or ◀/▼ button to choose Select Photo.
3. Press the SELECT button, then press the ►/▲ or ◀/▼ button to move forward or back through the images in the camera until the photo you want to erase appears on the screen.
4. Press the SELECT button. An orange frame appears around the image. If you want to erase other photos at the same time, use the ►/▲ or ◀/▼ button to display them, then press the SELECT button to select them.

Note:

- ❑ *To cancel the selection of a photo, simply press the SELECT button again.*
 - ❑ *If you select a locked photo, the camera beeps and you can't select the photo until you unlock it, as described on page 65.*
5. When you have selected all the photos you want to erase, press the BACK button. A message appears asking you to confirm your selections.

6. Press the SELECT button to erase the images and return to the Photo Control menu; press BACK to return to the Photo Control menu without erasing the photos.

Erase All

1. With the Photo Control menu selected, press the SELECT button. The Photo Control features appear on the screen, with the Erase option highlighted in orange.
2. Press the SELECT button to enter the Erase mode, then press the ►/▲ or ◀/▼ button to choose Erase All.
3. Press the SELECT button. A message appears asking you to confirm that you want to erase all photos. Press the SELECT button to erase the photos and return to the Photo Control menu; press the BACK button to return to the Photo Control menu without erasing the photos.

Note:

If there are locked photos in your camera, a message appears on the screen before the erase photos confirmation message. Press the SELECT button to erase only the unlocked images from the camera.

Locking photos

The lock feature allows you keep your photos from being accidentally erased. You can lock and unlock selected photos from the Select Photo menu, or lock all the photos in the camera from the Lock All menu. To unlock all photos, use the Unlock All menu. Follow the steps below for each procedure:

Select Photo

1. With the Photo Control menu selected, press the SELECT button. The Photo Control features appear on the screen, with the Erase option highlighted in orange.
2. Press the $\blacktriangleleft/\blacktriangleright$ button to select the Lock option, then press the SELECT button to enter the Lock mode. Then press the $\blacktriangleright/\blacktriangleleft$ or $\blacktriangleleft/\blacktriangleright$ button to choose Select Photo.
3. Press the SELECT button, then press the $\blacktriangleright/\blacktriangleleft$ or $\blacktriangleleft/\blacktriangleright$ button to move forward or back through the images in the camera until the photo you want to lock or unlock appears on the screen.

4. Press the SELECT button. A lock icon  appears at the bottom of the screen, or disappears if it was locked originally. If you want to lock or unlock other photos at the same time, use the $\blacktriangleright/\blacktriangleleft$ or $\blacktriangleleft/\blacktriangleright$ button to display them, then press the SELECT button.
5. When you have selected all the photos you want to lock or unlock, press the BACK button. A message appears asking you to confirm your selections.
6. Press the SELECT button to lock or unlock the images and return to the Photo Control menu; press BACK to return to the Photo Control menu without locking or unlocking the photos.

Lock All

1. With the Photo Control menu selected, press the SELECT button. The Photo Control features appear on the screen, with the Erase option highlighted in orange.
2. Press the $\blacktriangleleft/\blacktriangleright$ button to select the Lock option, then press the SELECT button to enter the Lock mode. Then press the $\blacktriangleright/\blacktriangleleft$ or $\blacktriangleleft/\blacktriangleright$ button to choose Lock All.





3. Press the SELECT button. A message appears asking you to confirm that you want to lock all the photos in the camera. Press the SELECT button to lock the photos and return to the Photo Control menu; Press the BACK button to return to the Photo Control menu without locking the photos.

Unlock All

1. With the Photo Control menu selected, press the SELECT button. The Photo Control features appear on the screen, with the Erase option highlighted in orange.
2. Press the ◀/▼ button until Lock is highlighted in orange. Press the SELECT button to enter the Lock Photos mode, then press the ▶/▲ or ◀/▼ button to choose Unlock All.
3. Press the SELECT button. A message appears asking you to confirm that you want to unlock all the photos in the camera. Press the SELECT button to unlock the photos and return to the Photo Control menu; press the BACK button to return to the Photo Control menu without unlocking the photos.

Getting memory information

This mode allows you to get information on both your camera's internal memory and on optional CompactFlash memory cards.

With the Photo Control menu selected, press the SELECT button. Then press the ◀/▼ button until Memory Info is highlighted. Press the SELECT button. Information on internal and external memory appears, including the number of photos you can take , the number of photos stored in internal memory  and external memory , and the total number of photos that can be stored at the current image quality setting .

Copying photos

When an optional CompactFlash memory card is installed in your camera, you can use the Copy mode to copy photos between the camera's internal memory and the memory card. Follow these steps:

1. Make sure the memory card is installed in the camera.
2. With the Photo Control menu selected, press the ▶/▲ SELECT button. Then press the ◀/▼ button until Copy is highlighted in orange.

3. Press the SELECT button to enter the Copy mode, then press the ►/▲ or ◀/▼ button to select Camera→Card or Card→Camera as the copy destination.
4. Press the SELECT button, then press the ►/▲ or ◀/▼ button to move forward or back through the images in the camera until the photo you want to copy appears on the screen.
5. Press the SELECT button. An orange frame appears around the photo. If you want to copy several photos at the same time, use the ►/▲ or ◀/▼ button to display them and press the SELECT button each time.

Note:

- ❑ *To cancel the selection of a photo, simply press the SELECT button again. The orange frame disappears.*
 - ❑ *If you select more photos than the card or camera can hold, an error message appears.*
6. When you have selected all the photos you want to copy, press the BACK button. A message appears asking you to confirm your selections.
 7. Press the SELECT button to copy the images and return to the Photo Control menu; press BACK to return to the Photo Control menu without copying the photos.

Formatting memory cards

Use this feature to format optional CompactFlash memory cards. Follow these steps:



Caution:

When you format a memory card, all the data on the card is lost, including any locked images.

Note:

EPSON CompactFlash Cards are already formatted when you buy them. You only need to format a card only if you want to erase all the data on the card or if a message on the LCD screen instructs you to do so.

1. Make sure the memory card is installed in the camera.
2. With the Photo Control menu selected, press the ►/▲ SELECT button. Then press the ◀/▼ button until Format Card is highlighted.
3. Press the SELECT button. A message appears stating that all data on the card will be erased and asking you to confirm the procedure. Press the SELECT button again to format the card and return to the Photo Control menu; press the BACK button to return to the Photo Control menu without formatting the card.

Using the Slide Show Menu



This menu allows you to automatically play back all the photos in your camera one-by-one.

Select this menu as described on page 60, then press the SELECT button. The LCD monitor begins playing back the photos in your camera one-at-a-time at regular intervals.

To move forward or back through the photos manually, press the ►/▲ or ◀/▼ button. To pause the slide show at a particular photo, press the SELECT button. The pause icon ■■ and current picture count appear at the bottom of the screen.

To stop the slide show and return to normal Playback mode, press the BACK button.

Using the Option Menu



This menu allows you to install, use, or delete optional programs available for use with your camera.

Access the LCD monitor menus and select the Option menu as described on page 60. The names of any programs already installed in your camera will appear on the menu, along with an Add/Delete command, which you can use to install programs from a memory card or delete programs from your camera.

To use an installed optional program, press the SELECT button then press the ►/▲ or ◀/▼ button to select the optional program you want to use. Press the SELECT button again to open the program.

Use the Add/Delete command to copy a program from a CompactFlash memory card to your camera, or to delete an optional program from your camera. Follow these steps:

Note:

You can also upload optional programs to your camera from your computer. See page 78 for instructions.

1. If there are any photos in the camera's internal memory, transfer the ones you want to your computer or to a CompactFlash Card, then erase all the photos from the camera.



Caution:

If any images are left in the camera's memory when you upload an optional program, the camera may not work properly.

2. Insert the memory card into your camera.

With the Option menu selected, press the SELECT button then press the ►/▲ or ◀/▼ button to select Add/Delete.

2. Press the SELECT button, then use the ►/▲ or ◀/▼ button to select Add or Delete.
3. Press the SELECT button. If you selected Add, the camera starts installing the program. A message appears asking you to confirm that you want to install the program.

If you selected Delete, a list of the programs installed in your camera appears. Use the ►/▲ or ◀/▼ button to choose the program you want to delete, then press the SELECT button. A message appears asking you to confirm that you want to delete the program.

4. Press the SELECT button to install or delete the program and return to the Option menu; press the BACK button to return to the Option menu without installing or deleting the program.

Using the Language Menu



With this menu you can select the language used to display camera information on the LCD screen. Depending on the country, you can choose English, Japanese, French, German, Italian, Portuguese, or Spanish. The current setting is highlighted. To select a different language, press the SELECT button until the language you want is highlighted. Press BACK to return to the Playback mode.

EPSON Photo PC 600 comes with two uploader utility programs that allow you to upload images and optional programs from your computer to your camera. This chapter explains how, including:

Uploading images to the camera

Uploading optional programs

Uploading Images to the Camera

The EPSON Photo File Uploader software included on the CD-ROM that came with your camera allows you to convert any JPEG or BMP image to EPSON Photo file format and upload it to your camera or to a flash memory card.

You can also use this software to make and save “screen captures” of everything displayed on the computer screen. Use this feature to turn any of the documents you create, for example PowerPoint presentations, into image files that you can upload to the camera or to a memory card.

You can upload images in 640 x 480 pixel, 1024 x 768 pixel, or 1024 x 384 pixel sizes.

Note:

EPSON Photo File Uploader automatically converts images from their original size to whichever of these three sizes you choose.

To use EPSON Photo File Uploader, you need to install it in your computer along with the EPSON Photo!2 software. If you have not yet installed these programs, do so now, following the instructions on page 17.

Uploading images from your PC

Follow these steps to upload images to your camera from PCs running Windows 3.1, Windows 95, or Windows NT versions 3.51 or 4.0:

1. Make sure the camera is connected to the computer, and that both the computer and the camera are turned on. Also make sure EPSON Photo!2 is not open and the LCD monitor is turned off.

2. Open your EPSON Photo File Uploader program. The EPSON Photo File Uploader window appears with the Upload To Camera menu displayed.



3. Select a file type from the File Type list. From the Folder list, double-click the folder containing the images you want to upload.

Note:

To upload images from a network drive, you may need to map the drive before opening EPSON Photo File Uploader.

4. Select the images you want to upload in the File Name list. Then click the -> button. If you want to upload all the images in the list at once, simply click the >> button.

The selected files appear in the Selected Files List in the order they will be uploaded. If you want to change your selection, click the <- button to remove selected files or click the << button to remove all the files from the Selected Files list.

If you want to rearrange the uploading order, select the image you want to rearrange, then click the ↑ or ↓ Sort arrows.

5. For each file in the Selected Files List, select an image size from the Image Size box.



During the uploading process, EPSON Photo File Uploader converts your files to EPSON Photo file format with the image sizes you specified.

If you want to save copies of the converted files on your computer, click the Save file to checkbox before uploading the photos. Click Browse, then select the folder where you want to save the files. Click OK. The folder you selected is displayed to the right of the Browse button.

Note:

If you want to preview a selected image and confirm its size, click the *Preview* checkbox.

6. Click the *Start* button. EPSON Photo!2 opens with the *Folder* menu displayed. The images you want to upload appear in the image selection window.
7. Click the *Select All* button to select all the images, or select individual images by clicking the thumbnails in the image selection window.
8. Click the *Upload Photos* button. The *Upload Photos* dialog box appears. Click the *Camera* radio button to upload the images to your camera, or click the *Compact Flash Memory Card* radio button to upload the images to a compact flash card installed in your computer; then click *OK*. The images are uploaded to the destination you selected.

If you clicked the *Save file to* checkbox in the EPSON Photo File Uploader window, the converted images are also saved to the folder you specified.

Uploading images from your Macintosh

Follow these steps to upload images to your camera from your Macintosh:

1. Make sure the camera is connected to the computer, and that both the computer and the camera are turned on. Also make sure EPSON Photo!2 is not open and the LCD monitor is turned off.
2. Double-click the EPSON Photo File Uploader icon. The EPSON Photo File Uploader window appears.



3. Click the Add button. The Select Files dialog box appears. Double-click the folder containing the images you want to upload, then select each file you want to upload and click the Select button.

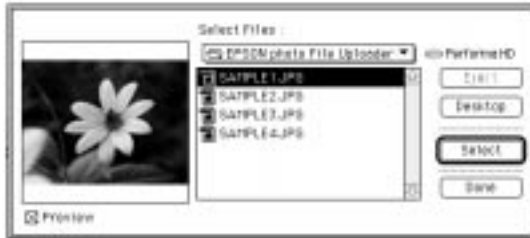

When you finish selecting image files, click Done to close the Select Files dialog box. The selected images appear in the Selected Files List in the order they will be uploaded.

If you want to remove files from this list, select the files and click the Remove button.

4. For each file in the Selected Files List, select an image size from the Image Size box.



During the uploading process, EPSON Photo File Uploader converts your files to EPSON Photo file format with the image sizes you specified.

If you want to save copies of the converted files on your computer, click the Save file to checkbox before uploading the photos. Click Browse, then select the folder where you want to save the files. Click OK. The folder you selected is displayed to the right of the Browse button.

Note:

If you want to preview a selected image and confirm its size, click the Preview checkbox.

5. Click the Upload button. EPSON Photo!2 opens with the Folder menu displayed. The images you want to upload appear in the image selection window.
6. Click the Select All button to select all the images, or select individual images by clicking the thumbnails in the image selection window.
7. Click the Upload Photos button. The Upload Photos dialog box appears. Click the Camera radio button to upload the images to your camera, or click the Flash Memory Card radio button to upload the images to a flash memory card installed in your Macintosh; then click OK. The images are uploaded to the destination you selected.

If you clicked the Save file to checkbox in the EPSON Photo File Uploader window, the converted images are also saved to the folder you selected.

Making Screen Copies

If you want to upload a document to your camera that is not saved as a standard image file, you can turn the document into an image file by making a copy, or "screen capture," of your computer desktop with the document open on it. Windows users can make screen captures from within the EPSON Photo File Uploader utility; Macintosh users need to use the standard Macintosh screen shot function.

For Windows users

Follow these steps to make screen captures:

1. Make sure the camera is connected to the computer, and that both the computer and the camera are turned on. Also make sure EPSON Photo!2 is not open and the LCD monitor is turned off.
2. Open your EPSON Photo File Uploader program. The EPSON Photo File Uploader window appears.

3. Click the Screen Capture menu tab. The Screen Capture menu appears.



4. From the Folder list, double-click the folder where you want to save the screen capture.

If you need to create a new folder for the images, click the New Folder button.

Note:

To select a folder located on a network drive, you may need to map the drive before opening EPSON Photo File Uploader.

5. Specify the key combination you want to use for screen captures using the Hot Key Settings box. Click the ALT, CTRL, or SHIFT checkbox, then select a key from the hot key list. The default hot key is the F5 key.
6. Click Start to register the key combination. When the key combination is registered, the Start button will change to a Stop button. The key combination remains registered only for the current session. Pressing the Stop button erases the hot key combination.
7. Start your application and open the file you want to capture, then press the hot key combination you selected.

You can make as many screen captures as you'd like; simply open each file you want to capture and press your screen capture key combination again.

Note:

File names are created automatically.

8. When you are finished making screen captures, close your application and click the Stop button in the Screen Capture menu. The key combination you selected is erased.

If you want to upload your screen captures to the camera right away, click the Upload To Camera menu tab. The screen capture files appear in the File Name list. Follow the uploading directions from step 4 on page 72 to upload the screen captures.

For Macintosh users

EPSON Photo File Uploader for the Macintosh does not have a screen shot feature. However, you can make screen shots using your Macintosh system software, then use EPSON Photo File Uploader to upload the screen shots to your camera.

The instructions below are representative of many Macintosh computers, but the procedure may be different depending on your Macintosh. See your computer manual for detailed instructions on making screen shots.

Follow these steps to make screen shots of your Macintosh desktop:

1. Make sure the camera is connected to the computer, and that both the computer and the camera are turned on. Also make sure EPSON Photo!2 is not open and the LCD monitor is turned off.

2. Open the EPSON Photo!2 folder and double-click the EPSON Photo File Uploader icon. The EPSON Photo File Uploader window appears.
3. Start your application and open the file you want to capture, then press SHIFT+COMMAND+3 on your computer keyboard. Your Macintosh names and saves the screen shot on your hard drive.

You can make as many screen shots as you'd like; simply repeat this step.

4. When you are finished making screen shots, close your application.

To upload your screen shots to the camera, click the EPSON Photo File Uploader window to make it active, then follow the uploading instructions from step 3 on page 74.

Uploading Programs to the Camera

The EPSON Photo!2 Program Uploader utility allows you to upload up to five optional programs from your PC or Macintosh to your PhotoPC 600.

Note:

- ❑ *When you install your EPSON Photo!2 software, EPSON Photo!2 Program Uploader is installed automatically.*
- ❑ *When uploading optional programs, the number of pictures you can store in your camera's internal memory decreases.*
- ❑ *You can also upload optional programs from CompactFlash memory cards. See page 68 for instructions.*

Uploading programs

Follow these steps to upload optional programs to the camera:

1. Make sure the camera is connected to the computer, and that both the computer and camera are turned on. Also make sure that EPSON Photo!2 is not open and the LCD monitor is turned off.
2. If there are any photos in the camera's internal memory, transfer the ones you want to your computer or to a CompactFlash Card, then erase all the photos from the camera.



Caution:

If any images are left in the camera's memory when you upload an optional program, the camera may not work properly.

3. Click or double-click the EPSON Photo!2 Program Uploader icon in the EPSON Photo!2 program group or folder. The EPSON Photo!2 Program Uploader window appears.

Note:

If the camera is not connected to the computer, an error dialog box appears. Check the cable connections and make sure the camera is turned on. If necessary, adjust the communication port and speed settings in this dialog box.

4. Click the Browse button to select the folder that contains the programs you want to upload.
5. Select the programs you want to upload from the Applications in Folder list.
6. Click the Upload button. EPSON Photo!2 Program Uploader begins uploading the selected programs.

When the uploading process is finished, the uploaded programs appear in the Applications in Camera list.

Now you can use the programs in your camera. See page 68 for instructions on opening the programs.

Removing programs

Follow these steps to remove optional programs from the camera:

Note:

You can also remove programs by using the Option menu in the camera's LCD monitor menus. See page 68 for instructions.

1. Make sure the camera is connected to the computer, and that both the computer and camera are turned on. Also make sure that EPSON Photo!2 is not open and the LCD monitor is turned off.

2. Click or double-click the EPSON Photo!2 Program Uploader icon in the EPSON Photo!2 program group or folder. The EPSON Photo!2 Program Uploader window appears.

Note:

If the camera is not connected to the computer, an error dialog box appears instead of the confirmation message. Check the cable connections and make sure the camera is turned on. If necessary, adjust the communication port and speed settings in this dialog box.

3. Click the programs you want to remove in the Applications in Camera list.
4. Click the Remove button. A confirmation message appears.
5. Click OK. The selected programs are removed from the camera and from the Applications in Camera list.

Chapter 6

Camera Options

A variety of options are available that expand the flexibility of your PhotoPC 600. Optional CompactFlash Cards allows you to increase the camera's storage capacity. If you use the optional PCMCIA adapter, you can access images stored on CompactFlash Cards directly from your computer. The optional AC Adapter helps you save battery power, particularly when previewing and transferring pictures to your computer. This chapter describes the following:

Using optional CompactFlash Cards

Using the optional PCMCIA adapter

Using the AC Adapter

Using CompactFlash Memory Cards

PhotoPC 600 comes with 4MB of internal memory, which holds up to approximately 8 super fine quality pictures (1024 x 768 pixels), approximately 18 fine quality pictures (1024 x 768 pixels), or approximately 56 standard quality pictures (640 x 480 pixels). You can increase the camera's storage capacity as described in the following table by installing an optional 4MB (B808311) or 15MB (B808301) CompactFlash Card:

	4MB Internal Memory	4MB CompactFlash Card	15MB CompactFlash Card
Standard	56	63	238
Fine	18	21	79
Super fine	8	9	35

Note:

EPSON recommends use of EPSON CompactFlash Cards only. Other memory cards may be incompatible with the EPSON PhotoPC 600.

Also, if your computer is equipped with a Type II PCMCIA memory card slot, you can access images stored on memory cards directly from your computer by using the optional PCMCIA adapter (B867041).

Installing a CompactFlash Card

Follow these steps to install a memory card in the camera:

1. Make sure the camera and the monitor mode switch are turned off.
2. Insert the card all the way into the memory card slot, as shown below.

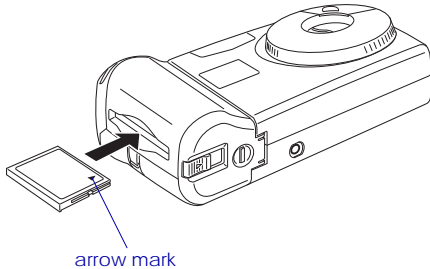

3. Loop the card slot cover string around the hand strap holder.

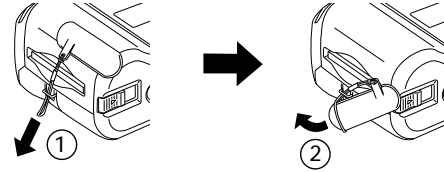

4. Align the tabs on the back of the cover with the installed memory card, as shown below.

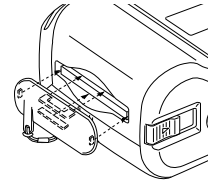

5. Press the cover onto the memory card so that the memory card slot is completely sealed.

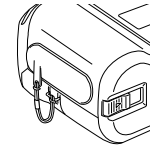

Note:

Always attach the card slot cover to your camera when you use optional CompactFlash Cards.

When a memory card is installed, photos you take are stored in the card's memory rather than the camera's internal memory. The number of pictures you can store in the memory card appears in brackets on the camera's display panel.



When a memory card is installed, you may notice a delay between the time you press the shutter button and when the camera beeps. To avoid blurring, make sure to hold the camera still until the camera beeps.



Caution:

Never remove the card while the camera is accessing it. Data in the card may be lost or damaged.

Removing a CompactFlash Card

Follow these steps to remove a memory card from the camera:

1. Make sure the camera and the monitor mode switch are turned off.
2. Remove the card slot cover.

3. Slide the lever on the bottom of the camera to eject the memory card.
4. Remove it by hand.

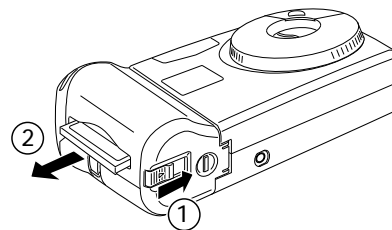

Caution:

- ❑ *Never remove the card while the camera is accessing it. Data in the card may be lost or damaged.*
- ❑ *Avoid using or storing the card in dusty places, in direct sunlight, or in places that become extremely hot or humid.*

Using the optional PCMCIA adapter

The optional PCMCIA adapter allows you to access images stored on CompactFlash Cards directly from your computer. To use this adapter, your computer must be equipped with a Type II PCMCIA memory card slot.

Macintosh users must enable the PC Exchange extension software to access files on CompactFlash Cards. See your Macintosh user's manual for more information.

Follow these steps to use the optional adapter:

1. Insert the memory card into the optional adapter all the way, as shown below.

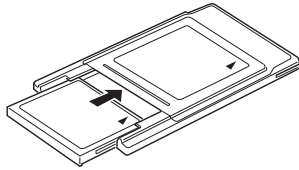

2. Insert the adapter into your computer's Type II PCMCIA slot.

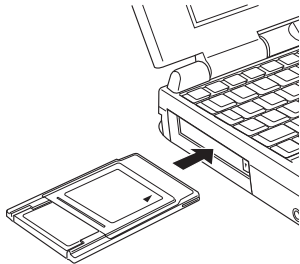

Now you can access the photos in the memory card from your computer.

Using the AC Adapter

The AC Adapter (B86703*) allows you to connect your PhotoPC 600 to a standard electrical outlet. This is especially useful when you are transferring pictures and operating the camera from your computer. The adapter powers the camera, but does not charge the batteries. In some locations the AC adapter comes with a separate AC power cable.

Note:

The asterisk in the product number (B86703) is a substitute for the last digit, which varies by country.*



Warning:

Use only the AC adapter designed for PhotoPC 600. Use of any other adapter could cause fire, electrical shock, or injury. Do not use the AC power cable and the adapter for any purpose other than powering your PhotoPC 600. If the AC plug doesn't fit your outlet, have a proper outlet installed by a qualified electrician. To avoid radiation danger, do not expose or remove the ferrite core.

To avoid losing any images or settings, make sure the camera is finished processing and is turned off before you connect or disconnect the AC adapter. Then follow these steps:

1. If your AC adapter has a separate AC power cable, push the cable connector firmly into the AC inlet.

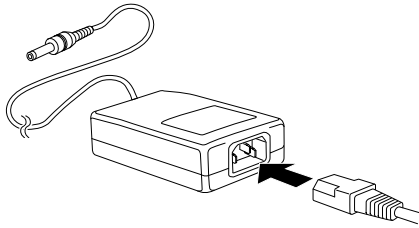

2. Open the connector cover located on the side of the camera.

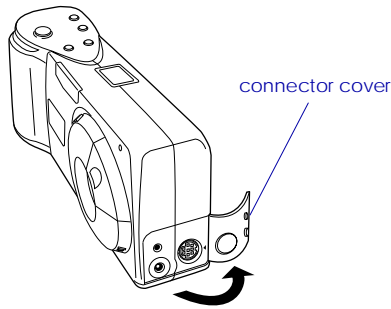

3. Plug the adapter cable into the DC port on the camera.

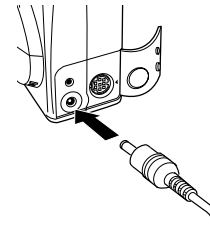

4. Plug the AC adapter into an electrical outlet.



Caution:

Place the camera and the AC adapter near an electrical outlet where the plug can be easily unplugged.

Note for French-speaking users:

Placez l'appareil photographique et ses options près d'une prise de courant où la prise peut être débranchée facilement.

Avoid electrical outlets controlled by wall switches or automatic timers. Also, avoid outlets on the same circuit as large motors or other appliances that can cause fluctuations in line voltage.

For United Kingdom users - safety information



Warning:

This appliance must be earthed. Refer to rating plate for voltage and check that the appliance voltage corresponds to the supply voltage.

IMPORTANT:

The wires in the mains lead fitted to this appliance are coloured in accordance with the following code:

Green and yellow - Earth

Blue - Neutral

Brown - Live

If you have to fit a plug:

As the colours of the mains lead of this appliance may not match coloured markings used to identify the terminals in a plug, please proceed as follows:

The green and yellow wire must be connected to the terminal in the plug which is marked with the letter E or the Earth symbol (\perp).

The blue wire must be connected to the terminal in the plug marked with the letter N.

The brown wire must be connected to the terminal in the plug marked with the letter L.

If damage occurs to the plug, replace the cord set or consult a qualified electrician.

Replace fuses only with a fuse of the correct size and rating.

Chapter 7

Maintenance and Troubleshooting

Your PhotoPC 600 is easy to take care of, and any problems you may have are easy to solve.

See the following section for guidance on cleaning the camera. For solutions to common camera problems, see the section beginning on page 87.

Caring for the Camera

Your PhotoPC 600 camera requires only the most basic care. Before you do any maintenance procedures on the camera, be sure to read the Safety Instructions in the Introduction. Then follow these guidelines:

Caution

Handle the camera gently and avoid subjecting it to strong shocks or vibrations. If the camera is dropped or otherwise jarred, the following errors may occur even if the camera is not permanently damaged.

- ❑ The camera's date and time settings may be lost.

- ❑ If the camera is jarred while processing an image, the camera may fail to record the image in its memory.

Cleaning the camera

- ❑ Use a clean, dry cloth to keep the camera free of dust.
- ❑ Do not use harsh or abrasive cleaners.
- ❑ To clean the lens, first blow off any loose dust or dirt. Then breathe on the lens and wipe off all moisture with a soft, lint-free cloth or lens cleaning tissue.
- ❑ To avoid scratching the lens, be careful not to press too hard.
- ❑ If necessary, clean the battery contacts with a dry cloth.

Storing the camera

- ❑ Make sure the camera's power is off and keep your camera in its case when you are not using it.

- ❑ When the camera is not used for long period of time, remove the batteries and store them at a low temperature in a dry location. This prevents camera damage from battery leaks or corrosion.

Do not store the camera in the following locations:

- ❑ Where it will be exposed to direct sunlight, for example, on a car dashboard
- ❑ Near sources of bright light or high humidity
- ❑ Near heat sources or in a closed car
- ❑ In areas of excessive dirt or dust
- ❑ Where it will be exposed to strong vibrations or magnetic fields

Camera Problems

Before you call for help, check this list of problems and possible solutions.

The camera has no power.

Make sure the lens cover is open all the way. The power comes on automatically when the lens cover is opened fully.

The camera may have shut off automatically. Close and open the lens cover to turn the power back on.

Check the batteries and make sure they are installed correctly. Replace the batteries if necessary, following the instructions on page 15.

If you are using the AC adapter, make sure it is plugged into a working outlet.

You cannot take a picture with the camera.

The flash may be recharging. Wait until the status light beside the viewfinder turns green, and try again.

The camera may be connected to your computer. When it is connected, you cannot use any of the controls on the camera itself. See page 53 for instructions on taking pictures from your computer.

The camera's memory may be full. Check the picture counter on the display panel. Erase some pictures using the LCD monitor, or transfer the pictures to your computer and then erase them.

Note:

- ❑ *To use the LCD monitor to delete pictures, see page 63.*
- ❑ *To use your computer to transfer and erase pictures, see page 44.*

- ❑ *Installing an optional CompactFlash Card allows you to take more pictures without deleting any images currently in the camera. See page 80 for details.*

The flash does not work.

Make sure the flash is set to Automatic or Forced Flash. See page 29 for more information on setting the flash.

Check the batteries and make sure they are installed correctly. Replace the batteries if necessary, following the instructions on page 15.

Nothing appears on the LCD screen in View mode.

Make sure the power is on. It comes on automatically when the lens cover is opened fully.

Check the batteries and make sure they are installed correctly. Replace the batteries if necessary, following the instructions on page 15.

Nothing appears on the LCD screen in Playback mode.

Check the batteries and make sure they are installed correctly. Replace the batteries if necessary, following the instructions on page 15.

The image on the LCD monitor screen is too dark, or is not visible at all.

Adjust the the brightness of the LCD screen if necessary, following the instructions on page 61.

The EPSON Photo!2 Setup menu appears instead of the Camera menu when you connect the camera to your computer and open EPSON Photo!2.

Make sure the cable is connected correctly, as described on page 36.

Make sure the camera is turned on and the batteries have enough power.

Check the serial port settings on the Setup menu of your EPSON Photo!2 software. You may need to change the Port and Speed serial connection settings to Auto.

Make sure the port to which your camera is connected is properly configured and that the Base I/O port address and the Interrupt Request Number (IRQ) assigned to the port are not in conflict with other devices.

If you are a Macintosh user and the camera is sharing a serial port with another device, make sure AppleTalk is turned off.

An error message appears when you are using EPSON Photo!2 with the camera connected to the computer.

Make sure the cable is connected correctly, as described on page 36.

Make sure the camera is turned on and the batteries have enough power.

Check the serial port settings on the Setup menu of your EPSON Photo!2 software. You may need to change the Port and Speed serial connection settings to Auto.

Avoid opening or working with applications unrelated to the photo transfer process while the camera and computer are communicating.

Note:

When the camera and computer are communicating, star icons move across the camera's display panel.

Nothing appears on the TV monitor when the camera is connected to your television.

Make sure the video cable is connected correctly, as described on page 34.

Make sure the LCD monitor is switched to the Playback mode.

Make sure the television is switched to the video mode.

Make sure the camera's batteries have enough power.

Your camera may not be compatible with local television broadcasting standards. Cameras purchased in countries using the NTSC standard can only be used with NTSC televisions, and cameras purchased in countries conforming to the PAL standard can only be used with PAL televisions.

Note:

Also check your television user's manual for possible solutions.

You cannot take a picture with the camera when an optional CompactFlash Card is installed.

Check your camera's LCD monitor for messages. If you get a message indicating that you need to format or eject the card, follow the instructions.

Your card's memory may be full. Check the picture counter on the display panel. If the card is full, change to another card, erase some pictures using the LCD monitor, or transfer the pictures to your computer and then erase them.

Picture Problems

If you are not satisfied with the pictures you get from PhotoPC 600, you may need to adjust some of the camera settings. Or maybe you need to brush up on your photography techniques. Read the suggestions listed below and give them a try.

Your pictures display poor image quality on the screen or when you print them out.

PhotoPC 600 captures images in 24-bit color (16 million colors). Your pictures will not display maximum image quality if your monitor or your computer's video controller does not support this color depth. You may need to upgrade your system to achieve the best possible image quality.

If your pictures look better on the screen than when you print them out, you may need to upgrade your printer. An EPSON color ink jet printer, for example, will provide excellent image quality.

Your picture is blurry or out of focus.

Make sure your subject is within the camera's range. You should be at least 50 cm away to take a picture without the flash, and 20 cm to 2.4 m away to take a picture with the flash. You can take a picture as close as 20 cm in macro mode.

Make sure the subject is not moving.

Be careful to hold the camera steady while the image is being captured.

Make sure your flash is not set to Flash Off.

Your picture is too dark (underexposed).

You may need to use the flash. Set the flash to Automatic or Forced Flash, following the instructions on page 29.

If you are using the flash, make sure your subject is within the range of 20 cm to 2.4 m.

Use an image-editing program to adjust the picture's brightness and contrast.

If you are using macro mode to take a close-up photo, make sure to provide adequate lighting for your subject, since the camera's aperture is automatically set to its smallest setting when in this mode.

Your picture is too light (overexposed).

If you are using the forced flash setting, it may be too bright. Try setting the flash to Automatic. See page 29.

If you are facing a bright light source, you may need to shoot your picture from a different angle.

Use an image-editing program to adjust the picture's brightness and contrast.

Part of your picture is missing.

Make sure you are not blocking the lens with your finger, hand strap, clothing, or other object.

A horizontal or vertical red line appears on your picture.

Red lines are caused by glare. Avoid photographing very shiny surfaces that reflect a glare of light into your lens.

The wrong date and/or time are displayed on your camera.

Whenever you change batteries in the camera you need to reset the clock. See page 60 to use the LCD monitor to set the clock, or see page 57 to set the clock from your computer.

If the camera has been subjected to a strong shock or vibration the camera's date and time settings may be lost.

The colors in your picture do not look right.

When you take pictures under certain artificial lighting conditions, the colors may be slightly distorted. You can use image-editing software to adjust the colors.

Your pictures do not look as good as they used to.

Your camera's lens may be dirty or dusty. Try cleaning it following the instructions on page 86.

The area captured in the photo is different from what you saw in the viewfinder.

Take care to look straight through the viewfinder. When taking photos in macro mode, we recommend you to use the LCD monitor rather than the viewfinder to frame your subject.

Keep in mind that the area visible through the viewfinder is slightly smaller than the area captured in the actual photo.

Chapter 8

Using the Direct Print Kit

The Direct Print Kit is software and a cable which allow you to print images directly from your PhotoPC 600 on an EPSON Stylus Photo inkjet printer.

The software includes the following features:

- ❑ Color, monochrome, blue, and sepia printing
- ❑ Standard, Album, Index (contact sheet), and Sticker printing modes

This chapter explains how to print directly from your PhotoPC 600, including:

Preparing to Use the Direct Print Kit

Connecting Your Camera to the Printer

Paper Types

Using the Direct Print Kit

LCD Screen and Display Panel Messages

Printed Image Dimensions

Preparing to Use the Direct Print Kit

You need the following items to use the Direct Print Kit.

Digital camera: EPSON PhotoPC 600

Printer: EPSON Stylus Photo

Printer cable: Apple System Peripheral-8 cable
(8-pin mini-circular connector)

Note:

We also recommend using the optional AC adapter (B86703) to make sure that the batteries do not run out while printing.*

Before you can print directly from your camera, you need to upload the Direct Print Kit software to your PhotoPC 600. See page 78 for instructions on how to upload programs to the camera.

Connecting Your Camera to the Printer

Follow these steps to connect the camera to the EPSON Stylus Photo printer.

1. Make sure that both the camera and the printer are turned off.
2. Connect one end of the interface cable to the serial connector on the back of the printer.

Note:

Use the Apple System Peripheral-8 cable (8-pin mini-circular connector) cable. Do not use the PC connection cable or Macintosh adapter cable that also came with the camera.

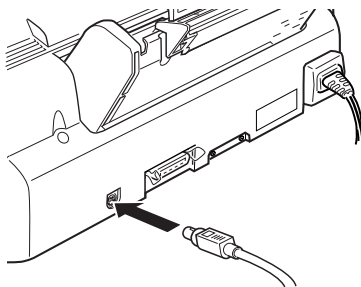

3. Open the connector cover on the side of the camera.

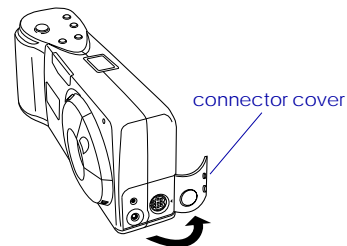

4. Depending on the type of serial cable you have, line up either the arrow or the flat surface of the cable connector with the mark on the camera's serial port. Then insert the connector.



Caution:

Be sure to position the cable correctly before pushing it into the connector. Otherwise, the cable's pins may be damaged.

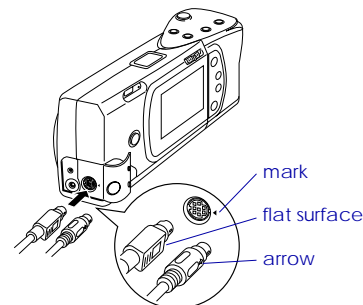

Paper Types

You can use any of the paper types listed below.

Photo Quality Ink Jet Paper

Use this paper for standard photo quality printing.

EPSON Photo Quality Ink Jet Paper (A4)	S041061
	S041026
EPSON Photo Quality Ink Jet Card (A6)	S041054
EPSON Photo Quality Ink Jet Paper (Letter)	S041062

Photo Quality Glossy Paper

Use this paper for photo quality glossy prints.

EPSON Photo Quality Glossy Paper (A4)	S041126
EPSON Photo Quality Glossy Paper (Letter)	S041124
EPSON Photo Paper (4 × 6 in.)	S041134

Photo Quality Glossy Film

Use glossy film to get high gloss photo quality images.

EPSON Photo Quality Glossy Film (A4)	S041071
EPSON Photo Quality Glossy Film (A6)	S041107
EPSON Photo Quality Glossy Film (Letter)	S041072
EPSON Photo Stickers (A6)	S041144

Note:

- ❑ The availability of special media varies by country.
- ❑ Ink jet printers are particularly sensitive to the condition of your paper. Keep unused paper in its original packaging and store it in a cool, dark place.

Using the Direct Print Kit

Once you have uploaded the Direct Print software to your camera, follow the instructions in this section to access the software and print out images.

Accessing the Direct Print program

1. Slide the monitor mode switch on your camera to Playback.
2. Press the SELECT button on the back of the camera. Menu icons appear at the top of the LCD screen with the currently selected menu highlighted in orange.
3. Press the ►/▲ or ◀/▼ button until the Option menu is highlighted, then press the SELECT button.
4. Press the ►/▲ or ◀/▼ button until Direct Print is highlighted. Then press the SELECT button to display the Direct Print modes.

To print, see the instructions in the next section for the print mode you want to use.

Printing your images

The Direct Print Kit features the following print modes:

- ❑ Standard
The Standard Print mode allows you to print a single image on each sheet. In this mode you can select the paper size and type, layout (printing position), color, number of copies, and whether to print the time and date that the photo was taken. See page 96 for instructions on printing with this mode.
- ❑ Album
Lets you to print up to three images on A4 or letter size paper, or up to two images on A6 size paper. The options in this mode allow you to select the paper size and type, and whether to print the time and date that the photo was taken. See page 97 for instructions on printing with this mode.
- ❑ Index (contact sheet)
The index Print mode allows you to print A4, Letter, or A6 size contact sheets consisting of small “thumbnail” images of all the photos in your camera. In this mode you can select the paper size and type, and whether to print the date that the photos were taken. See page 98 for instructions on printing with this mode.

❑ Sticker

The Sticker Print mode allows you to print on EPSON Photo Stickers. This mode prints 16 small copies of the image you select onto each Photo Sticker sheet. See page 99 for instructions on printing with this mode.

To print, access the Direct Print program as described on page 95, then follow the instructions below for the print mode you want to use.

Standard Print mode

Follow these steps to print using the Standard Print mode:

1. Access the Direct Print program as described on page 95, then press the ►/▲ or ◀/▼ button to highlight Standard Print. Press the SELECT button. Thumbnail images of the first nine photos in your camera appear with the currently selected image framed in blue.
2. Press the ►/▲ or ◀/▼ button until the image you want to print is framed in blue.

To see an enlarged view of a selected image, press the photo format button to the left of the LCD screen. To return to the thumbnail view, press any button on the camera.

3. After selecting an image, press the SELECT button. The Standard Print options and current settings appear on the screen.
4. To change a setting, press the ►/▲ or ◀/▼ button to select the option you want to change, then press the SELECT button. The settings for that option appear on the screen.
5. Press the ►/▲ or ◀/▼ button to select a setting, then press the SELECT button.

Note:

The settings available for some options depend on the type of image selected. For example, A4 and Letter paper size settings are only available for panorama photos.

6. Connect the camera to the printer as described on page 93, then turn on the printer and load the size and type of paper you selected. For paper loading instructions, see your printer *User's Guide*.
7. When you are ready to start printing, press the ►/▲ or ◀/▼ button to select Print.
8. Press the SELECT button. The camera starts sending the image data to the printer.



While the camera is sending data, the LCD screen goes blank and star icons move across the display panel on the top of the camera. When printing starts, the display panel returns to normal.

Note:

To cancel printing, hold down the camera's BACK button for about three seconds. A message stating that printing is canceled appears on the LCD screen for five seconds, then the screen returns to the Direct Print menu. The printer stops printing and ejects the paper.

9. When printing is finished, the LCD screen returns to the Direct Print menu. When you finish printing, close the Direct Print program by pressing the BACK button. Then slide the monitor mode switch to OFF and turn off the printer.

Album Print mode

Follow these steps to print using the Album Print mode:

1. Access the Direct Print program as described on page 95, then press the $\blacktriangleright/\wedge$ or \blacktriangleleft/\vee button to highlight Album Print. Press the SELECT button. Thumbnail images of the first nine photos in your camera appear with the currently selected image framed in blue.

2. Press the $\blacktriangleright/\wedge$ or \blacktriangleleft/\vee button until the first image in the series you want to print is framed in blue. Then press the SELECT button.

To see an enlarged view of a selected image, press the photo format button to the left of the LCD screen. To return to the thumbnail view, press any button on the camera.

3. Press the $\blacktriangleright/\wedge$ or \blacktriangleleft/\vee button to select the last image in the series you want to print, then press the SELECT button. The Album Print options and current settings appear on the screen.

Note:

You can print up to three images on an A4 or letter size sheet, or up to two images on an A6 size sheet.

4. To change a setting, press the $\blacktriangleright/\wedge$ or \blacktriangleleft/\vee button to select the option you want to change, then press the SELECT button. The settings for that option appear on the screen.
5. Press the $\blacktriangleright/\wedge$ or \blacktriangleleft/\vee button to select a setting, then press the SELECT button.

6. Connect the camera to the printer as described on page 93, then turn on the printer and load the size and type of paper you selected. If a message telling you how many sheets to load appears at the bottom of the Album Print options screen, be sure to load at least that many sheets. For paper loading instructions, see your printer *User's Guide*.
7. When you are ready to start printing, press the ►/▲ or ◀/▼ button to select Print.
8. Press the SELECT button. The camera starts sending the image data to the printer.

While the camera is sending data, the LCD screen goes blank and star icons move across the display panel on the top of the camera. When printing starts, the display panel returns to normal.

Note:

To cancel printing, hold down the camera's BACK button for about three seconds. A message stating that printing is canceled appears on the LCD screen for five seconds, then the screen returns to the Direct Print menu. The printer stops printing and ejects the paper.

9. When printing is finished, the LCD screen again displays thumbnail images of the photos in your camera in Album Print mode.

To print a new group of photos, follow these instructions from step 2. To finish printing, close the Direct Print program by pressing the BACK button. Then slide the monitor mode switch to OFF and turn off the printer.

Index Print mode

Follow these steps to print using the Index Print mode:

1. Access the Direct Print program as described on page 95, then press the ►/▲ or ◀/▼ button to highlight Index Print. Press the SELECT button. Thumbnail images of the first nine photos in your camera appear with the currently selected image framed in blue.
2. Press the ►/▲ or ◀/▼ button until the first image in the series you want to print is framed in blue. Then press the SELECT button.

To see an enlarged view of a selected image, press the photo format button to the left of the LCD screen. To return to the thumbnail view, press any button on the camera.

3. Press the ►/▲ or ◀/▼ button to select the last image in the series you want to print, then press the SELECT button. The Index Print options and current settings appear on the screen.

4. To change a setting, press the ►/▲ or ◀/▼ button to select the option you want to change, then press the SELECT button. The settings for that option appear on the screen.
5. Press the ►/▲ or ◀/▼ button to select a setting, then press the SELECT button.
6. Connect the camera to the printer as described on page 93, then turn on the printer and load the size and type of paper you selected. If a message telling you how many sheets to load appears at the bottom of the Album Print options screen, be sure to load at least that many sheets. For paper loading instructions, see your printer *User's Guide*.
7. When you are ready to start printing, press the ►/▲ or ◀/▼ button to select Print.
8. Press the SELECT button. The camera starts sending the image data to the printer.

While the camera is sending data, the LCD screen goes blank and star icons move across the display panel on the top of the camera. When printing starts, the display panel returns to normal.

Note:

To cancel printing, hold down the camera's BACK button for about three seconds. A message stating that printing is canceled appears on the LCD screen for five seconds, then the screen returns to the Direct Print menu. The printer stops printing and ejects the paper.

9. When printing is finished, the LCD screen returns to the Direct Print menu.

When you finish printing, close the Direct Print program by pressing the BACK button. Then slide the monitor mode switch to OFF and turn off the printer.

Sticker Print mode

Follow these steps to print using the Sticker Print mode:

1. Access the Direct Print program as described on page 95, then press the ►/▲ or ◀/▼ button to highlight Sticker Print. Press the SELECT button. Thumbnail images of the first nine photos in your camera appear with the currently selected image framed in blue.
2. Press the ►/▲ or ◀/▼ or button until the image you want to print is framed in blue.



To see an enlarged view of a selected image, press the photo format button to the left of the LCD screen. To return to the thumbnail view, press any button on the camera.

3. After selecting an image, press the SELECT button. The Print option appears on the screen.
4. Connect the camera to the printer as described on page 93, then turn on the printer and load EPSON Photo Stickers. See the loading instructions that came with the PhotoStickers.
5. When you are ready to start printing, press the SELECT button. The camera starts sending the image data to the printer.

While the camera is sending data, the LCD screen goes blank and star icons move across the display panel on the top of the camera. When printing starts, the display panel returns to normal.

Note:

To cancel printing, hold down the camera's BACK button for about three seconds. A message stating that printing is canceled appears on the LCD screen for five seconds, then the screen returns to the Direct Print menu. The printer stops printing and ejects the paper.

6. When printing is finished, the LCD screen returns to the Direct Print menu.

When you finish printing, close the Direct Print program by pressing the BACK button. Then slide the monitor mode switch to OFF and turn off the printer.

LCD Screen and Display Panel Messages

When printing with the Direct Print Kit, a variety of status messages may appear on the camera's LCD screen and display panel. For detailed explanations of these messages, see the following tables.

LCD screen messages

Message	Explanation
Check Printer Model. Print: SELECT Cancel: BACK	The camera is not connected to an EPSON Stylus Photo printer. Connect the camera to an EPSON Stylus Photo printer, then press the SELECT button to begin printing. (If you want to cancel printing, press the BACK button.)
Battery is low. Use AC adapter.	Battery power is almost out. Connect the camera to the optional AC adapter.
Check Printer Connection or Printer Error.	Printing stopped because of a printer error. Clear the error, then start printing again from the beginning. (For information about how to handle printer errors, refer to your printer User's Guide.)
Printing Canceled	This message appears when you hold down the BACK button for more than 3 seconds while printing. The printer stops printing and ejects the paper.

Display panel messages

Message	Explanation
E51: Another interface is active	The printer is receiving a print job through another interface. When the print job ends, the printer begins printing from the Direct Print Kit automatically.
E55: No ink	Printing stopped because the printer ran out of ink. Replace the ink cartridges as needed and start printing again from the beginning. (For information about how to replace ink cartridges, refer to your printer User's Guide.)
E56: No paper	Load paper into the printer, and then press the printer's (⏏) load/eject button to begin printing. (Or press the camera's BACK button to cancel printing.)

Printed Image Dimensions

Standard Print mode

Layout setting	Paper Size setting	Image Dimensions
Framed Photo	A6	108 × 81 mm
Top, Center, Bottom	A6/Photo Paper	72 × 54 mm
Photo Print	Photo Paper	157 × 106 mm
Panorama	A4/Letter	252 × 93 mm
	A6/Photo Paper	108 × 40 mm

Album Print mode

A4/Letter: 108 × 81 mm
A6: 72 × 54 mm

Index Print mode

A4/letter/A6: 36 × 27 mm

Sticker Print mode

Photo Stickers: 26 × 19.5 mm



Appendix A

Specifications

Camera

Product type

Type	Digital still AF camera with LCD monitor
CCD	1/3 inch color area CCD (810,000 pixels)
LCD monitor	2-inch color LCD monitor (110,000 pixels)
Internal memory	4MB (record image data, program memory)

Recorded Image

Data type	JPEG (16 million colors, 24 bit)
Image size	1024 x 768 pixels, 1024 x 384 pixels (panorama), 640 x 480 pixels

Image quality modes	Super fine image quality (1024 x 768 pixels, 1024 x 384 pixels) Fine image quality (1024 x 768 pixels, 1024 x 384 pixels) Standard image quality (640 x 480 pixels)
Alternative formats	Monochrome, macro, digital step zoom (zoom rate 1.0 to 3.0 times), panorama, multi-frame

Optical

Lens	f = 5 mm F2.8 (equivalent to a 36 mm lens on a 35 mm camera)
Range	0.5 m to infinity 0.2 m to 0.5 m (macro mode)
Focus	Automatic focus
Sensitivity	Equivalent to ISO 100
Aperture	F2.8, F5.6, F11

Shutter	Electric iris with mechanical shutter 1/4 second to 1/500 second (flash off mode), 1/30 second to 1/500 second (auto flash and forced flash modes)
Exposure control	Program auto expose
White balance	TTL automatic white balance
Viewfinder	Real-image optical
Self timer	10 seconds
Flash	Automatic luminance control flash
Flash modes	Automatic, forced flash, flash off
Flash range	0.2 to 2.4 m

Functional

Storage capacity

	Minimum	Average
Standard	48	53
Fine	16	17
Super fine	6	8
Fine/ monochrome	16	17
Super fine/ monochrome	6	8
Fine/ panorama	32	35
Super fine/ panorama	13	16

Note:

- ❑ *Figures shown here represent storage capacity when optional programs are not installed in the camera's internal memory.*
- ❑ *The number of pictures you can take depends on the complexity of each photo even if the image quality is the same for all the photos.*

Photo processing time (approximate)

	LCD monitor off	LCD monitor on
Standard	7 seconds	11 seconds
Fine	7	11
Super fine	10	14

LCD monitor photo displaying time (approximate)

	Time (seconds)
Standard	3
Fine	6
Super fine	8 ~ 9

Interface

Serial interface	8-pin mini-DIN, RS-232C-compatible special interface for PC, Macintosh and EPSON printers Communications speed: 19.2 Kbps or higher (max 115.2 Kbps)
Video out	NTSC (NTSC model) PAL (PAL model)



Power

Sources 4 AA batteries (single-use alkaline (LR6), single-use lithium (FR6), rechargeable Ni-Cd, or rechargeable Ni-MH)
Optional AC Adapter (B86703*)

Battery life*

LCD monitor off	LCD Monitor on
Approximately 400 pictures	View mode Approximately 30 minutes
	Playback mode Approximately 90 minutes

* AA (LR6) alkaline batteries. Battery life varies depending on the type and manufacturer.

Physical Dimensions

Width 142.5 mm
Height 69.8 mm
Depth 48.8 mm
Weight 280 g (without batteries)
Temperature Operating: 5 to 35°C
Non-operating: -20 to 60°C
Humidity (non-condensing) Operating: 30% to 90%
Non-operating: 10% to 90%

Optional CompactFlash Card

4MB CompactFlash Card (B808311)

Storage capacity 4MB

Physical Dimensions:

Width 42.8 mm

Height 36.8 mm

Depth 3.3 mm

15MB CompactFlash Card (B808301).

Storage capacity 15MB

Physical Dimensions:

Width 42.8 mm

Height 36.8 mm

Depth 3.3 mm



Optional PCMCIA Adapter

Interface	PCMCIA PC Card ATA
Card slot type	Type II
Physical Dimensions:	
Width	54.0 mm
Height	85.6 mm
Depth	5.0 mm

Optional AC Adapter

Model EU-18

Output	DC 7V / 2.0A
Input	AC 110/120V, 50/60 Hz
Physical Dimensions:	
Width	50 mm
Height	30 mm (47 mm including plug)
Depth	95 mm

Model EU-19

Output	DC7V/2.0A
Input	AC 120V, 50/60 Hz
Physical Dimensions:	
Width	50 mm
Height	30 mm (47 mm including plug)
Depth	95 mm

Model EU-20

Output	DC7V/2.0A
Input	AC 127/220/230/240V, 50/60 Hz
Physical Dimensions:	
Width	60 mm
Height	34 mm
Depth	95 mm



Appendix B

Contacting Customer Support

If your camera is not operating properly and you cannot solve the problem using the troubleshooting information in this guide, contact customer support services for assistance.

We will be able to help you much more quickly if you give us the following information:

Serial number of your camera:

(The serial number label is on the underside of the camera.)

Camera model:

Brand and model of your computer:

Camera software version:

(Click the About button in your camera software.)

Windows version (for example, 95 or 3.1) you are using:

Software applications you normally use with your camera and their version numbers:

For United Kingdom and the Republic of Ireland Users

If you purchased your camera in the UK or the Republic of Ireland, Epson (UK) Limited provides a range of customer services and technical support.

Note:

For customers in the Republic of Ireland, please use the correct dialing codes when dialing the UK telephone numbers listed in the following sections. For example the Customer Support telephone number, 01442 227478, should be dialed as 00 44 1442 227478 from the Republic of Ireland.

Customer Support

Our Customer Support team can provide the following services:

- ❑ Technical information on installing, configuring, and operating your EPSON products
- ❑ Arranging for faulty EPSON products to be repaired within the warranty period

The Customer Support team can be contacted by calling 01442 227478 in the UK or 00 44 1442 227478 from the Republic of Ireland.

Faxon EPSON

Contact Faxon EPSON Faxback Service for:

- ❑ Literature and specifications on the latest EPSON products
- ❑ Support information including troubleshooting tips, switch settings and driver information

To use Faxon EPSON, call 01442 227332 using a touch-tone phone. You will be asked to follow a simple routine to register your document request and once you have entered your telephone and fax numbers, Faxon EPSON will fax a copy of the document catalogue to your fax machine.

When you have found the documents that you need in the catalogue, call Faxon EPSON again and enter the document ID numbers. The documents will be faxed to you automatically.

EPtec - Bulletin Board Service for latest drivers and utilities

You can call the EPSON Bulletin Board Service on 01442 227479. No membership is required. Make sure that your communications software is set to 8 data bits, 1 stop bit, no parity bit, ANSI terminal mode emulation and a modem speed of up to 28.8 Kbps. Downloading protocols supported include Xmodem, Ymodem and Zmodem. See the documentation that came with your communications software and modem for more information.

When you first connect to the Bulletin Board Service, you will be asked for your name, company name, phone number and a password (which you can invent yourself).

World Wide Web

If you can connect to the Internet and have a Web browser, you can access EPSON's World Wide Web site at <http://www.epson.com>. Here you will find information on the latest EPSON products, software drivers, and answers to frequently asked questions.

For United States Users

If you purchased your camera in the United States or Canada, EPSON provides customer support and service through a network of authorized EPSON Customer Care Centers. Dial (800) 922-8911 for the nearest location or the following services:

- Fax-on-Demand access to EPSON's technical information library
- Literature on current and new products
- The location of your nearest Authorized EPSON Reseller or Customer Care Center
- Technical information on installation, configuration, and operation of EPSON products
- Customer relations.

For answers to commonly asked questions about EPSON products 24 hours a day, 7 days a week, call EPSON Sound Advice at (800) 442-2110.

You can purchase manuals, accessories, or parts from EPSON Accessories at (800) 873-7766 (U.S. sales only). In Canada, please call (800) 873-7766 for dealer referral.

If you need help using software with an EPSON product, see the documentation for that program for technical support information.

Electronic support services

You can access helpful tips, specifications, DIP switch or jumper settings, drivers, FAQs, sample files, application notes, and EPSON product bulletins 24 hours a day, 7 days a week, using a modem and one of the online services below.

World Wide Web

From the Internet, you can reach EPSON's home page at <http://www.epson.com>

EPSON Internet FTP site

If you have Internet FTP capability, use your Web browser (or other software for FTP downloading) to log onto <ftp.epson.com> with the user name anonymous and your e-mail address as the password.

EPSON Download Service

You can call the EPSON Download Service BBS at (800) 442-2007. Set your communications software to 8 data bits, 1 stop bit, no parity. Modem speed can be up to 28.8 Kbps.

EPSON Fax-on-Demand Service

You can access EPSON's technical information library by calling (800) 442-2110 or (800) 922-8911 and selecting the appropriate phone option. You must provide a return fax number to use Fax-on-Demand.

EPSON Forum on CompuServe®

Members of CompuServe can type GO EPSON at the menu prompt to reach CompuServe's Epson America Forum. As an owner of an EPSON product, you are eligible for a free introductory CompuServe membership, which entitles you to an introductory credit and your own user ID and password. To take advantage of this offer in the U.S. or Canada, call (800) 848-8199 and ask for representative #529.

For Australian Users

EPSON Australia wishes to provide you with a high level of Customer Service. As well as this *User's Guide*, we provide the following sources for obtaining information:

EPSON FAXBACK

EPSON FAXBACK will fax you the latest specifications and pricing for most EPSON products offered in Australia. There is also technical information including details of the latest software and drivers available. Phone (02) 9903 9075 and the system will guide you through a number of choices before faxing the information to your fax machine.

EPSON Bulletin Board System

This is where you can download the latest software and drivers. Visit the BBS to check out the latest versions. If you have a modem, phone (02) 9417 5090.

Internet URL <http://www.epson.com.au>

Access the Epson Australia World Wide Web pages. Worth taking your modem here for the occasional surf! You can get the same information as offered on the EPSON FAXBACK and the EPSON Bulletin Board plus more.

Your dealer

Don't forget that your dealer can often help identify and resolve problems. The dealer should always be the first call for advice on problems. They can often solve problems quickly and easily as well as give you advice on the next step to take.

EPSON Helpdesk

EPSON Helpdesk is provided as a final backup to make sure our clients have access to advice. Operators on the Helpdesk can aid you in diagnosing hardware and software problems. They can also advise you on the latest EPSON products and where the nearest dealer or service agent is located. Many types of queries are answered here.

Access to the Helpdesk is at no charge to purchasers of new products for the first 12 months of that product's life. After that period, a different phone number is used and charges are debited to your telephone account. The current charge rates are specified when you ring the chargeable support number. You are asked to signify your acceptance before any charges are incurred.

The Helpdesk numbers are:

first 12 months	(02) 9903 9040
after 12 months	1 902 263 192
fax number	(02) 9903 9189

We encourage you to have all the relevant information on hand when you ring. The more information you prepare, the faster we can help solve the problem. This information includes the *User's Guide* for your EPSON product, type of computer, operating system, application programs, and any other information you feel is required.

For Hong Kong Users

To obtain technical support as well as other after-sales services, users are welcome to contact EPSON Hong Kong Limited.

Internet home page

EPSON Hong Kong has established a local home page in both Chinese and English on the Internet to provide users with the following information:

- Product information
- Answers to Frequently Asked Questions (FAQs)
- Latest versions of EPSON camera software

Users can access our World Wide Web home page at:
<http://www.epson.com.hk>.

Electronic bulletin board system

An electronic bulletin board system (BBS) is also available to obtain camera information and the latest versions of camera software. You can log on to the following number for the BBS service:

BBS: (852) 2827-4244

Technical Support Hotline

You can also contact our technical staff at the following telephone and fax numbers:

Phone: (852) 2585-4399

Fax: (852) 2827-4383

For Philippines Users

To obtain technical support as well as other after sales services, users are welcome to contact the EPSON Philippines Representative Office at the telephone and fax numbers below:

Phone: (632) 813-6552

Fax: (632) 813-6545

BBS: (632) 814-0595

For Singapore Users

Contact the telephone and fax numbers below:

Phone: (065) 337-7911

Fax: (065) 334-1185

Glossary

application

A software program that helps you carry out a particular task, such as word processing or financial planning.

BMP

A Windows file format for storing image data.

bps (bits per second)

A measure of data transmission speed.

default

A value or setting that takes effect when the equipment is turned on, reset, or initialized.

drag and drop

Method for moving an on-screen object by holding the pointer over the object, pressing and holding the mouse button, dragging the mouse, then releasing the mouse button to drop the object in a new location.

ink jet printer

A printer that transfers ink onto the paper by spraying it through a number of small nozzles.

interface

The connection between the computer and the camera.

JPEG

A file format for storing color and grayscale images in compressed files. Data in JPEG files receives greater compression than TIFF and other formats.

OLE

A way to transfer and share information between Windows-based applications.

PCX

A file format for storing color and grayscale images.

PICT

A file format widely used for Macintosh graphics.

pixel

Short for picture element. Each image is composed of a number of pixels. Pixels are also counted in units of dots.

thumbnails

Small representations of images.

TWAIN

A type of interface protocol that makes input peripherals, such as scanners or digital cameras, easier to access directly from application programs.

Index

A

- AC adapter, 83-85
- Adjusting camera settings
 - flash, 29, 53
 - image quality, 28, 53
 - macro, 30, 53
 - self timer, 29, 53
 - special photo formats, 30
- Attaching the hand strap, 17
- Auto shut-off, 23
 - setting, 57

B

- BACK button, 20, 58
- Batteries
 - handling, 16
 - installing, 15
 - checking, 24
 - life, 105
- Beep, 29
 - setting, 61
- Brightness
 - LCD monitor, 61
 - picture, 91
- Buttons, 13-14

C

- Cables
 - printer, *See Direct Print Kit*
 - serial, 12, 36
 - video, 12, 34
- Camera ID, 57
- Camera
 - buttons, 13-14
 - caring for, 86
 - cleaning, 86
 - getting to know, 13
 - menu, 43
 - parts of, 12
 - problems, 87
 - storage capacity, 28, 1048
- Checking
 - battery, 24
 - picture counter, 32
- Clicking the shutter,
 - from the computer, 54
 - on the camera, 24
- Clock, setting,
 - from the camera, 20
 - from the computer, 57
- CompactFlash Cards, 80
 - formatting, 67
 - installing and removing, 81, 82
 - installing programs from, 68
 - uploading photos to, 50



- Computer connection settings, 55
- Connecting the camera
 - to a Macintosh, 38
 - to a PC, 37
- Controlling the camera from the computer, 52
- Controls menu, 52
- Copying photos, 66
- Customer Support, 107

D

- Date and time, setting
 - from the camera, 20
 - from the computer, 57
- Direct Print Kit, 92-102
 - album printout, 95, 97
 - cable, 92, 93
 - connecting your camera to the printer, 93
 - EPSON Stylus Photo printer, 92, 93, 101
 - error messages, 101
 - index printout (contact sheet), 95, 98
 - LCD screen and display panel messages, 101
 - paper types, 94
 - preparing to use the Direct Print Kit, 92
 - printed image dimensions, 102
 - printing images directly from your camera, 92
 - printing your images, 95-100
 - printout modes, 95-96
 - standard printout, 95, 96
 - sticker printout, 96, 99-100
 - uploading the Direct Print Kit to your camera, 92, 78
 - using the Direct Print Kit, 95

- Displaying photos on a television, 34
- Display panel, 12, 24

E

- EPSON Direct Print Kit, *See Direct Print Kit*
- EPSON Photo!2 Program Uploader, 78
- EPSON Photo!2 software
 - accessing, 40
 - installing, 17
 - using, 41
- EPSON Photo! File Uploader
 - installing, 18
 - making screen copies, 75
 - uploading images, 70
- EPSON Stylus Photo printer, *See Direct Print Kit*
- Erase Photo menu, 63
- Erasing photos
 - from a folder, 51
 - using EPSON Photo!2, 54
 - using the Erase Photo menu, 63
 - using the Photo Control menu, 63
- Error messages when printing, *See Direct Print Kit*

F

- File names, 45
- Finding the folder containing your photos, 50
- Fine image quality setting, 28, 53
- Flash settings, 29, 53
- Folder menu, 48
- Formatting memory cards, 67



G

- Getting memory information, 66
- Getting photo information
 - from the computer, 48
 - from the LCD monitor, 62

H

- Help EPSON Photo!2, 42

I

- Image quality settings, 28, 53
- Image selection window, 43, 48-49
- Information menu, 62
- Inserting a picture by importing, 47
- Installing
 - batteries, 15
 - CompactFlash Cards, 81
 - Direct Print Kit, 92
 - EPSON Photo!2 software, 17
 - EPSON Photo! File Uploader software, 18
 - optional programs in the camera, 68-69, 78-79

L

- Language menu, 69
- Language, setting, 20
- LCD monitor
 - brightness, 61
 - error messages when printing, *See Direct Print Kit*
 - menus, 58-69
 - using to take photos, 25-26

Lights

- status, 13, 25
- timer, 13, 29-30

Live preview

- displaying on computer screen, 54
- displaying on the LCD monitor, 25-26

M

- Macro mode setting, 30, 53
- Making screen copies, 75
- Menus
 - EPSON Photo!2, 42
 - LCD monitor, 59
- Monitor mode switch, 13, 20
- Monochrome image quality settings, 28, 53
- Multi-frame photo format, 30-32
- Multi-frame shooting time, setting, 62
- Multi-photo Playback mode, 62

N

- Navigation buttons, 13, 31, 58

O

- Option menu, 68-69
- Options, 80-85
 - AC adapter, 83-85
 - CompactFlash Cards, 80-82
 - PCMCIA adapter, 82-83

P

- Panorama photo format, 30-32
- PCMCIA adapter, 82-83
- Photo Control menu, 63-67
- Picture
 - counter, 32
 - printing, *See Direct Print Kit*
 - problems, 90-91
 - taking range, 26
- Pictures
 - inserting by importing, 47-48
 - erasing, 48, 51, 54, 63-64
 - taking from the computer, 54
 - transferring from a folder to a document, 51
 - transferring from the camera to a document, 45-46
- Playback mode, 33, 58
- Playback Mode menu, 62
- Playing back photos
 - on the LCD monitor, 33
 - on a television, 34-35
 - using the slide show feature, 68
- Port option, 56
- Ports
 - DC, 84
 - serial, 37-38
 - video, 34
- Power saving features LCD monitor, 23
- Preview option, EPSON Photo File Uploader, 72-79, 74-75
- Printer, *See Direct Print Kit*
- Printing images directly from your camera, *See Direct Print Kit*

Problems

- camera, 87
- printing with Direct Print Kit, *See Direct Print Kit*
- picture, 90-91

Progress meter, 43

S

- Saving selected photos to a folder, 44-45
- Screen Capture menu, 76
- SELECT button, 20-21, 58
- Selecting images, EPSON Photo!2, 43-44, 49
- Self timer, 29-30, 53
- Settings menu, 60-62
- Setup menu, 55-57
- Shutter
 - clicking on the camera, 24-26
 - clicking from the computer, 54
- Slide Show menu, 68
- Special photo formats, 30-32
- Specifications, 103-106
- Speed option, 56
- Standard image quality setting, 28, 53
- Status bar, 42
- Status light, 13, 24-25
- Storage capacity
 - CompactFlash Cards, 80
 - internal memory, 28, 104
- Storing the camera, 86-87
- Stylus Photo printer, *See Direct Print Kit*
- Superfine image quality setting, 28, 53
- Support (contacting customer support), 107



T

- Taking pictures from the computer, 53-54
- Test Connection button, 56
- Transferring
 - pictures from the camera to your documents, 45-48
 - pictures from a folder to your documents, 49-51
- Troubleshooting
 - camera problems, 87-89
 - Direct Print Kit, 92, 101
 - picture problems, 90-91

U

- Unpacking your camera, 12
- Uploading
 - Direct Print Kit, *See Direct Print Kit*
 - images, 50, 70-75
 - programs to the camera, 78-79
- Uploader utilities
 - EPSON Photo!2 Program Uploader, 78-79
 - EPSON Photo File Uploader, 70-77
- Upload Photos button, 50
- Upload To Camera menu, 71

V

- Viewfinder, 13, 24-25
- View mode, 25, 27, 31

Z

- Zoom, 30-32



Using this On-line User's Guide

You should view this document with the follow settings on the toolbar:

- ❑ *Display bookmarks and the page*
- ❑ *Make the page fit inside the window*
- ❑ *Hand tool.*

The diagram and annotations on this page show the main toolbar buttons and document navigation methods to use when viewing this on-line user's guide.

For more information on using documents in Adobe Acrobat, select Acrobat on-line guide or Acrobat tutorial from the Help menu.

Point and Click anywhere on this page to go to the Font Cover contents page.

The screenshot shows the Adobe Acrobat interface with the following annotations:

- Display Bookmarks and the page**: Points to the 'Bookmarks' icon in the toolbar.
- First page**: Points to the 'First Page' icon in the toolbar.
- Previous**: Points to the 'Previous Page' icon in the toolbar.
- Next**: Points to the 'Next Page' icon in the toolbar.
- Last**: Points to the 'Last Page' icon in the toolbar.
- Make the pages fit inside the Window**: Points to the 'Fit Width' icon in the toolbar.
- Selects the hand tool**: Points to the 'Hand' icon in the toolbar.
- Find text**: Points to the 'Find' icon in the toolbar.
- Drag this scroll box up or down to jump to a specific page**: Points to the page navigation scroll bar on the right side of the document.
- Point & Click on these bookmark headings to jump to a section**: Points to the 'Print & Click Here for tips on using the On-line Guide' and 'Important Notice & Declaration of Conformity' links in the document.
- Point & Click on these links to jump to a section**: Points to the 'Print & Click Here for tips on using the On-line Guide' and 'Important Notice & Declaration of Conformity' links in the document.