

Color Ink Jet Printer

EPSON STYLUS™ PHOTO 750

Setup & Daily Use

Safety Instructions	1
Important Safety Instructions	1
A Few Precautions	2
Warnings, Cautions, and Notes	4
Setting Up Your Printer	5
System Requirements	5
Printer Parts and Control Panel Functions	8
Attaching the Paper Support	10
Plugging in the Printer	10
Installing the Ink Cartridges	11
Connecting the Printer to Your PC	15
Installing the Printer Software in Your PC	16
Connecting the Printer to Your Macintosh	18
Installing the Printer Software in Your Macintosh	20
Selecting Your Printer in the Chooser	22
Loading Paper	24
Printing Your First Page for Windows	25
Printing Your First Page for Macintosh	27
Loading Special Paper	30
Replacing Ink Cartridges	32
Maintenance	37
Checking the Print Head Nozzles	37
Cleaning the Print Head	39
Aligning the Print Head	41
Troubleshooting	43
Error Indicators	43
Cancelling Printing	45
Where to Get Help	47
Options and Consumable Products	53

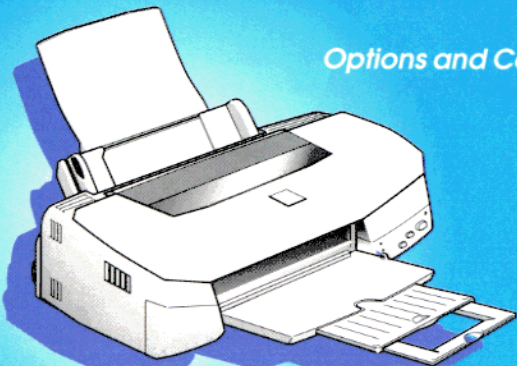

All rights reserved. No part of this publication may be reproduced, stored in a retrieval system, or transmitted in any form or by any means, electronic, mechanical, photocopying, recording, or otherwise, without the prior written permission of SEIKO EPSON CORPORATION. The information contained herein is designed only for use with this EPSON printer. EPSON is not responsible for any use of this information as applied to other printers.

Neither SEIKO EPSON CORPORATION nor its affiliates shall be liable to the purchaser of this product or third parties for damages, losses, costs, or expenses incurred by the purchaser or third parties as a result of: accident, misuse, or abuse of this product or unauthorized modifications, repairs, or alterations to this product, or (excluding the U.S.) failure to strictly comply with SEIKO EPSON CORPORATION's operating and maintenance instructions.

SEIKO EPSON CORPORATION shall not be liable for any damages or problems arising from the use of any options or any consumable products other than those designated as Original EPSON Products or EPSON Approved Products by SEIKO EPSON CORPORATION.

SEIKO EPSON CORPORATION shall not be held liable for any damage resulting from electromagnetic interference that occurs from the use of any interface cables other than EPSON Approved Products by SEIKO EPSON CORPORATION.

EPSON and EPSON ESC/P are registered trademarks and EPSON ESC/P 2, ESC/P Raster and EPSON Stylus are trademarks of SEIKO EPSON CORPORATION.

Microsoft and Windows are registered trademarks of Microsoft Corporation.

General Notice: Other product names used herein are for identification purposes only and may be trademarks of their respective owners. EPSON disclaims any and all rights in those marks.

Copyright © 1999 by SEIKO EPSON CORPORATION, Nagano, Japan.



Printed on Recycled Paper.

Safety Instructions

Important Safety Instructions

Read all of these instructions before using your printer. Also be sure to follow all warnings and instructions marked on the printer.

- ❑ Do not block or cover the openings in the printer's cabinet.
- ❑ Do not insert objects through the slots. Take care not to spill liquid on the printer.
- ❑ Use only the type of power source indicated on the printer's label.
- ❑ Connect all equipment to properly grounded power outlets. Avoid using outlets on the same circuit as photocopiers or air control systems that regularly switch on and off.
- ❑ Avoid electrical outlets controlled by wall switches or automatic timers.
- ❑ Keep the entire computer system away from potential sources of electromagnetic interference, such as loudspeakers or the base units of cordless telephones.
- ❑ Do not use a damaged or frayed power cord.
- ❑ If you use an extension cord with the printer, make sure the total ampere rating of the devices plugged into the extension cord does not exceed the cord's ampere rating. Also, make sure the total ampere rating of all devices plugged into the wall outlet does not exceed the wall outlet's ampere rating.
- ❑ Do not attempt to service the printer yourself.

- ❑ Unplug the printer and refer servicing to qualified service personnel under the following conditions:

The power cord or plug is damaged; liquid has entered the printer; the printer has been dropped or the cabinet damaged; the printer does not operate normally or exhibits a distinct change in performance.



- ❑ If you plan to use the printer in Germany, observe the following:

To provide adequate short-circuit protection and over-current protection for this printer, the building installation must be protected by a 16 Amp circuit breaker.

Bei Anschluß des Druckers an die Stromversorgung muß sichergestellt werden, daß die Gebäudeinstallation mit einem 16 A-Überstromschalter abgesichert ist.

A Few Precautions

When using the printer

- ❑ Do not put your hand inside the printer or touch the ink cartridges during printing.
- ❑ Do not move the print head by hand; otherwise you may damage the printer.
- ❑ Always turn the printer off using the  power button. When this button is pressed, the  power light flashes briefly then goes off. Do not unplug the printer or turn off the power to the outlet until the  power light stops flashing.
- ❑ Before transporting the printer, make sure the print head is in the home (far right) position and the ink cartridges are in place.

When handling the ink cartridges

- ❑ Keep ink cartridges out of the reach of children. Do not allow children to drink or otherwise handle the cartridges.
- ❑ If ink gets on the skin, wash it off with soap and water. If it gets in the eyes, flush them immediately with water.
- ❑ Do not shake an ink cartridge; this can cause leakage.
- ❑ Install the ink cartridge immediately after you remove it from its package. Leaving the cartridge unpacked for a long time before use may result in reduced print quality.
- ❑ Once you install an ink cartridge, do not open the clamp or remove the cartridge except to replace it with a new one. The cartridge may become unusable otherwise.
- ❑ Do not use an ink cartridge beyond the date printed on the cartridge carton. For best results, use up the ink cartridges within six months of installing them.
- ❑ Do not dismantle the ink cartridges or try to refill them. This could damage the print head.

When choosing a place for the printer

- ❑ Place the printer on a flat, stable surface that is larger than the printer. The printer will not operate properly if it is tilted or at an angle.
- ❑ Avoid places subject to rapid changes in temperature and humidity. Also keep it away from direct sunlight, strong light, or heat sources.
- ❑ Avoid places subject to shocks and vibrations.
- ❑ Place the printer near a wall outlet where the plug can be easily unplugged.

Note for French-speaking users:

Placez l'imprimante près d'une prise de contact où la fiche peut être débranchée facilement.

Warnings, Cautions, and Notes



Warnings must be followed carefully to avoid bodily injury.



Cautions must be observed to avoid damage to your equipment.

Notes contain important information and useful tips on the operation of your printer.

Setting Up Your Printer

System Requirements

For PCs

To use your printer, you need Microsoft® Windows® 95, Windows® 98, or Windows® NT 4.0; and a shielded, twisted-pair parallel cable. If you want connect your printer to a USB port, you need a Windows 98 pre-installed PC equipped with a USB port; and a shielded USB cable.

Your computer should also meet the following system requirements:

Minimum system	Recommended system
i486/25 MHz for Windows 95 and NT 4.0 i486/66 MHz for Windows 98	Pentium or higher processor
16MB RAM	32MB RAM or more for Windows 95 and 98 64MB or more for Windows NT 4.0
10MB hard disk space for Windows 95 and 98 20MB for Windows NT 4.0	50MB or more free disk space for Windows 95, and 98 100MB or more for Windows NT 4.0
VGA monitor	VGA or better monitor

Your computer dealer can help you update your system if it does not meet these requirements.

For Macintosh computers

To use this printer, your Apple® Macintosh® must meet the following system requirements. You also need a standard Apple System Peripheral-8 cable (8-pin mini-circular connector) or equivalent.

If you want connect your printer to a USB port, you need an iMac computer with a USB port; and a shielded USB cable.

Applicable computer models (as of September 1, 1998)

Macintosh LC475, LC575, LC630

Macintosh Quadra Series

Macintosh Centris Series

Macintosh PowerBook™ Series (PowerBook 190, 520, 540, 550 or later)

Macintosh PowerBook Duo 280, 2300c/100

Macintosh Performa 475, 575, 588, 630, 5210 or later

Power Macintosh Series

iMac Series (for USB)

Environment

Minimum system	Recommended system
System 7.5.1	System 7.6 or later
5MB of available memory 10MB of available memory when background printing is turned on.	16MB or more of available memory 25MB of available memory when background printing is turned on.

Note:

- ❑ *The amount of available memory varies according to the number and kind of applications that are open. To see how much memory is available, choose About This Macintosh from the Apple menu and refer to the memory size (listed in kilobytes) under “Largest Unused Block” (1,024K=1MB).*





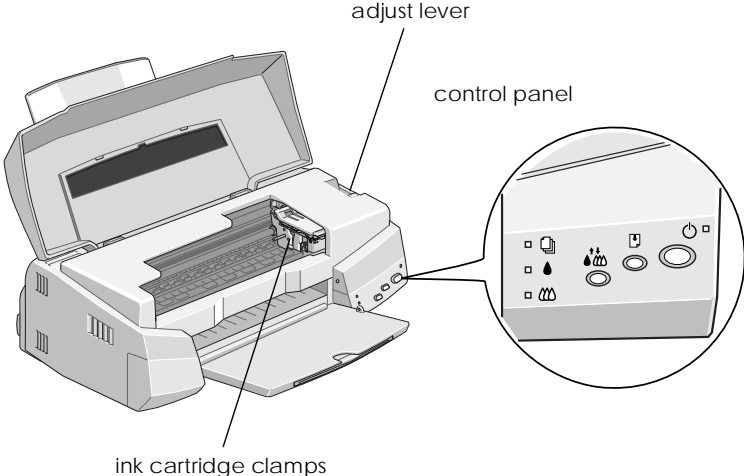
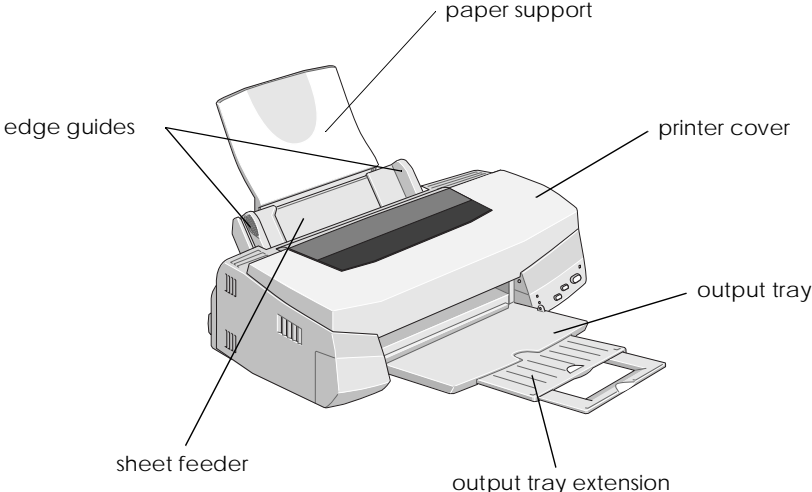

- ❑ *The memory requirements above are for printing on Letter size paper. These requirements may vary depending on the size of the paper, the type of application you are using, and the complexity of the document you want to print.*

In addition to these system and memory requirements, you also need 10MB of free hard disk space to install your printer software. To print, you need extra hard disk space amounting to about double the size of the file you want to print.

















Printer Parts and Control Panel Functions



Buttons

Button	Function
 Power	Turns the printer on and off. Clears the printer's memory if pressed twice while the power is on.
 Load/Eject	Loads or ejects paper if pressed and released within 2 seconds. Resumes printing if pressed and released after a paper out error.
 Cleaning	Moves the print head to the ink cartridge replacement position if pressed for 3 seconds while the  or  ink out light is flashing or on. Returns the print head to its home position after ink cartridge replacement. Performs print head cleaning if pressed for 3 seconds when the  or  ink out light is off.

Lights

Light Status	Printer Status
 	Printer is on.
 	Receiving data, replacing an ink cartridge, charging ink, or cleaning the print head.
 	Paper out. Load paper in the sheet feeder; then press the  load/eject button to resume printing.
 	Paper jam. Take all the paper out of the feeder, and reload the paper. If the light continues to flash, turn off the printer and gently pull all the paper out of the printer.
 	Ink low. The black ink cartridge is nearly empty. Obtain a black ink cartridge (S020187).
 	Ink out. The black ink cartridge is empty. Replace the black ink cartridge (S020187).
 	Ink low. The color ink cartridge is nearly empty. Obtain a color ink cartridge (S020193).
 	Ink out. The color ink cartridge is empty. Replace the color ink cartridge (S020193).

■ = on, □ = flashing

Attaching the Paper Support

Insert the paper support into the slots at the rear of the printer.

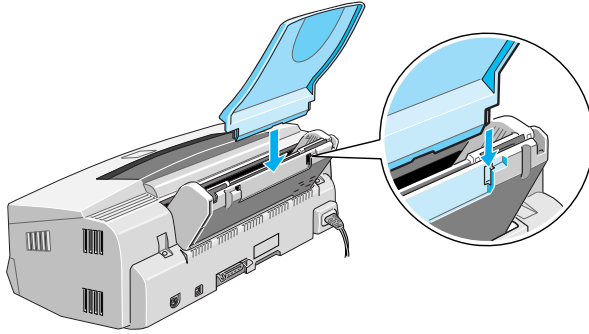

Plugging in the Printer

1. Make sure that the printer is turned off. It is off when the  power button protrudes slightly from the surface of the control panel.
2. Check the label on the back of the printer to make sure the voltage required by the printer matches that of the electrical outlet you will be plugging it into. Also, make sure that you have the correct power cable for your power source.



Caution:

It is not possible to change the printer's voltage. If the rated voltage and your outlet voltage do not match, contact your dealer for assistance. Do not plug in the power cord.

3. If the power cord is not attached to the printer, connect it to the AC inlet on the back of the printer.
4. Plug the power cord into a properly grounded electrical outlet.

Installing the Ink Cartridges

Before installing the ink cartridges, note the following.



Warning:

The ink cartridges are self-contained units. Under ordinary use, ink will not leak from a cartridge. If ink does get on your hands, wash them thoroughly with soap and water. If ink gets into your eyes, flush them immediately with water.

Note:



- ❑ *Do not open the ink cartridge packages until just before you install them, or the ink may dry up.*
- ❑ *Use the ink cartridges packed with your printer the first time you install ink cartridges, otherwise the printer may not charge ink properly.*

Install the ink cartridges as follows:

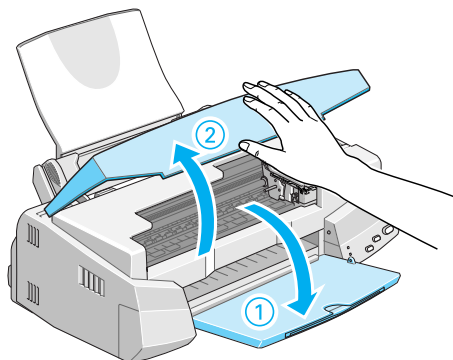
1. Lower the output tray; then open the printer cover.



2. Turn on the printer.

The print head moves slightly to the left, which is the ink cartridge install position. The  power light flashes and the  and  ink out lights come on.

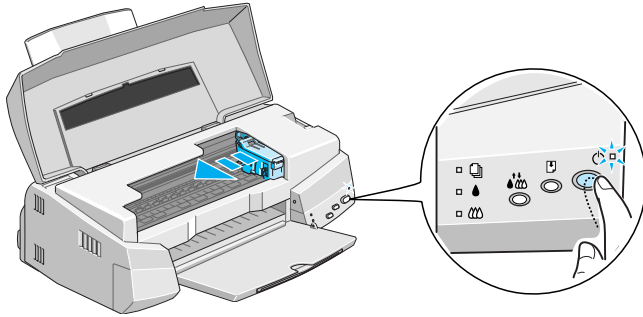

Caution:

Do not move the print head by hand. Otherwise you may damage the printer.

3. Lift up the ink cartridge clamps.

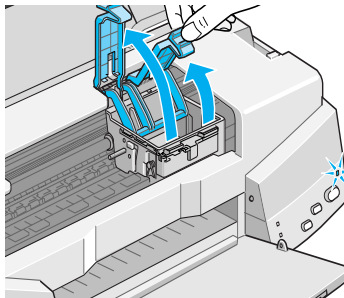

4. Open the ink cartridge packages that came with your printer. Next, remove only the yellow tape seals from each cartridge.

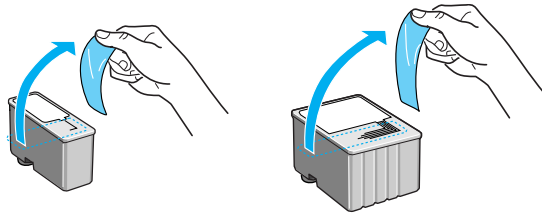

Caution:

- Remove the yellow tape seals from the cartridges before installing them; otherwise the cartridges may become unusable.
 - Do not remove the blue portion of the tape seals from the cartridges; otherwise the cartridges may become clogged and cannot print.
 - Do not remove the tape seals from the bottom of the cartridges; otherwise, ink will leak.
5. Place the cartridges gently into their holders with the labels face-up. The color ink cartridge, which is larger, goes on the right and the black goes on the left. Do not press down on the cartridges.

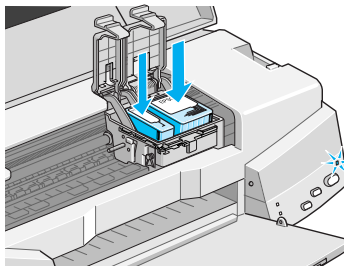

Note:

Install both ink cartridges. If either of the cartridges is not installed, the printer will not work.

6. Press the ink cartridge clamps down until they lock in place.

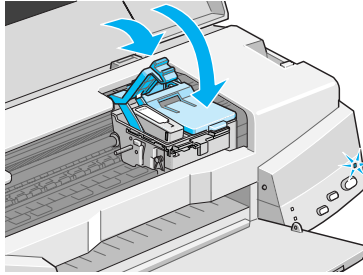



Caution:

Once you install the ink cartridges, do not open their clamps again until you replace the ink cartridges. Otherwise, the cartridges may become unusable.

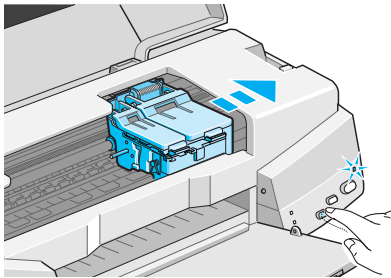
7. Press the  cleaning button. The printer moves the print head and begins charging the ink delivery system.



The ink charging process may take about one minute to complete, during which time the  power light flashes and the printer produces a variety of mechanical sounds. These sounds are normal. When the ink delivery system has been charged, the print head returns to its home (far right) position and the  power light stops flashing.



Caution:

Never turn off the printer while the  power light is flashing.

8. Close the printer cover.

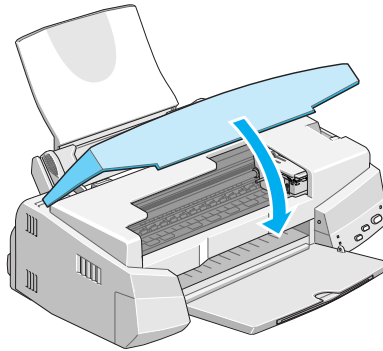

Now you are ready to connect the printer to your computer. To connect the printer to your PC, see the next section. To connect the printer to a Macintosh, see “Connecting the Printer to Your Macintosh” on page 18.

Connecting the Printer to Your PC

Note:

To connect and use the USB connector, see the USB User’s Guide shipped with your printer.

Connecting to a parallel interface

To connect the printer to your computer using the built-in parallel interface, you need a shielded, twisted-pair parallel cable.

Follow these steps to connect your printer.

1. Make sure both the printer and computer are turned off.

2. Plug the cable connector securely into the printer's interface connector. Then squeeze the wire clips together until they lock in place on both sides. If your cable has a ground wire, connect it to the ground connector below the interface connector.

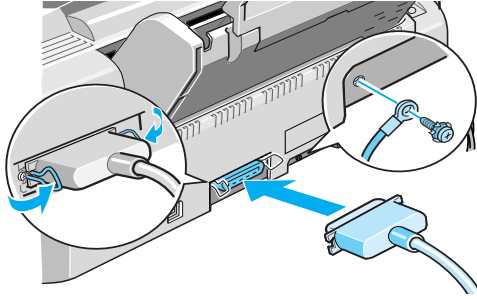

3. Plug the other end of the cable into the computer's parallel interface. If there is a ground wire at the computer end of the cable, connect it to the ground connector at the back of the computer.

See “Installing the Printer Software in Your PC” on page 16 for instructions on installing the printer software. You must install the printer software before using your printer.

Installing the Printer Software in Your PC

After connecting the printer to your computer, you need to install the software included on the “Printer Software for EPSON Stylus Photo 750” CD-ROM shipped with your printer.

Your printer software includes:

- ❑ **Printer driver**
The printer driver is the software that runs, or “drives,” your printer. With it, you can make settings such as media type, print quality, speed, and paper size.

- ❑ **Utilities**
The Nozzle Check, Head Cleaning, and Print Head Alignment utilities help you keep your printer in top operating condition.
- ❑ **EPSON Status Monitor 2**
EPSON Status Monitor 2 notifies you of printer errors and displays printer status information such as the amount of ink remaining. The Status Monitor also guides you when replacing ink cartridges.
- ❑ **HIGH QUALITY IMAGES**
HIGH QUALITY IMAGES allows you to quickly and easily see the kind of high-quality printout available from the EPSON Stylus Photo 750.

If you are using the floppy disk version of the software, make a backup copy of the EPSON printer software disk before you begin installation. If you wish to make a floppy disk version of the printer software included on your CD-ROM, insert the printer software CD-ROM, then click the Driver disk creation utility button and follow the on-screen instructions.

Installing in Windows 95, 98, and NT 4.0

1. Insert the printer software CD shipped with your printer in the CD-ROM drive. The Installer dialog box appears. (For floppy disk users, insert the disk in a disk drive, then double-click the drive icon and double-click the Setup.exe icon.)
2. Click Install to start the printer software installation.
3. When the installation is complete, click OK.

EPSON Status Monitor 2 installation starts automatically. Follow the on-screen instructions.

Note:

- ❑ *If the New Hardware Found screen or any other Wizard appears when you turn on your computer, click Cancel and follow the steps above.*
- ❑ *Installation time varies depending on your computer.*

For information on opening and using the software, see “Printing Your First Page for Windows” on page 25. See also “Using the Printer Software for Windows” in the online Reference Guide.

If you use your printer on a network, see “Network Printing” in the online Reference Guide.

Installing in Windows 98 with USB interface

If you connected your printer using the USB interface, you need to install the EPSON USB Printer Device Driver and the printer software included in the printer software CD-ROM. Follow the instructions in the *USB User's Guide* that came with your printer.

For information on opening and using the software, see “Printing Your First Page for Windows” on page 25. See also “Using the Printer Software for Windows” in the online Reference Guide.

Connecting the Printer to Your Macintosh

Note:

To connect to an iMac computer using the USB port, see the USB User's Guide shipped with your printer.

To use the printer's built-in serial interface, you will need an Apple System Peripheral-8 cable.

Follow these steps to connect the printer:

1. Make sure both your printer and Macintosh are switched off.

2. Connect one end of the interface cable to the serial connector on the back of the printer.

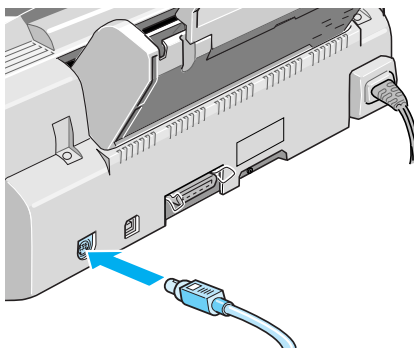

3. Connect the other end of the interface cable to either the modem port or printer port on the Macintosh. The ports are marked with the following icons.



modem port

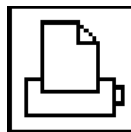

printer port

See the next section for instructions on installing the printer software. You must install the printer software before using your printer.

For information on opening and using the software, see “Printing Your First Page for Macintosh” on page 27. See also “Using the Printer Software for Macintosh” in the online Reference Guide.

Installing the Printer Software in Your Macintosh

After connecting the printer to your Macintosh, you are ready to install the printer software included in the “Printer Software for EPSON Stylus Photo 750” CD-ROM shipped with your printer.

Your printer software includes:

- ❑ EPSON Printer Driver Package

SP750

This is the printer driver software that runs your printer. With it, you can make settings such as media type, print quality, speed, and paper size.

EPSON Monitor3

Monitors and manages background printing jobs. You must turn on background printing in the Chooser to use this utility.

StatusMonitor

Keeps track of the current status of your printer, and alerts you when printer errors occur.

Nozzle Check

Checks the print head for clogging.

Head Cleaning

Cleans the print head to maintain the best print quality.

Print Head Alignment

Adjusts the print head so that vertical and horizontal lines are aligned.

ColorSync 2.0 and Profiles

Matches the colors in your printout with the colors displayed on your screen automatically. Use this when printing scanned photographs or computer graphics.

If you are using the floppy disk version, make a backup copy of the EPSON Macintosh printer software disk before you begin installation.



Caution:

Turn off all virus protection programs before you install your printer software.

Follow these steps to install your printer software:

1. Turn on your Macintosh and insert the software CD in the CD-ROM drive. (If you use the floppy disk version, insert it in a disk drive.)
2. The EPSON printer software disk opens automatically.
3. If a single Installer icon appears, double-click the icon. If separate folders containing installer icons for several languages appear, double-click the folder for your preferred language, then double-click the Installer icon inside it.
4. After the initial screen appears, click Continue. The following dialog box appears.

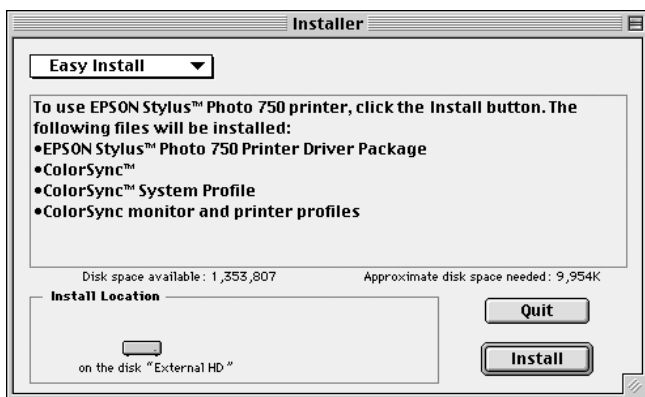

5. If you want to install all of the printer software included on your printer software CD-ROM, make sure the Install Location box shows the correct disk drive and click Install.

If you are low on disk space, select Custom Install from the pop-up menu and click Serial Driver Package. Confirm the destination for installation, then click Install.

Note:

Click the  icon to get information on each component.

6. When a message appears informing you that installation is finished, click Restart to complete the installation and restart your computer.

Selecting Your Printer in the Chooser

After you install the printer software, you need to open the Chooser to select your printer. You have to choose the printer the first time you use it or whenever you want to switch to another printer. Your Macintosh will always print using the last printer selected.

Note:

If you are using a Macintosh Quadra 950 or 900, you need to choose Compatible in the Serial Switch dialog box before selecting your printer from the Chooser. To open the Serial Switch dialog box, choose Control Panel from the Apple menu, then choose Serial Switch.

1. Make sure the printer is connected to your Macintosh and is turned on.

2. Choose Chooser from the Apple menu. Then click your printer's icon and the port your printer is connected to.

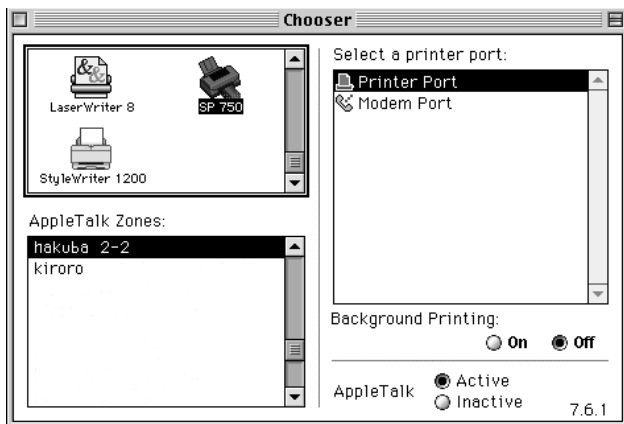

Note:

- If you are using an iMac computer, you must select the USB port.*
 - If you are using an AppleTalk network, an alert message may appear when you click the port. In this case, reselect the other port, or make AppleTalk setting Inactive then select the port again.*
3. Click the Background Printing radio buttons to turn background printing on or off.

When background printing is on, you can use your Macintosh while it is preparing a document for printing. You must turn on background printing to use the EPSON Monitor3 utility to manage print jobs.

4. Close the Chooser.

For information on opening and using the software, see “Printing Your First Page for Macintosh” on page 27. See also “Using the Printer Software for Macintosh” in the online Reference Guide.

Loading Paper

Follow these steps to load A4 or letter size plain paper in the printer.

You can also print on ink jet paper, photo-quality glossy film or paper, photo paper, transparencies, envelopes, index cards, and adhesive sheets. For details on using such media, see “Paper Handling” in the online Reference Guide.

1. Lower the output tray and slide out the extension. Next, slide the left edge guide so that the distance between the edge guides is slightly wider than the width of your paper.

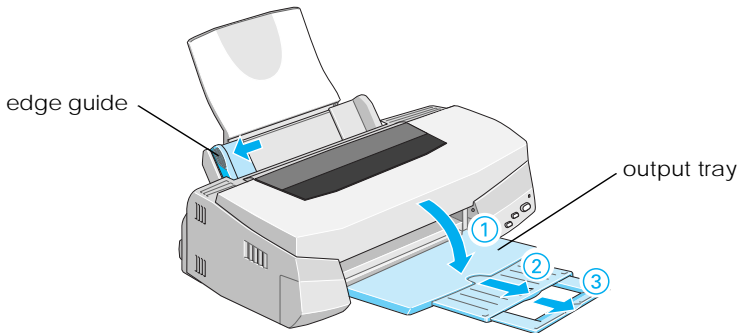

2. Fan a stack of paper; then tap it on a flat surface to even the edges.

3. Load the stack of paper with the printable side up and the right edge of the paper resting against the right side of the sheet feeder. Then slide the left edge guide against the edge of the paper.

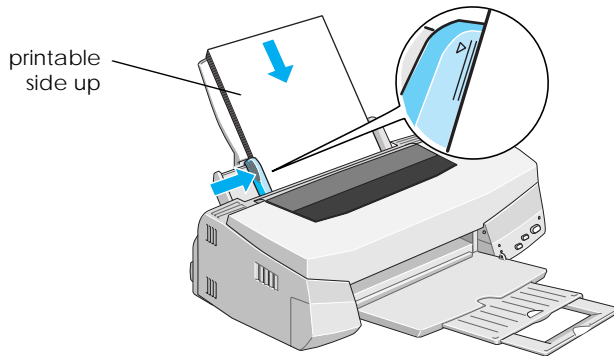

Note:

- Always load paper into the sheet feeder short edge first.
- Make sure the paper stack fits under the arrow mark inside the edge guide.

Printing Your First Page for Windows

After loading the paper, you are ready to print your first page. In order to check the operation of your printer, we recommend printing the README file provided with your printer software. The README file contains the latest information about your printer software.

If you choose to print your own document instead, select the appropriate Paper Size setting in your application software, then print the document as explained from step 3, below. (See your software manual for details on how to use your application.)

Follow these steps to print the README file:

1. Make sure A4 or letter size paper is loaded in the printer.
2. Click Start, point to Programs, point to Epson (for Windows 95, and 98) or EPSON Printers (for Windows NT 4.0), and then click EPSON Stylus Photo 750 Readme.
3. Click Print on the File menu. The Print dialog box appears.
4. Make sure your printer is selected and then click Properties, or Options. You may need to click a combination of these buttons. The driver settings window appears.

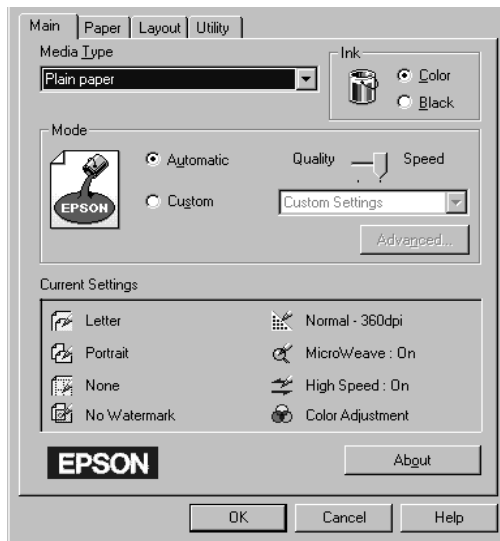

5. Click the Main tab if necessary, then click anywhere in the Media Type box and select the media you loaded in the printer.
6. Select Color as the Ink setting.
7. Make sure the Mode option is set to Automatic.

When Automatic is selected, the printer software optimizes other settings according to the Media Type and Ink settings you make.

8. Make sure the correct paper size is displayed in the Current Settings box. If it is not, click the Paper tab and select the correct paper size from the Paper Size list.
9. Click OK at the bottom of the window. You return to the Print dialog box (or a similar dialog box).
10. Click Close, OK, or Print to print. You may need to click a combination of these buttons.

While printing, the EPSON Progress Meter will appear, showing the printing progress and the status of your printer. For details, see “Checking Printer Status and Managing Print Jobs for Windows” in the online Reference Guide.

After printing, check your results. If everything printed satisfactorily, your EPSON printer is now fully setup and ready to help you create wonderful printouts. If the printed image is unexpectedly faint or dots in the printed image are missing, see “Checking the Print Head Nozzles” on page 37 for help on checking and cleaning the print head.

For further information about your printer, see the online Reference Guide. For details about the printer software, see online help. To learn more about color printing, see the online Color Guide.

Printing Your First Page for Macintosh



After loading the paper, you are ready to print your first page. In order to check the operation of your printer, we recommend printing the README file located on your printer software CD. The README file contains the latest information about your printer software.

If you choose to print your own document instead, select the appropriate Paper Size setting in your application software, then print the document as explained from step 4, below. (See your software manual for details on how to use your application.)

Follow these steps to print the README file:

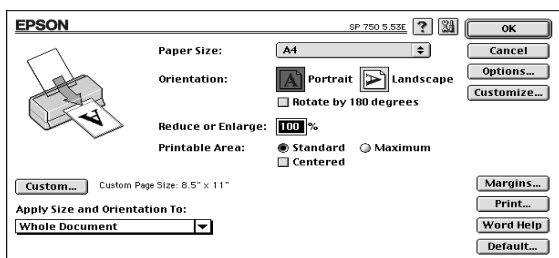
1. Make sure A4 or letter size paper is loaded in the printer.
2. Insert the printer software CD.
3. Open the EPSON folder and double-click the README file.
4. Choose Page Setup from the File menu. This brings up the dialog box shown below.



5. Select the paper size you loaded in the printer from the Paper Size list.
6. Select  Portrait or  Landscape as the Orientation option.
7. After making your settings, click the OK button to close the Page Setup dialog box.

Note:

You cannot print from the Page Setup dialog box. You can only print from the Print dialog box.

8. Choose Print from the File menu. This brings up the dialog box shown below.

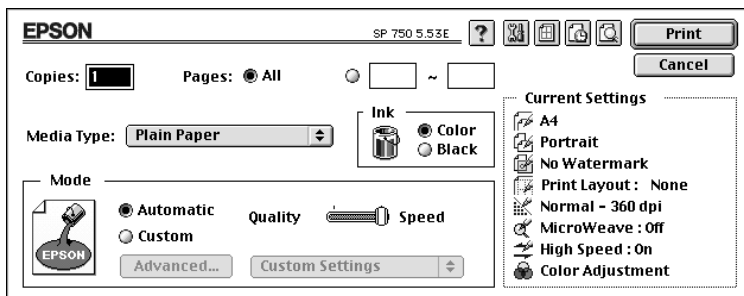

9. Select the media you loaded in the printer from the Media Type list.
10. Select Color as the Ink option.
11. Make sure the Mode option is set to Automatic.

When Automatic is selected, the printer software optimizes other settings according to the Media Type and Ink settings you make.

12. Click Print to start printing.

After printing, check your results. If everything printed satisfactorily, your EPSON printer is now fully setup and ready to help you create wonderful printouts. If the printed image is unexpectedly faint or dots in the printed image are missing, see “Checking the Print Head Nozzles” on page 37 for help on checking and cleaning the print head.

For further information about your printer, see the online Reference Guide. For details about the printer software, see online help. To learn more about color printing, see the online Color Guide.

Loading Special Paper

You can print on a wide variety of special media, including ink jet paper, photo-quality glossy film or paper, photo paper, transparencies, envelopes, index cards, and adhesive sheets.

When loading special paper, read the instruction sheets packed with your special media first, and keep the following in mind. For more details on using such media, see “Paper Handling” in the online Reference Guide.

Note:

If you want to use plain paper, see “Loading Paper” on page 24.

- ❑ Make sure the printable side of the paper is face up when loading media into the sheet feeder. See the instruction sheets packed with the media to determine which side is the printable surface. Some media have cut corners to help identify the correct loading direction.
- ❑ Always load paper into the sheet feeder short edge first.
- ❑ Make sure the paper stack fits under the arrow mark inside the edge guide.
- ❑ Loading capacity for envelopes and EPSON special media is explained below.

Envelopes

Up to 10 envelopes.

Note:

If the total thickness of the stack of envelopes exceeds 10 mm, press each envelope flat before loading.

360 dpi Ink Jet Paper
and Photo Quality
Ink Jet Paper

Up to the arrow mark on the left edge guide.

Photo Quality Ink Jet Card, Ink Jet Note Card, and Ink Jet Greeting Card	Up to 30 index cards. Always place the included support sheet under the cards.
Photo Quality Glossy Film	One sheet at a time for best results. Always put a support sheet* or a sheet of plain paper under the glossy film. If you wish to print with multiple sheets, load only up to 20 sheets and set the minimum top margin of the page to 30 mm.
Ink Jet Transparencies	Up to 30 transparencies. Always put a sheet of plain paper under the stack of transparencies.
Photo Quality Self Adhesive Sheet	One sheet at a time.
Photo Paper	Up to 20 sheets. For 4 × 6 inch Photo Paper, always put a support sheet* under the stack of Photo Paper.
Photo Stickers 16 and Photo Stickers 4	One sheet at a time. Always put the included Support Sheets A and B under the stack of Photo Stickers.
Panoramic Photo Paper and Iron-On Cool Peel Transfer Paper	One sheet at a time.
Photo Paper Cards	One sheet at a time. Always put a support sheet* under the Photo Paper Card.





*Take care not to not print on support sheets loaded under special media.

Replacing Ink Cartridges

Using the printer's control panel

The printer's indicator lights will inform you when it is time to obtain a replacement ink cartridge and when it is time to replace an empty cartridge.

This table describes the status of the lights on your printer and the actions you need to take.

Lights	Action
	Obtain a replacement black ink cartridge (S020187).
	Replace the empty black ink cartridge.
	Obtain a replacement color ink cartridge (S020193).
	Replace the empty color ink cartridge.

■ = on,  = flashing







Caution:

- ❑ *EPSON recommends the use of genuine EPSON ink cartridges. Other products not manufactured by EPSON may cause damage to your printer not covered by EPSON's warranties.*
- ❑ *Leave the old cartridge installed in the printer until you have obtained a replacement. Otherwise, ink remaining in the print head nozzles may dry out.*

Note:

If the ink runs out, you cannot continue printing until you replace the empty cartridge, even though the other ink cartridge still contains ink.

To replace an ink cartridge using the printer's control panel, follow these steps.

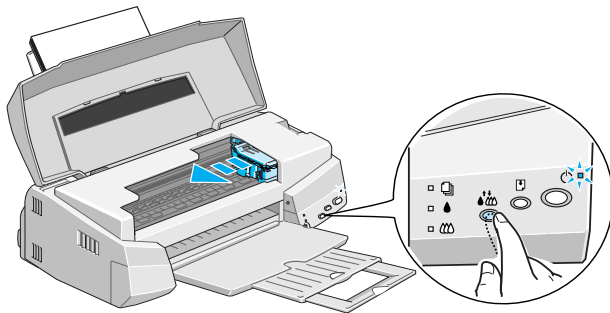

1. Make sure the printer is on. The  power light should be on, but not flashing. (Determine which cartridge needs to be replaced as indicated by the  black and  color ink out light.)
2. Lower the output tray at the front of the printer, then open the printer cover.
3. Hold down the  cleaning button for three seconds until the print head moves left slightly to the cartridge replacement position and the  power light begins flashing.



Caution:

Do not move the print head by hand. Always use the  cleaning button to move it. Otherwise you may damage the printer.

Note:

If you press the  cleaning button for three seconds when the  and  ink out lights are off, the printer starts cleaning the print head.

- Lift up the clamp that holds the cartridge you want to replace as far as it will go. When you do, the cartridge will rise partly out of the cartridge holder.

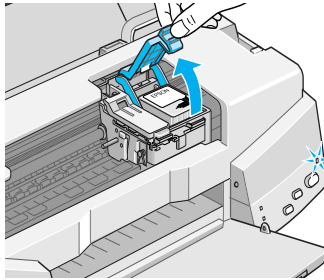

The illustration shows color ink replacement. To replace black ink, lift up only the smaller clamp on the left.



Caution:

Once you open the ink cartridge clamp, the ink cartridge becomes unusable and cannot be reinstalled even if ink remains.

- Lift the cartridge out of the printer and dispose of it properly. Do not take the used cartridge apart or try to refill it.



Warning:

If ink gets on your hands, wash them thoroughly with soap and water. If ink gets into your eyes, flush them immediately with water.

- Remove the ink cartridge from its protective bag. Next, remove only the yellow tape seal from the cartridge.

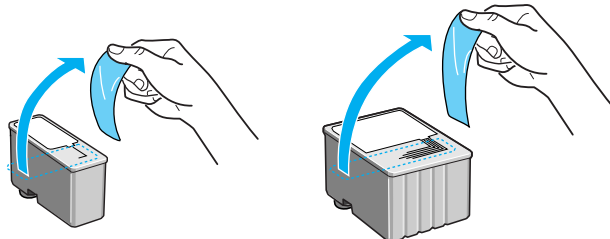



Caution:

- You must remove the yellow tape seal from the cartridge. Leaving the tape on when you install the cartridge will permanently damage it.
 - Do not remove the blue portion of the tape seal from the top of the cartridge; otherwise, the cartridge may become clogged and cannot print.
 - Do not remove the tape seal from the bottom of the cartridge; otherwise, ink will leak.
7. Place the ink cartridge gently into the cartridge holder with the label on the cartridge face up. Do not press down on the cartridge.

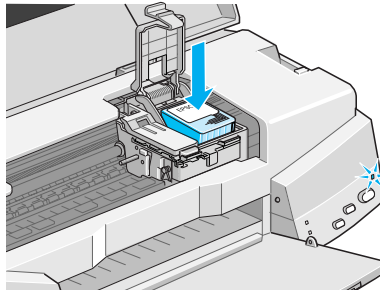



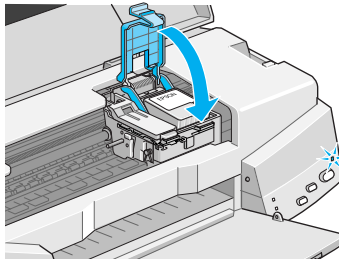

8. Press the ink cartridge clamp down until it locks in place.





The illustration shows color ink replacement. To replace black ink, press down the smaller clamp on the left.

**Caution:**

Once you install the cartridges, do not open their clamps again until you replace the ink cartridges. Otherwise, the cartridges may become unusable.

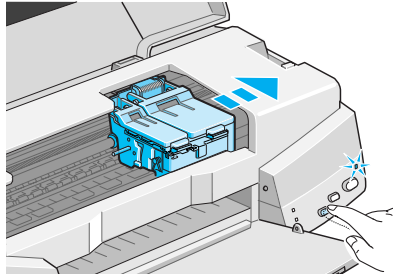
9. Make sure the  and  ink out lights are off. Then press the  cleaning button. The printer moves the print head and begins charging the ink delivery system. This process takes about 1 minute to complete. When the ink charging process is finished, the printer returns the print head to its home position and the  power light stops flashing.

**Caution:**

The  power light continues to flash while the printer performs the ink charging operation. Never turn off the printer while this light is flashing. Doing so can result in incomplete charging of ink.

10. Close the printer cover.

Maintenance

Checking the Print Head Nozzles

If you find that the printed image is unexpectedly faint or dots in the printed image are missing, you may be able to solve these problems by checking the print head nozzles.

You can check the print head nozzles from your computer with the Nozzle Check utility in the printer software, or from the printer itself by using the printer's control panel buttons.

Note:

Do not start the Nozzle Check utility while printing is in progress; otherwise your printout may be marred.

Using the Nozzle Check Utility



For Windows users

1. Access the printer software window.
2. Click the Utility tab, then click the Nozzle Check button.
3. Follow the messages on your screen.

For Macintosh users

1. Access the Page Setup dialog box.
2. Click the Utility icon button, then click the Nozzle Check button.
3. Follow the messages on your screen.

Using the control panel buttons

1. Hold down the  load/eject button and press the  power button to turn on the printer. Then release both buttons.

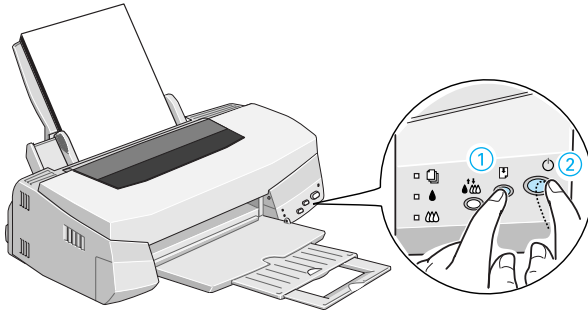

The printer prints an operation check page including your printer's ROM version information, the ink counter code, and a nozzle check pattern. Here is a typical printout:

Good sample

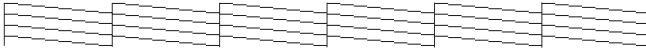

Print head needs to be cleaned



The above sample is in black and white, but the actual test prints in color (CMYK).

2. Press the  power button to turn off the printer after it finishes printing the nozzle check pattern.



If the nozzle check page does not print satisfactorily, for example, if any segment of the printed lines is missing, there is a problem with the printer. This could be a clogged ink nozzle or a misaligned print head. See the next section for details on cleaning the print head. For information on aligning the print head, see “Aligning the Print Head” on page 41.

Cleaning the Print Head

If you find that the printed image is unexpectedly faint or dots in the printed image are missing, you may be able to solve these problems by cleaning the print head, which ensures that the nozzles are delivering ink properly.

You can clean the print head from your computer with the Head Cleaning utility in the printer software, or from the printer itself by using the printer’s control panel buttons.

Note:

- ❑ *Print head cleaning uses both color and black ink. To avoid wasting ink, clean the print head only if print quality declines.*
- ❑ *Use the Nozzle Check utility to confirm that the print head needs to be cleaned. This saves ink.*
- ❑ *When the  or  ink out light is flashing or on, you cannot clean the print head. Replace the appropriate ink cartridge first.*
- ❑ *Do not start the Head Cleaning or Nozzle Check utility while printing is in progress; otherwise your printout may be marred.*

Using the Head Cleaning utility

For Windows users



1. Access the printer software window.
2. Click the Utility tab, then click the Head Cleaning button.

3. Follow the messages on your screen.



For Macintosh users

1. Click the Utility icon button in the Print dialog box. Then click the Head Cleaning button.
2. Follow the on-screen messages.

Using the control panel buttons

1. Make sure that the  power light is on and that both the  and  ink out lights are off.

Note:

If the  or  ink out light is flashing or on, you cannot clean the head, and this operation will start the ink cartridge replacement procedure. If you do not want to replace an ink cartridge at this moment, press the  cleaning button to return the print head to its home position.

2. Hold down the  cleaning button for three seconds.

The printer starts cleaning the print head and the  power light begins flashing. Print head cleaning takes about one minute to complete.



Caution:

Never turn off the printer while the  power light is flashing. Doing so may damage the printer.

3. When the  power light stops flashing, print a few lines from a document to confirm that the head is clean and to reset the cleaning cycle.

If print quality hasn't improved after repeating this procedure four or five times, turn the printer off and leave it alone overnight. Then do the head cleaning again.

If the print quality still has not improved, one or both of your ink cartridges may be old or damaged and may need to be replaced. To replace an ink cartridge before it is empty, see “Replacing an Old or Damaged Ink Cartridge” in the online Reference Guide. If print quality remains a problem after replacing the ink cartridges, contact your dealer.

Note:

To maintain print quality, we recommend turning on the printer for at least one minute every month.

Aligning the Print Head

If you notice a misalignment of vertical lines, you may be able to solve this problem from your computer using the Print Head Alignment utility in your printer software.

Note:

Do not start the Print Head Alignment utility while printing is in progress; otherwise your printout may be marred.

For Windows users

1. Make sure paper is loaded in the sheet feeder.



Caution:

Use paper at least 210 mm (8.27 inches) wide; for example, A4 size paper loaded short edge first. Otherwise, the print head will spray ink directly onto the platen.

2. Access the printer software window. If you need instructions, see “Accessing the printer software” in the online Reference Guide.
3. Click the Utility tab, then click the Print Head Alignment button.
4. Follow the messages on your screen to align the print head.







For Macintosh users





1. **Make sure A4 or wider paper is loaded in the sheet feeder.**
2. **Click the Utility icon button in the Print dialog box. Then click the Print Head Alignment button.**
3. **Follow the messages on your screen to align the print head.**

Troubleshooting

Error Indicators

You can identify many common printer problems with the lights on your printer's control panel. If your printer stops working and the lights are on or flashing, use the following table of panel light patterns to diagnose the problem, then follow the recommended corrective measures.

Lights	Problem and Solution	
	Paper Out	
	No paper is loaded in the printer.	Load paper in the sheet feeder; then press the  load/eject button to turn this light off. The printer resumes printing.
	Paper Jam	
	Paper has jammed in the printer.	Press the  load/eject button. The printer ejects the jammed paper and then resumes printing. If the error is not cleared, open the printer cover and remove the jammed paper. Then reload paper in the sheet feeder, and press the  load/eject button. The printer resumes printing.
	Ink Low (black ink cartridge)	
	The black ink cartridge is nearly empty.	Obtain a replacement black ink cartridge (S020187).
	Ink Out (black ink cartridge)	
	The black ink cartridge is empty.	Replace the black ink cartridge with a new one (S020187). See "Replacing Ink Cartridges" on page 32.

	Ink Low (color ink cartridge)	
	The color ink cartridge is nearly empty.	Obtain a replacement color ink cartridge (S020193).
	Ink Out (color ink cartridge)	
	The color ink cartridge is empty.	Replace the color ink cartridge with a new one (S020193). See "Replacing Ink Cartridges" on page 32.
	Carriage Error	
	The print head carriage is caught by jammed paper or other foreign material and cannot return to the home position.	<p>If the paper is not ejected, turn off the printer. Open the printer cover and remove any paper from the paper path by hand.</p> <p>If the error is not cleared, contact your dealer.</p>
	Unknown Printer Error	
	An unknown printer error has occurred.	Turn off the printer, and contact your dealer.

■ = on, □ = off,  = flashing

Cancelling Printing

To cancel printing, follow the steps below.

For Windows

When you send a print job to the printer, the Progress Meter appears on your computer screen.

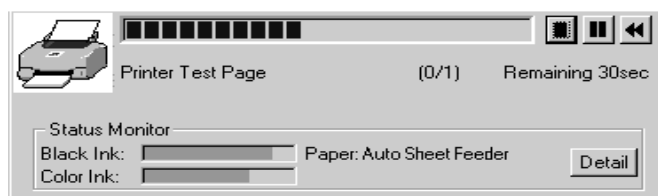

Click the  stop button to cancel printing.

For Macintosh

When background printing is on



1. Press the  power button to turn off the printer.
2. Select EPSON Monitor3 from the application menu.

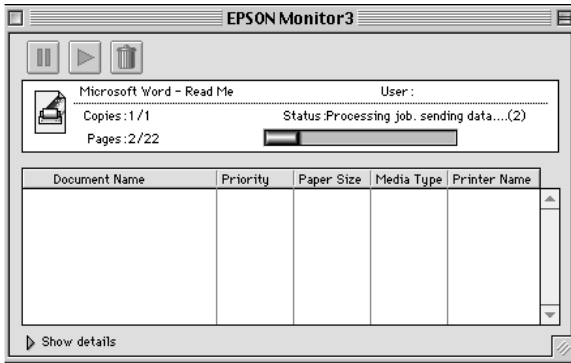

3. Click the  button, then click the  stop button to cancel the print job.



When background printing is off

1. Press the  power button to turn off the printer.
2. Hold down the  key on your keyboard and press the . (period) key to cancel the print job.

Where to Get Help

If your printer is not operating properly and you cannot solve the problem using the troubleshooting information in your printer documentation, contact customer support services for assistance.

We will be able to help you much more quickly if you give us the following information:

Serial number of your printer

(The serial number label is on the back of the printer.)

Printer model

Brand and model of your computer

Printer software version

(Click About in your printer driver.)

Windows version you are using

Software application(s) you normally use with your printer and their version number(s)

For United Kingdom and the Republic of Ireland Users

If you purchased your printer in the UK or the Republic of Ireland, EPSON (UK) Limited provides a range of customer services and technical support.

World Wide Web

If you can connect to the Internet and have a Web browser, you can access our Web site at <http://www.epson.co.uk>. Here you will find information on the latest EPSON products, software drivers, on-line user guides, and answers to frequently asked questions.

Faxon EPSON

Contact Faxon EPSON Faxback Service for support information including troubleshooting tips, switch settings, and driver information.

To use Faxon EPSON, call 01442 227332 in the UK or 0044 1442 227332 from the Republic of Ireland using a touch-tone phone. You will be asked to follow a simple routine to register your document request. Once you have entered your telephone and fax numbers, Faxon EPSON will fax a copy of the document catalogue to your fax machine.

When you have found the documents that you need in the catalogue, call Faxon EPSON again and enter the document ID numbers. The documents will be faxed to you automatically.

Bulletin Board Service for latest drivers and utilities

You can call the EPSON Bulletin Board Service on 01442 227479 in the UK or 0044 1442 227479 from the Republic of Ireland. No membership is required. Make sure that your communications software is set to 8 data bits, 1 stop bit, no parity bit, ANSI terminal mode emulation, and a modem speed of up to 28.8 Kbps. Downloading protocols supported include Xmodem, Ymodem and Zmodem. See the documentation that came with your communications software and modem for more information.

When you first connect to the Bulletin Board Service, you will be asked for your name, company name, phone number and a password (which you can invent yourself).

Customer and Warranty Support

Our Customer and Warranty Support teams can be contacted by calling 0870 163 7766 in the UK or 0044 0870 163 7766 from the Republic of Ireland. They can provide the following services:

- ❑ Technical information on installing, configuring, and operating your EPSON products

- ❑ Arranging for faulty EPSON products to be repaired within the warranty period

A full list of EPSON Customer and Warranty Support services is available on the technical support section of our world wide web pages at <http://www.epson.co.uk/support/> and on Faxon EPSON Faxback service in document number 5085.

Pre Sales Enquiry Desk

The Enquiry Desk team can be contacted by calling 0800 220546 in the UK or 1 800 409132 from the Republic of Ireland, by faxing 01442 227271 in the UK or 0044 1442 227271 from the Republic of Ireland, and via Email at info@epson.co.uk. They can provide the following information:

- ❑ Pre Sales information and literature on new EPSON products (also available via our world wide web site at <http://www.epson.co.uk>)
- ❑ Where to purchase genuine EPSON consumables, accessories, and options

For Australian Users

EPSON Australia wishes to provide you with a high level of Customer Service. As well as the user's guide, we provide the following sources for obtaining information:

EPSON FAXBACK

EPSON FAXBACK will fax you the latest specifications and pricing for most EPSON products offered in Australia. There is also technical information including details of the latest software and drivers available. Phone (02) 9903 9075 and the system will guide you through a number of choices before faxing the information to your fax machine.

EPSON Bulletin Board System

This is where you can download the latest software and drivers. Visit the BBS to check out the latest versions. If you have a modem, phone (02) 9417 5090.

Internet URL <http://www.epson.com.au>

Access the EPSON Australia World Wide Web pages. Worth taking your modem here for the occasional surf! You can get the same information as offered on the EPSON FAXBACK and the EPSON Bulletin Board plus more.

Your dealer

Don't forget that your dealer can often help identify and resolve problems. The dealer should always be the first call for advice on problems. They can often solve problems quickly and easily as well as give you advice on the next step to take.

EPSON Helpdesk

EPSON Helpdesk is provided as a final backup to make sure our clients have access to advice. Operators on the Helpdesk can aid you in diagnosing hardware and software problems. They can also advise you on the latest EPSON products and where the nearest dealer or service agent is located. Many types of queries are answered here.

The Helpdesk numbers are:

Phone: (02) 9903 9040

Fax: (02) 9903 9189

We encourage you to have all the relevant information on hand when you ring. The more information you prepare, the faster we can help solve the problem. This information includes the *User's Guide* for your EPSON product, type of computer, operating system, application programs, and any other information you feel is required.

For Singapore Users

Contact the telephone and fax numbers below:

Phone: (065) 337-7911

Fax: (065) 334-1185

For Hong Kong Users

To obtain technical support as well as other after-sales services, users are welcome to contact EPSON Hong Kong Limited.

Internet home page

EPSON Hong Kong has established a local home page in both Chinese and English on the Internet to provide users with the following information:

- Product information
- Answers to Frequently Asked Questions (FAQs)
- Latest versions of EPSON printer drivers

Users can access our World Wide Web home page at:
<http://www.epson.com.hk>

Electronic bulletin board system

An electronic bulletin board system (BBS) is also available to obtain printer information and the latest versions of printer drivers. You can log on to the following number for the BBS service:

BBS: (852) 2827-4244

Technical Support Hotline

You can also contact our technical staff at the following telephone and fax numbers:

Phone: (852) 2585-4399

Fax: (852) 2827-4383

For Philippines Users

To obtain technical support as well as other after sales services, users are welcome to contact the EPSON Philippines Representative Office at the telephone and fax numbers below:

Phone: (632) 813-6552

Fax: (632) 813-6545

BBS: (632) 814-0595

Options and Consumable Products

Interface cables

You can use any interface cable that meets the following specifications. See your computer manual for any additional requirements.

- ❑ Parallel Interface Cable (shielded) C83602* from D-SUB 25-pin (computer) to 36-pin Amphenol 57 Series (printer)
- ❑ USB Interface Cable (shielded) C83623* from Series A 4-pin (computer) to Series B 4-pin (printer) (This cable not supplied in all locations.)

Note:

The asterisk () is a substitute for the last digit of the product number, which varies by country.*



Caution:

Use only the interface cables listed above. Using other cables not covered by EPSON warranties may cause the printer to malfunction.

Ink cartridges

Black ink cartridge S020187

Color ink cartridge S020193

EPSON special media

Most plain paper works well in your printer. In addition, EPSON offers specifically designed media for ink jet printers to meet most high-quality printing needs.

EPSON 360 dpi Ink Jet Paper (A4)	S041059
	S041025

EPSON 360 dpi Ink Jet Paper (Letter)	S041060 S041028
EPSON Photo Quality Ink Jet Paper (A4)	S041061 S041026
EPSON Photo Quality Ink Jet Paper (Letter)	S041062 S041029
EPSON Photo Quality Ink Jet Paper (Legal)	S041067 S041048
EPSON Photo Quality Ink Jet Card (A6)	S041054
EPSON Photo Quality Ink Jet Card (5 × 8")	S041121
EPSON Photo Quality Ink Jet Card (8 × 10")	S041122
EPSON Photo Quality Self Adhesive Sheet (A4)	S041106
EPSON Ink Jet Note Cards A6 (with envelopes)	S041147
EPSON Ink Jet Greeting Cards 5 × 8" (with envelopes)	S041148
EPSON Ink Jet Greeting Cards 8 × 10" (with envelopes)	S041149
EPSON Photo Quality Glossy Film (A4)	S041071
EPSON Photo Quality Glossy Film (Letter)	S041072
EPSON Photo Quality Glossy Film (A6)	S041107
EPSON Ink Jet Transparencies (A4)	S041063
EPSON Ink Jet Transparencies (Letter)	S041064
EPSON Photo Paper (A4)	S041140
EPSON Photo Paper (Letter)	S041141
EPSON Photo Paper (4 × 6")	S041134
EPSON Photo Paper Cards (A4)	S041177
EPSON Photo Stickers 16 (A6)	S041144
EPSON Photo Stickers 4 (A6)	S041176
EPSON Panoramic Photo Paper (210 × 594 mm)	S041145
EPSON Iron-On Cool Peel Transfer Paper (A4)	S041154

EPSON Iron-On Cool Peel Transfer Paper (Letter) S041153
S041155

Note:

The availability of special media varies by country.

EPSON OVERSEAS MARKETING LOCATIONS

EPSON AMERICA, INC.

20770 Madrona Ave.
P.O. Box 2842
Torrance, CA 90509-2842
Phone: (800) 922-8911
Fax: (310) 782-5220

EPSON UK LTD.

Campus 100, Maylands Avenue,
Hemel Hempstead, Herts,
HP2 7TJ, U.K.
Phone: (+44) 01442 261144
Fax: (+44) 01442 227227

EPSON DEUTSCHLAND GmbH

Zülpicher Straße 6,
40549 Düsseldorf Germany
Phone: (0211) 56030
Fax: (0211) 5047787

EPSON FRANCE S.A.

68 bis, rue Marjolin
92300, Levallois-Perret, France
Phone: 33.1.40.87.37.37
Telex: 610657

EPSON AUSTRALIA PTY. LTD.

70 GIBBES STREET, CHATSWOOD 2067 NSW.
Phone: 2-9903-9000
Fax: 2-9903-9177

EPSON SINGAPORE PTE. LTD.

No. 1 Temasek Avenue #36-00
Millenia Tower, Singapore 039192
Phone: (065) 33 77 911
Fax: (065) 33 41 185

EPSON HONG KONG LTD.

Rooms 4706-10, 47/F,
China Resources Bldg.,
26 Harbour Road, Wanchai, Hong Kong
Phone: 2585-4300
Fax: 2827-7083

EPSON TAIWAN TECHNOLOGY & TRADING LTD.

10F, No. 287 Nanking E. Road, Sec. 3,
Taipei, Taiwan, R.O.C.
Phone: (02) 717-7360
Fax: (02) 712-9164

EPSON ITALIA S.p.A.

V.le F.lli Casiraghi 427
20099 Sesto S.Giovanni
MI, Italy
Phone: 2-262331
Fax: 2-2440750

EPSON IBERICA S.A.

Av. de Roma, 18-26
08290 Cerdanyola del Valles
Barcelona, Spain
Phone: 582. 15.00
Fax: 582. 15.55

**SEIKO EPSON CORPORATION
(Hirooka Office)**

80 Harashinden, Hirooka
Shiojiri-shi, Nagano-ken
399-0785 Japan

EPSON PORTUGAL, S.A.

R. do Progresso, 471, 1ª Perafita
4460 Matosinhos, Portugal
Phone: (02) 996 14 02
Fax: (02) 996 14 11

EPSON

Color Ink Jet Printer

EPSON STYLUS PHOTO 750

Setup & Daily Use