







Home Entertainment Projector EH-DM2

User's Guide



Notations used in this guide

	<p>Indicates content that may cause the unit damage or malfunction.</p>
	<p>Indicates additional information and points that may be useful to know regarding a topic.</p>
	<p>Indicates a page where useful information regarding a topic can be found.</p>
	<p>Indicates operating methods and the order of operations. The procedure indicated should be carried out in order of the numbered steps.</p>
	<p>Indicates remote control or main unit buttons.</p>
<p>“(Menu name)”</p>	<p>Indicates menu items and messages that are displayed on screen. Example: “Brightness”</p>
	<p>Depending on the type of disc, the functions and operations which can be performed may be different. These marks inform you of the type of disc being used.</p> <div style="display: flex; justify-content: center; gap: 10px; align-items: center;"> <div style="display: flex; flex-wrap: wrap; justify-content: space-around;"> <div style="border: 1px solid black; padding: 2px; margin: 2px;">DVD Video</div> <div style="border: 1px solid black; padding: 2px; margin: 2px;">Video CD</div> <div style="border: 1px solid black; padding: 2px; margin: 2px;">Data CD</div> <div style="border: 1px solid black; padding: 2px; margin: 2px;">Audio CD</div> <div style="border: 1px solid black; padding: 2px; margin: 2px;">MP3/WMA</div> <div style="border: 1px solid black; padding: 2px; margin: 2px;">JPEG</div> <div style="border: 1px solid black; padding: 2px; margin: 2px;">DivX[®]</div> <div style="border: 1px solid black; padding: 2px; margin: 2px;">Ext.Vid./Comp.</div> </div> <div style="display: flex; justify-content: center; gap: 10px; margin-top: 5px;"> <div style="border: 1px solid black; padding: 2px; margin: 2px;">DVD Video</div> <div style="border: 1px solid black; padding: 2px; margin: 2px;">Video CD</div> <div style="border: 1px solid black; padding: 2px; margin: 2px;">Data CD</div> <div style="border: 1px solid black; padding: 2px; margin: 2px;">Audio CD</div> <div style="border: 1px solid black; padding: 2px; margin: 2px;">MP3/WMA</div> <div style="border: 1px solid black; padding: 2px; margin: 2px;">JPEG</div> <div style="border: 1px solid black; padding: 2px; margin: 2px;">DivX[®]</div> <div style="border: 1px solid black; padding: 2px; margin: 2px;">Ext.Vid./Comp.</div> </div> </div>

Contents

Contents.....	1
Safety Instructions.....	2
Use and Storage.....	8
Discs and USB Storage.....	10
Parts Name and Functions.....	12
Preparing the Remote Control.....	16

Quick Start

Installation.....	18
Projection distance and screen size.....	18
Connecting the power cable.....	18
Disc Playback.....	19
Playing a disc and projecting.....	19
Adjusting the projection position and volume.....	20
Stopping playback.....	22
Turning off the power.....	22
Basic Playback Operations.....	23
Pause.....	23
Reverse search/forward search.....	23
Skip.....	24
Frame advance.....	24
Slow motion playback.....	24
Temporarily using the projector's light as illumination (Break).....	25
Color Mode.....	25
Mute.....	25

Advanced Operations

Becoming a playback expert.....	26
Playback from a DVD menu.....	26
Playback a Video CD from the menu.....	27
JPEG, MP3/WMA and DivX® playback.....	29
Playback by selecting the chapter or track number.....	32
Repeat play and random play.....	32
Program play.....	34
Zoom In.....	35
Changing the audio language.....	36
Changing the subtitles display.....	36
Changing the angle.....	37
Carrying out operations from the playback information screen.....	37
Setting the sleep timer.....	39
Changing the aspect ratio.....	40
Playback by attaching a peripheral device.....	42
Connecting a USB storage device.....	42
Connecting to another video device, a TV set, or a Computer..	43
Projecting images from external video equipment or a computer.....	45
Audio Settings.....	47
Listening with headphones.....	47
Connecting to audio equipment with a digital coaxial audio input port.....	48
Selecting the Surround Sound mode (Only via speaker).....	48
Selecting the digital sound effects.....	49

Settings and Adjustments

Setup Menu Operation and Functions.....	50
Using the setup menu.....	50
Setup menu list.....	51
Language code list.....	53
“Digital Output” settings and output signals.....	54
Operations and functions on the Visual Setup menu.....	55
Operations on the Visual Setup menu.....	55
Visual Setup menu.....	56

Appendix



Troubleshooting.....	58
Reading the indicators.....	58
When the indicators provide no help.....	61
Maintenance.....	63
Cleaning.....	63
Consumables replacement period.....	64
Optional Accessories and Consumables.....	64
How to replace consumables.....	65
Projection Distance and Screen Size.....	69
Compatible Resolution List.....	70
Compatible MPEG format list.....	71
Specifications.....	72
Glossary.....	74
Index.....	75
Inquiries.....	76

Safety Instructions

All safety and operating instructions should be read before using the unit. After you have read all instructions, save this information for later reference.

The documentation and the unit use graphical symbols to show how to use the unit safely.

Please understand and respect these caution symbols in order to avoid injury to persons or property.

 Warning	This symbol indicates information that, if ignored, could possibly result in personal injury or even death due to incorrect handling.
 Caution	This symbol indicates information that, if ignored, could possibly result in personal injury or physical damage due to incorrect handling.



Caution :

To reduce the risk of electric shock, do not remove cover (or back). No user-serviceable parts inside. Refer servicing to qualified service personnel.



This symbol is intended to alert the user to the presence of uninsulated “dangerous voltage” within the product’s enclosure that may be of sufficient magnitude to constitute a risk of electric shock to persons.



This symbol is intended to alert the user to the presence of important operating and maintenance (servicing) instructions in the literature accompanying the appliance.

Explanation of symbols

Symbols indicating an action that must not be done



Do not do



Do not disassemble



Do not touch



Do not wet



Do not use in wet areas



Do not place on an unstable surface

Symbols indicating an action that should be done



Instructions



Disconnect the plug from the outlet

Important safety instructions

Follow these safety instructions when setting up and using the projector :

- Read these instructions.
- Keep these instructions.
- Heed all warnings.
- Follow all instructions.
- Do not use this apparatus near water.
- Clean only with dry cloth.
- Do not block any ventilation openings. Install in accordance with the manufacturer's instructions.
- Do not install near any heat sources such as radiators, heat registers, stoves, or other apparatus (including amplifiers) that produce heat.
- Do not defeat the safety purpose of the polarized or grounding-type plug. A polarized plug has two blades with one wider than the other. A grounding type plug has two blades and a third grounding prong. The wide blade or the third grounding prong are provided for your safety. If the provided plug does not fit into your outlet, consult an electrician for replacement of the obsolete outlet.
- Protect the power cord from being walked on or pinched particularly at plugs, convenience receptacles, and the point where they exit from the apparatus.
- Only use attachments/accessories specified by the manufacturer.
- Use only with the cart stand, tripod, bracket, or table specified by the manufacturer, or sold with the apparatus. When a cart is used, use caution when moving the cart/apparatus combination to avoid injury from tip-over.



- Unplug this apparatus during lightning storms or when unused for long periods of time.
- Refer all servicing to qualified service personnel. Servicing is required when the apparatus has been damaged in any way, such as the power-supply cord or plug is damaged, liquid has been spilled or objects have fallen into the apparatus, the apparatus has been exposed to rain or moisture, does not operate normally, or has been dropped.

Warning

To reduce the risk of fire or electric shock, do not expose this apparatus to rain or moisture.



Do not use in wet areas

Unplug the unit from the outlet and refer all repairs to qualified service personnel under the following conditions:

- If smoke, unusual smells or unusual noises come from the unit.
- If liquid or foreign objects get inside the unit.
- If the unit has been dropped or the case has been damaged.

Continuing to use under these conditions may result in fire or electric shock.

Do not try to repair this unit yourself. Refer all repairs to qualified service personnel.

Place the unit near a outlet where the plug can be easily unplugged.



Disconnect the plug from the outlet

Never open any covers on the unit except as specifically explained in this guide. Never attempt to disassemble or modify the unit. Refer all repairs to qualified service personnel.

Electrical voltages inside the unit can cause severe injury.



Do not disassemble

Do not expose the unit to water, rain, or extensive humidity.



Do not use in wet areas

Use only the type of power source indicated on the unit. Use of a power source other than the specified may result in fire or electric shock. If you are not sure of the power available, consult your dealer or local electricity company.



Do not do

Check the specifications of the power cable. Using an inappropriate power cable could result in fire or electric shock.

The power cable supplied with the unit is intended to comply with power supply requirements for the country of purchase. If using within the country of purchase, do not use any power cable other than the one supplied with the unit. If using the unit overseas, check the power supply voltage, outlet shape and electrical rating of the unit that conform to the local standards, and purchase a proper power cable in the country.



Instructions

Take the following precautions when handling the plug.

Failure to comply with these precautions could result in fire or electric shock.

- Do not overload outlets, extension cables or multi-socket devices.
- Do not insert the plug into the outlet with dust present.
- Insert the plug firmly into the outlet.
- Do not handle the plug with wet hands.
- Do not pull the power cable when disconnecting the plug. Always be sure to hold the plug when disconnecting it.



Instructions

Do not use the power cable that is damaged. Fire or electric shock may result.

- Do not modify the power cable.
- Do not place heavy objects on top of the power cable.
- Do not bend, twist or pull the power cable excessively.
- Keep the power cable away from hot electrical appliances.

If the power cable becomes damaged (such as the wires becoming exposed or broken), contact your dealer for a replacement.



Do not do

If there is an electrical storm, do not touch the plug, otherwise you may receive an electric shock.



Do not touch

Warning

Do not place containers with liquids, water or chemicals on top of the unit.
If the containers spill and the contents get inside the unit, fire or electric shock may result.



Do not
wet

Never look into the unit lens when the lamp is switched on as the bright light can damage your eyes.



Do not do

Never push metallic or flammable objects or any other foreign materials through the air intake or air exhaust vents, fire or electric shock may result.



Do not do

A mercury lamp with high internal pressure is used as the unit's light source. Be sure to observe the instructions below.

If the following points are not observed, injury or poisoning may result.

- Do not damage the lamp or subject it to any impacts.
- The gases inside mercury lamps contain mercury vapor. If the lamp breaks, ventilate the room to prevent the gases that are released from being inhaled or coming into contact with the eyes or mouth.
- Do not bring your face close to the unit while it is in use.

If the lamp breaks and gases or fragments of broken glass from the lamp are inhaled or get into the eyes or mouth, or if any other ill effects are noticed, immediately seek medical advice.



Instructions











Do not leave the unit or the remote control with batteries inside a vehicle with the windows closed, in places where they will be exposed to direct sunlight, or in other places that may become extremely hot.

Thermal deformation or technical malfunction may occur, which could result in fire.



Do not do

Caution

<p>Class 1 LASER Product Do not open the top cover. There are no user serviceable parts inside the unit.</p>	 Do not disassemble
<p>Do not use the unit in places where there are lots of humidity or dust, near cooking or heating appliances, or in places where it may come into contact with smoke or steam. Do not use or store this unit outdoors for an extended length of time. Fire or electric shock may result.</p>	 Do not do
<p>Do not block the slots and opening in the unit case. They provide ventilation and prevent the unit from overheating.</p> <ul style="list-style-type: none"> • Material or paper may get stuck against the air filter underneath the unit while it is in use. Remove anything from underneath the unit that might get stuck against the air filter. If setting up the unit near a wall, leave a space of at least 20 cm between the wall and the air exhaust vent. • Ensure there is at least 10 cm between the air intake vent and any walls, and so on. • Do not place the unit on a sofa, rug, or other soft surface, or in a closed-in cabinet unless proper ventilation is provided. 	 Do not do
<p>Do not place the unit on an unstable cart, stand, or table. The unit might fall down or tip over, and injury may result.</p>	 Do not place on an unstable surface
<p>Do not stand on the unit or place heavy objects on it. The unit might collapse or fall down, and injury may result.</p>	 Do not do
<p>Do not place anything that can become warped or damaged by heat near the air exhaust vents, or bring your hands or face close to the vents while projection is in progress. Because hot air comes out from the air exhaust vents, it may result in burns, warping or other accidents.</p>	 Do not do
<p>Never try to remove the lamp immediately after use because it will be extremely hot. Before removing the lamp, turn off the power supply and wait the duration specified in this guide to allow the lamp to cool completely. The heat may cause burns or other injuries.</p>	 Do not do
<p>Do not place the source of a naked flame, such as a lit candle, on or near the unit.</p>	 Do not do
<p>Unplug the unit when it will not be used for extended periods. The insulation may deteriorate, which may result in fire.</p>	 Disconnect the plug from the outlet
<p>Be sure to check that the power is turned off, the plug is disconnected from the outlet and all cables are disconnected before moving the unit. Fire or electric shock may result.</p>	 Disconnect the plug from the outlet

Caution

Unplug the unit from the outlet before cleaning.
This avoids electric shock during cleaning.



Disconnect
the plug from
the outlet

When cleaning the unit, do not use wet cloths or solvents such as alcohol, thinner or benzine.
Water infiltration or deterioration and breakage of the unit case could result in electric shock.



Instructions

Incorrect battery usage may cause leakage of battery fluid and battery rupture, which could result in fire, injury or corrosion of the unit. When replacing batteries, take the following precautions.

- Insert batteries so that the polarities (+ and -) are correct.
- Do not use batteries of different types or mix old and new batteries.
- Do not use any batteries other than those specified in this guide.
- If the batteries leak, wipe away battery fluid with a soft cloth. If fluid gets on your hands, wash them immediately.
- Replace the batteries as soon as they run out.
- Remove the batteries if you will not be using the unit for a long period of time.
- Do not expose batteries to heat or flame and do not put them in water.
- Dispose of used batteries according to local regulations.
- Keep these batteries out of the reach of children. Batteries are choking hazards and are very dangerous if swallowed.



Instructions

Do not set the volume too high from the outset.

A loud sound may be produced suddenly that may cause damage to the speaker or your hearing. As a precaution, lower the volume before you switch off this unit then raise it gradually after you switch it back on.



Do not do

When using headphones, do not turn the volume up too loudly.

You may adversely affect your hearing when listening at loud volumes over extended periods of time.



Do not do

Follow the maintenance schedule for this unit. If the interior of the unit has not been cleaned for a long time, dust may build up, which could cause fire or electric shock.

Replace your air filter periodically as needed.

Contact your dealer to clean the interior of the unit as needed.



Instructions

Use and Storage

Take note of the following advice in order to prevent malfunction and damage.

Notes on handling and storage

- Be sure to observe the operating temperatures and storage temperatures given in this guide when using and storing the projector.
- Do not set up the unit in places where it might be subjected to vibration or shock.
- Do not install the unit close to television, radio or video equipment that generates magnetic fields. This may adversely affect the audio and images of this unit, and may cause a malfunction. In the event that such symptoms occur, move the unit further away from any television, radio and video equipment.
- Do not operate the projector under any of the following conditions. If this is not observed, problems with operation or accidents may result.

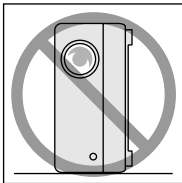

While the projector is standing on its end

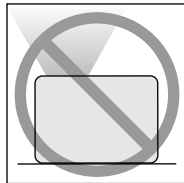

While the projector is placed with the top facing up

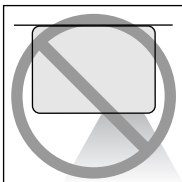

While the projector is placed with the bottom up

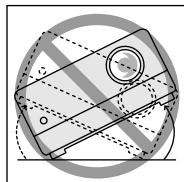

While the projector is tilted to either side

- Do not move this unit during playback. This may damage the disc or cause malfunction.
- Avoid using or storing this unit in cigarette or other smoke filled places, or in rooms containing a large amount of dust. This may cause degradation of the image quality.
- Do not touch the projection lens with your bare hands. If fingerprints or marks are left on the face of the lens, the image will not be projected clearly. When the unit is not in use, be sure to attach the lens cover.
- EPSON will not be held responsible for damage arising from projector or lamp failure outside the

range of that which is covered in your warranty terms.

- You can store the unit in an upright position compactly on a shelf, etc., as it has storage feet on its side. When storing the unit in an upright position, place it on a stable surface with the storage feet at the bottom. Be sure to place the unit in the storage case supplied with the unit so that no dust enters the air intake vent.

Condensation

If you move this unit from a cold place into a warm room, or, if the room in which this unit is installed is heated rapidly, condensation (moisture) may form internally or on the lens surface. If condensation forms, it may not only cause incorrect operation such as weakening of the image, but also damage the disc and/or parts. In order to prevent against condensation, setup this unit in the room approximately one hour before it is to be used. If by some chance condensation does form, disconnect the power cable from the outlet, then wait one to two hours before use.

Lamp

A mercury lamp with high internal pressure is used as the unit's light source.

The characteristics of the mercury lamp are:

- The intensity of the lamp decreases with use.
- When the lamp reaches the end of its life, it will no longer light or may break with a loud noise.
- The life of the lamp may vary greatly depending on the individual lamp characteristics and the operating environment. You should always have a spare lamp ready in case it is needed.
- Once the lamp replacement period has elapsed, the possibility of lamp breakage increases. When the lamp replacement message appears, replace the lamp with a new one as soon as possible.
- This product includes a lamp component that contains mercury (Hg). Please consult your local regulations regarding disposal or recycling. Do not dispose of it with normal waste.

LCD panel

- The LCD panel is manufactured using extremely high-precision technology. However, black dots may appear on the panel, or some red, blue or green dots may light up extremely brightly at times. Furthermore, sometimes striped color irregularities or brightness irregularities may also appear. They are caused by the characteristics of the LCD panel, and are not a sign of malfunction.
- Screen burn may remain in the projected image when a high-contrast still image is projected for more than 15 minutes.

If screen burn has occurred, you should project a bright screen (if a computer is used: white screen, video: as bright an animation as possible) until the screen burn disappears. It takes approx. 30 to 60 minutes, depending on the extent of the screen burn. If the screen burn does not disappear, contact your dealer for advice. ↗ p. 76

When moving this unit

- Close the lens cover.
- Eject the disc.
- Retract the unit feet if extended.
- Carry the unit by holding the handle as shown in the following illustration.

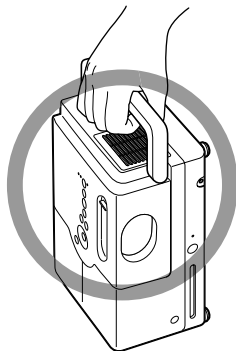

Transportation cautions

- Many glass and precision parts are used within this unit. In order to prevent impact during transportation, re-use the box and protective packaging you received at the time of purchase. If you no longer have the original packing, protect the outside of this unit with shock absorbing material to protect it from impact, place it inside a strong box and make sure it is clearly labeled for the transportation of precision equipment.
 - Close the lens cover and pack the unit.
 - If using a courier service for transportation, inform them that this unit contains precision equipment and should be handled accordingly.
- * Your warranty does not cover any damages that may occur to this product during transportation.

Copyrights























Reproduction of a disc for the purposes of broadcast, projection in public, public musical performance, or rental (regardless of compensation, remuneration, or lack thereof) without the permission of the copyright owner, is strictly prohibited.













Discs and USB Storage

Discs

Readable disc types

The following discs can be played.

Disc types	Symbols used in this guide	Explanation
DVD video 	 	Commercially available software containing high-quality movies and forms of visual images. You cannot play DVD videos if the disc region code does not correspond to the region code label on the side of this unit.
DVD+RW DVD+R DVD+R DL DVD-RW DVD-R DVD-R DL  	       	DVD discs described on the left, recorded on another DVD recorder. <ul style="list-style-type: none"> • Can play a DVD disc containing video format images. • Can play a DVD disc containing VR format images. • Can play a disc if it has been “finalized” by the DVD recorder that has recorded the images. • Can play the following files recorded in the ISO 9660/UDF format: MP3/WMA/JPEG/MPEG1/2/4/DivX[®]3/4/5/6/DivX[®] Ultra   • Can play only the first session although the unit supports multiple sessions.
Video CD  	 	Software containing images and sound. <ul style="list-style-type: none"> • Can play a Video CD (in version 2.0) with PBC (playback control). • Can play a Super Video CD (SVCD).
CD 	 	The software containing sound and voice.

CD-R/RW CD+R/RW  	       	CDs created with a CD recorder or a computer. <ul style="list-style-type: none"> • Can play the following files recorded in the ISO9660 level-1 or -2/UDF format: MP3/WMA/JPEG/Kodak Picture CD/FujiColor CD/MPEG1/2/4/DivX[®]3/4/5/6/DivX[®] Ultra   • Supports the extended format (Joliet). • Supports multiple sessions. • Can play a disc recorded by packet writing.
--	--	---

- The performance and tonal quality of copy-control CD discs that do not conform to the compact disc (CD) standard cannot be guaranteed with this unit. CDs that conform to the CD standard will bear the following compact disc logo mark. Check what is displayed on the packaging of the audio disc.

- This unit conforms to the NTSC and PAL television signal formats.
- In the case of DVD video, SVCD, and Video CD, playback functions may be intentionally limited by the software producers. As this unit plays back the contents of a disc certain functions may not work. Refer to the attached user information of the disc being played.
- DVD-R/R DL/RW, DVD+R/R DL/RW, CD-R/RW, and CD+R/RW discs may not be able to be played if they are scratched, dirty, warped, or if the recording status or recording conditions are unsuitable. Also, it may take the unit some time to read the disc data.
- CPRM (Content Protection for Recordable Media) compatible DVD-R discs recorded in the VR format cannot be played back on this unit.
- Only the audio of the following discs can be played back.
- MIX-MODE CD - CD-G - CD-EXTRA
- CD TEXT

Unreadable disc types

- The following discs cannot be played.
 - DVD-ROM - CD-ROM - PHOTO CD
 - DVD audio - SACD - DACD
 - DVD-RAM
- Round discs with a diameter other than 8 cm or 12 cm
- Irregularly shaped discs

Disc Handling

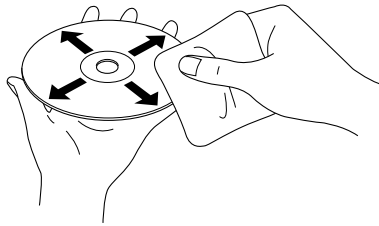
- Avoid touching the playback side with your bare hands.
- Be sure to store discs in their cases when not in use.
- Avoid storing your discs in places with high humidity or in direct sunlight.
- If the playback surface of the disc is dirty with dust or fingerprints, the image and audio quality may deteriorate. When the playback surface is dirty, gently wipe the disc clean with a soft dry cloth, starting from the center of the disc then moving outwards.



- Do not use cleaning products such as benzene, or anti-static products designed for analog records.
- Do not glue paper or attach stickers to a disc.

USB storage that can be played

- You can attach and play the following USB 1.1 based storage devices to the unit:
 - USB memory (only devices that are not equipped with the security function)
 - Multicard reader
 - Digital camera (if USB mass storage class is supported)
- Use a multicard reader to connect an SD memory card or other media to the unit.
- The FAT16 and FAT32 file systems are supported.
- Some system files may not be supported. If the media is not supported, format the media in the Windows system before use.

- This unit can play only one memory card even if multiple cards are mounted on the card reader. Mount only the card you wish to play.

Specifications of files that can be played

File format	File extension*	Specifications
MP3	“.mp3” or “.MP3”	Bit rate: 16 to 320K bps Sampling frequency: 11 kHz, 16 kHz, 22.05 kHz, 32 kHz, 44.1 kHz, 48 kHz
WMA	“.wma” or “.WMA”	Bit rate: 64 to 192K bps Sampling frequency: 44.1 kHz, 48 kHz
DivX® DivX® Ultra	“.divx” or “.DIVX”, “.avi” or “.AVI”	Up to 3M bps Maximum number of pixels: 720 x 576 pixels Optimum frame rate: 30 fps A file may not be in the DivX® file format even if it has an “.avi” or “.AVI” file extension. In such a case, the file cannot be played.
JPEG	“.jpg” or “.JPG”	Number of pixels: Up to 3027 x 2048 pixels No Motion JPEG is supported. JPEG data created by the DCF (Design rule for Camera File system) standard based digital camera is supported. Pictures may not be played back if the auto rotate function of digital still camera is used or if data is processed, edited or saved again using computer image editing software.

*If double-byte character is used for a file name, it will not be displayed correctly.

File size	4GB
Total number of files*	648 files (including folders) + 2 default folders
Total number of folders*	Up to 300 folders

*This figure is unlimited if “MP3/JPEG Nav” from the settings menu is set to “Without Menu”.

Parts Name and Functions

Front

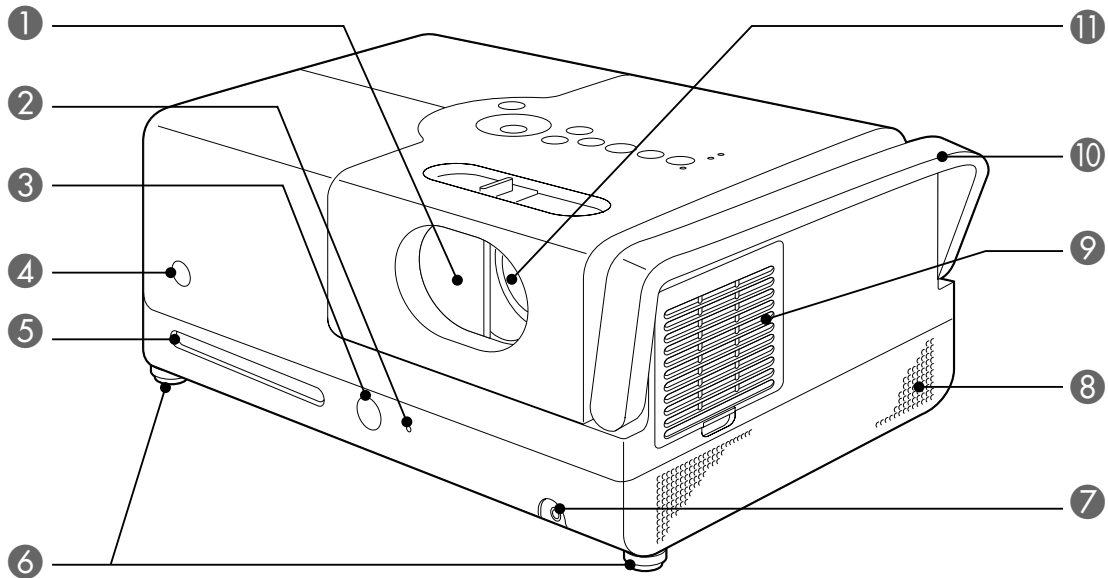

Name	Function
① Slide lens cover	Close the lens cover to protect the lens when the unit is not in use. You can stop the projection completely by closing the lens cover during projection. However, if this state continues for 30 minutes, the unit lamp is turned off automatically. ☞ p. 18
② Disc indicator	Lights up green when a disc is inserted into the disc slot. ☞ p. 19
③ Eject button	Press this button to eject a disc from the disc slot. ☞ p. 22
④ Remote control light-receiving area	Receives signals from the remote control. ☞ p. 16
⑤ Disc slot	Insert a disc you wish to play. ☞ p. 19
⑥ Feet	The feet on the side of the projection lens can be extended by turning them. Extending the feet to the maximum extent tilts this unit by approximately 5 degrees. ☞ p. 21
⑦ Headphone jack	Connects a headphone to the unit. ☞ p. 47
⑧ Speakers	Placed on the left and right; supports Dolby Virtual Speaker. ☞ p. 48
⑨ Air intake vent	Take the cooling air into the unit. If dust collects on the air intake vent it can cause the internal temperature of the unit to rise, and this can lead to operation problems and a shortening of the service life of optical parts. Clean it periodically. ☞ p. 63
⑩ Handle	Hold this handle when carrying the unit. ☞ p. 9
⑪ Projection lens	Projects an image.

Rear

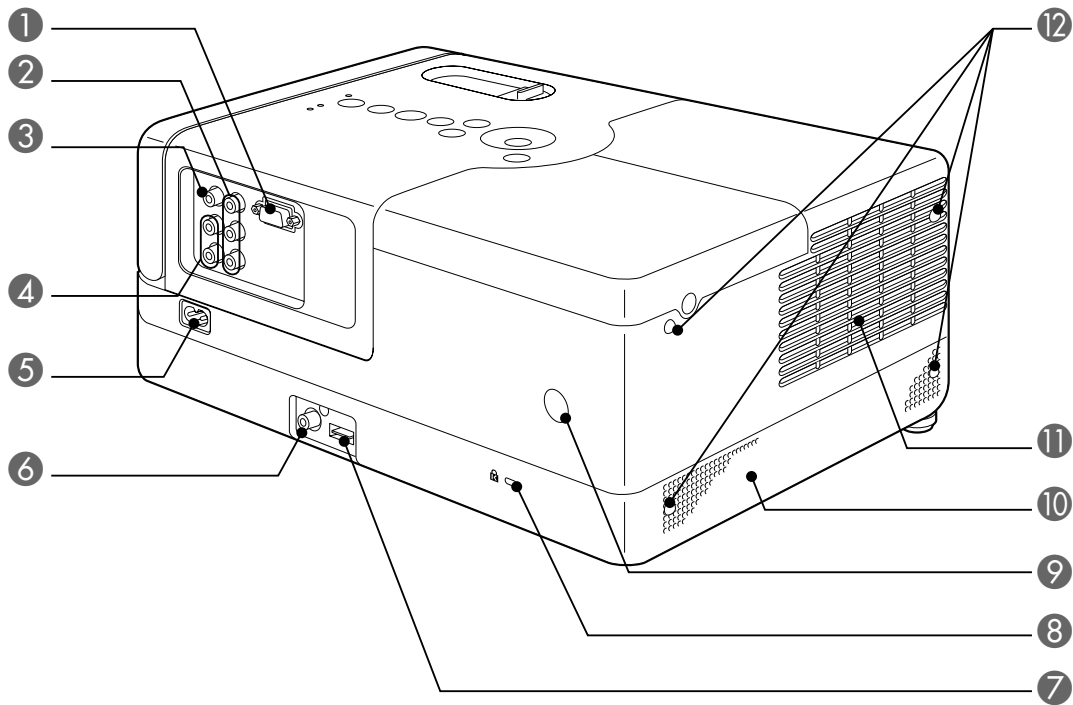



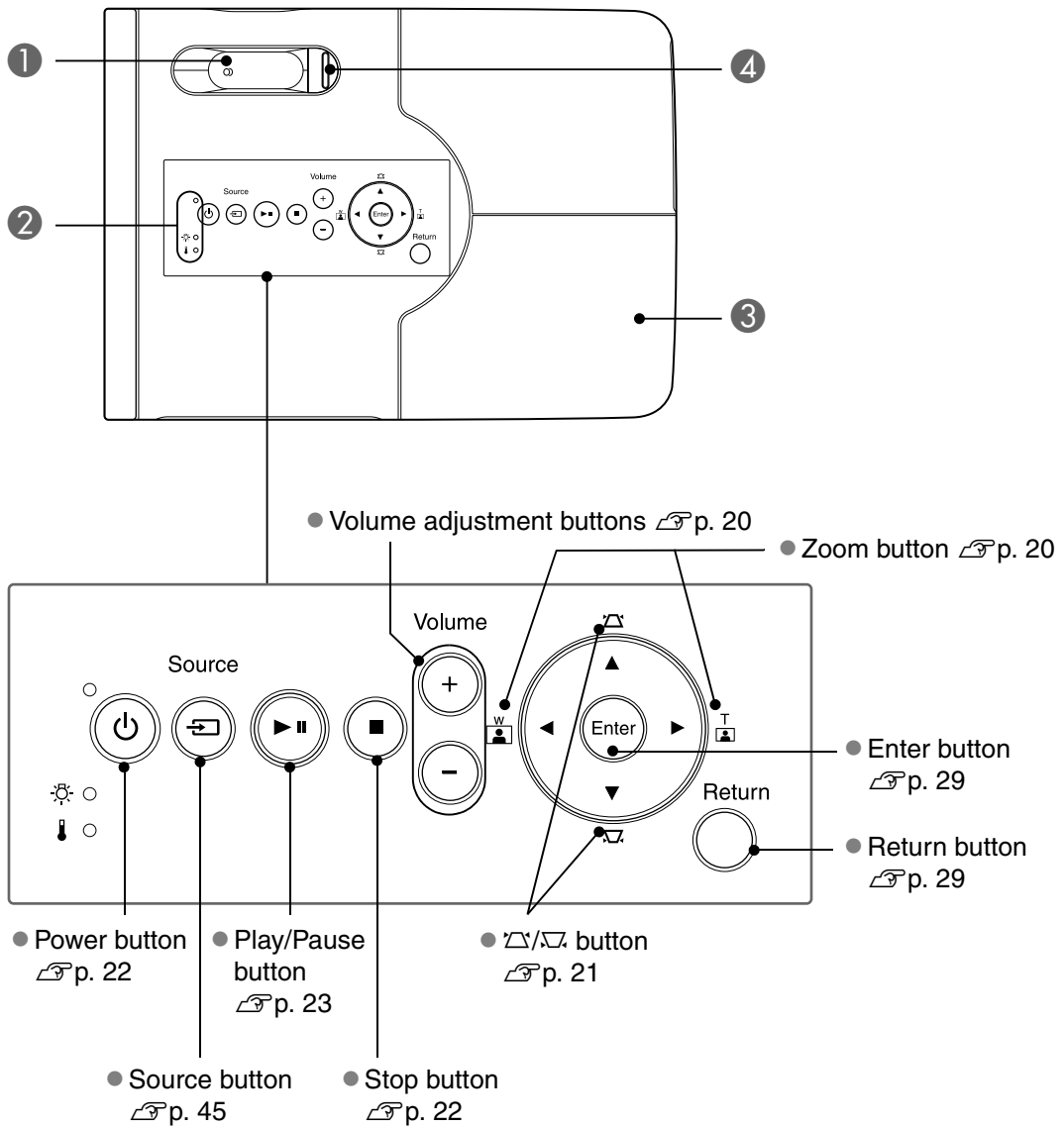

Name	Function
① Computer input port	Can be connected to the RGB output port of a computer. ↗ p. 44
② Component input port	Can be connected to the component (YCbCr or YPbPr) output port of a video device. ↗ p. 44
③ Video input port	Can be connected to the ordinary image output port of a video device. ↗ p. 43
④ Audio input port	Can be connected to the audio output port of the connected video device or a computer. ↗ p. 43, 44
⑤ Power inlet port	Connect the power cable. 18
⑥ Digital Coaxial Audio-Out port	Can be connected to an audio device with a digital coaxial audio input port. ↗ p. 48
⑦ USB port	Connects a USB 1.1-based USB memory or a multcard reader to play the MP3/WMA, JPEG, DivX [®] and other format storages. ↗ p. 42
⑧ Security slot (K)	Supports Kensington's micro saver security system. For details, access the Kensington website at http://www.kensington.com/ .
⑨ Remote control light-receiving area	Receives signals from the remote control. ↗ p. 16
⑩ Speakers	Placed on the left and right; supports Dolby Virtual Speaker. ↗ p. 48
⑪ Air exhaust vent	The air outlet of the unit after cooling.
⚠ Caution	
Do not block the exhaust vents, and do not touch the exhaust vent immediately after projecting, or while projecting, since it becomes hot.	
⑫ Storage feet	Used when placing the unit in an upright position. When storing the unit in an upright position, place it on a stable surface with the storage feet at the bottom. Be sure to place the unit in the storage case supplied with the unit so that no dust enters the air intake vent.

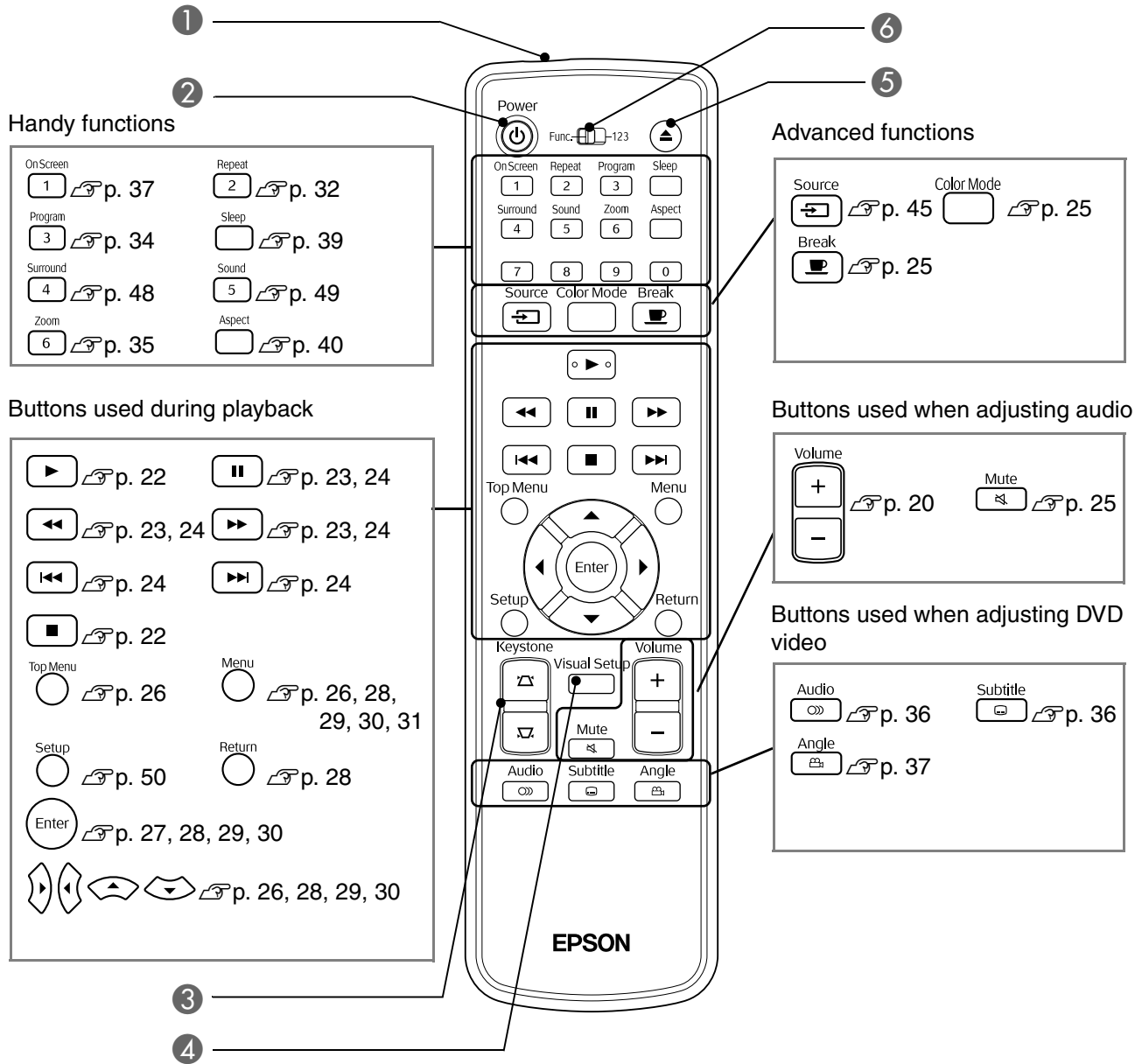

Name	Function
① Focusing ring	Move to the left or right for image focusing. ↗ p. 20
② Status indicator	If a problem occurs in the unit, the status indicator blinks or lights up to indicate the problem. ↗ p. 58
③ Lamp cover	When replacing the lamp, open this cover and replace the lamp. ↗ p. 66
④ Lens cover knob	Slide the holder to open or close the lens cover. ↗ p. 18

Remote Control



Name	Function
1 Remote control light-emitting area	Emits remote control signals. p. 16
2 	Turns power supply to the unit on or off. p. 22
3 	Corrects keystone distortion of the screen image to square or rectangular. p. 21
4 	Displays or closes the projection adjustment and checkout menu. p. 55
5 	Press this button to eject a disc from the disc slot. p. 22
6 Function/numeric toggle switch	Switches between the functions and numerics you wish to use. Slide this switch to the Function position to use any function. p. 26

Preparing the Remote Control

Inserting the batteries

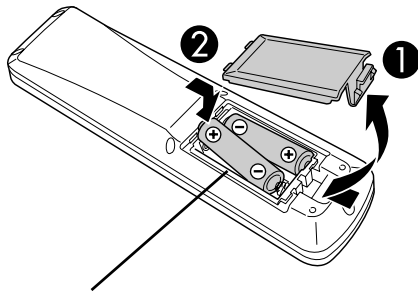

⚠ Caution

Check the positions of the (+) and (-) marks inside the battery holder to ensure the batteries are inserted the correct way.

At the time of purchase, the batteries are not installed into the remote control. Insert the batteries provided with this unit, before use.

- 1 Push in the catch on the rear of the remote control, then lift it upwards.
- 2 Insert the batteries observing correct polarity.
- 3 Close the battery cover.



TIP

If delays in the responsiveness of the remote control occur, or if it does not operate after it has been used for some time, it probably means that the batteries are becoming flat and need to be replaced. Have two spare AA-size alkaline (manganese) batteries ready to use when required.

Remote control usage range

Operable range (horizontal)

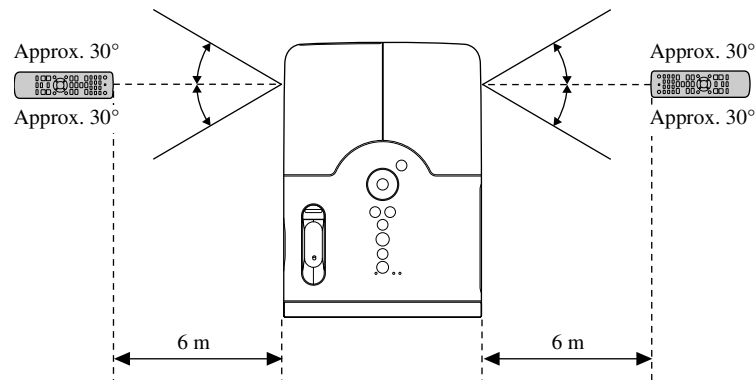

Operable range (vertical)

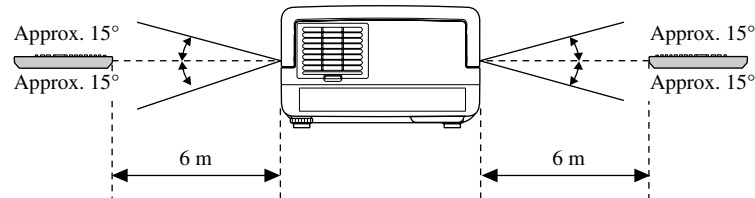

TIP

Avoid allowing direct sunlight or fluorescent light to fall on the remote control light-receiving area of this unit. The signal from the remote control may not be able to be received.

Quick Start

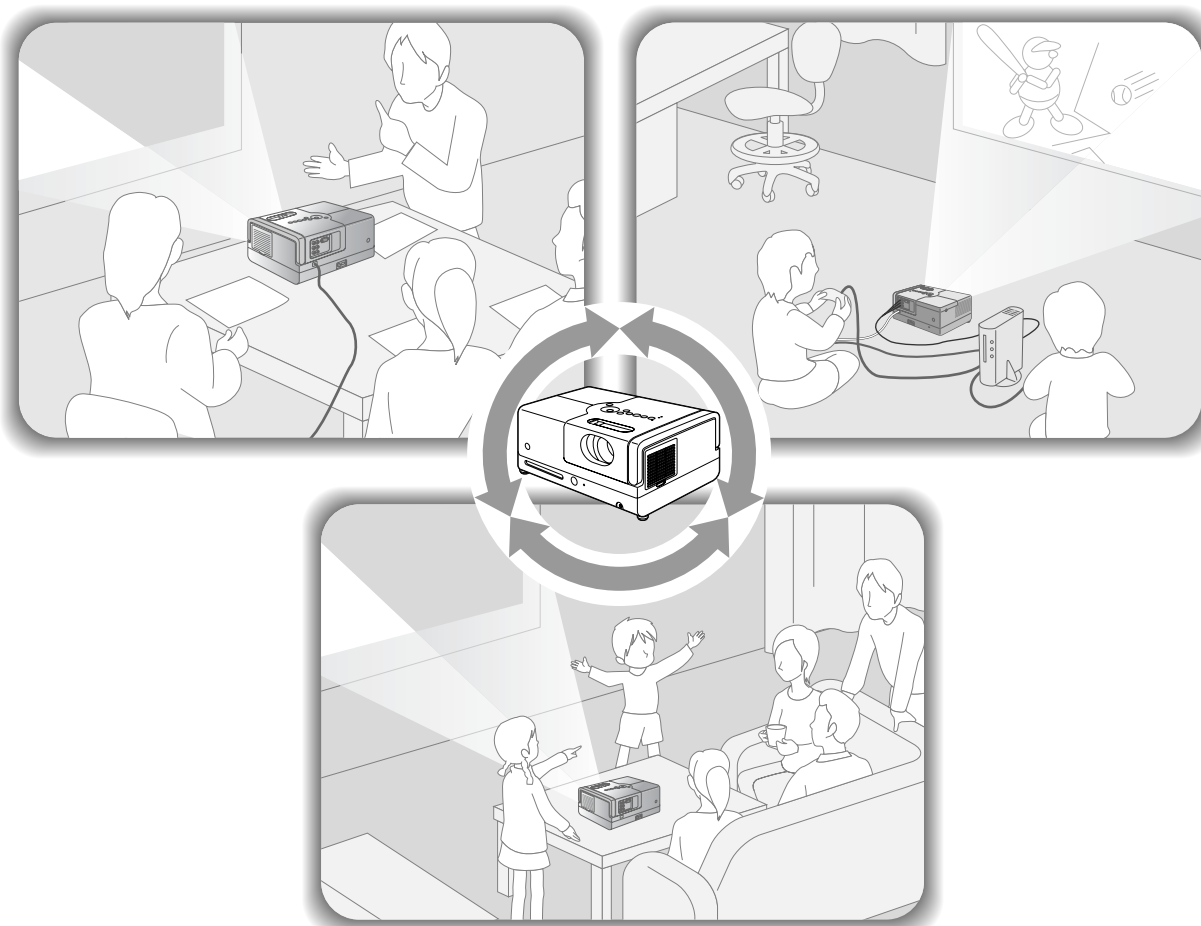

Playback procedure

No complicated connections are necessary. You do not even need to select the television type or change the input. You can enjoy your DVDs on the big screen by following these four easy steps.

The standard speakers support Dolby Virtual Speaker, and you can enjoy real stereo surround sound using the left and right speakers.

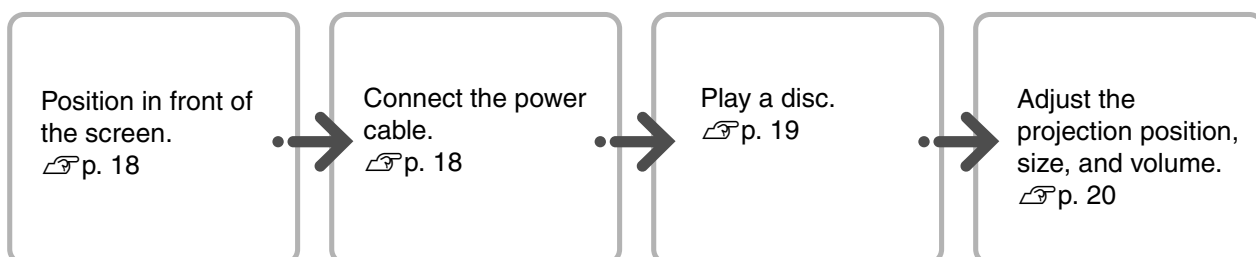

Installation

Projection distance and screen size

- 1 Place the unit in a position that will enable the optimum size image to be projected on the screen.

When you use a 16:9 ratio, 80" type widescreen, for example, place the unit approximately 237 cm away from the screen.

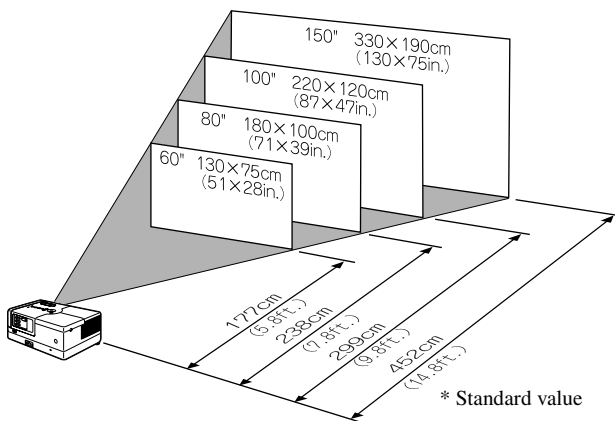

The further this unit is moved away from the screen, the larger the projected image becomes.

For detailed projection distance values p. 69

- 2 Position this unit so that it is parallel to the screen.

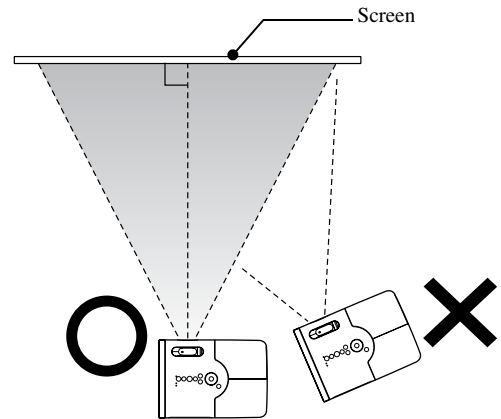

If this unit is not placed parallel to the screen, the projected image is distorted in the shape of a keystone.

Connecting the power cable

- 1 Connect the power cable.

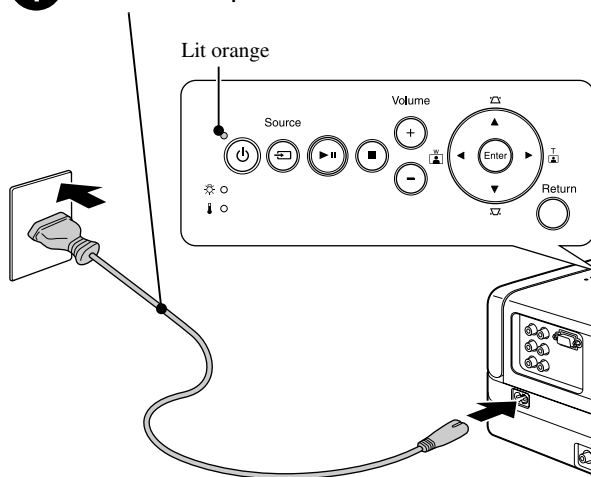

- 2 Open the lens cover.

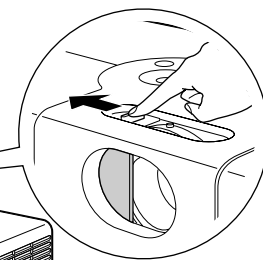

Disc Playback

Playing a disc and projecting



- 1 Insert the disc into its slot by facing the disc label upward.

If you are using a dual-side disc, face the side you wish to play downwards.

Insert an 8-cm disc into the disc slot center position.

A short beep sounds and the power comes on.

Inserting the disc makes the Disc indicator light up green.

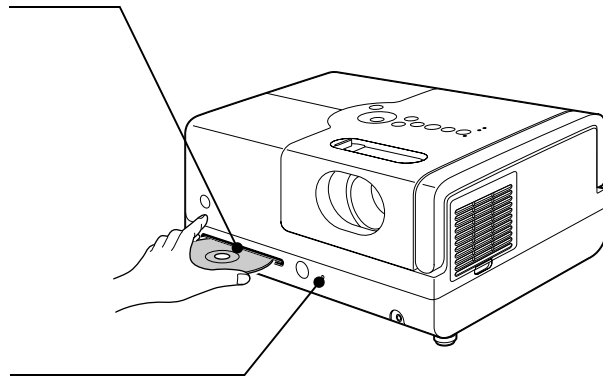

CAUTION

Do not use discs with any CD/DVD label stickers stuck to them, and do not use discs that have condensation on them. This may cause malfunction or damage.

- 2 Start playback.

The projection lamp lights up automatically, and projection begins. It takes approximately 30 seconds from when the lamp lights up until the image is projected brightly.

When the Menu appears:

DVD Video ↗ p. 26

Video CD ↗ p. 27

MP3/WMA **DivX** ↗ p. 29



TIP

When using this unit at high altitudes, that is 1500 m or more above sea level, set “High Altitude Mode” to “On”. ↗ p. 56

⚠ Caution

Never look at the lens after you have turned the unit power switch to On.

Close the lens cover before inserting or ejecting a disc.

Adjusting the projection position and volume

Adjust the volume and image being projected.

Fine-tuning the projection size (Zoom button)

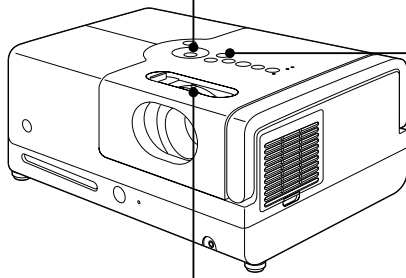
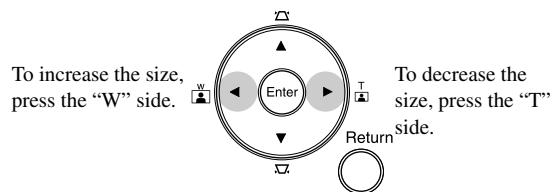
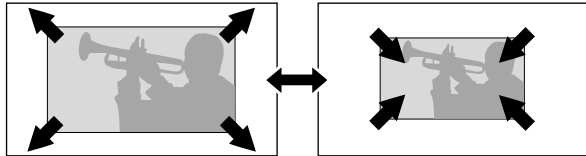

Volume control (Volume)

Using the main unit

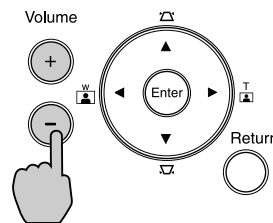

Using the remote control

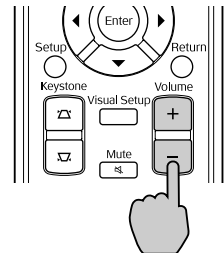

Focusing (Focus ring)

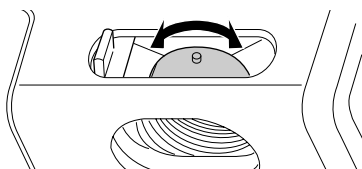
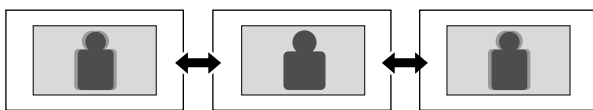

Correcting keystone distortion of the image (Keystone)

To raise the position of the projected image on the screen, extend the front adjustable feet by turning them.

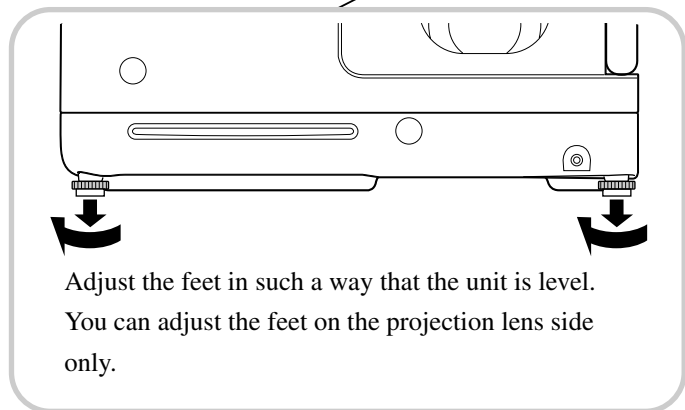
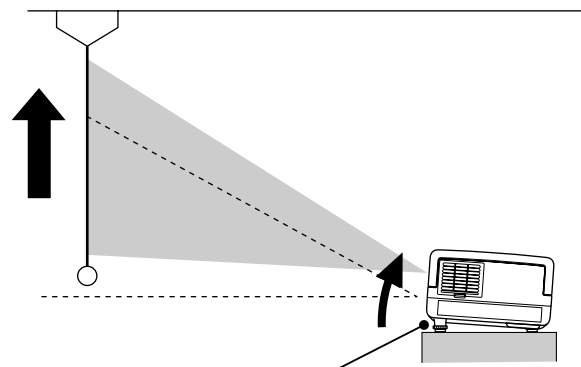

If you extend the foot and tilt the unit, the image will have keystone distortion. Reshape the keystone distortion as follows:

When the top of the image is wide



When the bottom of the image is wide

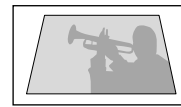

Adjustment on the main unit

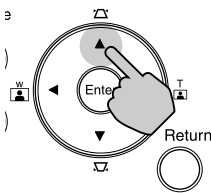

Using the remote control

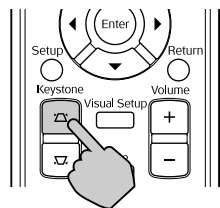

Adjustment on the main unit

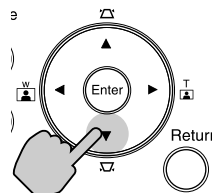

Using the remote control

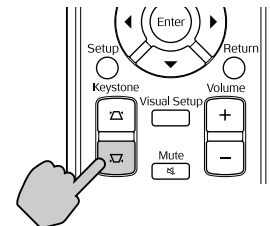



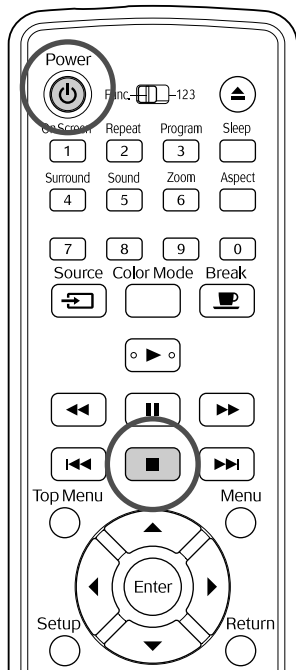

If the unit is tilted by up to 15° degrees in an upward or downward orientation, you can correct the image shape. However, it will be difficult to focus if the tilt angle is large.







Stopping playback







Press .

    After stopping, when you press , playback is resumed from the interrupted scene (resume).

Notes on resume play

- If you press  when “Loading” is displayed on the screen, “Resume Play” is displayed and the disc is played from the last stop position.
- Remember that the resume play function is canceled if you press  twice.
- You cannot resume playing a disc indicated as   on the File List and on VR formatted .
- You can resume playing up to 10 discs that you have recently played even if you replace the discs.
- The position from where playback resumes may be slightly different to where playback was stopped.
- The audio language, subtitle language, and angle settings are memorized along with the stopping position.
- If you stop play when the disc menu is displayed, the resume play may fail.

Turning off the power

- 1 When you have played back a disc, press  to eject the disc from its slot.
 - Once you have pressed , if you want to play back the ejected disc again, you cannot push it back into the disc slot manually. Press .
- 2 Press .
- 3 If the lamp was on, the lamp turns off and the Power indicator on the main unit flashes orange (during cool-down).
- 4 The confirmation buzzer beeps twice to indicate that cool-down has completed. Unplug the power cable from the electrical outlet.

If you only press  to turn off the power, electricity continues to be consumed.

- 5 Close the lens cover.

Keep the lens cover in place when the unit is not being used to protect the lens from dirt and damage.



The Power indicator flashes orange to indicate that the internal lamp cooling function (cool-down) is taking place. The buttons on the remote control and the main unit are disabled when cool-down is taking place (approx. 5 seconds).

CAUTION

Do not unplug the power cable during cool-down. This may reduce the lifespan of the lamp.

Basic Playback Operations

From here on, operations are explained primarily using the buttons of the remote control. You can also use the buttons with the same markings as those on the unit control panel to achieve the same effect.

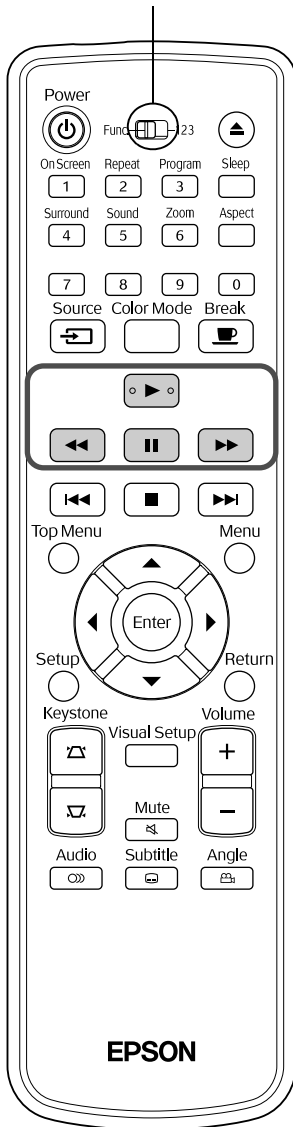

Set the [Function] position before performing operations



Pause



Press  during playback.

- Press  on the operation panel. The play is paused and restarted each time you press .
- To resume playback, press .

Reverse search/forward search



Press  or  during playback.

- There are five levels of reverse/forward search speeds that change each time the buttons are pressed.
- Press  to return to normal playback.



TIP

Depending on the disc you use, the sound may not be audible during forward/reverse search.

Set the [Function] position before performing operations

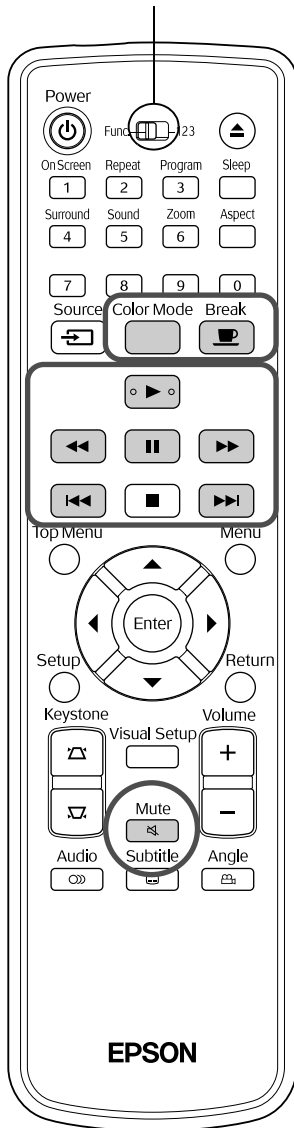

Skip



Press or during playback or when paused.

DVD Video **Video CD** **Audio CD** If you press once during chapter/track playback, playback returns to the start of the chapter or track being played. After this, playback returns to the start of the previous chapter/track each time you press . After this, playback returns to the start of the previous chapter/track each time you press .



TIP

- If you press / once when a **DVD Video** **DivX** disc is being paused, the previous chapter (file) or the next chapter (file) is played.

Frame advance



Press during paused playback.

- A single frame is advanced each time you press . This unit does not have a frame return function.
- Press to return to normal playback.

Slow motion playback



1 Press at the point where you want to begin slow motion playback in order to pause the image.

2 Press .



- There are 4 levels of playback speed, selectable each time is pressed.
- When playing a **DVD Video**, slow motion review can be performed by pressing . There are 4 levels of rewinding speed that change each time is pressed.
- Press to return to normal playback.
- No sound is output during slow motion playback.

Temporarily using the projector's light as illumination (Break)



The break function is useful if, in the middle of a movie, you want to get up or move around, get a drink, or some food, and so on. By simply pressing the  button you can pause the disc being played until you can get up to turn the lights on in the room.

Press  during playback.

- The projection lamp remains lit, whilst the projected image disappears.  flashes in the lower right portion of the screen.
- The screen darkens after about five minutes if the unit is left in break mode without any operations being made. Additionally, after approximately 30 minutes have elapsed, power to the unit automatically turns off.
- Press  to return to the state before the break button was pressed. If the power has switched off, press  to switch the power back on.



TIP

- Operations cannot be performed when the disc menu is displayed.
- When you press any of the following buttons, break mode is cancelled and the function of the button you pressed is performed.



Color Mode



You can select a picture quality to correspond to the brightness and other conditions of your room.

1 Press .

The currently selected color mode name is displayed on the screen.



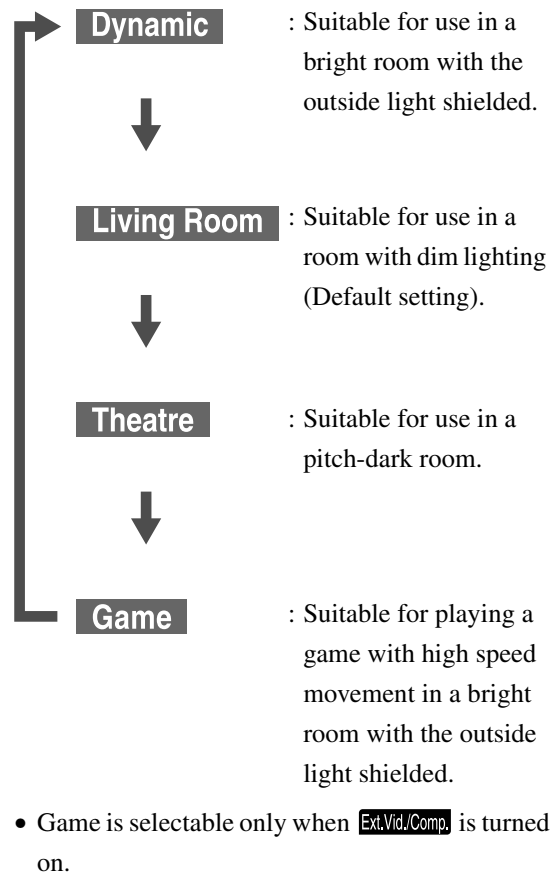

2 While the color mode name is displayed, press  repeatedly until the desired color mode appears.

After waiting a few seconds, the color mode name disappears and the picture quality changes.



Mute

Press  during playback.

- Sound stops coming from the speakers and headphones.
- Press  to return to normal playback. The former volume is also restored when power to the unit is turned on again.

Advanced Operations

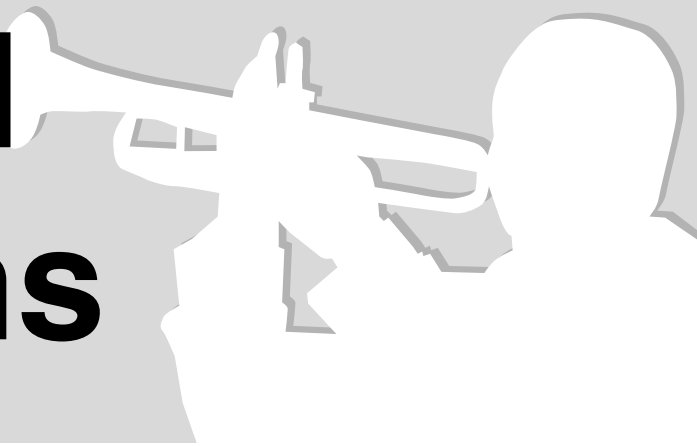

Becoming a playback expert

Playback from a DVD menu

DVD
Video

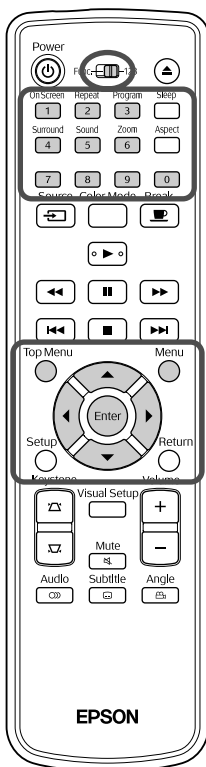

Some **DVD Video** discs have the following kinds of original menus saved in them.

- **Root Menu:** When multiple titles (image and audio) have been recorded, this integrated disc information is displayed.
- **Menu:** Title-specific playback data (chapter, angle, audio, and subtitle menus) is displayed.

1 Press  or  during playback.

2 Press     and select the item you want to see.

You can also select the title number or chapter number directly using the numeric buttons.

When using the numeric buttons



With the function/numerics toggle switch in the [1 2 3] position, press the following buttons.

Example)

5: 

10:  → 

15:  → 

20:  → 

Once you have finished entering numbers, return the function/numerics toggle switch back to the [Function] position.

3 Press .



TIP

- Certain discs may not contain a menu. If a menu is not recorded, these operations cannot be executed.
- Depending on the disc, playback may begin automatically, even if  is not pressed.

Playback a Video CD from the menu

Video CD

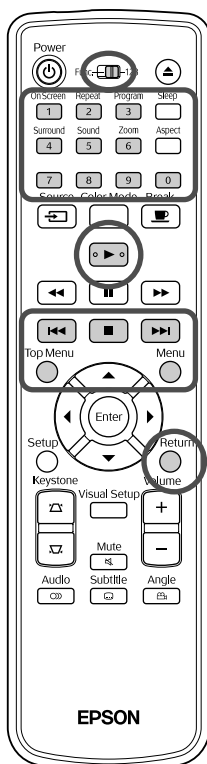

You can play a **Video CD** disc by selecting the desired chapter from any of the following two menus.

- **PBC (Playback control) function:** If a Video CD with “PBC (playback control) enabled” specified on the disc or jacket is inserted into the disc slot, a menu screen is displayed. You can select the scene or information you wish to see interactively from this menu.
- **Preview function:** You can select the desired track or scene and play it back in the following three formats.

Track Digest: Plays the first three or four seconds of each track sequentially. Six tracks are projected on a single screen page.



Disc Interval: The total disc time is divided by six, and the first three or four seconds of each interval are played. Six images are projected on a single screen page.

Track Interval: When a track is being played, it is divided by six and the first three or four seconds of each interval are played. Six images are projected on a single screen page.

PBC (playback control) playback

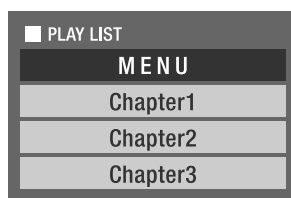

- 1 When playing a Video CD that contains PBC, the following kind of menu is displayed.





- 2 Select the item you want to see using   or the numeric buttons. [p. 26](#)

The selected contents are played.

To turn to the previous/next page of the menu screen



Press / when the menu screen is displayed.

To call the menu screen during playback

Each time  is pressed, the menu goes back by one step. Press  repeatedly until the menu is displayed.

To call the PBC menu screen

When you display the playback information or the preview screen, the PBC mode is canceled.

To call the PBC menu again during play, stop play by pressing  twice. Then, press .



If you select “Others” from the settings menu and set “PBC” to “Off”, the disc is played directly without displaying the menu screen. PBC is “On” by default.  p. 52

To play using the Preview function





- 1 If you press  while a video CD is playing, the following Preview menu is displayed.



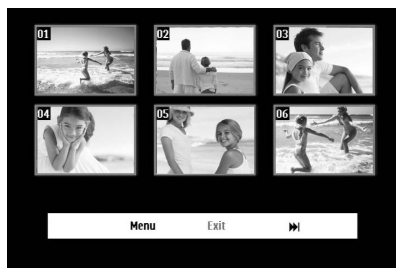



- You can also use Track Digest and Disc Interval by pressing  when stopped.

- 2 Select an item by pressing  , and press .



- If a disc contains six or more tracks, you can press   to display the next or previous page when you select Track Digest.
- You can return to the initial menu by selecting “Menu” and pressing .
- You can close the Preview menu by selecting “Exit” and pressing .

- 3** Select the track you want to see using    , and press .

The selected track is played.

JPEG, MP3/WMA and DivX® playback



Set the [Function] position before performing operations

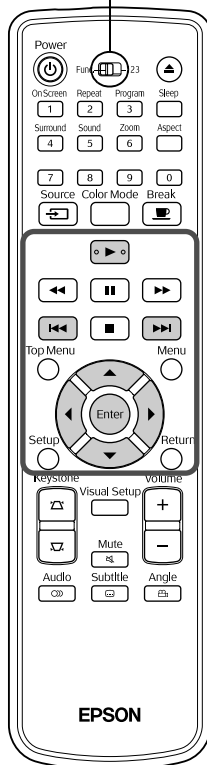



Although the **JPEG**, **MP3/WMA** or **DivX** files stored in a disc and a USB storage device are played back by selecting the desired file from a File List, the function varies depending on the file, as follows.



- If a **JPEG** in the folder is selected, the JPEG files stored in the folder are played back starting from the selected file in Slideshow sequence.
- **MP3/WMA** files are automatically played back, starting from the first file. If you want to play back another file, select a file from the File List displayed.

If a Kodak Picture CD or FUJICOLOR CD is inserted into the disc slot, Slideshow playback is automatically performed.

- 1** When you play back a disc containing **JPEG**, **MP3/WMA** or **DivX** files, or a USB storage device, the following File List is displayed.



- 2** Select a folder or file using  .

- When the File List is displayed, you can go to the next or previous page by using  . When you are on the first page, the  button is ineffective and vice versa.

- 3** Press  or  to begin playback.







If  is pressed while playing back **JPEG**, **MP3/WMA**, Kodak Picture CD or FUJICOLOR CD, the display returns to the File List.

- If **DivX** is displayed, you will return to the File List when you press  twice.







- When you select “Others” from the settings menu and set the “MP3/JPEG Nav” to “Without Menu”, all MP3, WMA, JPEG and DivX[®] files are listed. “With Menu” is set by default. [↩](#) p. 52
- MP3/WMA ID3 tag is supported. The album name, artist name, and track name, if set, are displayed at the right of the File List (only alphanumeric characters are supported).

Slideshow Playback Operation

- The image switching interval depends on the selected image size.
- The Slideshow ends after projection of all JPEG files in the folder.
- You can rotate an image by pressing .
- You can reverse the top and bottom of an image by pressing .
- You can reverse the right and left of an image by pressing .
- If you press  during Slideshow playback, the Slideshow is canceled and the thumbnail list is displayed.
- If you press  during Slideshow playback, the File List is displayed.
If you select the desired JPEG file from the list and press , the Slideshow will start.
- A progressive JPEG file takes a longer time to start when compared with a baseline JPEG file.
- The JPEG files stored in a USB storage device are also played in the Slideshow.

Operations from the thumbnail list



- If a disc contains 12 or more JPEG files, you can display the previous or next page using  .
- When you select the desired thumbnail and press , the Slideshow restarts from the selected position.
- When you press , the File List is displayed. If you select the desired JPEG file from the list and press , the Slideshow will start.





When playing MP3/WMA audio

Once menu selection is complete and the audio begins, close the lens cover. The projection lamp turns off and you can enjoy just the music being played. Open the lens cover to turn the lamp back on.

Simultaneous MP3/WMA and JPEG playback

If a disc contains a mix of MP3/WMA and JPEG files, you can enjoy the Slideshow with sounds.

When a disc containing both MP3/WMA and JPEG files is inserted into the disc slot, the MP3/WMA files are automatically played. If a JPEG file from the File List displayed is selected, the Slideshow will start.

- The Slideshow ends after projection of all JPEG files in the folder.
- When you press  during simultaneous file play, the Slideshow is canceled and the file thumbnail list is displayed. When you select the desired thumbnail from its list and press , the Slideshow restarts from the selected position.
- You can return to the File List screen by pressing  during simultaneous file play. You can select the desired MP3/WMA file and press . Then, when you select a JPEG file for Slideshow and press , the selected items are played back simultaneously.
- If a USB storage device has both MP3/WMA and JPEG files, you can also enjoy the Slideshow with sound.

Notes on playback

- Depending on the recording and the characteristics of the disc it is possible that the disc may not be readable, or that disc reading may take some time.
- The time it takes to read a disc differs depending on the number of folders or files recorded on the disc.
- The order of the File List displayed on the screen may differ from the order displayed on the computer monitor.
- Files of a commercial MP3 disc may be played in the different order from those recorded on the disc.
- It may take some time to play MP3 files containing still picture data. The time-elapsed is not displayed until playback has commenced. Further, there are times when an accurate elapsed time is not displayed, even once playback has commenced.
- It is possible that data that has been processed, edited, or saved using computer image editing software might not play.
- When playing back a Slideshow, JPEG files may be played in a different order from that recorded on the disc, and you cannot change the order in which they are played back.

Playback by selecting the chapter or track number



During playback or when paused, select the chapter or track number you wish to play by pressing the numeric buttons.

☞ “When using the numeric buttons” p. 26



- **Audio CD** **MP3/WMA** **JPEG** Can also be used when stopped.
- Depending on the disc, certain operations may not be possible.

Repeat play and random play



Set the [Function] position before performing operations

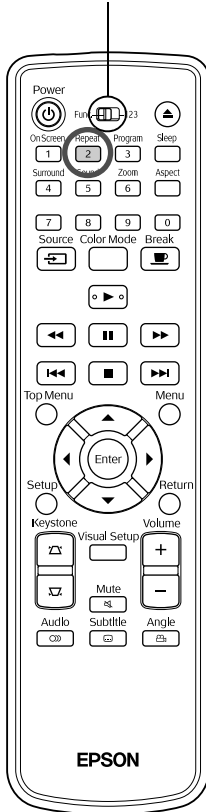

Depending on the type of disc, you can loop playback within a range of titles, chapters, or tracks, as in the table below.

Press ^{Repeat} **2** during playback.

The repeat mode changes whenever you press ^{Repeat} **2** and the repeat mode name and icon are displayed on the screen.



- **Video CD** is not available when playing back using the PBC function.

DVD Video

Screen display	Function	Contents
Chapter	Chapter repeat	Repeats the current chapter.
Title	Title repeat	Repeats the current title.
Shuffle	Random play	Randomly plays titles and chapters.
Shuffle Repeat	Random repeat	Repeats random play. Tracks are played in a different order when repeated.
Repeat Off	Repeat Off	Cancels repeat or random play.

Video CD Audio CD

Screen display	Function	Contents
Track	Track repeat	Repeats the current track.
All	Disc repeat	Repeats entire tracks of the disc.
Shuffle	Random play	Randomly plays all tracks of the disc.
Shuffle Repeat	Random repeat	Repeats random play. Tracks are played in a different order when repeated.
Repeat Off	Repeat Off	Cancels repeat or random play.

MP3/WMA JPEG DivX

(If “Others” is selected from the settings menu and if “MP3/JPEG Nav” is set to “With Menu”)

Screen display	Function	Contents
Repeat One	File repeat	Repeats the current file.
Repeat Folder	Folder repeat	Repeats files in the current folder.
Shuffle	Random play	Randomly plays files in the current folder.
Repeat Off	Repeat Off	Cancels repeat or random play.

MP3/WMA JPEG DivX

(If “Others” is selected from the settings menu and if “MP3/JPEG Nav” is set to “Without Menu”)



Screen display	Function	Contents
Repeat One	File repeat	Repeats the current file.
Repeat All	Disc repeat	Repeats all files on the current disc.
Shuffle	Random play	Randomly plays all files on the disc.
Repeat Off	Repeat Off	Cancels repeat or random play.

Canceling repeat play

Press  repeatedly until “Repeat Off” is displayed on the screen.



TIP

- **DVD Video** does not allow use of the “Title repeat” function with some DVDs.
- You can also repeat the play from the playback information screen.
 p. 37
- The  button is ineffective during program play.

Program play

DVD Video Video CD Audio CD

Set the [Function] position before performing operations

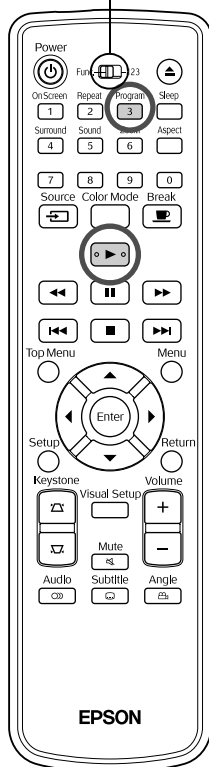

You can set titles, chapters, and tracks to playback in your order of preference.

1 Press **[3]** during play or when paused.

The program screen will appear for you to set a playback sequence.

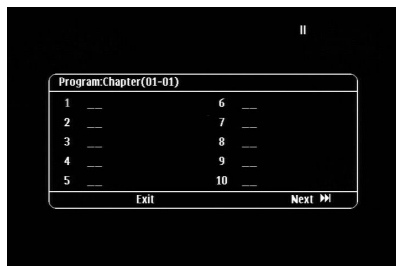

2 Using the numeric keys, enter title and track/chapter numbers sequentially.

☞ “When using the numeric buttons” p. 26

- Use to shift the cursor in respective directions.
- If the disc has 10 or more tracks/chapters, either press or select “Next” on the screen and press to display the next page. To display the previous page, either press or select “Previous” on the screen and press .
- If you wish to delete a track or chapter you have entered, position the pointer on it and press .
- To close the program screen, select “Exit” from the program screen and press .

3 When you have set the playback sequence, select “Start” from the screen and press .

- Playback starts in the set sequence.
- Once the set playback is fully complete, playback stops.

Canceling program play

- Press .
- Turn the power switch off.

Resuming normal playback

Stop play and press .



TIP

- You can set the program play of up to 10 discs. Also, you can set up to 20 tracks or chapters of each disc. Your settings are held in memory even when you have changed the discs. Insert the disc with the playback sequence set in the disc slot, press ^{Program} **[3]**, and select “Start” from the program screen. Program play starts.
- Pressing ^{Repeat} **[2]** during program play will not function.
- You may not use the program play for some types of discs.

Zoom In



Set the [Function] position before performing operations

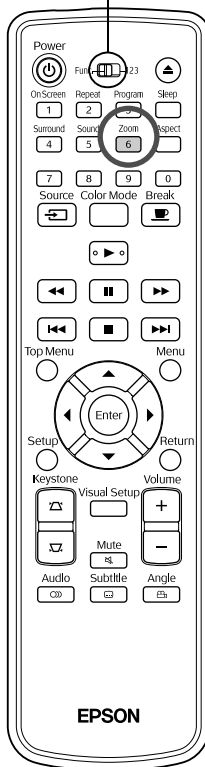

You can zoom (enlarge or compress) the projection image on the unit screen. If the enlarged image exceeds the screen size, you can display it by panning.

- 1 Press ^{Zoom} **[6]** during playback.

The magnification (or zoom rate) is displayed.



- 2 Select the desired magnification by pressing ^{Zoom} **[6]** repeatedly.

- You can only enlarge **JPEG** images. You cannot reduce them.
- After you have enlarged the image, press to pan.
- To return to the original size, press ^{Zoom} **[6]** repeatedly until the Zoom Rate disappears.

Changing the audio language

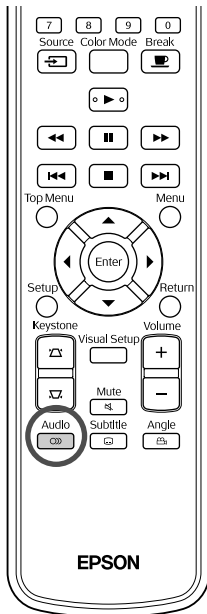

When a disc has been recorded with multiple audio signals or languages, you can switch to the available audio signal or language of your preference.

1 Press  during playback.

The current audio settings are displayed on the screen.

2 Select the desired settings by pressing  repeatedly.



- You can also switch from the playback information screen. [↗](#) p. 37
- If a language code (for example 6978) is displayed [↗](#) p. 53

Changing the subtitles display

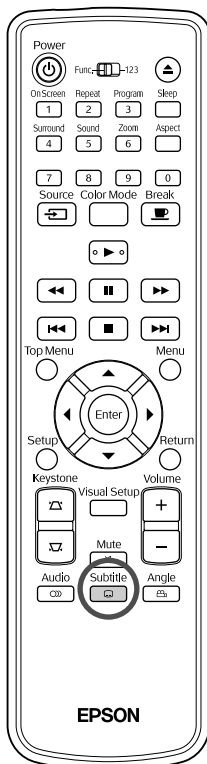

You can choose whether or not to display subtitles for discs that have been recorded with subtitles. If a disc has multiple language subtitles, you can switch to the preferred language.

1 Press  during playback.

The current subtitle settings are displayed on the screen.

2 Select the desired settings by pressing  repeatedly.

- If the available subtitle is not found, the  icon is displayed.



- You can also switch from the playback information screen. [↗](#) p. 37
- When using **DIVX**, you can switch between the embedded subtitle and the subtitle file data. Both of them can be displayed with 45 single-byte characters (27 double-byte characters) on 2 lines maximum. Any excess characters are not displayed.
A subtitle file with any of the following extensions is valid:
“.srt”, “.smi”, “.sub”, “.ssa” and “.ass”;
The subtitle file name must be the same as the file name of the movie.

Changing the angle

DVD
Video

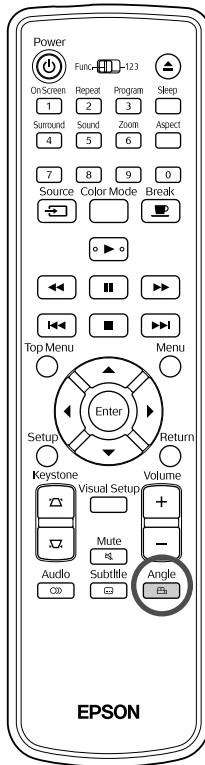

For discs that have been recorded with multiple camera angles, you can switch from the main angle to a different camera angle of your preference, such as from above, or from the right, during playback.

1 Press **Angle** during playback.

The current angle is displayed on the screen.

2 Select the desired angle by pressing **Angle** repeatedly.



TIP

You can also switch from the playback information screen. [p. 37](#)

Carrying out operations from the playback information screen

DVD
Video

Video
CD

Audio
CD

DivX

Set the [Function] position before performing operations

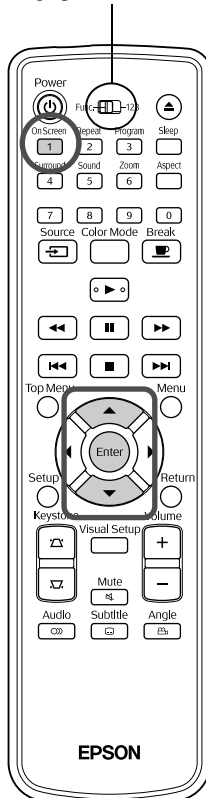



You can check the current playback status and change your settings without stopping the play.





1 Press **OnScreen** during playback.

The projected image is reduced, and the following information screen is displayed under it.

Menu		▶
Title	01/01	
Chapter	01/01	
Audio	2ch	Others
Subtitle	Off	
Bitrate	01	Title Elapsed 0:00:39

- When you are using a **Audio CD**, the playback time is switched as follows each time you press **OnScreen** **1**: “Single Remain” → “Total Elapsed” → “Total Remain” → “Single Elapsed.”
- When you are using a **DivX** **MP3/WMA**, the playback time is switched as follows each time you press **OnScreen** **1**: “Total Elapsed” → “Total Remain” → “-:--:--” (WMA does not support for Track Time)

2 Pressing  , position the pointer on the desired item and press .

- You can set the title/chapter/track number and time by using the numeric keys, and set the play start time.  p. 26
- When the selected item appears, select the desired value using   and press .
- Press  once and the playback information screen disappears.
- When you are using **DIVX** and “-:--:--” is displayed, you can set the play start time of the track by using numeric keys.
- You cannot use this function when play is stopped.

3 Press .

Playback starts with the selected title/chapter/track or specified time settings.



Contents on the playback information screen

DVD Video

Title	Specify a title number you wish to play by using the numeric keys.
Chapter	Specify a chapter number you wish to play by using the numeric keys.
Audio	Select the sound system and the language.
Subtitle	Select to display or not display subtitles and language.
Angle	You can switch the camera angle.
TT time	Set the play start time of a title using the numeric keys.
Ch time	Set the play start time of a chapter using the numeric keys.
Repeat*	Select the repeat play mode.
Time Disp.	Select how to display the play time at bottom right of the playback information screen.

Video CD

Track	Specify a track number you wish to play using the numeric keys.
Disc Time	Set the play start time of a disc using the numeric keys.
Track Time	Set the play start time of a track using the numeric keys.
Repeat*	Select the repeat play mode.
Time Disp.	Select how to display the play time at bottom right of the playback information screen.

*You cannot select random play or random repeat for the repeat setting on the playback information screen. Set it up using .  p. 32

Setting the sleep timer



Set the [Function] position before performing operations

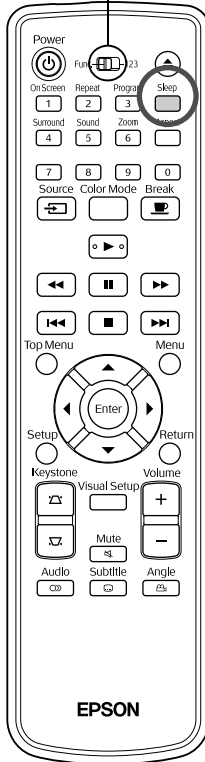

When the time you set on the sleep timer has passed, the unit power switch is turned off automatically. You can prevent unnecessary power from being consumed if you fall asleep while watching a movie.

If the sleep timer is set to “Sleep Off” and if play is stopped or finished and the unit is not operated for approximately 30 minutes, the unit power switch is turned off automatically.

Press .

- When you press , the current sleep timer setting is displayed.

When the sleep timer is displayed, select the desired setting using

.

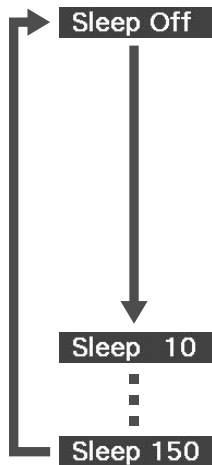

: If the standby screen is projected and if the unit is not operated for approximately 30 minutes, its power switch is turned off automatically. If image signals are not entered in **Ext. Vid./Comp.** mode and if the unit is not operated for approximately 30 minutes, its power switch is turned off automatically (default setting).

: After 10 minutes have elapsed, the power switches off.

: After 150 minutes have elapsed, the power switches off.

Setting the sleep timer

The “Sleep” message is displayed on the screen approximately 20 seconds before automatic power off.

Changing the sleep timer

Press  repeatedly and select the new time.

Checking the sleep timer setting

Once the sleep timer has been set, if you press  once, the remaining time before sleep is displayed on the screen.



TIP

- Sleep timer settings are not memorized. If the power is switched off, the sleep timer is canceled.
- With discs that return to the menu once playback has completed, power to the unit will not turn off even when the “Sleep Off” mode is set.

Changing the aspect ratio

DVD Video Video CD JPEG Ext.Vid./Comp.

Set the [Function] position before performing operations

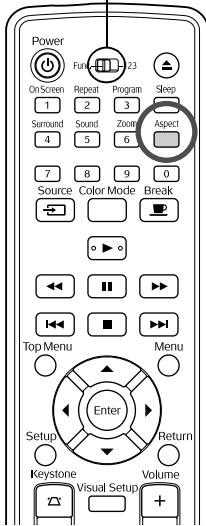

The unit automatically recognizes the aspect suitable for the input signal, and the image is projected in the appropriate aspect. If you want to change the aspect yourself, or if the aspect is not correct, you can change it in the following way.

Press .

- Each time you press  the aspect ratio name is displayed on the screen and the aspect ratio is changed.
- The aspect ratio for disc settings and image signals can be changed in the following way.

When projecting by using the built-in DVD player

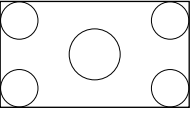
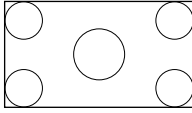
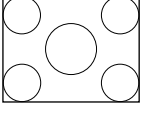
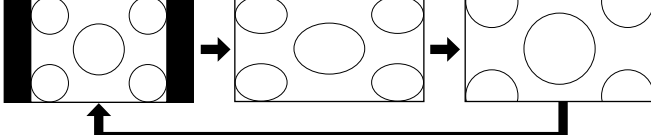
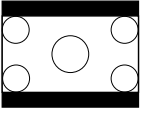
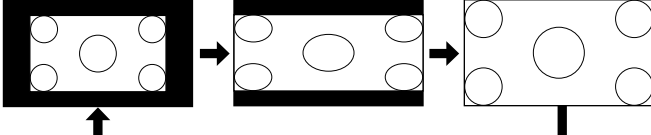
Screen Size	Aspect
<p>16:9</p> 	<p>Fixed to full size (16:9)</p> 
<p>4:3</p> 	<p>Normal → Full → Zoom</p> 
<p>Letterbox</p> 	<p>Normal → Full → Zoom</p> 

* **JPEG** Fixed to normal size when the Slideshow is executed.

When projecting component video (SDTV), composite video images

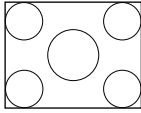
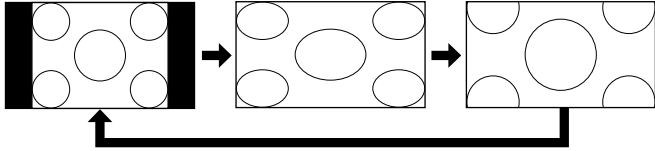
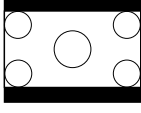
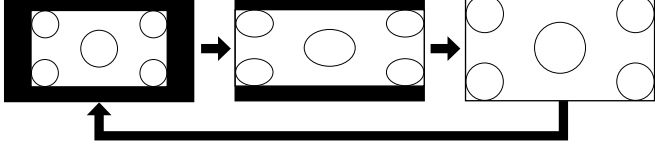
Screen Size	Aspect
4:3 	Normal Full Zoom 
Letterbox 	Normal Full Zoom 

When projecting component video (HDTV) images

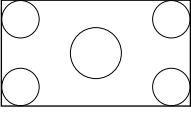
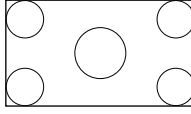
Screen Size	Aspect
16:9 	Fixed to full size (16:9) 

When projecting computer images

Wide panel computer images are always projected at the normal (wide screen) setting.

If wide panel computer images are not projected in the correct aspect, press the button to change to an appropriate aspect.

Playback by attaching a peripheral device

Connecting a USB storage device

You can attach a USB memory or multcard reader that conform to the USB 1.1 to the unit and play the following format files.

- MP3/WMA files
- JPEG files
- DivX[®] files

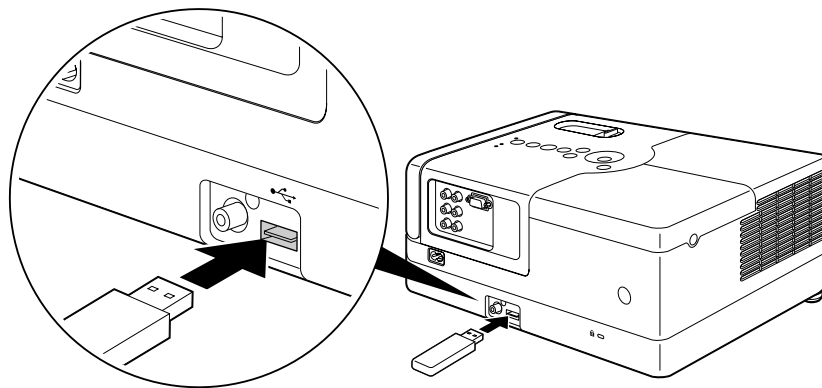

The file playback and your operations during play are the same as when you play files of a **Data CD** using the standard DVD player.



TIP

- When you connect a USB storage device to the unit, the source is changed to the USB and playback starts automatically when:
 - a disc is being played or stopped on the standard DVD player.
 - another video device, a TV set or a computer is connected to the unit and a disc is being played or stopped.
- If you use a USB hub, the unit will not operate normally. Connect the USB storage device directly to the unit.

CAUTION

- When power to the unit is turned on with only a USB storage connected (no disc inserted in the disc slot), the USB storage is not recognized and “No Disc” is displayed. Even if you press , it does not playback. In such a case, remove the USB storage and then reconnect.
- Do not remove the USB storage during a Slideshow. Stop the Slideshow by pressing , and remove the USB storage.

Connecting to another video device, a TV set, or a Computer

Aside from the built-in DVD player, this unit can project images by connecting to a computer or the following devices with a video output port.

- Video recorder - Game machine - Video device with built-in TV tuner - Video camera and others

Video equipment signal format

The kind of video signal that can be output depends on the video equipment. The image quality differs depending on the video signal format. Generally speaking, the order of quality of the image goes as follows.

1. Component video → 2. Composite video

Check which signal system to use in the “Documentation” supplied with the video equipment that is being used. The composite video may be called “Image output”.



TIP If the equipment you are connecting has a unique connector shape, connect using the cable supplied with your equipment, or an optional cable.

CAUTION

- Turn off connected equipment. Damage may result if you try to connect when the power is on.
- Close the lens cover before connecting a device to the unit. If fingerprints or marks are left on the face of the lens, the image will not be projected clearly.
- Do not try to force a cable plug with a different shape the port. This may damage the unit or the equipment.

Connecting with a video cable

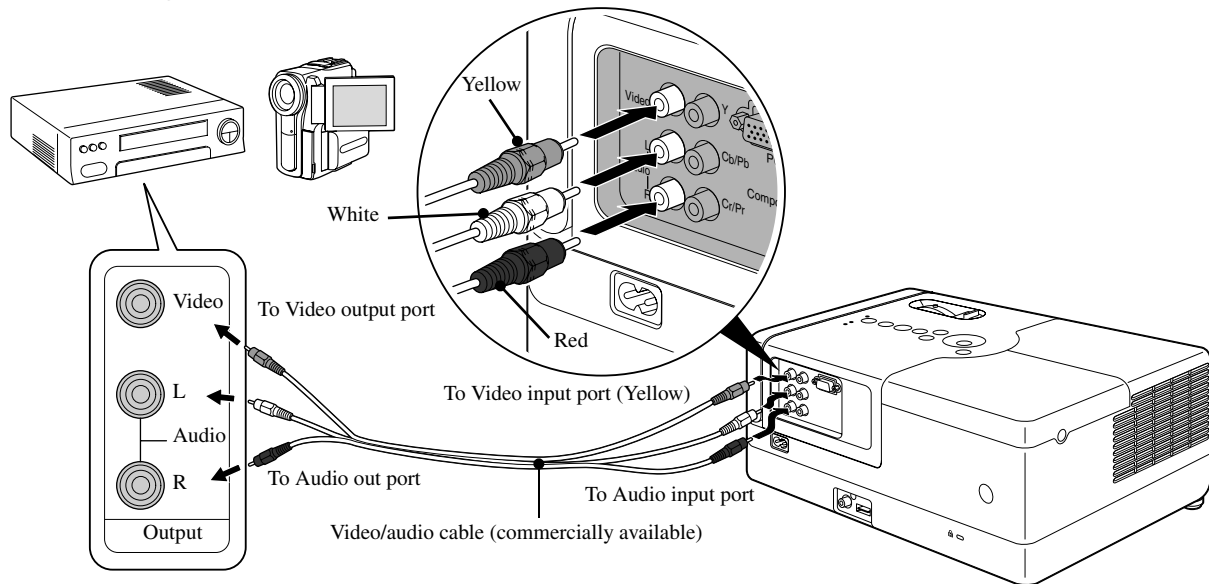

Connecting with a component video cable

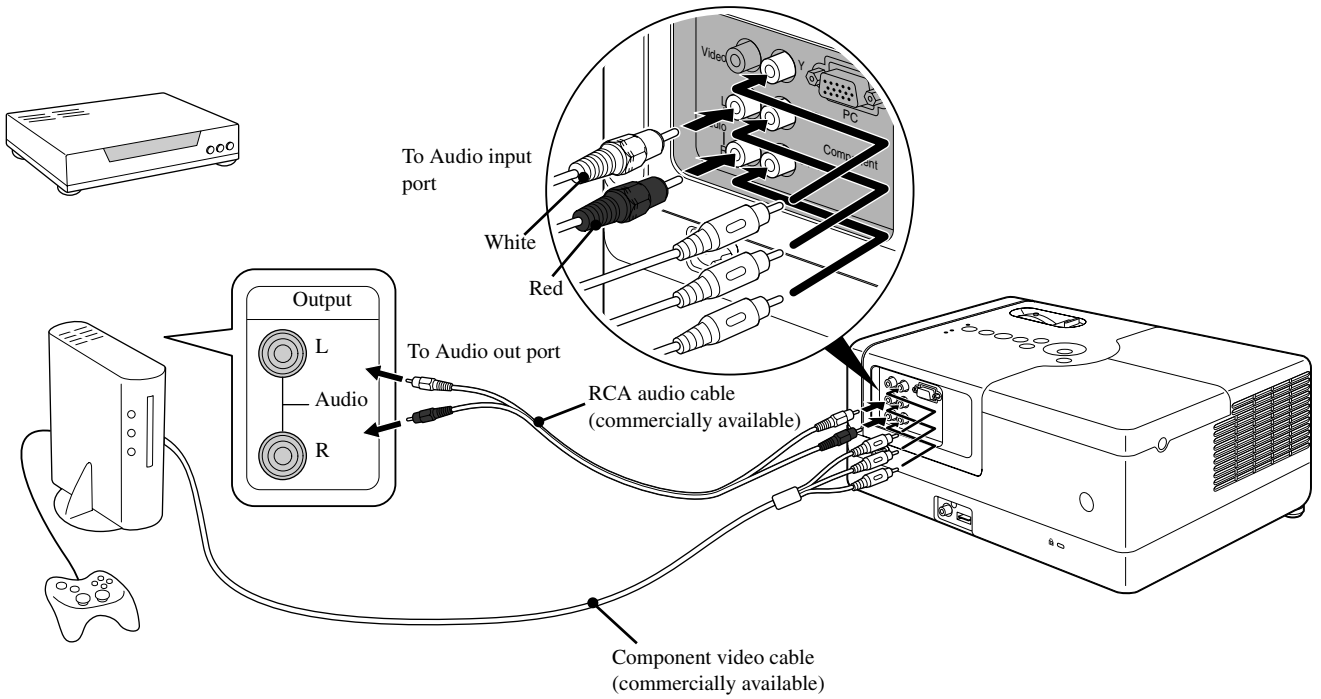

For a D port output device, use a commercially available D port - component conversion cable.

Connecting with a computer

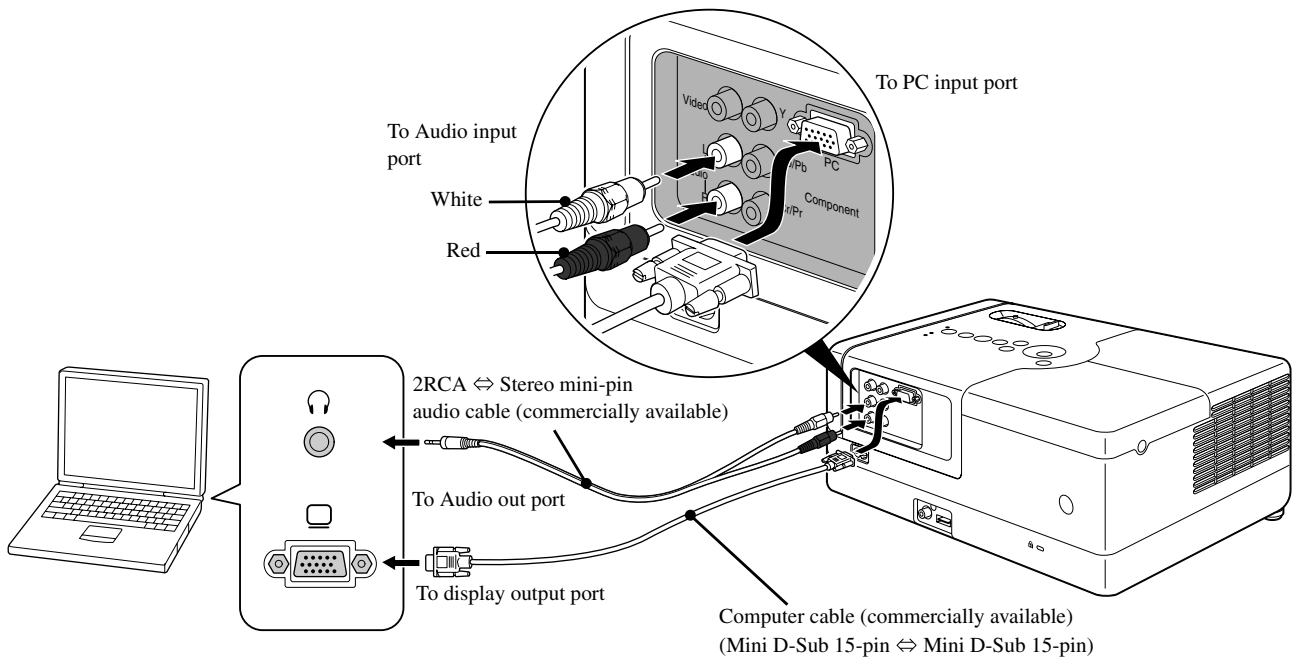



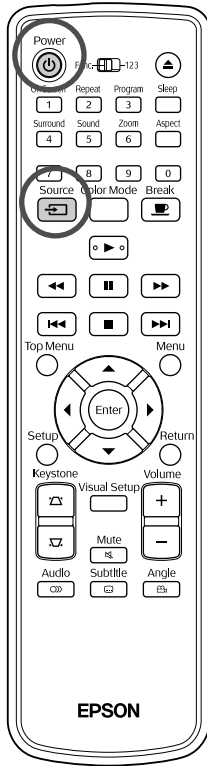

Use a cable marked "No resistance" when you use a commercially available 2RCA ⇔ stereo mini-plug audio cable.

Projecting images from external video equipment or a computer



1 Open the lens cover and press .

2 When you press  ^{Source}, the following menu appears on the screen.

The orange pointer points to the currently selected source. Select the desired source by pressing  , and press .

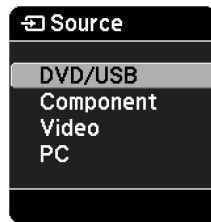



3 Turn the device power switch on, and press the [Play] or [Playback] button on the video device.



If the lamp was off, it comes on automatically.

After a moment, the image is projected.

To return to the standard built-in DVD player
Make any of the following operations.

- Press .
- Insert a disc into the disc slot.
- Select "DVD/USB" by pressing  ^{Source}.
- Press .

When a computer image is not projected

You can switch the image signal destination from the computer by holding down **Fn** and pressing **F9** (the key is usually labeled  or ).

 Computer “Documentation”

After switching, wait a few seconds for projection to start.

Examples of Switching Output			
Epson	Fn + F9	Toshiba	Fn + F5
NEC	Fn + F3	IBM/Lenovo	Fn + F7
Panasonic		Sony	
SOTEC		Dell	Fn + F8
HP	Fn + F4	Fujitsu	Fn + F10
Macintosh	Set mirroring or display detection. Depending on your OS, you can set them by pressing F7 .		

Depending on the computer, each time the key to change the output is pressed, the display status may also change as follows.

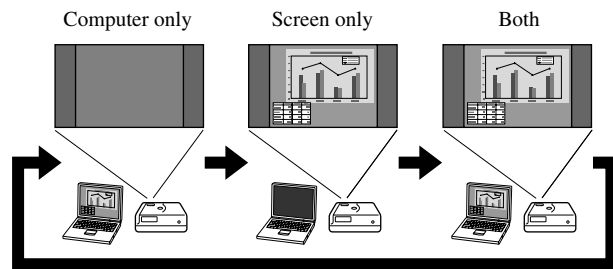

Audio Settings

Listening with headphones

Caution

- When listening with headphones, make sure the volume is not too high. You may damage your hearing when listening to sounds at high volume over an extended period of time.
- Do not set the volume too high from the outset. A loud sound may be produced suddenly that may cause damage to your headphones or your hearing. As a precaution, lower the volume before you switch off this unit then raise it gradually after you switch it back on.

Connecting commercially available headphones.

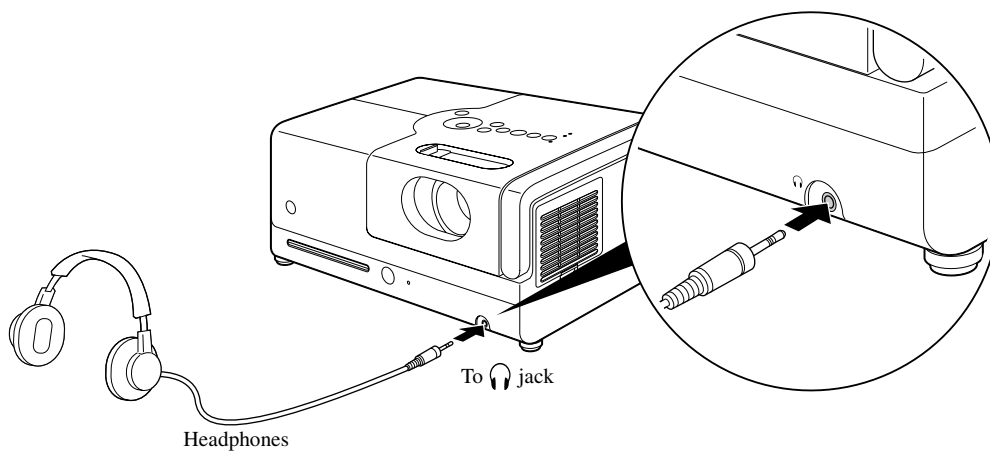

Once you have connected your headphones to the headphone jack, no sound will come from the speakers. Stereo mode will be automatically selected. Sound mode selection is not possible when you are listening through the headphone. When you disconnect the headphone from the headphone jack, the Sound mode will automatically toggle to the selected Sound mode prior to the connection of headphone to headphone jack.

Connecting to audio equipment with a digital coaxial audio input port

You can connect to AV amplifiers and so on or equipment capable of making digital recordings when they are equipped with a coaxial digital audio input port. When connecting, use a commercially available coaxial digital cable.

Fully plug the audio cable connector into jack.

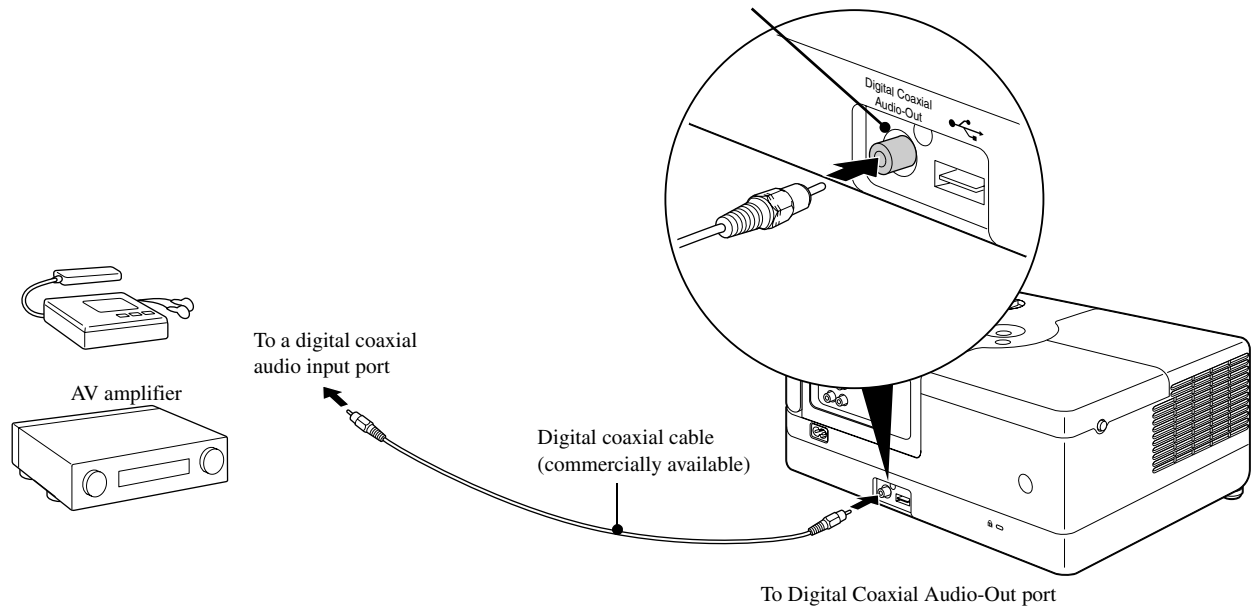

The signal being output from the Digital Coaxial Audio-Out port is changed with the "Digital Output" setting in the settings menu. For detailed output signal information [p. 54](#)

Selecting the Surround Sound mode (Only via speaker)

Set the [Function] position before performing operations

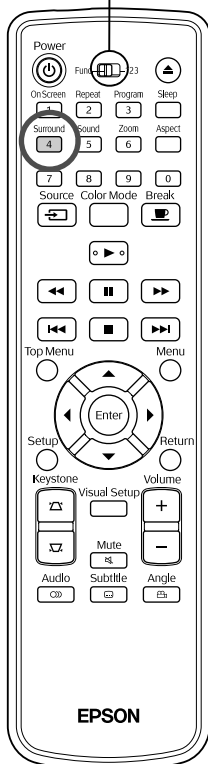

When you turn the Dolby Virtual Speaker function on, you can enjoy real stereo sound although sound is usually provided through multiple speakers. When using the Dolby Virtual Speaker function, setup the unit so that the unit has to be placed in front of the viewer.

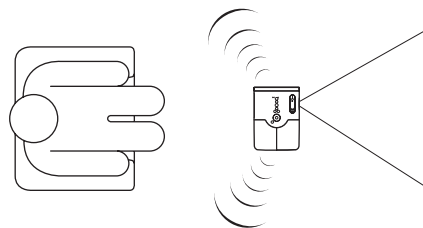

1 Press **Surround 4**.

The current settings are displayed on the screen.



2 Select the desired settings by pressing ^{Surround} **4** repeatedly.

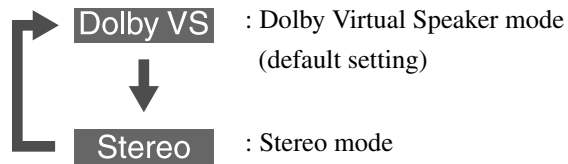

When using the headphone the sound mode automatically changes to the Stereo mode as the Dolby Virtual Speaker mode is not applicable on headphone output. Sound mode will automatically toggle to the previous mode when the headphone removed.

Selecting the digital sound effects

Set the [Function] position before performing operations

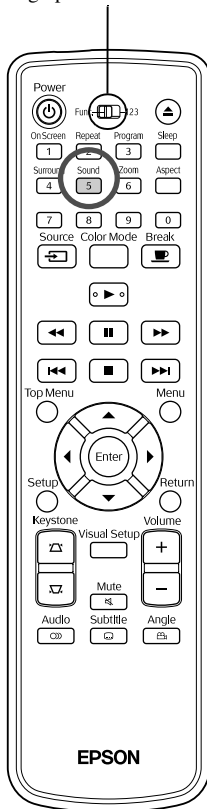

You can select the sound effects appropriate to the musical genre of the current disc.

1 Press ^{Sound} **5**.

The current settings are displayed on the screen.



2 Select the desired settings by pressing ^{Sound} **5** repeatedly.

The sound effects, which you can select according to the inserted disc or the connected source, are switched as follows:

DVD Video	Concert → Drama → Action → Sic-Fi (Science Fiction)
Video CD	
Ext.Vid./Comp.	Classic → Jazz → Rock → Digital
Other discs	



TIP Select “Concert” or “Classic” sound effects for flat sound output.

Settings and Adjustments

Setup Menu Operation and Functions

The settings of this unit can be adjusted to suit the environment in which it is used.

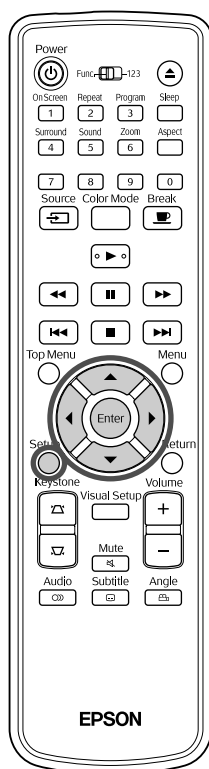

Using the setup menu





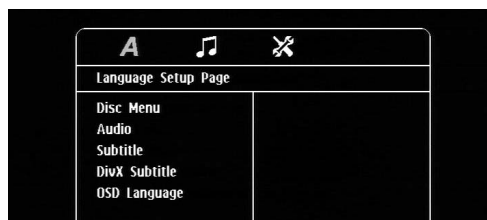

- 1 Press  during playback or when stopped.

The following setup menu is displayed.

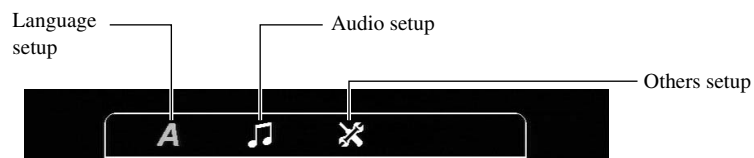



- 2 Press   and select the desired icon.



- 3** Press   to select the item to be set, and then press .

The settings are displayed on the right.



- 4** Select the setting you wish to change, and press . To display other setting pages, select a desired icon by repeatedly pressing .

- 5** After setup is complete, press  to close the setup menu.

Setup menu list

Boldface is the default.





Language page

Setting Item	Setting Contents
Disc Menu Select the DVD video menu language.	For “6978” and other language codes, see the “Language code list”.  p. 53
Audio Select the DVD video soundtrack language.	These settings become available when settings have been recorded on the disc itself. If they have not been recorded, the setting contents become available. If the language selected is not recorded on the disc, the default language for that disc is used.
Subtitle Select the DVD video subtitle language.	
DivX Subtitle Select a font type that supports the DivX subtitle.	Central Europe, Cyrillic, Greek, Standard , Hebrew Select the “Standard” to display the standard list of Roman subtitle fonts already installed on the unit.
OSD Language Select the menu language (for setup and visual setup).	English : :

Audio page

Setting Item	Setting Contents
Digital Output Select the kind of output signal according to the equipment connected to the Digital Coaxial Audio-Out port. For detailed information  p. 54	All: Use when connected to a DTS/Dolby Digital Decoder, or when connected to equipment with these functions. PCM Only: Use when connected to equipment that is only compliant with Linear PCM.
Night Mode Compensates for the variation in the way we hear loud and quiet sounds when playing back at low volume. Only available for DVD videos that have been recorded in Dolby Digital. Turn the Dolby Digital mode “On” if the volume of voices in the movie is low.	On: Reduce the loudness but increases volume of quieter sounds. Off: Use this option to enjoy normal or powerful clear stereo surround sound.

Others page

Setting Item	Setting Contents
Screen Saver Set whether or not to start the screen saver function if play has stopped and a still image is projected for approximately 15 minutes without any unit operation.	On: The Screen Saver function starts. Off: The Screen Saver function does not start.
PBC Set to activate the PBC or cancel it during play of Video CD .	On: Starts to play with PBC active. When Video CD is played, its menu screen appears. Off: Starts to play with PBC inactive. The first and subsequent tracks are played sequentially.
DivX® VOD code The registration codes required for video on-demand service are provided.	Press  and check your registration code that is displayed. After checking, press  . Using your registration code, you can purchase or rent videos provided by DivX® video on-demand services (www.divx.com/vod).
MP3/JPEG NAV Display of hierarchical menu including folders.	Without Menu: Displays all MP3/WMA , JPEG and DivX files contained on a disc. With Menu: Displays the menu containing folders.
Default Resets all settings to their initial states, except for “Disc Lock” and “Password” from the Settings menu and “Reset Lamp Hours” from the Visual Setup menu.	Press  and press  to start initialization.
Password Set your password when you play a disc protected with a “Disc Lock.”	Using the numeric keys of the remote control, enter your 6-digit password in the “Old Password” column. When you enter a password for the first time, enter “000000”. Enter a new 6-digit password in the “New Password” column. Enter the new 6-digit password again for confirmation in the “Confirm PWD” column. When you press  , your new password is registered. If you cannot remember your password, simply enter “000000” in the “Old Password” column.
Disc Lock If you have locked a disc with the Disc Lock function, you will need to enter your password to play the disc. You can protect discs from unauthorized play. You can lock up to 40 discs.	Lock: Locks playback of the currently inserted disc. You will need to enter the 6-digit password to play it. Unlock: Allows playback of all discs.

Language code list

Abkhazian	6566	Gaelic; Scottish Gaelic	7168	Magyar	7285	Sinhalese	8373
Afar	6565	Gallegan	7176	Malayalam	7776	Slovensky	8373
Afrikaans	6570	Georgian	7565	Maltese	7784	Slovenian	8376
Amharic	6577	Gikuyu; Kikuyu	7573	Manx	7186	Somali	8379
Arabic	6582	Guarani	7178	Maori	7773	Sotho; Southern	8384
Armenian	7289	Gujarati	7185	Marathi	7782	South Ndebele	7882
Assamese	6583	Hausa	7265	Marshalllese	7772	Sundanese	8385
Avestan	6569	Herero	7290	Moldavian	7779	Suomi	7073
Aymara	6589	Hindi	7273	Mongolian	7778	Swahili	8387
Azerbaijani	6590	Hiri Motu	7279	Nauru	7865	Swati	8383
Bahasa Melayu	7783	Hrvatski	6779	Navaho; Navajo	7886	Svenska	8386
Bashkir	6665	Ido	7379	Ndebele, North	7868	Tagalog	8476
Belarusian	6669	Interlingua (International)	7365	Ndebele, South	7882	Tahitian	8489
Bengali	6678	Interlingue	7365	Ndonga	7871	Tajik	8471
Bihari	6672	Inuktitut	7385	Nederlands	7876	Tamil	8465
Bislama	6673	Inupiaq	7375	Nepali	7869	Tatar	8484
Bokmål, Norwegian	7866	Irish	7165	Norsk	7879	Telugu	8469
Bosanski	6683	Íslenska	7383	Northern Sami	8369	Thai	8472
Brezhoneg	6682	Italiano	7384	North Ndebele	7868	Tibetan	6679
Bulgarian	6671	Ivrit	7269	Norwegian Nynorsk;	7878	Tigrinya	8473
Burmese	7789	Japanese	7465	Occitan; Provençal	7967	Tonga (Tonga Island)	8479
Castellano, Español	6983	Javanese	7486	Old Bulgarian; Old Slavonic	6785	Tsonga	8483
Catalán	6765	Kalaallisut	7576	Oriya	7982	Tswana	8478
Chamorro	6772	Kannada	7578	Oromo	7977	Türkçe	8482
Chechen	6769	Kashmiri	7583	Ossetian; Ossetic	7983	Turkmen	8475
Chewa; Chichewa; Nyanja	7889	Kazakh	7575	Pali	8073	Twi	8487
中文	9072	Kernewek	7587	Panjabi	8065	Uighur	8571
Chuang; Zhuang	9065	Khmer	7577	Persian	7065	Ukrainian	8575
Church Slavonic; Slavonic	6785	Kinyarwanda	8287	Polski	8076	Urdu	8582
Chuvash	6786	Kirghiz	7589	Português	8084	Uzbek	8590
Corsican	6779	Komi	7586	Pushto	8083	Vietnamese	8673
Česky	6783	Korean	7579	Russian	8285	Volapuk	8679
Dansk	6865	Kuanyama; Kwanyama	7574	Quechua	8185	Walloon	8765
Deutsch	6869	Kurdish	7585	Raeto-Romance	8277	Welsh	6789
Dzongkha	6890	Lao	7679	Romanian	8279	Wolof	8779
English	6978	Latina	7665	Rundi	8278	Xhosa	8872
Esperanto	6979	Latvian	7686	Samoan	8377	Yiddish	8973
Estonian	6984	Letzeburgesch;	7666	Sango	8371	Yoruba	8979
Euskara	6985	limburgan; limburgger	7673	Sanskrit	8365	Zulu	9085
Ελληνικά	6976	Lingala	7678	Sardinian	8367		
Faroese	7079	Lithuanian	7684	Serbian	8382		
Français	7082	Luxembourgish;	7666	Shona	8378		
Frysk	7089	Macedonian	7775	Shqip	8381		
Fijian	7074	Malagasy	7771	Sindhi	8368		

“Digital Output” settings and output signals

Playback Disc	“Digital Output” Settings	
	Stream	PCM
Linear PCM DVD video	Linear PCM Stereo	
DTS DVD video	DTS bit stream	48 kHz, 16 bit linear PCM
Dolby digital DVD video	Dolby digital bit stream	48 kHz, 16 bit stereo linear PCM
Audio CD, Video CD, SVCD	44.1 kHz, 16 bit stereo linear PCM/48 kHz, 16 bit linear PCM	
DTS Audio CD	DTS bit stream	44.1 kHz, 16 bit linear PCM
MP3/WMA disc	32/44.1/48 kHz, 16 bit linear PCM	

Operations and functions on the Visual Setup menu

You can adjust the brightness, contrast, and other values of the projected image.

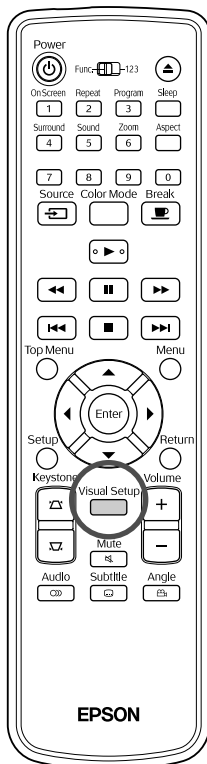

Operations on the Visual Setup menu





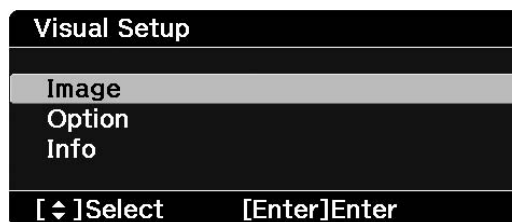

- 1 Press  during projection.

The following menu is displayed.



- 2 Press   to select the item to be set, and then press .



- 3 Press   to select the item to be set, and then press   to adjust.

- When options are displayed, select a desired option and press  to enable it.



- 4 After setup is complete, press  to close the menu.

Visual Setup menu

Image page

Setting Item	Setting Contents
Brightness	Adjusts the image brightness.
Contrast	Adjusts the difference between light and shade in the images.
Color Saturation	Adjusts the color saturation for the images. (This is not displayed when a computer is connected.)
Tint	Adjusts the image tint. (This is not displayed when the external video or computer connected is not NTSC.)
Sharpness	Adjusts the image sharpness.
Color Temp.	Adjusts the entire image tint. High: Makes the image bluish. Low: Makes the image reddish.
Progressive Converts the interlace signals into progressive signals appropriate to the current picture.	Can only be set when one of the following five signals is input: 480i, 576i and 1080i in component video, or NTSC and PAL in composite video. Off: Suitable for fast action images. Video: Suitable for ordinary video images. Film/Auto: Uses 2-3 pull-down mode and converts 24/30-frame movie film, CG and animation images into appropriate progressive signals to produce natural image quality.

Option page

Setting Item	Setting Contents
Video Signal Sets the signal format of the video equipment connected to the Video input port.	Only displayed when "Video" is selected as the source. At the time of purchase, this is set to "Auto" so the video signal is recognized automatically. If interference appears in the projected images or no images appear when you select "Auto", select the appropriate signal manually.
Child Lock Use  on the main unit to lock the power-on.	On: Starts the Child Lock. To turn the power supply on, hold down  on the main unit for approximately 5 seconds or hold down  on the remote control. Off: Cancels the Child Lock.
Ceiling Projection	On: Projects images onto the ceiling using the optional Ceiling Reflector Kit. Off: Deactivates the ceiling projection.
High Altitude Mode Set this mode when you use this unit at high altitudes.	When using this unit at high altitudes, that is 1500 meters or more above sea level, turn this mode "On".
Zoom Select W/T on the operation panel of the main unit.	Adjusts the image size. Wide: Enlarges the image. Tele: Reduces the image.

Info page

Item	Contents
Information Displays the current status.	<p>Lamp Hours: Total usage time of the lamp. 0H is displayed for 0 to 10 hours. Changes to units of 1 hour at 10 hours and above. The display turns yellow text when it is time to change the lamp.</p> <p>Source: Displays whether standard DVD player images are being projected, or images from external video equipment or a computer are being projected.</p> <p>Video Signal: This is displayed when “Video” is selected as the “Source”, and displays the format of the video signal being input.</p> <p>Resolution: The resolution is displayed if the “Source” is other than “Video”. The resolution of image signals from a computer and the component video signals that are being input are displayed.</p> <p>Status: Displays any error information. You may be asked for this information when you contact your service center.</p>
Reset Lamp Hours	After you have replaced the unit lamp, initialize the lamp hour settings. The accumulated lamp operating time is cleared.

Appendix



Troubleshooting

Reading the indicators

You can check the status of this unit using the indicators on the top panel.

Check each condition in the following table and follow the steps to remedy the problem.

* If all indicators are not lit, the power cable is not connected correctly or the unit is not powered.

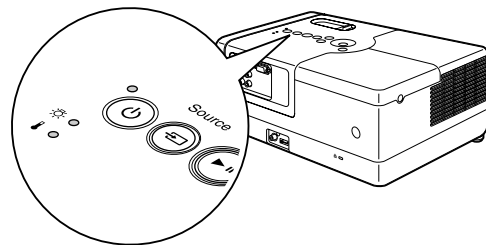

When the or indicators flash orange

Warning





















● : lit : flashing ○ : off

<p>Red</p> <p></p> <p>○ </p> <p>Orange</p> <p> </p>	<p>High Temperature alarm</p> <p>You can continue projecting in this state. Projection stops automatically if subsequent high temperatures are registered.</p>	<p>Check the 2 items listed.</p> <ul style="list-style-type: none"> • Move this unit away from the wall at least 20 cm. • Clean the air filter. p. 63 	<p>If there is no improvement when you press and switch the power on, discontinue use and disconnect the power cable from the electrical outlet. Contact your local dealer or the nearest address provided in the Inquiries. p. 76</p>
<p>Green</p> <p>●</p> <p>Orange</p> <p> </p> <p>○ </p>	<p>Lamp replacement notification</p> <p>It is time to replace the lamp. Replace the lamp with a new one as soon as possible. Do not continue to use the lamp in this state, otherwise it may explode. p. 66</p>		

When lights on red









Error

● : lit  : flashing ○ : off

<p>Red ●</p> <p>Red  </p> <p>Red  </p>	<p>Internal failure</p> <p>Wait for approximately 1 minute and 30 seconds. Then, disconnect and reconnect the power cable. If the indicator status does not change when  is pressed and the power turned on...</p>	<p>If the error continues</p> <p>Wait for approximately 1 minute and 30 seconds. Then, disconnect the power cable from the electrical outlet and contact your local dealer or the nearest address provided in the Inquiries.  p. 76</p>	
<p>Red ●</p> <p>○ </p> <p>Red  </p>	<p>Fan related error/Sensor error</p>		
<p>Red ●</p> <p>○ </p> <p>Red ● </p>	<p>High temperature error (overheating)</p> <p>The lamp turns off automatically and projection stops. Wait for approximately 5 minutes. When the Power indicator color changes to orange, check for the 3 points shown at right.</p>	<ul style="list-style-type: none"> • Move this unit away from the wall by at least 20 cm. • Clean the air filter.  p. 63 • When using this unit at high altitudes, that is 1500 m or more above sea level, set "High Altitude Mode" to "On".  p. 56 	<p>If the indicator status does not change when  is pressed and the power turned on...</p>
<p>Red ●</p> <p>Red  </p> <p>○ </p>	<p>Lamp error/Lamp failure/Lamp cuts out/Lamp cover open</p> <p>Wait for approximately 1 minute and 30 seconds, and check for a blown lamp.  p. 66</p> <p>Clean the air filter and the air intake vent.  p. 63</p> <p>The lamp is not broken</p> <p>The lamp is broken</p> <p>When using this unit at high altitudes, that is 1500 m or more above sea level, set "High Altitude Mode" to "On".  p. 56</p>	<p>Reinsert the lamp then turn on the main power switch on the main unit.</p>	<p>If the condition is not fixed once the lamp is re-inserted</p>
		<p>Contact your dealer for further advice.  p. 76</p>	























When the or indicators are off **Normal**

● : lit  : flashing ○ : off





 Orange	Standing-by Shows that the unit is ready to be used.
 Green	During warming up (Approx. 20 sec) In warm-up mode, pressing  has no effect. Do not unplug the power cable during warm-up. This may reduce the lifespan of the lamp.
 Green	Projection in Progress
 Orange	Cooling down (Approx. 5 sec) The operation of all remote control and main unit buttons is suspended during cool-down. Enters stand-by mode once cool-down has completed. Do not unplug the power cable during cool-down. This may reduce the lifespan of the lamp.
 Green	Break Press  to return to normal playback.
 Flashes orange three times	Child Lock Child Lock is set.  p. 56

When the indicators provide no help

If this unit is not functioning normally, check the following notes before requesting repairs. However, if the unit fails to improve, contact your dealer for advice.

At these times	Check here	Reference page
Power does not turn on	• Did you press  ?	 p. 18
	• Disconnect and reconnect the power cable.	 p. 18
	• Is the unit cooling down?	 p. 60
	• If the indicator goes on and off when you touch the power cable, turn off the main power switch then disconnect and reconnect the power cable. If the unit fails to improve, it is possible that the power cable has been damaged. Stop using the unit, disconnect the power cable from the electrical outlet, and contact your dealer.	 p. 76
	• Is the Child Lock set?	 p. 56
No images appear	• Is the lens cover closed?	 p. 18
	• Is the DVD video region number correct?	 p. 10
	• Press  to switch to DVD.	 p. 45
	• Is the lamp spent?	 p. 58
Images are fuzzy or out of focus	• Has the focus been adjusted?	 p. 20
	• Is the unit at the correct distance?	 p. 69
	• Could there be condensation?	 p. 8
Images appear dark	• Is the color mode appropriate to the usage environment?	 p. 25
	• Is the lamp due for replacement?	 p. 64
	• Is the screensaver running?	 p. 52
The remote control does not work	• Is the Function/Numerics toggle switch in the [1 2 3] (numerical input) position?	 p. 26
	• Depending on the disc, certain operations are prohibited.	-
	• Are the batteries dead, or have the batteries been inserted incorrectly?	 p. 16
There is no audio or it is too low.	• Has the volume been adjusted to the minimum setting?	 p. 20
	• Is mute mode active? Press  .	-
The audio distorts	Is the volume too loud?	 p. 20
The audio/subtitle language cannot be changed	• If multiple languages are not recorded on the disc, they cannot be changed.	-
	• Depending on the disc, there are some types that can only be changed from the DVD menu.	-
Subtitles do not appear	• If there are no subtitles on the disc, they are not displayed.	-
	• Is the subtitle language set to “OFF”?	 p. 36

When using external video or computer mode

At these times	Check here	Reference page
No images appear	<ul style="list-style-type: none"> Is the power for the connected equipment turned on? Switch on the power to the connected equipment, or start playback depending on the playback method for the connected equipment. 	☞ p. 45
“Signal not supported” is displayed	<ul style="list-style-type: none"> When external video equipment is connected If projection is disabled even when the “Video Signal” is set to “Auto” in the visual setup menu, set the signal format that is appropriate to the device. 	☞ p. 56
	<ul style="list-style-type: none"> When a computer is connected Are the resolution and refresh rate modes for the image signal compatible with the unit? Use the computer’s documentation and so on to check and change the resolution and the refresh rate for the image signal being output by the computer. 	☞ p. 70
“No signal.” is displayed	<ul style="list-style-type: none"> Are the cables connected correctly? 	☞ p. 43 - 44
	<ul style="list-style-type: none"> Is the power for the connected equipment turned on? Turn on the power for the connected equipment. Press the playback button according to the connected video equipment. 	☞ p. 45
	<ul style="list-style-type: none"> Is a laptop computer or a computer with a built-in LCD screen connected? Change the image signal's output destination from the computer. 	☞ p. 46
	<ul style="list-style-type: none"> Press  to switch to DVD. 	☞ p. 45
The signal is distorted	<ul style="list-style-type: none"> If an extension cable is used, electrical interference may affect the signals. Connect amplification equipment and check. 	-
	<ul style="list-style-type: none"> Is the computer’s image signal resolution mode compatible with the unit? Use the computer’s documentation and so on to check and change the resolution for the image signal being output by the computer. 	☞ p. 70
	<ul style="list-style-type: none"> Press the  button on the remote control if interference or flickering appear in the computer image being projected. “Running Auto Setup...” is displayed and synchronization, tracking, and position are automatically adjusted. 	-
Image is truncated (large) or small	<ul style="list-style-type: none"> The unit automatically recognizes the aspect ratio appropriate to input signals and projects images. If the aspect ratio is not selected correctly, press  and select the aspect ratio appropriate to the input signal. 	☞ p. 40
	<ul style="list-style-type: none"> Press the  button on the remote control if part of the computer image being projected is missing. “Running Auto Setup...” is displayed and synchronization, tracking, and position are automatically adjusted. 	-
Image colors are not right	In the visual setup menu, set the “Video Signal” to the signal format appropriate to the device.	☞ p. 56
Moving images being played back by the computer become black	Change the computer’s image signal to external output only. ☞ Check the “Documentation” supplied with the computer for more information, or inquire to the computer’s manufacturer.	-

Maintenance

This section describes maintenance tasks such as cleaning the unit and replacing consumable parts.

Caution

Before starting the maintenance, unplug the power cable from the electrical outlet.

Cleaning

Cleaning the air filter and air intake vent

When dust builds up on the air filter or the air intake vent, or the message “The unit is overheating. Make sure nothing is blocking the air vent, and clean or replace the air filter.” is displayed, remove any dust from the air filter and the air intake vent using a vacuum cleaner.

CAUTION

If dust collects on the air filter or the air intake vent it can cause the internal temperature of the unit to rise, and this can lead to operation problems and a shortening of the service life of optical parts. It is recommended that you clean these parts at least once every three months. Clean them more often than this if the unit is used in particularly dusty environments.

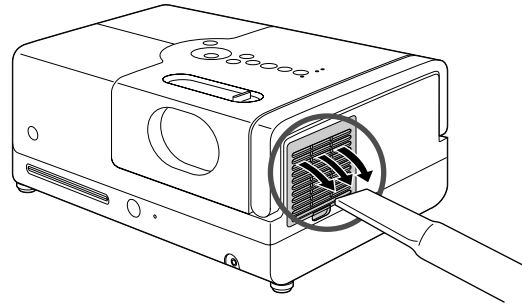

Cleaning the main unit

Clean the surface by wiping it gently with a soft cloth. If the unit is particularly dirty, moisten a cloth with water containing a small amount of neutral detergent, firmly wring the cloth dry, wipe the unit softly with the cloth to remove stains, and then wipe it again with a soft, dry cloth.

CAUTION

Do not use volatile substances such as wax, alcohol, or thinner to clean the unit's surface. These can cause the unit to warp and make the coating finish peel off.

Cleaning the projection lens

Use a commercially available cloth for cleaning glasses to gently wipe the lens.

CAUTION

Do not rub the lens with harsh materials or subject the lens to impact shock, as it is fragile.

Consumables replacement period

Air filter replacement period

When the air filter gets dirty or is broken

Lamp replacement period

- The message “Replace the lamp” appears on the screen when projection starts.
- The projected image gets darker or starts to deteriorate.



- In order to maintain the initial brightness and image quality, the lamp replacement message is displayed after about 2900 hours of use has passed. The time at which this message is displayed will vary depending on the color mode settings and the conditions under which this unit has been used.
- If you continue to use the lamp after this period, the possibility of the lamp breaking becomes greater. When the lamp replacement message appears, replace the lamp with a new one as soon as possible, even if it is still working.
- Depending on the characteristics of the lamp and on the way it has been used, the lamp may become darker or stop working before the lamp warning message appears. You should always have a spare lamp ready in case it is needed.

Optional Accessories and Consumables

The following optional accessories and consumables are available for purchase if required. This list of optional accessories is applicable as of September, 2007. Details of accessories are subject to change without notice and availability may vary depending on the country or area of purchase.

Consumables

Replacement lamp ELPLP44 (Lamp x1) Use as a replacement for used lamps.	Air filter ELPAF14 (Air filter x1) Use as a replacement for used air filters.
---	---

Optional accessories

50" portable screen ELPSC06 60" portable screen ELPSC07 80" portable screen ELPSC08 100" screen ELPSC10 A compact screen which can be carried easily. (Aspect ratio 4:3)	HD-15 cable ELPKC02 (1.8 m - for mini D-Sub 15-pin/mini D-Sub 15-pin) HD-15 cable ELPKC09 (3 m - for mini D-Sub 15-pin/mini D-Sub 15-pin) HD-15 PC cable ELPKC10 (20 m - for mini D-Sub 15-pin/mini D-Sub 15-pin) Use to connect the unit to a computer.
	Component video cable ELPKC19 (3 m - for mini D-Sub 15-pin/RCA male x 3) Use to connect a component video source.

How to replace consumables

Replacing the air filter



TIP

Dispose of used air filters properly in accordance with your local regulations.

Filter: Polypropylene

Frames: ABS resin

- 1** Turn the power switch off and when a short beep sounds, unplug the power cable.

- 2** Remove the air filter cover.

Place your finger in the hollow and lift upwards.

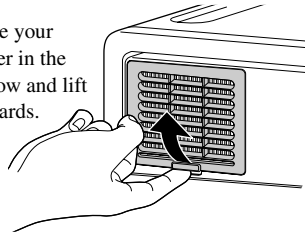

- 3** Take out the old air filter.

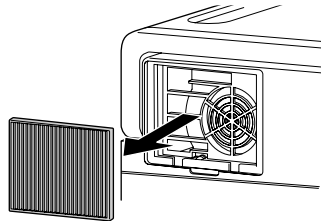

- 4** Install the new air filter.

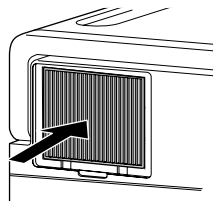

- 5** Install the filter cover.

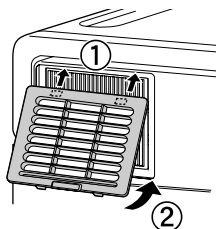

Replacing the lamp

Caution

The lamp is hot immediately after use. Once the power has been switched off, allow approximately one hour to pass before replacing the lamp to allow it to cool thoroughly.

- 1** Turn the power switch off, and when a short beep sounds, unplug the power cable.

- 2** Loosen the screws of the lamp cover attachment using the screwdriver that supplied with the replacement lamp. Slide the lamp cover horizontally, and then lift it up to remove it.

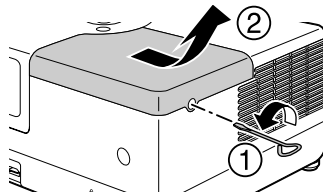

- 3** Loosen the lamp attachment screws.

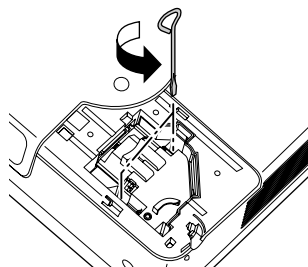

- 4** Take out the old lamp.

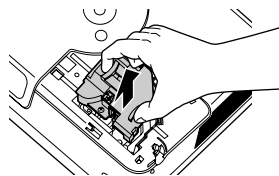

- 5** Install the new lamp.

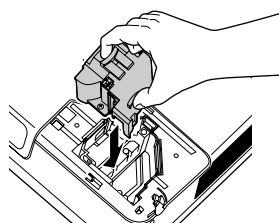

6 Tighten the lamp attachment screws firmly.

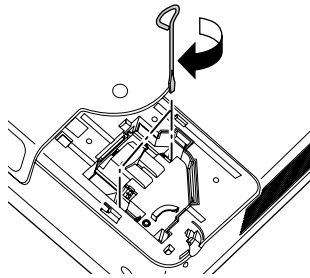

7 Install the lamp cover.

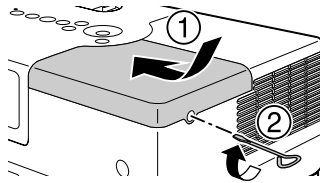

CAUTION

- Install the lamp and the lamp cover securely. For the safety of this unit, the lamp will not turn on if the lamp or the lamp cover is not installed correctly.
- This product includes a lamp component that contains mercury (Hg). Please consult your local regulations regarding disposal or recycling. Do not dispose of it with normal waste.

Resetting the lamp operating time

After the lamp has been replaced, make sure you initialize the Lamp Hours setting.

The unit has a built-in counter that keeps track of the lamp operating time and the lamp replacement message is displayed based on this counter.

1 Connect the power cable, and press .

2 Press and when the menu appears, set the “Info” to “Reset Lamp Hours”.

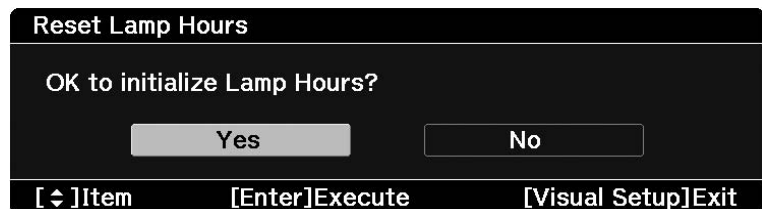

3 Select “Yes” and press  to initialize the setting.

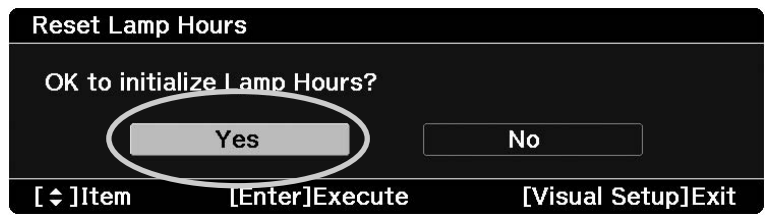

Projection Distance and Screen Size

Refer to the following table and place the unit in a position which allows the best possible projection for the size of the screen.

Units: cm (ft.)

16:9 Screen Size		Projection Distance	
		Minimum (Zoom Adjustment Wide)	Maximum (Zoom Adjustment Tele)
30"	66 x 37 (26 x 15)	85 - 116 (2.8 to 3.8)	
40"	89 x 50 (35 x 20)	116 - 158 (3.8 to 5.2)	
60"	130 x 75 (51 x 28)	177 - 240 (5.8 to 7.9)	
80"	180 x 100 (71 x 39)	238 - 323 (7.8 to 10.6)	
100"	220 x 120 (87 x 47)	299 - 405 (9.8 to 13.3)	
120"	270 x 150 (106 x 59)	360 - 488 (11.8 to 16.0)	
150"	330 x 190 (130 x 75)	452 - 611 (14.8 to 20.1)	

Units: cm (ft.)

4:3 Screen Size		Projection Distance	
		Minimum (Zoom Adjustment Wide)	Maximum (Zoom Adjustment Tele)
30"	61 x 46 (24 x 18)	105 - 143 (3.4 to 4.7)	
40"	81 x 61 (32 x 24)	143 - 194 (4.7 to 6.3)	
60"	120 x 90 (47 x 35)	217 - 295 (7.1 to 9.6)	
80"	160 x 120 (63 x 47)	292 - 396 (9.6 to 13.0)	
100"	200 x 150 (79 x 59)	367 - 497 (12.0 to 16.3)	
120"	240 x 180 (94 x 71)	442 - 598 (14.5 to 19.6)	
150"	300 x 230 (118 x 91)	554 - 749 (18.2 to 24.5)	

Compatible Resolution List

Composite video

Units: Dots

Signal	Resolution	Aspect Mode		
		Normal	Full	Zoom
TV (NTSC)	720 x 480 720 x 360 *	640 x 480 (4:3)	854 x 480 (16:9)	854 x 480 (16:9)
TV (PAL, SECAM)	720 x 576 720 x 432 *	640 x 480 (4:3)	854 x 480 (16:9)	854 x 480 (16:9)

* Letterbox signal

Component video

Units: Dots

Signal	Resolution	Aspect Mode		
		Normal	Full	Zoom
SDTV (480i, 60Hz)	720 x 480 720 x 360 *	640 x 480 (4:3)	854 x 480 (16:9)	854 x 480 (16:9)
SDTV (576i, 50Hz)	720 x 576 720 x 432 *	640 x 480 (4:3)	854 x 480 (16:9)	854 x 480 (16:9)
SDTV (480p)	720 x 480 720 x 360 *	640 x 480 (4:3)	854 x 480 (16:9)	854 x 480 (16:9)
SDTV (576p)	720 x 576 720 x 432 *	640 x 480 (4:3)	854 x 480 (16:9)	854 x 480 (16:9)
HDTV (720p) 16:9	1280 x 720	854 x 480 (16:9)	-	-
HDTV (1080i) 16:9	1920 x 1080	854 x 480 (16:9)	-	-

* Letterbox signal

Computer image

Units: Dots

Signal	Resolution	Aspect Mode		
		Normal	Full	Zoom
VGA60/72/75/85, iMac * 1	640 x 480 640 x 360 * 2	640 x 480	854 x 480	854 x 480
SVGA56/60/72/75/85, iMac * 1	800 x 600 800 x 450 * 2	640 x 480	854 x 480	854 x 480
XGA60/70/75/85, iMac * 1	1024 x 768 1024 x 576 * 2	640 x 480	854 x 480	854 x 480
MAC13"	640 x 480	640 x 480	854 x 480	854 x 480
MAC16"	832 x 624	640 x 480	854 x 480	854 x 480
MAC19"	1024 x 768	640 x 480	854 x 480	854 x 480

* 1 You cannot connect to models where the VGA output port is not installed.

* 2 Letterbox signals

Even when signals other than those mentioned above are input, it is likely that the image can be projected. However, not all functions may be supported.

Small characters, and so on may not be visible.

Compatible MPEG format list

Extension	Video Codec	Audio Codec	Resolution
.AVI	MPEG-1/MPEG-2/ MPEG-4(Advanced Simple Profile)	PCM/ADPCM/MPEG/MP3/WMA/AC3/DTS	PAL: 25 Hz 720 x 576 or less NTSC: 30Hz 720 x 480 or less
.VID/.DIV/ .DIVX(Home Theater)/ .XVID	MPEG-4(Advanced Simple Profile)	PCM/ADPCM/MPEG/MP3/WMA/AC3/DTS	PAL: 25 Hz 720 x 576 or less NTSC: 30Hz 720 x 480 or less
.MPE/ .MPG/ .MPEG	MPEG-1/ MPEG-2	PCM/ADPCM/LPCM/MPEG/MP3/WMA/AC3/DTS	PAL: 25 Hz 720 x 576 or less NTSC: 30Hz 720 x 480 or less
.DAT	MPEG-1	MPEG I or II /layer II	PAL: 25Hz 352 x 288/704 x 576 NTSC: 30Hz 352 x 240/704 x 480
.VOB	MPEG-2	PCM/ADPCM/LPCM/MPEG/MP3/WMA/AC3/DTS	PAL: 25Hz 720 x 576 NTSC: 30Hz 720 x 480

The file format must meet the following requirements

- Resolution: up to 720 x 576
- GMC (global motion compensation) point: Up to one
- Bit rate: CD: 5.6 Mbps
DVD: 19Mbps
USB: 5.57 Mbps (However, this may be slower depending on the performance of the USB storage.)

Specifications

Product name	EH-DM2			
Dimensions	320W x 135H x 230D mm (Including projections)			
Panel size	0.55" wide			
Display method	Polysilicon TFT active matrix			
Resolution	409, 920 pixels (854W x 480H dots) x 3			
Focus adjustment	Manual			
Zoom adjustment	Digital type (Approx. 1:1.35)			
Lamp (light source)	UHE lamp, 140W, Model No.: ELPLP44			
Power supply	100 - 240VAC +/-10%, 50/60Hz, 2.5 to 1.1A			
Power consumption	100 to 120VAC area	Operating: 225 W Standby: 5 W		
	220 to 240VAC area	Operating: 225W Standby: 5 W		
Operating altitude	Altitude: 0 m to 2286 m			
Operating temperature	+5 to +35°C (No condensation)			
Storage temperature	-10 to +60°C (No condensation)			
Mass	Approximately 3.8 kg			
Connectors	Input	Audio port	1	RCA pin jack
		Video port	1	RCA pin jack
		Component port	1	RCA pin jack
		Computer port	1	Mini D-Sub 15-pin
		USB port	1	Type A
	Output	Digital Coaxial Audio-Out port	1	RCA pin jack
		Headphone jack	1	3.5 mm mini-jack
Speakers	Maximum input 8W, Rated impedance 12 Ω ohms			
Audio output	Analog audio output	1 speaker system: Practical, maximum output 8W + 8W (10% THD)		
		1 headphone system: 25 mW/32 Ω ohms		
	Digital audio output	Dynamic range: 70 dB or more		
	Digital audio output	Digital coaxial output		

* The USB ports may not accept all USB-compatible devices.



Pixelworks DNX™ IC is installed in this unit.

Tilted angle

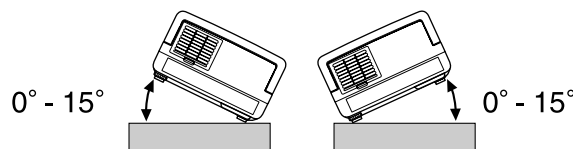

The unit may fail or may cause an accident if it is tilted more than 15 degrees.

DECLARATION of CONFORMITY

According to 47CFR, Part 2 and 15
Class B Personal Computers and Peripherals; and/or
CPU Boards and Power Supplies used with Class B Personal Computers

We : Epson America, INC.
Located at : 3840 Kilroy Airport Way
MS:3-13
Long Beach, CA 90806
Tel : 562-290-5254

Declare under sole responsibility that the product identified herein, complies with 47CFR Part 2 and 15 of the FCC rules as a Class B digital device. Each product marketed, is identical to the representative unit tested and found to be compliant with the standards. Records maintained continue to reflect the equipment being produced can be expected to be within the variation accepted, due to quantity production and testing on a statistical basis as required by 47CFR 2.909. Operation is subject to the following two conditions : (1) this device may not cause harmful interference, and (2) this device must accept any interference received, including interference that may cause undesired operation.

Trade Name : Epson
Type of Product : Projector
Model : H302C

FCC Compliance Statement For United States Users

This equipment has been tested and found to comply with the limits for a Class B digital device, pursuant to Part 15 of the FCC Rules. These limits are designed to provide reasonable protection against harmful interference in a residential installation. This equipment generates, uses, and can radiate radio frequency energy and, if not installed and used in accordance with the instructions, may cause harmful interference to radio or television reception. However, there is no guarantee that interference will not occur in a particular installation. If this equipment does cause interference to radio and television reception, which can be determined by turning the equipment off and on, the user is encouraged to try to correct the interference by one or more of the following measures.

- Reorient or relocate the receiving antenna.
- Increase the separation between the equipment and receiver.
- Connect the equipment into an outlet on a circuit different from that to which the receiver is connected.
- Consult the dealer or an experienced radio/TV technician for help.

WARNING

The connection of a non-shielded equipment interface cable to this equipment will invalidate the FCC Certification or Declaration of this device and may cause interference levels which exceed the limits established by the FCC for this equipment. It is the responsibility of the user to obtain and use a shielded equipment interface cable with this device. If this equipment has more than one interface connector, do not leave cables connected to unused interfaces. Changes or modifications not expressly approved by the manufacturer could void the user's authority to operate the equipment.

Glossary

HDTV

An abbreviated form of “High-Definition Television system” to be applied to a high-definition TV set that can satisfy the following requirements:

- Vertical resolution 720p or 1080i or higher (where, “p” refers to progressive scan, and “i” refers to interlace scan)
- 16:9 screen aspect ratio

JPEG

A file format used for saving image files. Most photographs taken with digital cameras are saved in the JPEG format.

MP3

The abbreviated form of “MPEG1 Audio Layer-3”, a standard for audio compression. It enables the size of the data to be greatly reduced, whilst maintaining a high sound quality.

NTSC

The abbreviated form of the “National Television Standards Committee”, and given to one of the analog color television wave transmission systems. This system is used in Japan, the USA and Latin America.

PAL

The abbreviated form of “Phase Alternation by Line”, and given to one of the analog color television wave transmission systems. This system is used in China, Western Europe, with the exception of France, and in other African and Asian countries.

SDTV

An abbreviated form of “Standard Definition Television”, and given to the standard TV broadcasting system that does not satisfy the HDTV requirements.

SECAM

The abbreviated form of “SEquential Couleur A Memoire”, and given to one of the analog color television wave transmission systems. This system is used in France, Eastern Europe, the former Soviet Union, the Middle East and some African nations.

WMA

The abbreviated form of “Windows Media Audio”, an audio compression technology developed by the Microsoft Corporation of America. You can encode WMA data using Windows Media Player Ver.7, 7.1, Windows Media Player for Windows XP, or the Windows Media Player 9 Series. When encoding WMA files, please use applications that have been certified by the Microsoft Corporation of America. If you use an application that has not been certified, it is possible that it may not operate correctly.

YCbCr

A transmission signal in the color bar signal waveform for the current TV set (NTSC system). Expressed by Y (brightness signal) CbCr (chromatin (color) signal).

YPbPr

A transmission signal in the color bar signal waveform for Hi-Vision. Expressed by Y (brightness signal) PbPr (color difference signal).

Aspect

The ratio between an image’s length and its height. HDTV images have an aspect ratio of 16:9 and appear elongated. The aspect ratio for standard images is 4:3. This unit can automatically detect the aspect ratio of a disc when it is played back.

Cool-down

A process to enable the lamp to cool down from the high temperatures attained during projection. Cool-down is automatically activated when you press  to turn off the power. Do not unplug the power cable during cool-down. If cool-down is not performed correctly, the lamp or internal structure of the main unit can overheat which may reduce the lifespan of the lamp or cause damage to this unit. Cool-down is complete once the main unit beeps twice.

Coaxial digital output

Converts the audio signal into a digital signal and enables it to be transmitted along coaxial cable.

Playback control (PBC)

A method for playing back Video CDs. You can select the screen or information you want to see from the menu screen displayed.

Disc related terms

Title/Chapter/Track

One movie on a DVD is divided into units called titles, which may contain any number of chapters.

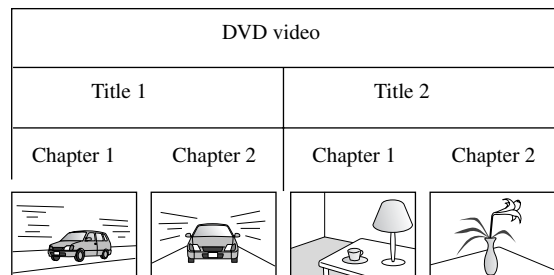

Video and Audio CDs are divided into units called tracks.

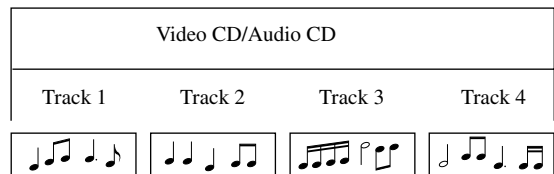

Index

A	
Audio page	52
Auto Setup	62
B	
Break	25
Brightness	56
C	
Chapter	74
Child lock	56
Cleaning the air filter and air intake vent	63
Cleaning the main unit	63
Cleaning the projection lens	63
Color Mode	25
Color Saturation	56
Computer input port	44
Consumables	64
Contrast	56
D	
Digital Output	52
Disc Lock	52
DivX	29
DivX VOD	52
Dolby Digital	52
Dolby Virtual Speaker	48
F	
Focus ring	20
H	
Headphones	47
High Altitude Mode	56
I	
Image page	56
Indicators	58
Info page	57
Inserting the batteries	16
L	
Lamp replacement period	64
Lamp-Hours	57
Language page	51
M	
Menu	26
MP3	29
MP3/JPEG NAV	52
Mute	25
N	
Night Mode	52
O	
Option page	56
Optional accessories	64
OSD Language	51
Others page	52
Overheating	59
P	
Password	52
PBC (playback control)	27
Playback information screen	37
Progressive	56
R	
Remote Control	15
Replacing the air filter	65
Replacing the lamp	66
Resetting the lamp operating time	67
S	
Sharpness	56
Source	57
Standing-by	60
T	
Tint	56
Title	74
Track	74
TV tuner	43
U	
USB	11, 42
V	
Video input port	43
Video Signal	56
Volume	20
W	
WMA	29
Z	
Zoom button	20

Inquiries

< EUROPE, MIDDLE EAST & AFRICA >

This address list is current as of the 5th of April, 2007.

A more up-to-date contact address can be obtained from the corresponding website listed here. If you do not find what you need on any of these pages, please visit the main Epson home page at www.epson.com.

ALBANIA :

INFOSOFT SYSTEM

Gjergji Center, Rr Murat Toptani
Tirana 04000 - Albania
Tel: 00 355 42 511 80/ 81/ 82/ 83
Fax: 00355 42 329 90
Web Address:
http://content.epson.it/about/int_services.htm

AUSTRIA :

EPSON DEUTSCHLAND GmbH

Buropark Donau Inkustrasse 1-7 / Stg. 8 / 1.
OG
A-3400 Klosterneuburg
Tel: +43 (0) 2243 - 40 181 - 0
Fax: +43 (0) 2243 - 40 181 - 30
Web Address:
<http://www.epson.at>

BELGIUM :

EPSON DEUTSCHLAND GmbH Branch office Belgium

Belgicastraat 4 - Keiberg
B-1930 Zaventem
Tel: +32 2/ 7 12 30 10
Fax: +32 2/ 7 12 30 20
Hotline: 070 350120
Web Address:
<http://www.epson.be>

BOSNIA AND HERZEGOVINA :

RECOS d.o.o.

Tvornicka 3 - 71000 Sarajevo
Tel: 00 387 33 767 330
Fax: 00 387 33 454 428
Web Address:
http://content.epson.it/about/int_services.htm

BULGARIA :

EPSON Service Center Bulgaria

c/o Reset Computers Ltd.
15-17 Tintiava Str.
1113 Sofia
Tel. : 00 359 2 911 22
Fax: 00 359 2 868 33 28
Email: reset@reset.bg
Web Address: <http://www.reset.bg>

CROATIA :

RECRO d.d.

Avenija V. Holjevca 40
10 000 Zagreb
Tel: 00385 1 3650774
Fax: 00385 1 3650798
Web Address:
http://content.epson.it/about/int_services.htm

CYPRUS :

TECH-U

75, Lemesou Avenue 2121 Cyprus
Tel: 00357 22 69 4000
Fax: 00357 22490240
Web Address:
http://content.epson.it/about/int_services.htm

CZECH REPUBLIC :

EPSON DEUTSCHLAND GmbH Branch Office Czech Republic

Slavickova 1a 63800 Brno
E-mail: infoline@epson.cz
Web Address:
<http://www.epson.cz>
Hotline: 800 142 052

DENMARK :

EPSON Denmark

Generatorvej 8 C 2730 Herlev
Tel: 44508585
Fax: 44508586
Email: denmark@epson.co.uk
Web Address:
<http://www.epson.dk>
Hotline: 70279273

ESTONIA :

EPSON Service Center Estonia

c/o Kulbert Ltd.
Sirge 4, 10618
Tallinn
Tel: 00372 671 8160
Fax: 00372 671 8161
Web Address:
<http://www.epson.ee>

FINLAND :

Epson (UK) Ltd.

Rajatorpantie 41 C FI-01640 Vantaa
Web Address:
<http://www.epson.fi>
Hotline: 0201 552091

FRANCE & DOM-TOM TERRITORY :

EPSON France S.A.

150 rue Victor Hugo BP 320
92305 LEVALLOIS PERRET CEDEX
Web Address:
<http://www.epson.fr>
Hotline: 0821017017

GERMANY :

EPSON Deutschland GmbH

Otto-Hahn-Strasse 4 D-40670 Meerbusch
Tel: +49-(0)2159-538 0
Fax: +49-(0)2159-538 3000
Web Address:
<http://www.epson.de>
Hotline: 01805 2341 10

GREECE :

EPSON Italia s.p.a.

274 Kifisias Avenue -15232 Halandri Greece
Tel: +30 210 6244314
Fax: +30 210 68 28 615
Email:
epson@information-center.gr
Web Address:
http://content.epson.it/about/int_services.htm

HUNGARY :

Epson Deutschland GmbH

Magyarorszagi Fiolkelepe 1117 Budapest
Inforpark setany 1.
Hotline: 06 800 14 783
E-mail: infoline@epson.hu
Web Address:
<http://www.epson.hu>

IRELAND :

Epson (UK) Ltd.

Campus 100, Maylands Avenue
Hemel Hempstead Herts HP2 7TJ
U.K.Techn.
Web Address:
<http://www.epson.ie>
Hotline: 01 679 9015

ITALY :

EPSON Italia s.p.a.

Via M. Vigano de Vizzi, 93/95
20092 Cinisello Balsamo (MI)
Tel: +39 06. 660321
Fax: +39 06. 6123622
Web Address:
<http://www.epson.it>
Hotline: 02 26830058

LATVIA :

EPSON Service Center Latvia

c/o ServiceNet LV
Jelgavas 36
1004 Riga
Tel.: 00 371 746 0399
Fax: 00 371 746 0299
Web Address:
<http://www.epson.lv>

LITHUANIA :

EPSON Service Center Lithuania

c/o ServiceNet
Gaiziunu 3
50128 Kaunas
Tel.: 00 370 37 400 160
Fax: 00 370 37 400 161
Web Address:
<http://www.epson.lt>

LUXEMBURG :

EPSON DEUTSCHLAND GmbH Branch office Belgium

Belgicastraat 4-Keiberg
B-1930 Zaventem
Tel: +32 2/ 7 12 30 10
Fax: +32 2/ 7 12 30 20
Hotline: 0900 43010
Web Address:
<http://www.epson.be>

MACEDONIAN :

DIGIT COMPUTER ENGINEERING

3 Makedonska brigada b.b upravna
zgrada R. Konkar - 91000 Skopje Macedonia
Tel: 00389 2 2463896
Fax: 00389 2 2465294
Web Address:
http://content.epson.it/about/int_services.htm

NETHERLANDS :

EPSON DEUTSCHLAND GmbH Branch office Netherland

J. Geesinkweg 501
NL-1096 AX Amsterdam-
Duivendrecht Netherlands
Tel: +31 20 592 65 55
Fax: +31 20 592 65 66
Hotline: 0900 5050808
Web Address:
<http://www.epson.nl>

NORWAY :

EPSON NORWAY

Lilleakerveien 4 oppgang 1A
N-0283 Oslo NORWAY
Hotline: 815 35 180
Web Address:
<http://www.epson.no>

POLAND :

EPSON DEUTSCHLAND GmbH
Branch Office Poland
 ul. Bokszerska 66
 02-690 Warszawa Poland
 Hotline: (0) 801-646453
 Web Address:
<http://www.epson.pl>

PORTUGAL :

EPSON Portugal
 R. Gregorio Lopes, n° 1514 Restelo 1400-195
 Lisboa
 Tel: 213035400
 Fax: 213035490
 Hotline: 707 222 000
 Web Address:
<http://www.epson.pt>

ROMANIA :

EPSON Service Center Romania
 c/o MB Distribution 162, Barbu Vacarescu
 Blvd., Sector 2
 71422 Bucharest
 Tel: 0040 21 231 7988 ext.103
 Fax: 0040 21 230 0313
 Web Address:
<http://www.epson.ro>

Russia :

EPSON CIS
 ul. Schepkina, 42, bldg 2a Moscow
 Tel. +7 (495) 737-37-88
 Fax: +7 (495) 777-03-57
 Hotline:(800) 200-37-88
 Web Address:
<http://www.epson.ru>
<http://www.support.epson.ru>

SERBIA AND MONTENEGRO :

BS PROCESSOR d.o.o.
 Hazdi Nikole Zivkovicica 2
 Beograd - 11000 - F.R. Jugoslavia
 Tel: 00 381 11 328 44 88
 Fax: 00 381 11 328 18 70
 Web Address:
http://content.epson.it/about/int_services.htm

SLOVAKIA :

EPSON DEUTSCHLAND GmbH Branch
Office Czech Republic
 Slavickova 1a
 638 00 Brno
 Hotline: 0850 111 429
 (national costs)
 Web Address:
<http://www.epson.sk>

SLOVENIA :

BIROTEHNA d.o.o.
 Smartinska 106
 1000 Ljubljana Slovenja
 Tel: 00 386 1 5853 410
 Fax: 00386 1 5400130
 Web Address:
http://content.epson.it/about/int_services.htm

SPAIN :

EPSON Iberica, S.A.
 Av. de Roma, 18-26
 08290 Cerdanyola del valles
 Barcelona
 Tel: 93 582 15 00
 Fax: 93 582 15 55
 Hotline: 902 404142
 Web Address:
<http://www.epson.es>

SWEDEN :

Epson Sweden
 Box 329 192 30 Sollentuna Sweden
 Tel: 0771-400134
 Web Address:
<http://www.epson.se>

SWITZERLAND :

EPSON DEUTSCHLAND GmbH
Branch office Switzerland
 Riedmuehlestrasse 8 CH-8305 Dietlikon
 Tel: +41 (0) 43 255 70 20
 Fax: +41 (0) 43 255 70 21
 Hotline: 0848448820
 Web Address:
<http://www.epson.ch>

TURKEY :

TECPRO
 Sti. Telsizler mah. Zincirlidere cad.
 No: 10 Kat 1/2 Kagithane 34410
 Istanbul
 Tel: 0090 212 2684000
 Fax: 0090212 2684001
 Web Address:
<http://www.epson.com.tr>
 Info: bilgi@epsonerisim.com
 Web Address:
<http://www.epson.tr>

UK :

Epson (UK) Ltd.
 Campus 100, Maylands Avenue
 Hemel Hempstead Herts HP2 7TJ
 Tel: (01442) 261144
 Fax: (01442) 227227
 Hotline: 08704437766
 Web Address:
<http://www.epson.co.uk>

AFRICA :

Contact your dealer
 Web Address:
http://www.epson.co.uk/welcome/welcome_africa.htm
 or
<http://www.epson.fr/bienvenu.htm>

SOUTH AFRICA :

Epson South Africa
 Grnd. Flr. Durham Hse, Block 6
 Fourways Office Park
 Cnr. Fourways Blvd. & Roos Str.
 Fourways, Gauteng, South Africa.
 Tel: +27 11 201 7741
 / 0860 337766
 Fax: +27 11 465 1542
 Email: support@epson.co.za
 Web Address:
<http://www.epson.co.za>

MIDDLE EAST :

Epson (Middle East)
 P.O. Box: 17383 Jebel Ali Free Zone Dubai
 UAE(United Arab Emirates)
 Tel: +971 4 88 72 1 72
 Fax: +971 4 88 18 9 45
 Email: supportme@epson.co.uk
 Web Address:
http://www.epson.co.uk/welcome/welcome_africa.htm

< NORTH, CENTRAL AMERICA & CARIBBEANI ISLANDS >**CANADA :**

Epson Canada, Ltd.
 3771 Victoria Park Avenue
 Scarborough, Ontario
 CANADA M1W 3Z5
 Tel: 905-709-9475
 or 905-709-3839
 Web Address:
<http://www.epson.com>

MEXICO :

Epson Mexico, S.A. de C.V.
 Boulevard Manuel Avila Camacho 389
 Edificio 1 Conjunto Legaria
 Col. Irrigacion, C.P. 11500
 Mexico, DF
 Tel: (52 55) 1323-2052
 Web Address:
<http://www.epson.com.mx>

U. S. A. :

Epson America, Inc.
 3840 Kilroy Airport Way
 Long Beach, CA 90806
 Tel: 562-276-4394
 Web Address:
<http://www.epson.com>

COSTA RICA :

Epson Costa Rica, S.A.
 Dela Embajada Americana,
 200 Sur y 300 Oeste
 Apartado Postal 1361-1200 Pavas
 San Jose, Costa Rica
 Tel: (506) 210-9555
 Web Address:
<http://www.epson.co.cr>

< SOUTH AMERICA >

ARGENTINA :

Epson Argentina S.A.

Avenida Belgrano 964/970 Capital Federal
1092, Buenos Aires, Argentina Tel: (54 11)
5167-0300
Web Address:
<http://www.epson.com.ar>

BRAZIL :

Epson Do Brasil Ltda.

Av. Tucunare, 720
Tambore Barueri,
Sao Paulo, SP 0646-0020, Brazil
Tel: (55 11) 4196-6100
Web Address:
<http://www.epson.com.br>

< ASIA & OCEANIA >

AUSTRALIA :

EPSON AUSTRALIA PTYLIMITED

3, Talavera Road, N.Ryde NSW 2113,
AUSTRALIA
Tel: 1300 361 054
Web Address:
<http://www.epson.com.au>

CHINA :

**EPSON (BEIJING) TECHNOLOGY
SERVICE CO.,LTD.**

8F,A. The Chengjian Plaza NO.18
Beitaipingzhuang Rd.,Haidian District,Beijing,
China
Zip code: 100088
Tel: 010-82255566-606
Fax: 010-82255123

**EPSON (BEIJING) TECHNOLOGY
SERVICE CO.,LTD.SHANGHAI
BRANCH PANYU ROAD SERVICE
CENTER**

NO. 127 Panyu Road, Changning District,
Shanghai China
ZIP code: 200052
Tel: 021-62815522
Fax: 021-52580458

**EPSON (BEIJING) TECHNOLOGY
SERVICE CO.,LTD.GUANGZHOU
BRANCH**

ROOM 1405,1407 Baoli Plaza,NO.2 , 6th
Zhongshan
Road,Yuexiu District, Guangzhou
Zip code: 510180
Tel: 020-83266808
Fax: 020- 83266055

**EPSON (BEIJING) TECHNOLOGY
SERVICE CO.,LTD.CHENDU BRANCH**

ROOM2803B, A. Times Plaza, NO.2, Zongfu
Road, Chengdu
Zip code: 610016
Tel: 028-86727703/04/05
Fax: 028-86727702

CHILE :

Epson Chile S.A.

La Concepcion 322 Piso 3
Providencia, Santiago,Chile
Tel: (562) 484-3400
Web Address:
<http://www.epson.com.cl>

COLOMBIA :

Epson Colombia Ltda.

Diagonal 109, 15-49
Bogota, Colombia
Tel: (57 1) 523-5000
Web Address:
<http://www.epson.com.co>

HONGKONG :

**EPSON Technical
Support Centre
(Information Centre)**

Units 516-517, Trade Square,
681 Cheung Sha Wan Road,
Cheung Sha Wan, Kowloon,
HONG KONG
Tech. Hot Line: (852) 2827 8911
Fax: (852) 2827 4383
Web Address:
<http://www.epson.com.hk>

JAPAN :

**SEIKO EPSON
CORPORATION
SHIMAUCHI PLANT**

VI Customer Support Group:
4897 Shimauchi, Matsumoto-shi, Nagano-ken,
390-8640 JAPAN
Tel: 0263-48-5438
Fax: 0263-48-5680
Web Address:
<http://www.epson.jp>

KOREA :

EPSON KOREA CO., LTD.

11F Milim Tower, 825-22 Yeoksam-dong,
Gangnam-gu, Seoul,135-934 Korea
Tel : 82-2-558-4270
Fax: 82-2-558-4272
Web Address:
<http://www.epson.co.kr>

MALAYSIA :

**EPSON TRADING
(MALAYSIA) SDN. BHD.**

3rd Floor, East Tower, Wisma Consplant 1
No.2, Jalan SS 16/4,
47500 Subang Jaya,
Malaysia.
Tel: 03 56 288 288
Fax: 03 56 288 388
or 56 288 399

SINGAPORE :

**EPSON SINGAPORE
PTE. LTD.**

1 HarbourFront Place #03-02
HarbourFront Tower One
Singapore 098633.
Tel: 6586 3111
Fax: 6271 5088

PERU :

Epson Peru S.A.

Av. Del Parque Sur #400
San Isidro, Lima, 27, Peru
Tel: (51 1) 224-2336
Web Address:
<http://www.epson.com.pe>

VENEZUELA :

Epson Venezuela S.A.

Calle 4 con Calle 11-1
Edf. Epson -- La Urbina Sur Caracas, Venezuela
Tel: (58 212) 240-1111
Web Address:
<http://www.epson.com.ve>

TAIWAN :

**EPSON Taiwan
Technology & Trading Ltd.**

14F.No. 7, Song Ren Road,
Taipei, Taiwan, ROC.
Tel: (02) 8786-6688
Fax: (02) 8786-6633
Web Address:
<http://www.epson.com.tw>

THAILAND:

EPSON (Thailand) Co.,Ltd.

24th Floor, Empire Tower,
195 South Sathorn Road, Yannawa, Sathorn,
Bangkok 10120, Thailand.
Tel: (02) 6700680 Ext. 310
Fax: (02) 6070669
Web Address:
<http://www.epson.co.th>

All rights reserved. No part of this publication may be reproduced, stored in a retrieval system, or transmitted in any form or by any means, electronic, mechanical, photocopying, recording, or otherwise, without the prior written permission of Seiko Epson Corporation. No patent liability is assumed with respect to the use of the information contained herein. Neither is any liability assumed for damages resulting from the use of the information contained herein.

Neither Seiko Epson Corporation nor its affiliates shall be liable to the purchaser of this product or third parties for damages, losses, costs, or expenses incurred by purchaser or third parties as a result of: accident, misuse, or abuse of this product or unauthorized modifications, repairs, or alterations to this product, or (excluding the U.S.) failure to strictly comply with Seiko Epson Corporation's operating and maintenance instructions.

Seiko Epson Corporation shall not be liable against any damages or problems arising from the use of any options or any consumable products other than those designated as Original Epson Products or Epson Approved Products by Seiko Epson Corporation.

The contents of this guide may be changed or updated without further notice.

Illustrations and screens used in this publication may differ from actual illustrations and screens.

Trademarks

Windows Media and Windows logos are trademarks or registered trademarks of Microsoft Corporation in the United States and other countries.

XGA is a trademark or a registered trademark of International Business Machine Corporation.

iMac is a registered trademark of Apple Inc.

Manufactured under license from Dolby Laboratories. "Dolby", "Pro Logic", and the double-D symbol are trademarks of Dolby Laboratories.

Manufactured under license under U.S. Patent #'s: 5,451,942; 5,956,674; 5,974,380; 5,978,762; 6,487,535 & other U.S. and worldwide patents issued & pending. DTS and DTS Digital Surround are registered trademarks and the DTS logos and Symbol are trademarks of DTS, Inc. © 1996-2007 DTS, Inc. All Rights Reserved.

DivX, DivX Ultra Certified, and associated logos are trademarks of DivX, Inc. and are used under license.

Pixelworks and DNX are trademarks of Pixelworks Inc.

DVD Video logo is a trademark.

We respect other trademarks or registered trademarks of respective companies even if they are not specified.