



PS-100 Series

User's Manual

Introduction

Thank you very much for purchasing a PS-100.

To use the device correctly, make sure you read the User's Manual along with the supplied Quick Start Guide.

Keep the supplied Quick Start Guide handy to help you resolve any problems.

Description in the User's Manual

! Important	Indicates things you must or must not do. Ignoring these instructions or mishandling this device could cause malfunction or operational problems to the device.
Note:	Indicates additional explanations and related information.
	Indicate related pages. Click the link in blue text to display the related page.

Trademarks

EPSON and EXCEED YOUR VISION are registered trademarks of the Seiko Epson Corporation.

Microsoft and Windows are registered trademarks of the Microsoft Corporation in the United States of America and other countries.

The Bluetooth[®] word mark and logos are the registered trademarks owned by Bluetooth SIG, Inc. and any use of such marks by Seiko Epson Corporation is under license.

Other product names are the trademarks or registered trademarks of their respective companies.

Caution:

- Unapproved copying of part or all of this manual is strictly forbidden.
- The content of this manual is subject to change without prior notice.
- Although every effort has been made to ensure the accuracy of this manual, contact us if you have any questions or notice any errors in descriptions in the content of this manual.
- Despite the preceding clause, we cannot accept any responsibility of mishandling due to errors in this manual.
- We cannot accept any responsibility for malfunctions and so on that occur due to ignoring the content of this manual, the device being handled inappropriately, repairs or modifications performed by a third party that is not our company or appointed by our company.

System Requirement

- A smart device such as a smart phone or tablet with Bluetooth® Smart capability is needed to upload product recorded data.

Please check the below link for the latest compatibility.

www.epson.eu/pulsense

Note:

PS-100 has Bluetooth® Smart to transfer data to PULSESENSE View.

Uploaded data can be seen via PULSESENSE View for Web (URL: go-wellness.epson.com).

To upload your data from PS-100	Use the PULSESENSE View for iOS, Android on your smart device. Your data will be transferred via Bluetooth® Smart.
See the data	Log into PULSESENSE View for iOS, Android on your smart device.
	Log into the PULSESENSE View web application.

Note:

To charge the PS-100 a USB port is required. You can use the USB port of a PC or an AC adapter. We recommend using the specified AC adapter. (SFAC03 for UK and Ireland. SFAC02 for Europe excluding UK and Ireland.)

Contents

Introduction	2
Description in the User's Manual.....	2
Trademarks.....	2
Caution:	2
System Requirement	3
Contents	4
Using this Device Safely	6
Symbols in this manual.....	6
Notes on Using the Product and Components	7
Notes on using the cradle	8
Regulatory and Safety Notices	8
Set up and Basic Operation	10
Things You Can Do With The Product	11
Measuring items.....	11
The heart rate zone.....	11
What's in the box	12
Options.....	12
Getting Started	13
To record your data.....	13
How to cancel the battery protection mode	13
Start-up operation:	16
Wearing the PS-100.....	17
Initial Configuration.....	19
Smart device user	19
How to Use	22
Heart rate measurement.....	23
How to stop and resume heart rate measurement	26
Low battery notification.....	27
Airplane Mode	28
Turn off Airplane Mode	29
Additional Functions	30
Notification Settings.....	31
Wake-up Alarm.....	31
Maintenance	32
Looking after your device	33
About the wristband	33
Replacing the Battery	34
Updating the Firmware	35

Appendix	36
Product Specification	37
Device Specifications	37
Cradle Specification	37
Options specifications	37
Troubleshooting	39
Caution	40
Problem Solving	41
System Reset	42
Contacting us.....	43

Using this Device Safely

Make sure you read the manuals (Quick Start Guide and User's Manual) first to use this product safely.

The product may malfunction, or an accident may occur if it is handled incorrectly.

- Keep the manuals handy to help you resolve any problems.
- When taking this product out of the country of purchase, check the laws and regulations in the destination country before you travel.
- This product is not a medical device. Use this product as an indicator during physical exercise.

Symbols in this manual

The following symbols are used in this manual to indicate possible dangerous operations or handling. Make sure you understand these warnings before using the product.

 **Warning:**

This symbol indicates information that, if ignored, could possibly result in serious personal injury.

 **Caution:**

This symbol indicates information that, if ignored, could possibly result in personal injury or damage the product.









This symbol indicates an action that should be done.



This symbol indicates an action that must not be done.

Notes on Using the Product and Components

 Warning	
	<p>Exercise according to your physical capabilities. Stop exercising and consult your doctor if you feel unwell during exercise.</p>
	<p>This product is a highly accurate sensor and able to measure your pulse rate; However, this is not a medical device. If you have any concerns, consult your doctor before using this product.</p>
	<p>Do not keep your eyes on the device while exercising; otherwise you could fall or cause a traffic accident. Pay attention to your surroundings while using the device.</p>
	<p>Do not use or store this product in the following environments. It may cause an electric shock or fire, or the product may malfunction or be damaged.</p> <ul style="list-style-type: none"> - Locations with very high or low temperatures or humidity - Near volatile substances - Sooty or dusty places - Near a fire - Near a strong magnetic field (for example, near a loudspeaker)
	<p>Do not disassemble this product, and do not attempt to repair this product by yourself. It may cause an electric shock or accident.</p>
	<p>Do not leave this product within reach of young children.</p>

 Caution	
	<p>To avoid the possibility of skin irritation or discomfort from wearing the PS-100, you must keep the skin under the band clean and dry at all times. Do not allow water, sweat, dead skin, or dirt to build up under the band. Do not wear the product too tight. If you feel any discomfort, loosen the wristband or stop usage.</p>
	<p>Avoid water, sweat or dirt build up between your skin and the product. Clean as directed in “Looking after your device” on page 33 .</p>
	<p>During sleep your wrist may swell, loosen the band by one setting if it becomes tight.</p>
	<p>Do not pour water directly from the tap onto this product. The power of the tap water stream may be strong enough to compromise the product’s waterproof feature</p>
	<p>Do not wear this product in a bath or sauna. The steam and soap may compromise the waterproof feature or cause corrosion.</p>

Note:

Please note that even if not used, the PS-100 should be charged at least once within a 6 month period. Failing to do so might affect the performance of the rechargeable battery.

Notes on using the cradle



Warning



Do not use the cradle or AC adapter if they are in any way damaged, faulty or contaminated by foreign material such as dust, water or dirt. Do not use any adapter other than the specified adapter for charging

Regulatory and Safety Notices



Data communication between the smartphone and product is made by Bluetooth Low Energy which operates in the 2.4GHz band.

Hereby, SEIKO EPSON, declares that this PS-100 is in compliance with the essential requirements and other relevant provisions of Directive 1999/5/EC.

This equipment may be operated in the UK and Ireland, Germany and France.

SEIKO EPSON CORPORATION,
3-3-5 Owa, Suwa-shi, Nagano-Ken, 392-8502, Japan



Warning



In areas in which usage is restricted, such as on airplanes and in hospitals, follow the rules and regulations provided (such as in-flight announcements).

Do not use the device if you have a surgically implanted medical device such as cardiac pacemaker.



Do not bring the device into an operating room, intensive care unit, and so on, and do not use the device near medical equipment. Radio waves from the device may interfere with electronic medical equipment causing the equipment to malfunction and cause an accident.

This device is equipped with Bluetooth® Smart technology. When operating supported HR monitors or smart phones, this function wirelessly sends and receives heart rate measurement data to the device.

This device has been certified as a wireless device based on the Radio Law. Therefore, the following acts may be punishable by law.

- Disassembling or remodeling the device
- Removing the verification or certification number for the device

Set up and Basic Operation

You need to make the following preparations before use.

 [“Things You Can Do with the Product”](#) on page 11

 [“What’s in the box”](#) on page 12

 [“Getting Started”](#) on page 13

 [“Initial Configuration”](#) on page 19

Things You Can Do With The Product

Measuring items

Items	Contents
Heart rate	The PS-100 reads and records your heart rate from the changes in light reflected through the blood vessels in your wrist.
Calories	PULSESENSE calculates the actual burned calories based upon the body motion and the heart rate information, which is related very closely to the calories burned, enabling more detailed calorie calculation. When heart rate measurement is disabled, the PS-100 will calculate calories based on body motion only.
Steps	Records the number of steps and calculates the distance using the accelerometer to measure your body movement. This function enables you to consciously track your general activity, so you can make small changes to become more active.
Distance	The distance is calculated approximately from the step count and your height.

Note:

Irregular arm movements may effect the reading on the steps and distance counters.

The heart rate zone

PULSESENSE monitors your heart rate across 5 zones, as detailed below. This is displayed on LEDs on the device, you can also set a vibration alert. See 'How to Use' section for details.

The heart rate zone	Name
0 – 40%	Below
40 – 70%	Fat Burning
70 – 80%	Aerobic
80 – 90%	Anaerobic
90 -100%	Maximum

Note:

- Your initial target zone is calculated by your profile data.
- When using the PS-100 overnight the heart rate zones will be adjusted according to your basal heart rate (minimum heart rate).

What's in the box

Contact your reseller if there are any missing or damaged components.

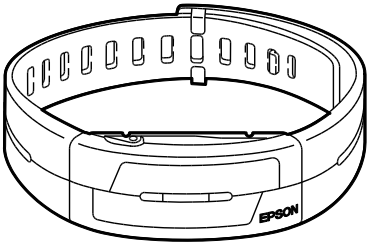
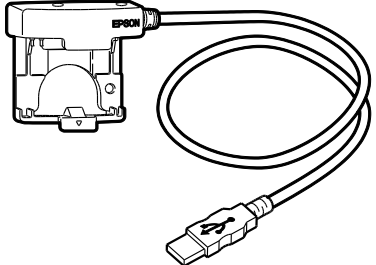
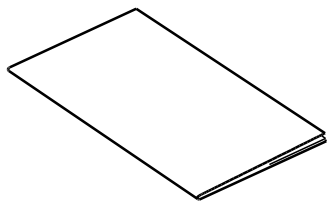
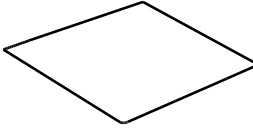
PS-100	Charging Cradle
	
Quick Start Guide	Information sheet
	

Options

You can purchase the following optional extras. Contact your local reseller for more information.

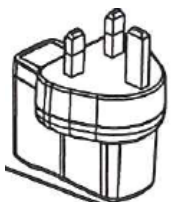
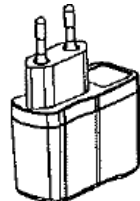
AC Adapter (SFAC03 for UK and Ireland.)	AC Adapter (SFAC02 for Europe excluding UK and Ireland.)
	

Getting Started

To record your data

! Important

To record your data it is necessary to register your device with the PULSESENSE View PC or smart device application.

How to cancel the battery protection mode

! Important

- You need to charge the product when using it for the first time.
- The product automatically turns on when being charged.
- Make sure that charging is complete.

1 Attach the product to the charging cradle

Clip the product into the cradle, ensuring that the metal terminals are connected as illustrated.

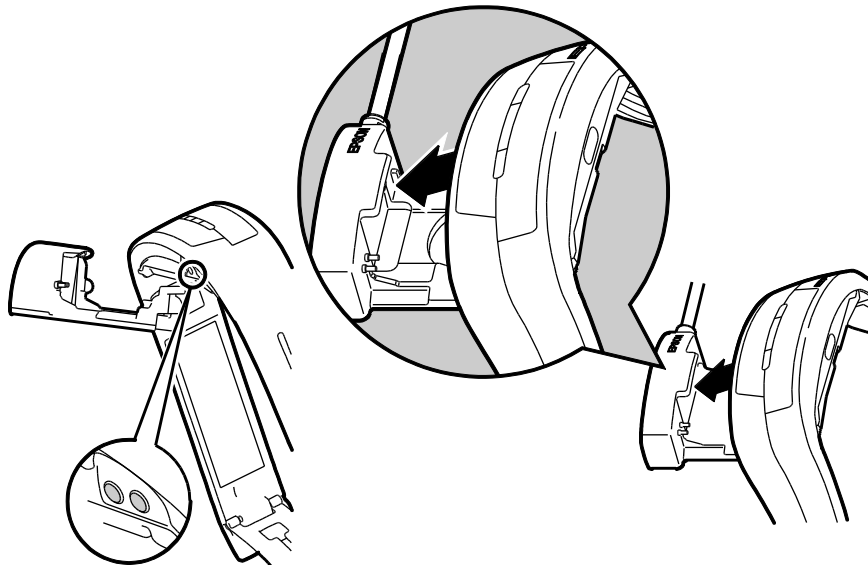

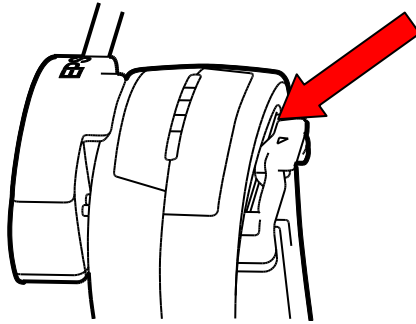

! Important

Before you place the product to the charging cradle, please check the below illustration.

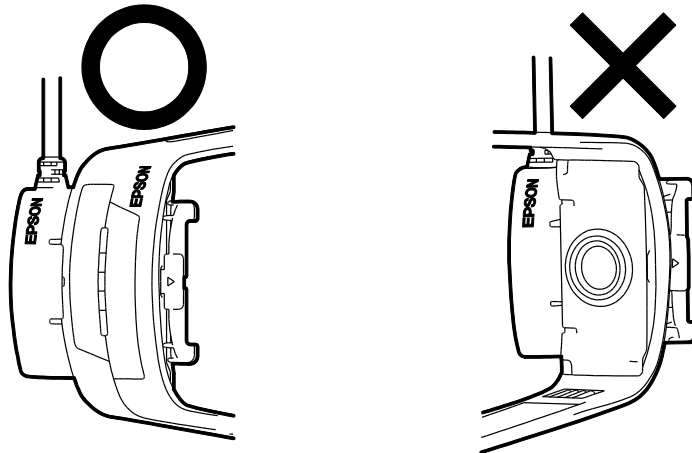

2 Insert charging cradle's USB cable into the USB port on your PC

Note:

You can use a PC to charge your PS-100, but not to upload any data. PS-100 requires Bluetooth® Smart to upload data.

Some PC USB ports may not support the charging function.

Please note that if you are connecting the charging cradle via a USB hub it may not charge. In this case please connect directly to the USB port of the PC.

3 Using an AC adapter

Connect the charging cradle with the AC adapter, and then insert the AC adapter into the power socket.

We recommend using the specified AC adapter (SFAC03 for UK and Ireland. SFAC02 for Europe excluding UK and Ireland.)

Note:

- An orange LED will be shown while charging and the LED will change to blue when the PS-100 is fully charged

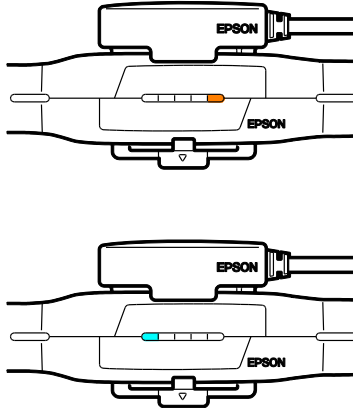

- Charging takes approximately 1.5 to 2.5 hours to complete; however, the duration may vary.

! Important

- The remaining battery charge cannot be checked with the product. Check the remaining battery charge under device settings in the PULSEVIEW app.
- Please note that even if not used, the PS-100 should be charged at least once within a 6 month period. Failing to do so might effect the performance of the rechargeable battery.
- Battery is not replaceable.

4 Detach the charging cradle from the product

Press the clip and push from behind with your finger to release the product.

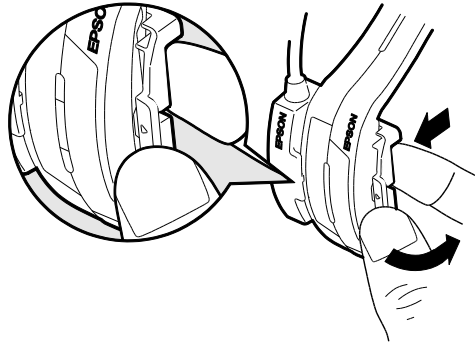

The product will be ready for configuration when fully charged and detached from the charging cradle.

Start-up operation:

All LEDs light up in sequence and the PS-100 will vibrate

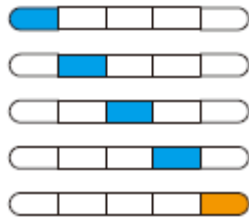

! Important

- Pair with your smart device after purchase. The time will be set on the PS-100 from your smart device. The memory of your device will not be enabled until pairing is completed.
- If you remove the PS-100 from your wrist and no movement is detected, it will go into sleep mode. It will re-wake if the product is moved.

Wearing the PS-100

Note:

When wearing the product, make sure it does not touch the bone on your wrist.

Wear the product closely around your wrist. Tighten the wrist band if your pulse is not measured correctly while exercising.

Note:

Do not wear the product too tight. If you feel any discomfort, loosen the wristband. During sleep your wrist may swell, loosen the band by one setting if it becomes tight.

- 1** Measure the circumference of your wrist, for example, using a string. Measure the circumference closely at the position indicated in the illustration without touching the ulna bone.

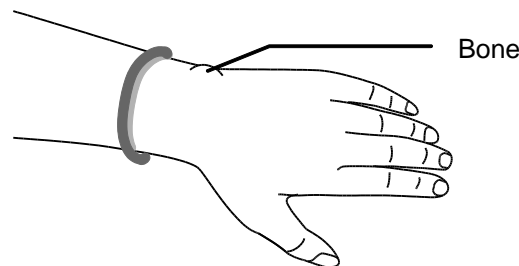

- 2** Check the hole numbers from the length around the arm using table below. The hole number is stamped in back of band. PS-100 S/M size has S1 to S9, PS-100 M/L size has L1 to L11.

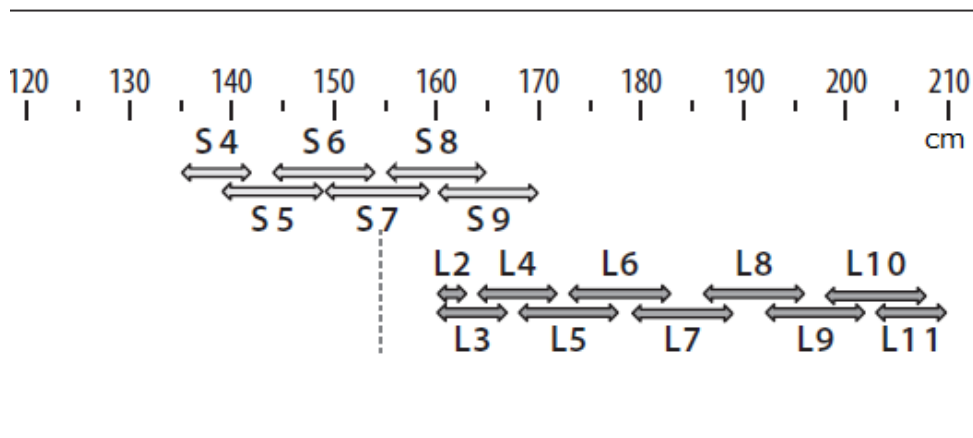

3 Unfasten the buckle of the wristband as shown below.

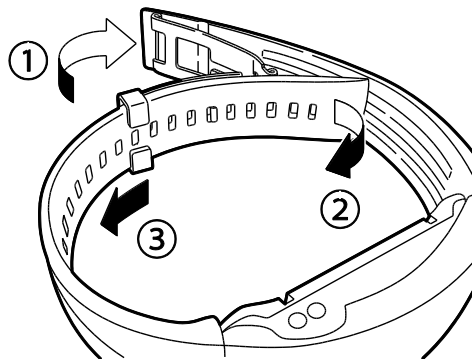

4 Insert the band fastener into the hole number you checked in step 3.
The following figures are of a fastener inserted at "wristband adjustment hole" L7.

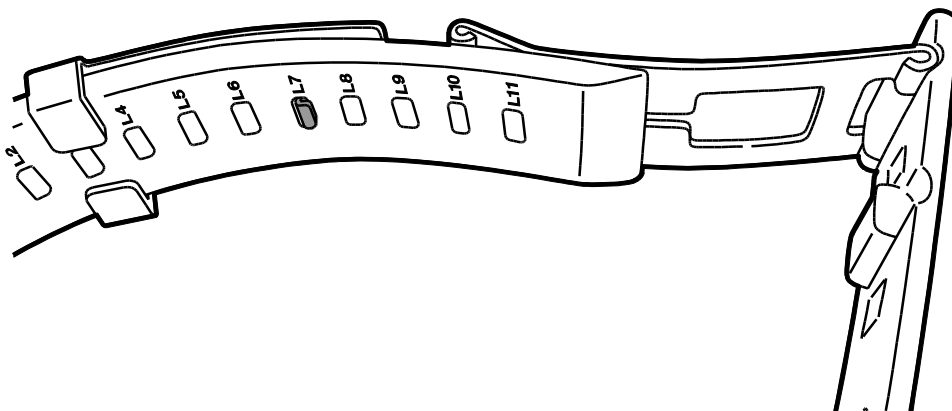

5 Put your hand through the wristband and fasten the buckle. When wearing the product, make sure it does not touch the bone. Adjust the wristband to a smaller hole number if the wristband is too loose.

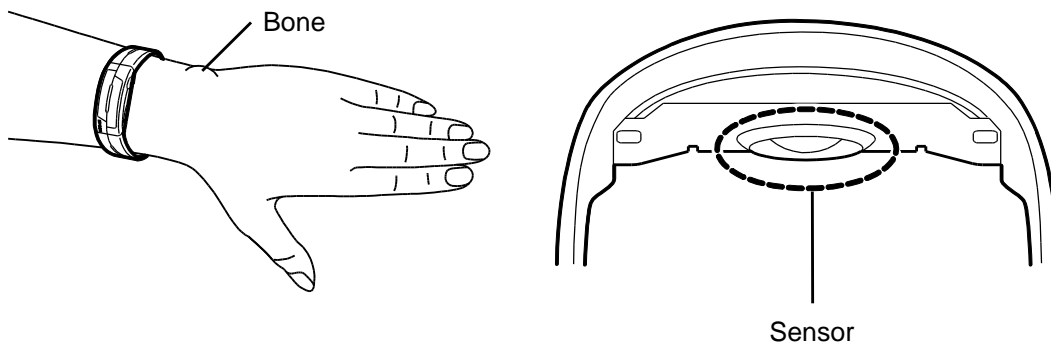

Initial Configuration

! Important

You need to perform initial configuration before using the PS-100 for the first time. Create a PULSESENSE View account and connect to a smart device.

Smart device user

1 Search your smart device's app store for the dedicated application Epson PULSESENSE View (free), and then install it.

Check that "Internet communication" and "Bluetooth®" are enabled in your smart device. Check the operating instructions for your smart device for the configuration method.

2 Start Epson PULSESENSE View.

Make sure that the product is within one meter from the smart device with the product.

Note:

Set Bluetooth® on your smart device to ON.

Ensure your smart device is connected to the Internet.

PULSESENSE View Icon



3 Follow the instructions in the Epson PULSENSE View Manual to proceed.

You need to set up a PULSENSE View account and follow the on-screen instructions.

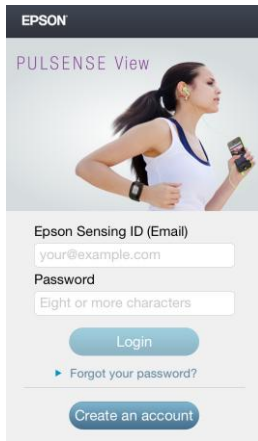

Once you have created your account and completed your profile, follow the on-screen instructions to pair your PS-100 with your smart device.

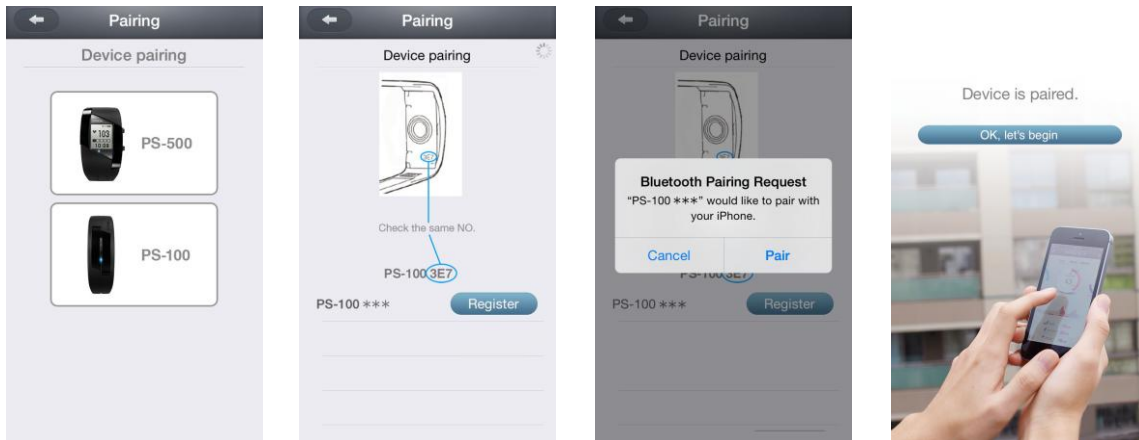

Once pairing is completed the LEDs will light up twice in sequence and the above screen is displayed on the smart device.



Pairing issues

<When using the product for the first time>

Check	What
1	Attach the PS-100 to the cradle to cancel the battery protection mode.
2	Enable Bluetooth [®] communication on your smart device.
3	To check smart device compatibility follow this link www.epson.eu/pulsense
4	Ensure your smart device is connected to the Internet.
5	Remove any other PULSENSE product that could interfere with the Bluetooth [®] communication.

<When pairing is lost or the PS-100 has been paired with another smart device>

Check	What
1	Has the PS-100 already been un-paired? If not, attach the PS-100 to the charging cradle and attached the cradle to a power supply. Tap the screen continuously until the blue lights flash. This will delete the current Bluetooth settings on the device.
2	Has the PS-100 already been deleted from PULSENSE View? Delete the PS-100 from the pairing menu in PULSENSE View
3	Has the PS-100 already been deleted in the Bluetooth [®] settings of your smart device? Delete the PS-100 from the Bluetooth [®] menu in smart device
4	Has Bluetooth [®] communication been enabled on your smart device?
5	To check smart device compatibility follow this link www.epson.eu/pulsense
6	Ensure your smart device is connected to the Internet.
7	Remove any other PULSENSE product that could interfere with the Bluetooth [®] communication.

How to Use

This product measures heart rate and activity 24 hours a day, tracking your steps, distance, calories, sleep quality and heart rate across five zones helping you to make better lifestyle choices.

 [“Heart rate measurement”](#) on page 23

 [“Low battery notification”](#) on page 27

 [“Airplane Mode”](#) on page 28

Heart rate measurement

Heart rate detection

- 1** Heart rate detection starts when the product is moved and the LEDs flash in sequence as shown below.

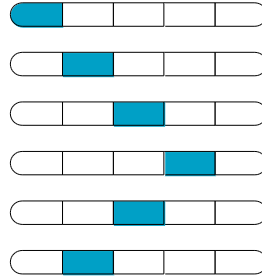

Note:



Heart rate detection will stop if the product is not worn and has not been moved for three minutes.
Heart rate detection will start again when the product has been moved.

- 2** After attaching the device to your wrist, the blue LEDs will all light up two times when it has detected your heart rate. The product will then be in the pulse measurement mode.

Note:

- Try to keep your body and arm still to facilitate heart rate detection.
- If the device does not detect your heart rate within one minute, the product will vibrate.
- If the device does not detect your heart rate within three minutes, the product will vibrate for longer and the LEDs will flash for 10 seconds. The PS-100 will stop the heart rate detection.
- You can resume heart rate detection by moving the product.





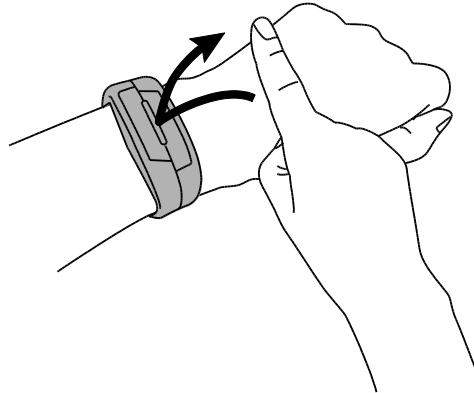

When the heart rate can't be detected

LED	Issue	How to solve
	It is likely that the device is not fitted correctly onto your wrist.	Wear the product closely around your wrist. Tighten the wrist band if your pulse is not measured correctly.
	It is likely that the device is not fitted correctly onto your wrist or the temperature on the surface of your skin is too low.	Wear the product closely around your wrist. Tighten the wrist band if your pulse is not measured correctly and warm your wrist and fingertips if they seem cold.

Heart rate zones

You can check your heart rate zone using the product LEDs. Setting can be made via PULSESENSE View to determine when the LEDs will illuminate. See below table for the available settings.



LED	% of max. heart rate	LED settings			
		TAP	FLASH	ON	OFF
	Under 40%	Blinking	OFF (If you tap, the LED will blink)		-
	40~49%	Blinking		ON	-
	50~59%	↑	↑	↑	-
	60~69%	↑	↑	↑	-
	70~79%	↑	↑	↑	-
	80~89%	↑	↑	↑	-
	Above 90%	Blinking (Faster)			-

Note:

- Your initial heart rate zones are calculated by your profile data. When using the PS-100 overnight the heart rate zones will be adjusted according to your basal heart rate (minimum heart rate).
- You can check your real time heart rate (updated every four seconds) in the PULSESENSE View app. Swipe the tab located in the middle at the top of the screen to the bottom in order to display the real-time meter.

How your heart rate measurement is being used

The PS-100 continuously monitors your heart rate and uses this recording in addition to your body movement to calculate the individual activities in PULSESENSE View. We therefore recommend having the heart rate detection enabled all the time, not only during exercise.

For more information, go to the Help section within the PULSESENSE View app.

How to stop and resume heart rate measurement

Heart rate detection will stop if the product is not worn and has not been moved for three minutes. Heart rate detection will start again when the product has been moved.

The below LED pattern will be shown when the PS-100 has been removed from your wrist.



Note:

Place the product onto a flat surface when you stop measurement.

It may take one to six minutes until the measurement will stop.

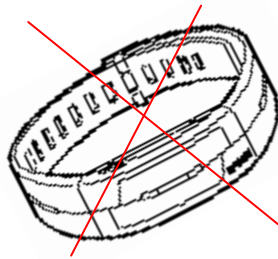

Resume heart rate measurement place the PS-100 onto your wrist and tighten the bands.

Low battery notification

If the remaining battery level is low, the orange LED will flash every 4 seconds.

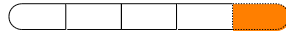

Once the remaining battery level is down to 1 hour, the orange LED flashes every second for 30 seconds. After this hour the PS-100 will stop measuring heart rate until the device has been charged.

Airplane Mode

Wireless communication needs to be switched OFF during a flight. Set the product to Airplane Mode before take-off.

Also, when transporting the product it is recommend using this mode.

1 Repeatedly tap the LED plate of the product as shown below.

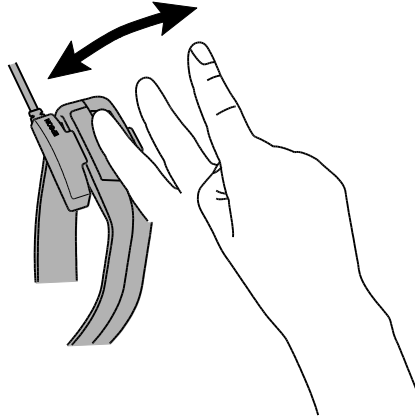

! Important

If you tap the PS-100 continuously as shown above while the device is connected to the charging cradle the pairing settings will be deleted.

The device will not go into airplane mode while measuring heart rate on your wrist, remove the product before tapping as above.

2 When the product is successfully set to Airplane Mode the LEDs will light up as shown below.

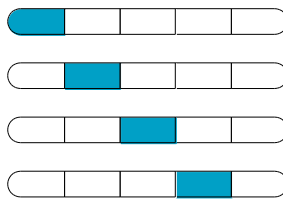

Note:

- To check if the product is in Airplane Mode, tap the device and the below LED pattern will be displayed.



- During Airplane Mode, the heart rate measurement and wireless communication will be disabled. However calories burned, steps and distance will continue to be calculated by the accelerometer sensor.

Turn off Airplane Mode

1 Repeatedly tap the LED plate of the product as shown below

The LEDs will light up and display the below pattern to confirm it is still in Airplane Mode.



2 Keep tapping until the LEDs go out.

The product will resume heart rate measurement and wireless communication.

Additional Functions

 [“Notification Settings”](#) on page 31

 [“Wake-up Alarm”](#) on page 31

Notification Settings

Depending on your settings the product can alert you by vibration and/or LEDs when you receive an E-mail, call or calendar notifications on your smart device.

To alert you the LEDs will light up six times as shown in the below pattern and will vibrate once if vibrate is enabled in the settings.

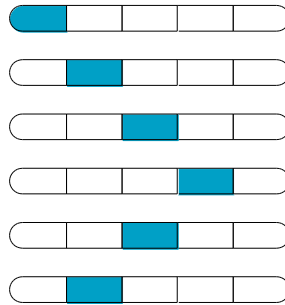

You need to enable the notification settings in the Device settings in PULSESENSE View. See PULSESENSE View help section for details.

Note:

The PS-100 must be connected via Bluetooth[®] to your smart device. Some additional settings might be required in the Notifications Settings of your smart device. See your smart device manual for details. Some Android devices may not support this function.

Wake-up Alarm

You can use the wake-up alarm to wake you up at the optimal time. The PS-100 will examine your sleep state for a given window before your alarm time. Within that window PULSESENSE will trigger the alarm (vibration) in a phase of shallow sleep so it is easy to wake up.

To alert you the LEDs will light up six times as shown in the below pattern and will vibrate if vibrate is enabled in the settings.

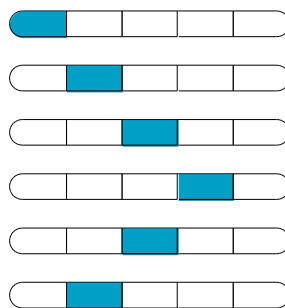

You need to set the alarm time and window time in the Device settings in PULSESENSE View. See the PULSESENSE View help section for details.

Maintenance

 [“Looking after your device”](#) on page 33

 [“Replacing the Battery”](#) on page 34

 [“Updating the Firmware”](#) on page 35

Looking after your device

Clean the PS-100 regularly. Wipe the product with a slightly moist soft cloth and then dry, or use a soft brush.

! Important:

Avoid water, sweat or dirt build up between your skin and the product as it could lead to skin irritations.

About the wristband

The wristband is made of silicon which could lose its elasticity and colour over time.

Replacing the Battery

You cannot replace the built-in rechargeable battery.

Updating the Firmware

You may be able to solve problems that occur by updating the firmware.

We recommend using the latest version.

! Important

When updating the firmware, the history may be deleted and settings may be initialised. For more details on updating by smart device, see the following website.

www.epson.eu/pulsense

Before updating the firmware, we recommend uploading your measurement data to PULSESENSE View.

Appendix

 ["Product Specification"](#) on page 37

Product Specification

Device Specifications

Contents	Specification
Model	PS-100
Size (LxWxH)	45mm x 22mm x 12.5mm (excluding sensor unit) 1.77in x 0.87in x 0.49in (excluding sensor unit)
Weight	S/M: 30g M/L: 31g
Wrist Size	S/M:135mm-160mm (5.31in-6.30in) M/L:150mm-210mm (5.91in-8.27in)
Battery	Rechargeable Lithium Polymer 40mAh
Battery Life(Heart rate ON)	Approx. 36hours (depending on usage)
Recharge Time	Approx. 2.5hours (from empty to full, depending on power source)
Water Resistance	3bar
Connectivity	Bluetooth [®] Smart
Operating Temperature	-5°C~+40°C
Storage Temperature	-20°C~+60°C

Cradle Specification

Contents	Specification
Operating Temperature	-5°C~35°C
Function	Recharge, update PS-100 data through PC.

Options specifications

You can purchase the following optional extras.

AC adapter

Contents	Specifications
Model	SFAC02 for Europe excluding UK and Ireland. SFAC03 for UK and Ireland.
Input	AC 100-240V 50/60Hz
Output	DC 5V / 1.0A

Troubleshooting

This section explains how to solve problems that occur during use.



[“Caution”](#) on page 40



[“Problem Solving”](#) on page 41



[“System Reset”](#) on page 42





[“Contacting us”](#) on page 43

Caution

- Clean the PS-100 regularly. Wipe the product with a slightly moist soft cloth and then dry, or use a soft brush.
Do not use the cradle or AC adapter if they are in any way damaged, faulty or contaminated by foreign material such as dust, water or dirt. Do not use any adapter other than the specified adapter for charging.
- If charging becomes unstable, clean the contact points on the device and cradle with a damp cotton swab.
- If device operations becomes unstable or if data transfer is not possible, perform a system reset by connecting the product to the cradle.
- Exercise according to your physical capabilities. Stop exercising and consult your doctor if you feel unwell during exercise
- During sleep and in other circumstances your wrist may swell, loosen the band by one setting if it becomes tight.
- We recommend to connect the PS-100 to your smart device once a day.

Problem Solving

Check each item.

	Problem	Solution
Basic Action	LED is not ON or Flashing.	After buying the product, the PS-100 is in battery protection mode. Set product to the cradle and connect to a USB port to charge the device and terminate the battery protection mode.  "Getting Started" on page 13
	The product is not responding according to the performed operation	Check the battery level and charge the device if necessary.
Charging	The device does not charge when set to the cradle. Charging stops frequently.	Charge in an environment where the surrounding temperature is 5 to 35°C Some PCs may not support the product. If you are connecting the charging cradle via a USB hub it may not charge. In this case please connect directly to the USB port of the PC. Clean the contact points of the product and charging cradle.  "Looking after your device" on page 32
	The product and charging cradle heat up while charging.	The product or cradle might be faulty. Immediately stop using the product and cradle, and contact our service center.
	A charging error is being displayed.	Charge in a location with an operating temperature of 5 to 35 °C.
Water Resistance	Can I use the product while swimming or diving?	The product is water resistant to 3bar. The product is not designed for swimming or diving.
	The inside of the glass where the sensor is located is cloudy.	Temporary clouding will not affect the product. Use it as is. If the clouding does not clear up after some time, water may have entered the product.
Accessories/Options	Where can I buy	The AC adapter is sold as an option. Please contact your local reseller. In addition, contact our service center if you require additional cradles.
Data Transfer	Data transfer is not possible even though the product is connected to a smart device.	Refer to the "Pairing issues" section on page 221 in this manual to resolve pairing issues.

System Reset

If device operations become unstable, perform a system reset by connecting the product to the cradle. Charging resets the system, and returns the product to normal operation.

If this suggestion does not solve your problem, check  [“Problem Solving”](#) on page 41.

Contacting us

Go to www.epson.eu/pulsense for service contact details.

EPSON EUROPE B.V.

Address: Atlas Arena, Azië building, Hoogoorddreef 5, 1101 BA Amsterdam Zuidoost,
The Netherlands

