

WF-4720 / WF-4730 Series

User's Guide

Copyright

No part of this publication may be reproduced, stored in a retrieval system, or transmitted in any form or by any means, electronic, mechanical, photocopying, recording, or otherwise, without the prior written permission of Seiko Epson Corporation. No patent liability is assumed with respect to the use of the information contained herein. Neither is any liability assumed for damages resulting from the use of the information herein. The information contained herein is designed only for use with this Epson product. Epson is not responsible for any use of this information as applied to other products.

Neither Seiko Epson Corporation nor its affiliates shall be liable to the purchaser of this product or third parties for damages, losses, costs, or expenses incurred by the purchaser or third parties as a result of accident, misuse, or abuse of this product or unauthorized modifications, repairs, or alterations to this product, or (excluding the U.S.) failure to strictly comply with Seiko Epson Corporation's operating and maintenance instructions.

Seiko Epson Corporation and its affiliates shall not be liable for any damages or problems arising from the use of any options or any consumable products other than those designated as Original Epson Products or Epson Approved Products by Seiko Epson Corporation.

Seiko Epson Corporation shall not be held liable for any damage resulting from electromagnetic interference that occurs from the use of any interface cables other than those designated as Epson Approved Products by Seiko Epson Corporation.

© 2016 Seiko Epson Corporation. All rights reserved.

The contents of this manual and the specifications of this product are subject to change without notice.

Trademarks

- ❑ EPSON® is a registered trademark, and EPSON EXCEED YOUR VISION or EXCEED YOUR VISION is a trademark of Seiko Epson Corporation.
- ❑ Epson Scan 2 software is based in part on the work of the Independent JPEG Group.
- ❑ libtiff

Copyright © 1988-1997 Sam Leffler

Copyright © 1991-1997 Silicon Graphics, Inc.

Permission to use, copy, modify, distribute, and sell this software and its documentation for any purpose is hereby granted without fee, provided that (i) the above copyright notices and this permission notice appear in all copies of the software and related documentation, and (ii) the names of Sam Leffler and Silicon Graphics may not be used in any advertising or publicity relating to the software without the specific, prior written permission of Sam Leffler and Silicon Graphics.

THE SOFTWARE IS PROVIDED "AS-IS" AND WITHOUT WARRANTY OF ANY KIND, EXPRESS, IMPLIED OR OTHERWISE, INCLUDING WITHOUT LIMITATION, ANY WARRANTY OF MERCHANTABILITY OR FITNESS FOR A PARTICULAR PURPOSE.

IN NO EVENT SHALL SAM LEFFLER OR SILICON GRAPHICS BE LIABLE FOR ANY SPECIAL, INCIDENTAL, INDIRECT OR CONSEQUENTIAL DAMAGES OF ANY KIND, OR ANY DAMAGES WHATSOEVER RESULTING FROM LOSS OF USE, DATA OR PROFITS, WHETHER OR NOT ADVISED OF THE POSSIBILITY OF DAMAGE, AND ON ANY THEORY OF LIABILITY, ARISING OUT OF OR IN CONNECTION WITH THE USE OR PERFORMANCE OF THIS SOFTWARE.

- ❑ Microsoft®, Windows®, and Windows Vista® are registered trademarks of Microsoft Corporation.
- ❑ Apple, Macintosh, Mac OS, OS X, Bonjour, Safari, iPad, iPhone, iPod touch, and iTunes are trademarks of Apple Inc., registered in the U.S. and other countries. AirPrint and the AirPrint logo are trademarks of Apple Inc.
- ❑ Google Cloud Print™, Chrome™, Chrome OS™, and Android™ are trademarks of Google Inc.
- ❑ Adobe and Adobe Reader are either registered trademarks or trademarks of Adobe Systems Incorporated in the United States and/or other countries.
- ❑ The N-Mark is a trademark or registered trademark of NFC Forum, Inc. in the United States and in other countries.
- ❑ Intel® is a registered trademark of Intel Corporation.
- ❑ General Notice: Other product names used herein are for identification purposes only and may be trademarks of their respective owners. Epson disclaims any and all rights in those marks.

Contents

Copyright

Trademarks

About This Manual

Introduction to the Manuals.	9
Marks and Symbols.	9
Descriptions Used in this Manual.	10
Operating System References.	10

Important Instructions

Safety Instructions.	11
Printer Advisories and Warnings.	12
Advisories and Warnings for Setting Up/ Using the Printer.	12
Advisories and Warnings for Using the Printer with a Wireless Connection.	13
Advisories and Warnings for Using the Touchscreen.	13
Protecting Your Personal Information.	13

Printer Basics

Part Names and Functions.	14
Control Panel.	17
Buttons and Lights.	17
Basic Screen Configuration.	18
Touch Screen Operations.	18
Icons displayed in the LCD Screen.	19
Entering Characters.	20
Viewing Animations.	21
Registering Your Favorite Settings as a Preset.	22
Menu Options for Preset.	22

Network Settings

Network Connection Types.	23
Ethernet Connection.	23
Wi-Fi Connection.	23
Wi-Fi Direct (Simple AP) Connection.	24
Connecting to a Computer.	24
Connecting to a Smart Device.	26
Making Wi-Fi Settings from the Printer.	26
Making Wi-Fi Settings Manually.	27

Making Wi-Fi Settings by Push Button Setup (WPS).	28
Making Wi-Fi Settings by PIN Code Setup (WPS).	29
Making Wi-Fi Direct (Simple AP) Connection Settings.	30
Making Advanced Network Settings.	31
Checking the Network Connection Status.	32
Network Icon.	33
Checking Detailed Network Information from the Control Panel.	33
Printing a Network Connection Report.	33
Printing a Network Status Sheet.	37
Replacing or Adding New Access Points.	38
Changing the Connection Method to a Computer.	38
Changing the Network Connection to Ethernet from the Control Panel.	40
Disabling Wi-Fi from the Control Panel.	40
Disconnecting Wi-Fi Direct (Simple AP) Connection from the Control Panel.	40
Restoring the Network Settings from the Control Panel.	41

Loading Paper

Paper Handling Precautions.	42
Available Paper and Capacities.	43
List of Paper Type.	44
Loading Paper in the Paper Cassette.	45

Placing Originals

Available Originals for the ADF.	49
Placing Originals on the ADF.	49
Placing Originals on the ADF for 2-up Copying.	51
Placing Originals on the Scanner Glass.	51

Managing Contacts

Registering or Editing Contacts.	53
Registering or Editing Grouped Contacts.	53
Register Contacts on a Computer.	54
Destination Setting Items.	54
Registering Destinations as a Group.	55
Exporting and Importing Contacts Using a Computer.	56
Export the Contacts.	56

Contents

Import the Contacts.	56
Printing	
Printing from the Control Panel.	58
Printing JPEG Files from a Memory Device.	58
Printing TIFF Files from a Memory Device.	59
Menu Options for Memory Device.	59
Printing from a Computer.	61
Printing Basics - Windows.	61
Printing Basics - Mac OS X.	63
Printing on 2-Sides.	65
Printing Several Pages on One Sheet.	67
Printing to Fit the Paper Size.	68
Printing Multiple Files Together (for Windows Only).	70
Printing One Image on Multiple Sheets to Create a Poster (for Windows Only).	71
Printing Using Advanced Features.	77
Printing Photos Using Epson Easy Photo Print.	80
Printing from Smart Devices.	80
Using Epson iPrint.	80
Using AirPrint.	83
Canceling Printing.	84
Canceling Printing - Control Panel.	84
Canceling Printing - Windows.	84
Canceling Printing - Mac OS X.	84
Copying	
Copying Basics.	86
Basic Menu Options for Copying.	86
Advanced Menu Options for Copying.	87
Scanning	
Scanning Using the Control Panel.	89
Scanning to a Network Folder or FTP Server.	89
Scanning to an Email.	91
Scanning to a Computer (Event Manager).	94
Scanning to a Memory Device.	97
Scanning to the Cloud.	99
Scanning to a Computer (WSD).	101
Scanning from a Computer.	103
Scanning Using Epson Scan 2.	103
Scanning from Smart Devices.	106
Installing Epson iPrint.	106
Scanning Using Epson iPrint.	106
Scanning by Touching Smart Devices to the NFC Tag.	107
Faxing	
Setting Up a Fax.	109
Connecting to a Phone Line.	109
Making Basic Fax Settings.	112
Sending Faxes.	116
Basic Fax Sending Operations.	116
Various Ways of Sending Faxes.	118
Receiving Faxes.	120
Setting Receive Mode.	120
Various Ways of Receiving Faxes.	121
Saving of Received Faxes.	123
Using Other Faxing Features.	127
Printing Fax Report and List.	127
Setting Security for Faxing.	128
Menu Options for Fax Mode.	128
Recipient.	128
Fax Settings.	128
More.	130
Menu Options for Fax Settings.	130
Check Fax Connection.	131
Fax Setting Wizard.	131
Receive Settings.	131
Report Settings.	133
Basic Settings.	133
Security Settings.	134
Menu Options for User Settings.	134
Menu Options for Inbox.	135
Replacing Ink Cartridges and Other Consumables	
Checking the Status of the Remaining Ink and the Maintenance Box.	136
Checking the Status of the Remaining Ink and the Maintenance Box - Control Panel.	136
Checking the Status of the Remaining Ink and the Maintenance Box - Windows.	136
Checking the Status of the Remaining Ink and the Maintenance Box - Mac OS X.	136
Ink Cartridge Codes.	137
Ink Cartridge Handling Precautions.	137
Replacing Ink Cartridges.	140
Maintenance Box Code.	140
Maintenance Box Handling Precautions.	140
Replacing the Maintenance Box.	141
Temporarily Printing with Black Ink.	141
Temporarily Printing with Black Ink - Windows	142

Contents

Temporarily Printing with Black Ink - Mac OS X.	143
Conserving Black Ink when the Black Ink Is Low (for Windows Only).	143

Maintaining the Printer

Checking and Cleaning the Print Head.	145
Checking and Cleaning the Print Head - Control Panel.	145
Checking and Cleaning the Print Head - Windows.	146
Checking and Cleaning the Print Head - Mac OS X.	146
Aligning the Print Head.	146
Aligning the Print Head - Control Panel.	147
Cleaning the Paper Path for Ink Smears.	148
Cleaning the ADF.	148
Cleaning the Scanner Glass.	150
Saving Power.	151
Saving Power - Control Panel.	151

Menu Options for Settings

Menu Options for General Settings.	153
Basic Settings.	153
Printer Settings.	154
Network Settings.	156
Web Service Settings.	157
Menu Options for Supply Status.	158
Menu Options for Maintenance.	158
Print Head Nozzle Check:.	158
Print Head Cleaning:.	158
Print Head Alignment:.	158
Ink Cartridge Replacement:.	159
Paper Guide Cleaning:.	159
Menu Options for Print Status Sheet.	159
Configuration Status Sheet:.	159
Supply Status Sheet:.	159
Usage History Sheet:.	159
Menu Options for Print Counter.	159
Menu Options for User Settings.	160
Menu Options for Restore Default Settings.	160
Menu Options for Firmware Update.	160
Update:.	160
Notification:.	160

Network Service and Software Information

Epson Connect Service.	161
Web Config.	161
Running Web Config on a Web Browser.	162
Running Web Config on Windows.	162
Running Web Config on Mac OS X.	163
Windows Printer Driver.	163
Restricting Settings for the Windows Printer Driver.	164
Making Operation Settings for the Windows Printer Driver.	164
Mac OS X Printer Driver.	165
Making Operation Settings for the Mac OS X Printer Driver.	165
Epson Scan 2 (Scanner Driver).	166
Epson Event Manager.	166
PC-FAX Driver (Fax Driver).	167
FAX Utility.	167
Epson Easy Photo Print.	168
EPSON Software Updater.	169
EpsonNet Config.	169
Uninstalling Applications.	170
Uninstalling Applications - Windows.	170
Uninstalling Applications - Mac OS X.	171
Installing Applications.	171
Updating Applications and Firmware.	172
Updating the Printer's Firmware using the Control Panel.	172

Solving Problems

Checking the Printer Status.	174
Checking Messages on the LCD Screen.	174
Checking the Printer Status - Windows.	175
Checking the Printer Status - Mac OS X.	175
Checking the Software Status.	175
Removing Jammed Paper.	176
Paper Does Not Feed Correctly.	176
Paper Jams.	177
Paper Feeds at a Slant.	177
Several Sheets of Paper are Fed at a Time.	177
Original Does Not Feed in the ADF.	177
Power and Control Panel Problems.	178
Power Does Not Turn On.	178
Power Does Not Turn Off.	178
Power Turns Off Automatically.	178

Contents

LCD Screen Gets Dark.	179	Uneven Colors, Dirt, Spots, and so on Appear when Scanning from the Scanner Glass.	194
Touch Screen Does Not Respond.	179	Straight Lines Appear when Scanning from ADF.	194
Cannot Print from a Computer.	179	The Image Quality Is Rough.	194
When You Cannot Make Network Settings.	180	Offset Appears in the Background of Images.	194
Cannot Connect from Devices Even Though Network Settings are No Problems.	180	Text is Blurred.	195
Checking the SSID Connected to the Printer.	182	Moiré Patterns (Web-Like Shadows) Appear.	195
Checking the SSID for the Computer.	182	Cannot Scan the Correct Area on the Scanner Glass.	195
Suddenly the Printer Cannot Print over a Network Connection.	183	Text is Not Recognized Correctly when Saving as a Searchable PDF.	196
Suddenly the Printer Cannot Print Using a USB Connection.	184	Cannot Solve Problems in the Scanned Image.	196
Cannot Print from an iPhone or iPad.	184	Other Scanning Problems.	197
Printout Problems.	184	Scanning Speed Is Slow.	197
Printout is Scuffed or Color is Missing.	184	Cannot Send the Scanned Image by Email.	197
Banding or Unexpected Colors Appear.	185	Scanning Stops when Scanning to PDF/Multi-TIFF.	197
Colored Banding Appears at Intervals of Approximately 3.3 cm.	185	Problems when Sending and Receiving Faxes.	198
Blurry Prints, Vertical Banding, or Misalignment.	186	Cannot Send or Receive Faxes.	198
Print Quality is Poor.	186	Cannot Send Faxes.	199
Paper Is Smeared or Scuffed.	187	Cannot Send Faxes to a Specific Recipient.	199
Paper is Smeared During Automatic 2-Sided Printing.	188	Cannot Send Faxes at a Specified Time.	200
Printed Photos are Sticky.	188	Cannot Receive Faxes.	200
Images or Photos are Printed in Unexpected Colors.	189	Cannot Save Received Faxes to a Memory Device.	200
Cannot Print Without Margins.	189	Memory Full Error Occurs.	200
Edges of the Image are Cropped During Borderless Printing.	189	Sent Fax Quality Is Poor.	201
The Position, Size, or Margins of the Printout Are Incorrect.	190	Faxes Are Sent at the Wrong Size.	201
Printed Characters Are Incorrect or Garbled.	190	Received Fax Quality Is Poor.	202
The Printed Image Is Inverted.	190	Received Faxes Are Not Printed.	202
Mosaic-Like Patterns in the Prints.	191	Pages are Blank or only a Small Amount of Text is Printed on the Second Page in Received Faxes.	202
Uneven Colors, Smears, Dots, or Straight Lines Appear in the Copied Image.	191	Other Faxing Problems.	202
Moiré (Cross-Hatch) Patterns Appear in the Copied Image.	191	Cannot Make Calls on the Connected Telephone.	202
An Image of the Reverse Side of the Original Appears in the Copied Image.	191	Answering Machine Cannot Answer Voice Calls.	203
The Printout Problem Could Not be Cleared.	191	Sender's Fax Number Not Displayed on Received Faxes or the Number Is Wrong.	203
Other Printing Problems.	192	Other Problems.	203
Printing Is Too Slow.	192	Slight Electric Shock when Touching the Printer.	203
Printing Slows Down Dramatically During Continuous Printing.	192	Operation Sounds Are Loud.	203
Cannot Cancel Printing from a Computer Running Mac OS X v10.6.8.	192	The Date and Time Are Incorrect.	203
Cannot Start Scanning.	193	Memory Device Is not Recognized.	204
Scanned Image Problems.	194	Cannot Save Data to a Memory Device.	204
		Application Is Blocked by a Firewall (for Windows Only).	204
		"!" Is Displayed on the Photo Selection Screen.	204

Appendix

Technical Specifications.	205
Printer Specifications.	205
Scanner Specifications.	206
Interface Specifications.	206
Fax Specifications.	207
Network Function List.	207
Wi-Fi Specifications.	209
Ethernet Specifications.	209
Security Protocol.	210
Supported Third Party Services.	210
External USB Device Specifications.	210
Supported Data Specifications.	210
Dimensions.	211
Electrical Specifications.	212
Environmental Specifications.	213
System Requirements.	213
Regulatory Information.	214
Standards and Approvals.	214
German Blue Angel.	215
Restrictions on Copying.	215
Transporting the Printer.	215
Accessing an External USB Device From a Computer.	217
Restricting Access to an External USB Device From a Computer.	218
Using an Email Server.	218
Configuring Mail Server.	219
Email Server Setting Items.	220
Checking an Email Server Connection.	220
Where to Get Help.	222
Technical Support Web Site.	222
Contacting Epson Support.	222

About This Manual

Introduction to the Manuals

The following manuals are supplied with your Epson printer. As well as the manuals, check the various types of help information available from the printer itself or from the Epson software applications.

Important Safety Instructions (paper manual)

Provides you with instructions to ensure the safe use of this printer.

Start Here (paper manual)

Provides you with information on setting up the printer, installing the software, using the printer, and so on.

User's Guide (digital manual)

This manual. Provides overall information and instructions on using the printer, on network settings when using the printer on a network, and on solving problems.

You can obtain the latest versions of the above manuals with the following methods.

Paper manual

Visit the Epson Europe support website at <http://www.epson.eu/Support>, or the Epson worldwide support website at <http://support.epson.net/>.

Digital manual

Start EPSON Software Updater on your computer. EPSON Software Updater checks for available updates of Epson software applications and the digital manuals, and allows you to download the latest ones.

Related Information

➔ [“EPSON Software Updater” on page 169](#)

Marks and Symbols



Caution:

Instructions that must be followed carefully to avoid bodily injury.



Important:

Instructions that must be observed to avoid damage to your equipment.

Note:

Provides complementary and reference information.

➔ Related Information

Links to related sections.

Descriptions Used in this Manual

- ❑ Screenshots of the printer driver and the Epson Scan 2 (scanner driver) screens are from Windows 10 or Mac OS X v10.11.x. The content displayed on the screens varies depending on the model and situation.
- ❑ Illustrations of the printer used in this manual are examples only. Although there may be slight differences depending on the model, the method of operation is the same.
- ❑ Some of the menu items on the LCD screen vary depending on the model and settings.

Operating System References

Windows

In this manual, terms such as "Windows 10", "Windows 8.1", "Windows 8", "Windows 7", "Windows Vista", "Windows XP", "Windows Server 2012 R2", "Windows Server 2012", "Windows Server 2008 R2", "Windows Server 2008", "Windows Server 2003 R2", and "Windows Server 2003" refer to the following operating systems. Additionally, "Windows" is used to refer to all versions.

- ❑ Microsoft® Windows® 10 operating system
- ❑ Microsoft® Windows® 8.1 operating system
- ❑ Microsoft® Windows® 8 operating system
- ❑ Microsoft® Windows® 7 operating system
- ❑ Microsoft® Windows Vista® operating system
- ❑ Microsoft® Windows® XP operating system
- ❑ Microsoft® Windows® XP Professional x64 Edition operating system
- ❑ Microsoft® Windows Server® 2012 R2 operating system
- ❑ Microsoft® Windows Server® 2012 operating system
- ❑ Microsoft® Windows Server® 2008 R2 operating system
- ❑ Microsoft® Windows Server® 2008 operating system
- ❑ Microsoft® Windows Server® 2003 R2 operating system
- ❑ Microsoft® Windows Server® 2003 operating system

Mac OS X

In this manual, "Mac OS X v10.11.x" refers to OS X El Capitan, "Mac OS X v10.10.x" refers to OS X Yosemite, "Mac OS X v10.9.x" refers to OS X Mavericks, and "Mac OS X v10.8.x" refers to OS X Mountain Lion. Additionally, "Mac OS X" is used to refer to "Mac OS X v10.11.x", "Mac OS X v10.10.x", "Mac OS X v10.9.x", "Mac OS X v10.8.x", "Mac OS X v10.7.x", and "Mac OS X v10.6.8".

Important Instructions

Safety Instructions



Read and follow these instructions to ensure safe use of this printer. Make sure you keep this manual for future reference. Also, be sure to follow all warnings and instructions marked on the printer.

- Some of the symbols used on your printer are to ensure safety and proper use of the printer. Visit the following Web site to learn the meaning of the symbols.
<http://support.epson.net/symbols>
- Use only the power cord supplied with the printer and do not use the cord with any other equipment. Use of other cords with this printer or the use of the supplied power cord with other equipment may result in fire or electric shock.
- Be sure your AC power cord meets the relevant local safety standard.
- Never disassemble, modify, or attempt to repair the power cord, plug, printer unit, scanner unit, or options by yourself, except as specifically explained in the printer's manuals.
- Unplug the printer and refer servicing to qualified service personnel under the following conditions:
The power cord or plug is damaged; liquid has entered the printer; the printer has been dropped or the casing damaged; the printer does not operate normally or exhibits a distinct change in performance. Do not adjust controls that are not covered by the operating instructions.
- Place the printer near a wall outlet where the plug can be easily unplugged.
- Do not place or store the printer outdoors, near excessive dirt or dust, water, heat sources, or in locations subject to shocks, vibrations, high temperature or humidity.
- Take care not to spill liquid on the printer and not to handle the printer with wet hands.
- Keep the printer at least 22 cm away from cardiac pacemakers. Radio waves from this printer may adversely affect the operation of cardiac pacemakers.
- If the LCD screen is damaged, contact your dealer. If the liquid crystal solution gets on your hands, wash them thoroughly with soap and water. If the liquid crystal solution gets into your eyes, flush them immediately with water. If discomfort or vision problems remain after a thorough flushing, see a doctor immediately.
- Avoid using a telephone during an electrical storm. There may be a remote risk of electric shock from lightning.
- Do not use a telephone to report a gas leak in the vicinity of the leak.
- Be careful when you handle used ink cartridges, as there may be some ink around the ink supply port.
 - If ink gets on your skin, wash the area thoroughly with soap and water.
 - If ink gets into your eyes, flush them immediately with water. If discomfort or vision problems continue after a thorough flushing, see a doctor immediately.
 - If ink gets into your mouth, see a doctor right away.
- Do not disassemble the ink cartridge and the maintenance box; otherwise ink may get into your eyes or on your skin.
- Do not shake ink cartridges too vigorously and do not drop them. Also, be careful not to squeeze them or tear their labels. Doing so may cause ink leakage.
- Keep ink cartridges and maintenance box out of the reach of children.

Printer Advisories and Warnings

Read and follow these instructions to avoid damaging the printer or your property. Make sure you keep this manual for future reference.

Advisories and Warnings for Setting Up/Using the Printer

- Do not block or cover the vents and openings in the printer.
- Use only the type of power source indicated on the printer's label.
- Avoid using outlets on the same circuit as photocopiers or air control systems that regularly switch on and off.
- Avoid electrical outlets controlled by wall switches or automatic timers.
- Keep the entire computer system away from potential sources of electromagnetic interference, such as loudspeakers or the base units of cordless telephones.
- The power-supply cords should be placed to avoid abrasions, cuts, fraying, crimping, and kinking. Do not place objects on top of the power-supply cords and do not allow the power-supply cords to be stepped on or run over. Be particularly careful to keep all the power-supply cords straight at the ends and the points where they enter and leave the transformer.
- If you use an extension cord with the printer, make sure that the total ampere rating of the devices plugged into the extension cord does not exceed the cord's ampere rating. Also, make sure that the total ampere rating of all devices plugged into the wall outlet does not exceed the wall outlet's ampere rating.
- If you plan to use the printer in Germany, the building installation must be protected by a 10 or 16 amp circuit breaker to provide adequate short-circuit protection and over-current protection for the printer.
- When connecting the printer to a computer or other device with a cable, ensure the correct orientation of the connectors. Each connector has only one correct orientation. Inserting a connector in the wrong orientation may damage both devices connected by the cable.
- Place the printer on a flat, stable surface that extends beyond the base of the printer in all directions. The printer will not operate properly if it is tilted at an angle.
- When storing or transporting the printer, avoid tilting it, placing it vertically, or turning it upside down; otherwise ink may leak.
- Allow space above the printer so that you can fully raise the document cover.
- Leave enough space in front of the printer for the paper to be fully ejected.
- Avoid places subject to rapid changes in temperature and humidity. Also, keep the printer away from direct sunlight, strong light, or heat sources.
- Do not insert objects through the slots in the printer.
- Do not put your hand inside the printer during printing.
- Do not touch the white flat cable inside the printer.
- Do not use aerosol products that contain flammable gases inside or around the printer. Doing so may cause fire.
- Do not move the print head by hand; otherwise, you may damage the printer.
- Be careful not to trap your fingers when closing the scanner unit.
- Do not press too hard on the scanner glass when placing the originals.
- Always turn the printer off using the  button. Do not unplug the printer or turn off the power at the outlet until the  light stops flashing.

Important Instructions

- ❑ Before transporting the printer, make sure that the print head is in the home (far right) position and the ink cartridges are in place.
- ❑ If you are not going to use the printer for a long period, be sure to unplug the power cord from the electrical outlet.

Advisories and Warnings for Using the Printer with a Wireless Connection

- ❑ Radio waves from this printer may negatively affect the operation of medical electronic equipment, causing them to malfunction. When using this printer inside medical facilities or near medical equipment, follow directions from the authorized personnel representing the medical facilities, and follow all posted warnings and directions on the medical equipment.
- ❑ Radio waves from this printer may negatively affect the operation of automatically controlled devices such as automatic doors or fire alarms, and could lead to accidents due to malfunction. When using this printer near automatically controlled devices, follow all posted warnings and directions on these devices.

Advisories and Warnings for Using the Touchscreen

- ❑ The LCD screen may contain a few small bright or dark spots, and because of its features it may have an uneven brightness. These are normal and do not indicate that it is damaged in any way.
- ❑ Only use a dry, soft cloth for cleaning. Do not use liquid or chemical cleaners.
- ❑ The exterior cover of the touchscreen could break if it receives a heavy impact. Contact your dealer if the panel surface chips or cracks, and do not touch or attempt to remove the broken pieces.
- ❑ Press the touchscreen gently with your finger. Do not press force or operate with your nails.
- ❑ Do not use sharp objects such as ball point pens or sharp pencils to perform operations.
- ❑ Condensation inside the touchscreen due to abrupt changes in temperature or humidity may cause performance to deteriorate.

Protecting Your Personal Information

When you give the printer to someone else or dispose of it, erase all the personal information stored in the printer's memory by selecting **Settings > Restore Default Settings > Clear All Data and Settings** on the control panel.

Printer Basics

Part Names and Functions

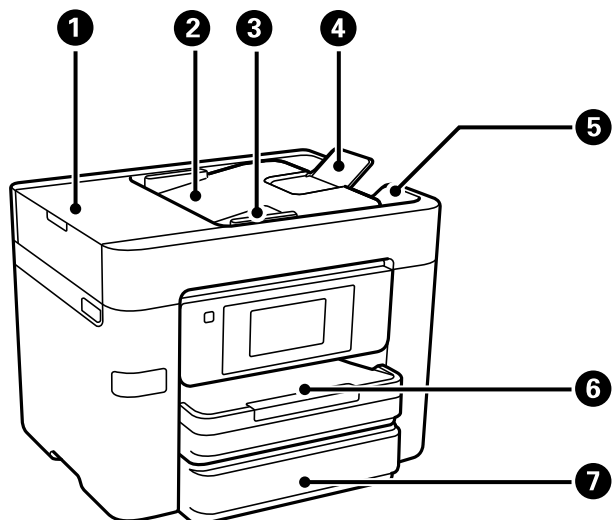

1	ADF (Automatic Document Feeder) cover	Open when removing jammed originals in the ADF.
2	ADF input tray	Feeds originals automatically.
3	ADF edge guide	Feeds originals straight into the printer. Slide to the edge of the originals.
4	ADF document support	Supports originals over A4 size .
5	ADF output tray	Holds originals ejected from the ADF.
6	Paper cassette 1 or Paper cassette	Loads paper.
7	Paper cassette 2	Available models only. Loads paper.

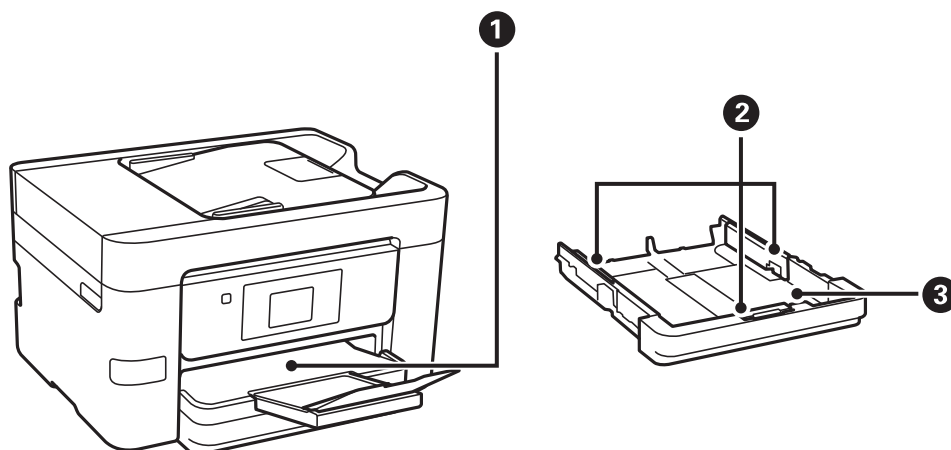

Printer Basics

❶	Output tray	Holds the ejected paper.
❷	Edge guides	Feeds the paper straight into the printer. Slide to the edges of the paper.
❸	Paper cassette	Loads paper.

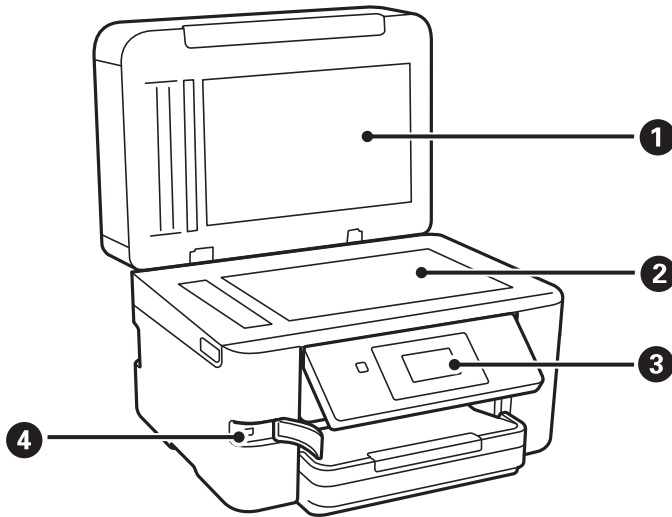

❶	Document cover	Blocks external light while scanning.
❷	Scanner glass	Place the originals.
❸	Control panel	Indicates the printer's status and allows you to make print settings.
❹	External interface USB port	Connects memory devices.

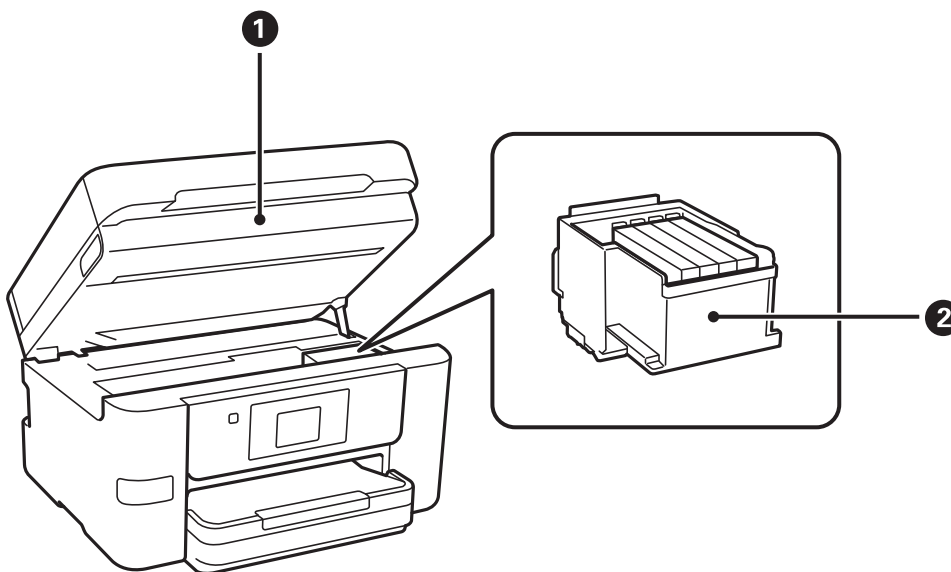

Printer Basics

<p>❶</p>	<p>Scanner unit</p>	<p>Scans placed originals. Open when replacing ink cartridges or removing jammed paper inside the printer.</p>
<p>❷</p>	<p>Ink cartridge holder</p>	<p>Install the ink cartridges. Ink is ejected from the print head nozzles underneath.</p>

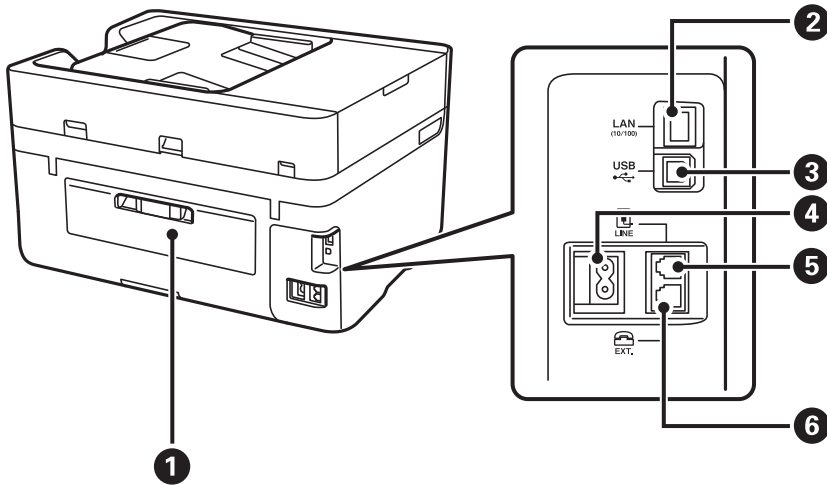

<p>❶</p>	<p>Rear cover</p>	<p>Remove when removing jammed paper.</p>
<p>❷</p>	<p>LAN port</p>	<p>Connects a LAN cable.</p>
<p>❸</p>	<p>USB port</p>	<p>Connects a USB cable.</p>
<p>❹</p>	<p>AC inlet</p>	<p>Connects the power cord.</p>
<p>❺</p>	<p>LINE port</p>	<p>Connects a phone line.</p>
<p>❻</p>	<p>EXT. port</p>	<p>Connects external phone devices.</p>

Control Panel

Buttons and Lights

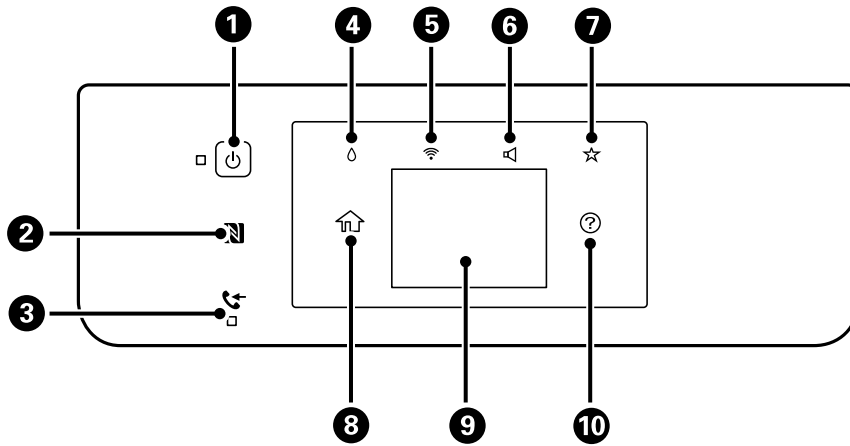

<p>1</p>	<p>Turns the printer on or off. Unplug the power cord when the power light is off.</p>
<p>2</p>	<p>Pass a smart device over this mark to print or scan from the smart device directly.</p>
<p>3</p>	<p>Turns on when received documents that have not yet been read, printed, or saved, are stored in the printer's memory.</p>
<p>4</p>	<p>Displays the Supply Status screen.</p> <div data-bbox="678 1265 1029 1534" style="border: 1px solid black; padding: 5px; margin: 10px auto; width: fit-content;"> <p>The screenshot shows a 'Supply Status' screen with a 'Close' button at the top left. Under 'Ink Level', there are four bars: BK (black), C (cyan), M (magenta), and Y (yellow). Below these is a 'Remaining capacity of Maintenance box' bar. At the bottom, there are two buttons: 'Replace Ink Cartridge(s)' and 'Print Supply Status Sheet'.</p> </div> <p>You can check the approximate ink levels and the approximate service life of the maintenance box. You can also replace the ink cartridges or print the Supply Status Sheet.</p>
<p>5</p>	<p>Displays the Network Connection Settings screen. Tap the icon to check and change the current settings .</p>
<p>6</p>	<p>Displays the Device Sound Settings screen. You can set Mute and Quiet Mode. You can also access the Sound menu from this screen.</p>
<p>7</p>	<p>Displays the list of settings registered to the Preset. You can also register new favorite settings.</p>
<p>8</p>	<p>Displays the home screen.</p>
<p>9</p>	<p>Displays menus and messages.</p>

Printer Basics

10	Displays the solutions when you are in trouble.
----	---

Related Information

- ➔ “Sound:” on page 153
- ➔ “Registering Your Favorite Settings as a Preset” on page 22

Basic Screen Configuration

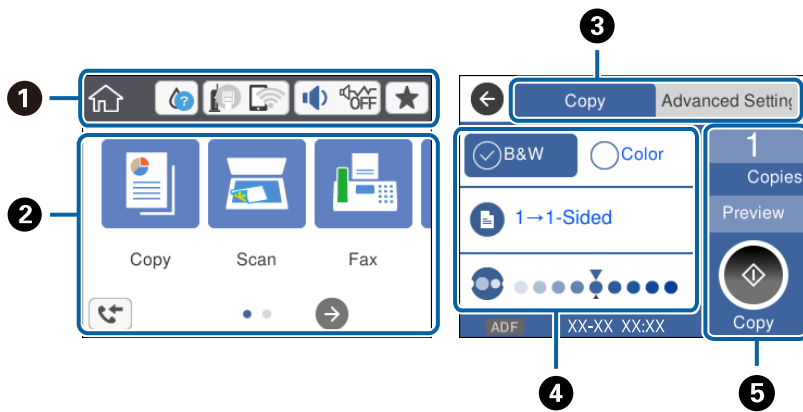

1	Indicates items that have been setup for the printer as icons. Tap to check the current settings or access each setting menu. This action bar is displayed on the home screen only.
2	Displays each mode.
3	Switch tabs.
4	Indicates the setting items. Tap each item to set or change the settings. The grayed out items are not available. Tap the item to check why they are unavailable.
5	Execute the current settings. Available functions vary depending on each mode. This action bar is displayed on the basic settings tab only.

Touch Screen Operations

The touchscreen is compatible with the following operations.





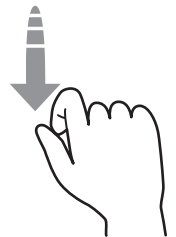
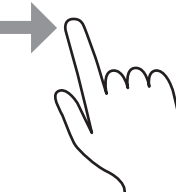

















Tap		Press or select the items or the icons.
-----	--	---

Printer Basics









Flick		Scroll the screen swiftly.
Slide		Hold and move the items around.

Icons displayed in the LCD Screen

The following icons are displayed on the LCD screen depending on the printer's status.

	<p>Indicates the status of consumables.</p> <p>Tap the icon to check the approximate ink levels. You can also replace the ink cartridges or print the Supply Status Sheet.</p>														
	<p>Indicates the network connection status.</p> <p>Tap the icon to check and change the current settings. This is the shortcut for the following menu. Settings > General Settings > Network Settings > Wi-Fi Setup</p> <table border="1" data-bbox="359 1187 1439 1776"> <tr> <td data-bbox="359 1187 430 1265">  </td> <td data-bbox="430 1187 1439 1265">The printer is not connected to a wired (Ethernet) network or unset it.</td> </tr> <tr> <td data-bbox="359 1265 430 1344">  </td> <td data-bbox="430 1265 1439 1344">The printer is connected to a wired (Ethernet) network.</td> </tr> <tr> <td data-bbox="359 1344 430 1422">  </td> <td data-bbox="430 1344 1439 1422">The printer is not connected to a wireless (Wi-Fi) network.</td> </tr> <tr> <td data-bbox="359 1422 430 1500">  </td> <td data-bbox="430 1422 1439 1500">The printer is searching for SSID, unset IP address, or having a problem with a wireless (Wi-Fi) network.</td> </tr> <tr> <td data-bbox="359 1500 430 1635">  </td> <td data-bbox="430 1500 1439 1635"> <p>The printer is connected to a wireless (Wi-Fi) network.</p> <p>The number of bars indicates the signal strength of the connection. The more bars there are, the stronger the connection.</p> </td> </tr> <tr> <td data-bbox="359 1635 430 1713">  </td> <td data-bbox="430 1635 1439 1713">The printer is not connected to a wireless (Wi-Fi) network in Wi-Fi Direct (Simple AP) mode.</td> </tr> <tr> <td data-bbox="359 1713 430 1776">  </td> <td data-bbox="430 1713 1439 1776">The printer is connected to a wireless (Wi-Fi) network in Wi-Fi Direct (Simple AP) mode.</td> </tr> </table>		The printer is not connected to a wired (Ethernet) network or unset it.		The printer is connected to a wired (Ethernet) network.		The printer is not connected to a wireless (Wi-Fi) network.		The printer is searching for SSID, unset IP address, or having a problem with a wireless (Wi-Fi) network.		<p>The printer is connected to a wireless (Wi-Fi) network.</p> <p>The number of bars indicates the signal strength of the connection. The more bars there are, the stronger the connection.</p>		The printer is not connected to a wireless (Wi-Fi) network in Wi-Fi Direct (Simple AP) mode.		The printer is connected to a wireless (Wi-Fi) network in Wi-Fi Direct (Simple AP) mode.
	The printer is not connected to a wired (Ethernet) network or unset it.														
	The printer is connected to a wired (Ethernet) network.														
	The printer is not connected to a wireless (Wi-Fi) network.														
	The printer is searching for SSID, unset IP address, or having a problem with a wireless (Wi-Fi) network.														
	<p>The printer is connected to a wireless (Wi-Fi) network.</p> <p>The number of bars indicates the signal strength of the connection. The more bars there are, the stronger the connection.</p>														
	The printer is not connected to a wireless (Wi-Fi) network in Wi-Fi Direct (Simple AP) mode.														
	The printer is connected to a wireless (Wi-Fi) network in Wi-Fi Direct (Simple AP) mode.														

Printer Basics

	<p>Displays the Device Sound Settings screen. You can set Mute and Quiet Mode.</p> <p>You can also access the Sound menu from this screen. This is the shortcut for the following menu.</p> <p>Settings > General Settings > Basic Settings > Sound</p>
 	<p>Indicates whether or not Quiet Mode is set for the printer. When this feature is enabled, the noise made by printer operations is reduced, but print speed may slow down. However, noises may not be reduced depending on the selected paper type and print quality.</p>
	<p>Indicates that Mute is set for the printer.</p>
	<p>Displays the list of settings registered to the Preset.</p> <p>You can also register new favorite settings.</p>
	<p>Displays the Fax Data Information screen.</p>
	<p>Indicates that there is additional information. Tap the icon to displays the message.</p>
	<p>Indicates a problem with the items. Tap the icon to check how to solve the problem.</p>
	<p>Indicates that there is data that has not yet been read, printed, or saved. The number displayed indicates the number of data items.</p>

Related Information

- ➔ [“Sound:” on page 153](#)
- ➔ [“Registering Your Favorite Settings as a Preset” on page 22](#)

Entering Characters

You can enter characters and symbols by using on-screen keyboard when you register a contact, make network settings, and so on.

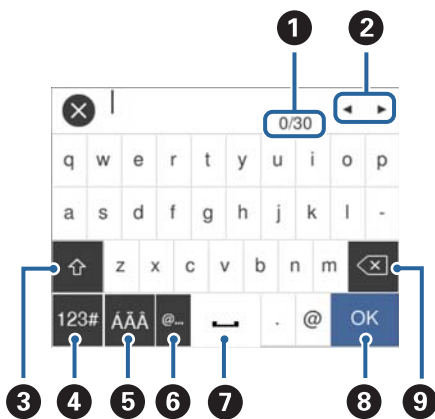



Note:

Available icons vary depending on the setting item.

<p>①</p>	<p>Indicates the character count.</p>
<p>②</p>	<p>Moves the cursor to the input position.</p>

Printer Basics

3	Switches between upper case and lower case or numbers and symbols.
4	Switches the character type.  : You can enter numbers and symbols.  : You can enter letters.  : You can select this to switch between special characters, numbers and symbols, or letters.
5	Switches the character type. You can enter alphanumerics and special characters such as umlauts and accents.
6	Enters frequently used email domain addresses or URLs by simply selecting the item.
7	Enters a space.
8	Enters character.
9	Deletes a character to the left.

Viewing Animations

You can view animations of operating instructions such as loading paper or removing jammed paper on the LCD screen.

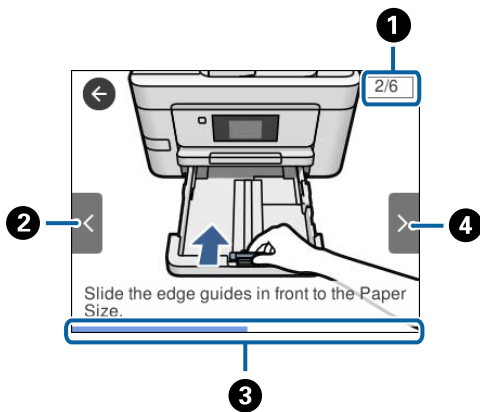

- Tap  on the right of the LCD screen: Displays the help screen. Tap **How To** and select the items that you want to view.
- Tap **How To** at the bottom of the operation screen: Displays the context-sensitive animation.



1	Indicates the total number of steps and the current step number. In the example above, it shows step 2 from 3 steps.
2	Returns to the previous step.
3	Indicates your progress through the current step. The animation repeats when the progress bar reaches the end.
4	Moves to next step.

Registering Your Favorite Settings as a Preset

You can register frequently used copy, fax, and scan settings as presets.

To register a preset, tap  from the home screen, tap **Add New**, and then select the feature for which you want to register a preset. Make the necessary settings, tap  and then enter a name for the preset.

To load a registered preset, select the preset from the list.

You can also register the current address and settings by tapping  from the printer's control panel on the screen of each feature.

To change the registered settings, change the settings on the screen for each feature and tap  from the printer's control panel. Tap **Register Current Settings** > **Add to Preset** and then select the target that you want to overwrite.

Menu Options for Preset

Tap  on the registered preset to display the details of the registered settings. You can change the registered name by tapping the name on the details screen.



Delete the registered preset.

Use This Setting:

Load the registered preset.

Network Settings

Network Connection Types

You can use the following connection methods.

Ethernet Connection

Connect the printer to a hub with an Ethernet cable.

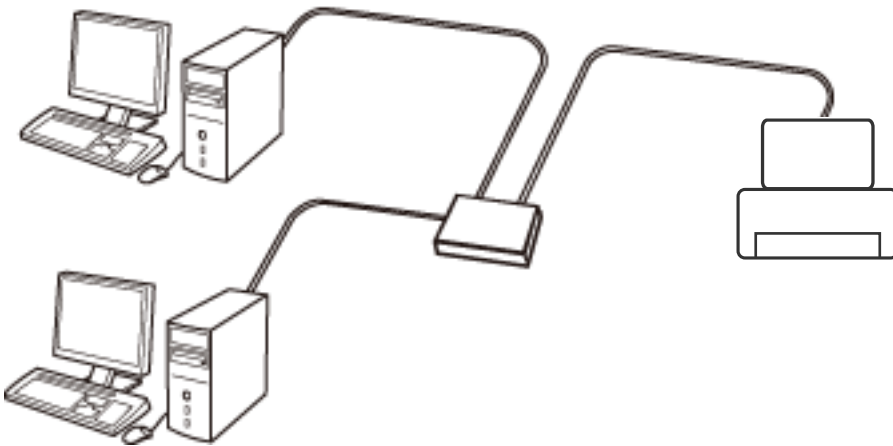

Related Information

➔ [“Making Advanced Network Settings” on page 31](#)

Wi-Fi Connection

Connect the printer and the computer or smart device to the access point. This is the typical connection method for home or office networks where computers are connected by Wi-Fi through the access point.

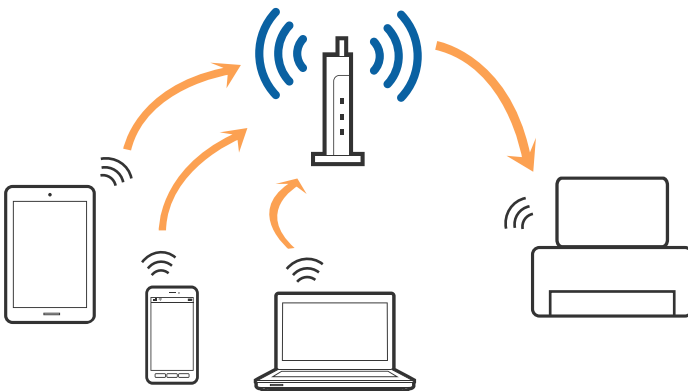

Related Information

- ➔ “Connecting to a Computer” on page 24
- ➔ “Connecting to a Smart Device” on page 26
- ➔ “Making Wi-Fi Settings from the Printer” on page 26

Wi-Fi Direct (Simple AP) Connection

Use this connection method when you are not using Wi-Fi at home or at the office, or when you want to connect the printer and the computer or smart device directly. In this mode, the printer acts as an access point and you can connect up to four devices to the printer without having to use a standard access point. However, devices directly connected to the printer cannot communicate with each other through the printer.

Note:

Wi-Fi Direct (Simple AP) connection is a connection method designed to replace Ad Hoc mode.

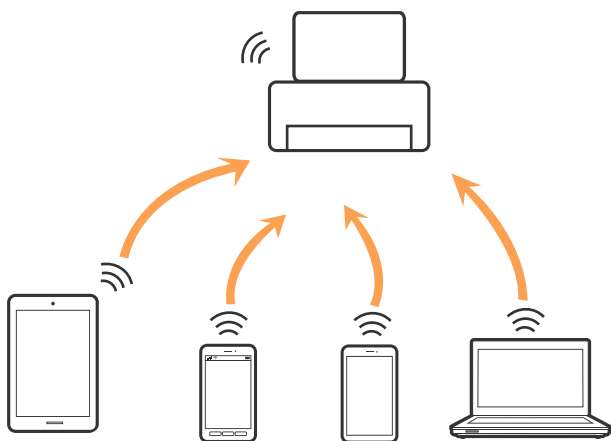

The printer can be connected by Wi-Fi or Ethernet, and Wi-Fi Direct (Simple AP) connection simultaneously. However, if you start a network connection in Wi-Fi Direct (Simple AP) connection when the printer is connected by Wi-Fi, the Wi-Fi is temporarily disconnected.

Related Information

- ➔ “Making Wi-Fi Direct (Simple AP) Connection Settings” on page 30

Connecting to a Computer

We recommend using the installer to connect the printer to a computer. You can run the installer using one of the following methods.

- Setting up from the website

Access the following website, and then enter the product name. Go to **Setup**, and then start setting up.

<http://epson.sn>

- Setting up using the software disc (only for the models that come with a software disc and users with computers with disc drives.)

Insert the software disc into the computer, and then follow the on-screen instructions.

Network Settings

Selecting the Connection Methods

Follow the on-screen instructions until the following screen is displayed, and then select the connection method of the printer to the computer.

Windows

Select the connection type and then click **Next**.

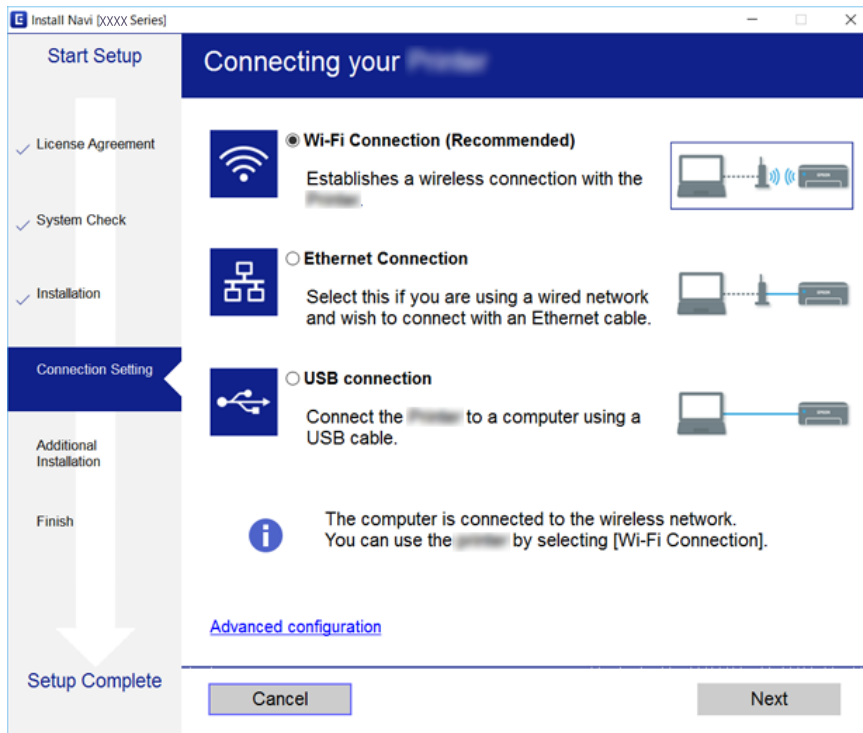

Network Settings

Mac OS X

Select the connection type.

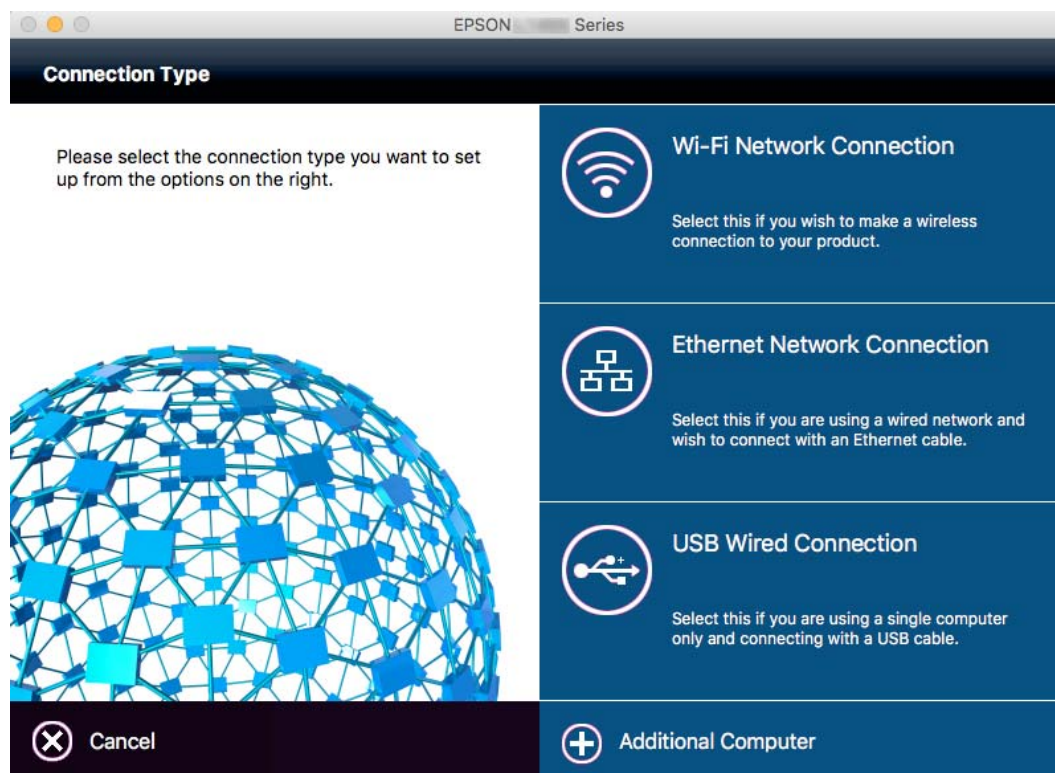

Follow the on-screen instructions. The necessary software is installed.

Connecting to a Smart Device

You can use the printer from a smart device when you connect the printer to the same Wi-Fi network (SSID) as the smart device. To use the printer from a smart device, set up from the following website. Access to the website from the smart device that you want to connect to the printer.

<http://epson.sn> > Setup

Note:

If you want to connect a computer and a smart device to the printer at the same time, we recommend connecting the computer first.

Making Wi-Fi Settings from the Printer

You can make network settings from the printer's control panel in several ways. Choose the connection method that matches the environment and conditions that you are using. If you know the information for the access point such as SSID and password, you can make settings manually. If the access point supports WPS, you can make settings by using push button setup.

After connecting the printer to the network, connect to the printer from the device that you want to use (computer, smart device, tablet, and so on.)

Network Settings

Related Information

- ➔ “Making Wi-Fi Settings Manually” on page 27
- ➔ “Making Wi-Fi Settings by Push Button Setup (WPS)” on page 28
- ➔ “Making Wi-Fi Settings by PIN Code Setup (WPS)” on page 29
- ➔ “Making Wi-Fi Direct (Simple AP) Connection Settings” on page 30

Making Wi-Fi Settings Manually

You can manually set up the information necessary to connect to an access point from the printer's control panel. To set up manually, you need the SSID and password for an access point.

Note:

If you are using an access point with its default settings, the SSID and password are on the label. If you do not know the SSID and password, contact the person who set up the access point, or see the documentation provided with the access point.

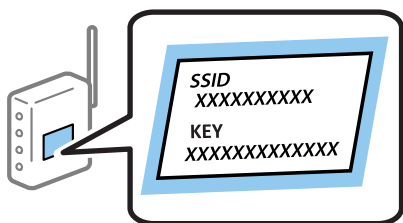

1. Tap  on the home screen.
2. Tap the **Wi-Fi(Recommended)** icon or the **Router** icon.
3. Tap **Start Setup**.

If the network connection is already set up, the connection details are displayed. Tap **Change to Wi-Fi connection**, or **Change Settings** to change the settings.

4. Tap **Wi-Fi Setup Wizard**.
5. Select the SSID for the access point.

Note:

- If the SSID you want to connect to is not displayed on the printer's control panel, tap **Search Again** to update the list. Still not displayed, tap **Enter Manually**, and then enter the SSID directly.
- If you do not know the SSID, check if it is written on the label of the access point. If you are using the access point with its default settings, use the SSID written on the label.

6. Tap the **Enter Password** field, and then enter the password.

Note:

- The password is case-sensitive.
- If you do not know the password, check if it is written on the label of the access point. If you are using the access point with its default settings, use the password written on the label. The password may also be called a "Key", a "Passphrase", and so on.
- If you do not know the password for the access point, see the documentation provided with the access point, or contact the person who set it up.

Network Settings

7. When you have setup finished, tap **Start Setup**.
8. Tap **OK** to finish.

Note:

If you fail to connect, load A4 size plain paper, and then tap **Print Check Report** to print a connection report.

9. Tap **Close** on the network connection settings screen.

Related Information

- ➔ [“Entering Characters” on page 20](#)
- ➔ [“Checking the Network Connection Status” on page 32](#)
- ➔ [“When You Cannot Make Network Settings” on page 180](#)

Making Wi-Fi Settings by Push Button Setup (WPS)

You can automatically set up a Wi-Fi network by pressing a button on the access point. If the following conditions are met, you can set up by using this method.

- The access point is compatible with WPS (Wi-Fi Protected Setup).
- The current Wi-Fi connection was established by pressing a button on the access point.

Note:

If you cannot find the button or you are setting up using the software, see the documentation provided with the access point.

1. Tap  on the home screen.
2. Tap the **Wi-Fi(Recommended)** icon or the **Router** icon.
3. Tap **Start Setup**.

If the network connection is already set up, the connection details are displayed. Tap **Change to Wi-Fi connection.** or **Change Settings** to change the settings.

4. Tap **Push Button Setup(WPS)**.
5. Hold down the [WPS] button on the access point until the security light flashes.



Network Settings

If you do not know where the [WPS] button is, or there are no buttons on the access point, see the documentation provided with your access point for details.

6. Tap **Start Setup**.

7. Tap **Close**.

The screen automatically closes after a specific length of time if you do not tap **Close**.

Note:

If connection fails, restart the access point, move it closer to the printer, and try again. If it still does not work, print a network connection report and check the solution.

8. Tap **Close** on the network connection settings screen.

Related Information

- ➔ [“Checking the Network Connection Status” on page 32](#)
- ➔ [“When You Cannot Make Network Settings” on page 180](#)

Making Wi-Fi Settings by PIN Code Setup (WPS)

You can automatically connect to an access point by using a PIN code. You can use this method to set up if an access point is capable of WPS (Wi-Fi Protected Setup). Use a computer to enter a PIN code into the access point.

1. Tap  on the home screen.

2. Tap the **Wi-Fi(Recommended)** icon or the **Router** icon.

3. Tap **Start Setup**.

If the network connection is already set up, the connection details are displayed. Tap **Change to Wi-Fi connection**, or **Change Settings** to change the settings.

4. Tap **Others > PIN Code Setup(WPS)**

5. Use your computer to enter the PIN code (an eight digit number) displayed on the printer's control panel into the access point within two minutes.

Note:

See the documentation provided with your access point for details on entering a PIN code.

6. Tap **Start Setup**.

7. Tap **Close**.

The screen automatically closes after a specific length of time if you do not tap **Close**.

Note:

If connection fails, restart the access point, move it closer to the printer, and try again. If it still does not work, print a connection report and check the solution.

8. Tap **Close** on the network connection settings screen.

Network Settings

Related Information

- ➔ “Checking the Network Connection Status” on page 32
- ➔ “When You Cannot Make Network Settings” on page 180

Making Wi-Fi Direct (Simple AP) Connection Settings

This method allows you to connect the printer directly to devices without an access point. The printer acts as an access point.

Important:

When you connect from a computer or smart device to the printer using the Wi-Fi Direct (Simple AP) connection, the printer is connected to the same Wi-Fi network (SSID) as the computer or smart device and the communication is established between them. Since the computer or smart device is automatically connected to the other connectable Wi-Fi network if the printer is turned off, it is not connected to the previous Wi-Fi network again if the printer is turned on. Connect to the printer's SSID for Wi-Fi Direct (Simple AP) connection from the computer or smart device again. If you do not want to connect every time you turn the printer on or off, we recommend using Wi-Fi network by connecting the printer to an access point.

1. Tap  on the home screen.
2. Tap the **Wi-Fi Direct** icon.
3. Tap **Start Setup**.
If you have made Wi-Fi settings, the detailed connection information is displayed. Go to step 5.
4. Tap **Start Setup**.
5. Check the SSID and password displayed on the printer's control panel. On the computer's network connection screen or the smart device's Wi-Fi screen, select the SSID shown on the printer's control panel to connect.

Note:

You can check the connection method on the Web site. To access the Web site, scan the QR code displayed on the printer's control panel using the smart device or enter the URL (<http://epson.sn>) on the computer, and then go to **Setup**.

6. Enter the password displayed on the printer's control panel on the computer or smart device.
7. After the connection is established, tap **OK** or **Close** on the printer's control panel.

Note:

You can also make Wi-Fi Direct (Simple AP) connection settings from a smart device. See *Tips* on the following Web site.

<http://epson.sn> > **Support**

Related Information

- ➔ “Checking the Network Connection Status” on page 32
- ➔ “When You Cannot Make Network Settings” on page 180

Making Advanced Network Settings

You can change the network device name, TCP/IP setup, proxy server and so on. Check your network environment before making changes.

1. Tap **Settings** on the home screen.
2. Tap **General Settings > Network Settings > Advanced**.
3. Tap the menu item for settings, and then select or specify the setting values.

Related Information

➔ [“Setting Items for Advanced Network Settings” on page 31](#)

Setting Items for Advanced Network Settings

Select the menu item for settings, and then select or specify the setting values.

Device Name

You can enter the following characters.

Character limits: 2 to 15 (you must enter at least 2 characters)

Usable characters: A to Z, a to z, 0 to 9, -.

Characters you cannot use at the top: 0 to 9, -.

Characters you cannot use at the bottom: -

TCP/IP

Auto

Select when you are using an access point at home or you are allowing the IP address to be acquired automatically by DHCP.

Manual

Select when you do not want the printer's IP address to be changed. Enter the addresses for IP Address, Subnet Mask, and Default Gateway, and make DNS Server settings according to your network environment.

Proxy Server

Do Not Use

Select when you are using the printer in a home network environment.

Use

Select when you are using a proxy server in your network environment and you want to set it to the printer. Enter the proxy server address and port number.

Email Server

Server Settings

You can select the server from Off, POP Before SmtP, or SMTP-AUTH.

Connection Check

You can check the connection for e-mail server. If an error occurs when performing **Connection Check**, see the explanation of the Connection Check message.

Network Settings

 IPv6 Address Enable

Select this when using an IPv6 address.

 Disable

Select this when using an IPv4 address.

 MS Network Sharing Enable

Use MS Network service.

 Disable

Disables the MS Network service.

 File Sharing

Enables or disables the file sharing function.

 Link Speed & Duplex

Select an appropriate Ethernet speed and duplex setting. If you select a setting other than Auto, make sure the setting corresponds to the settings on the hub you are using.

 Auto 10BASE-T Half Duplex 10BASE-T Full Duplex 100BASE-TX Half Duplex 100BASE-TX Full Duplex

Related Information

➔ [“Messages Displayed During Connection Check” on page 220](#)

Checking the Network Connection Status

You can check the network connection status in the following way.

Network Icon

You can check the network connection status and strength of the radio wave using the network icon on the printer's home screen.



Related Information

➔ [“Icons displayed in the LCD Screen” on page 19](#)

Checking Detailed Network Information from the Control Panel

When your printer is connected to the network, you can also view other network-related information by selecting the network menus you want to check.

1. Tap **Settings** on the home screen.
2. Tap **General Settings** > **Network Settings** > **Network Status**.
3. To check the information, select the menus that you want to check.
 - Wired LAN/Wi-Fi Status**
Displays the network information (device name, connection, signal strength, obtain IP address, and so on) for Ethernet or Wi-Fi connections.
 - Wi-Fi Direct Status**
Displays whether Wi-Fi Direct is enabled or disabled, and the SSID, password and so on for Wi-Fi Direct connections.
 - Email Server Status**
Displays the network information for email server.
 - Print Status Sheet**
Prints a network status sheet. The information for Ethernet, Wi-Fi, Wi-Fi Direct, and so on is printed on two or more pages.

Printing a Network Connection Report

You can print a network connection report to check the status between the printer and the access point.

1. Load papers.

Network Settings

2. Tap **Settings** on the home screen.
3. Tap **General Settings** > **Network Settings** > **Connection Check**.
The connection check starts.
4. Tap **Print Check Report**.
5. Tap **Print** to print the network connection report.
If an error has occurred, check the network connection report, and then follow the printed solutions.
6. Tap **Close**.
The screen automatically closes after a specific length of time if you do not tap **Close**.

Related Information

➔ [“Messages and Solutions on the Network Connection Report” on page 34](#)

Messages and Solutions on the Network Connection Report

Check the messages and error codes on the network connection report, and then follow the solutions.

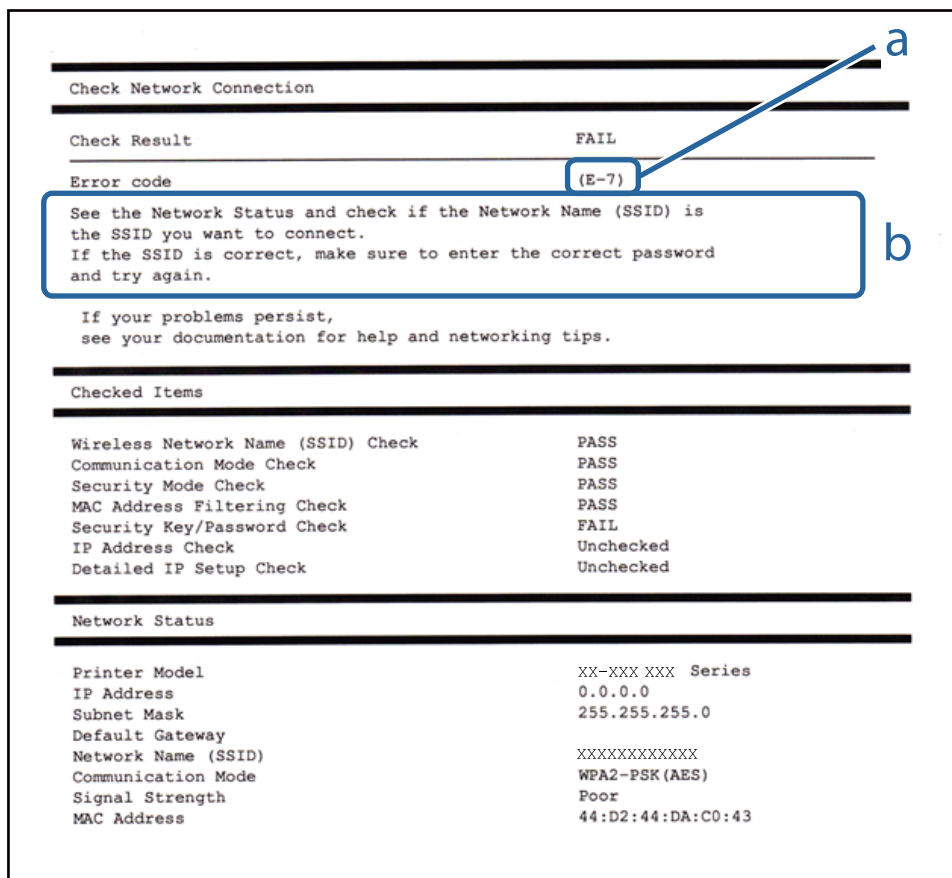

a. Error code

b. Messages on the Network Environment

Network Settings

a. Error code

Code	Solution
E-1	<ul style="list-style-type: none"> <input type="checkbox"/> Make sure that the Ethernet cable is connected to the printer, a hub, or other network devices. <input type="checkbox"/> Make sure that the hub or other network devices are turned on.
E-2 E-3 E-7	<ul style="list-style-type: none"> <input type="checkbox"/> Make sure that the access point is turned on. <input type="checkbox"/> Check that the computer or other devices are connected correctly to the access point. <input type="checkbox"/> Place the printer close to the access point. Remove any obstacles between them. <input type="checkbox"/> If you have entered the SSID manually, check if it is correct. Check the SSID from the Network Status part on the network connection report. <input type="checkbox"/> To establish a network using push button setup, check that the access point supports WPS. If it does not support WPS, you cannot establish a network using push button setup. <input type="checkbox"/> Check that only ASCII characters (alphanumeric characters and symbols) are used for the SSID. The printer cannot display an SSID which contains any characters other than ASCII characters. <input type="checkbox"/> Check the SSID and password before connecting to the access point. If you are using an access point with its default settings, the SSID and password are on the label. If you do not know the SSID and password, contact the person who set up the access point, or see the documentation provided with the access point. <input type="checkbox"/> When you want to connect to an SSID generated using the tethering function on a smart device, check the SSID and password in the documentation provided with the smart device. <input type="checkbox"/> If the Wi-Fi connection is suddenly disconnected, check the following. If any of these are applicable, reset the network settings using the installer. You can run it from the following website. http://epson.sn > Setup <ul style="list-style-type: none"> <input type="checkbox"/> Another smart device was added to the network using push button setup. <input type="checkbox"/> The Wi-Fi network was set up using any method other than push button setup.
E-5	<p>Make sure the access point's security type is set to one of the following. If it is not, change the security type on the access point, and then reset the printer's network settings.</p> <ul style="list-style-type: none"> <input type="checkbox"/> WEP-64 bit (40 bit) <input type="checkbox"/> WEP-128 bit (104 bit) <input type="checkbox"/> WPA PSK (TKIP/AES)* <input type="checkbox"/> WPA2 PSK (TKIP/AES)* <input type="checkbox"/> WPA (TKIP/AES) <input type="checkbox"/> WPA2 (TKIP/AES) <p>* : WPA PSK is also known as WPA Personal. WPA2 PSK is also known as WPA2 Personal.</p>
E-6	<ul style="list-style-type: none"> <input type="checkbox"/> Check if the MAC address filtering is disabled. If it is enabled, register the printer's MAC address so that it is not filtered. See the documentation provided with the access point for details. You can check the printer's MAC address from the Network Status part on the network connection report. <input type="checkbox"/> If the access point's shared authentication is enabled on the WEP security method, make sure the authentication key and index are correct.
E-8	<ul style="list-style-type: none"> <input type="checkbox"/> Enable DHCP on the access point when the printer's Obtain IP Address is set to Auto. <input type="checkbox"/> If the printer's Obtain IP Address is set to Manual, the IP address you manually set is out of range (for example: 0.0.0.0) and it is disabled. Set a valid IP address from printer's control panel or Web Config.

Network Settings

Code	Solution
E-9	<p>Check the following.</p> <ul style="list-style-type: none"> <input type="checkbox"/> Devices are turned on. <input type="checkbox"/> You can access the Internet and other computers or network devices on the same network from the devices you want to connect to the printer. <p>If it still does not work after checking the above, reset the network settings using the installer. You can run it from the following website.</p> <p>http://epson.sn > Setup</p>
E-10	<p>Check the following.</p> <ul style="list-style-type: none"> <input type="checkbox"/> Other devices on the network are turned on. <input type="checkbox"/> Network addresses (IP address, subnet mask, and default gateway) are correct if you have set the printer's Obtain IP Address to Manual. <p>Reset the network address if these are incorrect. You can check the IP address, subnet mask, and default gateway from the Network Status part on the network connection report.</p> <p>When DHCP is enabled, change the printer's Obtain IP Address to Auto. If you want to set the IP address manually, check the printer's IP address from the Network Status part on the network connection report, and then select Manual on the network settings screen. Set the subnet mask to [255.255.255.0].</p>
E-11	<p>Check the following.</p> <ul style="list-style-type: none"> <input type="checkbox"/> The default gateway address is correct when you set the printer's TCP/IP Setup to Manual. <input type="checkbox"/> The device that is set as the default gateway is turned on. <p>Set the correct default gateway address. You can check the default gateway address from the Network Status part on the network connection report.</p>
E-12	<p>Check the following.</p> <ul style="list-style-type: none"> <input type="checkbox"/> Other devices on the network are turned on. <input type="checkbox"/> The network addresses (IP address, subnet mask, and default gateway) are correct if you are entering them manually. <input type="checkbox"/> The network addresses for other devices (subnet mask and default gateway) are the same. <input type="checkbox"/> The IP address does not conflict with other devices. <p>If it still does not work after checking the above, try the following.</p> <ul style="list-style-type: none"> <input type="checkbox"/> Make network settings on the computer that is on the same network as the printer using the installer. You can run it from the following website. <p>http://epson.sn > Setup</p> <ul style="list-style-type: none"> <input type="checkbox"/> You can register several passwords on an access point that uses the WEP security type. If several passwords are registered, check if the first registered password is set on the printer.

Network Settings

Code	Solution
E-13	<p>Check the following.</p> <ul style="list-style-type: none"> <input type="checkbox"/> Network devices such as an access point, hub, and router are turned on. <input type="checkbox"/> The TCP/IP Setup for network devices has not been set up manually. (If the printer's TCP/IP Setup is set automatically while the TCP/IP Setup for other network devices is performed manually, the printer's network may differ from the network for other devices.) <p>If it still does not work after checking the above, try the following.</p> <ul style="list-style-type: none"> <input type="checkbox"/> Make network settings on the computer that is on the same network as the printer using the installer. You can run it from the following website. http://epson.sn > Setup <input type="checkbox"/> You can register several passwords on an access point that uses the WEP security type. If several passwords are registered, check if the first registered password is set on the printer.

b. Messages on the Network Environment

Message	Solution
*Multiple network names (SSID) that match your entered network name (SSID) have been detected. Confirm network name (SSID).	The same SSID may be set on several access points. Check the settings on the access points, and change the SSID.
The Wi-Fi environment needs to be improved. Turn the wireless router off and then turn it on. If the connection does not improve, see the documentation for the wireless router.	After moving the printer closer to the access point and removing any obstacles between them, turn the access point on. If it still does not connect, see the documentation supplied with the access point.
*No more devices can be connected. Disconnect one of the connected devices if you want to add another one.	You can simultaneously connect up to four computers and smart devices in Wi-Fi Direct (Simple AP) connection. To add another computer or smart device, disconnect one of the connected devices first.

Related Information

- ➔ [“Connecting to a Computer” on page 24](#)
- ➔ [“Web Config” on page 161](#)
- ➔ [“When You Cannot Make Network Settings” on page 180](#)

Printing a Network Status Sheet

You can check the detailed network information by printing it.

1. Load papers.
2. Tap **Settings** on the home screen.
3. Tap **General Settings** > **Network Settings** > **Network Status**.
4. Tap **Print Status Sheet**.

Network Settings

5. Check the message, and then tap **Print**.

The network status sheet is printed.

6. Tap **Close**.

The screen automatically closes after a specific length of time if you do not tap **Close**.

Replacing or Adding New Access Points

If the SSID changes due to the replacement of an access point, or an access point is added and a new network environment is established, re-set the Wi-Fi settings.

Related Information

➔ [“Changing the Connection Method to a Computer” on page 38](#)

Changing the Connection Method to a Computer

Using the installer and re-set up in a different connection method.

- Setting up from the website

Access the following website, and then enter the product name. Go to **Setup**, and then start setting up.

<http://epson.sn>

- Setting up using the software disc (only for the models that come with a software disc and users with computers with disc drives.)

Insert the software disc into the computer, and then follow the on-screen instructions.

Selecting Change the Connection Methods

Follow the on-screen instructions until the following screen is displayed.

Network Settings

Windows

Select **Change or re-set the connection method** on the Select Software Installation screen, and then click **Next**.

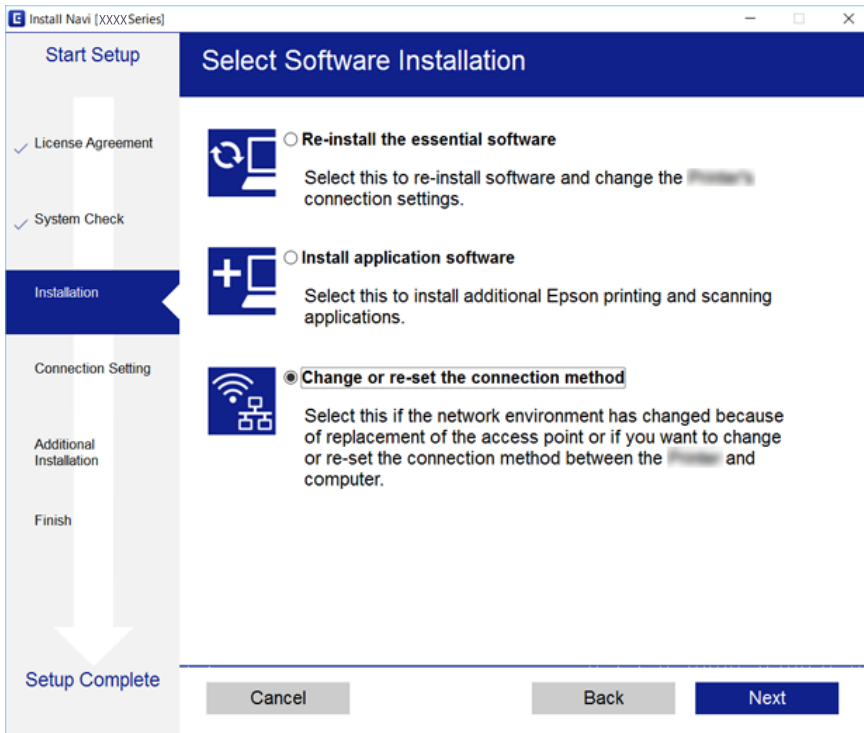

Mac OS X

Select how you want to connect the printer to your computer.

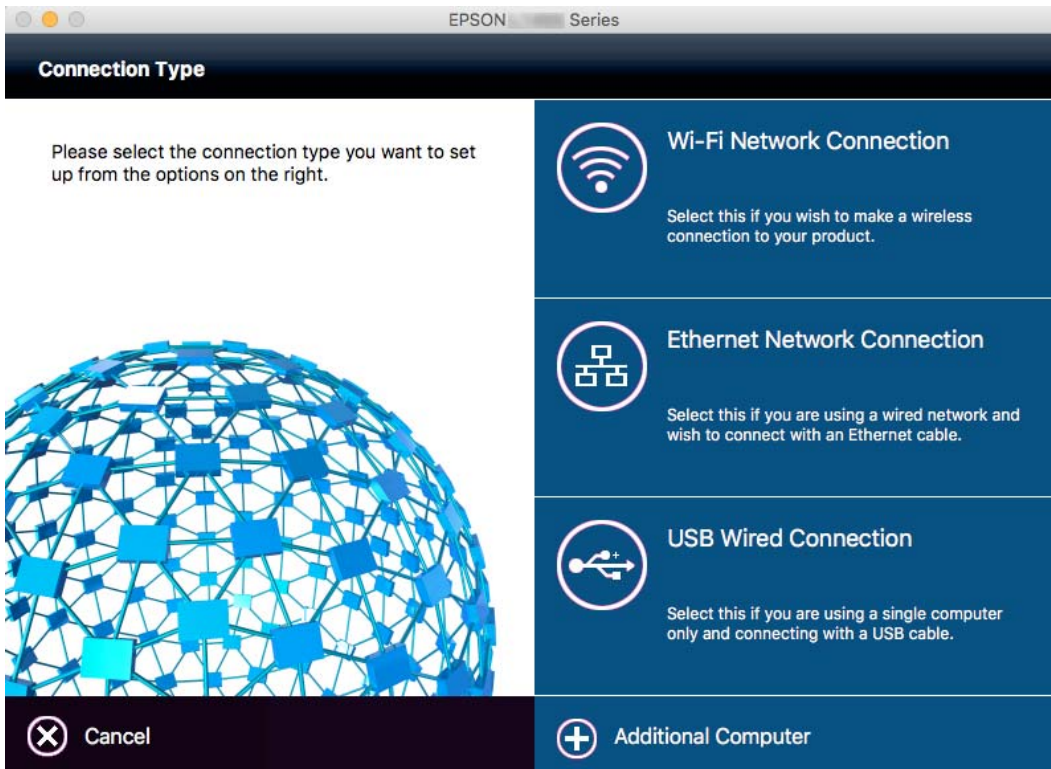

Changing the Network Connection to Ethernet from the Control Panel

Follow the steps below to change the network connection to Ethernet from Wi-Fi using the control panel.

1. Tap **Settings** on the home screen.
2. Tap **General Settings > Network Settings > Wired LAN Setup**.
3. Check the message, and then tap **Start Setup**.
4. Check the message, and then tap **OK**.
The screen automatically closes after a specific length of time if you do not tap **OK**.
5. Connect the printer to a router using an Ethernet cable.

Disabling Wi-Fi from the Control Panel

When Wi-Fi is disabled, the Wi-Fi connection is disconnected.

1. Tap  on the home screen.
2. Tap the **Wi-Fi(Recommended)** icon.
The network status is displayed.
3. Tap **Change Settings**.
4. Tap **Others > Disable Wi-Fi**.
5. Check the message, and then tap **Start Setup**.
6. When a completion message is displayed, tap **Close**.
The screen automatically closes after a specific length of time if you do not tap **Close**.

Disconnecting Wi-Fi Direct (Simple AP) Connection from the Control Panel

Note:

When Wi-Fi Direct (Simple AP) connection disabled, all computers and smart devices connected to the printer in Wi-Fi Direct (Simple AP) connection are disconnected. If you want to disconnect a specific device, disconnect from the device instead of the printer.

1. Tap  on the home screen.

Network Settings

2. Tap the **Wi-Fi Direct** icon.
The Wi-Fi Direct information is displayed.
3. Tap **Change Settings**.
4. Tap **Disable Wi-Fi Direct**.
5. Check the message, and then tap **Disable the settings**.
6. When a completion message is displayed, tap **Close**.
The screen automatically closes after a specific length of time if you do not tap **Close**.

Restoring the Network Settings from the Control Panel

You can restore all network settings to their defaults.

1. Tap **Settings** on the home screen.
2. Tap **Restore Default Settings > Network Settings**.
3. Check the message, and then tap **Yes**.
4. When a completion message is displayed, tap **Close**.
The screen automatically closes after a specific length of time if you do not tap **Close**.

Loading Paper

Paper Handling Precautions

- ❑ Read the instruction sheets supplied with the paper.
- ❑ Fan and align the edges of the paper before loading. Do not fan or curl photo paper. Doing so may damage the printable side.

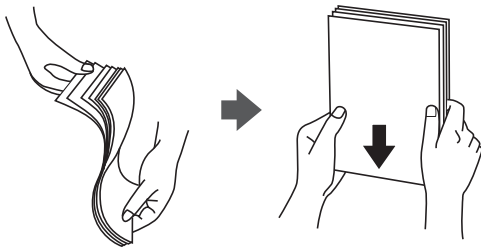

- ❑ If the paper is curled, flatten it or curl it slightly in the opposite direction before loading. Printing on curled paper may cause paper jams and smears on the printout.

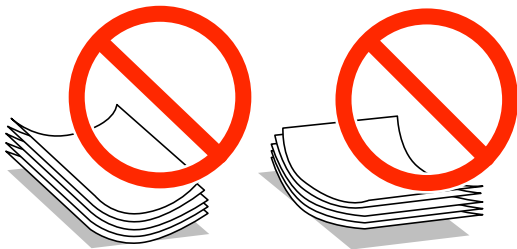

- ❑ Do not use paper that is wavy, torn, cut, folded, damp, too thick, too thin, or paper that has stickers stuck to it. Using these types of paper causes paper jams and smears on the printout.
- ❑ Fan and align the edges of the envelopes before loading. When the stacked envelopes are puffed up with air, press them down to flatten them before loading.

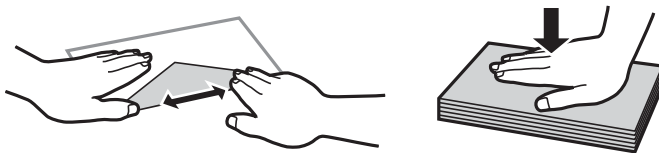

- ❑ Do not use envelopes that are curled or folded. Using these envelopes causes paper jams and smears on the printout.
- ❑ Do not use envelopes with adhesive surfaces on the flaps or window envelopes.
- ❑ Avoid using envelopes that are too thin, as they may curl during printing.

Related Information

- ➔ [“Printer Specifications” on page 205](#)

Available Paper and Capacities

Epson recommends using genuine Epson paper to ensure high-quality printouts.

Genuine Epson Paper

Media Name	Size	Loading Capacity (Sheets)		2-Sided Printing	Borderless Printing
		Paper Cassette or Paper Cassette 1	Paper Cassette 2(Available models only)		
Epson Bright White Ink Jet Paper	A4	200	200	Auto, Manual*1	-
Epson Ultra Glossy Photo Paper	A4, 13×18 cm (5×7 in.), 10×15 cm (4×6 in.)	20*2	-	-	✓
Epson Premium Glossy Photo Paper	A4, 13×18 cm (5×7 in.), 16:9 wide size (102×181 mm), 10×15 cm (4×6 in.)	20*2	-	-	✓
Epson Premium Semigloss Photo Paper	A4, 10×15 cm (4×6 in.)	20*2	-	-	✓
Epson Photo Paper Glossy	A4, 13×18 cm (5×7 in.), 10×15 cm (4×6 in.)	20*2	-	-	✓
Epson Matte Paper-Heavyweight	A4	20	-	-	✓
Epson Photo Quality Ink Jet Paper	A4	80	-	-	✓

*1 You can load up to 30 sheets for paper with one side already printed.

*2 Load one sheet of paper at a time if the paper does not feed correctly or if the printout has uneven colors or smears.

Note:

- ❑ The availability of paper varies by location. For the latest information on paper available in your area, contact Epson support.
- ❑ When printing on genuine Epson paper at a user defined size, only **Standard** or **Normal** print quality settings are available. Although some printer drivers allow you to select a better print quality, the printouts are printed using **Standard** or **Normal**.

Loading Paper

Commercially Available Paper

Media Name	Size	Loading Capacity (Sheets or Envelopes)		2-Sided Printing	Borderless Printing
		Paper Cassette or Paper Cassette 1	Paper Cassette 2(Available models only)		
High quality plain paper	Letter ^{*3} , A4, Executive ^{*3} , B5	Up to the line indicated by the triangle symbol on the edge guide.		Auto, Manual ^{*1}	-
Plain paper Copy paper Letterhead Recycled paper Color paper Preprinted paper	A5, Half letter ^{*3} , A6, B6 ^{*3}	Up to the line indicated by the triangle symbol on the edge guide.	-	Manual ^{*1}	-
	Legal ^{*3}	30	30	Manual ^{*2}	-
	User Defined (mm) ^{*3} 89×127 to 182×257	1	-	Manual	-
	User Defined (mm) ^{*3} 182×257 to 215.9×297	1	1	Auto, Manual	-
	User Defined (mm) ^{*3} 215.9×297 to 215.9×1200	1	1	Manual	-
Envelope	Envelope #10, Envelope DL, Envelope C6	10	-	-	-

*1 You can load up to 30 sheets for paper with one side already printed.

*2 You can load up to 1 sheet for paper with one side already printed.

*3 Only printing from computer or smart device is available.

Related Information

- ➔ [“Part Names and Functions” on page 14](#)
- ➔ [“Technical Support Web Site” on page 222](#)

List of Paper Type

To obtain optimum printing results, select the paper type that suits the paper.

Loading Paper

Media Name	Media Type	
	Control Panel	Printer Driver
Copy paper, Plain paper Epson Bright White Ink Jet Paper	plain papers	plain papers
Letterhead	Letterhead	Letterhead
Recycled paper	Recycled	Recycled
Colored paper	Color	Color
Preprinted paper	Preprinted	Preprinted
High quality plain paper	High Quality Plain Paper	High quality plain paper
Epson Ultra Glossy Photo Paper	Ultra Glossy	Epson Ultra Glossy
Epson Premium Glossy Photo Paper	Prem. Glossy	Epson Premium Glossy
Epson Premium Semigloss Photo Paper	Prem. Semigloss	Epson Premium Semigloss
Epson Photo Paper Glossy	Glossy	Photo Paper Glossy
Epson Matte Paper-Heavyweight Epson Photo Quality Ink Jet Paper	Matte	Epson Matte
Envelope	Envelope	Envelope

Loading Paper in the Paper Cassette

1. Check that the printer is not operating, and then pull out the paper cassette.

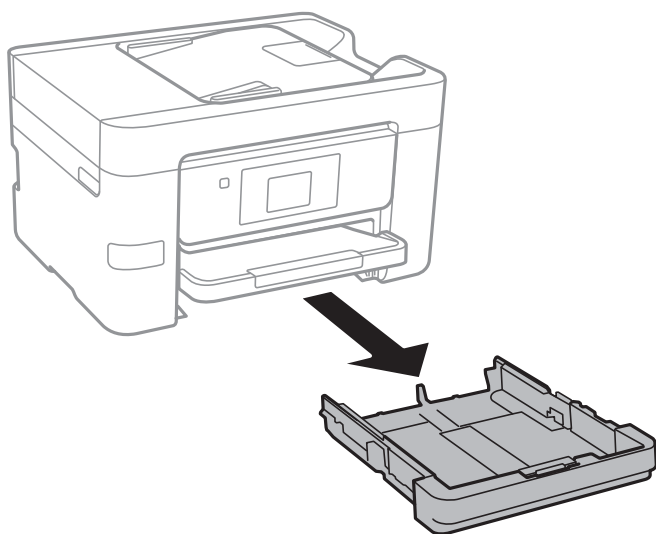

Loading Paper

- Slide the edge guides to their maximum position.

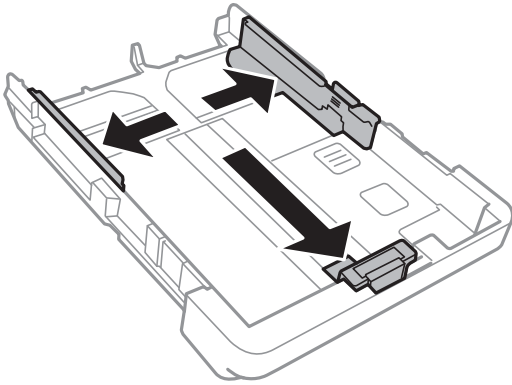

Note:

When using paper larger than A4 size, extend the paper cassette.

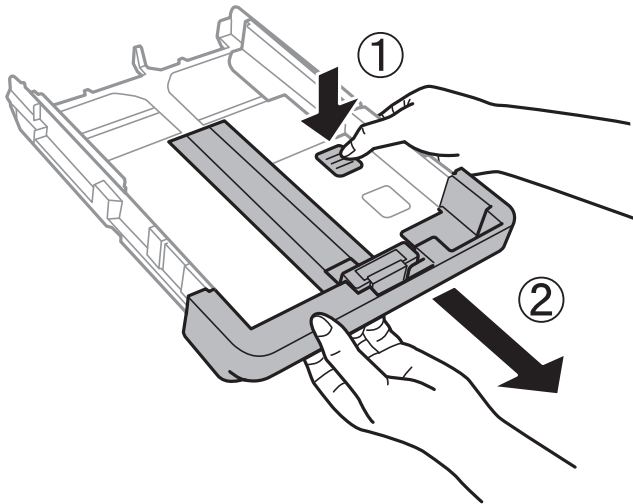

- Slide the front edge guide to the paper size you want to use.

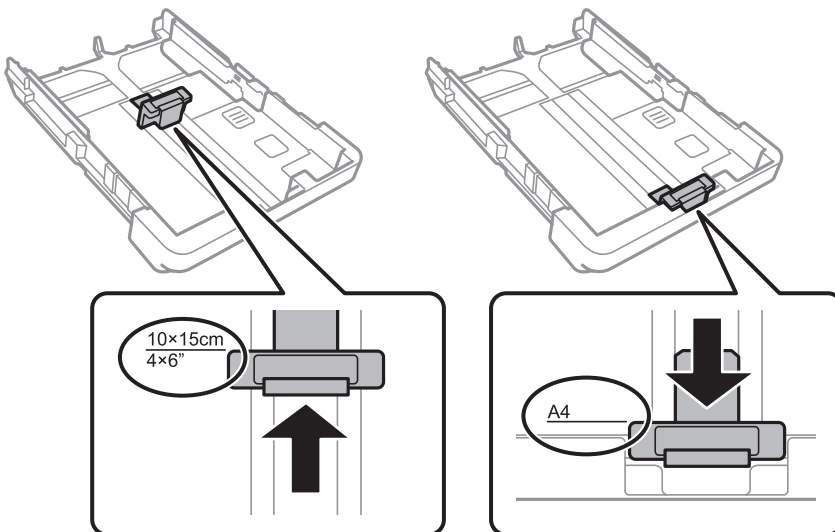

Loading Paper

4. With the printable side facing down, load paper against the front edge guide.

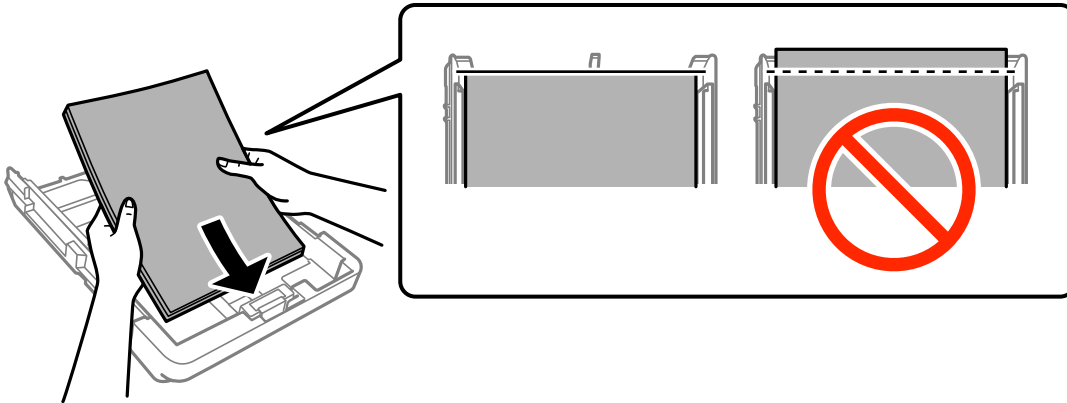

! Important:

- ❑ Make sure the paper does not extend beyond the triangle symbol at the end of the paper cassette.
- ❑ Do not load more than the maximum number of sheets specified for the paper. For plain paper, do not load above the line indicated by the triangle symbol on the edge guide.

❑ Envelopes

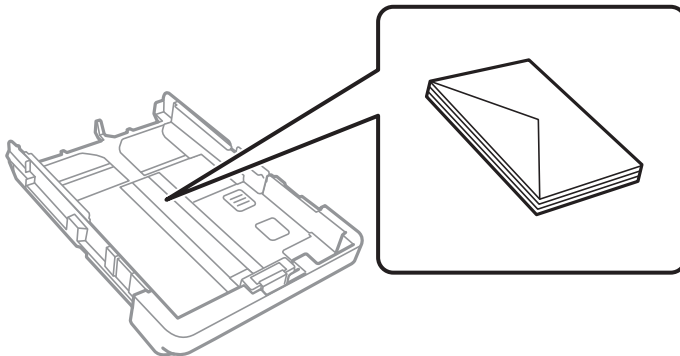

❑ Pre-punched paper

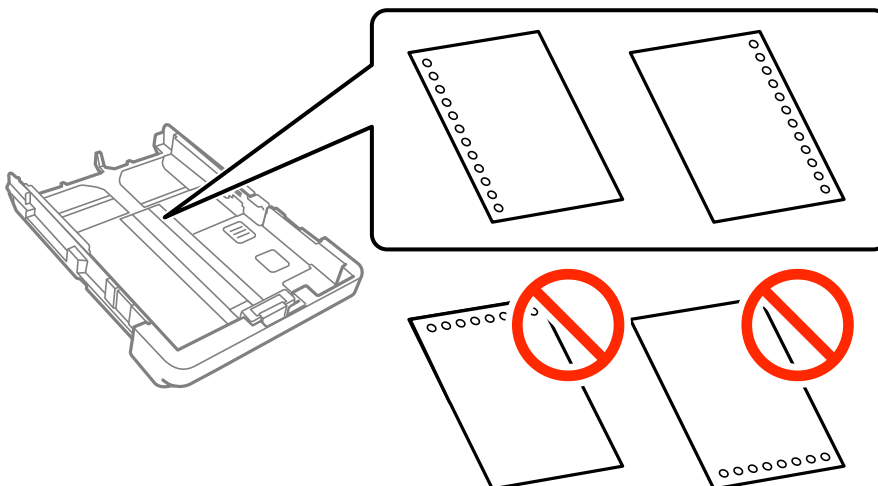

Loading Paper

Note:

- ❑ Load a single sheet of defined size plain paper with binding holes at the left or right.
- ❑ Adjust the print position of your file to avoid printing over the holes.
- ❑ Automatic 2-sided printing is not available for pre-punched paper.

5. Slide the side edge guides to the edges of the paper.

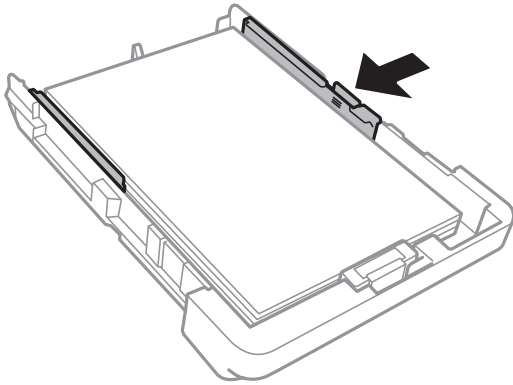

6. Insert the paper cassette all the way.
7. On the control panel, set the size and type of the paper you loaded in the paper cassette. If your paper size is not displayed, select **User-Defined**.

Note:

You can also display the paper size and paper type settings screen by tapping **Settings > General Settings > Printer Settings > Paper Source Settings > Paper Setting**.

8. Slide out the output tray.

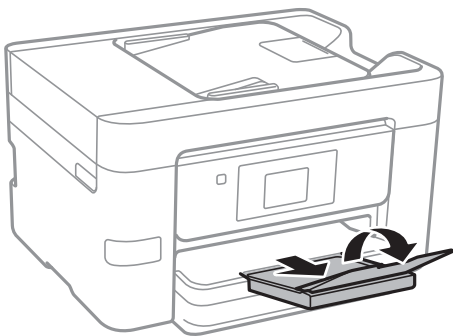

Related Information

- ➔ [“Paper Handling Precautions” on page 42](#)
- ➔ [“Available Paper and Capacities” on page 43](#)

Placing Originals

Place originals on the scanner glass or the ADF. Use the scanner glass for originals that the ADF does not support. You can scan multiple originals at the same time with the ADF.

Available Originals for the ADF

Available Paper Sizes	A4, Letter, Legal
Paper Type	Plain paper
Paper Thickness (Weight of Paper)	64 to 95 g/m ²
Loading Capacity	A4, Letter: 35 sheets or 3.85 mm Legal: 10 sheets

Even when the original meets the specifications for media that can be placed in the ADF, it may not feed from the ADF or the scan quality may decline depending on the paper properties or quality.



Important:

Do not feed photographs or valuable original artwork into the ADF. Misfeeding may wrinkle or damage the original. Scan these documents on the scanner glass instead.

To prevent paper jams, avoid placing the following originals in the ADF. For these types, use the scanner glass.

- Originals that are torn, folded, wrinkled, deteriorated, or curled
- Originals with binder holes
- Originals held together with tape, staples, paper clips etc.
- Originals that have stickers or labels stuck to them
- Originals that are cut irregularly or not right angled
- Originals that are bound
- OHPs, thermal transfer paper, or carbon backs

Placing Originals on the ADF

1. Align the edges of the originals.

Placing Originals

- Slide the ADF edge guide.

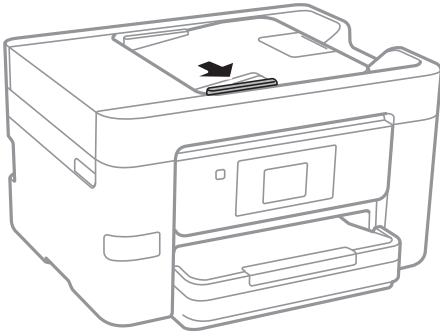

- Place the originals face up in the ADF.

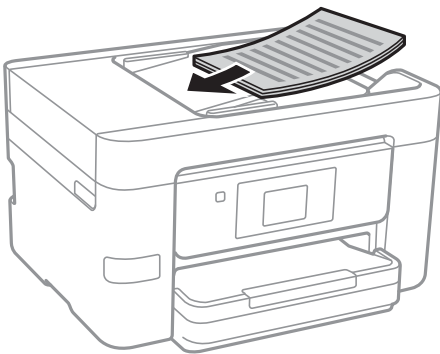

! *Important:*

- ❑ *Do not load originals above the line indicated by the triangle symbol on the ADF.*

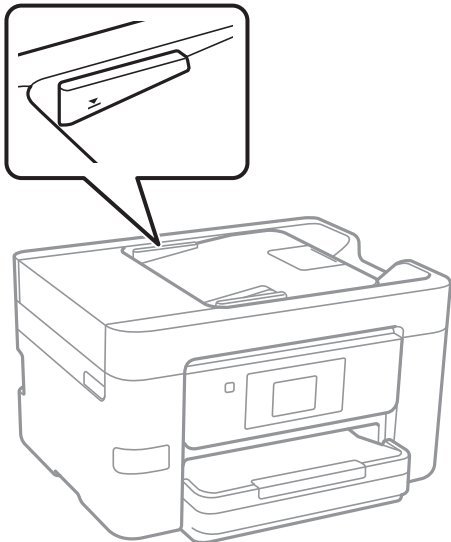

- ❑ *Do not add originals while scanning.*
- ❑ *When placing originals larger than A4 size, open the ADF document support.*

Placing Originals

- Slide the ADF edge guide to the edge of the originals.

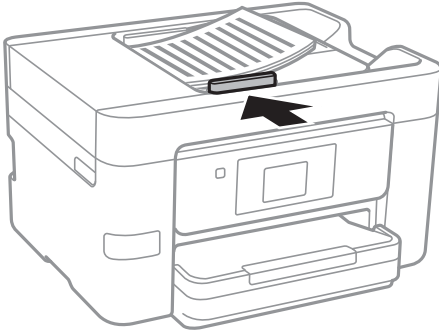

Related Information

- ➔ [“Available Originals for the ADF” on page 49](#)

Placing Originals on the ADF for 2-up Copying

Place the originals in the direction shown in the illustration, and then select the orientation setting.

- ❑ Placing the originals in the up direction: Select **Up Direction** on the control panel as described below.

Copy > Advanced Settings > Orientation (Original) > Up Direction

Place the originals on the ADF in the direction of the arrow.

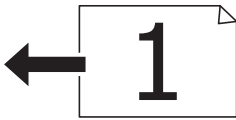

- ❑ Placing the originals in the left direction: Select **Left Direction** on the control panel as described below.

Copy > Advanced Settings > Orientation (Original) > Left Direction

Place the originals on the ADF in the direction of the arrow.



Placing Originals on the Scanner Glass

Caution:

Be careful not to trap your hand or fingers when opening or closing the document cover. Otherwise you may be injured.

Important:

When placing bulky originals such as books, prevent exterior light from shining directly onto the scanner glass.

Placing Originals

1. Open the document cover.

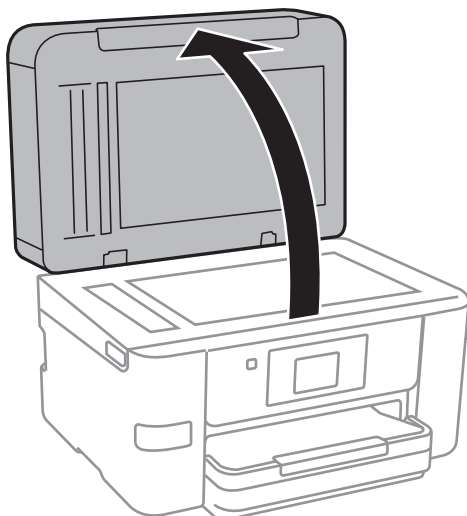

2. Remove any dust or stains on the scanner glass.
3. Place the original face-down and slide it to the corner mark.

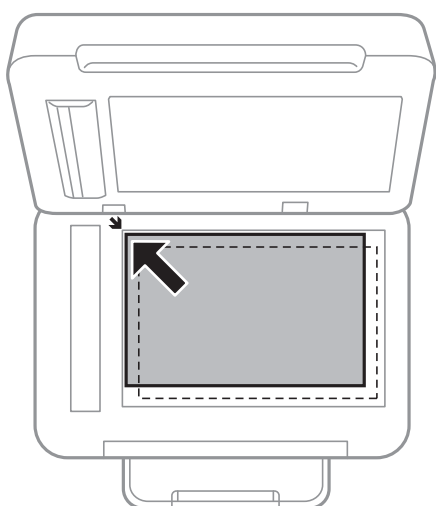

Note:

- ❑ A range of 1.5 mm from the edges of the scanner glass is not scanned.
- ❑ When originals are placed in the ADF and on the scanner glass, priority is given to the originals in the ADF.

4. Close the cover gently.



Important:

Do not apply too much force to the scanner glass or the document cover. Otherwise, they may be damaged.

5. Remove the originals after scanning.

Note:

If you leave the originals on the scanner glass for a long time, they may stick to the surface of the glass.

Managing Contacts

Registering a contacts list allows you to easily enter destinations. You can register up to 100 entries, and you can use the contacts list when you enter a fax number, enter a destination for attaching a scanned image to an email, and saving a scanned image to a network folder.

Registering or Editing Contacts

Note:

Before registering contacts, make sure you have also configured the email server settings to use the email address.

1. Enter the menu to which you want to register contacts.
 - Fax: Tap **Fax** on the home screen.
 - Email: Tap **Scan** on the home screen > **Email**.
 - Network Folder/FTP: Tap **Scan** on the home screen > **Network Folder/FTP**.
2. Tap **Contacts**.
3. Do one of the following.
 - To register a new contact, tap **Add Entry**.
 - To edit a contact, tap **>** on the target contact, and then tap **Edit**.
 - To delete a contact, tap **>** on the target contact, and then tap **Delete**, and then tap **Yes**. You do not have to perform following procedures.
4. Tap **Add Contact**.

If you want to register a contact of **Network Folder/FTP**, or to edit a contact, skip this procedure.
5. Make the necessary settings.

Note:

*When entering a fax number, enter an external access code at the beginning of the fax number if your phone system is PBX and you need the access code to get an outside line. If the access code has been set in the **Line Type** setting, enter a hash (#) instead of the actual access code. To add a pause (pause for three seconds) during dialing, enter a hyphen (-).*

6. Tap **OK**.

Registering or Editing Grouped Contacts

Adding contacts to a group allows you to send a fax or send a scanned image by an email to multiple destinations at the same time.

1. Enter the menu to which you want to register grouped contacts.
 - Fax: Tap **Fax** on the home screen.
 - Email: Tap **Scan** on the home screen > **Email**.

Managing Contacts

2. Tap **Contacts**.
3. Do one of the following.
 - To register a new grouped contacts, tap **Add Entry** and then tap **Add Group**.
 - To edit a grouped contacts, tap **>** on the target grouped contacts, and then tap **Edit**.
 - To delete a grouped contacts, tap **>** on the target grouped contacts and then tap **Delete**, and then tap **Yes**.
You do not have to perform following procedures.
4. Enter or edit the **Group Name** and the **Index Word**, and then tap **Contact(s) Added to the Group (Required)**.
5. Select the contacts that you want to register in the group, and then tap **Close**.

Note:

 - You can register up to 99 contacts.
 - To deselect a contact, tap it again.
6. Tap **OK**.

Register Contacts on a Computer

Using Web Config, you can create a contact list on your computer and import it to the printer.

1. Access Web Config and select **Contacts**.
2. Select the number that you want to register, and then click **Edit**.
3. Enter **Name** and **Index Word**.
4. Select the destination type as the **Type** option.

Note:

You cannot change the **Type** option after registration is complete. If you want to change the type, delete the destination and then register again.

5. Enter a value for each item, and then click **Apply**.

Related Information

- ➔ [“Web Config” on page 161](#)
- ➔ [“Running Web Config on a Web Browser” on page 162](#)

Destination Setting Items

Items	Settings and Explanation
Common Settings	
Name	Enter a name displayed in the contacts in 30 characters or less in Unicode (UTF-8). If you do not specify this, leave it blank.

Managing Contacts

Items	Settings and Explanation
Index Word	Enter words to search in 30 characters or less in Unicode (UTF-8). If you do not specify this, leave it blank.
Type	Select the type of the address that you want to register.
Assign to Frequent Use	Select to set the registered address as a frequently used address. When setting as a frequently used address, it is displayed on the top screen of fax and scan, and you can specify the destination without displaying the contacts.
Fax	
Fax Number	Enter between 1 and 64 characters using 0-9 - * # and space.
Fax Speed	Select a communication speed for a destination.
Email	
Email Address	Enter the email address between 1 and 255 characters.
Network Folder (SMB)	
Save to	Enter the location where the target folder is located between 1 and 253 characters in Unicode (UTF-8), omitting "\".
User Name	Enter a user name to access a network folder in 30 characters or less in Unicode (UTF-8). However, avoid using control characters (0x00 to 0x1f, 0x7F).
Password	Enter a password to access a network folder in 20 characters or less in Unicode (UTF-8). However, avoid using control characters (0x00 to 0x1f, 0x7F).
FTP	
Save to	Enter the server name between 1 and 253 characters in ASCII (0x20-0x7E), omitting "ftp://".
User Name	Enter a user name to access an FTP server in 30 characters or less in Unicode (UTF-8). However, avoid using control characters (0x00 to 0x1f, 0x7F). If the server allows anonymous connections, enter a user name such as Anonymous and FTP. If you do not specify this, leave it blank.
Password	Enter a password to access to an FTP server within 20 characters or less in Unicode (UTF-8). However, avoid using control characters (0x00 to 0x1f, 0x7F). If you do not specify this, leave it blank.
Connection Mode	Select the connection mode from the menu. If a firewall is set between the printer and the FTP server, select Passive Mode .
Port Number	Enter the FTP server port number between 1 and 65535.

Registering Destinations as a Group

If the destination type is set to **Fax** or **Email**, you can register the destinations as a group.

1. Access Web Config and select **Contacts**.
2. Select the number that you want to register, and then click **Edit**.
3. Select a group from **Type**.

Managing Contacts

4. Click **Select** for **Contact(s) for Group**.
The available destinations are displayed.
5. Select the destination that you want to register to the group, and then click **Select**.
6. Enter a **Name** and **Index Word**.
7. Select whether or not you assign the registered group to the frequently used group.
Note:
Destinations can be registered to multiple groups.
8. Click **Apply**.

Exporting and Importing Contacts Using a Computer

You can export contacts stored in the printer to the computer using Web Config. You can also import the exported contacts to the other printers.

Contacts data may be lost due to a printer malfunction. We recommend that you make a backup of the data whenever you update the data. Epson shall not be responsible for the loss of any data, for backing up or recovering data and/or settings even during a warranty period.

Related Information

➔ [“Web Config” on page 161](#)

Export the Contacts

Export each setting for the printer.

1. Access Web Config, and then select **Export and Import Setting Value > Export**.
2. Select **Contacts**.
3. Enter a password to encrypt the exported file.
You need the password to import the file. Leave this blank if you do not want to encrypt the file.
4. Click **Export**.

Related Information

➔ [“Running Web Config on a Web Browser” on page 162](#)

Import the Contacts

Import the exported Web Config file to the printer.

1. Access Web Config, and then select **Export and Import Setting Value > Import**.

Managing Contacts

2. Select the exported file, and then enter the encrypted password.
3. Click **Next**.
4. Select **Contacts**, and then click **Next**.
5. Click **OK**.

Related Information

- ➔ [“Running Web Config on a Web Browser” on page 162](#)

Printing

Printing from the Control Panel

You can print data from an external USB device connected to your printer.

Printing JPEG Files from a Memory Device





Note:

If you have more than 999 images on your memory device, images are automatically divided into groups and the group selection screen is displayed. Images are sorted by the date they were taken.

1. Connect the memory device to the printer's external interface USB port.
2. Tap **Memory Device** on the home screen.
3. Tap **JPEG**.

The images on the memory device are displayed as thumbnails.

Tap  to change the **Display order** or make settings for **Select all photos**, **Cancel Image Selection**, and **Select Group**.



4. Tap the files you want to print.
Selected images have check marks and the number of prints (1 initially) on them.
To preview one image, tap **Single View**. You can set the number of prints for each image by tapping - or +. You can enlarge the image by tapping . Tap  or  to preview the previous or next image.
5. Tap **Print Settings**.
6. Set the items as necessary.
For more information on detailed settings, see the menus for Memory Device.
7. Tap **Preview and Print**.
8. Set the number of copies by tapping the value.
9. Tap  to start printing.
10. Remove the memory device from the printer.

Related Information

- ➔ [“Loading Paper in the Paper Cassette” on page 45](#)
- ➔ [“Part Names and Functions” on page 14](#)
- ➔ [“JPEG Settings” on page 59](#)

Printing

Printing TIFF Files from a Memory Device

1. Connect the memory device to the printer's external interface USB port.
2. Tap **Memory Device** on the home screen.
3. Tap **TIFF**.
The files on the memory device are displayed as a list.
To change the order of the files, tap .
4. Tap the file you want to print.
5. Tap **Settings and Print**.
6. Set the items as necessary.
For more information on detailed settings, see the menus for Memory Device.
7. Tap **To Check Printing**, and then check settings such as  (**Print Order**), and change them if necessary.
8. Set the number of prints by tapping the value.
9. Tap  to start printing.
10. Remove the memory device from the printer.

Related Information

- ➔ [“Loading Paper in the Paper Cassette” on page 45](#)
- ➔ [“Part Names and Functions” on page 14](#)
- ➔ [“TIFF Settings” on page 60](#)

Menu Options for Memory Device

Tap **Memory Device** on the printer's home screen to make various print settings for the file on the memory device.

JPEG Settings



(Select Photo Menu) :

Make settings for ordering, selecting, and deselecting image data.

Paper Setting:

Specify the paper source settings which you want to print on.

Color Mode:

Select a color setting whether you normally print in **B&W** or **Color**.

Printing

Layout:

Select how to layout the JPEG files. **Borderless** is for printing one file per sheet without margins around the edges. The image is enlarged a little to remove borders from the edges of the paper. **With Border** is for printing one file per sheet with margins around the edges. **20-up** is for printing 20 files on one sheet. **Index** is for making index printing with information.

Fit Frame:

Select **On** to crop the image to fit into the selected print layout automatically. If the aspect ratio of the image data and the paper size is different, the image is automatically enlarged or reduced so that the short sides match the short sides of the paper. The long side of the image is cropped if it extends beyond the long side of the paper. This feature may not work for panorama photos.

Quality:

Select **Best** for higher quality printing, but the printing speed may be slower.

Date:

Select the format of the date the photo was taken or saved. The date is not printed for some layouts.

Enhance:

Select this mode to improve the brightness, contrast, and saturation of the photo automatically. To turn off automatic improvement, select **Enhance Off**.

Fix Red-Eye:

Select **On** to automatically fix the red-eye effect in photos. Corrections are not applied to the original file, only to the printouts. Depending on the type of photo, parts of the image other than the eyes may be corrected.

Clear All Settings:

Resets all settings to their defaults.

TIFF Settings

You can make print settings for TIFF format files in you memory devices.



Changes the order of the files.



(Paper Setting):

Specify the paper source settings which you want to print on.

Layout:

Select how to layout the Multi-TIFF file. **Borderless** is for printing one page per sheet without margins around the edges. The image is enlarged a little to remove borders from the edges of the paper. **With Border** is for printing one page per sheet with margins around the edges. **20-up** is for printing 20 pages on one sheet. **Index** is for making index printing with information.

Printing

Fit Frame:

Select **On** to crop the photo to fit into the selected photo layout automatically. If the aspect ratio of the image data and the paper size is different, the image is automatically enlarged or reduced so that the short sides match the short sides of the paper. The long side of the image is cropped if it extends beyond the long side of the paper. This feature may not work for panorama photos.

Quality:

Select **Best** for higher quality printing, but the printing speed may be slower.

Date:

Select the format of the date the photo was taken or saved. The date is not printed for some layouts.

Clear All Settings:

Resets all settings to their defaults.



(Print Order):

Select the order for printing multi-page TIFF files.

Color Mode:

Select a color setting whether you normally print in **B&W** or **Color**.

Printing from a Computer

Printing Basics - Windows

Note:

- See the online help for explanations of the setting items. Right-click an item, and then click **Help**.
- Operations may differ depending on the application. See the application's help for details.

1. Load paper in the printer.
2. Open the file you want to print.
3. Select **Print** or **Print Setup** from the **File** menu.
4. Select your printer.

Printing

5. Select **Preferences** or **Properties** to access the printer driver window.

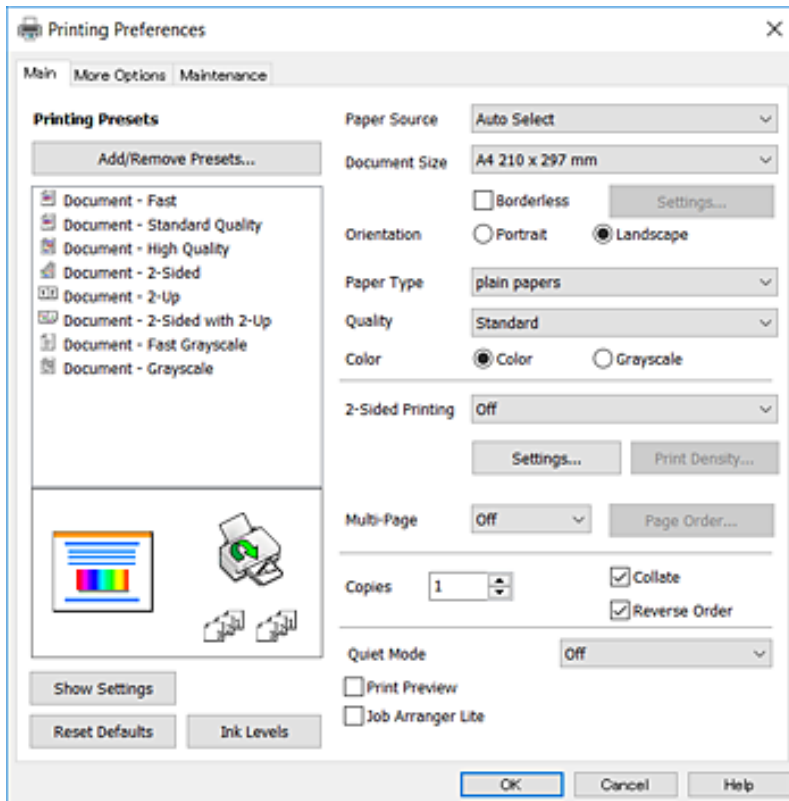

6. Make the following settings.
 - Paper Source: Select the paper source in which you loaded the paper. If the printer has only one paper source, this item is not displayed.
 - Document Size: Select the paper size you loaded in the printer.
 - Borderless: Select to print with no margins around the image.
 - Orientation: Select the orientation you set in the application.
 - Paper Type: Select the type of paper you loaded.
 - Quality: Select the print quality. Selecting **High** provides higher quality printing, but the printing speed may be slower.
 - Color: Select **Grayscale** when you want to print in black or shades of gray.

Note:

- If you are printing high-density data on plain paper, letterhead, or preprinted paper, select *Standard-Vivid* as the Quality setting to make your printout vivid.
 - When printing on envelopes, select *Landscape* as the **Orientation** setting.
7. Click **OK** to close the printer driver window.
 8. Click **Print**.

Related Information

- ➔ [“Available Paper and Capacities” on page 43](#)
- ➔ [“Loading Paper in the Paper Cassette” on page 45](#)

Printing

➔ “List of Paper Type” on page 44

Printing Basics - Mac OS X

Note:

Explanations in the section use TextEdit as an example. Operations and screens differ depending on the application. See the application's help for details.

1. Load paper in the printer.
2. Open the file you want to print.
3. Select **Print** from the **File** menu or another command to access the print dialog.

If necessary, click **Show Details** or ▼ to expand the print window.

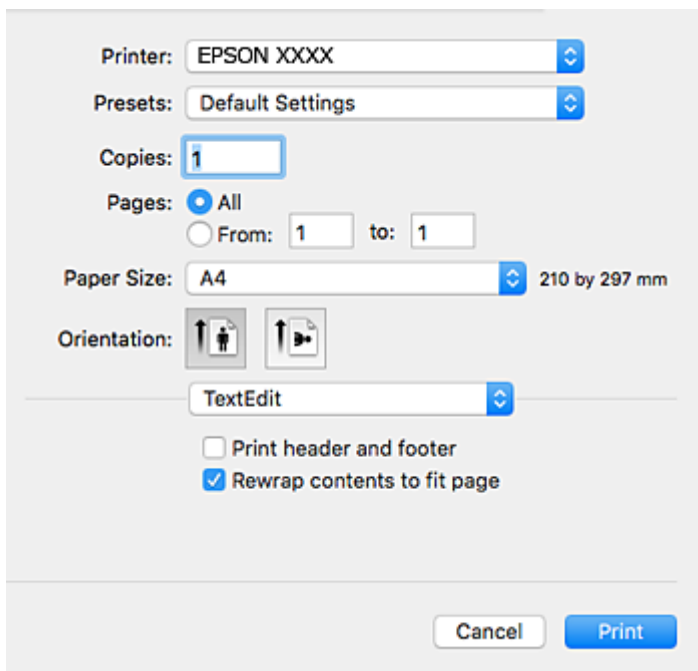

4. Make the following settings.
 - Printer: Select your printer.
 - Presets: Select when you want to use the registered settings.
 - Paper Size: Select the paper size you loaded in the printer.
When printing with no margins, select a "borderless" paper size.
 - Orientation: Select the orientation you set in the application.

Note:

- If the above setting menus are not displayed, close the print window, select **Page Setup** from the **File** menu, and then make settings.
- When printing on envelopes, select landscape orientation.

Printing

5. Select **Print Settings** from the pop-up menu.

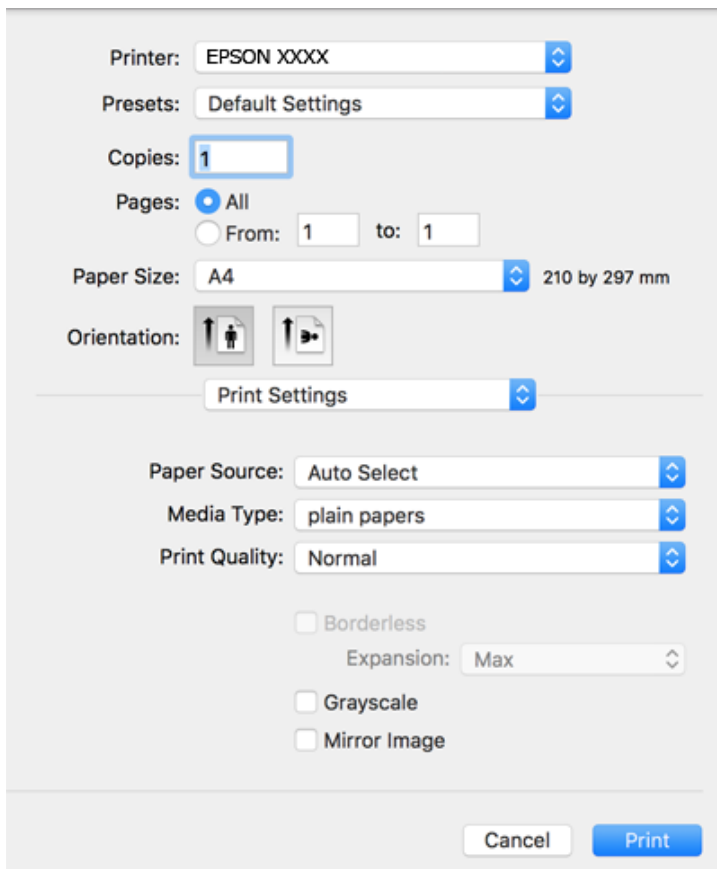

Note:

On Mac OS X v10.8.x or later, if the **Print Settings** menu is not displayed, the Epson printer driver has not been installed correctly.

Select **System Preferences** from the  menu > **Printers & Scanners** (or **Print & Scan**, **Print & Fax**), remove the printer, and then add the printer again. See the following to add a printer.

<http://epson.sn>

6. Make the following settings.

- Paper Source: Select the paper source in which you loaded the paper. If the printer has only one paper source, this item is not displayed.
- Media Type: Select the type of paper you loaded.
- Print Quality: Select the print quality.
Selecting a higher quality setting may reduce the printing speed.
- Expansion: Available when selecting a borderless paper size.
In borderless printing, the print data is enlarged slightly more than the paper size so that no margins are printed around the edges of the paper. Select the amount of enlargement.
- Grayscale: Select to print in black or shades of gray.

7. Click **Print**.

Printing

Related Information

- ➔ [“Available Paper and Capacities” on page 43](#)
- ➔ [“Loading Paper in the Paper Cassette” on page 45](#)
- ➔ [“List of Paper Type” on page 44](#)

Printing on 2-Sides

You can use either of the following methods to print on both sides of the paper.

- Automatic 2-sided printing
- Manual 2-sided printing (for Windows only)

When the printer has finished printing the first side, flip the paper over to print on the other side.

You can also print a booklet that can be created by folding the printout. (For Windows only)

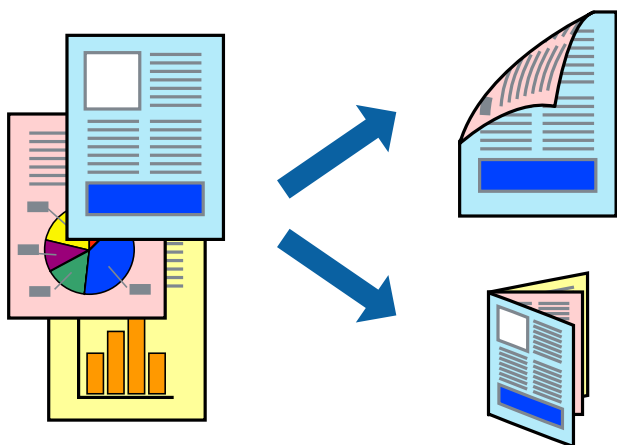

Note:

- This feature is not available for borderless printing.
- If you do not use paper that is suitable for 2-sided printing, the print quality may decline and paper jams may occur.
- Depending on the paper and the data, ink may bleed through to the other side of the paper.

Related Information

- ➔ [“Available Paper and Capacities” on page 43](#)

Printing on 2-Sides - Windows

Note:

- Manual 2-sided printing is available when **EPSON Status Monitor 3** is enabled. If **EPSON Status Monitor 3** is disabled, access the printer driver, click **Extended Settings** on the **Maintenance** tab, and then select **Enable EPSON Status Monitor 3**.
- Manual 2-sided printing may not be available when the printer is accessed over a network or is used as a shared printer.

1. Load paper in the printer.
2. Open the file you want to print.

Printing

3. Access the printer driver window.
4. Select **Auto (Long-edge binding)**, **Auto (Short-edge binding)**, **Manual (Long-edge binding)**, or **Manual (Short-edge binding)** from **2-Sided Printing** on the **Main** tab.
5. Click **Settings**, make the appropriate settings, and then click **OK**.

Note:

*To print a folded booklet, select **Booklet**.*

6. Click **Print Density**, select the document type from **Select Document Type**, and then click **OK**.

The printer driver automatically sets the **Adjustments** options for that document type.

Note:

*Printing may be slow depending on the combination of options selected for **Select Document Type** in the **Print Density Adjustment** window and for **Quality** on the **Main** tab.*

*For manual 2-sided printing, the **Print Density Adjustment** setting is not available.*

7. Set the other items on the **Main** and **More Options** tabs as necessary, and then click **OK**.

8. Click **Print**.

For manual 2-sided printing, when the first side has finished printing, a pop-up window is displayed on the computer. Follow the on-screen instructions.

Related Information

➔ [“Loading Paper in the Paper Cassette” on page 45](#)

➔ [“Printing Basics - Windows” on page 61](#)

Printing on 2-Sides - Mac OS X

1. Load paper in the printer.
2. Open the file you want to print.
3. Access the print dialog.
4. Select **Two-sided Printing Settings** from the pop-up menu.
5. Select the bindings and **Document Type**.

Note:

*Printing may be slow depending on the **Document Type** setting.*

*If you are printing high-density data such as photos or graphs, select **Text & Graphics** or **Text & Photos as the Document Type** setting. If scuffing occurs or the image bleeds through to the reverse side, adjust the print density and ink drying time by clicking the arrow mark next to **Adjustments**.*

6. Set the other items as necessary.
7. Click **Print**.

Printing

Related Information

- ➔ [“Loading Paper in the Paper Cassette” on page 45](#)
- ➔ [“Printing Basics - Mac OS X” on page 63](#)

Printing Several Pages on One Sheet

You can print two or four pages of data on a single sheet of paper.

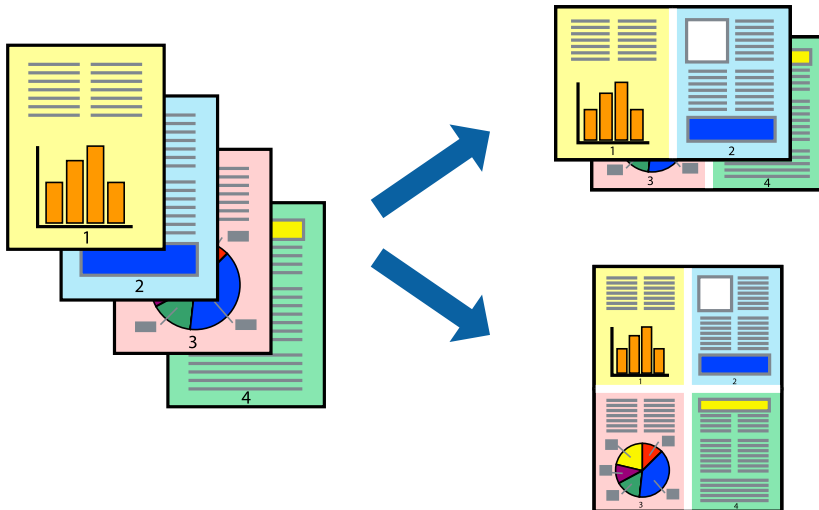

Printing Several Pages on One Sheet - Windows

Note:

This feature is not available for borderless printing.

1. Load paper in the printer.
2. Open the file you want to print.
3. Access the printer driver window.
4. Select **2-Up** or **4-Up** as the **Multi-Page** setting on the **Main** tab.
5. Click **Page Order**, make the appropriate settings, and then click **OK** to close the window.
6. Set the other items on the **Main** and **More Options** tabs as necessary, and then click **OK**.
7. Click **Print**.

Related Information

- ➔ [“Loading Paper in the Paper Cassette” on page 45](#)
- ➔ [“Printing Basics - Windows” on page 61](#)

Printing

Printing Several Pages on One Sheet - Mac OS X

1. Load paper in the printer.
2. Open the file you want to print.
3. Access the print dialog.
4. Select **Layout** from the pop-up menu.
5. Set the number of pages in **Pages per Sheet**, the **Layout Direction** (page order), and **Border**.
6. Set the other items as necessary.
7. Click **Print**.

Related Information

- ➔ [“Loading Paper in the Paper Cassette” on page 45](#)
- ➔ [“Printing Basics - Mac OS X” on page 63](#)

Printing to Fit the Paper Size

You can print to fit the paper size you loaded in the printer.



Printing to Fit the Paper Size - Windows

Note:

This feature is not available for borderless printing.

1. Load paper in the printer.
2. Open the file you want to print.
3. Access the printer driver window.
4. Make the following settings on the **More Options** tab.
 - Document Size: Select the paper size you set in the application.

Printing

- ❑ Output Paper: Select the paper size you loaded in the printer.
Fit to Page is selected automatically.

Note:

*If you want to print a reduced image at the center of the page, select **Center**.*

5. Set the other items on the **Main** and **More Options** tabs as necessary, and then click **OK**.
6. Click **Print**.

Related Information

- ➔ [“Loading Paper in the Paper Cassette” on page 45](#)
- ➔ [“Printing Basics - Windows” on page 61](#)

Printing to Fit the Paper Size - Mac OS X

1. Load paper in the printer.
2. Open the file you want to print.
3. Access the print dialog.
4. Select the size of the paper you set in the application as the **Paper Size** setting.
5. Select **Paper Handling** from the pop-up menu.
6. Select **Scale to fit paper size**.
7. Select the paper size you loaded in the printer as the **Destination Paper Size** setting.
8. Set the other items as necessary.
9. Click **Print**.

Related Information

- ➔ [“Loading Paper in the Paper Cassette” on page 45](#)
- ➔ [“Printing Basics - Mac OS X” on page 63](#)

Printing Multiple Files Together (for Windows Only)

Job Arranger Lite allows you to combine several files created by different applications and print them as a single print job. You can specify the print settings for combined files, such as layout, print order, and orientation.

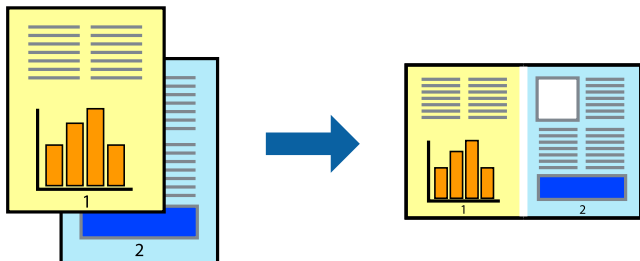

1. Load paper in the printer.
2. Open the file you want to print.
3. Access the printer driver window.
4. Select **Job Arranger Lite** on the **Main** tab.
5. Click **OK** to close the printer driver window.
6. Click **Print**.

The **Job Arranger Lite** window is displayed and the print job is added to the **Print Project**.

7. With the **Job Arranger Lite** window opened, open the file that you want to combine with the current file, and then repeat steps 3 to 6.

Note:

- If you close the **Job Arranger Lite** window, the unsaved **Print Project** is deleted. To print later, select **Save** from the **File** menu.
- To open a **Print Project** saved in **Job Arranger Lite**, click **Job Arranger Lite** on the printer driver's **Maintenance** tab. Next, select **Open** from the **File** menu to select the file. The extension of the saved files is ".ecl".

8. Select the **Layout** and **Edit** menus in **Job Arranger Lite** to edit the **Print Project** as necessary. See the help of **Job Arranger Lite** for details.
9. Select **Print** from the **File** menu.

Related Information

- ➔ [“Loading Paper in the Paper Cassette” on page 45](#)
- ➔ [“Printing Basics - Windows” on page 61](#)

Printing One Image on Multiple Sheets to Create a Poster (for Windows Only)

This feature allows you to print one image on multiple sheets of paper. You can create a larger poster by taping them together.

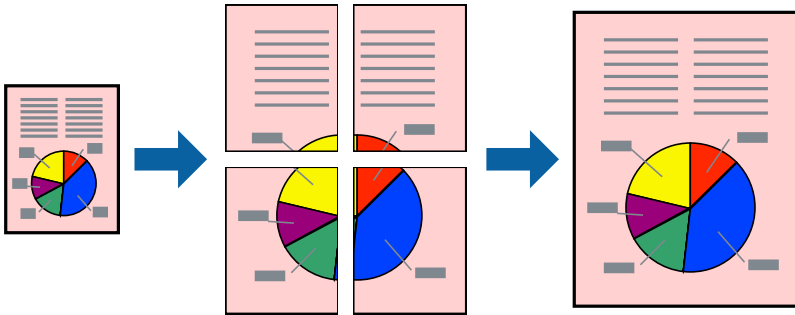

Note:

This feature is not available for borderless printing.

1. Load paper in the printer.
2. Open the file you want to print.
3. Access the printer driver window.
4. Select **2x1 Poster**, **2x2 Poster**, **3x3 Poster**, or **4x4 Poster** from **Multi-Page** on the **Main** tab.
5. Click **Settings**, make the appropriate settings, and then click **OK**.

Note:

Print Cutting Guides allows you to print a cutting guide.

6. Set the other items on the **Main** and **More Options** tabs as necessary, and then click **OK**.
7. Click **Print**.

Related Information

- ➔ [“Loading Paper in the Paper Cassette” on page 45](#)
- ➔ [“Printing Basics - Windows” on page 61](#)

Making Posters Using Overlapping Alignment Marks

Here is an example of how to make a poster when **2x2 Poster** is selected, and **Overlapping Alignment Marks** is selected in **Print Cutting Guides**.

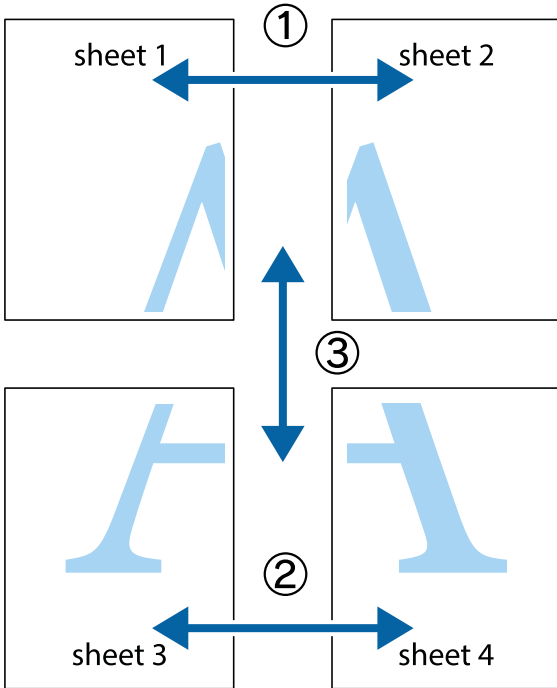

1. Prepare Sheet 1 and Sheet 2. Cut off the margins of Sheet 1 along the vertical blue line through the center of the top and bottom cross marks.

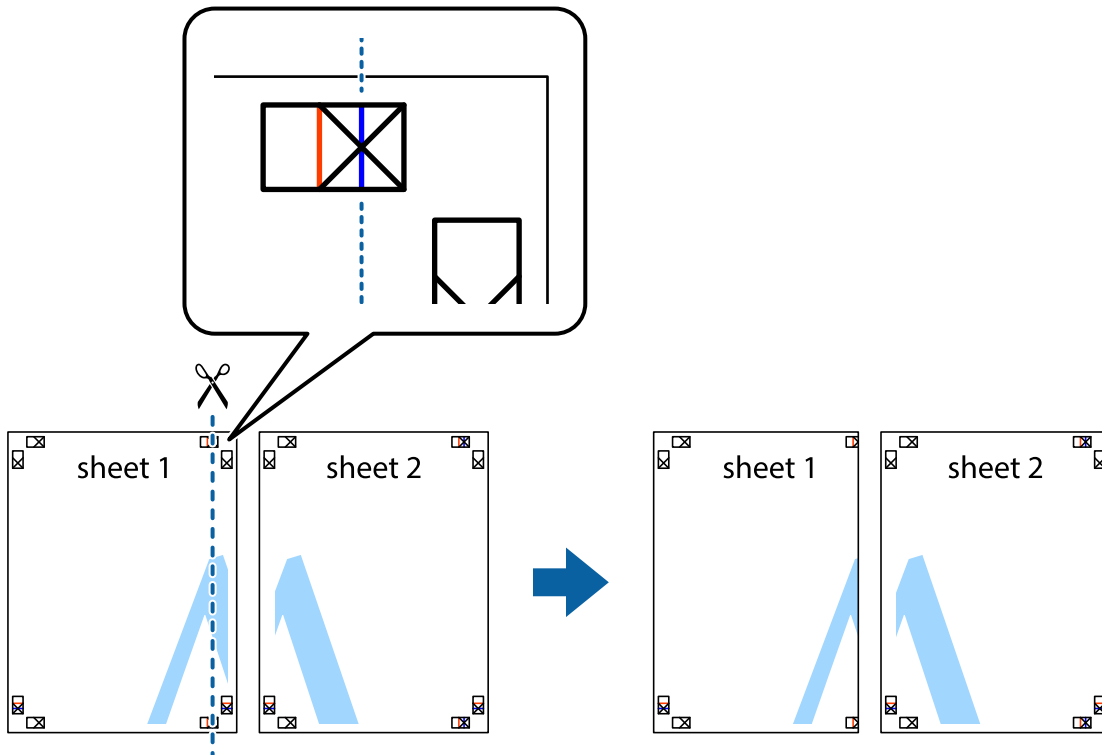

Printing

2. Place the edge of Sheet 1 on top of Sheet 2 and align the cross marks, then temporarily tape the two sheets together from the back.

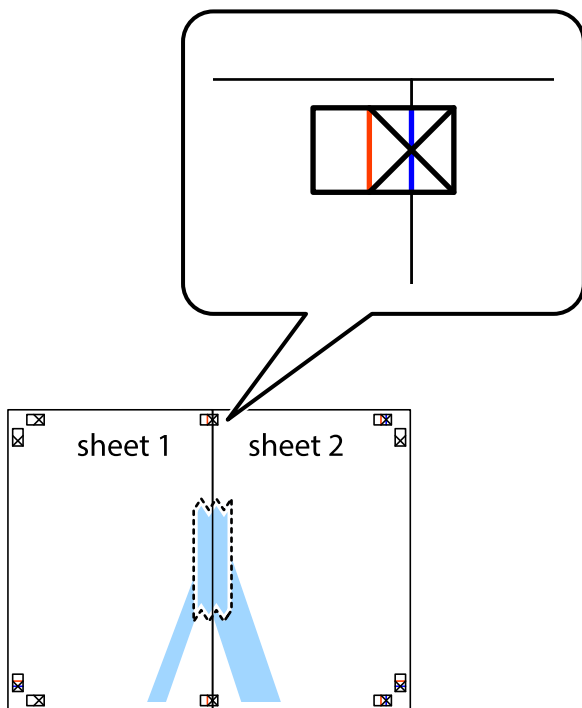

3. Cut the taped sheets in two along the vertical red line through the alignment markers (this time, the line to the left of the cross marks).

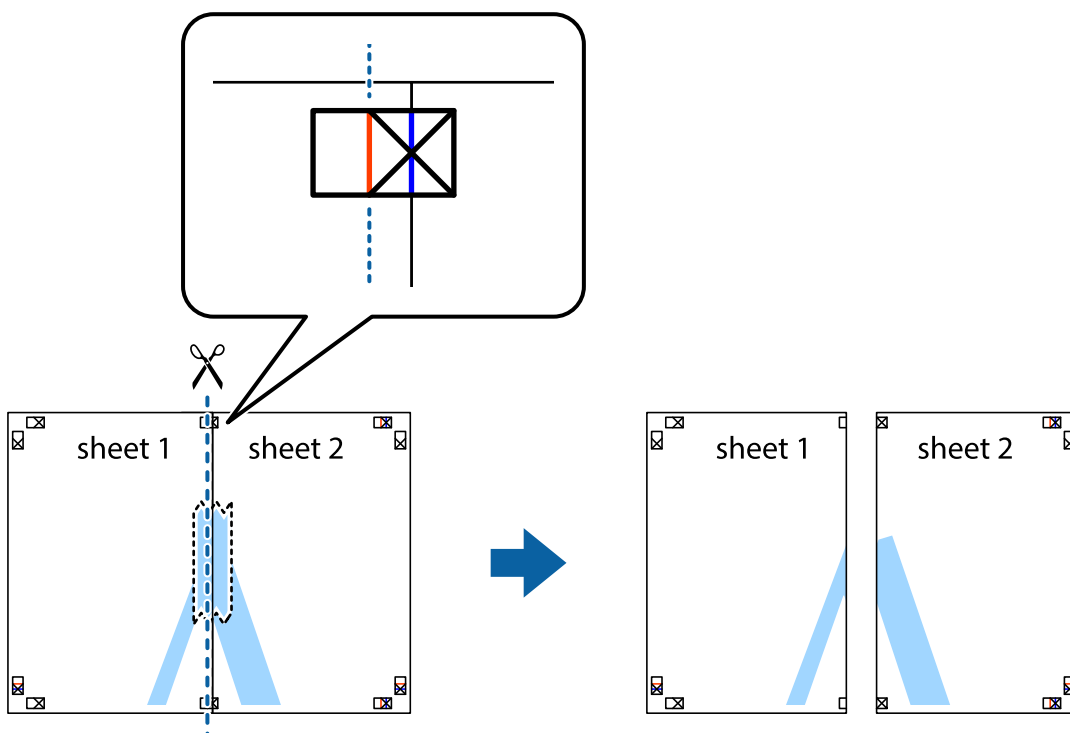

Printing

4. Tape the sheets together from the back.

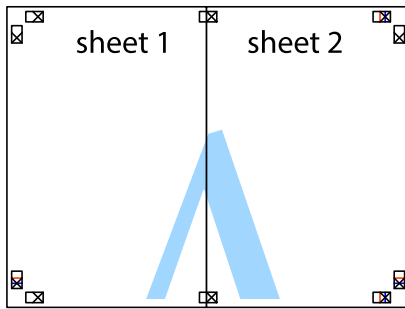

5. Repeat steps 1 to 4 to tape Sheet 3 and Sheet 4 together.
6. Cut off the margins of Sheet 1 and Sheet 2 along the horizontal blue line through the center of the left and right side cross marks.

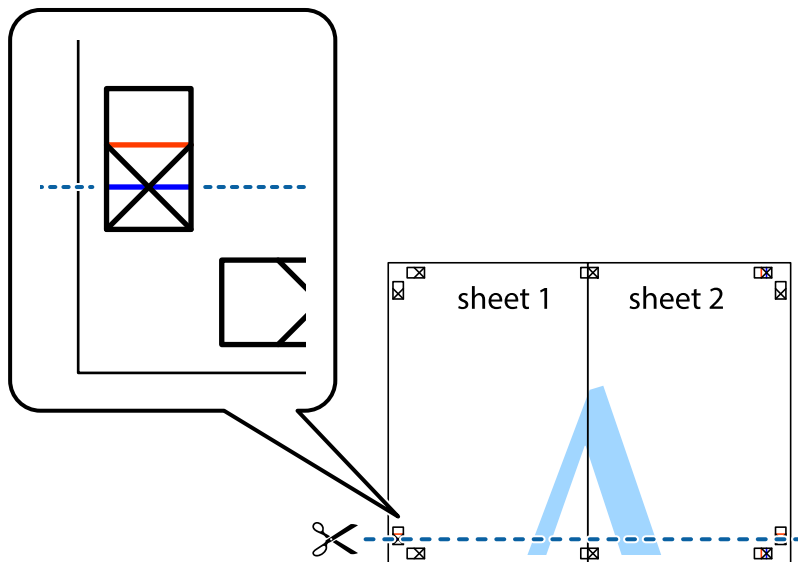

Printing

7. Place the edge of Sheet 1 and Sheet 2 on top of Sheet 3 and Sheet 4 and align the cross marks, and then temporarily tape them together from the back.

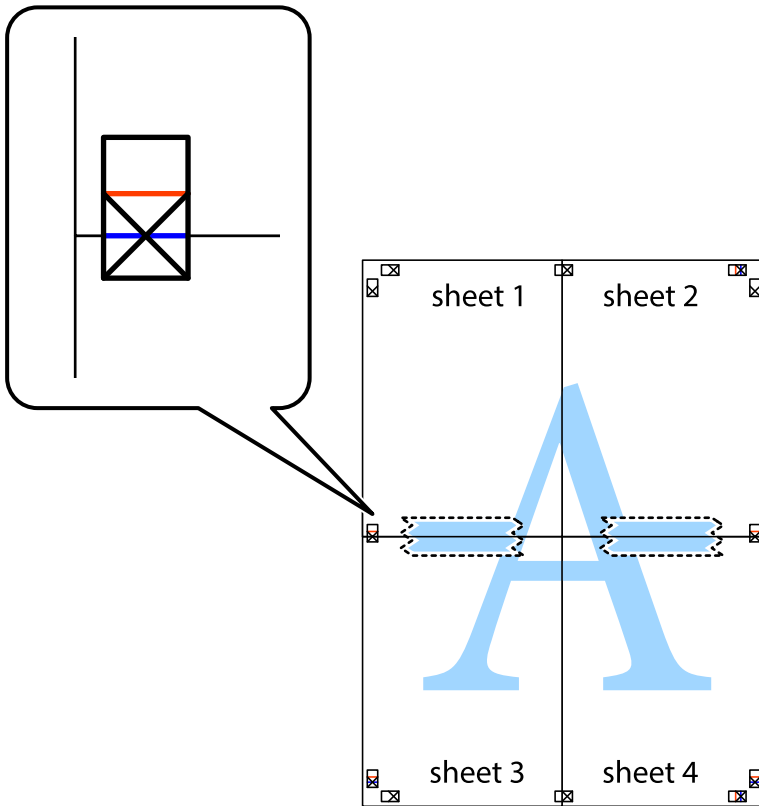

Printing

- Cut the taped sheets in two along the horizontal red line through the alignment markers (this time, the line above the cross marks).

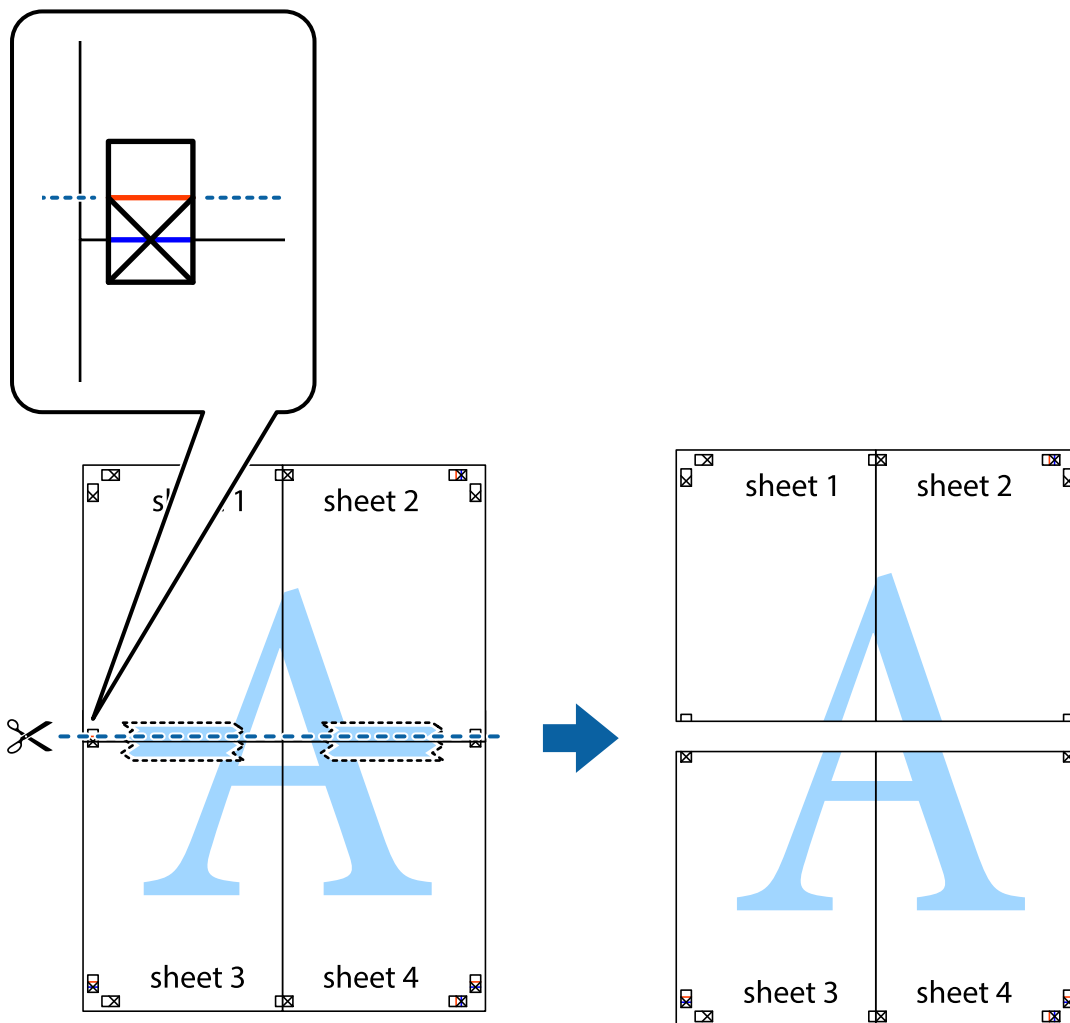

- Tape the sheets together from the back.

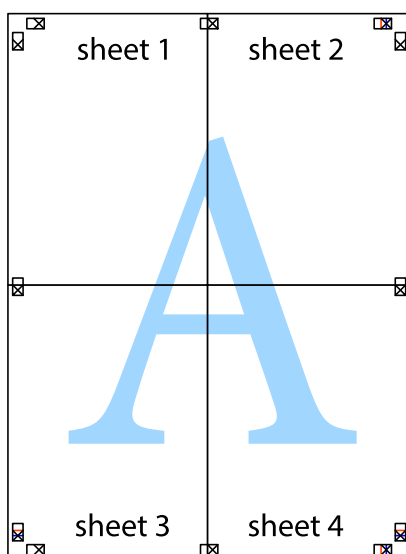

Printing

10. Cut off the remaining margins along the outer guide.

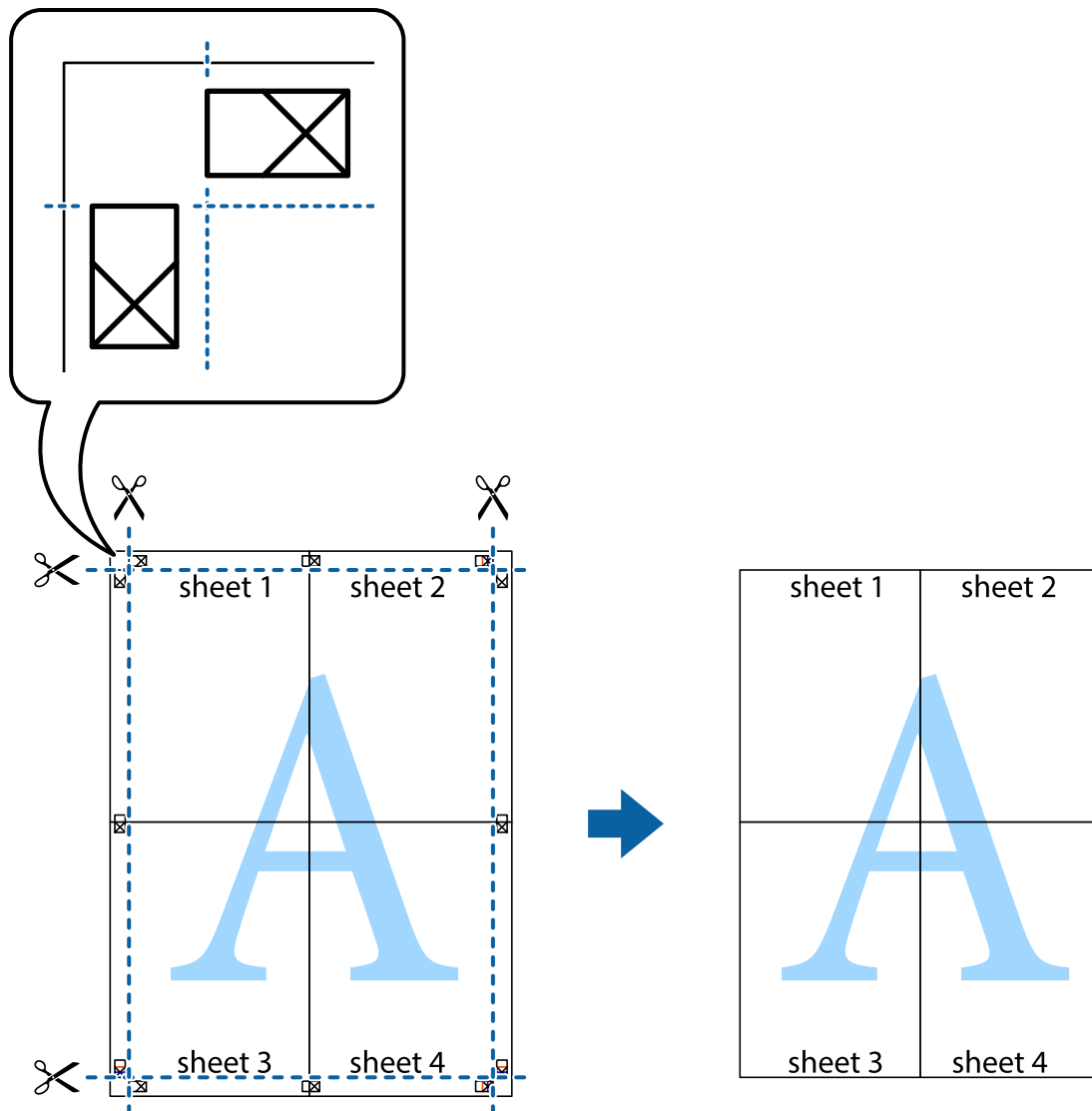

Printing Using Advanced Features

This section introduces a variety of additional layout and printing features available on the printer driver.

Related Information

- ➔ [“Windows Printer Driver” on page 163](#)
- ➔ [“Mac OS X Printer Driver” on page 165](#)

Adding a Printing Preset to Print Easily

If you create your own preset of frequently used print settings on the printer driver, you can print easily by selecting the preset from the list.

Printing

Windows

To add your own preset, set items such as the **Document Size** and **Paper Type** on the **Main** or **More Options** tab, and then click **Add/Remove Presets** in **Printing Presets**.

Note:

To delete an added preset, click **Add/Remove Presets**, select the preset name you want to delete from the list, and then delete it.

Mac OS X

Access the print dialog. To add your own preset, set items such as the **Paper Size** and **Media Type**, and then save the current settings as the preset in the **Presets** setting.

Note:

To delete an added preset, click **Presets > Show Presets**, select the preset name you want to delete from the list, and then delete it.

Printing a Reduced or Enlarged Document

You can reduce or enlarge the size of a document by a specific percentage.

Windows

Note:

This feature is not available for borderless printing.

Set the **Document Size** on the **More Options** tab. Select **Reduce/Enlarge Document**, **Zoom to**, and then enter a percentage.

Mac OS X

Note:

Operations differ depending on the application. See the application's help for details.

Select **Page Setup** (or **Print**) from the **File** menu. Select the printer from **Format For**, select the paper size, and then enter a percentage in **Scale**. Close the window, and then print following the basic printing instructions.

Related Information

➔ [“Printing Basics - Mac OS X” on page 63](#)

Adjusting the Print Color

You can adjust the colors used in the print job.

PhotoEnhance produces sharper images and more vivid colors by automatically adjusting the contrast, saturation, and brightness of the original image data.

Note:

These adjustments are not applied to the original data.

PhotoEnhance adjusts the color by analyzing the location of the subject. Therefore, if you have changed the location of the subject by reducing, enlarging, cropping, or rotating the image, the color may change unexpectedly. Selecting the borderless setting also changes the location of the subject resulting in changes in color. If the image is out of focus, the tone may be unnatural. If the color is changed or becomes unnatural, print in a mode other than **PhotoEnhance**.

Printing

Windows

Select the method of color correction from **Color Correction** on the **More Options** tab.

If you select **Automatic**, the colors are automatically adjusted to match the paper type and print quality settings. If you select **Custom** and click **Advanced**, you can make your own settings.

Mac OS X

Access the print dialog. Select **Color Matching** from the pop-up menu, and then select **EPSON Color Controls**. Select **Color Options** from the pop-up menu, and then select one of the available options. Click the arrow next to **Advanced Settings** and make the appropriate settings.

Printing an Anti-Copy Pattern (for Windows Only)

You can print documents with invisible letters such as "Copy". These letters appear when the document is photocopied so that the copies can be distinguished from the original. You can also add your own anti-copy pattern.

Note:

This feature is only available when the following settings are selected.

- Paper Type: plain papers
- Quality: Standard
- Auto 2-sided printing: Disabled
- Borderless printing: Disabled
- Color Correction: Automatic

Click **Watermark Features** on the **More Options** tab, and then select an anti-copy pattern. Click **Settings** to change details such as the size and density.

Printing a Watermark (for Windows Only)

You can print a watermark such as "Confidential" on your printouts. You can also add your own watermark.

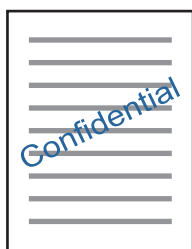

Note:

This feature is not available with borderless printing.

Click **Watermark Features** on the **More Options** tab, and then select a watermark. Click **Settings** to change details such as the density and position of the watermark.

Printing

Printing a Header and Footer (for Windows Only)

You can print information such as a user name and printing date as headers or footers.

Click **Watermark Features** in the **More Options** tab, and then select **Header/Footer**. Click **Settings** and select necessary items from the drop-down list.

Printing Clear Bar Codes (for Windows Only)

You can print a bar code clearly and make it easy to scan. Only enable this feature if the bar code you printed cannot be scanned. You can use this feature under the following conditions.

- Paper Type: plain papers, Letterhead, Recycled, Color, Preprinted, Envelope, High quality plain paper
- Quality: Standard

Note:

Deblurring may not always be possible depending on the circumstances.

On the **Maintenance** tab, click **Extended Settings**, and then select **Barcode mode**.

Printing Photos Using Epson Easy Photo Print

Epson Easy Photo Print lets you lay out and print photos easily on various types of paper. See the application's help for details.

Note:

- By printing on genuine Epson photo paper, the ink quality is maximized and the printouts are vivid and clear.*
- To perform borderless printing using a commercially available application, make the following settings.*
 - Create the image data to fully fit the paper size and if a margin setting is available in the application you are using, set the margin to 0 mm.
 - Enable the borderless printing setting in the printer driver.

Related Information

- ➔ [“Epson Easy Photo Print” on page 168](#)
- ➔ [“Installing Applications” on page 171](#)

Printing from Smart Devices

Using Epson iPrint

Epson iPrint is an application that allows you to print photos, documents, and web pages from a smart device such as a smartphone or tablet. You can use local print, printing from a smart device that is connected to the same

Printing

wireless network as your printer, or remote print, printing from a remote location over the Internet. To use remote print, register your printer in the Epson Connect service.



Related Information

➔ “Epson Connect Service” on page 161

Installing Epson iPrint

You can install Epson iPrint on your smart device from the following URL or QR code.

<http://ipr.to/c>



Printing Using Epson iPrint

Start Epson iPrint from your smart device and select the item you want to use from the home screen.

The following screens are subject to change without notice.

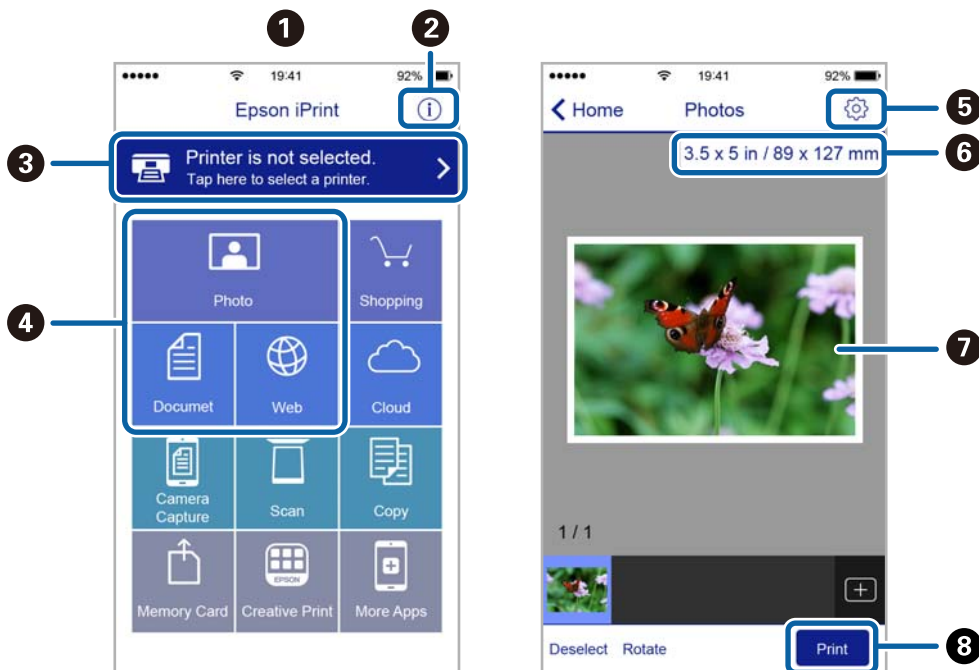

Printing

①	Home screen displayed when the application is started.
②	Displays information on how to setup the printer and a FAQ.
③	Displays the screen where you can select the printer and make printer settings. Once you have selected the printer, you do not need to select it again from the next time.
④	Select what you want to print such as photos, documents, and web pages.
⑤	Displays the screen to make print settings such as paper size and paper type.
⑥	Displays the paper size. When this is displayed as a button, press it to display the paper settings currently set on the printer.
⑦	Displays photos and documents you selected.
⑧	Starts printing.

Note:

To print from the document menu using iPhone, iPad, and iPod touch running iOS, start Epson iPrint after transferring the document you want to print using the file sharing function in iTunes.

Printing by Touching Smart Devices to the NFC Tag

You can connect the printer and your smart device automatically and print by touching the NFC antenna of a smart device running Android 4.0 or later and that supports NFC (Near Field Communication) to the printer's NFC tag.

The location of the NFC antenna varies depending on the smart device. See the documentation provided with your smart device for more details.



Important:

- Make sure that the Wi-Fi Direct (Simple AP) connection setting is enabled.
- Enable the NFC function on your smart device.
- Make sure that Epson iPrint is installed on your smart device. If not, touch the NFC antenna of the smart device to the printer's NFC tag and install it.

Note:

- If the printer does not communicate with the smart device even after touching it to the tag, try adjusting the position of the smart device and touch it to the tag again.
- If there are obstacles such as metal between the printer's NFC tag and the NFC antenna of the smart device, the printer may not be able to communicate with the smart device.
- This feature uses a Wi-Fi Direct (Simple AP) connection to connect to the printer. You can connect up to four devices to the printer at the same time.
- If you have changed the password for the Wi-Fi Direct (Simple AP) connection, you cannot use this feature. Restore the initial password to use this feature.

1. Load paper in the printer.

Printing

2. Touch the NFC antenna of your smart device to the printer's NFC tag.

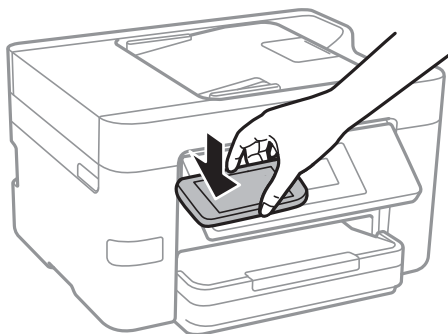

Epson iPrint starts.

3. On the Epson iPrint home screen, touch the NFC antenna of your smart device to the printer's NFC tag again.
The printer and the smart device are connected.
4. Select the image you want to print, and then select **Next** at the top right of the screen.
5. Touch the NFC antenna of your smart device to the printer's NFC tag again.
Printing starts.

Related Information

- ➔ [“Making Wi-Fi Direct \(Simple AP\) Connection Settings” on page 30](#)
- ➔ [“Loading Paper in the Paper Cassette” on page 45](#)

Using AirPrint

AirPrint enables instant wireless printing from iPhone, iPad, and iPod touch with the latest version of iOS, and Mac with the latest version of OS X.



Note:

If you disabled paper configuration messages on your product control panel, you cannot use AirPrint. See the link below to enable the messages, if necessary.

1. Load paper in your product.

Printing

2. Set up your product for wireless printing. See the link below.
<http://epson.sn>
3. Connect your Apple device to the same wireless network that your product is using.
4. Print from your device to your product.

Note:

For details, see the AirPrint page on the Apple website.

Related Information

- ➔ [“Loading Paper in the Paper Cassette” on page 45](#)

Canceling Printing

Note:

- In Windows, you cannot cancel a print job from the computer once it has been completely sent to the printer. In this case, cancel the print job by using the printer's control panel.*
- When printing several pages from Mac OS X, you cannot cancel all of the jobs by using the control panel. In this case, cancel the print job from the computer.*
- If you have sent a print job from Mac OS X v10.6.8 through the network, you may not be able to cancel printing from the computer. In this case, cancel the print job by using the printer's control panel.*

Canceling Printing - Control Panel

Tap  on the printer's control panel to cancel the print job in progress.

Canceling Printing - Windows

1. Access the printer driver window.
2. Select the **Maintenance** tab.
3. Click **Print Queue**.
4. Right-click on the job you want to cancel and then select **Cancel**.

Related Information

- ➔ [“Windows Printer Driver” on page 163](#)

Canceling Printing - Mac OS X

1. Click the printer icon in the **Dock**.
2. Select the job you want to cancel.

Printing

3. Cancel the job.

- ❑ Mac OS X v10.8.x or later

Click  next to the progress meter.

- ❑ Mac OS X v10.6.8 to v10.7.x

Click **Delete**.

Copying

Copying Basics

This section explains the steps for basic copying.

1. Place the originals.

If you want to copy multiple originals, place all of the originals on the ADF.

2. Tap **Copy** on the home screen.

3. Check the settings on the **Copy** tab.

Tap the setting item to change it as necessary.

Note:

If you tap **Advanced Settings**, you can make settings such as **Multi-Page** or **Original Type**.

If you tap , you can register frequently used copy settings as presets.

If the combination of settings you require is not available,  is displayed. Tap the icon to check the details, and then change the settings.

Tap **Preview** to check the scanned image before start copying.

4. Tap the value of the number of copies, and then enter the number of copies using the on-screen keypad.

5. Tap .

Related Information

- ➔ [“Placing Originals” on page 49](#)
- ➔ [“Basic Menu Options for Copying” on page 86](#)
- ➔ [“Advanced Menu Options for Copying” on page 87](#)

Basic Menu Options for Copying

Note:

The items may not be available depending on other settings you made.

B&W:

Copies the original in black and white (monochrome).

Color:

Copies the original in color.



(2-Sided):

Select 2-sided layout.

Copying

1→1-Sided

Copies one side of an original onto a single side of paper.

1→2-Sided

Copies two single-sided originals onto both sides of a single sheet of paper. Select the orientation of your original and the binding position of the paper.

 (Density) :

Increase the level of density when the copying results are faint. Decrease the level of density when ink smears.

Advanced Menu Options for Copying

Note:

The items may not be available depending on other settings you made.

Paper Setting:

Select paper size and paper type. If your printer has two paper cassettes, select the paper source that you want to use.

Reduce/Enlarge:

Configures the magnification ratio of the enlargement or reduction. If you want to reduce or enlarge the original by a specific percentage, tap the value, and then enter a percentage within a range of 25 to 400%.

Actual Size

Copies at 100 % magnification.

Auto Fit Page

Detects the scan area and automatically enlarges or reduces the original to fit to the paper size you selected. When there are white margins around the original, the white margins from the corner mark of the scanner glass are detected as the scan area, but the margins at the opposite side may be cropped.

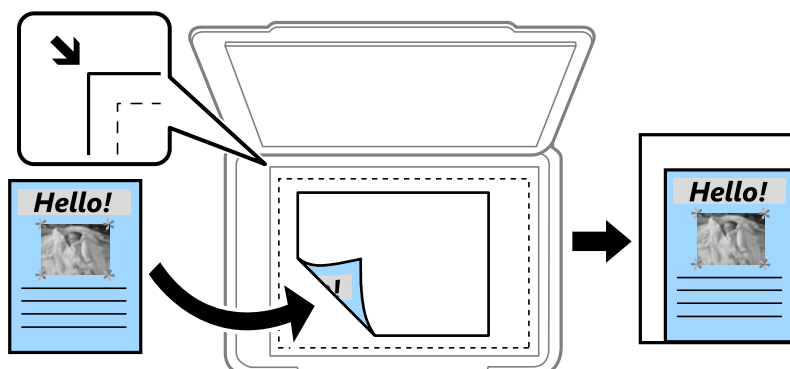

A4→A5 and others

Automatically enlarges or reduces the original to fit to a specific paper size.

Copying

Original Size:

Select the size of your original. When copying non-standard size originals, select the size closest to your original.

Multi-Page:

Single Page

Copies a single-sided original onto a single sheet.

2-up

Copies two single-sided originals onto a single sheet in 2-up layout. Select the layout order and the orientation of your original.

4-up

Copies four single-sided originals onto a single sheet in 4-up layout. Select the layout order and the orientation of your original.

Original Type:

Select the type of your original. Copies in optimal quality to match the type of original.

Finishing:

Select how to eject the paper for multiple copies of multiple originals.

Group (Same Pages)

Copies the originals by page as a group.

Collate (Page Order)

Copies the originals collated in order and sorted into sets.

Orientation (Original):

Select the orientation of your original.

Remove Shadow:

Removes shadows that appear around copies when copying thick paper or that appear in the center of copies when copying a booklet.

Remove Punch Holes:

Removes the binding holes when copying.

ID Card Copy:

Scans both sides of an ID card and copies onto one side of A4 size paper.

Borderless Copy:

Copies without margins around the edges. The image is enlarged a little to remove margins from the edges of the paper. Select how much to enlarge in the **Expansion** setting.

Clear All Settings:

Resets the copy settings to their defaults.

Scanning

Scanning Using the Control Panel

Scanning to a Network Folder or FTP Server

You can save the scanned image to a specified folder on a network. You can specify the folder by entering a folder path directly, but it may be easier if you register the folder information in the contacts list first.

Note:

- ❑ Before you use this feature, make sure the printer's **Date/Time** and **Time Difference** settings are correct. Access the menus from **Settings > General Settings > Basic Settings > Date/Time Settings**.
- ❑ You can check destination before scanning. Select **Settings > General Settings > Scan Settings**, and then enable **Confirm Recipient**.

1. Place the originals.
2. Tap **Scan** on the home screen.
3. Tap **Network Folder/FTP**.
4. Specify the folder.
 - ❑ To enter the folder path directly: Tap **Keyboard**. Select **Communication Mode**, enter the folder path as the **Location**, and then make other folder settings.
Enter the folder path in the following format.
When using SMB as the communication mode:
\\host name (computer name)\folder name
When using FTP as the communication mode:
ftp://host name (server name)/folder name
 - ❑ To select from the contacts list: Tap **Contacts**, select a contact, and then tap **Close**.
You can search for a folder from the contacts list. Enter the search keyword into the box at the top of the screen.

Note:

You can print the history of the folder in which documents are saved by tapping .

5. Tap **Scan Settings**, and then check settings such as the save format, and change them if necessary.

Note:

Tap  to save your settings as a preset.

6. Tap **Destination**, and then tap .

Related Information

- ➔ [“Managing Contacts” on page 53](#)
- ➔ [“Placing Originals” on page 49](#)

Scanning

Menu Options for Scanning to a Folder

Note:

The items may not be available depending on other settings you made.

Edit Location:

- Communication Mode:
Select the communication mode.
- Location:
Enter a folder path in which to save the scanned image.
- User Name:
Enter a user name for the specified folder.
- Password:
Enter a password for the specified folder.
- Connection Mode:
Select the connection mode.
- Port Number:
Enter a port number.

Color Mode:

Select whether to scan in color or in monochrome.

File Format:

Select the format in which to save the scanned image.

- Compression Ratio:
Select how much to compress the scanned image.
- PDF Settings:
When you have selected **PDF** as the save format setting, use these settings to protect PDF files.
To create a PDF file that requires a password when opening, set Document Open Password. To create a PDF file that requires a password when printing or editing, set Permissions Password.

Quality:

- Resolution:
Select the scanning resolution.
- Original Type:
Select the type of your original.

Scan Area:

- Scan Size:
Select the scan size. To crop the white space around the text or image when scanning, select **Auto Cropping**. To scan at the maximum area of the scanner glass, select **Max Area**.
- Orientation (Original):
Select the orientation of the original.

Scanning

Density:

Select the contrast of the scanned image.

Remove Shadow:

Remove the shadows of the original that appear in the scanned image.

Surround:

Remove the shadows at the edge of the original.

Center:

Remove the shadows of the binding margin of the booklet.

Remove Punch Holes:

Remove the punch holes that appear in the scanned image. You can specify the area to erase the punch holes by entering a value in the box on the right.

Erasing Position:

Select the position to remove the punch holes.

Document Direction:

Select the orientation of the original.

File Name:

Filename Prefix:

Enter a prefix for the name of the images in alphanumeric characters and symbols.

Add Date:

Add the date to the file name.

Add Time:

Add the time to the file name.

Clear All Settings

Resets the scan settings to their defaults.

Scanning to an Email

You can send scanned image files by email directly from the printer through a pre-configured email server. Before using this feature, you need to configure the email server.

You can specify the email address by entering directly, but it may be easier if you register the email address in the contacts list first.

Note:

- Before you use this feature, make sure the printer's **Date/Time** and **Time Difference** settings are correct. Access the menus from **Settings > General Settings > Basic Settings > Date/Time Settings**.
- Instead of this feature, you can select **Email** as a format when scanning to computer from the control panel. You can send an email by entering the address on a computer connected to this printer. When scanning to computer, make sure the computer is turned on.
- You can check destination before scanning. Select **Settings > General Settings > Scan Settings**, and then enable **Confirm Recipient**.

1. Place the originals.



Scanning

2. Tap **Scan** on the home screen.
3. Tap **Email**.
4. Specify the addresses.
 - To enter the email address manually: Tap **Keyboard**, enter the email address, and then tap **OK**.
 - To select from the contacts list: Tap **Contacts**, select a contact or a group, and then tap **Close**.
You can search for the address from the contacts list. Enter the search keyword into the box at the top of the screen.
 - To select from the history list: Tap **History**, select a contact, and then tap **Close**.

Note:

 - The number of recipients you selected is displayed on the right of the screen. You can send emails to up to 10 addresses and groups.*
If groups is included in recipients, you can select up to 200 individual addresses in total, taking addresses in the groups into account.
 - Tap the address box at the top of the screen to display the list of selected addresses.*
 - Tap  to display or print the sending history, or change the email server settings.
5. Tap **Scan Settings**, and then check settings such as the save format, and change them if necessary.

Note:

Tap  to save your settings as a preset.
6. Tap **Recipient**, and then tap .

Related Information

- ➔ [“Managing Contacts” on page 53](#)
- ➔ [“Scanning to a Computer \(Event Manager\)” on page 94](#)
- ➔ [“Placing Originals” on page 49](#)

Menu Options for Attaching to an Email

Note:

The items may not be available depending on other settings you made.

Color Mode:

Select whether to scan in color or in monochrome.

File Format:

Select the format in which to save the scanned image.

Compression Ratio:

Select how much to compress the scanned image.

PDF Settings:

When you have selected **PDF** as the save format setting, use these settings to protect PDF files.

To create a PDF file that requires a password when opening, set Document Open Password. To create a PDF file that requires a password when printing or editing, set Permissions Password.

Scanning

Quality:

- Resolution:
Select the scanning resolution.
- Original Type:
Select the type of your original.

Scan Area:

- Scan Size:
Select the scan size. To crop the white space around the text or image when scanning, select **Auto Cropping**. To scan at the maximum area of the scanner glass, select **Max Area**.
- Orientation (Original):
Select the orientation of the original.

Density:

Select the contrast of the scanned image.

Remove Shadow:

Remove the shadows of the original that appear in the scanned image.

- Surround:
Remove the shadows at the edge of the original.
- Center:
Remove the shadows of the binding margin of the booklet.

Remove Punch Holes:

Remove the punch holes that appear in the scanned image. You can specify the area to erase the punch holes by entering a value in the box on the right.

- Erasing Position:
Select the position to remove the punch holes.
- Document Direction:
Select the orientation of the original.

Subject:

Enter a subject for the email in alphanumeric characters and symbols.

Attached File Max Size:

Select the maximum file size that can be attached to the email.

File Name:

- Filename Prefix:
Enter a prefix for the name of the images in alphanumeric characters and symbols.
- Add Date:
Add the date to the file name.
- Add Time:
Add the time to the file name.

Scanning

Clear All Settings

Resets the scan settings to their defaults.

Scanning to a Computer (Event Manager)



Note:

Before scanning, install *Epson Scan 2* and *Epson Event Manager* on your computer.

1. Place the originals.
2. Tap **Scan** on the home screen.
3. Tap **Computer**.
4. Tap  to select the computer to which you want to save the scanned images.

Note:

When the printer is connected to a network, you can select the computer to which you want to save the scanned image. You can display up to 20 computers on the printer's control panel. If you set **Network Scan Name (Alphanumeric)** on *Epson Event Manager*, it is displayed on the control panel.

5. Tap  to select how to save the scanned image to a computer.
 - Save as JPEG: Saves the scanned image in JPEG format.
 - Save as PDF: Saves the scanned image in PDF format.
 - Attach to e-mail: Starts the email client on your computer, and then automatically attaches it to an email.
 - Follow custom setting: Saves the scanned image using the settings on the *Epson Event Manager*. You can change the scan settings such as the scanning size, folder to save to, or save format.
6. Tap .

Related Information

- ➔ [“Placing Originals” on page 49](#)
- ➔ [“Epson Event Manager” on page 166](#)

Making Custom Settings in Epson Event Manager

You can set the scan settings for **Follow custom setting** in *Epson Event Manager*.

See the *Epson Event Manager* help for details.

1. Start *Epson Event Manager*.

Scanning

2. Make sure that your scanner is selected as the **Scanner** on the **Button Settings** tab on the main screen.

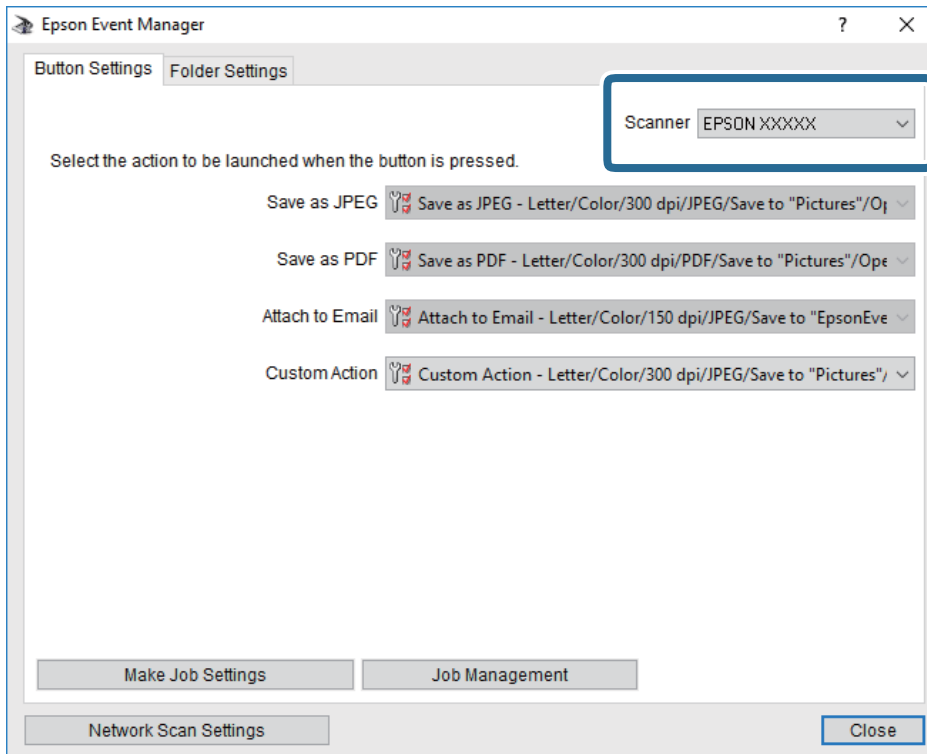

3. Click **Make Job Settings**.

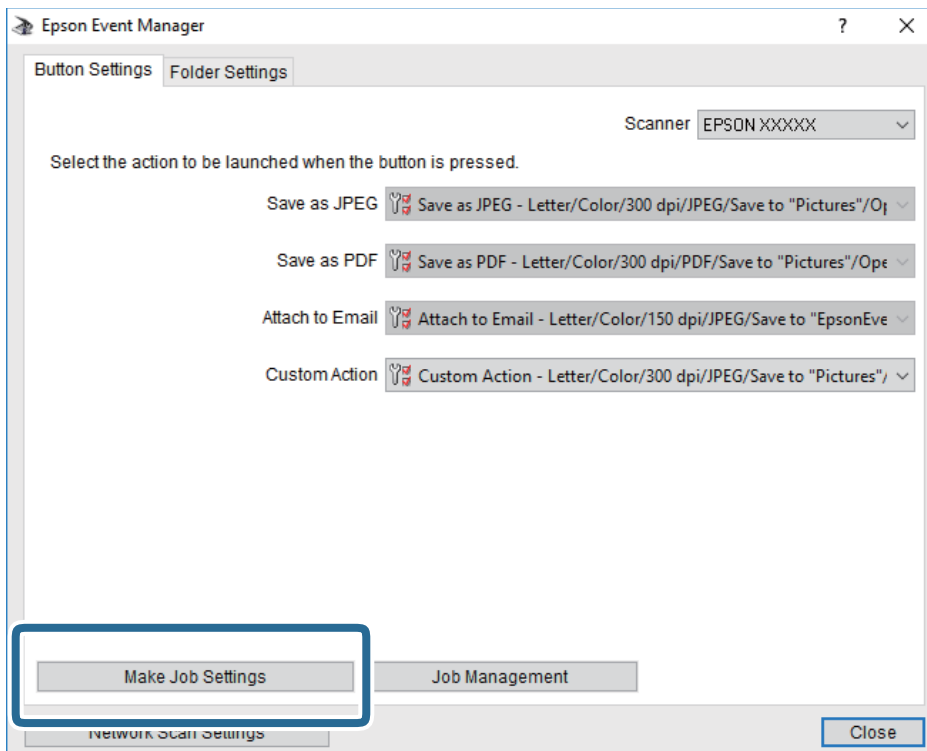

Scanning

4. Make scan settings on the **Job Settings** screen.

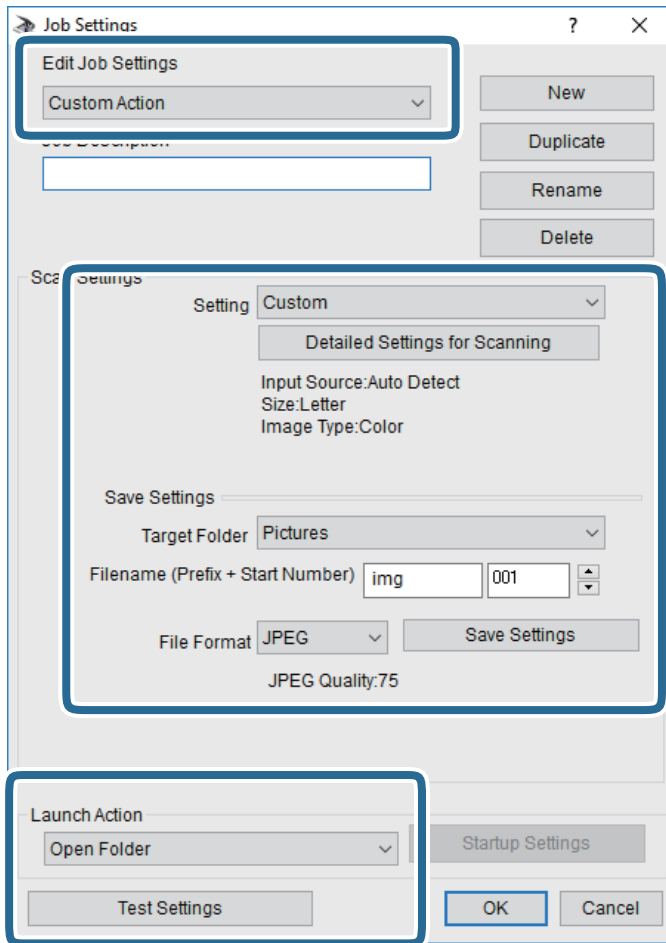

- Edit Job Settings: Select **Custom Action**.
- Setting: Scan using the best settings for the selected type of original. Click **Detailed Settings for Scanning** to set the items such as the resolution or the color for saving the scanned image.
- Target Folder: Select the save folder for the scanned image.
- Filename (Prefix + Start Number): Change the settings for the file name you want to save.
- File Format: Select the save format.
- Launch Action: Select the action when scanning.
- Test Settings: Starts test scanning using current settings.

5. Click **OK** to return to the main screen.

Scanning

6. Make sure that the **Custom Action** is selected on the **Custom Action** list.

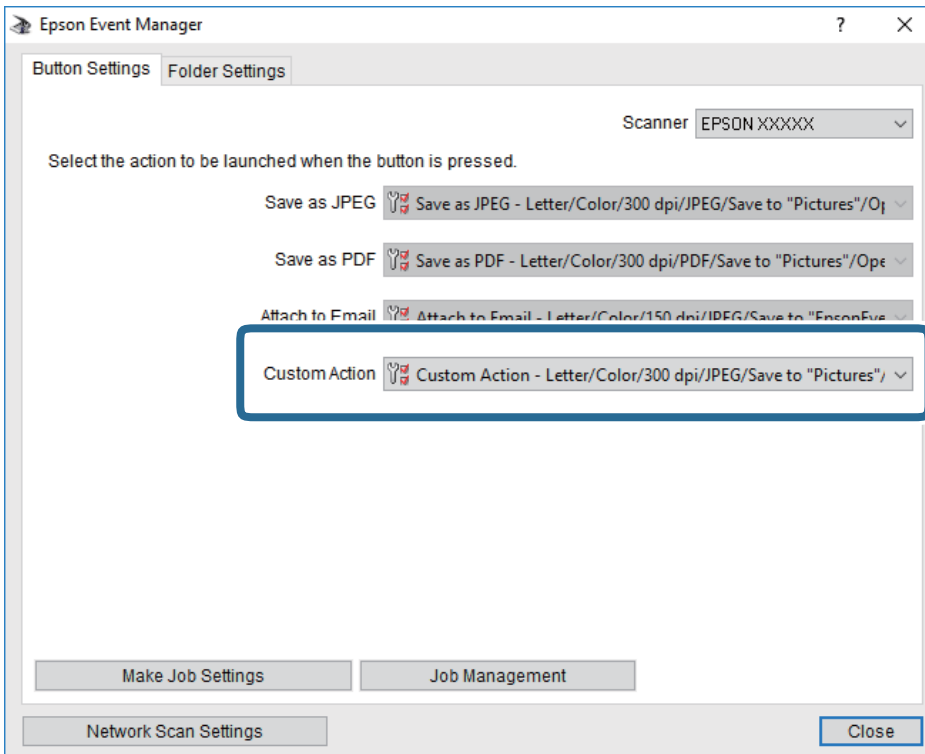

7. Click **Close** to close Epson Event Manager.

Scanning to a Memory Device

You can save the scanned image to a memory device.

1. Insert a memory device into the printer's external interface USB port.
2. Place the originals.
3. Tap **Scan** on the home screen.
4. Tap **Memory Device**.
5. Set items on **Scan** tab, such as the save format.
6. Tap **Advanced Settings**, and then check settings, and change them if necessary.

Note:

Tap  to save your settings as a preset.

7. Tap **Scan**, and then tap .

Related Information

- ➔ [“Part Names and Functions” on page 14](#)
- ➔ [“Placing Originals” on page 49](#)

Scanning

Basic Menu Options for Scanning to a Memory Device

Note:

The items may not be available depending on other settings you made.

B&W/Color:

Select whether to scan in color or in monochrome.



(File Format):

Select the format in which to save the scanned image.

Compression Ratio:

Select how much to compress the scanned image.

PDF Settings:

When you have selected **PDF** as the save format setting, use these settings to protect PDF files.

To create a PDF file that requires a password when opening, set Document Open Password. To create a PDF file that requires a password when printing or editing, set Permissions Password.



(Quality):

Resolution:

Select the scanning resolution.

Original Type:

Select the type of your original.

Advanced Menu Options for Scanning to a Memory Device

Note:

The items may not be available depending on other settings you made.

Scan Area:

Scan Size:

Select the scan size. To crop the white space around the text or image when scanning, select **Auto Cropping**. To scan at the maximum area of the scanner glass, select **Max Area**.

Orientation (Original):

Select the orientation of the original.

Density:

Select the contrast of the scanned image.

Remove Shadow:

Remove the shadows of the original that appear in the scanned image.

Surround:

Remove the shadows at the edge of the original.

Center:

Remove the shadows of the binding margin of the booklet.

Scanning

Remove Punch Holes:

Remove the punch holes that appear in the scanned image. You can specify the area to erase the punch holes by entering a value in the box on the right.

Erasing Position:

Select the position to remove the punch holes.

Document Direction:

Select the orientation of the original.

File Name:

Filename Prefix:

Enter a prefix for the name of the images in alphanumeric characters and symbols.

Add Date:

Add the date to the file name.

Add Time:

Add the time to the file name.

Clear All Settings

Resets the scan settings to their defaults.

Scanning to the Cloud

You can send scanned images to cloud services. Before using this feature, make settings using Epson Connect. See the following Epson Connect portal website for details.

<https://www.epsonconnect.com/>

<http://www.epsonconnect.eu> (Europe only)

1. Make sure that you have made settings using Epson Connect.
2. Place the originals.
3. Tap **Scan** on the home screen.
4. Tap **Cloud**.
5. Tap  on the top of the screen, and then select a destination.
6. Set items on **Scan** tab, such as the save format.
7. Tap **Advanced Settings**, and then check settings, and change them if necessary.

Note:

Tap  to save your settings as a preset.

8. Tap **Scan**, and then tap .

Scanning

Related Information

➔ [“Placing Originals” on page 49](#)

Basic Menu Options for Scanning to the Cloud

Note:

The items may not be available depending on other settings you made.

B&W/Color:

Select whether to scan in color or in monochrome.

JPEG/PDF:

Select the format in which to save the scanned image.

Advanced Menu Options for Scanning to the Cloud

Note:

The items may not be available depending on other settings you made.

Scan Area:

Scan Size:

Select the scan size. To crop the white space around the text or image when scanning, select **Auto Cropping**. To scan at the maximum area of the scanner glass, select **Max Area**.

Orientation (Original):

Select the orientation of the original.

Original Type:

Select the type of your original.

Density:

Select the contrast of the scanned image.

Remove Shadow:

Remove the shadows of the original that appear in the scanned image.

Surround:

Remove the shadows at the edge of the original.

Center:

Remove the shadows of the binding margin of the booklet.

Remove Punch Holes:

Remove the punch holes that appear in the scanned image. You can specify the area to erase the punch holes by entering a value in the box on the right.

Erasing Position:

Select the position to remove the punch holes.

Scanning

- Document Direction:
Select the orientation of the original.

Clear All Settings

Resets the scan settings to their defaults.

Scanning to a Computer (WSD)

Note:

- This feature is only available for computers running Windows 10/Windows 8.1/Windows 8/Windows 7/Windows Vista.
- If you are using Windows 7/Windows Vista, you need to setup your computer in advance using this feature.

1. Place the originals.
2. Tap **Scan** on the home screen.
3. Tap **Computer (WSD)**.
4. Select a computer.
5. Tap .

Related Information

- ➔ [“Placing Originals” on page 49](#)

Setting Up a WSD Port

This section explains how to set up a WSD port for Windows 7/Windows Vista.

Note:

For Windows 10/Windows 8.1/Windows 8, the WSD port is set up automatically.

The following is necessary to set up a WSD port.

- The printer and the computer are connected to the network.
 - The printer driver is installed on the computer.
1. Turn the printer on.
 2. Click start, and then click **Network** on the computer.
 3. Right-click the printer, and then click **Install**.
Click **Continue** when the **User Account Control** screen is displayed.

Scanning

Click **Uninstall** and start again if the **Uninstall** screen is displayed.

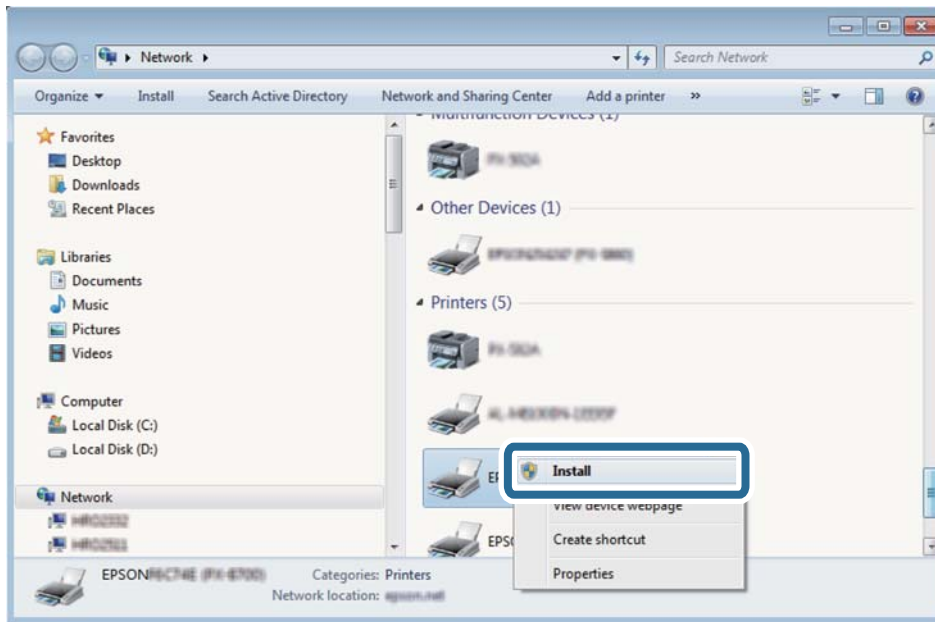

Note:

The printer name you set on the network and model name (EPSON XXXXXX (XX-XXXX)) are displayed on the network screen. You can check the printer's name set on the network from the printer's control panel or by printing a network status sheet.

4. Click **Your device is ready to use**.

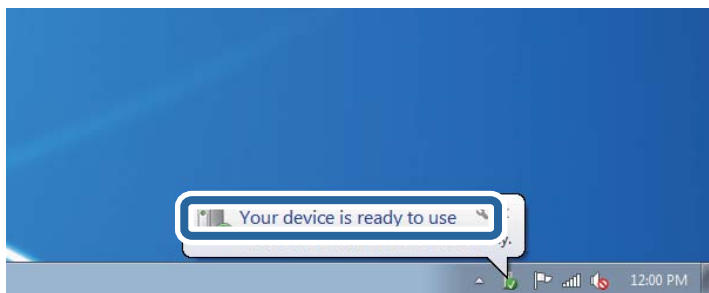

5. Check the message, and then click **Close**.

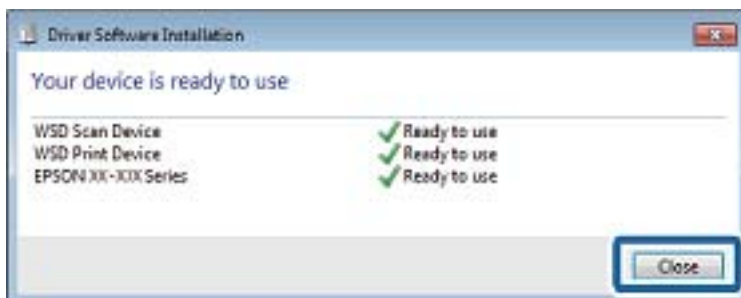

6. Open the **Devices and Printers** screen.

- ❑ Windows 7

Click start > **Control Panel** > **Hardware and Sound** (or **Hardware**) > **Devices and Printers**.

Scanning

- ❑ Windows Vista

Click start > **Control Panel** > **Hardware and Sound** > **Printers**.

7. Check that an icon with the printer's name on the network is displayed.
Select the printer name when using with WSD.

Related Information

- ➔ [“Printing a Network Status Sheet” on page 37](#)

Scanning from a Computer

Scanning Using Epson Scan 2

You can scan using the scanner driver "Epson Scan 2". You can scan originals using detailed settings that are suitable for text documents.

See the Epson Scan 2 help for an explanation of each setting item.

1. Place the original.

Note:

If you want to scan multiple originals, place them in the ADF.

2. Start Epson Scan 2.

Scanning

3. Make the following settings on the **Main Settings** tab.

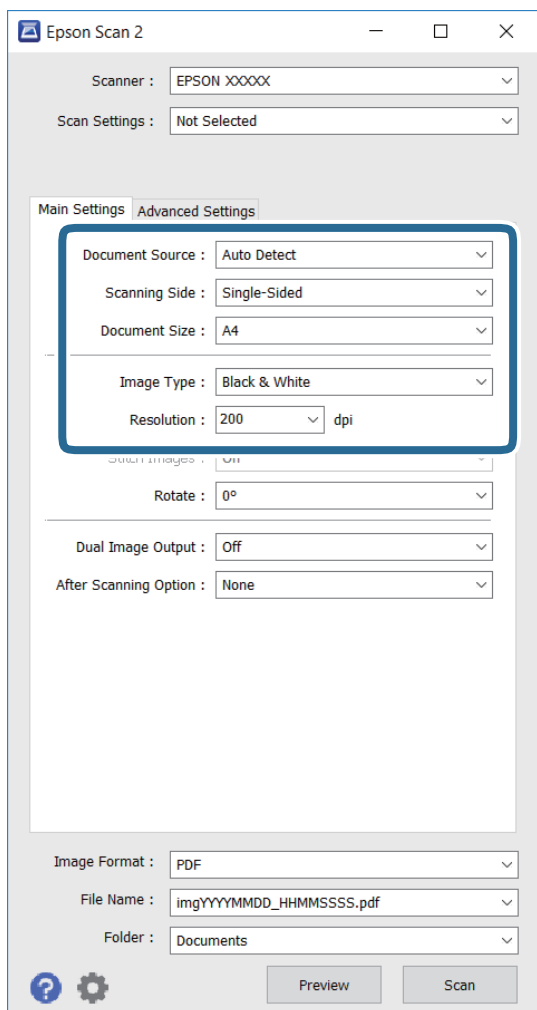

- Document Source:** Select the source where the original is placed.
 - Scanning Side:** Select the side of the original you want to scan when scanning from ADF.
 - Document Size:** Select the size of the original you placed.
 - Image Type:** Select the color for saving the scanned image.
 - Resolution:** Select the resolution.
4. Make other scan settings if necessary.
 - You can preview the scanned image by clicking the **Preview** button. The preview window opens, and the previewed image is displayed.
When you preview using the ADF, the original is ejected from the ADF. Place the ejected original again.

Scanning

- ❑ On the **Advanced Settings** tab, you can make detailed image adjustment settings that are suitable for text documents, such as the following.
 - ❑ **Unsharp Mask:** You can enhance and sharpen the outlines of the image.
 - ❑ **Descreening:** You can remove moiré patterns (web-like shadows) that appear when scanning printed papers such as a magazine.
 - ❑ **Text Enhancement:** You can make blurred letters in the original clear and sharp.
 - ❑ **Auto Area Segmentation:** You can make letters clear and images smooth when performing black and white scanning for a document that contains images.

Note:

The items may not be available depending on other settings you made.

5. Set the file saving settings.

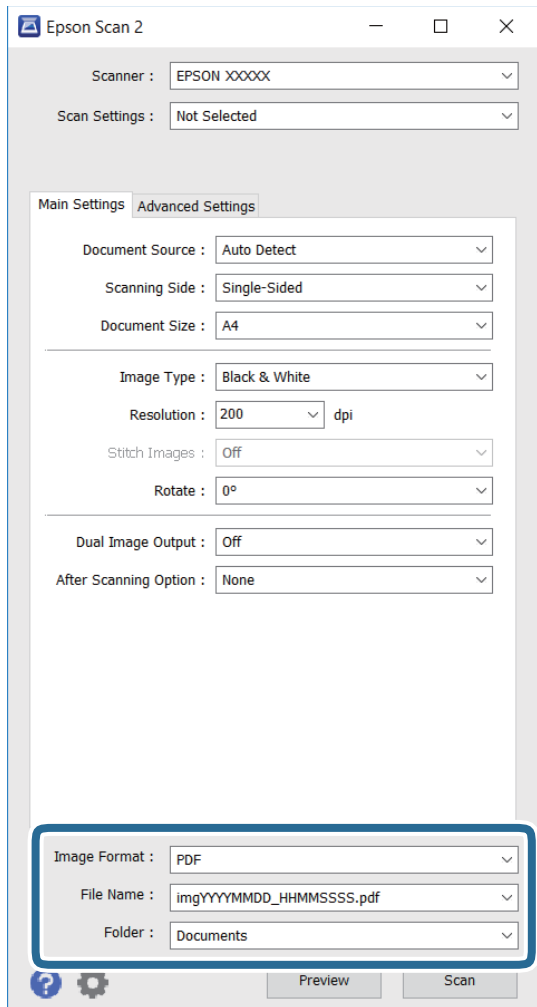

- ❑ **Image Format:** Select the save format from the list.
You can make detailed settings for each save format except BITMAP and PNG. Select **Options** from the list after selecting the save format.
- ❑ **File Name:** Confirm the save file name displayed.
You can change settings for the file name by selecting **Settings** from the list.

Scanning

- ❑ **Folder:** Select the save folder for the scanned image from the list.

You can select another folder or create a new folder by selecting **Select** from the list.

6. Click **Scan**.

Related Information

- ➔ “Placing Originals” on page 49
- ➔ “Epson Scan 2 (Scanner Driver)” on page 166

Scanning from Smart Devices

Epson iPrint is an application that allows you to scan photos and documents from a smart device, such as a smartphone or tablet, that is connected to the same wireless network as your printer. You can save the scanned data on a smart device or to Cloud services, send it by email, or print it.



Installing Epson iPrint

You can install Epson iPrint on your smart device from the following URL or QR code.

<http://ipr.to/c>



Scanning Using Epson iPrint

Start Epson iPrint from your smart device and select the item you want to use from the home screen.

Scanning

The following screens are subject to change without notice.

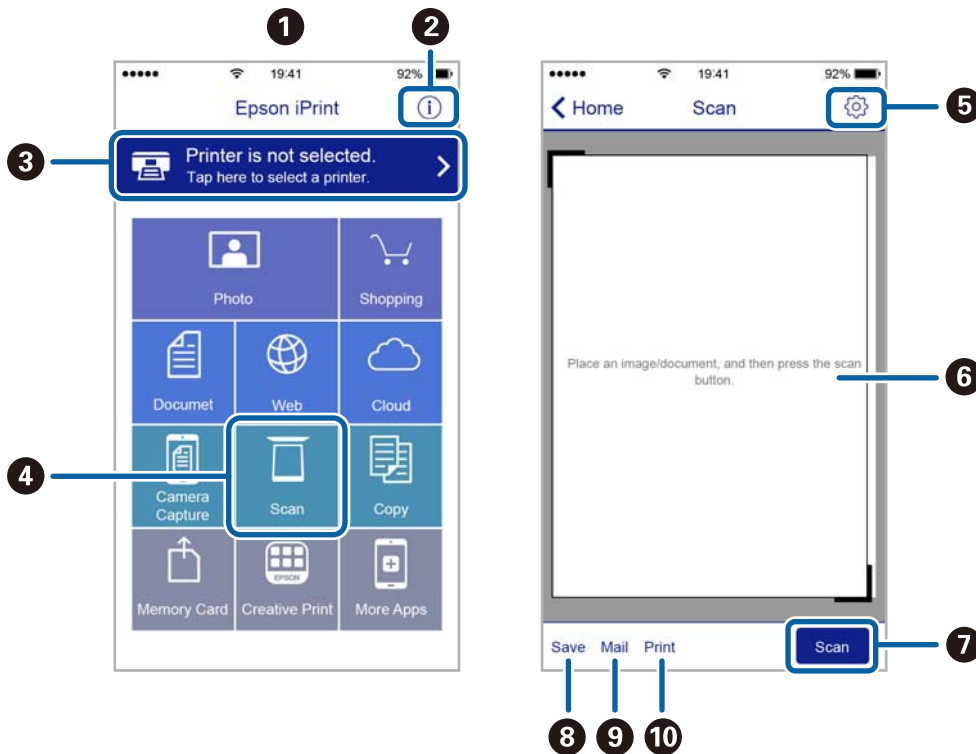

1	Home screen displayed when the application is started.
2	Displays information on how to setup the printer and a FAQ.
3	Displays the screen where you can select the printer and make printer settings. Once you have selected the printer, you do not need to select it again from the next time.
4	Displays the scanning screen.
5	Displays the screen where you can make scan settings such as resolution.
6	Displays scanned images.
7	Starts scanning.
8	Displays the screen where you can save scanned data to a smart device or Cloud services.
9	Displays the screen where you can send scanned data by email.
10	Displays the screen where you can print scanned data.

Scanning by Touching Smart Devices to the NFC Tag

Even if your smart device does not make any settings to use the printer, you can automatically connect it and scan by touching the NFC antenna of a smart device to the printer's NFC Tag.

Make sure that you prepare the followings to use this feature.

- Enable the NFC function on your smart device.
- Epson iPrint is installed on your smart device. If not, touch the NFC tag antenna of the smart device to the printer's NFC Tag to install it.

Scanning

Note:

- ❑ *Android 4.0 or later supports NFC (Near Field Communication)*
- ❑ *The location of the NFC antenna varies depending on the smart device. See the documentation provided with your smart device for more details.*
- ❑ *The printer may not be able to communicate with the smart device when there are obstacles such as metal between the printer's NFC Tag and the NFC antenna of the smart device,*

1. Place the originals in the printer.
2. Touch the NFC antenna of your smart device to the printer's NFC Tag.

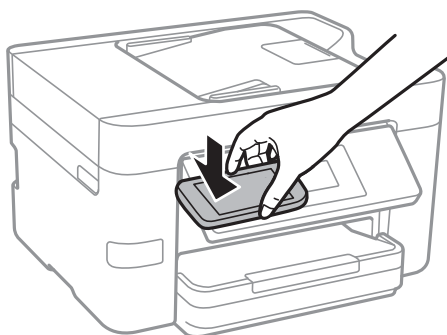

Epson iPrint starts.

3. Select the scan menu in Epson iPrint.
4. Touch the NFC antenna of your smart device to the printer's NFC Tag again.

Scanning starts.

Faxing

Setting Up a Fax

Connecting to a Phone Line

Compatible Telephone Lines

You can use the printer over standard analogue telephone lines (PSTN = Public Switched Telephone Network) and PBX (Private Branch Exchange) telephone systems.

You may not be able to use the printer with the following phone lines or systems.

- VoIP phone line such as DSL or fiber-optic digital service
- Digital phone line (ISDN)
- Some PBX telephone systems
- When adapters such as terminal adapters, VoIP adapters, splitters, or DSL router are connected between the telephone wall jack and the printer

Connecting the Printer to a Phone Line

Connect the printer to a telephone wall jack using an RJ-11 (6P2C) phone cable. When connecting a telephone to the printer, use a second RJ-11 (6P2C) phone cable.

Depending on the area, a phone cable may be included with the printer. If it is included, use that cable.

You may need to connect the phone cable to an adapter provided for your country or region.

Note:

Remove the cap from the EXT. port of the printer only when connecting your telephone to the printer. Do not remove the cap if you are not connecting your telephone.

In areas where lightning strikes occur frequently, we recommend that you use a surge protector.

Connecting to a Standard Phone Line (PSTN) or PBX

Connect a phone cable from the telephone wall jack or PBX port to the LINE port on the back of the printer.

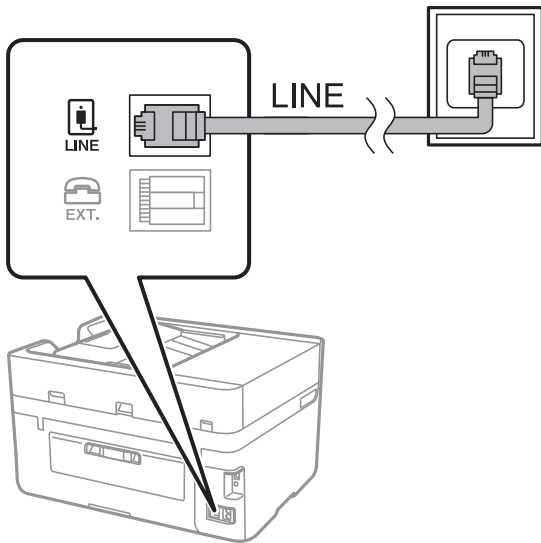
**Related Information**

➔ [“Making Settings for a PBX Phone System” on page 114](#)

Connecting to DSL or ISDN

Connect a phone cable from the DSL modem or the ISDN terminal adapter to the LINE port on the back of the printer. See the documentation provided with the modem or the adapter for more details.

Note:

If your DSL modem is not equipped with a built-in DSL filter, connect a separate DSL filter.

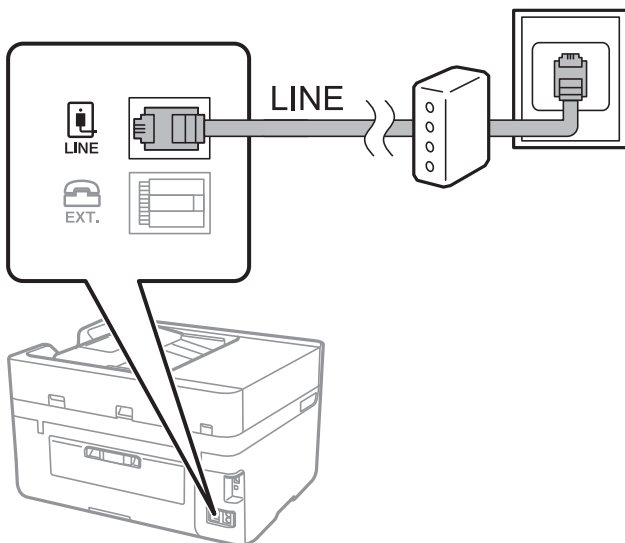
**Connecting Your Phone Device to the Printer**

When using the printer and your telephone on a single phone line, connect the telephone to the printer.

Faxing

Note:

- ❑ If your phone device has a fax function, disable the fax function before connecting. See the manuals that came with the phone device for details.
- ❑ If you connect an answering machine, make sure the printer's **Rings to Answer** setting is set higher than the number of rings your answering machine is set to answer a call.

1. Remove the cap from the EXT. port on the back of the printer.

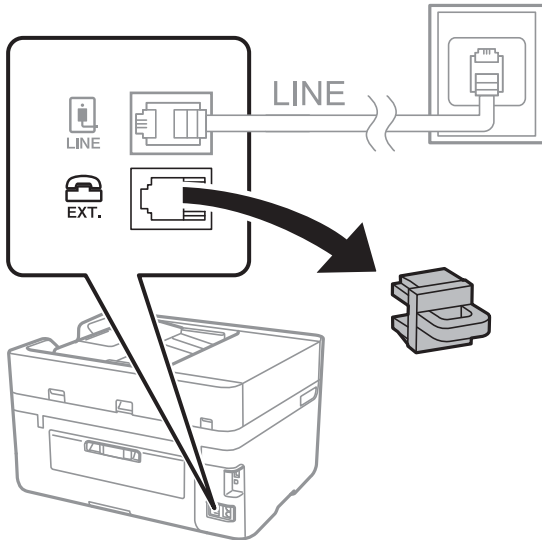

2. Connect the phone device and the EXT. port with a phone cable.

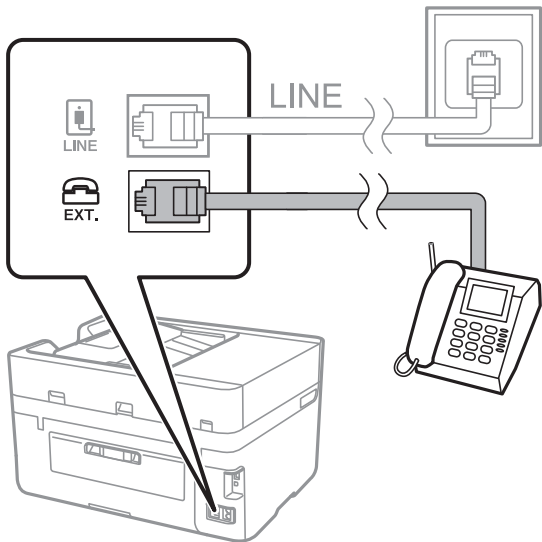
**Note:**

When sharing a single phone line, make sure you connect the phone device to the EXT. port of the printer. If you split the line to connect the phone device and the printer separately, the phone and the printer do not work correctly.

3. Tap **Fax** on the home screen.

Faxing

- Pick up the handset.

The connection is established when  (**Send**) is enabled as the following screen.

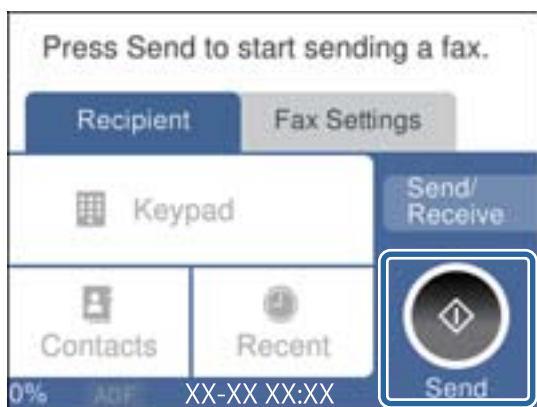

Related Information

➔ [“Making Settings for a PBX Phone System” on page 114](#)

Making Basic Fax Settings

First make basic fax settings such as **Receive Mode** using the **Fax Setting Wizard**, and then configure the other settings as necessary.

The **Fax Setting Wizard** is automatically displayed when the printer is turned on for the first time. Once you have made the settings, you do not need to make them again unless the connection environment is changed.

Making Basic Fax Settings Using the Fax Setting Wizard

Make basic settings by following the on-screen instructions.

- Connect the printer to the phone line.

Note:

Because an automatic fax connection check runs at the end of the wizard, make sure you connect the printer to the phone line before starting the wizard.

- Tap **Settings** on the home screen.
- Tap **General Settings** > **Fax Settings** > **Fax Setting Wizard**.
- On the **Fax Setting Wizard** screen, tap **Proceed**.

The wizard begins.

- On the fax header entry screen, enter the sender name such as your company name, and then tap **OK**.

Note:

Your sender name and your fax number appear as the header for outgoing faxes.

- On the phone number entry screen, enter your fax number, and then tap **OK**.

Faxing

7. On the **Distinctive Ring Detection (DRD) Setting** screen, make the following settings.

- If you have subscribed to a distinctive ring service from your telephone company: Tap **Settings** , and then select the ring pattern to be used for incoming faxes.
 - If you select **All**, go to step 8.
 - If you select any other setting, **Receive Mode** is automatically set to **Auto**. Go to step 10.
- If you do not need to set this option: Tap **Skip**, and then go to step 10.

Note:

- Distinctive ring services, offered by many telephone companies (the service name differs by company), allows you to have several phone numbers on one phone line. Each number is assigned a different ring pattern. You can use one number for voice calls and another for fax calls. Select the ring pattern assigned to fax calls in **DRD**.*
- Depending on the region, **On** and **Off** are displayed as the **DRD** options. Select **On** to use the distinctive ring feature.*

8. On the **Receive Mode Setting** screen, select whether you are using your phone device connected to the printer.

- When connected: Tap **Yes**, and then go to the next step.
- When not connected: Tap **No**, and then go to step 10. **Receive Mode** is set to **Auto**.

9. On the **Receive Mode Setting** screen, select whether you want to receive faxes automatically.

- To receive automatically: Tap **Yes**. **Receive Mode** is set to **Auto**.
- To receive manually: Tap **No**. **Receive Mode** is set to **Manual**.

10. On the **Proceed** screen, check the settings you made, and then tap **Proceed**.

To correct or change settings, tap .

11. Tap **Start Checking** to run the fax connection check, and when the screen prompts you to print the check result, tap **Print**.

A report of the check result that shows the connection status is printed.

Note:

- If there are any errors reported, follow the instructions on the report to solve them.*
- If the **Select Line Type** screen is displayed, select the line type.*
 - *When you are connecting the printer to a PBX phone system or terminal adapter, select **PBX**.*
 - *When you are connecting the printer to a standard phone line (PSTN), select **Disable** on the **Confirmation** screen displayed. However, setting this to **Disable** may cause the printer to skip the first digit of a fax number when dialing and send the fax to the wrong number.*

Related Information

- ➔ [“Connecting the Printer to a Phone Line” on page 109](#)
- ➔ [“Making Settings for a PBX Phone System” on page 114](#)
- ➔ [“Setting Receive Mode” on page 120](#)
- ➔ [“Menu Options for Fax Settings” on page 130](#)

Making Basic Fax Settings Individually

You can make fax settings without using the fax setting wizard by selecting each setting menu individually. The settings configured using the wizard can also be changed. For more details, see the list of menus in fax settings.

Faxing

Related Information

➔ [“Fax Settings” on page 128](#)

Making Settings for a PBX Phone System

Make the following settings when using the printer in offices that use extensions and require external access codes, such as 0 and 9, to get an outside line.

1. Tap **Settings** on the home screen.
2. Tap **General Settings** > **Fax Settings** > **Basic Settings**.
3. Tap **Line Type**, and then tap **PBX**.
4. When sending a fax to an outside fax number using # (hash) instead of the actual external access code, tap the **Access Code** box to make this to **Use**.

The #, entered instead of the actual access code, is replaced with the stored access code when dialing. Using # helps avoid connection problems when connecting to an outside line.

Note:

*You cannot send faxes to recipients in **Contacts** that have external access codes such as 0 and 9.*

*If you have registered recipients in **Contacts** using an external access code such as 0 and 9, set the **Access Code** to **Do Not Use**. Otherwise, you must change the code to # in **Contacts**.*

5. Tap the **Access Code** input box, enter the external access code used for your phone system, and then tap **OK**.
The access code is stored in the printer.

Making Paper Source Settings to Receive Faxes (For Models with Two or More Paper Sources)

You can set the printer so that specific paper sources are not used for printing received documents and fax reports. By default, all of the paper sources are enabled for fax printing. Use this feature if you do not want to use paper in a specific paper source for fax printing.

1. Tap **Settings** on the home screen.
2. Tap **General Settings** > **Printer Settings** > **Paper Source Settings** > **Auto Select Settings** > **Fax**.
3. Tap each box of the paper source that you do not want to use for printing faxes.

The paper source setting is changed to **Off** and is disabled for printing faxes.

Making Information Settings to be Printed on Received Faxes

You can set to print reception information in the footer of the received fax, even if the sender has not set the header information. The reception information includes the received date and time, sender's ID, reception ID (such as "#001"), and page number (such as "P1"). When **Split Page Settings** is enabled, the split page number is also included.

1. Tap **Settings** on the home screen.
2. Tap **General Settings** > **Fax Settings** > **Receive Settings**.

Faxing

3. Tap **Print Settings**, and then tap the **Add Reception Information** to set this to **On**.

Related Information

➔ [“Print Settings” on page 131](#)

Making Settings to Print Received Faxes on 2-Sides

You can print multiple pages of received documents on both sides of the paper.

1. Tap **Settings** on the home screen.
2. Tap **General Settings** > **Fax Settings** > **Receive Settings**.
3. Tap **Print Settings**, and then tap **2-Sided**.
4. Tap the **2-Sided** box to set this to **On**.
5. In **Binding(Copy)**, select **Short Side** or **Long Side**.
6. Tap **OK**.

Related Information

➔ [“Print Settings” on page 131](#)

Making Settings to Print Received Faxes by Splitting Pages

Make split page settings when the size of the received document is larger than the size of the paper loaded in the printer.

1. Tap **Settings** on the home screen.
2. Tap **General Settings** > **Fax Settings** > **Receive Settings**.
3. Tap **Print Settings** > **Split Page Settings** > **Delete Print Data After Split**.
4. Select the options for deleting print data after splitting.
5. If you select **Off** in step 4, tap **OK** and go to step 7. If you select **Delete Top** or **Delete Bottom**, go to step 6.
6. In **Threshold**, set the threshold, and then tap **OK**.
7. Tap **Overlap When Split**.
8. Tap the **Overlap When Split** box to set this to **On**.
9. In **Overlapping Width**, set the width, and then tap **OK**.

Related Information

➔ [“Print Settings” on page 131](#)

Sending Faxes

Basic Fax Sending Operations

Send faxes in color or monochrome (B&W).

Note:

When sending a fax in monochrome, you can preview the scanned image on the LCD screen before sending.

Sending Fax Using the Control Panel

You can enter fax numbers for recipients and send faxes by using the control panel. The printer automatically dials the recipients and sends the fax.

Note:

When sending a fax in monochrome, you can preview the scanned image on the LCD screen before sending.

If the fax number is busy or a problem occurs, the printer automatically redials twice after one minute.

1. Place the originals.

Note:

You can send up to 100 pages in one transmission; however depending on the remaining amount of memory, you may not be able to send faxes even with less than 100 pages.

2. Tap **Fax** on the home screen.

3. Specify the recipient.

You can send the same monochrome fax to up to 100 recipients or 99 groups in **Contacts**. However, a color fax can only be sent to one recipient at a time.

To enter manually: Tap **Keypad**, enter a fax number on the screen displayed, and then tap **OK**.

- To add a pause (pause for three seconds during dialing), enter a hyphen(-).

- If you have set an external access code in **Line Type**, enter "#" (hash) instead of the actual external access code at the beginning of the fax number.

To select from the contacts list: Tap **Contacts** and add a check mark to a contact. If the recipients you want to send has not registered in **Contacts** yet, you can register the recipient first by tapping **Add Entry**.

To select from the sent fax history: Tap **Recent**, and then select a recipient.

Note:

*When **Direct Dialing Restrictions** in **Security Settings** is enabled, you can only select fax recipients from the contacts list or the sent fax history. You cannot manually enter a fax number.*

To delete recipients you entered, display the list of recipients by tapping on the field of a fax number or the number of recipients on the LCD screen, select the recipient from the list, and then select **Remove**.

4. Tap the **Fax Settings** tab, and then make settings such as the resolution and the sending method as necessary.

Note:

Tap  on the fax top screen to save the current settings and the recipients in **Preset**.

Faxing

- When sending a fax in monochrome, tap **Preview** on the **Recipient** tab to confirm the scanned document.

To send the fax as is, tap **Start Sending**, and then go to step 7. Otherwise, cancel the preview by tapping **Cancel**, and then go to step 3.

: Moves the screen in the direction of the arrows.

: Reduces or enlarges.

: Moves to the previous or the next page.

Note:

- You cannot send the fax in color after previewing.
- When **Direct Send** is enabled, you cannot preview.
- When the preview screen is left untouched for 20 seconds, the fax is sent automatically.
- The image quality of a sent fax may be different from what you previewed depending on the capability of the recipient machine.

- Tap .

Note:

- To cancel sending, tap .
- It takes longer to send a fax in color because the printer performs scanning and sending simultaneously. While the printer is sending a fax in color, you cannot use the other features.

- When sending is complete, remove the originals.

Related Information

- ➔ [“Registering Your Favorite Settings as a Preset” on page 22](#)
- ➔ [“Managing Contacts” on page 53](#)
- ➔ [“Placing Originals” on page 49](#)
- ➔ [“Menu Options for Fax Mode” on page 128](#)

Sending Faxes Dialing from the External Phone Device

You can send a fax by dialing using the connected telephone when you want to talk over the phone before sending a fax, or when the recipient's fax machine does not switch to the fax automatically.

- Place the originals.

Note:

You can send up to 100 pages in one transmission.

- Pick up the handset of the connected telephone, and then dial the recipient's fax number using the phone.
- Tap **Fax** on the home screen.
- Tap the **Fax Settings** tab, and then make settings such as the resolution and the sending method as necessary.

Faxing

5. When you hear a fax tone, tap , and then hang up the handset.

Note:

When a number is dialed using the connected telephone, it takes longer to send a fax because the printer performs scanning and sending simultaneously. While sending the fax, you cannot use the other features.

6. When sending is complete, remove the originals.

Related Information

- ➔ [“Placing Originals” on page 49](#)
- ➔ [“Fax Settings” on page 128](#)

Various Ways of Sending Faxes

Sending Many Pages of a Monochrome Document (Direct Send)

When sending a fax in monochrome, the scanned document is temporarily stored in the printer's memory. Therefore, sending a lot of pages may cause the printer to run out of memory and stop sending the fax. You can avoid this by enabling the **Direct Send** feature, however, it takes longer to send the fax because the printer performs scanning and sending simultaneously. You can use this feature when there is only one recipient.

Tap **Fax** on the home screen, tap the **Fax Settings** tab, and then tap the **Direct Send** box to set this to **On**.

Related Information

- ➔ [“Placing Originals” on page 49](#)
- ➔ [“Fax Settings” on page 128](#)

Sending Faxes at a Specified Time (Send Fax Later)

You can set to send a fax at a specified time. Only monochrome faxes can be sent when the time to send is specified.

1. Tap **Fax** on the home screen.
2. Specify the recipient.
3. Tap the **Fax Settings** tab.
4. Tap **Send Fax Later**, and then tap the **Send Fax Later** box to set this to **On**.
5. Tap the **Time** box, enter the time you want to send the fax, and then press **OK**.
6. Tap **OK** to apply the settings.

Note:

*You cannot send another fax until the fax has been sent at the specified time. If you want to send another one, you need to cancel the scheduled fax by tapping **Fax** on the home screen, and then deleting it.*

Faxing

Related Information

- ➔ [“Placing Originals” on page 49](#)
- ➔ [“Sending Fax Using the Control Panel” on page 116](#)
- ➔ [“Fax Settings” on page 128](#)

Sending a Fax with a Selected Header

You can send a fax with sender information that is suitable for the recipient. You need to register multiple headers of sender information in advance in the printer by following the steps below.

Registering Multiple Headers for Sending Faxes

You can register up to 21 fax headers as sender information.

1. Tap **Settings** on the home screen.
2. Tap **General Settings** > **Fax Settings** > **Basic Settings**.
3. Tap **Header**, tap the **Your Phone Number** box, enter your phone number, and then tap **OK**.
4. Tap one of the boxes under the **Fax Header** list, enter the fax header information, and then tap **OK**.

Related Information

- ➔ [“Fax Settings” on page 128](#)

Sending a Fax with a Selected Header

When you send a fax, you can select header information for the recipient. To use this feature, you must register multiple headers in advance.

1. Tap **Fax** on the home screen.
2. Tap **Fax Settings** > **Add Sender Information**.
3. Select where you want to add your sender information.
 - Off**: Sends a fax with no header information.
 - Outside of Image**: Sends a fax with header information in the top white margin of the fax. This keeps the header from overlapping with the scanned image, however, the fax received by the recipient may be printed across two sheets depending on the size of the originals.
 - Inside of Image**: Sends a fax with header information approximately 7 mm lower than the top of the scanned image. The header may overlap with the image, however, the fax received by the recipient will not be split into two documents.
4. Tap the **Fax Header** box, and then select the header you want to use.
5. Tap one of the **Additional Information** options as necessary.
6. Tap **OK** to apply the settings.

Faxing

Related Information

➔ [“Fax Settings” on page 128](#)

Sending Different Size Documents Using ADF (ADF Continuous Scan)

If you place different sized originals in the ADF, all of the originals are sent at the largest size among them. You can send them in their original sizes by sorting and placing them by size, or placing them one by one.

Before placing originals, make the following setting.

Tap **Fax** on the home screen, tap the **Fax Settings** tab, and then tap the **ADF Continuous Scan** box to set this to **On**. Follow the on-screen instructions to place originals.

The printer stores the scanned documents, and sends as one document.

Note:

If you leave the printer untouched for 20 seconds after prompted to set the next originals, the printer stops storing and starts sending the document.

Related Information

➔ [“Fax Settings” on page 128](#)

Sending a Fax from a Computer

You can send faxes from the computer by using the FAX Utility and PC-FAX driver. See the help of FAX Utility and PC-FAX driver for the operating instructions.

Related Information

➔ [“PC-FAX Driver \(Fax Driver\)” on page 167](#)

➔ [“FAX Utility” on page 167](#)

Receiving Faxes

Setting Receive Mode

You can set **Receive Mode** using the **Fax Setting Wizard**. When you set up the fax feature for the first time, we recommend using the **Fax Setting Wizard**. If you want to change the **Receive Mode** settings individually, follow the steps below.

1. Tap **Settings** on the home screen.
2. Tap **General Settings** > **Fax Settings** > **Basic Settings** > **Receive Mode**.

Faxing

3. Select how to receive.

- For users who want to receive a fax after answering calls with the connected telephone, or who do not fax often: Select **Manual**. The printer never automatically receives faxes and allows you to answer the phone for voice calls, or operate the printer to receive the fax.

Note:

*If you enable the **Remote Receive** feature, you can start receiving a fax just by using the connected telephone.*

- For users who use a phone line for the printer (fax) only: Select **Auto** mode. The printer automatically receives a fax after the number of rings you specified.

Related Information

- ➔ [“Making Basic Fax Settings Using the Fax Setting Wizard” on page 112](#)
- ➔ [“Receiving Faxes Manually” on page 121](#)
- ➔ [“Receiving Faxes Using a Connected Telephone \(Remote Receive\)” on page 122](#)

Settings for the Answering Machine

You need settings to use an answering machine.

- Set the **Receive Mode** of the printer to **Auto**.
- Set the **Rings to Answer** setting of the printer to a higher number than the number of rings for the answering machine. Otherwise, the answering machine cannot receive voice calls to record voice messages. See the manuals that came with the answering machine for its settings.

The **Rings to Answer** setting may not be displayed depending on the region.

Related Information

- ➔ [“Basic Settings” on page 133](#)

Various Ways of Receiving Faxes

Receiving Faxes Manually

When you connect a telephone and set the **Receive Mode** setting of the printer to **Manual**, follow the steps below to receive faxes.

1. When the telephone rings, pick up the handset.
2. When you hear a fax tone, tap **Fax** on the home screen of the printer.

Note:

*If you enable the **Remote Receive** feature, you can start receiving a fax just by using the connected telephone.*

3. Tap **Send/Receive**.
4. Tap **Recv**.
5. Tap , and then hang up the handset.

Faxing

Related Information

- ➔ [“Making Paper Source Settings to Receive Faxes \(For Models with Two or More Paper Sources\)”](#) on page 114
- ➔ [“Receiving Faxes Using a Connected Telephone \(Remote Receive\)”](#) on page 122
- ➔ [“Saving Received Faxes in the Inbox”](#) on page 124

Receiving Faxes Using a Connected Telephone (Remote Receive)

To receive a fax manually, you need to operate the printer after you pick up the handset of the telephone. By using the **Remote Receive** feature, you can start receiving a fax just by operating the phone.

The **Remote Receive** feature is available for telephones that support tone dialing.

Related Information

- ➔ [“Receiving Faxes Manually”](#) on page 121

Setting Up Remote Receive

1. Tap **Settings** on the home screen.
2. Tap **General Settings** > **Fax Settings** > **Basic Settings** > **Remote Receive**.
3. After enabling **Remote Receive**, enter a two digit code (0 to 9, *, and # can be entered) in the **Start Code** field.
4. Tap **OK**, and then tap **OK** again.

Related Information

- ➔ [“Basic Settings”](#) on page 133

Using Remote Receive

1. When the telephone rings, pick up the handset.
2. When you hear a fax tone, enter the start code using the telephone.
3. After confirming that the printer has started receiving the fax, hang up the handset.

Receiving Faxes by Polling (Polling Receive)

You can receive a fax stored on another fax machine by dialing the fax number. Use this feature to receive a document from a fax information service. However, if the fax information service has an audio guidance feature that you need to follow to receive a document, you cannot use this feature.

Note:

To receive a document from a fax information service that uses audio guidance, just dial the fax number using the connected telephone, and operate the phone and the printer following the audio guidance.

1. Tap **Fax** on the home screen.

Faxing

2. Tap .
3. Tap the **Polling Receive** box to set this to **On**.
4. Tap **Close**.
5. Enter the fax number.

Note:

When *Direct Dialing Restrictions in Security Settings* is enabled, you can only select fax recipients from the contact list or the sent fax history. You cannot manually enter a fax number.

6. Tap .

Related Information

➔ [“Sending Faxes Dialing from the External Phone Device” on page 117](#)

Making Settings for Blocking Junk Faxes

You can block junk faxes.

1. Tap **Settings** on the home screen.
2. Tap **General Settings** > **Fax Settings** > **Basic Settings** > **Rejection Fax**.
3. Tap **Rejection Fax** and then enable the following options.
 - Rejection Number List: Reject faxes that are in the Rejection Number List.
 - Fax Header Blank: Reject faxes that have blank header information.
 - Unregistered Contacts: Reject fax that have not been registered in the contact list.
4. If you use the **Rejection Number List**, tap , and then tap **Edit Blocked Number list** and edit the list.

Related Information

➔ [“Basic Settings” on page 133](#)

Saving of Received Faxes

The printer provides the following features to save received faxes.

- Saving in the printer's inbox
- Saving in an external memory device
- Saving on a computer

Note:

- The above features can be used at the same time. If you do use them all at the same time, received documents are saved to the inbox, to an external memory device, and on a computer.
- When there are received documents that have not been read or saved yet, the number of the unprocessed jobs is displayed on the  on the home screen.

Faxing

Related Information

- ➔ [“Saving Received Faxes in the Inbox” on page 124](#)
- ➔ [“Saving Received Faxes in an External Memory Device” on page 125](#)
- ➔ [“Saving Received Faxes on a Computer” on page 126](#)

Saving Received Faxes in the Inbox

You can set to save received faxes in the printer's inbox. Up to 100 documents can be saved. If you use this feature, received documents are not automatically printed. You can view them on the printer's LCD screen and print only when needed.

Note:

Saving 100 documents may not be possible depending on the usage conditions such as the file size of saved documents, and using of multiple fax saving features at a time.

Related Information

- ➔ [“Checking the Received Faxes on the LCD Screen” on page 124](#)

Setting to Save Received Faxes in the Inbox

1. Tap **Settings** on the home screen.
2. Tap **General Settings** > **Fax Settings** > **Receive Settings** > **Fax Output Settings**.
3. If a confirmation message is displayed, confirm it, and then tap **OK**.
4. Tap **Save to Inbox**.
5. Tap **Save to Inbox** to set this to **On**
6. Tap **Options when memory is full**, select the option to use when the inbox is full, and then tap **Close**.
 - Receive and print faxes:** The printer prints all received documents that cannot be saved in the Inbox.
 - Reject incoming faxes:** The printer does not answer incoming fax calls.
7. You can set a password for the inbox. Tap **Inbox Password Settings**, and then set the password.

Note:

*You cannot set a password when **Receive and print faxes** is selected.*

Checking the Received Faxes on the LCD Screen

1. Tap on the  on the home screen.

Note:



When there are received faxes that have not been read, the number of unread documents is displayed on the  on the home screen.

2. Tap **Open Inbox (XX Unread)**.

Faxing

- If the inbox has been password protected, enter the inbox password.
- Select the fax you want to view from the list.

The contents of the fax are displayed.

- : Moves the screen in the direction of the arrows.
 - : Reduces or enlarges.
 - : Moves to the previous or the next page.
 - To hide the operation icons, tap anywhere on the preview screen except for the icons. Tap again to display the icons.
- Select whether to print or delete the document you have viewed, and then follow the on-screen instructions.



Important:

If the printer runs out of memory, receiving and sending faxes is disabled. Delete documents that you have already read or printed.

Related Information

- ➔ [“Setting to Save Received Faxes in the Inbox” on page 124](#)

Saving Received Faxes in an External Memory Device

You can set to convert received documents into PDF format and save them in an external memory device connected to the printer. You can also set to automatically print the documents while saving them in the memory device.



Important:

Received documents are saved in the printer's memory temporarily before the documents are saved in the memory device connected to the printer. Because a memory full error disables sending and receiving faxes, keep the memory device connected to the printer. The number of documents that have temporarily saved in the printer's memory is displayed on  on the home screen.

- Connect an external memory device to the printer.
- Tap **Settings** on the home screen.
- Tap **General Settings** > **Fax Settings** > **Receive Settings** > **Fax Output Settings**.
- If a message is displayed, check the content, and then tap **OK**.
- Tap **Save to Memory Device**.
- Select **Yes**. To print the documents automatically while saving them in the memory device, select **Yes and Print**.
- Check the message on the screen and then tap **Create**.
A folder for saving received documents is created in the memory device.

Related Information

➔ [“Fax Output Settings” on page 131](#)

Saving Received Faxes on a Computer

You can set to convert received documents into PDF format and save them on a computer connected to the printer. You can also set to automatically print the documents while saving them on the computer.

You need to use FAX Utility to make the setting. Install FAX Utility on the computer.

The Windows FAX Utility instructions differ depending on the version being used. This document provides the instructions for Version 1.XX. For Windows FAX Utility Version 2.XX, see **Basic Operations** in the FAX Utility Online Help. To check which version you are using, right-click the FAX Utility title bar, and then click **Version Information**.

Note:

- Set the printer's receive mode to **Auto**.
- Received documents are saved in the printer's memory temporarily before the documents are saved on the computer that is set to save the faxes. Because a memory full error disables sending and receiving faxes, keep the computer that is set to save the faxes turned on. The number of documents that have been temporarily saved in the printer's memory is displayed on the  on the home screen.

1. Start FAX Utility on the computer connected to the printer.
2. Open the setting screen of FAX Utility.
 - Windows**
Select **Fax Settings for Printer > Received Fax Output Settings**.
 - Mac OS X**
Click **Fax Receive Monitor**, select the printer, and then click **Receive Settings**.
3. Click **Save faxes on this computer**, and specify the folder to save received documents.
4. Make the other settings as necessary.

Note:

For details on the setting items and the procedure, see the FAX Utility help settings screen.

5. Send the settings information to your printer.
 - Windows**
Click **OK**.
 - Mac OS X**
Click **Send**.

If you want to save and print at the same time, go to the next step.

6. On the printer's control panel, tap **Settings > General Settings > Fax Settings > Receive Settings**.
7. Tap **Fax Output Settings > Save to Computer**, and then select **Yes and Print**.

Note:

*To stop saving received document on the computer, set **Save to Computer** to **No**. You can also use FAX Utility to change the setting, however, changing from FAX Utility is not allowed while there are received faxes that have not been saved on the computer.*

Related Information

- ➔ [“Setting Receive Mode” on page 120](#)
- ➔ [“FAX Utility” on page 167](#)

Using Other Faxing Features

Printing Fax Report and List

Printing Fax Report Manually

1. Tap **Fax** on the home screen.
2. Tap  (More).
3. Tap **Fax Report**.
4. Select the report you want to print, and then follow the on-screen instructions.

Note:

You can change the report format. From the home screen, select **Settings > General Settings > Fax Settings > Report Settings**, and then change the **Attach Fax image to report** or **Report Format** settings.

Related Information

- ➔ [“Print Settings” on page 131](#)
- ➔ [“Report Settings” on page 133](#)

Setting Up to Print Fax Reports Automatically

You can make settings to print the following fax reports automatically.

Transmission Report

From the home screen, tap **Fax > Fax Settings > Transmission Report**, and then select **Print** or **Print on Error**.

Fax Log

From the home screen, tap **Settings > General Settings > Fax Settings > Report Settings > Fax Log Auto Print**, and then select **On(Every 30)** or **On(Time)**.

Related Information

- ➔ [“Report Settings” on page 133](#)
- ➔ [“Menu Options for User Settings” on page 134](#)

Setting Security for Faxing

You can make security settings to prevent sending a fax to the wrong recipient, or prevent received documents from being leaked or lost. You can also delete backed-up fax data.

1. Tap **Settings** on the home screen.
2. Tap **General Settings** > **Fax Settings** > **Security Settings**.
3. Select the menu, and then make the settings.

Related Information

➔ [“Security Settings” on page 134](#)

Menu Options for Fax Mode

Recipient

Select the menus on the control panel as described below.

Fax > Recipient

- Keypad
Manually enter a fax number.
- Contacts
Select a recipient from the contacts list. You can also add or edit a contact.
- Recent
Select a recipient from the sent fax history. You can also add the recipient to the contacts list.

Fax Settings

Select the menus on the control panel as described below.

Fax > Fax Settings

Scan Settings:

- Original Size (Glass)
Select the size and orientation of the original you placed on the scanner glass.
- Color Mode
Select whether to scan in color or in monochrome.
- Resolution
Select the resolution of the outgoing fax.

Faxing

- Density
Sets the density of the outgoing fax.
- Remove Background
Detects the paper color (background color) of the original document, and removes or lightens the color. Depending on the darkness and vividness of the color, it may not be removed or lightened
- ADF Continuous Scan
When sending a fax from the ADF, you cannot add originals in the ADF after starting scanning. If you place different sized originals in the ADF, all of the originals are sent at the largest size among them. Enable this option so that the printer asks if you want to scan another page after an original in the ADF has finished scanning. Then you can sort and scan your originals by size and send them as a single fax.

Fax Send Settings:

- Direct Send
Sends monochrome faxes to a single recipient as soon as the connection is made, without saving the scanned image to memory. If you do not enable this option, the printer starts the transmission after saving the scanned image to memory and may cause a memory full error when sending many pages. By using this option, you can avoid the error, but it takes longer to send the fax. You cannot use this option when sending a fax to multiple recipients.
- Send Fax Later
Sends a fax at a time you specified. Only a monochrome fax is available when using this option.
- Add Sender Information
 - Add Sender Information:
Select the position where you want to include the header information (sender name and fax number) in the outgoing fax, or not to include the information.
Select **Off** to send a fax with no header information.
Select **Outside of Image** to send a fax with header information in the top white margin of the fax. This keeps the header from overlapping with the scanned image, however, the fax received by the recipient may be printed across two sheets depending on the size of the originals.
Select **Inside of Image** to send a fax with header information approximately 7 mm lower than the top of the scanned image. The header may overlap with the image, however, the fax received by the recipient will not be split into two documents.
 - Fax Header:
Select the header for the recipient. To use this feature, you should register multiple headers in advance.
 - Additional Information:
Select the information you want to add.
- Transmission Report
Prints a transmission report automatically after you send a fax. Select **Print on Error** to print a report only when an error occurs.
- Clear All Settings
Restores all settings in **Fax Settings** to their defaults.

More

Select the menus on the control panel as described below.

Fax >  (More)

Transmission History:

You can check the history of sent or received fax jobs.

Fax Report:

Last Transmission

Prints a report for the previous fax that was sent or received through polling.

Fax Log

Prints a transmission report. You can set to print this report automatically using the following menu.

Settings > General Settings > Fax Settings > Report Settings > Fax Log Auto Print

Fax Settings List

Prints the current fax settings.

Protocol Trace

Prints a detailed report for the previous fax that was sent or received.

Polling Receive:

Connects to the fax number you entered and receives a fax stored on the fax machine. You can use this option for receiving a fax from a fax information service.

Inbox:

Opens the inbox where the received faxes are stored.

Reprint Faxes:

Prints the received faxes again.

Fax Settings:

Opens **Fax Settings**. You can also access this screen by tapping **Settings** on the home screen, and then tapping **General Settings > Fax Settings**. For more details, see the page that describes the **Fax Settings** feature.

Related Information

➔ [“Menu Options for Fax Settings” on page 130](#)

Menu Options for Fax Settings

Select the menus on the control panel as described below.

Settings > General Settings > Fax Settings

Faxing

Check Fax Connection

Select the menus on the control panel as described below.

Settings > General Settings > Fax Settings > Check Fax Connection

Checks if the printer is connected to the phone line and ready for fax transmission, and prints the check result on A4 size plain paper.

Fax Setting Wizard

Select the menus on the control panel as described below.

Settings > General Settings > Fax Settings > Fax Setting Wizard

Select to make basic fax settings by following the on-screen instructions. For details, see the page that describes basic fax settings.

Receive Settings

Select the menus on the control panel as described below.

Settings > General Settings > Fax Settings > Receive Settings

Fax Output Settings

You can set to save received documents in the inbox, on a memory device, or on a computer. Select the menus on the control panel as described below.

Save to Inbox:

Saves received faxes in the printer's inbox.

Save to Computer:

Converts received documents into PDF format and saves them on a computer connected to the printer.

Save to Memory Device:

Converts received documents into PDF format and saves them to an external memory device connected to the printer.

Print Settings

Select the menus on the control panel as described below.

Auto Reduction:

Reduces large received documents to fit on the paper in the paper source. Reducing may not always be possible depending on the received data. If this is turned off, large documents are printed at their original size on multiple sheets, or a blank second page may be ejected.

Faxing

Split Page Settings:

Make split page settings when the size of the received document is larger than the size of the paper loaded in the printer.

Auto Rotation:

Rotates faxes received as landscape-orientated, A5 size documents so that they are printed on the correct paper size.

For models with two or more paper sources:

This setting is applied when the paper size setting for at least one paper source used for printing faxes is set to A5. Check the paper source settings for printing faxes and paper size for the paper sources in the following menus.

Settings > General Settings > Printer Settings > Paper Source Settings > Auto Select Settings Settings > General Settings > Printer Settings > Paper Source Settings > Paper Setting

For models with one paper source:

This setting is applied when the paper size setting is set to A5. Check the following menu.

Settings > General Settings > Printer Settings > Paper Source Settings > Paper Setting

Add Reception Information:

Prints reception information in the header of the received fax, even if the sender does not set the header information. The reception information includes the received date and time, sender's ID, reception ID (such as "#001"), and page number (such as "P1"). When **Split Page Settings** is enabled, the split page number is also included.

2-Sided:

You can print multiple pages of received documents on both sides of the paper.

Print Start Timing:

Select options to start printing the received documents.

All Pages Received: After receiving all of the pages, printing starts from the first page.

First Page Received: Starts printing when the first page is received, and then prints in order as the pages are received. If the printer cannot start printing, such as when it is printing other jobs, the printer starts printing received pages as a batch when it is available.

Collation Stack:

Prints received documents from the last page (print in descending order) so that the printed documents are stacked in the correct page order. When the printer is running low on memory, this feature may not be available.

Print Suspend Time:

Saves documents received during the specified time period in the printer's memory without printing them. At the time specified to restart printing, the documents are automatically printed. This feature can be used for noise prevention at night or to prevent confidential documents from being disclosed while you are away. Before using this feature, make sure there is enough free memory.

Quiet Mode:

Reduces the noise the printer makes when printing faxes, however, print speed may be reduced.

Report Settings

Select the menu on the control panel as described below.

Settings > General Settings > Fax Settings > Report Settings

Fax Log Auto Print:

Prints the fax log automatically. Select **On(Every 30)** to print a log every time 30 fax jobs are completed. Select **On(Time)** to print the log at a specified time. However, if the number of fax jobs exceeds 30, the log is printed before the specified time.

Attach Fax image to report:

Prints a **Transmission Report** with an image of the first page of the sent document. Select **On(Large Image)** to print the upper part of the page without reducing. Select **On(Small Image)** to print the entire page reducing it to fit onto the report.

Report Format:

Select a format for fax reports. Select **Detail** to print with error codes.

Basic Settings

Select the menus on the control panel as described below.

Settings > General Settings > Fax Settings > Basic Settings

Fax Speed:

Select the fax transmission speed. We recommend selecting **Slow(9,600bps)** when a communication error occurs frequently, when sending/receiving a fax to/from abroad, or when you are using an IP (VoIP) phone service.

ECM:

Automatically corrects errors in the fax transmission (Error Correction Mode), mostly caused by telephone line noise. If this is disabled, you cannot send or receive documents in color.

Dial Tone Detection:

Detects a dial tone before starting to dial. If the printer is connected to a PBX (Private Branch Exchange) or digital phone line, the printer may fail to start dialing. In this situation, change the **Line Type** setting to **PBX**. If this does not work, disable this feature. However, disabling this feature may drop the first digit of a fax number and send the fax to the wrong number.

Line Type:

Select the line type to which you have connected the printer. When using the printer in an environment that uses extensions and requires an external access code, such as 0 and 9, to get an outside line, select **PBX** and register the access code. Once you have registered the access code, enter # (hash) instead of the access code when sending a fax to an outside fax number. For an environment that uses a DSL modem or terminal adapter, setting to **PBX** is also recommended.

Header:

Enter your sender name and fax number. These appear as a header on outgoing faxes. You can enter up to 40 characters for your name, and up to 20 digits for your fax number.

Faxing

Receive Mode:

Select the receive mode.

DRD:

If you have subscribed to a distinctive ring service from your telephone company, select the ring pattern to be used for incoming faxes. The distinctive ring service, offered by many telephone companies (the service name differs by company), allows you to have several phone numbers on one phone line. Each number is assigned different ring pattern. You can use one number for voice calls and another for fax calls. Depending on the region, this option may be **On** or **Off**.

Rings to Answer:

Select the number of rings that must occur before the printer automatically receives a fax.

Remote Receive:

When you answer an incoming fax call on a phone connected to the printer, you can start receiving the fax by entering the code using the phone.

Rejection Fax:

Select options to reject junk faxes.

Security Settings

Select the menus on the control panel as described below.

Settings > General Settings > Fax Settings > Security Settings

Direct Dialing Restrictions:

Enable this to disable the manual entry of recipient's fax numbers allowing the operator to select recipients only from the contacts list or sent history. Select **Enter Twice** to require the operator to enter the fax number again when the number was manually entered.

Confirm Address List:

Displays a recipient confirmation screen before starting the transmission.

Backup Data Auto Clear:

To prepare for an unexpected power off due to an electricity failure or an incorrect operation, the printer temporarily stores backup copies of sent and received documents in its memory. Enable this option to automatically erase the backups when sending or receiving a document completes successfully and the backups become unnecessary.

Clear Backup Data:

Erases all backup copies temporarily stored in the printer's memory. Run this before you give the printer to someone else or dispose of it.

Menu Options for User Settings

Select the menus on the control panel as described below.

Faxing

Settings > User Settings > Fax

The settings made in this menu become your default settings for sending faxes. For explanations on the setting items, see the **Fax Settings** in Fax mode.

Menu Options for Inbox

Tap  on the home screen.

Replacing Ink Cartridges and Other Consumables

Checking the Status of the Remaining Ink and the Maintenance Box

You can check the approximate ink levels and the approximate service life of the maintenance box from the control panel or the computer.

Checking the Status of the Remaining Ink and the Maintenance Box - Control Panel

Tap  on the home screen.

Checking the Status of the Remaining Ink and the Maintenance Box - Windows

1. Access the printer driver window.
2. Click **EPSON Status Monitor 3** on the **Maintenance** tab, and then click **Details**.

Note:

*If EPSON Status Monitor 3 is disabled, click **Extended Settings** on the **Maintenance** tab, and then select **Enable EPSON Status Monitor 3**.*

Related Information

➔ [“Windows Printer Driver” on page 163](#)

Checking the Status of the Remaining Ink and the Maintenance Box - Mac OS X

1. Select **System Preferences** from the  menu > **Printers & Scanners** (or **Print & Scan**, **Print & Fax**), and then select the printer.
2. Click **Options & Supplies** > **Utility** > **Open Printer Utility**.
3. Click **EPSON Status Monitor**.

Ink Cartridge Codes

The following are the codes for genuine Epson ink cartridges.

Icon	BK: Black	C: Cyan	M: Magenta	Y: Yellow
Padlock 	35 35XL*	35 35XL*	35 35XL*	35 35XL*

* "XL" indicates a large cartridge.

For Australia and New Zealand

BK: Black	C: Cyan	M: Magenta	Y: Yellow
802 802XL*	802 802XL*	802 802XL*	802 802XL*

* "XL" indicates a large cartridge.

Epson recommends the use of genuine Epson ink cartridges. Epson cannot guarantee the quality or reliability of non-genuine ink. The use of non-genuine ink may cause damage that is not covered by Epson's warranties, and under certain circumstances, may cause erratic printer behavior. Information about non-genuine ink levels may not be displayed.

Note:

- Not all cartridges are available in all regions.
- For users in Europe, visit the following website for information on Epson's ink cartridge yields.
<http://www.epson.eu/pageyield>

Related Information

- ➔ ["Technical Support Web Site" on page 222](#)

Ink Cartridge Handling Precautions

Read the following instructions before replacing ink cartridges.

Handling precautions

- Store ink cartridges at normal room temperature and keep them away from direct sunlight.
- Epson recommends using the ink cartridge before the date printed on the package.
- For best results, use up ink cartridge within six months of opening the package.
- For best results, store ink cartridge packages with their bottom down.
- After bringing an ink cartridge inside from a cold storage site, allow it to warm up at room temperature for at least three hours before using it.

Replacing Ink Cartridges and Other Consumables

- ❑ Do not open the ink cartridge package until you are ready to install it in the printer. The cartridge is vacuum packed to maintain its reliability. If you leave a cartridge unpacked for a long time before using it, normal printing may not be possible.
- ❑ Be careful not to break the hooks on the side of the ink cartridge when you remove it from the package.
- ❑ You must remove the yellow tape from the cartridge before installing it; otherwise, print quality may decline or you may not be able to print. Do not remove or tear the label on the cartridge; this can cause leakage.



- ❑ Do not remove the transparent seal from the bottom of the cartridge; otherwise, the cartridge may become unusable.

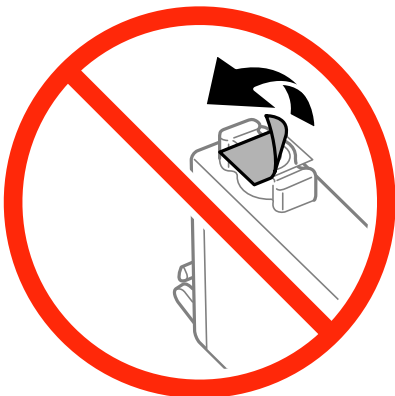

Replacing Ink Cartridges and Other Consumables

- ❑ Do not touch the sections shown in the illustration. Doing so may prevent normal operation and printing.



- ❑ Install all ink cartridges; otherwise you cannot print.
- ❑ Do not replace ink cartridges with the power off. Do not move the print head by hand; otherwise, you may damage the printer.
- ❑ Do not turn off the printer during ink charging. If the ink charging is incomplete, you may not be able to print.
- ❑ Do not leave the printer with the ink cartridges removed or do not turn off the printer during cartridge replacement. Otherwise, ink remaining in the print head nozzles will dry out and you may not be able to print.
- ❑ If you need to remove an ink cartridge temporarily, make sure you protect the ink supply area from dirt and dust. Store the ink cartridge in the same environment as the printer, with the ink supply port facing down or sideways. Do not store ink cartridges with the ink supply port facing up. Because the ink supply port is equipped with a valve designed to contain the release of excess ink, there is no need to supply your own covers or plugs.
- ❑ Removed ink cartridges may have ink around the ink supply port, so be careful not to get any ink on the surrounding area when removing the cartridges.
- ❑ This printer uses ink cartridges equipped with a green chip that monitors information such as the amount of remaining ink for each cartridge. This means that even if the cartridge is removed from the printer before it is expended, you can still use the cartridge after reinserting it back into the printer. However, when reinserting a cartridge, some ink may be consumed to guarantee printer performance.
- ❑ For maximum ink efficiency, only remove an ink cartridge when you are ready to replace it. Ink cartridges with low ink status may not be used when reinserted.
- ❑ To ensure you receive premium print quality and to help protect your print head, a variable ink safety reserve remains in the cartridge when your printer indicates to replace the cartridge. The yields quoted for you do not include this reserve.
- ❑ Although the ink cartridges may contain recycled materials, this does not affect printer function or performance.
- ❑ Specifications and appearance of the ink cartridge are subject to change without prior notice for improvement.
- ❑ Do not disassemble or remodel the ink cartridge, otherwise you may not be able to print normally.
- ❑ You cannot use the cartridges that came with the printer for the replacement.
- ❑ Quoted yields may vary depending on the images that you are printing, the paper type that you are using, the frequency of your prints and environmental conditions such as temperature.

Replacing Ink Cartridges and Other Consumables

Ink consumption

- ❑ To maintain optimum print head performance, some ink is consumed from all cartridges not only during printing but also during maintenance operations such as ink cartridge replacement and print head cleaning.
- ❑ When printing in monochrome or grayscale, color inks instead of black ink may be used depending on the paper type or print quality settings. This is because a mixture of color inks is used to create black.
- ❑ The ink in the ink cartridges supplied with your printer is partly used during initial setup. In order to produce high quality printouts, the print head in your printer will be fully charged with ink. This one-off process consumes a quantity of ink and therefore these cartridges may print fewer pages compared to subsequent ink cartridges.

Replacing Ink Cartridges

When a message is displayed prompting you to replace the ink cartridges, tap **How To** and then view the animations displayed on the control panel to learn how to replace the ink cartridges.

If you need to replace the ink cartridges before they are expended, tap **Maintenance > Ink Cartridge Replacement** on the home screen, and then follow the on-screen instructions. Tap **How To** for details.

Related Information

- ➔ [“Ink Cartridge Codes” on page 137](#)
- ➔ [“Ink Cartridge Handling Precautions” on page 137](#)

Maintenance Box Code

Epson recommends the use of a genuine Epson maintenance box.

The following is the code for the genuine Epson maintenance box.

T6715

Maintenance Box Handling Precautions

Read the following instructions before replacing the maintenance box.

- ❑ Do not touch the green chip on the side of the maintenance box. Doing so may prevent normal operation and printing.
- ❑ Do not tilt the used maintenance box until after it is sealed in the plastic bag; otherwise ink may leak.
- ❑ Keep the maintenance box out of direct sunlight.
- ❑ Do not replace the maintenance box during printing; otherwise, ink may leak.
- ❑ Do not reuse a maintenance box which has been removed and left detached for a long period. Ink inside the box will have solidified and no more ink can be absorbed.
- ❑ Do not remove the maintenance box and its cover except when replacing the maintenance box; otherwise ink may leak.

Replacing the Maintenance Box

In some print cycles a very small amount of surplus ink may be collected in the maintenance box. To prevent ink leakage from the maintenance box, the printer is designed to stop printing when the absorbing capacity of the maintenance box has reached its limit. Whether and how often this is required will vary according to the number of pages you print, the type of material that you print and the number of cleaning cycles that the printer performs.

When a message is displayed prompting you to replace the maintenance box, refer to the animations displayed on the control panel. The need for replacement of the box does not mean that your printer has ceased to operate in accordance with its specifications. The Epson warranty does not cover the cost of this replacement. It is a user-serviceable part.

Note:

When it is full, you cannot print until the maintenance box is replaced to avoid ink leakage. However, you can perform operations such as sending faxes and saving data to an external USB device.

Related Information

- ➔ [“Maintenance Box Code” on page 140](#)
- ➔ [“Maintenance Box Handling Precautions” on page 140](#)

Temporarily Printing with Black Ink

When color ink is expended and black ink still remains, you can use the following settings to continue printing for a short time using only black ink.

- Type of paper: plain papers, Envelope
- Color: **Grayscale**
- Borderless: Not selected
- EPSON Status Monitor 3: Enabled (for Windows only)

Because this feature is only available for approximately five days, replace the expended ink cartridge as soon as possible.

Note:

- If EPSON Status Monitor 3 is disabled, access the printer driver, click **Extended Settings** on the **Maintenance** tab, and then select **Enable EPSON Status Monitor 3**.*
- The available period varies depending on the usage conditions.*

Replacing Ink Cartridges and Other Consumables

Temporarily Printing with Black Ink - Windows

1. When the following window is displayed, cancel printing.

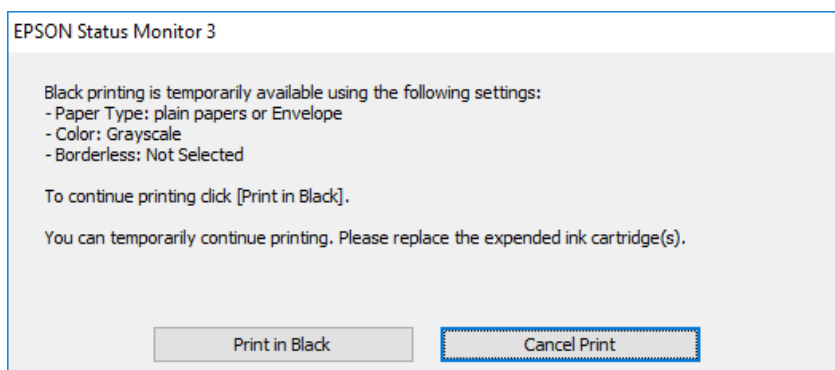
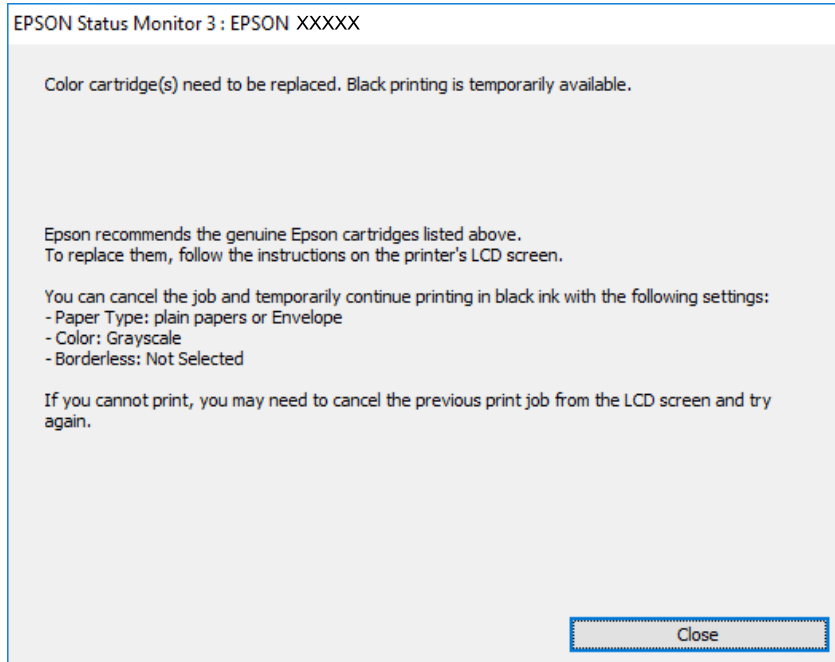
**Note:**

If you cannot cancel printing from the computer, cancel using the printer's control panel.

2. Access the printer driver window.
3. Clear **Borderless** on the **Main** tab.
4. Select **plain papers** or **Envelope** as the **Paper Type** setting on the **Main** tab.
5. Select **Grayscale**.
6. Set the other items on the **Main** and **More Options** tabs as necessary, and then click **OK**.
7. Click **Print**.
8. Click **Print in Black** in the window displayed.

Replacing Ink Cartridges and Other Consumables

Related Information

- ➔ [“Loading Paper in the Paper Cassette” on page 45](#)
- ➔ [“Printing Basics - Windows” on page 61](#)

Temporarily Printing with Black Ink - Mac OS X

Note:

To use this feature through a network, connect with **Bonjour**.

1. Click the printer icon in the **Dock**.
2. Cancel the job.

Note:

If you cannot cancel printing from the computer, cancel using the printer's control panel.

3. Select **System Preferences** from the  menu > **Printers & Scanners** (or **Print & Scan, Print & Fax**), and then select the printer. Click **Options & Supplies > Options** (or **Driver**).
4. Select **On** as the **Permit temporary black printing** setting.
5. Access the print dialog.
6. Select **Print Settings** from the pop-up menu.
7. Select any paper size except for a borderless size as the **Paper Size** setting.
8. Select **plain papers** or **Envelope** as the **Media Type** setting.
9. Select **Grayscale**.
10. Set the other items as necessary.
11. Click **Print**.

Related Information

- ➔ [“Loading Paper in the Paper Cassette” on page 45](#)
- ➔ [“Printing Basics - Mac OS X” on page 63](#)

Conserving Black Ink when the Black Ink Is Low (for Windows Only)

When black ink is running low and there is enough color ink remaining, you can use a mixture of color inks to create black. You can continue printing while preparing a replacement black ink cartridge.

This feature is only available when you select the following settings in the printer driver.

- Paper Type: **plain papers**
- Quality: **Standard**

Replacing Ink Cartridges and Other Consumables

- EPSON Status Monitor 3: Enabled

Note:

- If **EPSON Status Monitor 3** is disabled, access the printer driver, click **Extended Settings** on the **Maintenance** tab, and then select **Enable EPSON Status Monitor 3**.
- Composite black looks slightly different from pure black. In addition, the print speed is reduced.
- To maintain the quality of the print head, black ink is also consumed.

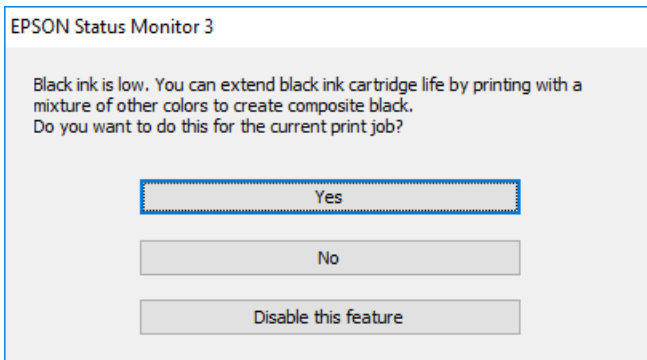

Options	Description
Yes	Select to use a mixture of color inks to create black. This window is displayed the next time you print a similar job.
No	Select to continue using the remaining black ink. This window is displayed the next time you print a similar job.
Disable this feature	Select to continue using the remaining black ink. This window is not displayed until you replace the black ink cartridge and it runs low again.

Maintaining the Printer

Checking and Cleaning the Print Head

If the nozzles are clogged, the printouts become faint, there is visible banding, or unexpected colors appear. When print quality has declined, use the nozzle check feature and check if the nozzles are clogged. If the nozzles are clogged, clean the print head.

Important:

- Do not open the scanner unit or turn off the printer during head cleaning. If the head cleaning is incomplete, you may not be able to print.
- Because print head cleaning uses some ink, clean the print head only if quality declines.
- When ink is low, you may not be able to clean the print head. Replace the ink cartridge first.
- If print quality has not improved after repeating nozzle check and head cleaning about four times, wait for at least six hours without printing, and then run the nozzle check again and repeat the head cleaning if necessary. We recommend to turn off the printer. If print quality has still not improved, contact Epson support.
- To prevent the print head from drying out, do not unplug the printer while the power is on.

Checking and Cleaning the Print Head - Control Panel

1. Load A4-size plain paper in the printer.
If your printer has two paper cassettes, load paper in paper cassette 1.
2. Tap **Maintenance** on the home screen.
3. Tap **Print Head Nozzle Check**.
4. Follow the on-screen instructions to print the nozzle check pattern.
5. Examine the printed pattern. If there are broken lines or missing segments as shown in the "NG" pattern, the print head nozzles may be clogged. Go to the next step. If you cannot see any broken lines or missing segments as in the following "OK" pattern, the nozzles are not clogged. Tap  to close the nozzle check feature.

OK

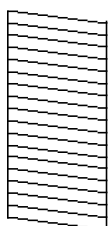

NG

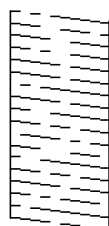

6. Tap , and then follow the on-screen instructions to clean the print head.

Maintaining the Printer

7. When cleaning is finished, print the nozzle check pattern again. Repeat cleaning and printing the pattern until all lines are printed completely.

Related Information

- ➔ [“Loading Paper in the Paper Cassette” on page 45](#)

Checking and Cleaning the Print Head - Windows

1. Load A4-size plain paper in the printer.
If your printer has two paper cassettes, load paper in paper cassette 1.
2. Access the printer driver window.
3. Click **Nozzle Check** on the **Maintenance** tab.
4. Follow the on-screen instructions.

Related Information

- ➔ [“Loading Paper in the Paper Cassette” on page 45](#)
- ➔ [“Windows Printer Driver” on page 163](#)

Checking and Cleaning the Print Head - Mac OS X

1. Load A4-size plain paper in the printer.
If your printer has two paper cassettes, load paper in paper cassette 1.
2. Select **System Preferences** from the  menu > **Printers & Scanners** (or **Print & Scan**, **Print & Fax**), and then select the printer.
3. Click **Options & Supplies** > **Utility** > **Open Printer Utility**.
4. Click **Nozzle Check**.
5. Follow the on-screen instructions.

Related Information

- ➔ [“Loading Paper in the Paper Cassette” on page 45](#)

Aligning the Print Head

If you notice a misalignment of vertical lines or blurred images, align the print head.

Aligning the Print Head - Control Panel

1. Load A4-size plain paper in the printer.
If your printer has two paper cassettes, load paper in paper cassette 1.
2. Tap **Maintenance** on the home screen.
3. Tap **Print Head Alignment**.
4. Select one of the alignment menus.
 - Ruled Line Alignment: Select this if vertical lines look misaligned.
 - Vertical Alignment: Select this if your printouts look blurry.
 - Horizontal Alignment: Select this if you see horizontal banding at regular intervals.
If the color selection screen is displayed, select **Color** or **B&W** according to the print settings.
5. Follow the on-screen instructions to print a pattern for alignment, and then align the print head.
 - Ruled Line Alignment: Find and enter the number for the pattern that has the least misaligned vertical line.

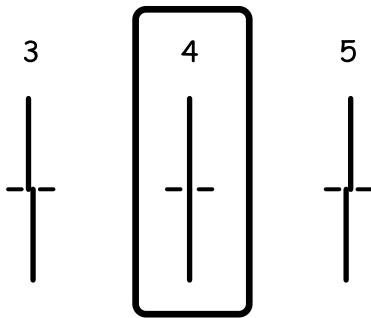

- Vertical Alignment: Find and enter the number for the most solid pattern in each group.

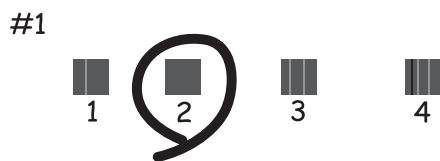

Maintaining the Printer

- ❑ Horizontal Alignment: Find and enter the number for the least separated and overlapping pattern.



Related Information

- ➔ [“Loading Paper in the Paper Cassette” on page 45](#)

Cleaning the Paper Path for Ink Smears

When the printouts are smeared or scuffed, clean the roller inside.

**Important:**

Do not use tissue paper to clean the inside of the printer. The print head nozzles may be clogged with lint.

1. Load A4-size plain paper in the printer.
2. Tap **Maintenance** on the home screen.
3. Tap **Paper Guide Cleaning**.
4. Follow the on-screen instructions to clean the paper path.

Note:

Repeat this procedure until the paper is not smeared with ink. If your printer has two paper cassettes and the printouts are still smeared or scuffed, clean the other paper source.

Related Information

- ➔ [“Loading Paper in the Paper Cassette” on page 45](#)

Cleaning the ADF

When the copied or scanned images from the ADF are smeared or the originals do not feed in the ADF correctly, clean the ADF.

**Important:**

Never use alcohol or thinner to clean the printer. These chemicals can damage the printer.

Maintaining the Printer

1. Open the ADF cover.

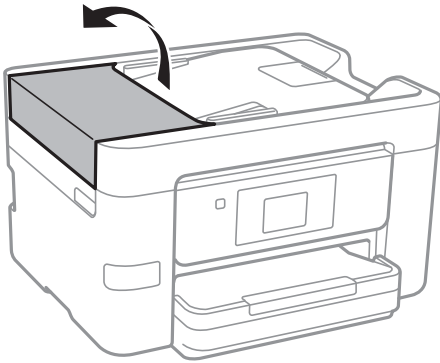

2. Use a soft, moist cloth to clean the roller and the interior of the ADF.

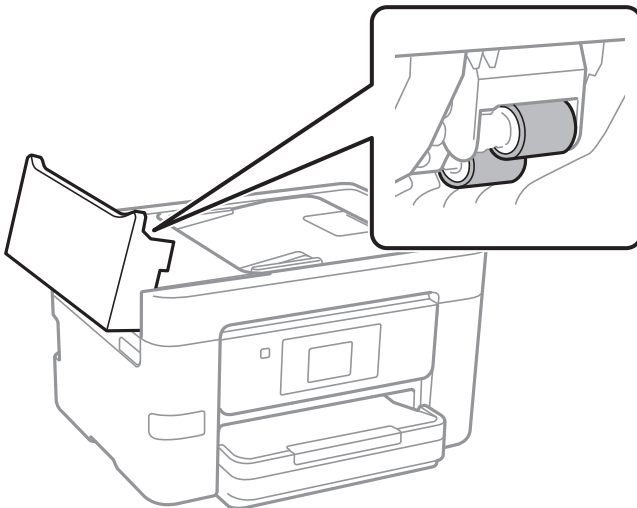

! *Important:*

Using a dry cloth may damage the surface of the roller. Use the ADF after the roller has dried.

3. Open the document cover.

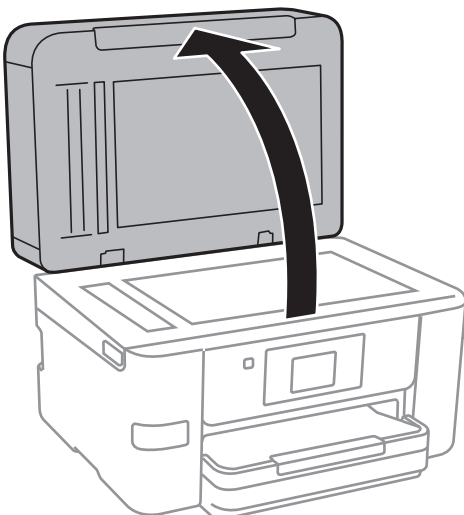

Maintaining the Printer

4. Clean the part that is shown in the illustration.

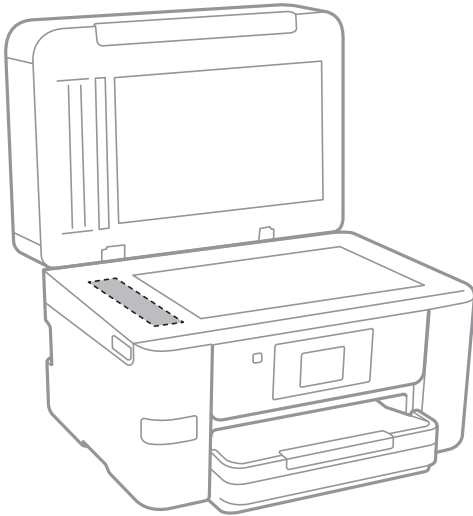

! **Important:**

- If the glass surface is stained with grease or some other hard-to-remove material, use a small amount of glass cleaner and a soft cloth to remove it. Wipe off all remaining liquid.
- Do not press the glass surface too hard.
- Be careful not to scratch or damage the surface of the glass. A damaged glass surface can decrease the scan quality.

Cleaning the Scanner Glass

When the copies or scanned images are smeared, clean the scanner glass.

! **Caution:**

Be careful not to trap your hand or fingers when opening or closing the document cover. Otherwise you may be injured.

! **Important:**

Never use alcohol or thinner to clean the printer. These chemicals can damage the printer.

Maintaining the Printer

1. Open the document cover.

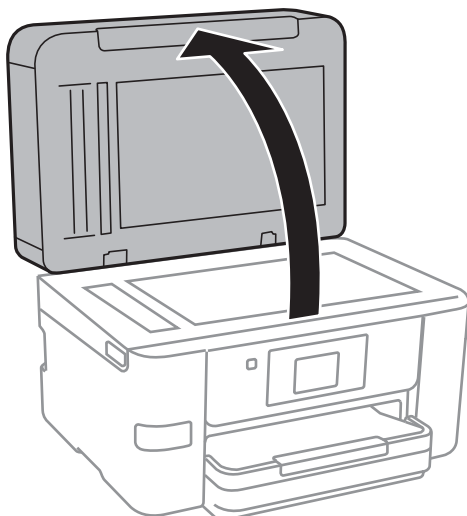

2. Use a soft, dry, clean cloth to clean the surface of the scanner glass.

**Important:**

- If the glass surface is stained with grease or some other hard-to-remove material, use a small amount of glass cleaner and a soft cloth to remove it. Wipe off all remaining liquid.*
- Do not press the glass surface too hard.*
- Be careful not to scratch or damage the surface of the glass. A damaged glass surface can decrease the scan quality.*

Saving Power

The printer enters sleep mode or turns off automatically if no operations are performed for a set period. You can adjust the time before power management is applied. Any increase will affect the product's energy efficiency. Please consider the environment before making any change.

Depending on the location of purchase, the printer may have a feature that turns it off automatically if it is not connected to the network for 30 minutes.

Saving Power - Control Panel

1. Tap **Settings** on the home screen.
2. Tap **General Settings** > **Basic Settings**.
3. Do one of the following.
 - Select **Sleep Timer** or **Power Off Settings** > **Power Off If Inactive** or **Power Off If Disconnected**, and then make settings.
 - Select **Sleep Timer** or **Power Off Timer**, and then make settings.

Maintaining the Printer

Note:

*Your product may have the **Power Off Settings** or **Power Off Timer** feature depending on the location of purchase.*

Menu Options for Settings

Tap **Settings** on the home screen of the printer to make various settings.

Menu Options for General Settings

Select the menus on the control panel as described below.

Settings > General Settings

Basic Settings

Select the menus on the control panel as described below.

Settings > General Settings > Basic Settings

LCD Brightness:

Adjust the brightness of the LCD screen.

Sound:

Adjust the volume and select the type of the sound.

Sleep Timer:

Adjust the time period to enter a sleep mode (energy saving mode) when the printer has not performed any operations. The LCD screen turns black when the setting time passes.

Power Off Timer:

Your product may have this feature or the Power Off Settings feature depending on the location of purchase.

Select this setting to turn the printer off automatically when it is not used for a specified period of time. You can adjust the time before power management is applied. Any increase will affect the product's energy efficiency. Please consider the environment before making any change.

Power Off Settings:

Your product may have this feature or the Power Off Timer feature depending on the location of purchase.

Power Off If Inactive

Select this setting to turn the printer off automatically if it is not used for a specified period of time. Any increase will affect the product's energy efficiency. Please consider the environment before making any change.

Power Off If Disconnected

Select this setting to turn the printer off after 30 minutes when all network ports including the LINE port are disconnected. This feature may not be available depending on your region.

Menu Options for Settings

Date/Time Settings:

Date/Time

Enter the current date and time.

Daylight Saving Time

Select the summer time setting that applies to your area.

Time Difference

Enter the time difference between your local time and UTC (Coordinated Universal Time).

Country/Region:

Select the country or region in which you are using your printer. If you change the country or region, your fax settings return to their defaults and you must select them again.

Language:

Select the language used on the LCD screen.

Wall Paper:

Change the background color of the LCD screen.

Operation Time Out:

Select **On** to return to the initial screen when no operations have been performed for the specified time.

Keyboard:

Change the layout of the keyboard on the LCD screen.

Related Information

➔ [“Saving Power - Control Panel” on page 151](#)

➔ [“Entering Characters” on page 20](#)

Printer Settings

Select the menus on the control panel as described below.

Settings > General Settings > Printer Settings

Paper Source Settings:

Paper Setting:

Select the paper size and paper type you loaded in the paper source. You can make **Favorite Paper Settings** in paper size and paper type.

A4/Letter Auto Switching:

Select **On** to feed paper from the paper source set as A4 size when there is no paper source set as Letter, or feed from the paper source set as Letter size when there is no paper source set as A4.

Menu Options for Settings

Auto Select Settings

This feature is available for models with two paper sources only.

Select **On** for any of following settings to automatically print on paper from any source containing paper that matches your paper settings.

- Copy
- Fax
- Other

Error Notice:

Select **On** to display an error message when the selected paper size or type does not match the loaded paper.

Paper Setup Auto Display:

Select **On** to display the **Paper Setting** screen when loading paper in the paper source. If you disable this feature, you cannot print from an iPhone or iPad using AirPrint.

Universal Print Settings:

These print settings are applied when you print by an external device without using the printer driver.

Top Offset:

Adjust the top margin of the paper.

Left Offset:

Adjust the left margin of the paper.

Top Offset in Back:

Adjust the top margin for the back of the page when performing 2-sided printing.

Left Offset in Back:

Adjust the left margin for the back margin of the page when performing 2-sided printing.

Check Paper Width:

Select **On** to check the paper width before printing. This prevents printing beyond the edges of the paper when the paper size setting are incorrect, but may reduce the printing speed.

Skip Blank Page:

Skips blank pages in the print data automatically.

Auto Error Solver:

Select an action to perform when a 2-sided printing error or a memory full error occurs.

On

Displays a warning and prints in single-sided mode when a 2-sided printing error occurs, or prints only what the printer could process when a memory full error occurs.

Off

Displays an error message and cancels printing.

Menu Options for Settings

Memory Device Interface:

Memory Device:

Select **Enable** to allow the printer to access an inserted memory device. If **Disable** is selected, you cannot save data to the memory device with the printer. This prevents confidential documents from being removed illegally.

File Sharing:

Select whether to give write access to the memory device from a USB-connected computer or a network-connected computer.

Thick Paper:

Select **On** to prevent ink from smearing on your printouts, however, this may lower the print speed.

Quiet Mode:

Select **On** to reduce noise during printing, however, this may lower the print speed. Depending on the paper type and print quality settings you selected, there may be no difference in the printer's noise level.

Ink Drying Time:

Select the ink drying time you want to use when performing 2-sided printing. The printer prints the other side after printing one side. If your printout is smeared, increase the time setting.

Bidirectional:

Select **On** to change the print direction; Prints while the print head moves to the left and to the right. If vertical or horizontal ruled lines on your printout look blurred or misaligned, disabling this feature may solve the problem; however, doing so may reduce print speed.

PC Connection via USB:

Select **Enable** to allow a computer to access the printer when connected by USB. When **Disable** is selected, printing and scanning that is not sent over a network connection is restricted.

Related Information

➔ [“Loading Paper” on page 42](#)

Network Settings

Select the menus on the control panel as described below.

Settings > General Settings > Network Settings

Wi-Fi Setup:

Set up or change wireless network settings. Choose the connection method from the following and then follow the instructions on the LCD panel.

Wi-Fi(Recommended)

Wi-Fi Direct

Menu Options for Settings

Wired LAN Setup:

Set up or change a network connection that uses a LAN cable and router. When this is being used, Wi-Fi connections are disabled.

Network Status:

Displays or prints the current network settings.

Connection Check:

Checks the current network connection and prints a report. If there are any problems with the connection, see the report to solve the problem.

Advanced:

Make the following detailed settings.

- Device Name
- TCP/IP
- Proxy Server
- Email Server
- IPv6 Address
- MS Network Sharing
- Link Speed & Duplex

Related Information

- ➔ [“Making Wi-Fi Settings Manually” on page 27](#)
- ➔ [“Making Wi-Fi Settings by Push Button Setup \(WPS\)” on page 28](#)
- ➔ [“Making Wi-Fi Settings by PIN Code Setup \(WPS\)” on page 29](#)
- ➔ [“Making Wi-Fi Direct \(Simple AP\) Connection Settings” on page 30](#)
- ➔ [“Printing a Network Status Sheet” on page 37](#)
- ➔ [“Checking the Network Connection Status” on page 32](#)
- ➔ [“Changing the Network Connection to Ethernet from the Control Panel” on page 40](#)
- ➔ [“Making Advanced Network Settings” on page 31](#)

Web Service Settings

Select the menus on the control panel as described below.

Settings > General Settings > Web Service Settings

Epson Connect Services:

Displays whether the printer is registered and connected to Epson Connect.

You can register to the service by tapping **Register** and follow the instructions.

When you have registered, you can change the following settings.

- Suspend/Resume
- Unregister

Menu Options for Settings

For details, see the following web site.

<https://www.epsonconnect.com/>

<http://www.epsonconnect.eu> (Europe only)

Google Cloud Print Services:

Displays whether the printer is registered and connected to Google Cloud Print services.

When you have registered, you can change the following settings.

Enable/Disable

Unregister

For details on registering to Google Cloud Print services, see the following web site.

<https://www.epsonconnect.com/>

<http://www.epsonconnect.eu> (Europe only)

Related Information

➔ [“Epson Connect Service” on page 161](#)

Menu Options for Supply Status

Select the menu on the control panel as described below.

Settings > Supply Status

Displays the approximate level of the ink and service life of the maintenance box.

When the ! mark is displayed, ink is running low or the maintenance box is nearly full. When the X mark is displayed, you need to replace the item as ink is expended or the maintenance box is full.

Menu Options for Maintenance

Select the menus on the control panel as described below.

Settings > Maintenance

Print Head Nozzle Check:

Select this feature to check if the print head nozzles are clogged. The printer prints a nozzle check pattern.

Print Head Cleaning:

Select this feature to clean clogged nozzles in the print head.

Print Head Alignment:

Use this feature to adjust the print head to improve print quality.

Ruled Line Alignment

Select this feature to align vertical lines.

Menu Options for Settings

Vertical Alignment

Select this feature if your printouts look blurry or text and lines are misaligned.

Horizontal Alignment

Select this feature if horizontal banding appears at regular intervals in your printouts.

Ink Cartridge Replacement:

Use this feature to replace the ink cartridges before the ink is expended.

Paper Guide Cleaning:

Select this feature if there are ink stains on the internal rollers. The printer feeds paper to clean the internal rollers.

Related Information

- ➔ [“Checking and Cleaning the Print Head” on page 145](#)
- ➔ [“Aligning the Print Head” on page 146](#)
- ➔ [“Replacing Ink Cartridges” on page 140](#)
- ➔ [“Cleaning the Paper Path for Ink Smears” on page 148](#)

Menu Options for Print Status Sheet

Select the menus on the control panel as described below.

Settings > Print Status Sheet

Configuration Status Sheet:

Print information sheets showing the current printer status and settings.

Supply Status Sheet:

Print information sheets showing the status of consumables.

Usage History Sheet:

Print information sheets showing the usage history of the printer.

Menu Options for Print Counter

Select the menus on the control panel as described below.

Settings > Print Counter

Displays the total number of prints, B&W prints, and color prints from the time you purchased the printer. Tap **Print Sheet** when you want to print the result.

Menu Options for User Settings

Select the menus on the control panel as described below.

Settings > User Settings

You can change the default settings of the following menus.

- Copy
- Scan to Network Folder/FTP
- Scan to Email
- Scan to Computer(WSD)
- Scan to Memory Device
- Scan to Cloud
- Fax

Menu Options for Restore Default Settings

Select the menus on the control panel as described below.

Settings > Restore Default Settings

Resets the following menus to their defaults.

- Network Settings
- Copy Settings
- Scan Settings
- Fax Settings
- Clear All Data and Settings

Menu Options for Firmware Update

Select the menus on the control panel as described below.

Settings > Firmware Update

Update:

Check if the latest version of the firmware has been uploaded to the network server. If an update is available, you can select whether or not to start updating.

Notification:

Select **On** to receive a notification if a firmware update is available.

Network Service and Software Information

This section introduces the network services and software products available for your printer from the Epson website or the supplied software disc.

Epson Connect Service

By using Epson Connect service available on the Internet, you can print from your smartphone, tablet PC, or laptop, anytime and practically anywhere.

The features available on the Internet are as follows.

Email Print	Epson iPrint remote print	Scan to Cloud	Remote Print Driver
✓	✓	✓	✓

See the Epson Connect portal website for details.

<https://www.epsonconnect.com/>

<http://www.epsonconnect.eu> (Europe only)

Web Config

Web Config is an application that runs in a web browser, such as Internet Explorer and Safari, on a computer or smart device. You can confirm the printer status or change the network service and printer settings. To use the Web Config, connect the printer and the computer or device to the same network.

Note:

The following browsers are supported.

OS	Browser
Windows XP SP3 or later	Internet Explorer 8 or later, Firefox [*] , Chrome [*]
Mac OS X v10.6.8 or later	Safari [*] , Firefox [*] , Chrome [*]
iOS [*]	Safari [*]
Android 2.3 or later	Default browser
Chrome OS [*]	Default browser

^{*} Use the latest version.

Running Web Config on a Web Browser

1. Check the printer's IP address.

Tap the network icon on the printer's home screen, and then tap the active connection method to confirm the printer's IP address.

Note:

You can also check the IP address by printing the network connection report.

2. Launch a Web browser from a computer or smart device, and then enter the printer's IP address.

Format:

IPv4: http://the printer's IP address/

IPv6: http://[the printer's IP address]/

Examples:

IPv4: http://192.168.100.201/

IPv6: http://[2001:db8::1000:1]/

Note:

Using the smart device, you can also run Web Config from the maintenance screen of Epson iPrint.

Related Information

- ➔ [“Using Epson iPrint” on page 80](#)
- ➔ [“Printing a Network Connection Report” on page 33](#)

Running Web Config on Windows

When connecting a computer to the printer using WSD, follow the steps below to run Web Config.

1. Access the devices and printers screen in Windows.

- Windows 10

Right-click the start button or press and hold it, and then select **Control Panel > View devices and printers** in **Hardware and Sound**.

- Windows 8.1/Windows 8/Windows Server 2012 R2/Windows Server 2012

Select **Desktop > Settings > Control Panel > View devices and printers** in **Hardware and Sound** (or **Hardware**).

- Windows 7/Windows Server 2008 R2

Click the start button, and select **Control Panel > View devices and printers** in **Hardware and Sound**.

- Windows Vista/Windows Server 2008

Click the start button, and select **Control Panel > Printers** in **Hardware and Sound**.

2. Right-click on your printer and select **Properties**.

3. Select the **Web Service** tab and click the URL.

Running Web Config on Mac OS X

1. Select **System Preferences** from the  menu > **Printers & Scanners** (or **Print & Scan, Print & Fax**), and then select the printer.
2. Click **Options & Supplies** > **Show Printer Webpage**.

Windows Printer Driver

The printer driver controls the printer according to the commands from an application. Making settings on the printer driver provides the best printing results. You can also check the status of the printer or keep it in top operating condition using the printer driver utility.

Note:

You can change the language of the printer driver. Select the language you want to use from the **Language** setting on the **Maintenance** tab.

Accessing the printer driver from applications

To make settings that apply only to the application you are using, access from that application.

Select **Print** or **Print Setup** from the **File** menu. Select your printer, and then click **Preferences** or **Properties**.

Note:

Operations differ depending on the application. See the application's help for details.

Accessing the printer driver from the control panel

To make settings that apply to all of the applications, access from the control panel.

Windows 10

Right-click the start button or press and hold it, and then select **Control Panel** > **View devices and printers** in **Hardware and Sound**. Right-click on your printer, or press and hold it and then select **Printing preferences**.

Windows 8.1/Windows 8/Windows Server 2012 R2/Windows Server 2012

Select **Desktop** > **Settings** > **Control Panel** > **View devices and printers** in **Hardware and Sound**. Right-click on your printer, or press and hold it and then select **Printing preferences**.

Windows 7/Windows Server 2008 R2

Click the start button, and select **Control Panel** > **View devices and printers** in **Hardware and Sound**. Right-click on your printer and select **Printing preferences**.

Windows Vista/Windows Server 2008

Click the start button, and select **Control Panel** > **Printers** in **Hardware and Sound**. Right-click on your printer and select **Select printing preferences**.

Windows XP/Windows Server 2003 R2/Windows Server 2003

Click the start button, and select **Control Panel** > **Printers and Other Hardware** > **Printers and Faxes**. Right-click on your printer and select **Printing preferences**.

Accessing the printer driver from the printer icon on the task bar

The printer icon on the desktop task bar is a shortcut icon allowing you to quickly access the printer driver.

If you click the printer icon and select **Printer Settings**, you can access the same printer settings window as the one displayed from the control panel. If you double-click this icon, you can check the status of the printer.

Network Service and Software Information

Note:

If the printer icon is not displayed on the task bar, access the printer driver window, click **Monitoring Preferences** on the **Maintenance** tab, and then select **Register the shortcut icon to the taskbar**.

Starting the utility

Access the printer driver window. Click the **Maintenance** tab.

Restricting Settings for the Windows Printer Driver

You can lock some settings of the printer driver so that other users cannot change them.

Note:

Log on to your computer as an administrator.

1. Open the **Optional Settings** tab in printer properties.
 - Windows 10
Right-click the start button or press and hold it, and then select **Control Panel > View devices and printers** in **Hardware and Sound**. Right-click on your printer, or press and hold it and then select **Printer properties**. Click the **Optional Settings** tab.
 - Windows 8.1/Windows 8/Windows Server 2012R2/Windows Server 2012
Select **Desktop > Settings > Control Panel > View devices and printers** in **Hardware and Sound**. Right-click on your printer, or press and hold it and then select **Printer properties**. Click the **Optional Settings** tab.
 - Windows 7/Windows Server 2008 R2
Click the start button, and select **Control Panel > View devices and printers** in **Hardware and Sound**. Right-click on your printer, and then select **Printer properties**. Click the **Optional Settings** tab.
 - Windows Vista/Windows Server 2008
Click the start button, and select **Control Panel > Printers** in **Hardware and Sound**. Right-click on your printer, and then select **Properties**. Click the **Optional Settings** tab.
 - Windows XP/Windows Server 2003 R2/Windows Server 2003
Click the start button, and select **Control Panel > Printers and Other Hardware > Printers and Faxes**. Right-click on your printer, and then select **Properties**. Click the **Optional Settings** tab.
2. Click **Driver Settings**.
3. Select the feature that you want to restrict.
See the online help for explanations of the setting items.
4. Click **OK**.

Making Operation Settings for the Windows Printer Driver

You can make settings such as enabling **EPSON Status Monitor 3**.

1. Access the printer driver window.
2. Click **Extended Settings** on the **Maintenance** tab.

Network Service and Software Information

3. Make the appropriate settings, and then click **OK**.
See the online help for explanations of the setting items.

Related Information

➔ [“Windows Printer Driver” on page 163](#)

Mac OS X Printer Driver

The printer driver controls the printer according to the commands from an application. Making settings on the printer driver provides the best printing results. You can also check the status of the printer or keep it in top operating condition using the printer driver utility.

Accessing the printer driver from applications

Click **Page Setup** or **Print** on the **File** menu of your application. If necessary, click **Show Details** (or ▼) to expand the print window.

Note:

Depending on the application being used, **Page Setup** may not be displayed in the **File** menu, and the operations for displaying the print screen may differ. See the application's help for details.

Starting the utility

Select **System Preferences** from the  menu > **Printers & Scanners** (or **Print & Scan**, **Print & Fax**), and then select the printer. Click **Options & Supplies** > **Utility** > **Open Printer Utility**.

Making Operation Settings for the Mac OS X Printer Driver

Accessing the Operation Settings Window of the Mac OS X Printer Driver

Select **System Preferences** from the  menu > **Printers & Scanners** (or **Print & Scan**, **Print & Fax**), and then select the printer. Click **Options & Supplies** > **Options** (or **Driver**).

Operation Settings of the Mac OS X Printer Driver

- Thick paper and envelopes:** Prevents the ink from smearing when printing on thick paper. However, this may reduce print speed.
- Skip Blank Page:** Avoids printing blank pages.
- Quiet Mode:** Reduces the noise the printer makes, however, may reduce print speed.
- Permit temporary black printing:** Prints only with black ink temporarily.
- Output documents for filing:** Feed the paper so that it is easy to file when printing landscape data or 2-sided printing. Envelope printing is not supported.
- Remove white borders:** Removes unnecessary margins during borderless printing.

Network Service and Software Information

- High Speed Printing: Prints when the print head moves in both directions. The print speed is faster, but the quality may decline.
- Warning Notifications: Allows the printer driver to display warning notifications.
- Establish bidirectional communication: Usually, this should be set to **On**. Select **Off** when acquiring the printer information is impossible because the printer is shared with Windows computers on a network or for any other reason.

Epson Scan 2 (Scanner Driver)

Epson Scan 2 is an application for controlling scanning. You can adjust the size, resolution, brightness, contrast, and quality of the scanned image.

Note:

You can also start Epson Scan 2 from a TWAIN-compliant scanning application.

Starting on Windows

Note:

*For Windows Server operating systems, you need to install the **Desktop Experience** feature.*

- Windows 10
 - Click the start button, and then select **EPSON > Epson Scan 2**.
- Windows 8.1/Windows 8/Windows Server 2012 R2/Windows Server 2012
 - Enter the application name in the search charm, and then select the displayed icon.
- Windows 7/Windows Vista/Windows XP/Windows Server 2008 R2/Windows Server 2008/Windows Server 2003 R2/Windows Server 2003
 - Click the start button, and then select **All Programs** or **Programs > EPSON > Epson Scan 2 > Epson Scan 2**.

Starting on Mac OS X

Note:

Epson Scan 2 does not support the Mac OS X fast user switching feature. Turn off fast user switching.

Select **Go > Applications > Epson Software > Epson Scan 2**.

Related Information

➔ [“Installing Applications” on page 171](#)

Epson Event Manager

Epson Event Manager is an application that allows you to manage scanning from the control panel and save images to a computer. You can add your own settings as presets, such as the document type, the save folder location, and the image format. See the application's help for details.

Note:

Windows Server operating systems are not supported.

Network Service and Software Information

Starting on Windows

Windows 10

Click the start button, and then select **Epson Software > Event Manager**.

Windows 8.1/Windows 8

Enter the application name in the search charm, and then select the displayed icon.

Windows 7/Windows Vista/Windows XP

Click the start button, and then select **All Programs** or **Programs > Epson Software > Event Manager**.

Starting on Mac OS X

Select **Go > Applications > Epson Software > Event Manager**.

Related Information

➔ [“Installing Applications” on page 171](#)

PC-FAX Driver (Fax Driver)

PC-FAX driver is an application that allows you to send a document created on a separate application as a fax directly from the computer. PC-FAX driver is installed when you install FAX Utility. See the application's help for details.

Note:

Windows Server operating systems are not supported.

The operation differs depending on the application you used to create the document. See the application's help for details.

Accessing from Windows

In the application, select **Print** or **Print Setup** from the **File** menu. Select your printer (FAX), and then click **Preferences** or **Properties**.

Accessing from Mac OS X

In the application, select **Print** from the **File** menu. Select your printer (FAX) as the **Printer** setting, and then select **Fax Settings** or **Recipient Settings** from the pop-up menu.

Related Information

➔ [“FAX Utility” on page 167](#)

FAX Utility

FAX Utility is an application that allows you to configure various settings for sending faxes from a computer. You can create or edit the contacts list to be used when sending a fax, configure to save received faxes in PDF format on the computer, and so on. See the application's help for details.

Note:

Windows Server operating systems are not supported.

Make sure you have installed the printer driver before installing FAX Utility.

Network Service and Software Information

Starting on Windows

Windows 10

Click the start button, and select **Epson Software > FAX Utility**.

Windows 8.1/Windows 8

Enter the application name in the search charm, and then select the displayed icon.

Windows 7/Windows Vista/Windows XP

Click the start button, and select **All Programs (or Programs) > Epson Software > FAX Utility**.

Starting on Mac OS X

Select **System Preferences** from the  menu > **Printers & Scanners (or Print & Scan, Print & Fax)**, and then select the printer (FAX). Click **Options & Supplies > Utility > Open Printer Utility**.

Related Information

➔ [“Installing Applications” on page 171](#)

Epson Easy Photo Print

Epson Easy Photo Print is an application that allows you to easily print photos with various layouts. You can preview the photo image and adjust the images or position. You can also print photos with a frame. See the application's help for details.

Note:

Windows Server operating systems are not supported.

To use this application, the printer driver needs to be installed.

Starting on Windows

Windows 10

Click the start button, and then select **Epson Software > Epson Easy Photo Print**.

Windows 8.1/Windows 8

Enter the application name in the search charm, and then select the displayed icon.

Windows 7/Windows Vista/Windows XP

Click the start button, and then select **All Programs or Programs > Epson Software > Epson Easy Photo Print**.

Starting on Mac OS X

Select **Go > Applications > Epson Software > Epson Easy Photo Print**.

Related Information

➔ [“Installing Applications” on page 171](#)

EPSON Software Updater

EPSON Software Updater is an application that checks for new or updated software on the internet and installs it. You can also update the printer's firmware and manual.

Note:

Windows Server operating systems are not supported.

Starting on Windows Windows 10

Click the start button, and then select **Epson Software > EPSON Software Updater**.

 Windows 8.1/Windows 8

Enter the application name in the search charm, and then select the displayed icon.

 Windows 7/Windows Vista/Windows XP

Click the start button, and then select **All Programs (or Programs) > Epson Software > EPSON Software Updater**.

Note:

*You can also start EPSON Software Updater by clicking the printer icon on the task bar on the desktop, and then selecting **Software Update**.*

Starting on Mac OS X

Select **Go > Applications > Epson Software > EPSON Software Updater**.

Related Information

➔ [“Installing Applications” on page 171](#)

EpsonNet Config

EpsonNet Config is an application that allows you to set the network interface addresses and protocols. See the operations guide for EpsonNet Config or the application's help for more details.

Starting on Windows Windows 10

Click the start button, and then select **EpsonNet > EpsonNet Config**.

 Windows 8.1/Windows 8/Windows Server 2012 R2/Windows Server 2012

Enter the application name in the search charm, and then select the displayed icon.

 Windows 7/Windows Vista/Windows XP/Windows Server 2008 R2/Windows Server 2008/Windows Server 2003 R2/Windows Server 2003

Click the start button, and select **All Programs (or Programs) > EpsonNet > EpsonNet Config V4 > EpsonNet Config**.

Starting on Mac OS X

Select **Go > Applications > Epson Software > EpsonNet > EpsonNet Config V4 > EpsonNet Config**.

Related Information

➔ [“Installing Applications” on page 171](#)



Uninstalling Applications

Log in to your computer as an administrator. Enter the administrator password if the computer prompts you.

Uninstalling Applications - Windows

1. Press the  button to turn off the printer.
 2. Quit all running applications.
 3. Open **Control Panel**:
 - Windows 10
Right-click the start button or press and hold it, and then select **Control Panel**.
 - Windows 8.1/Windows 8/Windows Server 2012 R2/Windows Server 2012
Select **Desktop > Settings > Control Panel**.
 - Windows 7/Windows Vista/Windows XP/Windows Server 2008 R2/Windows Server 2008/Windows Server 2003 R2/Windows Server 2003
Click the start button and select **Control Panel**.
 4. Open **Uninstall a program** (or **Add or Remove Programs**):
 - Windows 10/Windows 8.1/Windows 8/Windows 7/Windows Vista/Windows Server 2012 R2/Windows Server 2012/Windows Server 2008 R2/Windows Server 2008
Select **Uninstall a program** in **Programs**.
 - Windows XP/Windows Server 2003 R2/Windows Server 2003
Click **Add or Remove Programs**.
 5. Select the application you want to uninstall.
 6. Uninstall the applications:
 - Windows 10/Windows 8.1/Windows 8/Windows 7/Windows Vista/Windows Server 2012 R2/Windows Server 2012/Windows Server 2008 R2/Windows Server 2008
Click **Uninstall/Change** or **Uninstall**.
 - Windows XP/Windows Server 2003 R2/Windows Server 2003
Click **Change/Remove** or **Remove**.
- Note:**
*If the **User Account Control** window is displayed, click **Continue**.*
7. Follow the on-screen instructions.

Uninstalling Applications - Mac OS X

1. Download the Uninstaller using EPSON Software Updater.
Once you have downloaded the Uninstaller, you do not need to download it again each time you uninstall the application.
2. Press the  button to turn off the printer.
3. To uninstall the printer driver or PC-FAX driver, select **System Preferences** from the  menu > **Printers & Scanners** (or **Print & Scan, Print & Fax**), and then remove the printer from the enabled printers list.
4. Quit all running applications.
5. Select **Go > Applications > Epson Software > Uninstaller**.
6. Select the application you want to uninstall, and then click **Uninstall**.

**Important:**

The Uninstaller removes all drivers for Epson inkjet printers on the computer. If you use multiple Epson inkjet printers and you only want to delete some drivers, delete all of them first, and then install the necessary printer driver again.

Note:

*If you cannot find the application you want to uninstall in the application list, you cannot uninstall using the Uninstaller. In this situation, select **Go > Applications > Epson Software**, select the application you want to uninstall, and then drag it to the trash icon.*

Related Information

➔ [“EPSON Software Updater” on page 169](#)

Installing Applications

Connect your computer to the network and install the latest version of applications from the website.

Note:

- Log on to your computer as an administrator. Enter the administrator password if the computer prompts you.
- When reinstalling an application, you need to uninstall it first.

1. Quit all running applications.
2. When installing the printer driver or Epson Scan 2, disconnect the printer and the computer temporarily.

Note:

Do not connect the printer and the computer until you are instructed to do so.

3. Install the applications by following the instructions on the website below.

<http://epson.sn>

Note:

If you are using a Windows computer and you cannot download applications from the website, install them from the software disc that came with the printer.

Updating Applications and Firmware

You may be able to clear certain problems and improve or add functions by updating the applications and the firmware. Make sure you use the latest version of the applications and firmware.

1. Make sure that the printer and the computer are connected, and the computer is connected to the internet.
2. Start EPSON Software Updater, and update the applications or the firmware.

**Important:**

Do not turn off or unplug the printer until the update is complete; otherwise, the printer may malfunction.

Note:

If you cannot find the application you want to update in the list, you cannot update using the EPSON Software Updater. Check for the latest versions of the applications from your local Epson website.

<http://www.epson.com>

Related Information

➔ [“EPSON Software Updater” on page 169](#)

Updating the Printer's Firmware using the Control Panel

If the printer is connected to the Internet, you can update the printer's firmware using the control panel. You can also set the printer to regularly check for firmware updates and notify you if any are available.

1. Tap **Settings** on the home screen.
2. Tap **Firmware Update > Update**.

Note:

Tap **Notification > On** to set the printer to regularly check for available firmware updates.

3. Check the message displayed on the screen and tap **Start Checking**.
The printer starts searching for available updates.

Network Service and Software Information

4. If a message is displayed on the LCD screen informing you that a firmware update is available, follow the on-screen instructions to start the update.

**Important:**

- ❑ *Do not turn off or unplug the printer until the update is complete; otherwise, the printer may malfunction.*
- ❑ *If the firmware update is not completed or is unsuccessful, the printer does not start up normally and "Recovery Mode" is displayed on the LCD screen the next time the printer is turned on. In this situation, you need to update the firmware again using a computer. Connect the printer to the computer with a USB cable. While "Recovery Mode" is displayed on the printer, you cannot update the firmware over a network connection. On the computer, access your local Epson website, and then download the latest printer firmware. See the instructions on the website for the next steps.*

Solving Problems

Checking the Printer Status

Checking Messages on the LCD Screen

If an error message is displayed on the LCD screen, follow the on-screen instructions or the solutions below to solve the problem.

Error Messages	Solutions
Printer Error Turn on the printer again. See your documentation for more details.	Remove any paper or protective material in the printer. If the error message is still displayed, contact Epson support.
Paper out in XX.	Load paper, and then insert the paper cassette all the way.
You need to replace the following ink cartridge(s).	To ensure you receive premium print quality and to help protect your print head, a variable ink safety reserve remains in the cartridge when your printer indicates it is time to replace the cartridge. Replace the cartridge when you are prompted to do so.
Paper Configuration is disabled. Some features may not be available. For details, see your documentation.	If Paper Setup Auto Display is disabled, you cannot use AirPrint.
No dial tone is detected.	This problem might be resolved by selecting Settings > General Settings > Fax Settings > Basic Settings > Line Type and then selecting PBX . If your phone system requires an external access code to get an outside line, set the access code after selecting PBX . Use # (hash) instead of the actual access code when entering an outside fax number. This makes connection more secure. If the error message is still displayed, set the Dial Tone Detection settings to disabled. However, disabling this feature may drop the first digit of a fax number and send the fax to the wrong number.
The combination of the IP address and the subnet mask are invalid. See your documentation for more details.	Enter the correct IP address or default gateway. Contact the person who setup the network for assistance.
To use cloud services, update the root certificate from the Epson Web Config utility.	Run Web Config, and then update the root certificate.
Check that the printer driver is installed on the computer and that the port settings for the printer are correct.	Make sure the printer port is selected correctly in Property > Port from the Printer menu as follows. Select " USBXXX " for a USB connection, or " EpsonNet Print Port " for a network connection.
Check that the printer driver is installed on the computer and that the USB port settings for the printer are correct.	

Solving Problems

Error Messages	Solutions
Recovery Mode	<p>The printer has started in recovery mode because the firmware update failed. Follow the steps below to try to update the firmware again.</p> <ol style="list-style-type: none"> 1. Connect the computer and the printer with a USB cable. (During recovery mode, you cannot update the firmware over a network connection.) 2. Visit your local Epson website for further instructions.

Related Information

- ➔ [“Contacting Epson Support” on page 222](#)
- ➔ [“Installing Applications” on page 171](#)
- ➔ [“Updating Applications and Firmware” on page 172](#)

Checking the Printer Status - Windows

1. Access the printer driver window.
2. Click **EPSON Status Monitor 3** on the **Maintenance** tab, and then click **Details**.

You can check the printer status, ink levels, and error status.

Note:

*If EPSON Status Monitor 3 is disabled, click **Extended Settings** on the **Maintenance** tab, and then select **Enable EPSON Status Monitor 3**.*

Related Information

- ➔ [“Windows Printer Driver” on page 163](#)

Checking the Printer Status - Mac OS X

1. Select **System Preferences** from the  menu > **Printers & Scanners** (or **Print & Scan, Print & Fax**), and then select the printer.
2. Click **Options & Supplies** > **Utility** > **Open Printer Utility**.
3. Click **EPSON Status Monitor**.

You can check the printer status, ink levels, and error status.

Checking the Software Status

You may be able to clear the problem by updating the software to the latest version. To check the software status, use the software update tool.

Related Information

- ➔ [“EPSON Software Updater” on page 169](#)

➔ [“Updating Applications and Firmware” on page 172](#)

Removing Jammed Paper

Follow the on-screen instructions on the printer's control panel to locate and remove the jammed paper including any torn pieces. The LCD screen displays an animation that shows you how to remove jammed paper.

**Caution:**

Never touch the buttons on the control panel while your hand is inside the printer. If the printer starts operating, it could cause an injury. Be careful not to touch the protruding parts to avoid injury.

**Important:**

Remove the jammed paper carefully. Removing the paper vigorously may cause damage to the printer.

Note:

WF-4720 Series:

If the paper jam error has not been cleared, torn pieces of the jammed paper may remain inside the rear cover. Open the rear cover, and then remove the jammed paper.

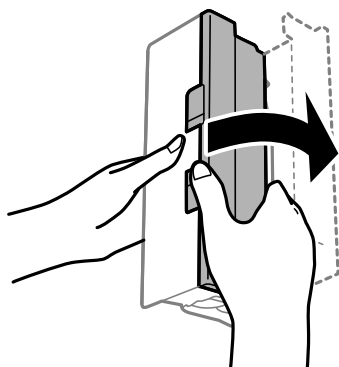

Paper Does Not Feed Correctly

Check the following points, and then take the appropriate actions to solve the problem.

- Place the printer on a flat surface and operate in the recommended environmental conditions.
- Use paper supported by this printer.
- Follow the paper handling precautions.
- Do not load more than the maximum number of sheets specified for the paper. For plain paper, do not load above the line indicated by the triangle symbol on the edge guide.
- Make sure the paper size and paper type settings match the actual paper size and paper type loaded in the printer.

Related Information

➔ [“Environmental Specifications” on page 213](#)

Solving Problems

- ➔ [“Paper Handling Precautions” on page 42](#)
- ➔ [“Available Paper and Capacities” on page 43](#)
- ➔ [“List of Paper Type” on page 44](#)

Paper Jams

Load paper in the correct direction, and slide the edge guides against the edges of the paper.

Related Information

- ➔ [“Removing Jammed Paper” on page 176](#)
- ➔ [“Loading Paper in the Paper Cassette” on page 45](#)

Paper Feeds at a Slant

Load paper in the correct direction, and slide the edge guides against the edges of the paper.

Related Information

- ➔ [“Loading Paper in the Paper Cassette” on page 45](#)

Several Sheets of Paper are Fed at a Time

When several sheets of paper are fed at a time during manual 2-sided printing, remove any paper which is loaded in the printer before you reload the paper.

Original Does Not Feed in the ADF

- Use originals supported by the ADF.
- Load originals in the correct direction, and slide the ADF edge guides against the edges of the originals.
- Clean the inside of the ADF.

Solving Problems

- ❑ Do not load originals above the line indicated by the triangle symbol on the ADF.

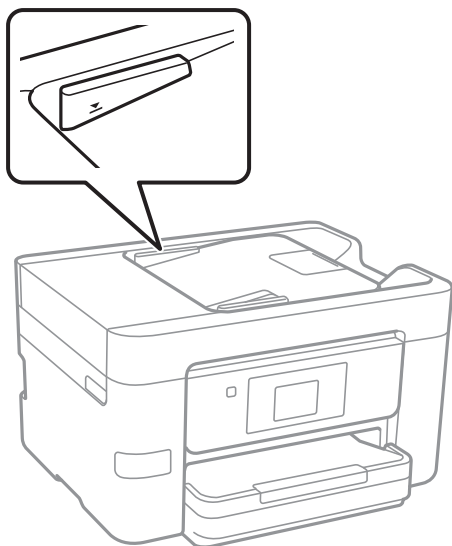

- ❑ Check that the ADF icon is on at the bottom of the screen. If it is off, place the originals again.

Related Information



- ➔ [“Available Originals for the ADF” on page 49](#)
- ➔ [“Placing Originals on the ADF” on page 49](#)
- ➔ [“Cleaning the ADF” on page 148](#)

Power and Control Panel Problems

Power Does Not Turn On

- ❑ Make sure the power cord is securely plugged in.
- ❑ Hold down the  button for a little longer.

Power Does Not Turn Off

Hold down the  button for a little longer. If you still cannot turn off the printer, unplug the power cord. To prevent the print head from drying out, turn the printer back on and turn it off by pressing the  button.

Power Turns Off Automatically

- ❑ Tap **Settings** > **General Settings** > **Basic Settings** > **Power Off Settings**, and then disable the **Power Off If Inactive** and **Power Off If Disconnected** settings.
- ❑ Tap **Settings** > **General Settings** > **Basic Settings**, and then disable the **Power Off Timer** Setting.

Solving Problems

Note:

Your product may have the **Power Off Settings** or **Power Off Timer** feature depending on the location of purchase.

LCD Screen Gets Dark

The printer is in sleep mode. Tap anywhere on the LCD screen to return it to its former state.

Touch Screen Does Not Respond

- If you stick a protective label on the touchscreen, the optical touch screen may not respond.
- Turn off the printer, and then wipe the screen using a soft, dry cloth. If the screen is smeared, it may not respond.

Cannot Print from a Computer

Checking the connection

- Connect the USB cable securely to the printer and the computer.
- If you are using a USB hub, try to connect the printer directly to the computer.
- If you cannot print over a network, see the page that describes the network connection method from the computer.

Checking the software and data

- Install the printer driver.
- If you are printing a large data size image, the computer may run out of memory. Print the image at a lower resolution or a smaller size.

Checking the printer status from the computer (Windows)

Click **Print Queue** on the printer driver's **Maintenance** tab, and then check the following.

- Check if there are any paused print jobs.
Cancel printing if necessary.
- Make sure the printer is not offline or pending.
If the printer is offline or pending, clear the offline or pending setting from the **Printer** menu.
- Make sure the printer is selected as the default printer from the **Printer** menu (there should be a check mark on the menu item).
If the printer is not selected as the default printer, set it as the default printer.
- Make sure the printer port is selected correctly in **Property > Port** from the **Printer** menu as follows.
Select "USBXXX" for a USB connection, or "EpsonNet Print Port" for a network connection.

Checking the printer status from the computer (Mac OS X)

Make sure the printer status is not **Pause**.

Solving Problems

Select **System Preferences** from the  menu > **Printers & Scanners** (or **Print & Scan**, **Print & Fax**), and then double-click the printer. If the printer is paused, click **Resume** (or **Resume Printer**).

Related Information

- ➔ [“Connecting to a Computer” on page 24](#)
- ➔ [“Installing Applications” on page 171](#)
- ➔ [“Canceling Printing” on page 84](#)

When You Cannot Make Network Settings

- ❑ Turn off the devices you want to connect to the network. Wait for about 10 seconds, and then turn on the devices in the following order; access point, computer or smart device, and then printer. Move the printer and computer or smart device closer to the access point to help with radio wave communication, and then try to make network settings again.
- ❑ Tap **Settings** > **General Settings** > **Network Settings** > **Connection Check**, and then print the network connection report. If an error has occurred, check the network connection report and then follow the printed solutions.

Related Information

- ➔ [“Printing a Network Connection Report” on page 33](#)
- ➔ [“Messages and Solutions on the Network Connection Report” on page 34](#)

Cannot Connect from Devices Even Though Network Settings are No Problems

If you cannot connect from the computer or smart device to the printer even though the network connection report does not show any problems, see the following.

- ❑ When you are using multiple access points at the same time, you may not be able to use the printer from the computer or smart device depending on the settings of the access points. Connect the computer or smart device to the same access point as the printer.

Disable the tethering function on the smart device if it is enabled.

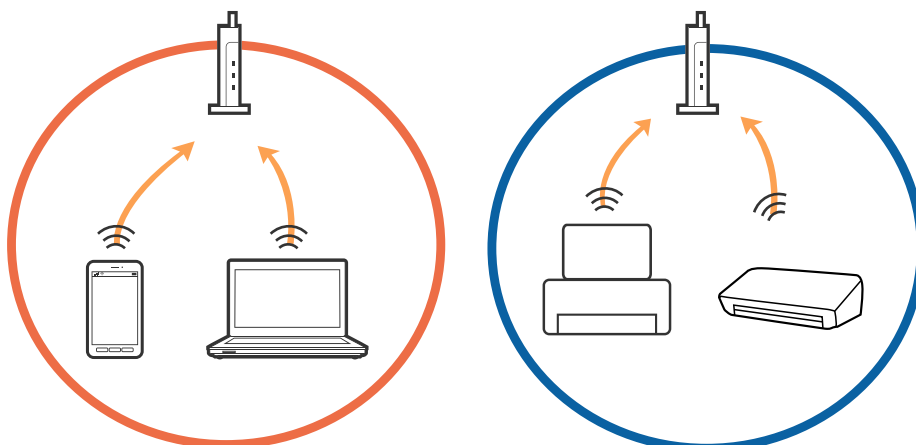

Solving Problems

- ❑ You may not be able to connect to the access point when the access point has multiple SSIDs and devices are connected to different SSIDs on the same access point. Connect the computer or smart device to the same SSID as the printer.

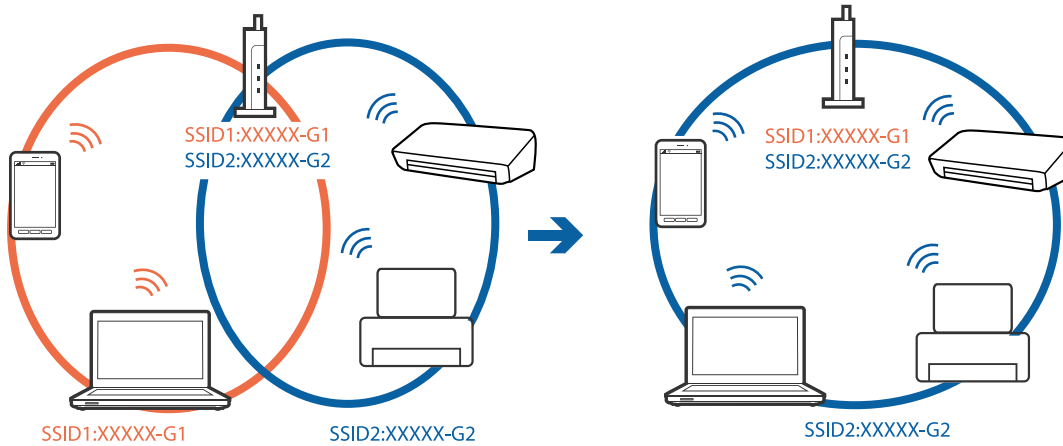

- ❑ An access point that is compliant with both IEEE802.11a and IEEE802.11g has SSIDs of 2.4 GHz and 5 GHz. If you connect the computer or smart device to a 5 GHz SSID, you cannot connect to the printer because the printer only supports communication over 2.4 GHz. Connect the computer or smart device to the same SSID as the printer.

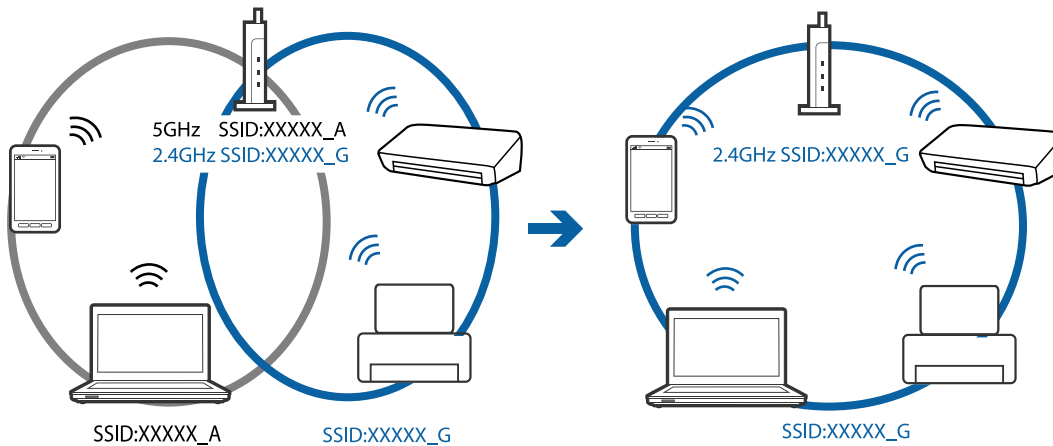

- ❑ Most access points have a privacy separator feature that blocks communication between connected devices. If you cannot communicate between the printer and the computer or smart device even if they are connected to the same network, disable the privacy separator on the access point. See the manual provided with the access point for details.

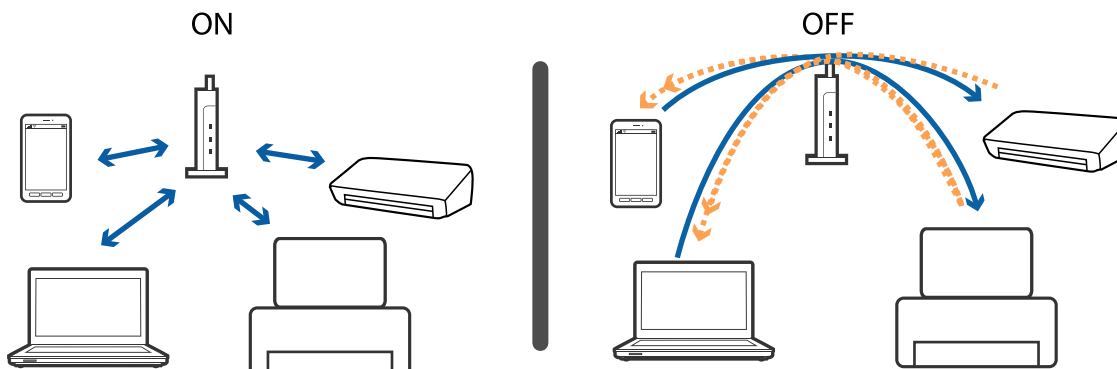

Solving Problems

Related Information

- ➔ [“Checking the SSID Connected to the Printer” on page 182](#)
- ➔ [“Checking the SSID for the Computer” on page 182](#)

Checking the SSID Connected to the Printer

Tap **Settings** > **General Settings** > **Network Settings** > **Network Status**. You can check the SSID for Wi-Fi and Wi-Fi Direct from each menu.

Checking the SSID for the Computer

Windows

Click  in the task tray on the desktop. Check the name of the connected SSID from the list displayed.



Solving Problems

Mac OS X

Click the Wi-Fi icon at the top of the computer screen. A list of SSIDs is displayed and the connected SSID is indicated with a check mark.



Suddenly the Printer Cannot Print over a Network Connection

Checking the network environment

- When you have changed your access point or provider, try making network settings for the printer again. Connect the computer or smart device to the same SSID as the printer.
- Turn off the devices you want to connect to the network. Wait for about 10 seconds, and then turn on the devices in the following order; access point, computer or smart device, and then printer. Move the printer and computer or smart device closer to the access point to help with radio wave communication, and then try to make network settings again.

Checking the computer

In Windows, click **Print Queue** on the printer driver's **Maintenance** tab, and then check the following.

- Check if there are any paused print jobs.
Cancel printing if necessary.
- Make sure the printer is not offline or pending.
If the printer is offline or pending, clear the offline or pending setting from the **Printer** menu.
- Make sure the printer is selected as the default printer from the **Printer** menu (there should be a check mark on the menu item).
If the printer is not selected as the default printer, set it as the default printer.
- Check if the selected port is correct in **Printer Properties** > **Port**.

Checking the network connection report

Tap **Settings** > **General Settings** > **Network Settings** > **Connection Check**, and then print the network connection report. If the report shows that the network connection failed, check the network connection report and then follow the printed solutions.

Solving Problems

Checking the network connection of the computer

Try accessing any website from your computer to make sure that your computer's network settings are correct. If you cannot access any website, there is a problem on the computer. Check the network connection of the computer.

Related Information

- ➔ [“Checking the SSID Connected to the Printer” on page 182](#)
- ➔ [“Printing a Network Connection Report” on page 33](#)
- ➔ [“Messages and Solutions on the Network Connection Report” on page 34](#)
- ➔ [“Windows Printer Driver” on page 163](#)

Suddenly the Printer Cannot Print Using a USB Connection

- Disconnect the USB cable from the computer. Right-click on the printer icon displayed on the computer, and then select **Remove Device**. Next, connect the USB cable to the computer and try a test print. If printing is possible, the setup is complete.
- Re-set the USB connection following the steps in [Changing a Connection Method to a Computer] in this manual.

Related Information

- ➔ [“Changing the Connection Method to a Computer” on page 38](#)

Cannot Print from an iPhone or iPad

- Connect the iPhone or iPad to the same network (SSID) as the printer.
- Enable **Paper Setup Auto Display** in the following menus.
Settings > General Settings > Printer Settings > Paper Source Settings > Paper Setup Auto Display
- Enable the AirPrint setting on Web Config.

Related Information

- ➔ [“Connecting to a Smart Device” on page 26](#)
- ➔ [“Web Config” on page 161](#)

Printout Problems

Printout is Scuffed or Color is Missing

If you have not used the printer for a long time, the print head nozzles may be clogged and ink drops may not be discharged. Perform a nozzle check, and then clean the print head if any of the print head nozzles are clogged.

Related Information

➔ [“Checking and Cleaning the Print Head” on page 145](#)

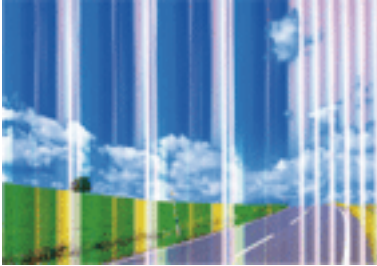
Banding or Unexpected Colors Appear

The print head nozzles may be clogged. Perform a nozzle check to check if the print head nozzles are clogged. Clean the print head if any of the print head nozzles are clogged.

Related Information

➔ [“Checking and Cleaning the Print Head” on page 145](#)

Colored Banding Appears at Intervals of Approximately 3.3 cm

- Select the appropriate paper type setting for the type of paper loaded in the printer.
- Align the print head using the **Horizontal Alignment** feature.
- When printing on plain paper, print using a higher quality setting.

Related Information

➔ [“List of Paper Type” on page 44](#)

➔ [“Aligning the Print Head” on page 146](#)

Blurry Prints, Vertical Banding, or Misalignment



enthalten alle
Aufdruck. W
5008 "Regel

Align the print head using the **Vertical Alignment** feature.

Related Information

➔ [“Aligning the Print Head” on page 146](#)

Print Quality Does Not Improve Even After Aligning the Print Head

During bidirectional (or high speed) printing, the print head prints while moving in both directions, and vertical lines may be misaligned. If print quality does not improve, disable the bidirectional (or high speed) setting. Disabling this setting may slow down printing speed.

Control panel

Disable **Bidirectional** in **Settings > General Settings > Printer Settings**.

Windows

Clear **High Speed** on the printer driver's **More Options** tab.

Mac OS X

Select **System Preferences** from the  menu > **Printers & Scanners** (or **Print & Scan, Print & Fax**), and then select the printer. Click **Options & Supplies > Options** (or **Driver**). Select **Off** as the **High Speed Printing** setting.

Related Information

➔ [“Menu Options for Memory Device” on page 59](#)

Print Quality is Poor

Check the following if the print quality is poor due to blurry prints, banding, missing colors, faded colors, and misalignment in the prints.

Checking the printer

- Perform a nozzle check, and then clean the print head if any of the print head nozzles are clogged.
- Align the print head.

Checking the paper

- Use paper supported by this printer.

Solving Problems

- Do not print on paper that is damp, damaged, or too old.
- If the paper is curled or the envelope is puffed up, flatten it.
- Do not stack the paper immediately after printing.
- Dry the printouts completely before filing or displaying them. When drying the printouts, avoid direct sun light, do not use a dryer, and do not touch the printed side of paper.
- When printing images or photos, Epson recommends using genuine Epson paper rather than plain paper. Print on the printable side of the genuine Epson paper.

Checking the print settings

- Select the appropriate paper type setting for the type of paper loaded in the printer.
- Print using a higher quality setting.
- If you have selected **Standard-Vivid** as the quality setting on the Windows printer driver, change to **Standard**. If you have selected **Normal-Vivid** as the quality setting on the Mac OS X printer driver, change to **Normal**.

Checking the ink cartridge

- Epson recommends using the ink cartridge before the date printed on the package.
- For best results, use up ink cartridge within six months of opening the package.
- Try to use genuine Epson ink cartridges. This product is designed to adjust colors based on the use of genuine Epson ink cartridges. The use of non-genuine ink cartridges may cause print quality to decline.

Related Information

- ➔ [“Checking and Cleaning the Print Head” on page 145](#)
- ➔ [“Aligning the Print Head” on page 146](#)
- ➔ [“Available Paper and Capacities” on page 43](#)
- ➔ [“List of Paper Type” on page 44](#)
- ➔ [“Paper Handling Precautions” on page 42](#)

Paper Is Smearred or Scuffed

- When horizontal banding appears or the top or bottom of the paper is smearred, load paper in the correct direction and slide the edge guides to the edges of the paper.

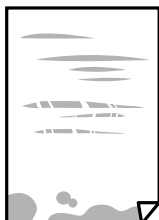

Solving Problems

- ❑ When vertical banding appears or the paper is smeared, clean the paper path.



- ❑ Place the paper on a flat surface to check if it is curled. If it is, flatten it.
- ❑ If thick paper is scuffed, enable the reduce scuffing setting. If you enable this setting, print quality may decline or printing may slow down.
 - ❑ Control panel
 - Tap **Settings** > **General Settings** > **Printer Settings** from the home screen, and then enable **Thick Paper**.
 - ❑ Windows
 - Click **Extended Settings** on the printer driver's **Maintenance** tab, and then select **Thick Paper and Envelopes**.
 - ❑ Mac OS X
 - Select **System Preferences** from the  menu > **Printers & Scanners** (or **Print & Scan**, **Print & Fax**), and then select the printer. Click **Options & Supplies** > **Options** (or **Driver**). Select **On** as the **Thick paper and envelopes** setting.
- ❑ When performing manual 2-sided printing, make sure that the ink is completely dry before reloading the paper.

Related Information

- ➔ [“Loading Paper in the Paper Cassette” on page 45](#)
- ➔ [“Cleaning the Paper Path for Ink Smears” on page 148](#)

Paper is Smeared During Automatic 2-Sided Printing

When using the automatic 2-sided printing feature and printing high density data such as images and graphs, set the print density to lower and the drying time to longer.

Related Information

- ➔ [“Printing on 2-Sides” on page 65](#)
- ➔ [“Printer Settings” on page 154](#)

Printed Photos are Sticky

You may be printing on the wrong side of the photo paper. Make sure you are printing on the printable side.

When printing on the wrong side of the photo paper, you need to clean the paper path.

Related Information

- ➔ [“Cleaning the Paper Path for Ink Smears” on page 148](#)

Images or Photos are Printed in Unexpected Colors

When printing from the control panel or from the Windows printer driver, the Epson auto photo adjustment setting is applied by default depending on the paper type. Try change the setting.

Control panel

Change the **Enhance** setting from **Auto** to any other option. If changing the setting does not work, select **Enhance Off** as the **Enhance** setting.

Windows printer driver

On the **More Options** tab, select **Custom** in **Color Correction**, and then click **Advanced**. Change the **Scene Correction** setting from **Auto Correct** to any other option. If changing the setting does not work, use any color correction method other than **PhotoEnhance** in **Color Management**.

Related Information

➔ [“Menu Options for Memory Device” on page 59](#)

➔ [“Adjusting the Print Color” on page 78](#)

Cannot Print Without Margins

Make borderless setting in the print settings. If you select a paper type that does not support borderless printing, you cannot select **Borderless**. Select a paper type that supports borderless printing.

Related Information

➔ [“Advanced Menu Options for Copying” on page 87](#)

➔ [“Printing Basics - Windows” on page 61](#)

➔ [“Printing Basics - Mac OS X” on page 63](#)

Edges of the Image are Cropped During Borderless Printing

During borderless printing, the image is slightly enlarged and the protruding area is cropped. Select a smaller enlargement setting.

Control panel

Change the **Expansion** setting.

Windows

Click **Settings** next to the **Borderless** checkbox on the printer driver's **Main** tab, and then change the settings.

Mac OS X

Change the **Expansion** setting from the print dialog's **Print Settings** menu.

Related Information

➔ [“Advanced Menu Options for Copying” on page 87](#)

Solving Problems

The Position, Size, or Margins of the Printout Are Incorrect

- Load paper in the correct direction, and slide the edge guides against the edges of the paper.
- When placing the originals on the scanner glass, align the corner of the original with the corner indicated by a symbol on the frame of the scanner glass. If the edges of the copy are cropped off, move the original slightly away from the corner.
- When placing the originals on the scanner glass, clean the scanner glass and the document cover. If there is dust or stains on the glass, the copy area may extend to include the dust or stains, resulting in the wrong copying position or small images.
- Select the appropriate **Original Size** in the copy settings.
- Select the appropriate paper size setting.
- Adjust the margin setting in the application so that it falls within the printable area.

Related Information

- ➔ [“Loading Paper in the Paper Cassette” on page 45](#)
- ➔ [“Placing Originals on the Scanner Glass” on page 51](#)
- ➔ [“Cleaning the Scanner Glass” on page 150](#)
- ➔ [“Printable Area” on page 205](#)

Printed Characters Are Incorrect or Garbled

- Connect the USB cable securely to the printer and the computer.
- Cancel any paused print jobs.
- Do not put the computer manually into the **Hibernate** mode or the **Sleep** mode while printing. Pages of garbled text may be printed next time you start the computer.
- If you use the printer driver you had previously used, printed characters may be garbled. Make sure that the printer driver you are using is for this printer. Check the printer name on the top of the printer driver window.

Related Information

- ➔ [“Canceling Printing” on page 84](#)

The Printed Image Is Inverted

Clear any mirror image settings in the printer driver or the application.

- Windows
 - Clear **Mirror Image** on the printer driver's **More Options** tab.
- Mac OS X
 - Clear **Mirror Image** from the print dialog's **Print Settings** menu.

Mosaic-Like Patterns in the Prints

When printing images or photos, print using high-resolution data. Images on websites are often low resolution although they look good enough on the display, and so print quality may decline.

Uneven Colors, Smears, Dots, or Straight Lines Appear in the Copied Image

- Clean the paper path.
- Clean the scanner glass.
- Clean the ADF.
- Do not press too hard on the original or the document cover when you are placing the originals on the scanner glass.
- When the paper is smeared, lower the copy density setting.

Related Information

- ➔ [“Cleaning the Paper Path for Ink Smears” on page 148](#)
- ➔ [“Cleaning the Scanner Glass” on page 150](#)
- ➔ [“Cleaning the ADF” on page 148](#)
- ➔ [“Basic Menu Options for Copying” on page 86](#)

Moiré (Cross-Hatch) Patterns Appear in the Copied Image

Change the reduce and enlarge setting or place the original at a slightly different angle.

Related Information

- ➔ [“Basic Menu Options for Copying” on page 86](#)

An Image of the Reverse Side of the Original Appears in the Copied Image

- For a thin original, place the original on the scanner glass and then place a piece of black paper over it.
- Lower the copy density setting on the control panel.

Related Information

- ➔ [“Basic Menu Options for Copying” on page 86](#)

The Printout Problem Could Not be Cleared



If you have tried all of the solutions and have not solved the problem, try uninstalling and then reinstalling the printer driver.

Related Information

- ➔ [“Uninstalling Applications” on page 170](#)
- ➔ [“Installing Applications” on page 171](#)

Other Printing Problems

Printing Is Too Slow

- Close any unnecessary applications.
- Lower the quality setting. High quality printing slows down the printing speed.
- Enable the bidirectional (or high speed) setting. When this setting is enabled, the print head prints while moving in both directions, and the printing speed increases.
 - Control Panel
From the home screen, tap **Settings** > **General Settings** > **Printer Settings** > **Bidirectional**, and then enable it.
 - Windows
Select **High Speed** on the printer driver's **More Options** tab.
 - Mac OS X
Select **System Preferences** from the  menu > **Printers & Scanners** (or **Print & Scan**, **Print & Fax**), and then select the printer. Click **Options & Supplies** > **Options** (or **Driver**). Select **On** as the **High Speed Printing** setting.
- Disable quiet mode. This feature slows down the printing speed.
 - Control Panel
Tap  **ON** on the home screen, and then disable **Quiet Mode**.
 - Windows
Select **Off** as the **Quiet Mode** setting on the printer driver's **Main** tab.
 - Mac OS X
Select **System Preferences** from the  menu > **Printers & Scanners** (or **Print & Scan**, **Print & Fax**), and then select the printer. Click **Options & Supplies** > **Options** (or **Driver**). Select **Off** as the **Quiet Mode** setting.

Printing Slows Down Dramatically During Continuous Printing

Printing slows down to prevent the printer mechanism from overheating and being damaged. However, you can continue printing. To return to normal printing speed, leave the printer idle for at least 30 minutes. Printing speed does not return to normal if the power is off.

Cannot Cancel Printing from a Computer Running Mac OS X v10.6.8

If you want to stop printing from your computer, make the following settings.

Solving Problems

Run Web Config, and then select **Port9100** as the **Top Priority Protocol** setting in **AirPrint Setup**. Select **System Preferences** from the  menu > **Printers & Scanners** (or **Print & Scan**, **Print & Fax**), remove the printer, and then add the printer again.

Cannot Start Scanning

- If you are scanning with the ADF, check that the document cover and ADF cover are closed.
- Connect the USB cable securely to the printer and the computer. If you are using a USB hub, try to connect the printer directly to the computer.
- If you scan at a high resolution over a network, a communication error may occur. Lower the resolution.
- Make sure that the correct printer (scanner) is selected on Epson Scan 2.

Check whether or not the printer is recognized when using Windows

In Windows, make sure the printer (scanner) is displayed in **Scanner and Camera**. The printer (scanner) should be displayed as "EPSON XXXXX (printer name)". If the printer (scanner) is not displayed, uninstall and then re-install Epson Scan 2. See the following to access **Scanner and Camera**.

- Windows 10
Right-click the start button or press and hold it, select **Control Panel**, enter "Scanner and Camera" in the search charm, click **View scanners and cameras**, and then check if the printer is displayed.
- Windows 8.1/Windows 8/Windows Server 2012 R2/Windows Server 2012
Select **Desktop > Settings > Control Panel**, enter "Scanner and Camera" in the search charm, click **Show Scanner and Camera**, and then check if the printer is displayed.
- Windows 7/Windows Server 2008 R2
Click the start button and select **Control Panel**, enter "Scanner and Camera" in the search charm, click **View scanners and cameras**, and then check if the printer is displayed.
- Windows Vista/Windows Server 2008
Click the start button, select **Control Panel > Hardware and Sound > Scanners and Cameras**, and then check if the printer is displayed.
- Windows XP/Windows Server 2003 R2/Windows Server 2003
Click the start button, select **Control Panel > Printers and Other Hardware > Scanner and Cameras**, and then check if the printer is displayed.

Related Information

- ➔ ["Uninstalling Applications" on page 170](#)
- ➔ ["Installing Applications" on page 171](#)

Scanned Image Problems

Uneven Colors, Dirt, Spots, and so on Appear when Scanning from the Scanner Glass

- Clean the scanner glass.
- Remove any trash or dirt that adheres to the original.
- Do not press with too much force on the original or the document cover. If you press with too much force, blurring, smudges, and spots may occur.

Related Information

- ➔ [“Cleaning the Scanner Glass” on page 150](#)

Straight Lines Appear when Scanning from ADF

- Clean the ADF.
Straight lines may appear in the image when trash or dirt gets into the ADF.
- Remove any trash or dirt that adheres to the original.

Related Information

- ➔ [“Cleaning the ADF” on page 148](#)

The Image Quality Is Rough

- In Epson Scan 2, adjust the image using items on the **Advanced Settings** tab, and then scan.
- If the resolution is low, try increasing the resolution and then scanning.

Related Information

- ➔ [“Scanning Using Epson Scan 2” on page 103](#)

Offset Appears in the Background of Images

Images on the back of the original may appear in the scanned image.

- In Epson Scan 2, select the **Advanced Settings** tab, and then adjust the **Brightness**.
This feature may not be available depending on the settings on the **Main Settings** tab > **Image Type** or other settings on the **Advanced Settings** tab.
- In Epson Scan 2, select the **Advanced Settings** tab, and then **Image Option** > **Text Enhancement**.
- When scanning from the scanner glass, place black paper or a desk pad over the original.

Solving Problems

Related Information

- ➔ [“Scanning Using Epson Scan 2” on page 103](#)
- ➔ [“Placing Originals” on page 49](#)

Text is Blurred

- In Epson Scan 2, select the **Advanced Settings** tab, and then **Image Option > Text Enhancement**.
- In Epson Scan 2, when **Image Type** on the **Main Settings** tab is set to **Black & White**, adjust the **Threshold** on the **Advanced Settings** tab. When you increase the **Threshold**, black becomes stronger.
- If the resolution is low, try increasing the resolution and then scanning.

Related Information

- ➔ [“Scanning Using Epson Scan 2” on page 103](#)

Moiré Patterns (Web-Like Shadows) Appear

If the original is a printed document, moiré patterns (web-like shadows) may appear in the scanned image.

- On the **Advanced Settings** tab in Epson Scan 2, set **Descreening**.



- Change the resolution, and then scan again.

Related Information

- ➔ [“Scanning Using Epson Scan 2” on page 103](#)

Cannot Scan the Correct Area on the Scanner Glass

- Make sure the original is placed correctly against the alignment marks.
- If the edge of the scanned image is missing, move the original slightly away from the edge of the scanner glass.
- When scanning from the control panel and selecting the auto scan area cropping function, remove any trash or dirt from the scanner glass and document cover. If there is any trash or dirt around the original, the scanning range expands to include it.

Related Information

- ➔ [“Placing Originals” on page 49](#)
- ➔ [“Cleaning the Scanner Glass” on page 150](#)

Solving Problems

Text is Not Recognized Correctly when Saving as a Searchable PDF

- On the **Image Format Options** window in Epson Scan 2, check that **Text Language** is set correctly on the **Text** tab.
- Check that the original is placed straight.
- Use an original with clear text. Text recognition may decline for the following types of originals.
 - Originals that have been copied a number of times
 - Originals received by fax (at low resolutions)
 - Originals on which the letter spacing or line spacing is too small
 - Originals with ruled lines or underlining over the text
 - Originals with hand-written text
 - Originals with creases or wrinkles
- In Epson Scan 2, when **Image Type** on the **Main Settings** tab is set to **Black & White**, adjust the **Threshold** on the **Advanced Settings** tab. When you increase the **Threshold**, the black color area becomes larger.
- In Epson Scan 2, select the **Advanced Settings** tab, and then **Image Option > Text Enhancement**.

Related Information

- ➔ [“Scanning Using Epson Scan 2” on page 103](#)

Cannot Solve Problems in the Scanned Image

If you have tried all of the solutions and have not solved the problem, initialize the Epson Scan 2 settings using Epson Scan 2 Utility.

Note:

Epson Scan 2 Utility is an application that comes with Epson Scan 2.

1. Start Epson Scan 2 Utility.
 - Windows 10
Click the start button, and then select **EPSON > Epson Scan 2 Utility**.
 - Windows 8.1/Windows 8/Windows Server 2012 R2/Windows Server 2012
Enter the application name in the search charm, and then select the displayed icon.
 - Windows 7/Windows Vista/Windows XP/Windows Server 2008 R2/Windows Server 2008/Windows Server 2003 R2/Windows Server 2003
Click the start button, and then select **All Programs** or **Programs > EPSON > Epson Scan 2 > Epson Scan 2 Utility**.
 - Mac OS X
Select **Go > Applications > Epson Software > Epson Scan 2 Utility**.
2. Select the **Other** tab.
3. Click **Reset**.

Note:

If initialization does not solve the problem, uninstall and re-install Epson Scan 2.

Related Information

- ➔ [“Uninstalling Applications” on page 170](#)
- ➔ [“Installing Applications” on page 171](#)

Other Scanning Problems

Scanning Speed Is Slow

- Lower the resolution, and then scan again. When the resolution is high, scanning may take some time.
- The scanning speed may be reduced depending on the image adjustment features in Epson Scan 2.
- On the **Configuration** screen which is displayed by clicking the  button in Epson Scan 2, if you set **Quiet Mode** on the **Scan** tab, the scanning speed may be reduced.

Related Information

- ➔ [“Scanning Using Epson Scan 2” on page 103](#)

Cannot Send the Scanned Image by Email

Make sure you have configured the email server settings.

Scanning Stops when Scanning to PDF/Multi-TIFF

- When scanning using Epson Scan 2, you can continuously scan up to 999 pages in PDF format and up to 200 pages in Multi-TIFF format. When scanning using the control panel, you can continuously scan up to 50 pages in single-sided scanning using the ADF, and up to 100 pages in 2-sided scanning using the ADF and when scanning using the scanner glass.
- When scanning large volumes, we recommend scanning in grayscale.
- Increase the free space on the computer's hard disk. Scanning may stop if there is not enough free space.
- Try scanning at a lower resolution. Scanning stops if the total data size reaches the limit.

Related Information



- ➔ [“Scanning Using Epson Scan 2” on page 103](#)
- ➔ [“Scanning Using Epson Scan 2” on page 103](#)

Problems when Sending and Receiving Faxes

Cannot Send or Receive Faxes

- ❑ Use **Check Fax Connection** on the control panel to run the automatic fax connection check. Try the solutions printed on the report.
- ❑ Check the **Line Type** setting. Setting to **PBX** may solve the problem. If your phone system requires an external access code to get an outside line, register the access code to the printer, and enter # (hash) at the beginning of a fax number when sending.
- ❑ If a communication error occurs, change the **Fax Speed** setting to **Slow(9,600bps)** on the control panel.
- ❑ Check that the telephone wall jack works by connecting a phone to it and testing it. If you cannot make or receive calls, contact your telecommunication company.
- ❑ To connect to a DSL phone line, you need to use a DSL modem equipped with a built-in DSL filter, or install a separate DSL filter to the line. Contact your DSL provider.
- ❑ If you are connecting to a DSL phone line, connect the printer directly to a telephone wall jack to see if the printer can send a fax. If it works, the problem may be caused by the DSL filter. Contact your DSL provider.
- ❑ Enable the **ECM** setting on the control panel. Color faxes cannot be sent or received when **ECM** is off.
- ❑ To send or receive faxes using the computer, make sure that the printer is connected using a USB cable or a network, and that the PC-FAX Driver have been installed on the computer. The PC-FAX Driver is installed together with FAX Utility.
- ❑ In Windows, make sure the printer (fax) is displayed in **Devices and Printers**, **Printer**, or **Printers and Other Hardware**. The printer (fax) is displayed as "EPSON XXXXX (FAX)". If the printer (fax) is not displayed, uninstall and then re-install the FAX Utility. See the following to access **Devices and Printers**, **Printer**, or **Printers and Other Hardware**.
 - ❑ Windows 10
Right-click on the start button, or press and hold it and then select **Control Panel > View devices and printers** in **Hardware and Sound**.
 - ❑ Windows 8.1/Windows 8
Select **Desktop > Settings > Control Panel > View devices and printers** in **Hardware and Sound** or **Hardware**.
 - ❑ Windows 7
Click the start button, and select **Control Panel > View devices and printers** in **Hardware and Sound** or **Hardware**.
 - ❑ Windows Vista
Click the start button, and select **Control Panel > Printers** in **Hardware and Sound**.
 - ❑ Windows XP
Click the start button, and select **Settings > Control Panel > Printers and Other Hardware > Printers and Faxes**.

Solving Problems

- ❑ In Mac OS X, check the following.
 - ❑ Select **System Preferences** from the  menu > **Printers & Scanners** (or **Print & Scan, Print & Fax**), and then make sure the printer (fax) is displayed. The printer (fax) is displayed as "FAX XXXX (USB)" or "FAX XXXX (IP)". If the printer (fax) is not displayed, click [+] and then register the printer (fax).
 - ❑ Select **System Preferences** from the  menu > **Printers & Scanners** (or **Print & Scan, Print & Fax**), and then double-click the printer (fax). If the printer is paused, click **Resume** (or **Resume Printer**).

Related Information

- ➔ [“Connecting the Printer to a Phone Line” on page 109](#)
- ➔ [“Making Settings for a PBX Phone System” on page 114](#)
- ➔ [“Check Fax Connection” on page 131](#)
- ➔ [“Basic Settings” on page 133](#)
- ➔ [“Uninstalling Applications” on page 170](#)
- ➔ [“Installing Applications” on page 171](#)

Cannot Send Faxes

- ❑ Set up the header information for outgoing faxes on the control panel. Some fax machines automatically reject incoming faxes that do not include header information.
- ❑ If you have blocked your caller ID, unblock it. Some phones or fax machines automatically reject anonymous calls.
- ❑ Ask the recipient if the fax number is correct and the recipient's fax machine is ready to receive a fax.

Related Information

- ➔ [“Basic Settings” on page 133](#)
- ➔ [“Cannot Send or Receive Faxes” on page 198](#)

Cannot Send Faxes to a Specific Recipient

Check the following if you cannot send faxes to a specific recipient due to an error.

- ❑ If the recipient machine does not pick up your call within 50 seconds after the printer has finished dialing, the call ends with an error. Dial using a connected telephone to check how long it takes before you hear a fax tone. If it takes more than 50 seconds, add pauses after the fax number to send the fax. Tap  to enter the pause. A hyphen is entered as the pause mark. One pause is about three seconds. Add multiple pauses as needed.
- ❑ If you have selected the recipient from the contacts list, verify that the registered information is correct. If the information is correct, select the recipient from the contacts list, tap **Edit** and change **Fax Communication Mode** to **Slow(9,600bps)**.

Related Information

- ➔ [“Sending Faxes Dialing from the External Phone Device” on page 117](#)
- ➔ [“Managing Contacts” on page 53](#)
- ➔ [“Cannot Send or Receive Faxes” on page 198](#)

Cannot Send Faxes at a Specified Time

Set the date and the time correctly on the control panel.

Related Information

- ➔ [“Sending Faxes at a Specified Time \(Send Fax Later\)” on page 118](#)
- ➔ [“Basic Settings” on page 153](#)

Cannot Receive Faxes

- If you have subscribed to a call forwarding service, the printer may not be able to receive faxes. Contact the service provider.
- If you have not connected a telephone to the printer, set the **Receive Mode** setting to **Auto** on the control panel.
- Under the following conditions, the printer runs out of memory and cannot receive faxes. See the troubleshooting for information on handling a memory full error.
 - The number of received documents has reached the maximum of 100 documents.
 - The printer's memory is full (100%).
- Check if the sender's fax number has been registered to the **Rejection Number List**. Faxes sent from numbers that have been added to this list are blocked when **Rejection Number List** in **Rejection Fax** is enabled.
- Ask the sender if header information is set up on their fax machine. Faxes that do not include header information are blocked when **Fax Header Blank** in **Rejection Fax** is enabled.
- Check if the sender's fax number is registered in the contacts list. Faxes sent from numbers that have not been registered to this list are blocked when **Unregistered Contacts** in **Rejection Fax** is enabled.

Related Information

- ➔ [“Basic Settings” on page 133](#)
- ➔ [“Cannot Send or Receive Faxes” on page 198](#)
- ➔ [“Memory Full Error Occurs” on page 200](#)

Cannot Save Received Faxes to a Memory Device

Check if the memory device is connected to the printer, and then check the **Receive Settings**.

Related Information

- ➔ [“Saving Received Faxes in an External Memory Device” on page 125](#)

Memory Full Error Occurs

- If the printer has been set to save received faxes in the inbox, delete faxes you have already read from the inbox.
- If the printer has been set to save received faxes on a computer, turn on the computer that is set to save the faxes. Once the faxes are saved in the computer, they are deleted from the printer's memory.

Solving Problems

- ❑ If the printer has been set to save received faxes on a memory device, connect the device, in which you have created a folder to save faxes, to the printer. Once the faxes are saved in the device, they are deleted from the printer's memory. Make sure that the device has enough available memory and is not write protected.
- ❑ Even though the memory is full, you can send a monochrome fax by using the **Direct Send** feature. Or you can also send a fax by dialing from the external phone device.
- ❑ If the printer cannot print a received fax due to a printer error, such as a paper jam, the memory full error may occur. Clear the printer problem, and then contact the sender and ask them to send the fax again.

Related Information

- ➔ [“Sending Faxes Dialing from the External Phone Device” on page 117](#)
- ➔ [“Sending Many Pages of a Monochrome Document \(Direct Send\)” on page 118](#)
- ➔ [“Saving Received Faxes in the Inbox” on page 124](#)
- ➔ [“Saving Received Faxes in an External Memory Device” on page 125](#)
- ➔ [“Saving Received Faxes on a Computer” on page 126](#)
- ➔ [“Removing Jammed Paper” on page 176](#)

Sent Fax Quality Is Poor

- ❑ Clean the scanner glass.
- ❑ Clean the ADF.
- ❑ Change the **Original Type** setting on the control panel. If your originals contain both text and photos, select **Photo**.
- ❑ Change the **Density** setting on the control panel.
- ❑ If you are not sure about the capabilities of the recipient fax machine, enable the **Direct Send** feature or select **Fine** as the **Resolution** setting.
If you select **Super Fine** or **Ultra Fine** for a monochrome fax, and send the fax without using the **Direct Send** feature, the printer may automatically lower the resolution.
- ❑ Enable the **ECM** setting on the control panel.

Related Information

- ➔ [“Cleaning the Scanner Glass” on page 150](#)
- ➔ [“Fax Settings” on page 128](#)
- ➔ [“Cleaning the ADF” on page 148](#)

Faxes Are Sent at the Wrong Size

- ❑ When sending a fax using the scanner glass, place the original correctly aligning its corner with the origin mark. Select your original size on the control panel.
- ❑ Clean the scanner glass and the document cover. If there is dust or stains on the glass, the scanning area may extend to include the dust or stains, resulting in the wrong scanning position or small images.

Related Information

- ➔ [“Placing Originals” on page 49](#)

Solving Problems

- ➔ [“Fax Settings” on page 128](#)
- ➔ [“Cleaning the Scanner Glass” on page 150](#)

Received Fax Quality Is Poor

- Enable the **ECM** setting on the control panel.
- Contact the sender and ask them to send using a higher quality mode.
- Reprint the received fax. Select **Fax** >  > **Reprint Faxes** to reprint the fax.

Related Information

- ➔ [“Fax Settings” on page 128](#)

Received Faxes Are Not Printed

- If an error has occurred on the printer, such as a paper jam, the printer cannot print received faxes. Check the printer.
- If the printer has been set to save received faxes in the inbox, the received faxes are not automatically printed. Check the **Receive Settings**.

Related Information

- ➔ [“Saving Received Faxes in the Inbox” on page 124](#)
- ➔ [“Removing Jammed Paper” on page 176](#)

Pages are Blank or only a Small Amount of Text is Printed on the Second Page in Received Faxes

You can print on one page by using the **Delete Print Data After Split** feature in **Split Page Settings**.

Select **Delete Top** or **Delete Bottom** in **Delete Print Data After Split**, and then adjust **Threshold**. Increasing the threshold increases the amount deleted; a higher threshold gives you a higher possibility of printing on one page.

Other Faxing Problems

Cannot Make Calls on the Connected Telephone

Connect the telephone to the **EXT.** port on the printer, and pick up the receiver. If you cannot hear a dial tone through the receiver, connect the phone cable correctly.

Related Information

- ➔ [“Connecting Your Phone Device to the Printer” on page 110](#)

Answering Machine Cannot Answer Voice Calls

On the control panel, set the printer's **Rings to Answer** setting to a number higher than the number of rings for your answering machine.

Related Information

- ➔ [“Settings for the Answering Machine” on page 121](#)
- ➔ [“Basic Settings” on page 133](#)

Sender's Fax Number Not Displayed on Received Faxes or the Number Is Wrong

The sender may not have set the fax header information or may have set it incorrectly. Contact the sender.

Other Problems

Slight Electric Shock when Touching the Printer

If many peripherals are connected to the computer, you may feel a slight electric shock when touching the printer. Install a ground wire to the computer that is connected to the printer.

Operation Sounds Are Loud

If operations sounds are too loud, enable **Quiet Mode**. Enabling this feature may reduce printing speed.

- Control panel

Tap  on the home screen, and then enable **Quiet Mode**.

- Windows printer driver

Enable **Quiet Mode** on the **Main** tab.

- Mac OS X printer driver

Select **System Preferences** from the  menu > **Printers & Scanners** (or **Print & Scan**, **Print & Fax**), and then select the printer. Click **Options & Supplies** > **Options** (or **Driver**). Select **On** as the **Quiet Mode** setting.

- Epson Scan 2

Click the  button to open the **Configuration** window. Next, set the **Quiet Mode** on the **Scan** tab.

The Date and Time Are Incorrect

Set the date and the time correctly on the control panel. After a power failure caused by a lightning strike or if the power is left off for a long time, the clock may show the wrong time.

Related Information

➔ [“Basic Settings” on page 153](#)

Memory Device Is not Recognized

Enable the memory device in the **Memory Device Interface** settings on the control panel.

Related Information

➔ [“Printer Settings” on page 154](#)

Cannot Save Data to a Memory Device

- Check that the memory device is not write protected.
- Check that the memory device has enough available memory. If the available memory is low, data cannot be saved.

Related Information

➔ [“External USB Device Specifications” on page 210](#)

Application Is Blocked by a Firewall (for Windows Only)

Add the application to the Windows Firewall allowed program in security settings on the **Control Panel**.

"!" Is Displayed on the Photo Selection Screen

"!" is displayed on the LCD screen when the image file is not supported by the product.

Related Information

➔ [“Supported Data Specifications” on page 210](#)

Appendix

Technical Specifications

Printer Specifications

Print Head Nozzle Placement		Black ink nozzles: 400×2 Color ink nozzles: 400×2 rows for each color
Weight of Paper*	Plain Paper	64 to 90 g/m ² (17 to 24lb)
	Envelopes	Envelope #10, DL, C6: 75 to 90 g/m ² (20 to 24 lb)

* Even when the paper thickness is within this range, the paper may not feed in the printer or the print quality may decline depending on the paper properties or quality.

Printable Area

Printable Area for Single Sheets

Print quality may decline in the shaded areas due to the printer's mechanism.

Printing with borders

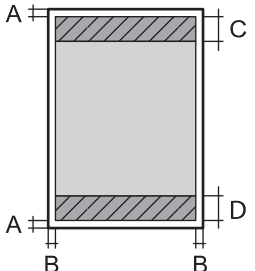
	A	3.0 mm (0.12 in.)
	B	3.0 mm (0.12 in.)
	C	47.0 mm (1.85 in.)
	D	45.0 mm (1.77 in.)

Borderless printing

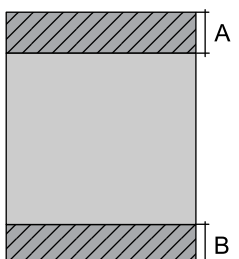
	A	50.0 mm (1.97 in.)
	B	48.0 mm (1.89 in.)

Appendix

Printable Area for Envelopes

Print quality may decline in the shaded areas due to the printer's mechanism.

	A	3.0 mm (0.12 in.)
	B	5.0 mm (0.20 in.)
	C	18.0 mm (0.71 in.)
	D	47.0 mm (1.85 in.)

Scanner Specifications

Scanner Type	Flatbed
Photoelectric Device	CIS
Effective Pixels	10200×14040 pixels (1200 dpi)
Maximum Document Size	216×297 mm (8.5×11.7 in.) A4, Letter
Scanning Resolution	1200 dpi (main scan) 2400 dpi (sub scan)
Output Resolution	50 to 9600 dpi in 1 dpi increments
Color Depth	Color <input type="checkbox"/> 48 bits per pixel internal (16 bits per pixel per color internal) <input type="checkbox"/> 24 bits per pixel external (8 bits per pixel per color external) Grayscale <input type="checkbox"/> 16 bits per pixel internal <input type="checkbox"/> 8 bits per pixel external Black and white <input type="checkbox"/> 16 bits per pixel internal <input type="checkbox"/> 1 bits per pixel external
Light Source	LED

Interface Specifications

For Computer	Hi-Speed USB
For External USB Device	Hi-Speed USB

Appendix

Fax Specifications

Fax Type	Walk-up black and white and color fax capability (ITU-T Super Group 3)
Supported Lines	Standard analogue telephone lines, PBX (Private Branch Exchange) telephone systems
Speed	Up to 33.6 kbps
Resolution	<p>Monochrome</p> <ul style="list-style-type: none"> <input type="checkbox"/> Standard: 8 pel/mm×3.85 line/mm (203 pel/in.×98 line/in.) <input type="checkbox"/> Fine: 8 pel/mm×7.7 line/mm (203 pel/in.×196 line/in.) <input type="checkbox"/> Super Fine: 8 pel/mm×15.4 line/mm (203 pel/in.×392 line/in.) <input type="checkbox"/> Ultra Fine: 16 pel/mm×15.4 line/mm (406 pel/in.×392 line/in.) <input type="checkbox"/> Photo: 8 pel/mm×7.7 line/mm (203 pel/in.×196 line/in.) <p>Color</p> <p>200×200 dpi</p>
Page Memory	Up to 180 pages (when received ITU-T No.1 chart in monochrome draft mode)
Redial*	2 times (with 1 minute intervals)
Interface	RJ-11 Phone Line, RJ-11 Telephone set connection

* The specifications may differ by country or region.

Network Function List

Functions		Supported	Remarks	
Network Interfaces	Ethernet	✓	-	
	Wi-Fi	Infrastructure	✓	-
		Ad hoc	-	-
		Wi-Fi Direct (Simple AP)	✓	-
Concurrent Connection	Ethernet and Wi-Fi Direct (Simple AP)	✓	-	
	Wi-Fi (Infrastructure) and Wi-Fi Direct (Simple AP)	✓	-	

Appendix

Functions			Supported	Remarks
Panel Operation	Wi-Fi Setup	Wi-Fi Setup Wizard	✓	-
		Push Button Setup (WPS)	✓	-
		PIN Code Setup	✓	-
		Wi-Fi Auto Connect	✓	-
		Epson iPrint Connection	-	-
		Wi-Fi Direct Setup	✓	-
	General Network Setup (device name, TCP/IP address, DNS server, proxy server)		✓	-
	Network Connection Check		✓	-
	Network Status		✓	-
	Network Status Sheet Printing		✓	-
	Disable Wi-Fi		✓	-
	Restore the Factory Default Settings		✓	-
	File Sharing Setup		✓	External USB storage only
Network Printing	EpsonNet Print (Windows)	IPv4	✓	-
	Standard TCP/IP (Windows)	IPv4, IPv6	✓	-
	WSD Printing (Windows)	IPv4, IPv6	✓	Windows Vista or later
	Bonjour Printing (Mac OS X)	IPv4, IPv6	✓	-
	IPP Printing (Windows, Mac OS X)	IPv4, IPv6	✓	-
	UPnP Printing	IPv4	-	Information appliance
	PictBridge Printing (Wi-Fi)	IPv4	-	Digital camera
	Epson Connect (Email Print)	IPv4	✓	-
	AirPrint (iOS, Mac OS X)	IPv4, IPv6	✓	iOS 5 or later, Mac OS X v10.7 or later
	Google Cloud Print	IPv4, IPv6	✓	-

Appendix

Functions			Supported	Remarks
Network Scanning	Epson Scan 2	IPv4, IPv6	✓	-
	Event Manager	IPv4	✓	-
	Epson Connect (Scan to Cloud)	IPv4	✓	-
	AirPrint (Scan)	IPv4, IPv6	✓	Mac OS X v10.9 or later
	ADF (2-sided scanning)		-	-
Fax	Send a fax	IPv4	✓	-
	Receive a fax	IPv4	✓	-
	AirPrint (Faxout)	IPv4, IPv6	✓	Mac OS X v10.8 or later

Wi-Fi Specifications

Standards	IEEE802.11b/g/n ^{*1*2}
Frequency Range	2.4 GHz
Maximum Radio-Frequency Power Transmitted	19.8 dBm (EIRP)
Coordination Modes	Infrastructure, Wi-Fi Direct (Simple AP) ^{*3}
Wireless Securities	WEP (64/128bit), WPA2-PSK (AES) ^{*4}

*1 Complies with either IEEE 802.11b/g/n or IEEE 802.11b/g depending on location of purchase.

*2 IEEE802.11n is only available for the HT20.

*3 Not supported for IEEE 802.11b.

*4 Complies with WPA2 standards with support for WPA/WPA2 Personal.

Ethernet Specifications

Standards	IEEE802.3i (10BASE-T) ^{*1} IEEE802.3u (100BASE-TX) IEEE802.3az (Energy Efficient Ethernet) ^{*2}
Communication Mode	Auto, 10Mbps Full duplex, 10Mbps Half duplex, 100Mbps Full duplex, 100Mbps Half duplex
Connector	RJ-45

*1 Use a category 5e or higher STP (Shielded twisted pair) cable to prevent risk of radio interference.

*2 The connected device should comply with IEEE802.3az standards.

Appendix

Security Protocol

SSL/TLS	HTTPS Server/Client, IPPS
SMTPS (STARTTLS, SSL/TLS)	

Supported Third Party Services

AirPrint	Print	iOS 5 or later/Mac OS X v10.7.x or later
	Scan	Mac OS X v10.9.x or later
	Fax	Mac OS X v10.8.x or later
Google Cloud Print		

External USB Device Specifications

Devices	Maximum Capacities
MO Drive*	1.3 GB
Hard Disk Drive* USB Flash Drive	2 TB (formatted in FAT, FAT32, or exFAT.)

* We do not recommend using external USB devices that are powered by USB. Use only external USB devices with independent AC power sources.

You cannot use the following devices:

- A device that requires a dedicated driver
- A device with security settings (password, encryption, and so on)
- A device with a built-in USB hub

Epson cannot guarantee all operations of externally connected devices.

Supported Data Specifications

File Format	JPEG taken by digital cameras DCF* ¹ version 1.0 or 2.0* ² compliant TIFF 6.0 compliant images as below <input type="checkbox"/> RGB full color images (not compressed) <input type="checkbox"/> Binary images (not compressed or CCITT encoded)
Image Size	Horizontal: 80 to 10200 pixels Vertical: 80 to 10200 pixels
File Size	Less than 2 GB

Appendix

Maximum Number of Files	JPEG: 9990* ³ TIFF: 999
-------------------------	---------------------------------------

*1 Design rule for Camera File system.

*2 Photo data stored on digital cameras with a built-in memory is not supported.

*3 Up to 999 files can be displayed at a time. (If the number of files exceeds 999, the files are displayed in groups.)

Note:

"!" is displayed on the LCD screen when the printer cannot recognize the image file. In this situation, if you select a multiple image layout, blank sections will be printed.

Dimensions

WF-4720 Series

Dimensions	<p>Storage</p> <ul style="list-style-type: none"> <input type="checkbox"/> Width: 425 mm (16.7 in.) <input type="checkbox"/> Depth: 378 mm (14.9 in.) <input type="checkbox"/> Height: 249 mm (9.8 in.) <p>Printing</p> <ul style="list-style-type: none"> <input type="checkbox"/> Width: 425 mm (16.7 in.) <input type="checkbox"/> Depth: 493 mm (19.4 in.) <input type="checkbox"/> Height: 249 mm (9.8 in.)
Weight*	Approx. 9.1 kg (20.1 lb)

* Without the ink cartridges and the power cord.

WF-4730 Series

Dimensions	<p>Storage</p> <ul style="list-style-type: none"> <input type="checkbox"/> Width: 425 mm (16.7 in.) <input type="checkbox"/> Depth: 388 mm (15.3 in.) <input type="checkbox"/> Height: 324 mm (12.8 in.) <p>Printing</p> <ul style="list-style-type: none"> <input type="checkbox"/> Width: 425 mm (16.7 in.) <input type="checkbox"/> Depth: 503 mm (19.8 in.) <input type="checkbox"/> Height: 324 mm (12.8 in.)
Weight*	Approx. 11.1 kg (24.5 lb)

* Without the ink cartridges and the power cord.

Electrical Specifications

WF-4720 Series

Rated Power Supply Voltage	100 to 240 V
Rated Frequency Range	50 to 60 Hz
Rated Current	0.6 to 0.4 A
Power Consumption (with USB Connection)	Standalone copying: Approx. 15 W (ISO/IEC24712) Ready mode: Approx. 6.1 W Sleep mode: Approx. 1.2 W Power off: Approx. 0.2 W

Note:

- Check the label on the printer for its voltage.
- For European users, see the following Website for details on power consumption.
<http://www.epson.eu/energy-consumption>

WF-4730 Series

Rated Power Supply Voltage	100 to 240 V
Rated Frequency Range	50 to 60 Hz
Rated Current	0.6 to 0.4 A
Power Consumption (with USB Connection)	Standalone copying: Approx. 15 W (ISO/IEC24712) Ready mode: Approx. 6.6 W Sleep mode: Approx. 1.2 W Power off: Approx. 0.2 W

Note:

- Check the label on the printer for its voltage.
- For European users, see the following Website for details on power consumption.
<http://www.epson.eu/energy-consumption>

Appendix

Environmental Specifications

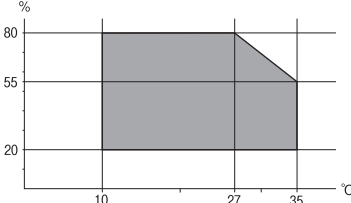
Operation	<p>Use the printer within the range shown in the following graph.</p>  <p>Temperature: 10 to 35°C (50 to 95°F) Humidity: 20 to 80% RH (without condensation)</p>
Storage	<p>Temperature: -20 to 40°C (-4 to 104°F)* Humidity: 5 to 85% RH (without condensation)</p>

* You can store for one month at 40°C (104°F).

Environmental Specifications for Ink Cartridges

Storage Temperature	-30 to 40 °C (-22 to 104 °F)*
Freezing Temperature	<p>-16 °C (3.2 °F) Ink thaws and is usable after approximately 3 hours at 25 °C (77 °F).</p>

* You can store for one month at 40 °C (104 °F).

System Requirements

- Windows 10 (32-bit, 64-bit)/Windows 8.1 (32-bit, 64-bit)/Windows 8 (32-bit, 64-bit)/Windows 7 (32-bit, 64-bit)/Windows Vista (32-bit, 64-bit)/Windows XP SP3 or later (32-bit)/Windows XP Professional x64 Edition SP2 or later/Windows Server 2012 R2/Windows Server 2012/Windows Server 2008 R2/Windows Server 2008/Windows Server 2003 R2/Windows Server 2003 SP2 or later
- Mac OS X v10.11.x/Mac OS X v10.10.x/Mac OS X v10.9.x/Mac OS X v10.8.x/Mac OS X v10.7.x/Mac OS X v10.6.8

Note:

- Mac OS X may not support some applications and features.
- The UNIX File System (UFS) for Mac OS X is not supported.

Regulatory Information

Standards and Approvals

Standards and Approvals for U.S. Model

Safety	UL60950-1 CAN/CSA-C22.2 No.60950-1
EMC	FCC Part 15 Subpart B Class B CAN/CSA-CEI/IEC CISPR 22 Class B

This equipment contains the following wireless module.

Manufacturer: Askey Computer Corporation

Type: WLU6320-D69 (RoHS)

This product conforms to Part 15 of the FCC Rules and RSS-210 of the IC Rules. Epson cannot accept responsibility for any failure to satisfy the protection requirements resulting from a non-recommended modification of the product. Operation is subject to the following two conditions: (1) this device may not cause harmful interference, and (2) this device must accept any interference received, including interference that may cause undesired operation of the device.

To prevent radio interference to the licensed service, this device is intended to be operated indoors and away from windows to provide maximum shielding. Equipment (or its transmit antenna) that is installed outdoors is subject to licensing.

This equipment complies with FCC/IC radiation exposure limits set forth for an uncontrolled environment and meets the FCC radio frequency (RF) Exposure Guidelines in Supplement C to OET65 and RSS-102 of the IC radio frequency (RF) Exposure rules. This equipment should be installed and operated so that the radiator is kept at least 7.9 inches (20 cm) or more away from a person's body (excluding extremities: hands, wrists, feet and ankles).

Standards and Approvals for European Model

For European users

Hereby, Seiko Epson Corporation declares that the following radio equipment model is in compliance with Directive 2014/53/EU. The full text of the EU declaration of conformity is available at the following website.

<http://www.epson.eu/conformity>

C582A, C582B

For use only in Ireland, UK, Austria, Germany, Liechtenstein, Switzerland, France, Belgium, Luxemburg, Netherlands, Italy, Portugal, Spain, Denmark, Finland, Norway, Sweden, Iceland, Croatia, Cyprus, Greece, Slovenia, Malta, Bulgaria, Czech, Estonia, Hungary, Latvia, Lithuania, Poland, Romania, and Slovakia.

Epson cannot accept responsibility for any failure to satisfy the protection requirements resulting from a non-recommended modification of the products.



Appendix

Standards and Approvals for Australian Model

EMC	AS/NZS CISPR22 Class B
-----	------------------------

Epson hereby declares that the following equipment Models are in compliance with the essential requirements and other relevant provisions of AS/NZS4268:

C582A, C582B

Epson cannot accept responsibility for any failure to satisfy the protection requirements resulting from a non-recommended modification of the products.

German Blue Angel

See the following website to check whether or not this printer meets the standards for the German Blue Angel.

<http://www.epson.de/blauerengel>

Restrictions on Copying

Observe the following restrictions to ensure the responsible and legal use of the printer.

Copying of the following items is prohibited by law:

- Bank bills, coins, government-issued marketable securities, government bond securities, and municipal securities
- Unused postage stamps, pre-stamped postcards, and other official postal items bearing valid postage
- Government-issued revenue stamps, and securities issued according to legal procedure

Exercise caution when copying the following items:

- Private marketable securities (stock certificates, negotiable notes, checks, etc.), monthly passes, concession tickets, etc.
- Passports, driver's licenses, warrants of fitness, road passes, food stamps, tickets, etc.

Note:

Copying these items may also be prohibited by law.

Responsible use of copyrighted materials:

Printers can be misused by improperly copying copyrighted materials. Unless acting on the advice of a knowledgeable attorney, be responsible and respectful by obtaining the permission of the copyright holder before copying published material.

Transporting the Printer

When you need to transport the printer to move or for repairs, follow the steps below to pack the printer.

Appendix

! *Important:*

- ❑ *When storing or transporting the printer, avoid tilting it, placing it vertically, or turning it upside down; otherwise ink may leak.*
- ❑ *Leave the ink cartridges installed. Removing the cartridges can dry out the print head and may prevent the printer from printing.*

1. Turn off the printer by pressing the  button.
2. Make sure the power light turns off, and then unplug the power cord.

! *Important:*

Unplug the power cord when the power light is off. Otherwise, the print head does not return to the home position causing the ink to dry, and printing may become impossible.

3. Make sure there are no external storage devices connected.
4. Disconnect all cables such as the power cord and USB cable.
5. Remove all of the paper from the printer.
6. Make sure there are no originals on the printer.
7. Open the scanner unit with the document cover closed. Secure the ink cartridge holder to the case with tape.

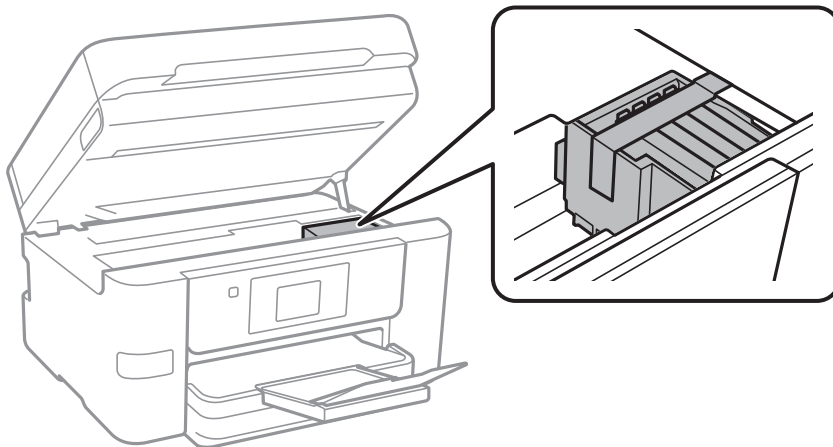

8. Close the scanner unit.

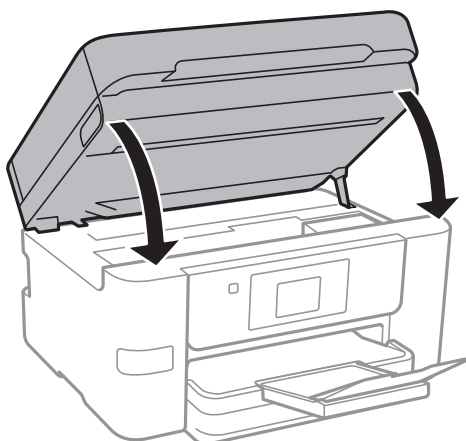

9. Prepare to pack the printer as shown below.

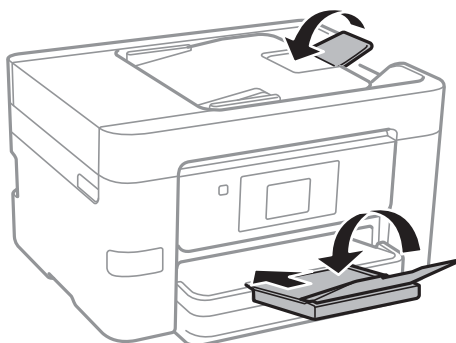

10. Pack the printer in its box, using the protective materials.

When you use the printer again, make sure you remove the tape securing the ink cartridge holder. If print quality has declined the next time you print, clean and align the print head.

Related Information

- ➔ [“Checking and Cleaning the Print Head” on page 145](#)
- ➔ [“Aligning the Print Head” on page 146](#)

Accessing an External USB Device From a Computer

You can write or read data on an external USB device such as a USB flash drive that has been inserted in the printer from a computer.

Important:

When sharing an external device inserted in the printer between computers connected over USB and over a network, write access is only allowed to the computers that are connected by the method you selected on the printer. To write to the external USB device, select a connection method from the following menu on the printer's control panel.

Settings > General Settings > Printer Settings > Memory Device Interface > File Sharing.

Appendix

Note:

It takes a while to recognize data from a computer if a large external USB device, such as 2TB HDD, is connected.

Windows

Select an external USB device in **Computer** or **My Computer**. The data on the external USB device is displayed.

Note:

If you connected the printer to the network without using the software disc or Web Installer, map a USB port as a network drive. Open **Run** and enter a printer name \\XXXXX or a printer's IP address \\XXX.XXX.XXX.XXX to **Open**. Right-click a device icon displayed to assign the network. The network drive appears in **Computer** or **My Computer**.

Mac OS X

Select a corresponding device icon. The data on the external USB device is displayed.

Note:

- To remove an external USB device, drag and drop the device icon to the trash icon. Otherwise, data in the shared drive may not be displayed correctly when another external USB device is inserted.
- To access an external storage device through the network, select **Go > Connect to Server** from the menu on the desktop. Enter a printer name `cifs://XXXXX` or `smb://XXXXX` (Where "xxxxx" is the printer name) in the **Server Address**, and then click **Connect**.

Restricting Access to an External USB Device From a Computer

You can make settings to authenticate the user for the following operations.

- Accessing from a computer to an external USB device, such as a USB flash memory, connected to the printer.
- Saving received faxes on a computer using FAX Utility.

Use Web Config or Epson Net Config to make the settings. The following describes the procedure for Web Config.

1. Start Web Config on the computer connected to the same network as the printer.
2. On the **Web Config** window, select **Services > MS Network**.
3. Select **Use Microsoft network sharing**.
4. Select **Enable** for **File Sharing**.
5. Enter a user name and password as the user authentication, and then click **Next**.
6. Confirm the entry, and then click **OK**.

Note:

You can check the current settings with a network status sheet.

Related Information

- ➔ [“Printing a Network Status Sheet” on page 37](#)

Using an Email Server

To use email features, you need to configure the email server.

Configuring Mail Server

Check the following before configuring the email server.

- The printer is connected to the network.
- The email server information, such as the documents from your service provider that you used to setup the email on your computer.

Note:

If you use a free email service, such as Internet email, search the Internet to get the email server information you need.

1. Tap **Settings** on the home screen.
2. Tap **General Settings** > **Network Settings** > **Advanced**.
3. Tap **Email Server** > **Server Settings**.
4. Select the authentication method of the email server you are using.



Important:

The following authentication methods are available.

- Off
- POP Before SmtP
- SMTP-AUTH

Contact your internet service provider to confirm the authentication method of the email server.

The printer may not be able to communicate with an email server even if the authentication method is available since security may be enhanced (for example SSL communication is necessary). Visit the Epson support website for the latest information.

<http://www.epson.eu/Support> (Europe)

<http://support.epson.net/> (outside Europe)

5. Make the appropriate settings.

The necessary settings vary depending on the authentication method. Enter the information for the email server you are using.

6. Tap **Proceed**.

Note:

- If an error message is displayed, check if the email server settings are correct.
- When you cannot send an email even if the connection check succeeds, check the authentication method for the email server you are using.

Related Information

➔ [“Email Server Setting Items”](#) on page 220

Appendix

Email Server Setting Items

Items	Explanations
Authenticated Account	If you select SMTP-AUTH or POP Before Smtplib as the Authentication Method , enter the user name (email address) registered to the email server within 255 characters or less.
Authenticated Password	If you select SMTP-AUTH or POP Before Smtplib as the Authentication Method , enter the password of the authenticated account within 20 characters or less.
Sender's Email Address	Specify the email address that the printer uses to send emails. You can specify the existing email address. To make it clear that the email is being sent from the printer, you can acquire an address specifically for the printer and enter it here.
SMTP Server Address	Enter the server address of the server that sends the email (SMTP server).
SMTP Server Port Number	Enter the port number of the server that sends the email (SMTP server).
POP3 Server Address	If you select POP Before Smtplib as the Authentication Method , enter the server address of the server that receives the email (POP3 server).
POP3 Server Port Number	If you select POP Before Smtplib as the Authentication Method , enter the port number of the email server that receives the email (POP3 server).
Secure Connection	If you select SMTP-AUTH or Off as the Authentication Method , select the method of the secure connection.

Checking an Email Server Connection

1. Tap **Settings** on the home screen.
2. Tap **General Settings** > **Network Settings** > **Advanced**.
3. Tap **Email Server** > **Connection Check** to check that the printer is connected to the email server.

Note:

- If an error message is displayed, check if the email server settings are correct.
- When you cannot send an email even if the connection check succeeds, check the authentication method for the email server you are using.

Messages Displayed During Connection Check

The following messages are displayed when performing a Connection Check to the email server. If an error occurs, check the message and the explanation to confirm the status.

Appendix

Messages	Explanation
Connection test was successful.	This message appears when the connection with the server is successful.
SMTP server communication error. Check the following. - Network Settings	This message appears when <ul style="list-style-type: none"> <input type="checkbox"/> The printer is not connected to a network <input type="checkbox"/> SMTP server is down <input type="checkbox"/> Network connection is disconnected while communicating <input type="checkbox"/> Received incomplete data
POP3 server communication error. Check the following. - Network Settings	This message appears when <ul style="list-style-type: none"> <input type="checkbox"/> The printer is not connected to a network <input type="checkbox"/> POP3 server is down <input type="checkbox"/> Network connection is disconnected while communicating <input type="checkbox"/> Received incomplete data
An error occurred while connecting to SMTP server. Check the followings. - SMTP Server Address - DNS Server	This message appears when <ul style="list-style-type: none"> <input type="checkbox"/> Connecting to a DNS server failed <input type="checkbox"/> Name resolution for an SMTP server failed
An error occurred while connecting to POP3 server. Check the followings. - POP3 Server Address - DNS Server	This message appears when <ul style="list-style-type: none"> <input type="checkbox"/> Connecting to a DNS server failed <input type="checkbox"/> Name resolution for an POP3 server failed
SMTP server authentication error. Check the followings. - Authentication Method - Authenticated Account - Authenticated Password	This message appears when SMTP server authentication failed.
POP3 server authentication error. Check the followings. - Authentication Method - Authenticated Account - Authenticated Password	This message appears when POP3 server authentication failed.
Unsupported communication method. Check the followings. - SMTP Server Address - SMTP Server Port Number	This message appears when you try to communicate with unsupported protocols.
Connection to SMTP server failed. Change Secure Connection to None.	This message appears when an SMTP mismatch occurs between a server and a client, or when the server does not support SMTP secure connection (SSL connection).
Connection to SMTP server failed. Change Secure Connection to SSL/TLS.	This message appears when an SMTP mismatch occurs between a server and a client, or when the server requests to use an SSL/TLS connection for an SMTP secure connection.
Connection to SMTP server failed. Change Secure Connection to STARTTLS.	This message appears when an SMTP mismatch occurs between a server and a client, or when the server requests to use an STARTTLS connection for an SMTP secure connection.
The connection is untrusted. Check the following. - Date and Time	This message appears when the printer's date and time setting is incorrect or the certificate has expired.
The connection is untrusted. Check the following. - CA Certificate	This message appears when the printer does not have a root certificate corresponding to the server or a CA Certificate has not been imported.
The connection is not secured.	This message appears when the obtained certificate is damaged.

Appendix

Messages	Explanation
SMTP server authentication failed. Change Authentication Method to SMTP-AUTH.	This message appears when an authentication method mismatch occurs between a server and a client. The server supports SMTP AUTH.
SMTP server authentication failed. Change Authentication Method to POP before SMTP.	This message appears when an authentication method mismatch occurs between a server and a client. The server does not support SMTP AUTH.
Sender's Email Address is incorrect. Change to the email address for your email service.	This message appears when the specified sender's Email address is wrong.
Cannot access the printer until processing is complete.	This message appears when the printer is busy.

Related Information

➔ [“Checking an Email Server Connection” on page 220](#)

Where to Get Help

Technical Support Web Site

If you need further help, visit the Epson support website shown below. Select your country or region and go to the support section of your local Epson website. The latest drivers, FAQs, manuals, or other downloadables are also available from the site.

<http://support.epson.net/>

<http://www.epson.eu/Support> (Europe)

If your Epson product is not operating properly and you cannot solve the problem, contact Epson support services for assistance.

Contacting Epson Support

Before Contacting Epson

If your Epson product is not operating properly and you cannot solve the problem using the troubleshooting information in your product manuals, contact Epson support services for assistance. If Epson support for your area is not listed below, contact the dealer where you purchased your product.

Epson support will be able to help you much more quickly if you give them the following information:

- Product serial number
(The serial number label is usually on the back of the product.)
- Product model
- Product software version
(Click **About**, **Version Info**, or a similar button in the product software.)

Appendix

- Brand and model of your computer
- Your computer operating system name and version
- Names and versions of the software applications you normally use with your product

Note:

Depending on the product, the dial list data for fax and/or network settings may be stored in the product's memory. Due to breakdown or repair of a product, data and/or settings may be lost. Epson shall not be responsible for the loss of any data, for backing up or recovering data and/or settings even during a warranty period. We recommend that you make your own backup data or take notes.

Help for Users in Europe

Check your Pan-European Warranty Document for information on how to contact Epson support.

Help for Users in Australia

Epson Australia wishes to provide you with a high level of customer service. In addition to your product manuals, we provide the following sources for obtaining information:

Internet URL

<http://www.epson.com.au>

Access the Epson Australia World Wide Web pages. Worth taking your modem here for the occasional surf! The site provides a download area for drivers, Epson contact points, new product information and technical support (e-mail).

Epson Helpdesk

Phone: 1300-361-054

Epson Helpdesk is provided as a final backup to make sure our clients have access to advice. Operators on the Helpdesk can aid you in installing, configuring and operating your Epson product. Our Pre-sales Helpdesk staff can provide literature on new Epson products and advise where the nearest dealer or service agent is located. Many types of queries are answered here.

We encourage you to have all the relevant information on hand when you ring. The more information you prepare, the faster we can help solve the problem. This information includes your Epson product manuals, type of computer, operating system, application programs, and any information you feel is required.

Transportation of Product

Epson recommends retaining product packaging for future transportation.

Help for Users in New Zealand

Epson New Zealand wishes to provide you with a high level of customer service. In addition to your product documentation, we provide the following sources for obtaining information:

Internet URL

<http://www.epson.co.nz>

Appendix

Access the Epson New Zealand World Wide Web pages. Worth taking your modem here for the occasional surf! The site provides a download area for drivers, Epson contact points, new product information and technical support (e-mail).

Epson Helpdesk

Phone: 0800 237 766

Epson Helpdesk is provided as a final backup to make sure our clients have access to advice. Operators on the Helpdesk can aid you in installing, configuring and operating your Epson product. Our Pre-sales Helpdesk staff can provide literature on new Epson products and advise where the nearest dealer or service agent is located. Many types of queries are answered here.

We encourage you to have all the relevant information on hand when you ring. The more information you prepare, the faster we can help solve the problem. This information includes your Epson product documentation, type of computer, operating system, application programs, and any information you feel is required.

Transportation of Product

Epson recommends retaining product packaging for future transportation.