

**SC-T5400 Series**  
**SC-T5400M Series**  
**SC-T3400 Series**  
**SC-T3400N Series**

**User's Guide**

---

## Copyrights and Trademarks

---

### **Copyrights and Trademarks**

No part of this publication may be reproduced, stored in a retrieval system, or transmitted in any form or by any means, electronic, mechanical, photocopying, recording, or otherwise, without the prior written permission of Seiko Epson Corporation. The information contained herein is designed only for use with this Epson printer. Epson is not responsible for any use of this information as applied to other printers.

Neither Seiko Epson Corporation nor its affiliates shall be liable to the purchaser of this product or third parties for damages, losses, costs, or expenses incurred by the purchaser or third parties as a result of accident, misuse, or abuse of this product or unauthorized modifications, repairs, or alterations to this product, or (excluding the U.S.) failure to strictly comply with Seiko Epson Corporation's operating and maintenance instructions.

Seiko Epson Corporation shall not be liable for any damages or problems arising from the use of any options or any consumable products other than those designated as Original Epson Products or Epson Approved Products by Seiko Epson Corporation.

Seiko Epson Corporation shall not be held liable for any damage resulting from electromagnetic interference that occurs from the use of any interface cables other than those designated as Epson Approved Products by Seiko Epson Corporation.

EPSON, EPSON EXCEED YOUR VISION, EXCEED YOUR VISION, and their logos are registered trademarks or trademarks of Seiko Epson Corporation.

Microsoft®, Windows®, and Windows Vista® are registered trademarks of Microsoft Corporation.

Apple, Mac, macOS, OS X, Bonjour, Safari, ColorSync, iPad, iPhone, iPod touch, iBeacon, AirPrint, and the AirPrint Logo are registered trademarks of Apple, Inc.

Chrome™, Chrome OS™, and Android™ are trademarks of Google Inc.

Intel® is a registered trademark of Intel Corporation.

Adobe and Reader are either registered trademarks or trademarks of Adobe Systems Incorporated in the United States and/or other countries.

HP-GL/2® and HP RTL® are registered trademarks of Hewlett-Packard Corporation.

The SuperSpeed USB Trident Logo is a registered trademark of USB Implementers Forum, Inc.

*General Notice: Other product names used herein are for identification purposes only and may be trademarks of their respective owners. Epson disclaims any and all rights in those marks.*

© 2018 Seiko Epson Corporation. All rights reserved.

**Contents**

**Contents**

**Copyrights and Trademarks**

**Introduction**

Notes on Manuals. . . . . 6  
 Meaning of Symbols. . . . . 6  
 Illustrations. . . . . 6  
 Product Model Descriptions. . . . . 6  
 Manual Organization. . . . . 6  
 Viewing Video Manuals. . . . . 6  
 Viewing PDF Manuals. . . . . 7  
 Printer Parts. . . . . 8  
 Front. . . . . 8  
 Scanner (SC-T5400M Series only). . . . . 9  
 Inside. . . . . 11  
 Side (right side). . . . . 13  
 Control panel. . . . . 15  
 Home screen operations. . . . . 15  
 Features of Printer. . . . . 18  
 Realizing High Productivity. . . . . 18  
 Realizing High Resolution. . . . . 18  
 Insistence on Ease-of-Use. . . . . 18  
 Notes on Usage and Storage. . . . . 20  
 Installation space. . . . . 20  
 Notes when using the printer. . . . . 20  
 Notes when not using the printer. . . . . 21  
 Notes on handling ink cartridges. . . . . 21  
 Notes on handling paper. . . . . 22  
 Saving Power. . . . . 23

**Introducing the Software**

Provided Software. . . . . 24  
 Built-in Software in the Printer. . . . . 25  
 How to Use Web Config. . . . . 26  
 How to Start. . . . . 26  
 Closing. . . . . 26  
 Function Summary. . . . . 26  
 How to Use Epson Edge Dashboard. . . . . 27  
 How to Start. . . . . 27  
 Closing. . . . . 27  
 Updating Software or Installing Additional Software. . . . . 28  
 Checking Whether Updates Available and Updating Software. . . . . 28  
 Receiving Update Notifications. . . . . 28  
 Uninstalling Software. . . . . 29

Windows. . . . . 29  
 Mac. . . . . 29

**Changing the Network Connection Methods**

Switching to Wired LAN. . . . . 30  
 Switching to Wireless LAN. . . . . 30  
 Directly Connection Wirelessly (Wi-Fi Direct). . . . . 31

**Loading and Setting the Paper**

Notes on Loading the Paper. . . . . 32  
 Paper Load Position. . . . . 32  
 Loading and Removing the Roll Paper. . . . . 33  
 Loading Roll Paper. . . . . 33  
 Cutting the Roll Paper. . . . . 36  
 Removing Roll Paper. . . . . 38  
 Loading and Removing Cut Sheet (1 sheet). . . . . 40  
 Loading Cut Sheet (1 sheet). . . . . 40  
 Removing Cut Sheet (1 Sheet). . . . . 41  
 Setting Loaded Paper. . . . . 42  
 For Roll Paper. . . . . 42  
 For Cut Sheet (1 sheet). . . . . 43  
 Optimizing Paper Settings (Media Adjust). . . . . 46  
 Notes on Making Adjustments. . . . . 46  
 Easy Adjustment. . . . . 46  
 Paper Feed Adjust (Auto). . . . . 47  
 Print Head Alignment (Auto). . . . . 47

**Printing with the Printer Driver from Your Computer**

Basic Operating Procedures (Windows). . . . . 49  
 Printing Procedure. . . . . 49  
 Canceling Printing. . . . . 51  
 Customizing the Printer Driver. . . . . 52  
 Basic Operating Procedures (Mac). . . . . 55  
 Printing Procedure. . . . . 55  
 Canceling Printing. . . . . 57  
 Customizing the Printer Driver. . . . . 57  
 Printing CAD Drawings. . . . . 59  
 Enlargements and Horizontal and Vertical Banners. . . . . 61  
 Fitting Documents to the Width of the Roll Paper. . . . . 62  
 Fitting Documents to the Output Size. . . . . 63

**Contents**

Choosing a Print Size. . . . . 65

Printing at Non-Standard Sizes. . . . . 66

Borderless Printing. . . . . 70

    Types of Borderless Printing Methods. . . . . 70

    Supported Paper. . . . . 70

    About Roll Paper Cutting. . . . . 71

    Setting Procedures for Printing. . . . . 72

Correct color and print. . . . . 74

Color Management Printing. . . . . 78

    About Color Management. . . . . 78

    Color Management Print Settings. . . . . 78

    Setting color management with the applications. . . . . 79

    Setting color management with the printer driver. . . . . 81

Multi-Page Printing (N-up). . . . . 85

Folded 2-Sided Printing (Windows only). . . . . 86

Poster Printing (Windows Only). . . . . 87

Printing Multiple Documents (Layout Manager) (Windows Only). . . . . 92

    Setting Procedures for Printing. . . . . 93

    Saving and Recalling Settings. . . . . 94

**Printing Using the HP-GL/2 or HP RTL Mode from a Computer**

Printer Settings. . . . . 95

    Basic Print Settings. . . . . 95

    HP-GL/2 Specific Print Settings. . . . . 95

CAD Application Settings. . . . . 96

**Printing without Using the Printer Driver**

Using AirPrint. . . . . 97

Direct Printing via the Web (Upload and Print) (SC-T5400M Series Only). . . . . 97

    Function Summary. . . . . 97

    Upload and Print Procedure. . . . . 97

Printing Files from a Shared Folder (Print from Folder) (SC-T5400M Series Only). . . . . 98

    Function Summary. . . . . 98

    Preparing a Shared Folder. . . . . 98

    Print from Folder Procedure. . . . . 99

Direct Printing of Files on USB Flash Memory. . . . . 99

**Copy (SC-T5400M Series Only)**

Placing Documents in the Scanner. . . . . 101

Loadable Document Sizes. . . . . 101

Loadable Paper Types. . . . . 101

Documents That Cannot Be Loaded. . . . . 101

    When loading documents that are thin, that are easily torn, or that you do not want to damage. . . . . 102

How to Load Documents. . . . . 102

Procedure for Copying. . . . . 103

**Scanning (SC-T5400M Series Only)**

Function Summary. . . . . 104

Preparing to Scan. . . . . 104

Procedure for Scanning. . . . . 105

    Scanning and Saving an Image to a Shared Folder or FTP Server. . . . . 105

    Scanning and Attaching an Image to an Email . . . . . 106

    Scanning and Saving an Image to a Memory Device. . . . . 107

**Making Enlarged Copies with an A3 or A4 Scanner (SC-T5400 Series/SC-T3400 Series/SC-T3400N Series Only)**

Connecting the Scanner. . . . . 108

Making Enlarged Copies. . . . . 109

Placing Documents in the Scanner. . . . . 110

**Using the Menu**

Menu List. . . . . 111

Paper Setting menu. . . . . 133

    Roll Paper menu. . . . . 133

    Cut Sheet (1 sheet) menu. . . . . 137

Printer Status menu. . . . . 139

Settings menu. . . . . 140

    General Settings. . . . . 140

    Maintenance. . . . . 160

    Printer Status/Print. . . . . 161

Enlarged Copy menu (SC-T5400 Series/SC-T3400 Series/SC-T3400N Series Only). . . . . 162

Memory Device menu. . . . . 164

Copy menu (SC-T5400M Series Only). . . . . 167

Scan menu (SC-T5400M Series Only). . . . . 171

Network Folder menu (SC-T5400M Series Only) . . . . . 179

## Contents

### **Maintenance**

Cleaning the Platen. . . . .	182
Handling of Used Consumables. . . . .	183
Replacing Ink Cartridges. . . . .	183
Replacing Maintenance Box. . . . .	185
Replacing the Cutter. . . . .	186

### **Problem Solver**

What to do When a Message is Displayed. . . . .	188
When a Maintenance Call/Printer Error Occurs . . . . .	189
Troubleshooting. . . . .	190
You cannot print (because the printer does not work). . . . .	190
The print head moves, but nothing prints.. . . .	192
The prints are not what you expected. . . . .	193
Feeding or ejecting problems. . . . .	205
Others. . . . .	209
Copying or Scanning Problems (SC-T5400M Series Only). . . . .	209

### **Appendix**

Options and Consumable Products. . . . .	214
Epson Special Media. . . . .	214
Ink Cartridges. . . . .	214
Others. . . . .	215
Supported Media. . . . .	216
Epson Special Media Table. . . . .	216
Supported Commercially Available Paper. . . . .	220
Printable area. . . . .	223
Roll Paper. . . . .	223
Cut Sheet. . . . .	224
Moving or Transporting the Printer. . . . .	225
Notes for Moving or Transporting the Printer . . . . .	225
Moving to a Different Location in the Same Building. . . . .	225
When Transporting. . . . .	226
Handling if Transporting/Leaving the Printer in an Environment of -10°C or Less. . . . .	226
System Requirements. . . . .	227
Printer Driver. . . . .	227
Web Config. . . . .	228
Specifications Table. . . . .	230
For European users. . . . .	232

### **Where To Get Help**

Technical Support Web Site. . . . .	233
Contacting Epson Support. . . . .	233
Before Contacting Epson. . . . .	233
Help for Users in North America. . . . .	234
Help for Users in Europe. . . . .	234
Help for Users in Australia. . . . .	234
Help for Users in Singapore. . . . .	235
Help for Users in Thailand. . . . .	235
Help for Users in Vietnam. . . . .	235
Help for Users in Indonesia. . . . .	235
Help for Users in Hong Kong. . . . .	236
Help for Users in Malaysia. . . . .	236
Help for Users in India. . . . .	236
Help for Users in the Philippines. . . . .	237

**Introduction**

# Introduction

## Notes on Manuals

### Meaning of Symbols

 <b>Warning:</b>	Warnings must be followed to avoid serious bodily injury.
---	---

 <b>Caution:</b>	Cautions must be followed to avoid bodily injury.
---	---

 <b>Important:</b>	Important must be followed to avoid damage to this product.
---	---

<b>Note:</b>	Notes contain useful or additional information on the operation of this product.
--------------	--

	Indicates related reference content.
---	--------------------------------------

### Illustrations

The illustrations may differ slightly from the model you are using. Please be aware of this when using the manuals.

### Product Model Descriptions

Some models described in this manual may not be sold in your country or region.

## Manual Organization

The manuals for the product are organized as shown below.

You can view the PDF manuals using Adobe Acrobat Reader or Preview (Mac).

Setup Guide (booklet)	Provides information on how to setup the printer after unpacking it from the box. Make sure you read this manual to perform operations safely.
Operator's Guide (booklet or PDF)	Provides selected information on how to use the printer and frequently used features of the printer.
General Information (PDF)	Provides important safety instructions, printer specifications and contact details.
Online Manual	
User's Guide (this manual)	Provides overall information and instructions on using the printer and on solving problems.
Administrator's Guide (PDF)	Provides network administrators with information on management and printer settings.

### Viewing Video Manuals

The video manuals have been uploaded to YouTube.

Click **Epson Video Manuals** from the top page of Online Manuals, or click the following blue text to view the manuals.

[Epson Video Manuals](#)

## Introduction

If the subtitles are not displayed when you play the video, click the subtitles icon shown in the image below.

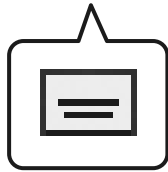

## Viewing PDF Manuals

This section uses the Adobe Acrobat Reader DC as an example to explain the basic operations for viewing the PDF in Adobe Acrobat Reader.

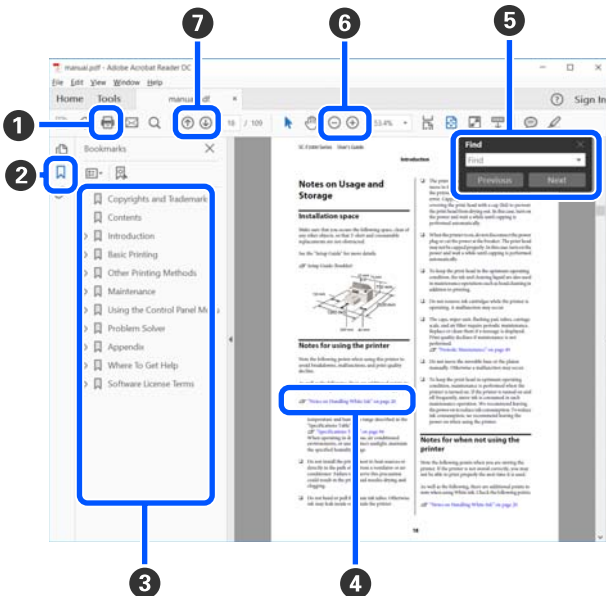

- 1 Click to print the PDF manual.
- 2 Each time it is clicked the bookmarks are hidden or shown.

- 3 Click the title to open the relevant page.  
Click [+] to open the titles lower in the hierarchy.
- 4 If the reference is in blue text, click the blue text to open the relevant page.

To return to the original page, do the following.

### For Windows

While pressing the Alt key, press the ← .

### For Mac

While pressing the command key, press the ← .

- 5 You can input and search for keywords, such as the names of items you want to confirm.

### For Windows

Right click on a page in the PDF manual and select **Find** in the menu that is displayed to open the search toolbar.

### For Mac

Select **Find** in the **Edit** menu to open the search toolbar.

- 6 To enlarge the text in the display that is too small to see well, click ⊕ . Click ⊖ to reduce the size. To specify a part of an illustration or screenshot to enlarge, do the following.

### For Windows

Right click on the page in the PDF manual and select **Marquee Zoom** in the menu that is displayed. The pointer changes to a magnifying glass, use it to specify the range of the place you want to enlarge.

### For Mac

Click **View** menu - **Zoom** - **Marquee Zoom** in this order to change the pointer to a magnifying glass. Use the pointer as a magnifying glass to specify the range of the place you want to enlarge.

- 7 Opens the previous page or next page.

## Introduction

# Printer Parts

## Front

The illustration shows the SC-T3400 Series (24 inch model with stand).

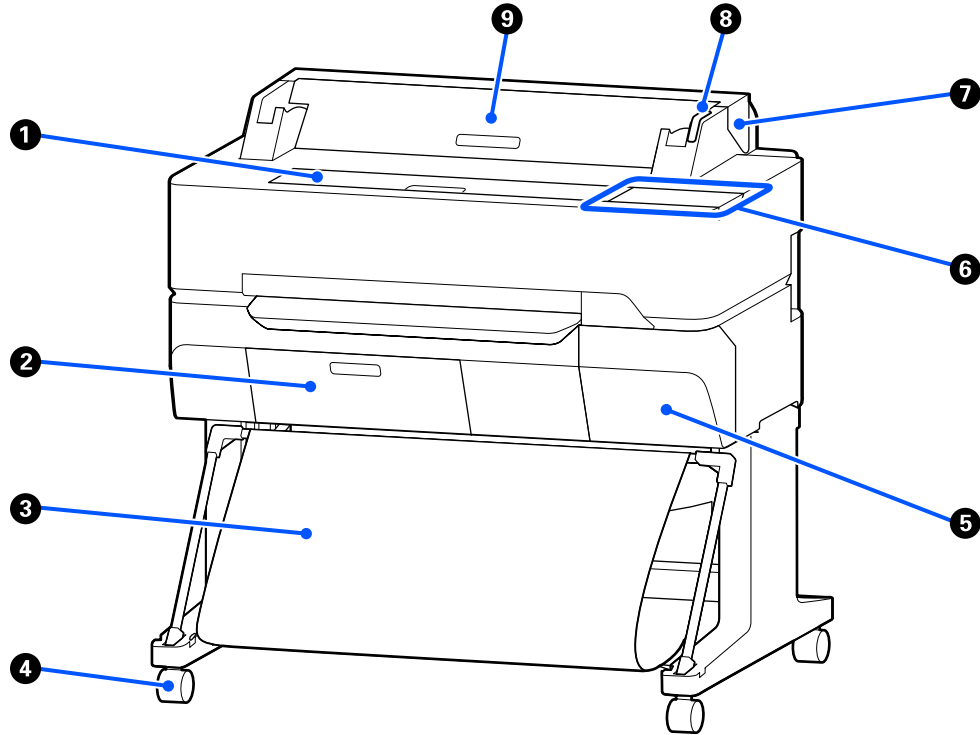

### 1 Front cover

Open the cover when cleaning inside of the printer or clearing jams.

### 2 Maintenance box cover

Open the cover when replacing the Maintenance Box.

 [“Replacing Maintenance Box” on page 185](#)

### 3 Paper basket

Output from the printer collects in this basket, keeping the media clean and free of creases.

### 4 Casters

There are two casters on each leg. The casters are normally kept locked once the printer is in place.

### 5 Cartridge cover

Open when replacing ink cartridges.

 [“Replacing Ink Cartridges” on page 183](#)



## Introduction

### 6 Control panel

 [“Control panel” on page 15](#)

### 7 Roll paper cover

This cover protects the loaded roll paper and prevents dust from entering inside the printer. Except when loading or removing roll paper, it should be closed when using the printer.

 [“Loading Roll Paper” on page 33](#)

### 8 Alert lamp

This lamp lights or flashes when an error occurs.

Lights or flashes: An error occurred. How the lamp lights or flashes varies with the type of error. The control panel displays a description of the error.

Off: No error.

### 9 Cut sheet cover

Open the cover when loading a cut sheet of paper.

 [“Loading Cut Sheet \(1 sheet\)” on page 40](#)

---

## Scanner (SC-T5400M Series only)

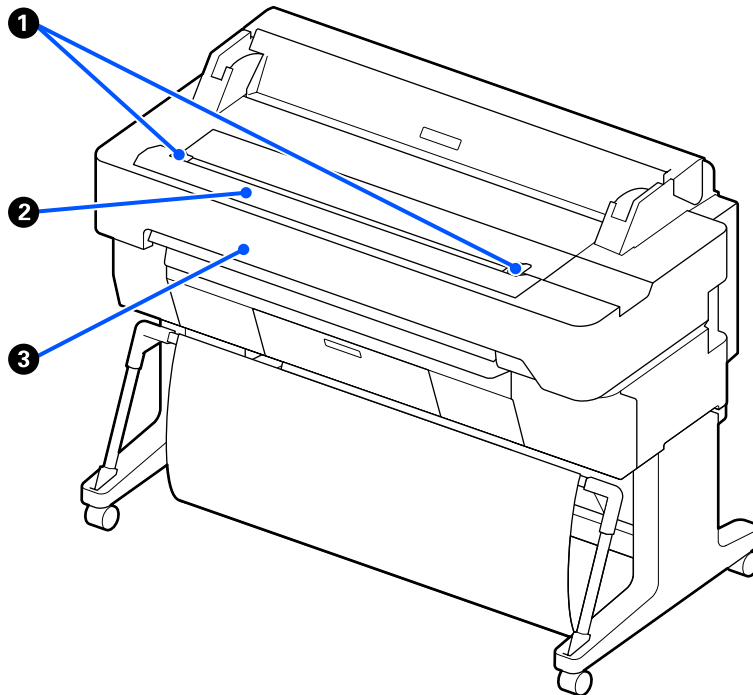

### 1 Document guide

This guide allows you to feed originals straight into the printer.

## Introduction

### ② Scanner's paper slot

This paper slot is for feeding originals that you are copying or scanning.

### ③ Scanner cover

Open this when there is a paper jam, or when you want to clean the scanner.

## Introduction

---

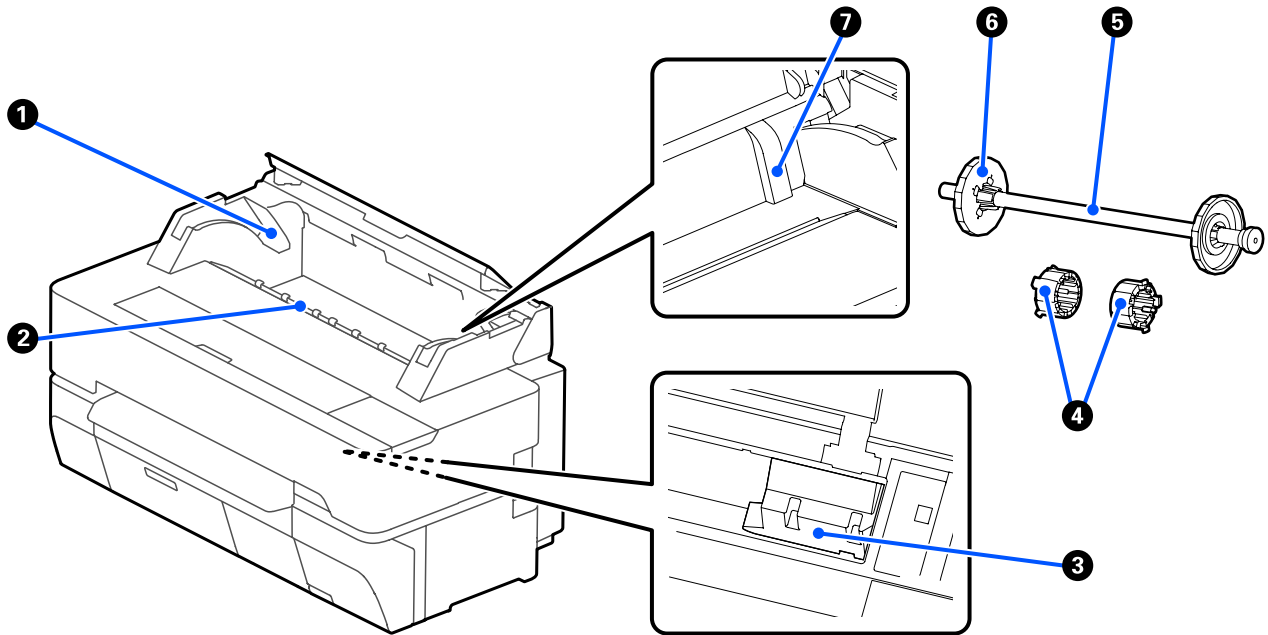
**Inside**
**1 Spindle holder**

There is a holder on both the left and right sides. Place the both ends of the spindle.

[“Loading Roll Paper” on page 33](#)

**2 Paper slot**

The slot through which roll paper and cut sheets are fed during printing.

**3 Print head**

Fires ink via high density nozzles while moving left and right to print.

**4 Attachments**

Attach them to the spindle for loading a 3 inch core roll of plain paper.

[“Loading Roll Paper” on page 33](#)

**5 Spindle**

When loading roll paper into the printer, insert this through the roll paper.

**6 Movable flange (transparent)**

This fixes the roll paper placed on the spindle. Attach or detach it when placing or removing roll paper on/ from the spindle.

## Introduction

### ⑦ Guide

When loading a cut sheet of paper, load the sheet while sliding its edge against the guide.

 [“Loading and Removing Cut Sheet \(1 sheet\)” on page 40](#)

## Introduction

### Side (right side)

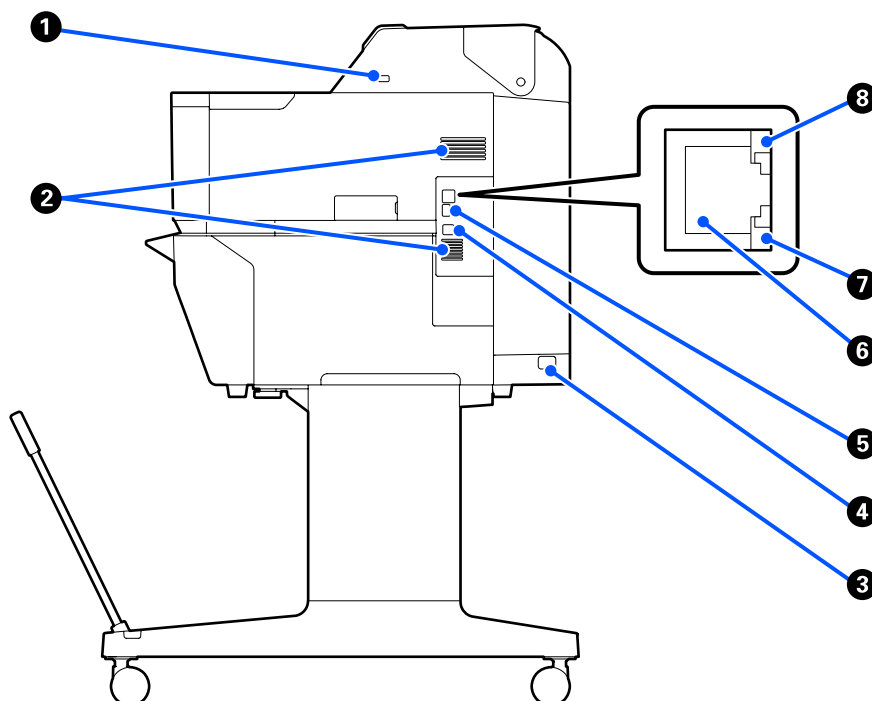

#### 1 USB port (for USB flash drive)

You can insert USB flash drive for direct printing.

[☞ “Direct Printing of Files on USB Flash Memory” on page 99](#)

#### 2 Vents

Do not block the vents.

[☞ “Installation space” on page 20](#)

#### 3 AC inlet

Connect the supplied power cable here.

#### 4 USB port

Use when connecting to a computer using a USB cable.

#### 5 OPTION port

Connect a scanner to perform enlarged copying.

[☞ “Making Enlarged Copies with an A3 or A4 Scanner \(SC-T5400 Series/SC-T3400 Series/SC-T3400N Series Only\)” on page 108](#)

#### 6 LAN port

Connects the LAN cable.

## Introduction

### 7 Data light (yellow)

The network connection status and data reception are indicated by a lit or flashing light.

On: Connected.

Flashing: Receiving data.

### 8 Status light (green, orange)

The color indicates the network transmission speed.

Off: 10BASE-T

Orange: 100BASE-TX

Green: 1000BASE-T

## Introduction

## Control panel

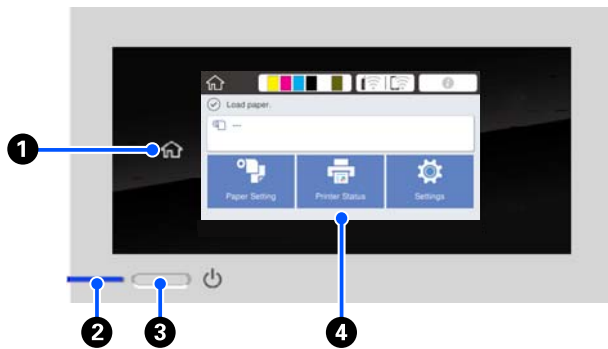
**1 Home button**

Touch this button while a menu is displayed to return to the Home screen. The home button is off when it cannot be used during operations such as paper feeding.

**2 Power light (power light)**

On : The power is on.

Flashing : The printer is performing a process such as starting up, powering off, data receiving, or print head cleaning. Please wait without performing any operation until this light stops flashing. Do not disconnect the power cord.

Off : The power is off.

**3 Power button (power button)**

Turns the power on and off.

**4 Screen**

This is a touch panel to display the printer's status, menus, error messages, and so on. You can select the menu items and options displayed on this screen by gently touching (tapping) them, and scroll the screen by moving your finger while it remains touching the screen.

## Home screen operations

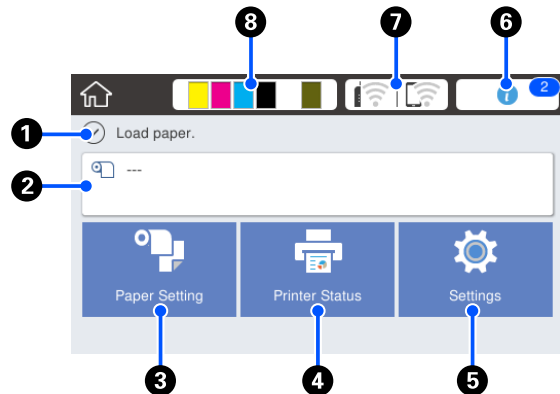

## Overview of Home screen operations

[Operator's Guide](#) (booklet or PDF)

**1 Information display area**

Displays the printer's status, error messages, and so on.

**2 Roll paper information area**

When roll paper is loaded  
Displays information on the loaded roll paper. When Manage Remaining Amount is set to On, the approximate remaining amount (remaining length) is displayed.

Touching this area displays a menu to perform operations such as setting and adjusting the roll paper.

["Roll Paper menu" on page 133](#)

When roll paper is not loaded  
Displays "---". Touching this area displays the procedure for loading roll paper.

**3 Paper Setting menu button**

Touch this button when loading, removing, setting, or adjusting paper.

See the following for more details on Roll Paper.  
["Loading and Removing the Roll Paper" on page 33](#)

Menu descriptions

["Roll Paper menu" on page 133](#)

See the following for more details on Cut Sheet(1 sheet).

["Loading and Removing Cut Sheet \(1 sheet\)" on page 40](#)

Menu descriptions

["Cut Sheet \(1 sheet\) menu" on page 137](#)

## Introduction

### 4 Printer Status menu button

Touch this button when you want to check the status of consumables or details of displayed notifications.

 [“Printer Status menu” on page 139](#)

### 5 Settings menu button

Touch this button when you want to perform maintenance or configure the printer operation settings, network settings, or other settings. See the following for more details.

 [“Settings menu” on page 140](#)

### 6 Information icon







When there are notifications, such as consumable remaining amount low warnings, the number of notifications is indicated by a badge at the top right of this icon. If you touch this icon when the badge is displayed, a list of the notifications that require your action is displayed. Touching each item displays instructions on what to do. If you do not perform the actions, the badge will not disappear.

### 7 Network icon

The network connection status is indicated by an icon as shown below.

Touching the icon allows you to switch the network connection status.

 [“Changing the Network Connection Methods” on page 30](#)

	Not connected to a wired LAN or the wired LAN or wireless LAN not set.
	Connected to a wired LAN.
	Wireless LAN (Wi-Fi) is disabled.
	Searching for SSID, IP address not set, or signal strength is 0 or poor.
	Connected to a wireless LAN (Wi-Fi). The number of lines indicates the signal strength. The more lines there are, the better the signal strength.
	Wi-Fi Direct (simple AP) connection is disabled.

	Wi-Fi Direct (simple AP) connection is enabled.
---	---

### 8 Consumables status icon

Estimates of the remaining amounts of ink cartridges and the empty space in the Maintenance Box are indicated by the length of the bars. The shorter a bar is, the lower the remaining amount of ink or space.

When  is displayed, the remaining amount of the corresponding ink cartridge or the amount of empty space in the Maintenance Box is low. Touching the icon displays the consumables status screen so that you can check the ink cartridge and Maintenance Box product numbers. This is a shortcut button for **Supply Status** in the **Printer Status** menu.

 [“Printer Status menu” on page 139](#)



## Introduction

**Note:**

- Connecting a supported scanner to the printer displays a **Enlarged Copy** button on the screen (SC-T5400 Series/SC-T3400 Series/SC-T3400N Series only).  
Inserting USB flash drive into the printer displays a **Memory Device** button on the screen.

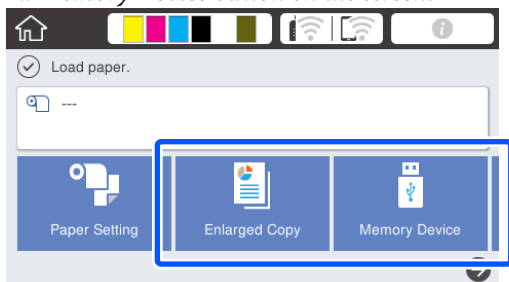

[“Making Enlarged Copies with an A3 or A4 Scanner \(SC-T5400 Series/SC-T3400 Series/SC-T3400N Series Only\)” on page 108](#)

[“Direct Printing of Files on USB Flash Memory” on page 99](#)

- The **Copy**, **Scan**, and **Network Folder** buttons appear on the SC-T5400M Series.

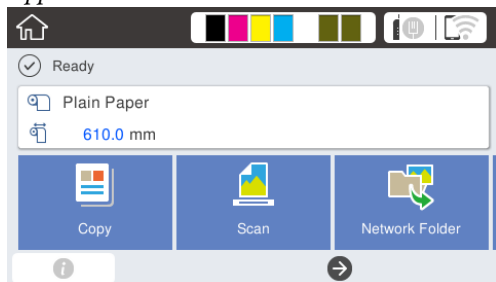

[“Copy \(SC-T5400M Series Only\)” on page 101](#)

[“Scanning \(SC-T5400M Series Only\)” on page 104](#)

[“Printing Files from a Shared Folder \(Print from Folder\) \(SC-T5400M Series Only\)” on page 98](#)

## Introduction

# Features of Printer

---

## Realizing High Productivity

### High-speed printing

The speeds of the print head and paper feed have been increased for faster printing.

The printer is equipped with a high-speed rotary cutter for quick cutting, significantly increasing productivity.

### Support for large-capacity roll paper

Roll paper up to 170 mm outer diameter can be loaded. This reduces roll paper replacement time and person-hours, enabling efficient high-volume printing.

### Reducing print waste with the print head nozzle self-cleaning function

The printer has a Self Check and Cleaning function that automatically detects and removes clogging of print head nozzles. This reduces decreases in print quality from clogging.

 [“General Settings - Printer Settings” on page 142](#)

## Realizing High Resolution

### CAD drawings that are clear, legible, and can even be used safely outdoors

Newly-developed Epson UltraChrome XD2 ink enables the printer to produce extremely detailed drawings both in black and white and in color.

The supplied printer driver offers a line drawing mode, making it easier to optimize printing for line drawing and, through unsurpassed reproduction of line drawing and fine lines in the form of connected lines, diagonals, and curves, ensuring the best possible results when the printer is used for drawings.

In addition, you can even safely take your drawings outdoors with you because they are printed using ink with excellent water resistance.

 [“Printing CAD Drawings” on page 59](#)

### Posters and displays that are vivid and also allow for short-term outdoor display

Posters with vivid hues can be printed simply by selecting, for example, **Poster (Photo)/Perspective** in Select Target of the supplied printer driver.

Short-term outdoor display is even supported since ink that also has excellent light fastness is used.

Your posters will last even longer if you use lamination processing.

The effect differs depending on the paper.

## Insistence on Ease-of-Use

---

### Back and side can be placed next to a wall

All work, such as replacing ink cartridges, maintenance boxes, and cutters, as well as loading roll paper and originals (SC-T5400M Series only), are done from the front of the printer, allowing the back and side of the printer to be placed against a wall. You do not need to turn the printer around, thus it can easily be situated in confined spaces.

See the following for dimensions.

 [“Specifications Table” on page 230](#)

### Checking current operating status even from afar thanks to an alert lamp

Errors such as ink or paper running out are immediately obvious even at a distance, thanks to the large, highly visible alert lamp.

### Smooth operation while checking the operating instructions on the screen

In addition to having a screen design that enables intuitive operation, this printer allows you to check illustrated instructions of operations such as how to load paper.

 [Operator's Guide \(booklet or PDF\)](#)

## Introduction

### Printer driver that is simple and easy to operate

Print settings can be optimized simply by choosing the desired use or target. This spares you the trouble of adjusting print settings individually. When you select a Source setting, printing failures due to paper loading mistakes are reduced because the size and type of paper loaded in the printer are applied automatically. In addition to checking the set conditions in an illustration in the printer driver, you can also check a detailed image in the preview screen before printing.

### Support for wireless LAN connection

This printer can be freely placed where desired without considering cable routing because it can connect with a computer via a wireless LAN to print. Of course, it also supports a wired LAN connection.

Furthermore, even if your device is not connected to a LAN, this printer also allows printing by directly connecting with it using Wi-Fi Direct.

 [“Switching to Wireless LAN” on page 30](#)

 [“Directly Connection Wirelessly \(Wi-Fi Direct\)” on page 31](#)

### Installing a color sensor (SC-T5400M Series)

By installing a color sensor, shadows from creases are less likely to appear in the results of copies and scans.

The color sensor also improves the reproduction of highlighted parts when you copy or scan originals that have parts written in highlighter.

**Introduction**

# Notes on Usage and Storage

## Installation space

Make sure that you secure the following space, clear of any other objects, so that paper ejection and consumable replacement are not obstructed.

See the “Specifications Table” for the external dimensions of the printer.

“Specifications Table” on page 230

### SC-T5400 Series/SC-T5400M Series/SC-T3400 Series

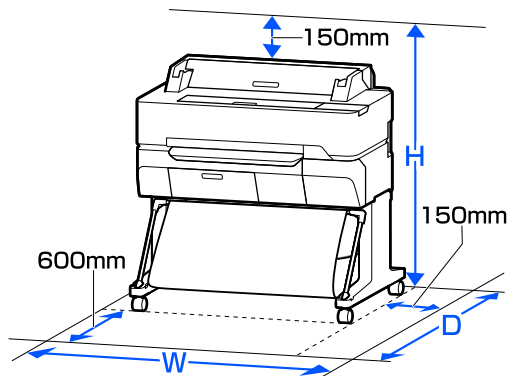

	W	D	H
SC-T5400 Series/ SC-T5400M Series	1535 mm	1350 mm	1210 mm
SC-T3400 Series	1230 mm	1350 mm	1210 mm

### SC-T3400N Series

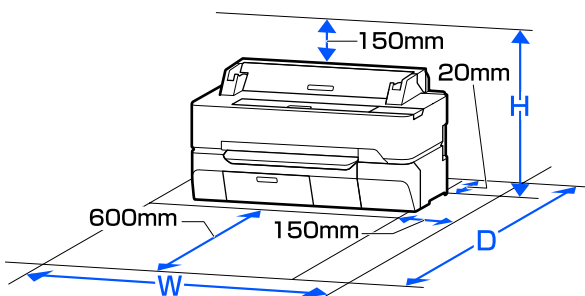

	W	D	H
SC-T3400N Series	1230 mm	1288 mm	735 mm

## Notes when using the printer

Note the following points when using this printer to avoid breakdowns, malfunctions, and print quality decline.

- When using the printer, observe the operating temperature and humidity range described in the "Specifications Table".  
 “Specifications Table” on page 230  
Even when the conditions above are met, you may not be able to print properly if the environmental conditions are not suitable for the paper. Be sure to use the printer in an environment where the paper's requirements are met. For more details, see the documentation supplied with the paper. Also, when operating in dry areas, air conditioned environment, or under direct sunlight, maintain the appropriate humidity.
- Do not install the printer next to heat sources or directly in the path of air from a ventilator or air conditioner. Failure to observe this precaution could result in the print head nozzles drying and clogging.
- The print head may not be capped (i.e., may not move to the right-hand side) if an error occurs and the printer is turned off without first resolving the error. Capping is a function for automatically covering the print head with a cap (lid) to prevent the print head from drying out. In this case, turn on the power and wait a while until capping is performed automatically.
- When the power is on, do not remove the power plug or cut the power at the breaker. The print head may not be capped properly. In this case, turn on the power and wait a while until capping is performed automatically.
- The printer may automatically perform print head cleaning to maintain good printing quality. Please wait until cleaning finishes without opening any of the covers or turning off the power.

## Introduction

### Notes when not using the printer

If you are not using it, note the following points when storing the printer. If it is not stored correctly, you may not be able to print properly the next time it is used.

- ❑ When storing the printer, store it flat with the ink cartridges installed. Do not place the printer tilted, upright, or upside down.
- ❑ If you do not print for a long time, the print head nozzles may become clogged. We recommend that you print once a week to prevent the print head from clogging.
- ❑ The roller may leave an impression on paper that is left in the printer. This can also cause wavy or curled paper resulting in paper feeding problems or the print head could be scratched. Remove any paper when storing.
- ❑ Store the printer after confirming that the print head has been capped (the print head is positioned at the far right). If the print head is left uncapped for a long time, the print quality may decline.

**Note:**

*If the print head is not capped, turn the printer on, and then turn it off.*

- ❑ To prevent the accumulation of dust and other foreign matter in the printer, close all covers before placing it in storage.  
If the printer will be not be used for an extended period, protect it with an anti-static cloth or other cover.  
The print head nozzles are very small, and they can become clogged easily if fine dust gets on the print head, and you may not be able to print properly.
- ❑ The print head may fail if the environmental temperature becomes -10°C or lower. If the environmental temperature in the room or during transport is expected to become -10°C or lower, be sure to discharge the ink in advance.  
[☞ “Handling if Transporting/Leaving the Printer in an Environment of -10°C or Less” on page 226](#)

### Notes on handling ink cartridges

Note the following points when handling ink cartridges to maintain good print quality.

- ❑ The ink cartridges packaged with your printer are partly used during initial setup. In order to produce high quality printouts, the print head in your printer will be fully charged with ink. This one-off process consumes a quantity of ink and therefore these cartridges may print fewer pages compared to subsequent ink cartridges.
- ❑ We recommend that ink cartridges be stored at room temperature out of direct sunlight and used before the expiry date printed on the packaging.
- ❑ To ensure good results, we recommend that all the ink in the cartridge be used within a year of installation.
- ❑ Ink cartridges that have been stored at low temperatures for an extended period should be allowed to return to room temperature over a period of at least four hours.
- ❑ Do not touch the IC chips on the ink cartridges. You may not be able to print properly.  
[☞ “Replacing Ink Cartridges” on page 183](#)
- ❑ Install ink cartridges into all slots. You cannot print if any of the slots are empty.
- ❑ Do not leave the printer without ink cartridges installed. The ink in the printer may dry, preventing it from printing as expected. Leave ink cartridges in all slots even while you do not use the printer.
- ❑ The ink level and other data are stored in the IC chip, allowing cartridges to be used after being removed and replaced.
- ❑ To avoid getting dirt on the ink supply port, store the removed ink cartridge properly. The ink supply port has a valve in it so it does not need to be capped.
- ❑ Removed ink cartridges may have ink around the ink supply port, so be careful not to get any ink on the surrounding area when removing the cartridges.

## Introduction

- ❑ To maintain the quality of the print head, this printer stops printing before ink cartridges are completely expended.
- ❑ Although the ink cartridges may contain recycled materials, this does not affect printer function or performance.
- ❑ Do not dismantle or remodel ink cartridges. You may not be able to print properly.
- ❑ Do not drop or otherwise subject an ink cartridge to a strong impact. Ink may leak from the cartridge.
- ❑ A mixture of color inks may be used to print black depending on the paper type and print quality settings even for black and white and grayscale printing.

---

### Notes on handling paper

Note the following points when handling and storing the paper. If the paper is not in good condition, print quality may decline.

Check the documentation supplied with each paper.

### Notes on Handling

- ❑ Use Epson special media under normal room conditions (temperature: 15 to 25°C, humidity: 40 to 60%).
- ❑ Do not fold the paper or scratch the surface of the paper.
- ❑ Avoid touching the printable surface of the paper with your bare hands. Moisture and oils from your hands can affect print quality.
- ❑ Handle paper by the edges. We recommend wearing cotton gloves.
- ❑ Changes in temperature and humidity may cause paper to become wavy or curled. Check the following points.
  - ❑ Load the paper just before printing.
  - ❑ Do not use wavy or curled paper. For roll paper, cut off the wavy or curled parts and then load it again. For cut sheets, use new paper.

- ❑ Do not wet the paper.
- ❑ Do not throw away the paper packaging as you can use it for storing the paper.
- ❑ Avoid locations that are subject to direct sunlight, excessive heat, or humidity.
- ❑ Keep cut sheets in their original package after opening, and keep them in a flat place.
- ❑ Remove roll paper that is not in use from the printer. Rewind it correctly and then store it in the original packaging that came with the roll paper. If you leave the roll paper in the printer for a long time, its quality may decline.

### Notes on handling printed paper

To maintain long lasting, high quality print results, note the following points.

- ❑ Do not rub or scratch print outs. If they are rubbed or scratched, the ink may peel off.
- ❑ Do not touch the surface of print outs. The ink may peel off.
- ❑ Make sure the print outs are completely dry before folding or stacking; otherwise, the color may change where they touch (leaves a mark). These marks will disappear if they are separated immediately and dried; however, they will remain if not separated.
- ❑ If you put the print outs in an album before they are completely dry, they may be blurred.
- ❑ Do not use a dryer to dry the print outs.
- ❑ Avoid direct sunlight.
- ❑ Prevent color distortion while displaying or storing the print outs by following the instructions in the paper's documentation.

## Introduction

### Note:

Typically, print outs and photos fade over time (color distortion) due to the effects of light and various constituents in the air. This also applies to Epson special media. However, with the correct storage method, the degree of color distortion can be minimized.

- ❑ See the documentation supplied with Epson special media for detailed information on handling the paper after printing.
- ❑ The colors of photos, posters, and other printed materials appear different under different lighting conditions (light sources\*). The colors of print outs from this printer may also appear different under different light sources.  
\* Light sources include sunlight, fluorescent light, incandescent light, and other types.

## Saving Power

The printer enters sleep mode or turns off automatically if no operations are performed for a set period. You can adjust the time before power management is applied. Any increase will affect the product's energy efficiency. Please consider the environment before making any change.

### Sleep mode

The printer enters sleep mode when there are no errors, no print jobs being received, and no control panel or other operations performed. When the printer enters sleep mode, the control panel's screen turns off and the internal motors and other parts switch off to consume less power.

Sleep mode is exited if a print job is received or the screen of the control panel is touched.

You can set the time it takes for the printer to enter sleep mode. At default settings, the printer enters sleep mode if no operations are performed for 15 minutes. The time it takes for the printer to enter sleep mode can be changed in the **Basic Settings** menu.

 [“General Settings - Basic Settings” on page 140](#)

### Note:

When the printer enters sleep mode, the control panel's screen goes blank as if the power has been turned off, but the  light remains lit.

### Power Off Timer

This function automatically turns the printer off if no errors occur, no print jobs are received, and no control panel or other operations are performed for a set period of time.

The default setting differs as follows depending on the model.

- ❑ SC-T5400/SC-T5400M/SC-T3400/SC-T3400N/  
SC-T5480/SC-T5480M/SC-T3480N  
Set to **8h**.
- ❑ SC-T5460/SC-T5460M/SC-T3460/SC-T3460N/  
SC-T5430/SC-T5430M/SC-T3430  
Set to **Off**.

Power Off Timer settings can be changed from the Basic Settings menu.

 [“General Settings - Basic Settings” on page 140](#)

## Introducing the Software

# Introducing the Software

## Provided Software

The following table lists the provided software.

The supplied software disc contains the software for Windows. When using a Mac or a computer without a disc drive, download the software from <http://epson.sn> and then install it.

For details on the various software, see the online help of each software or the *Administrator's Guide* (online manual).

**Note:**

Convenient software compatible with this printer is introduced on the Epson website. Please check the information from the following link.

<http://www.epson.com>

Software Name	Function
Printer Driver	Install the printer driver to take full advantage of the functionality of this printer when printing. ☞ <a href="#">"Printing with the Printer Driver from Your Computer" on page 49</a>
EPSON Software Updater	Software to check whether there is any software update information and then notify you and install the software if an update is available. It allows you to update the firmware and already installed software of the printer. ☞ <a href="#">"Updating Software or Installing Additional Software" on page 28</a>
LFP Print Plug-In for Office (Windows Only)	Plug-in software for Microsoft Office applications (Word, Excel, and PowerPoint). Installing this plug-in displays ribbon items in Office applications that give quick access to horizontal and vertical banner printing and enlarged printing. It can be installed by selecting it in the Additional Installation screen when installing the software. You can also install it later with EPSON Software Updater. The supported Microsoft versions are shown below. Office 2003/Office 2007/Office 2010/Office 2013/Office 2016
Epson Edge Dashboard*	Convenient software for administrating multiple printers. This enables confirmation in a list of the status of printers registered for monitoring. This also allows simple copying of Custom Paper Settings configured on a single printer to configure multiple other printers. ☞ <a href="#">"How to Start" on page 27</a> ☞ <a href="#">"Closing" on page 27</a>



## Introducing the Software

Software Name	Function
EpsonNet Config	<p>Software to configure the initial settings of the network or change the settings of the network in bulk when installing or relocating Epson printers and scanners.</p> <p>EpsonNet Config is not installed automatically. Download it from the Epson website and then install it if necessary.</p> <p><a href="http://www.epson.com">http://www.epson.com</a></p> <p>For Windows, you can install the software from the following folder on the supplied software disc.</p> <p>\\Network\EpsonNetConfig</p> <p> <i>Administrator's Guide</i></p>

\*Download software from the Internet, and install. Connect the computer to the Internet and install.

## Built-in Software in the Printer

The following software comes preinstalled in the printer. Start and use it from a Web browser via the network.

Software Name	Function
Web Config	<p>The network security settings can be configured from Web Config. This software also has an email notification function for notifying of printer errors and other problems.</p> <p> <a href="#">"How to Use Web Config" on page 26</a></p>

## Introducing the Software

# How to Use Web Config

This section describes how to start the software and provides a summary of its functions.

## How to Start

Start the software from a web browser on a computer or smart device that is connected to the same network as the printer.

- 1 Check the IP address of the printer.

Touch  on the Home screen, select the connected network, and check the IP address.

### Note:

The IP address can also be checked by printing a network connection check report. A report can be printed by touching the following in order from the Home screen.

**Settings - General Settings - Network Settings - Connection Check**

- 2 Start a Web browser on a computer or smart device connected to the printer via the network.

- 3 Enter the IP address of the printer in the address bar of the Web browser and press the **Enter** or **Return** key.

Format:

IPv4: http://IP address of printer/

IPv6: http://[IP address of printer]/

Example:

IPv4: http://192.168.100.201/

IPv6: http://[2001:db8::1000:1]/

## Closing

Close the Web browser.

## Function Summary

This section introduces the main functions of Web Config. See the *Administrator's Guide* for more details.

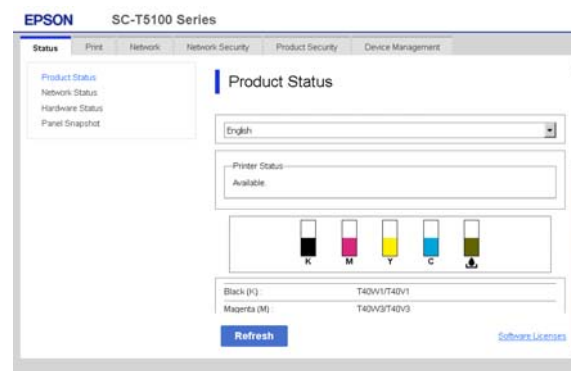

## Main Functions

- Check the printer's status, such as the remaining amount of ink.
- Check and update the printer's firmware version.
- Configure the printer's network settings and advanced security settings, such as SSL/TLS communication, IPsec/IP filtering, and IEEE802.1X, which cannot be configured with the printer alone.
- Edit the custom paper settings and export and import the settings.  
The custom paper settings registered in **Settings - General Settings - Printer Settings - Custom Paper Setting** of the printer can be changed as well as exported to a file and then imported (registered) to another printer. This is convenient when you install multiple printers and want to use common custom paper settings for them.
- You can print by simply selecting the file you want to print, and then uploading it to the printer. (SC-T5400M Series only)  
[📄 “Direct Printing via the Web \(Upload and Print\) \(SC-T5400M Series Only\)” on page 97](#)

## Introducing the Software

# How to Use Epson Edge Dashboard

---

## How to Start

Epson Edge Dashboard is a Web application that resides on your computer. Starting the computer will automatically start Epson Edge Dashboard and this remains running.

**1** Display the screen as follows.

### Windows

From the Taskbar on the Windows desktop, click the **Epson Edge Dashboard** icon, and select **Show Epson Edge Dashboard**.



Alternatively, from **Start**, click **All apps** (or **All Programs**) - **Epson Software** - **Epson Edge Dashboard**.

### Mac

From the desktop menu, click the **Epson Edge Dashboard** icon, and select **Show Epson Edge Dashboard**.



**2** The Epson Edge Dashboard screen appears.

See the Epson Edge Dashboard help for more details.

---

## Closing

Close the Web browser to close the Epson Edge Dashboard screen. Since Epson Edge Dashboard is a resident software on the computer, it does not stop running.

## Introducing the Software

# Updating Software or Installing Additional Software

When you install the software during setup as described in the *Setup Guide*, Epson Software Updater is installed. Epson Software Updater allows you to update the firmware and already installed software in your computer as well as install additional software compatible with the printer.

**Note:**

The software is updated as needed for greater convenience and more robust functionality. We recommend setting to receive update notifications with Epson Software Updater and updating the software as soon as possible when there is a notification.

## Checking Whether Updates Available and Updating Software

**1** Check that the computer and printer are in the following states.

- Computer is connected to the Internet.
- Printer and computer can communicate.

**2** Start Epson Software Updater.

- Windows  
Display the list of all the programs and then click Epson Software Updater in the Epson Software folder.

**Note:**

- If you press the Windows key (key with Windows logo mark) on the keyboard and then type the software name in the search box of the displayed window, the software appears immediately.
- The software can also be started by clicking the printer icon on the Taskbar of the desktop and then selecting **Software Update**.

- Mac  
Select **Go - Applications - Epson Software - EPSON Software Updater**.

**3** Select the software or manuals to be updated and then update them.

Follow the on-screen instructions.

**! Important:**

Do not turn off the computer or printer during the update.

**Note:**

Software not displayed in the list cannot be updated with Epson Software Updater. Check the latest versions of software on the Epson website.

Please note that you cannot update or install software using Epson Software Updater if you are using a Windows Server OS. Download the software from the Epson website.

<http://www.epson.com>

## Receiving Update Notifications

### Windows

- 1** Start Epson Software Updater.
- 2** Click **Auto update settings**.
- 3** Select the interval to perform the update check in the **Interval to Check** field of the printer and then click **OK**.

### Mac

The software is set by default to check and notify whether there are updates every 30 days.

## Introducing the Software

# Uninstalling Software

## Windows

### Important:

- You must log in as an Administrator.
- If the password or confirmation of an administrator is requested, enter the password and then continue with the operation.

- 1 Turn off the printer, and unplug the interface cable.
- 2 Close all applications running on your computer.
- 3 Go to the **Control Panel** and click **Uninstall a program** from the **Programs** category.



- 4 Select the software you want to remove and then click **Uninstall/Change** (or **Change/Remove / Add/Remove**).

You can remove the printer driver and EPSON Status Monitor 3 by selecting **EPSON SC-XXXXX Printer Uninstall**.

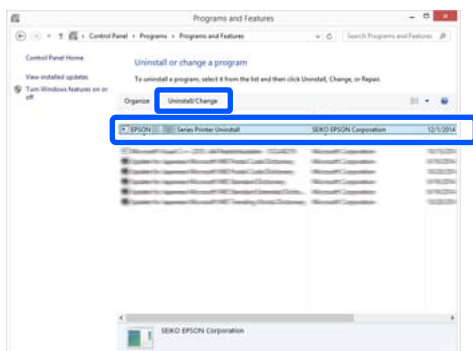

- 5 Select the printer icon, and then click **OK**.



- 6 Follow the on-screen instructions to continue. When the delete confirmation message appears, click **Yes**.

Restart the computer if you are reinstalling the printer driver.

## Mac

When reinstalling or upgrading the printer driver or other software, follow the steps below to uninstall the target software first.

### Printer Driver

Use the "Uninstaller".

### Downloading the Uninstaller

Download the "Uninstaller" from the Epson website.

<http://www.epson.com/>

### Using the Uninstaller

Follow the instructions on the Epson website.

### Other Software

Drag and drop folder with the software name from the **Applications** folder into **Trash** to delete.

## Changing the Network Connection Methods

# Changing the Network Connection Methods

The printer can connect to a wired LAN or a wireless LAN. Furthermore, it also supports Wi-Fi Direct (Simple AP) which allows a smart device or other device to directly connect wirelessly with the printer even when there is no wired LAN or wireless LAN environment.

The printer cannot connect to a wired LAN and wireless LAN at the same time. A Wi-Fi Direct connection is possible regardless of whether or not the printer is connected to a network.

This section describes the procedures to use to switch the connection method.

**Note:**

See the *Administrator's Guide (online manual)* for details on the network settings.

## Switching to Wired LAN

- 1 Touch  on the Home screen.

**Note:**

The shape and color of the icon differ depending on the connection status.

 ["Home screen operations" on page 15](#)

- 2 Touch **Description**.
- 3 Touch **Wired LAN Connection Method**.
- 4 Touch **Start Setup**.

The process to disable the wireless LAN connection with the access point starts. Wait until the **The Wi-Fi connection is disabled...** message appears.

- 5 Connect your router and the printer with a LAN cable.

See the following for the location of the printer's LAN port.

 ["Side \(right side\)" on page 13](#)

## Switching to Wireless LAN

The SSID (network name) and password of the access point to which the printer is to be connected are required. Confirm them in advance. The printer can be connected to a wireless LAN while the LAN cable is still connected.

**Note:**

If your access point supports WPS (Wi-Fi Protected Setup), the printer can be connected using **Push Button Setup (WPS)** or **PIN Code Setup (WPS)** without using an SSID and password.

 ["General Settings - Network Settings" on page 154](#)

- 1 Touch  on the Home screen.

**Note:**

The shape and color of the icon differ depending on the connection status.

 ["Home screen operations" on page 15](#)

- 2 Touch **Router**.
- 3 Touch **Start Setup**.  
Details of the wired LAN connection status are displayed.
- 4 Touch **Change to Wi-Fi connection.**, check the displayed message, and touch **Yes**.
- 5 Touch **Wi-Fi Setup Wizard**.
- 6 Select the desired SSID.  
If the desired SSID is not displayed, touch **Search Again** to update the list. If it is still not displayed, touch **Enter Manually** and directly enter the SSID.

## Changing the Network Connection Methods

**7** Touch **Enter Password** and enter the password.

**Note:**

- Differentiate between uppercase and lowercase when entering the password.
- If the SSID was entered directly, set **Password to Available** before entering the password.

**8** When input is finished, touch **OK**.

**9** Check the settings and then touch **Start Setup**.

**10** Touch **OK** to finish the procedure.

If the connection fails, select **Print Check Report** to print a network connection check report. You can check the measure to take in the report.

**11** Close the Network Connection Settings screen.

## Directly Connection Wirelessly (Wi-Fi Direct)

A direct connection with the printer can be established temporarily when, for example, the printer is not connected to a network or you do not have permission to log on to the network.

Wi-Fi Direct is disabled by default. The following describes the procedure from enabling Wi-Fi Direct to connecting.

**Note:**

*The printer can connect with up to four smart devices or computers at the same time. If you want to connect another device when there are already four devices connected, disconnect the connection with the printer from an already connected device.*

**1** Touch  on the Home screen.

**Note:**

*The shape and color of the icon differ depending on the connection status.*

 ["Home screen operations" on page 15](#)

**2** Touch **Wi-Fi Direct**.

When Wi-Fi Direct is already enabled, the network (SSID), password, number of connected devices, etc. are displayed. Proceed to step 5.

**Note:**

*When any of the displayed network (SSID), device name, etc. is partially not visible because it is cut off at the right edge of the screen, touch the corresponding item to display the entire setting value.*

**3** Touch **Start Setup**.

**4** Touch **Start Setup**.

Wi-Fi Direct is enabled and the network (SSID), password are displayed.

**5** Open the Wi-Fi setting screen on the device you want to connect with the printer, select the SSID displayed on the screen of the printer, and enter the password just as it is displayed on the screen.

**6** When a connection is established, touch **Close** to finish the procedure.

**7** Touch **Close** on the screen of the printer to close the network connection settings screen.

When the printer driver is installed on the connected device, you can print using the printer driver.

**Note:**

*When you turn off the power of the printer, the connections with connected devices are all disconnected. To reconnect after turning the printer back on, perform the procedure again from step 1.*

## Loading and Setting the Paper

# Loading and Setting the Paper

## Notes on Loading the Paper



### Caution:

Do not rub the edges of the paper with your hands. The edges of the paper are thin and sharp and could cause an injury.

### Do not load roll paper with the right and left edges uneven

Loading roll paper with the right and left edges uneven may cause paper feeding problems or paper meandering may occur during printing. Rewind the paper to make the edges even before using roll paper or use roll paper with no problem.

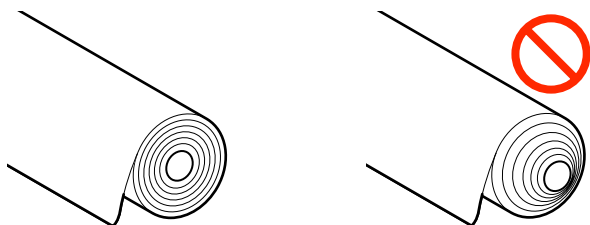

### Do not load curled paper

Loading curled paper may cause paper jams or soiled prints. Flatten the paper before use by bending it in the opposite way or use paper with no problem.

### Unsupported paper

Do not use paper that is wavy, torn, cut, folded, too thick, too thin, has a sticker affixed, etc. Doing so may cause paper jams or soiled prints. See the following for paper supported by the printer.

☞ [“Epson Special Media Table” on page 216](#)

☞ [“Supported Commercially Available Paper” on page 220](#)

## Paper Load Position

Roll paper and cut sheets can be loaded. See the following for more details on the paper that can be used with the printer.

☞ [“Supported Media” on page 216](#)

### Roll Paper

Roll paper from 254 mm to the maximum printable width can be loaded.

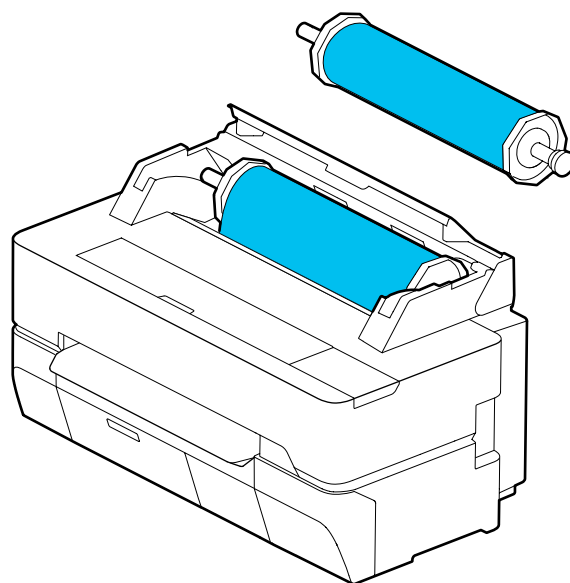

### Cut Sheet (1 sheet)

One sheet of cut paper from A4 to the maximum printable width can be loaded.

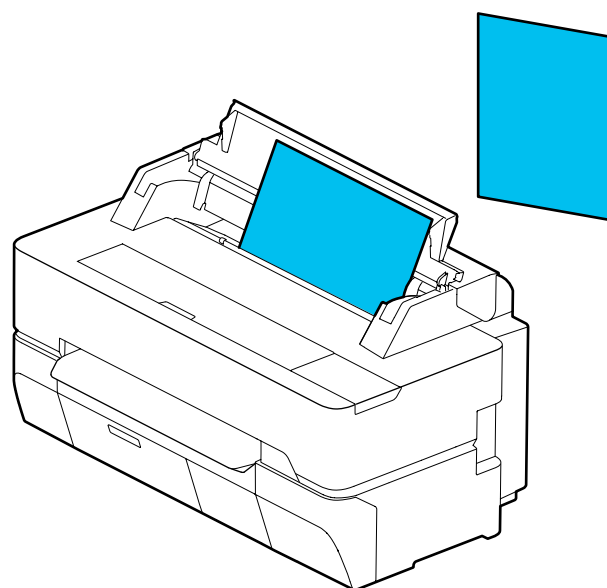



## Loading and Setting the Paper

**Note:**

The paper slot for Roll Paper and Cut Sheet (1 sheet) is the same. Insert either one into the paper slot.

### Loading and Removing the Roll Paper

Place the roll paper on the supplied spindle and then load the roll paper in the printer.

When replacing paper, remove the loaded paper first.

☞ [“Removing Roll Paper” on page 38](#)

☞ [“Removing Cut Sheet \(1 Sheet\)” on page 41](#)

The supplied attachment is only used when loading a 3 inch core roll paper.



**Important:**

The printer only supports plain paper for 3 inch roll cores. Epson cannot guarantee feed and print quality for 3 inch roll cores for other than plain paper.

### Loading Roll Paper

**Note:**

You can load the paper while viewing the loading procedure on the screen. To view the procedure on the screen, touch the Roll paper information area of the Home screen.

**1**

Check that "Load paper." is displayed on the Home screen and then open the cut sheet cover and the roll paper cover.

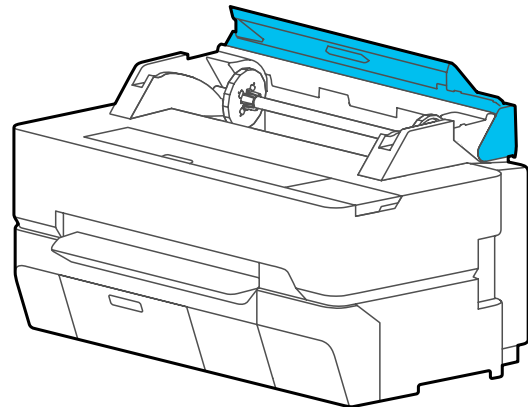
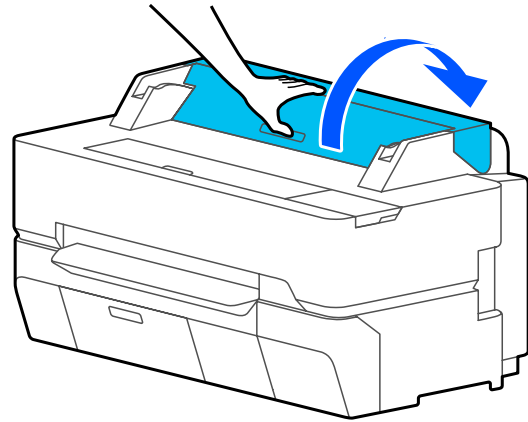

**2**

Remove the inserted spindle.

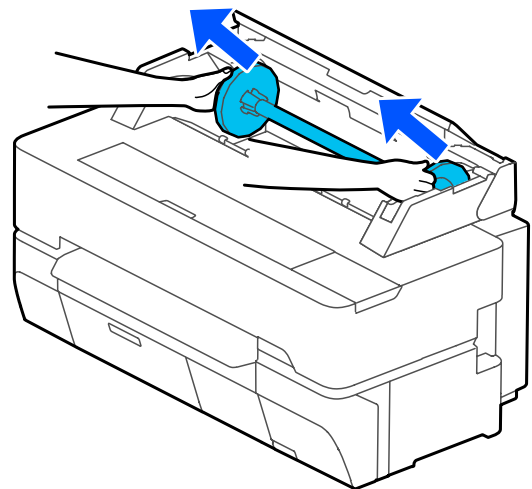

### Loading and Setting the Paper

- 3** Pull off the transparent flange from the spindle.

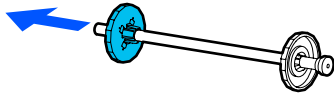

- 4** Attach or remove the attachments in accordance with the roll core size of the roll paper.

#### 2 inch roll core

The attachments are not required. Remove the attachments from the flanges if they have been attached to the flanges.

Push the two tabs on the flange outwards to remove the attachment.

After you remove the attachment from the black flange, remove the attachment from the spindle.

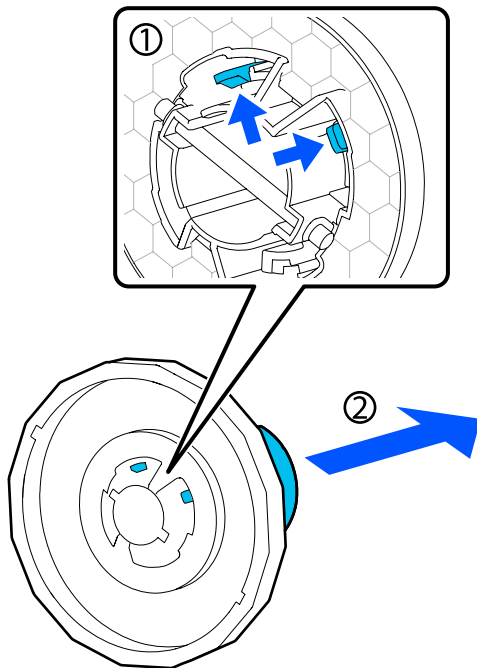

#### 3 inch roll core

Attach the attachments to the both flanges. Align the triangle marks on the flange with those on the attachment, and push in until the tabs are secured.

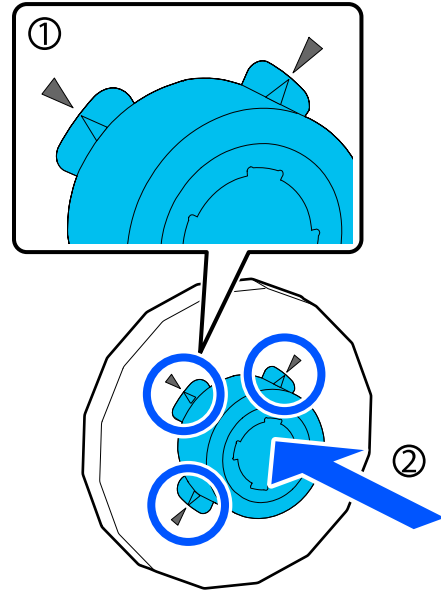

- 5** Place the roll paper on a flat surface and then insert the spindle.

With the black flange is on the right, orient the roll paper so that the leading edge is as shown in the figure below.

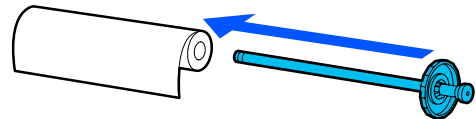

- 6** Push the flange to the roll paper until there is no gap between the flange and roll paper.

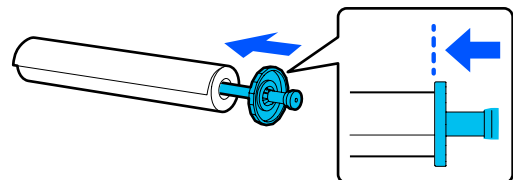

### Loading and Setting the Paper

- 7** Attach the transparent flange and push it until there is no gap between the flange and roll paper. If there are gaps between the flanges at both ends and the roll paper, the paper may be fed skewed resulting in an error.

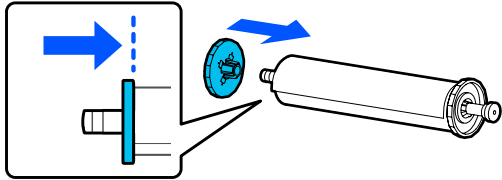

- 8** Orient the black flange of the spindle to the right side, and place the spindle into the grooves on the left and right.

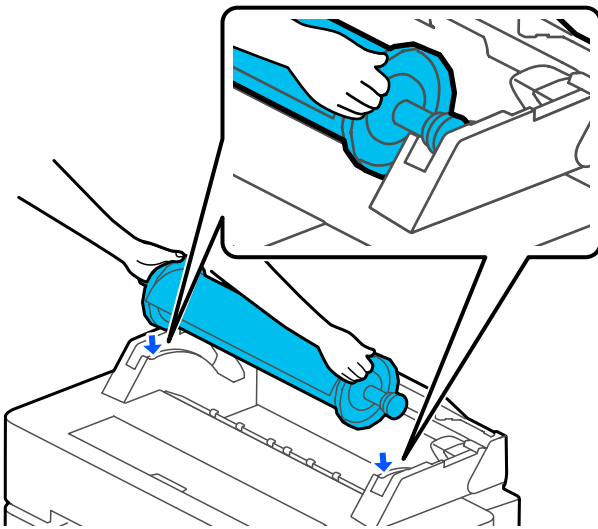

- 9** Slide the spindle in along the rails, and set the spindle's both ends in the spindle holders.

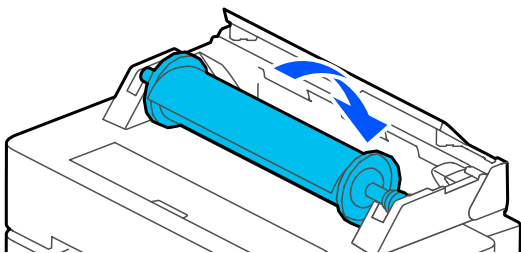

- 10** Check that the leading edge of the roll paper is not bent and then insert it into the paper slot until you hear a beep.

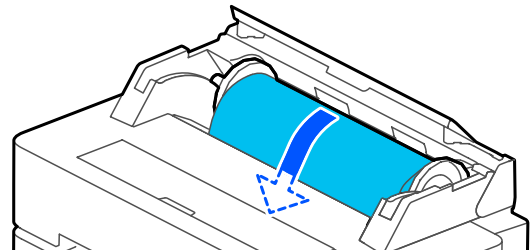
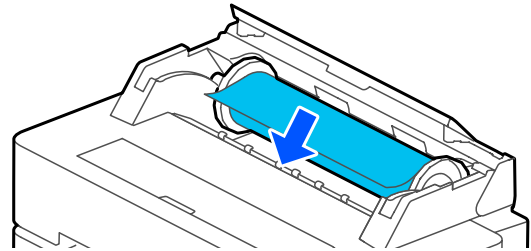

**Important:**

*Insert the paper straight into the paper slot. Inserting it skewed will cause a skew error or paper jam.*

**Note:**

*If the leading edge of the roll paper is not horizontal or not cut cleanly, it will be cut automatically after loading completes. However, it will not be cut if **Auto Cut** is set to **Off**.*

- 11** Close the roll paper cover and cut sheet cover.

- 12** On the displayed screen, set the paper type that matches the loaded paper and set remaining amount management if necessary.

**If a barcode giving information on the paper is printed on the roll paper**

When the paper is loaded, the barcode is read automatically, and the media type and roll paper remaining settings are configured automatically. You can start printing once **Ready** appears on the screen.

## Loading and Setting the Paper

### If a barcode giving information on the paper is not printed on the roll paper

See the following.

 [“For Roll Paper” on page 42](#)

- 13** For SC-T5400 Series and SC-T3400 Series, check that the paper basket attached to the stand is open.

**Note:**

Close the paper basket before printing banners or other documents of sizes that will not fit in the paper basket. Before the paper ejected from the printer touches the floor, we suggest that you take it in both hands close to the paper eject slot and continue to lightly support it until printing is complete.

**Note:**

- ❑ The auto cut setting of the printer driver has priority over that of the printer. The auto cut setting of the printer driver is reset to the default setting of **Normal Cut** when the application closes.
- ❑ To turn off auto cut for HP-GL/2 mode printing, enlarged copying, or direct printing from a USB flash drive, turn off the auto cut setting of the printer. Touch the Roll paper information area - **Advanced Media Setting - Auto Cut - Off** from the Home screen. The change to the setting is saved as a setting of the currently selected paper type.

## Cutting the Roll Paper

### Auto Cut

Auto Cut is set to On for the printer by default. When On is set, the roll paper is cut automatically at the following times.

- ❑ When the leading edge is detected as not horizontal  
After the roll paper is loaded, the leading edge part is cut straight.
- ❑ When printing of one page is finished  
The roll paper is cut before printing of the next page starts.

If you do not want to cut each page or you want to cut at a desired position, see the following procedure.

### Cutting after Last Page Printed or at Desired Position

Turn off auto cut in the printer driver, print, and then cut using the **Feed/Cut Paper** menu of the printer after printing finishes.

- 1** Select **Off** in **Advanced - Roll Paper Option - Auto Cut** of the printer driver and then print.

Leave the auto cut setting of the printer on.



- 2** Touch the Roll paper information area - **Feed/Cut Paper** from the Home screen of the printer after printing finishes.

Use the buttons displayed on the screen to cut and feed the paper.

#### When cutting at the printer default cut position (right after the bottom margin)

Touch the  (Cut) button. The paper is cut and the paper leading edge returns to the print wait position.

#### When cutting at desired position

- ① With the front cover closed, while looking into the printer, touch and hold down the  (Forward) or  (Backward) button until the position you want to cut comes to the position of the dotted line in the figure.

A cut position cannot be set further inside than the bottom margin.

## Loading and Setting the Paper

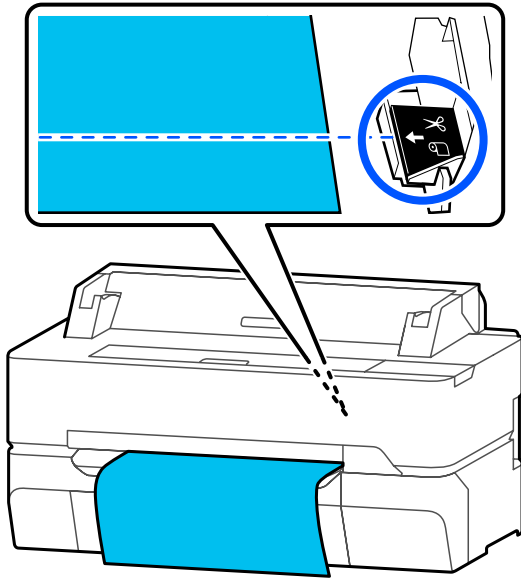

② Touch the  (Cut) button.

The paper is cut.

### Note:

When the length of **A** in the figure is shorter than the following length, the paper is fed automatically until the required length is obtained at the time of cutting.

- Plain paper or tracing paper: 100 mm
- Photo paper or coated paper: 80 mm
- Synthetic paper and other thick paper: 60 mm

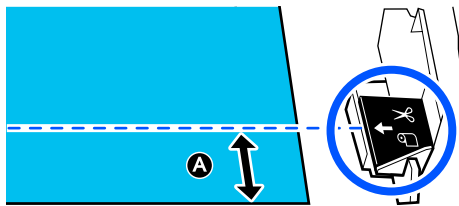

## Cutting Commercially Available Synthetic or Canvas Paper with Scissors

When using commercially available paper that cannot be cleanly cut with the cutter of the printer, print cut lines and cut the paper with scissors.

### ! Important:

- If commercially available synthetic or canvas paper is cut with the built-in cutter, the cutter may be damaged or its life may be shortened. When using such paper, cut the paper with scissors as described in the following procedure.
- Do not use a cutter. The printer may be damaged.

1

Turn off the auto cut setting and then print.

To print cut lines, turn off the auto cut setting of the printer. When printing via the printer driver, also turn off the setting of the printer driver.

- Printer settings  
Roll paper information area - **Advanced Media Setting - Auto Cut - Off** from the Home screen.
- Printer driver settings  
**Advanced - Roll Paper Option - Auto Cut - Off**

2

Touch the Roll paper information area - **Feed/Cut Paper** from the Home screen of the printer after printing finishes.

3



Operate the buttons displayed on the screen.

**When printing cut lines at the printer default position (right after the bottom margin)**

Touch the  (Cut) button. The cut or print cut lines selection screen appears.

## Loading and Setting the Paper

### When printing cut lines at desired position

With the front cover closed, while looking into the printer, touch and hold down the  (Forward) or  (Backward) button until the position of the cutting lines you want to print comes to the position of the dotted line in the figure.

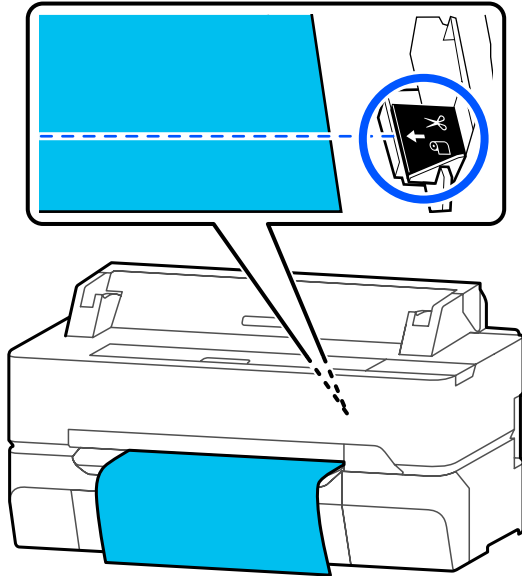

Cut lines cannot be printed further inside than the bottom margin. Once you have finished moving the paper, touch  (Cut). The cut or print cut lines selection screen appears.

#### 4 Touch **Print Cutting Guideline**.

Cut lines are printed and the paper is ejected automatically to a position where it can be easily cut with scissors.

#### 5 Cut the paper along the cut lines with scissors and then touch **Done**.

The paper rewinds to return the paper leading edge to the print wait position.

## Removing Roll Paper

This section describes how to remove and store roll paper after printing.

The rollers may leave impressions on roll paper if you leave the paper loaded in the printer. In addition, the paper may become wavy or curled due to damp, which may cause paper feeding problems, paper jams, or soiled prints.

We recommend that you return the paper to its original package and store it flat, and take it out of the package for use when printing.

#### 1 Touch the Roll paper information area - **Remove** from the Home screen.

The paper is rewound and ejected.

When Manage Remaining Amount is set to On, the barcode is automatically printed prior to rewinding.

#### **Note:**

*If printed paper is not cut and remains, a confirmation screen appears.*

*Touch **Cut** to cut the paper at the default cut position or touch **Print Cutting Guideline** to print cut lines at the default position.*

*If you want to change the cut position or cut lines print position to a desired position, touch **Close** to cancel the message, and change the position in the **Feed/Cut Paper** menu.*

*See the following for more details.*

* ["Cutting the Roll Paper" on page 36](#)*

#### 2 Open the cut sheet cover and the roll paper cover.

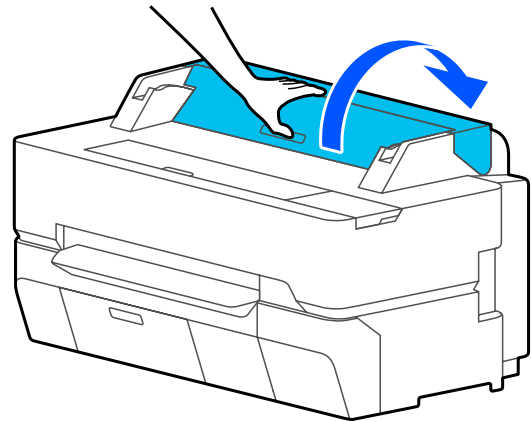

#### 3 Hold the flanges on both ends of the spindle and remove the spindle from the spindle holder.

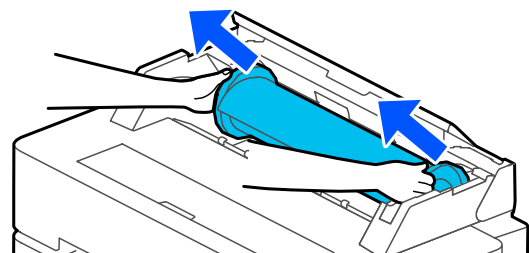

## Loading and Setting the Paper

- 4 Detach the transparent flange from the spindle.

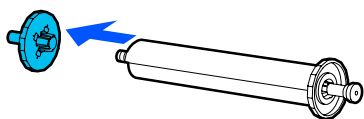

- 5 Remove the spindle from the roll paper.

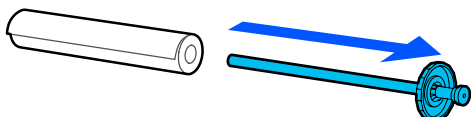

**!** **Important:**

*After rewinding the roll paper carefully, store it in the original package.*

- 6 Attach the transparent flange to the spindle and return the spindle in the printer.

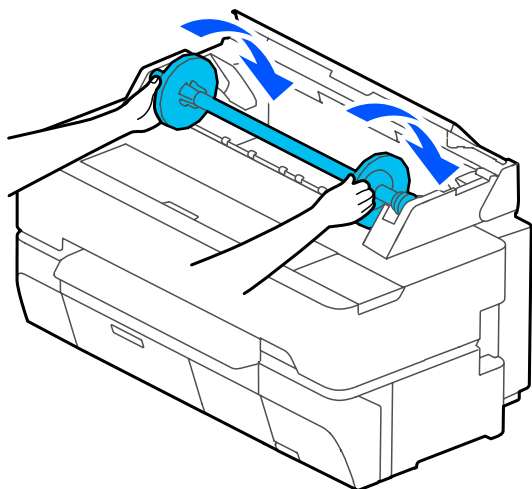

- 7 Close the roll paper cover and cut sheet cover.

**Loading and Setting the Paper**

# Loading and Removing Cut Sheet (1 sheet)

## Loading Cut Sheet (1 sheet)

When roll paper is loaded, remove it.  
 ☞ [“Removing Roll Paper” on page 38](#)

**Note:**  
 You can load the paper while viewing the loading procedure on the screen. To view the procedure on the screen, touch **Paper Setting - Cut Sheet(1 sheet)** from the Home screen.

- 1 Check that "Load paper." is displayed on the Home screen and then open the cut sheet cover.

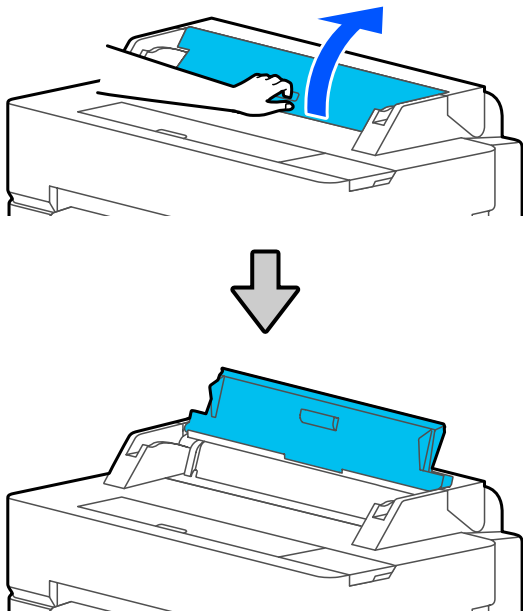

- 2 Load a sheet of paper with the print side facing up, align its right edge with the guide on the right, and move it downwards.

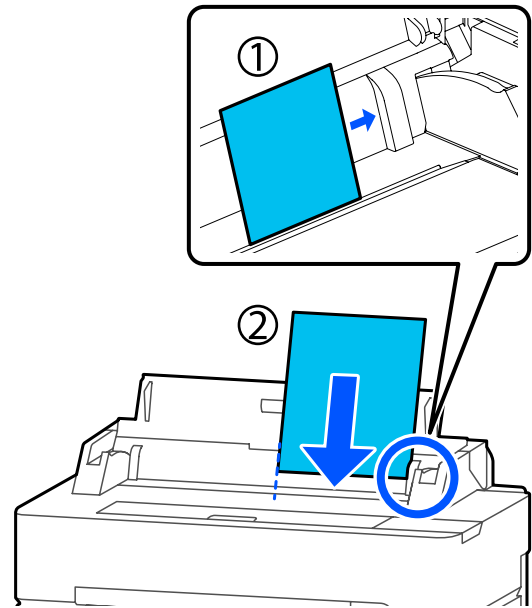

**! Important:**  
 Insert all paper in portrait orientation. Inserting paper in landscape orientation may cause a decline in print quality.

- 3 Insert the leading edge of the paper straight into the paper slot until you hear a beep.

**! Important:**  
 Insert the paper straight into the paper slot. Inserting it skewed will cause a skew error or paper jam.

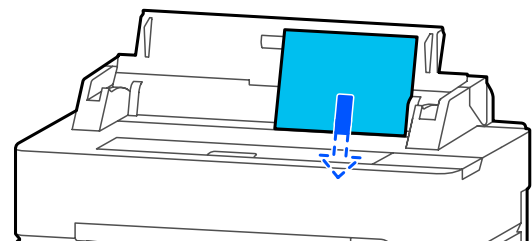

A dialog box to confirm that the paper is not skewed appears.



## Loading and Setting the Paper

- 4** If the paper is inserted straight, touch **OK**. To reload the paper, touch **Cancel**.  
If you have touched **Cancel**, load the paper again from step 2.
- 5** On the displayed screen, set the paper type and size that match the loaded paper.  
Not setting the appropriate paper type will cause print quality trouble. See the following for more details on the paper types and sizes.  
[🔗 “For Cut Sheet \(1 sheet\)” on page 43](#)
- 6** For SC-T5400 Series and SC-T3400 Series, check that the paper basket attached to the stand is open.

---

## Removing Cut Sheet (1 Sheet)

To remove cut sheet that was loaded but not used, eject using the procedure below.

- 1** Touch **Paper Setting - Cut Sheet (1 sheet) - Remove** from the Home screen.  
This starts paper ejection operation.
- 2** Hold the edges of the paper with your hands, touch **OK** on the screen, and pull the paper toward you.

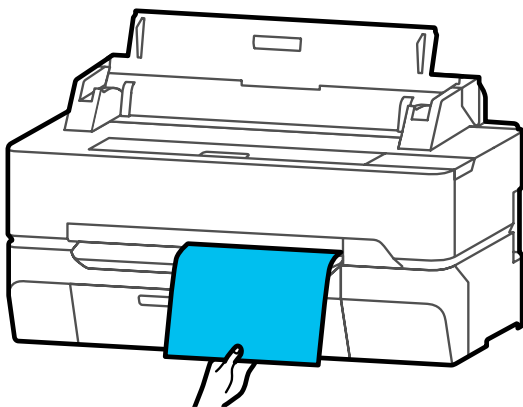

## Loading and Setting the Paper

# Setting Loaded Paper

## For Roll Paper

Configure the following settings after loading roll paper.

### Paper Type settings

This is the most important setting to obtain the optimum print results. Not setting a paper type that matches the loaded paper will cause wrinkles, scuffing, uneven colors, and other trouble.

### Manage Remaining Amount settings

When On is selected for Manage Remaining Amount, the printer tracks the following roll paper data.

- Roll paper remaining amount display  
This displays the approximate remaining amount of roll paper on the printer's Home screen and on the printer driver screen. Furthermore, a notification can also be displayed when the remaining amount has become low.
- Remaining amount management when replacing roll paper  
The following settings are recorded in a barcode printed on the roll.  
The amount of roll paper remaining, the value selected for remaining alert, and the paper type.

The barcode is automatically printed at the end of the roll paper when the roll is rewound. The barcode is automatically read and settings adjusted the next time the roll paper is used, improving efficiency when multiple rolls of paper are used.

However, depending on the paper, the printer may not be able to read the barcode.

## How to Set

- 1** The currently set paper type is shown on the screen displayed after loading roll paper.

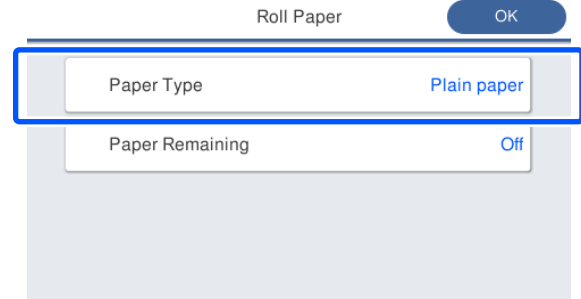

### When changing Paper Type

Proceed to step 2.

### When setting Paper Remaining without changing Paper Type

Proceed to step 5.

### When not changing either of them

Touch **OK**. You can start printing once **Ready** appears on the screen.

**Note:**

The settings are confirmed if no operations are performed for 90 seconds on the above screen. To change the settings later, touch the Roll paper information area - **Change Paper Type** from the Home screen and then configure the settings.

- 2** Touch **Paper Type**.

The following paper type selection screen appears.

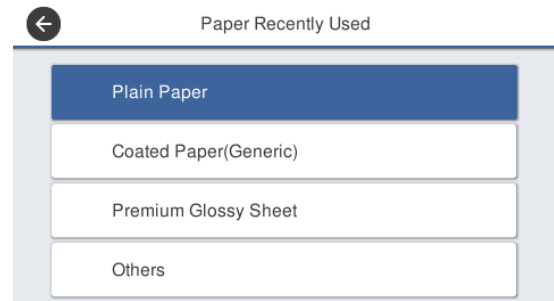

**Note:**

The most recently selected three paper types are displayed in addition to **Others**.

## Loading and Setting the Paper

- 3** Select the paper type that matches the loaded roll paper.

### Epson Special Media

Select the same product name as the one shown on the package of the paper.

### Commercially available non-Epson paper

Select from the following commercially available paper types.

- Plain paper
- Coated Paper (Generic)
- Photo Paper (Generic)
- Tracing Paper
- Tracing Paper <LowDuty>
- Matte Film

To select a paper type that is not displayed on the screen, touch **Others**.

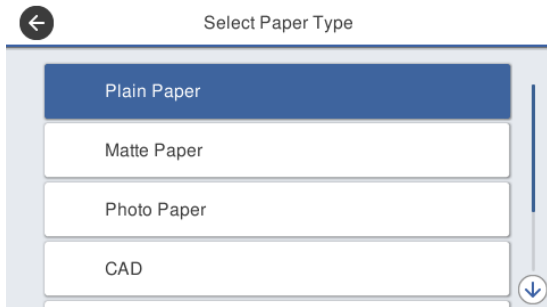

Select a category and select the target paper type.

**Note:**  
If you scroll downward in the category selection screen, **Custom Paper** appears. To select custom paper that has already been registered, touch **Custom Paper**.

- 4** When a paper type is selected, the screen returns to the one in step 1.

If you will not set the remaining amount management setting, touch **OK**.

- 5** Touch **Paper Remaining**.

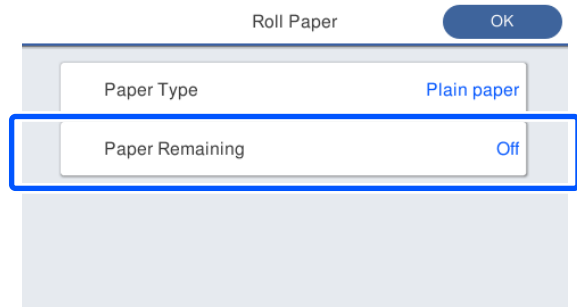

- 6** Touch **Setup**.

The setting changes to **On**, and **Remaining Amount** and **Remaining Alert** are enabled. Touch each one and enter a value as follows.

- Remaining Amount: Total length of roll paper (see the manual supplied with the roll paper)
- Remaining Alert: Remaining amount value that will be the timing for displaying the remaining amount warning notification.

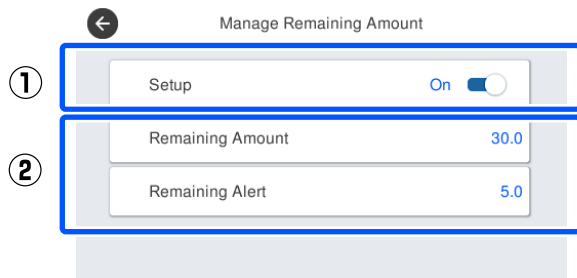

**Note:**

On the keypad screen for entering a numeric value, enter numbers that include a number of the first decimal place. For example, if you want to enter 5 m, touch [5] and [0].

- 7** Touch **←** at the top left of the screen to return to the screen of step 5 and then touch **OK**.

You can start printing once **Ready** appears on the screen.

## For Cut Sheet (1 sheet)

Configure the following settings after loading cut sheets.

## Loading and Setting the Paper

### Settings of Paper Type

This is the most important setting to obtain the optimum print results. Not setting a paper type that matches the loaded paper will cause wrinkles, scuffing, uneven colors, and other trouble.

### Settings of Paper Size

Paper size will not be automatically detected. Set the size of the loaded paper.

## How to Set

- 1 The currently set paper type is shown on the screen displayed after loading cut sheet.

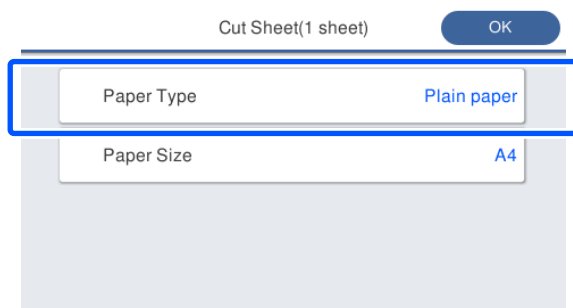

### When changing Paper Type

Proceed to step 2.

### When changing Paper Size without changing Paper Type

Proceed to step 4.

### When not changing either of them

Touch **OK**. You can start printing once **Ready** appears on the screen.

**Note:**

The settings are confirmed if no operations are performed for 90 seconds on the above screen. To change the settings later, touch the following in order from the Home screen and then configure the settings.

**Paper Setting - Cut Sheet(1 sheet) - Change Paper Type/Paper Size**

- 2 Touch **Paper Type**.

The following paper type selection screen appears.

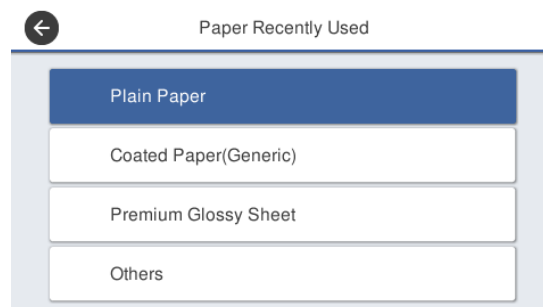

**Note:**

The most recently selected three paper types are displayed in addition to **Others**.

- 3 Select the paper type that matches the loaded paper.

### Epson Special Media

Select the same product name as the one shown on the package of the paper.

### Commercially available non-Epson paper

Select from the following commercially available paper types.

- Plain paper
- Coated Paper (Generic)
- Photo Paper (Generic)
- Tracing Paper
- Tracing Paper <LowDuty>
- Matte Film

To select a paper type that is not displayed on the screen, touch **Others**.

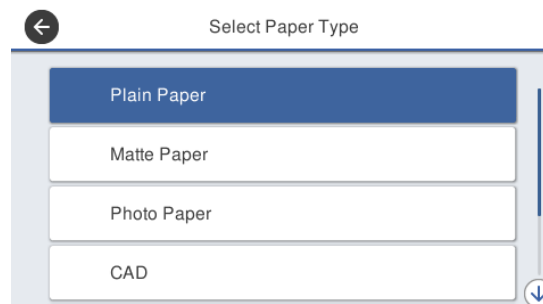

## Loading and Setting the Paper

Select a category and select the target paper type. When a paper type is confirmed, the screen returns to the one in step 1.

**Note:**

If you scroll downward in the category selection screen, **Custom Paper** appears. To select custom paper that has already been registered, touch **Custom Paper**.

### 4 Touch Paper Size.

If you will not change the paper size, touch **OK**.

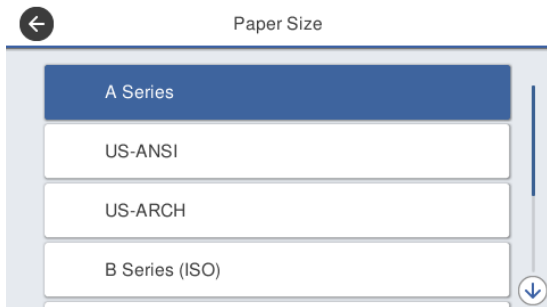

Select a category and select the target paper size.

**Note:**

**Setting non-standard size**

For a non-standard size, touch **User-Defined** at the end of the list and then enter the paper width and length.

On the keypad screen for entering a numeric value, enter numbers that include a number of the first decimal place. For example, if you want to enter 5 m, touch [5] and [0].

### 5 When the screen of step 1 is redisplayed, touch **OK**.

You can start printing once **Ready** appears on the screen.

## Loading and Setting the Paper

# Optimizing Paper Settings (Media Adjust)

Media Adjust has three main types.

- Easy Adjustment
- Paper Feed Adjust
- Print Head Alignment

Perform Easy Adjustment in the following cases.

- Print results have streaks (horizontal banding or uneven colors)
- Duplicated ruled lines, warped lettering, or grainy printing
- When registered with custom paper settings



**Note:**

**Adjustment for paper registered with custom paper settings**

*With roll paper and cut sheet, optimal paper settings will differ even when the paper types are the same. When registering roll paper and cut sheet with the same paper type, adjust for each of these. For details on custom paper setting, see the following Custom Paper Setting menu.*





 [“General Settings - Printer Settings” on page 142](#)

However, if a problem with print results can be specified, then perform the following adjustment in accordance with the situation.

- If print results have streaks (horizontal banding or uneven colors):  
Perform **Paper Feed Adjust - Auto**  
 [“Paper Feed Adjust \(Auto\)” on page 47](#)
- If duplicated ruled lines, warped lettering, or grainy printing:  
Perform **Print Head Alignment - Auto**  
 [“Print Head Alignment \(Auto\)” on page 47](#)

The sensor reads adjustment patterns while it is printing for both of these, and automatically registers the optimum adjustment value to the printer.

## Notes on Making Adjustments

- Correctly load the paper that actually requires adjustment and then select the paper type that matches the loaded paper.
- If paper with visible curls, wrinkles, waves, folds, or bends is used, correct adjustment may not be possible. Remove curled, wavy, or folded sections by cutting them off.
- Ensure that light from outside (direct sunlight, etc.) does not enter the interior of the printer. If this occurs, the printer may not be able to correctly read the adjustment pattern. If light enters the interior of the printer and automatic adjustment is not possible, then carry out manual adjustment.  
 [“The prints are not what you expected” on page 193](#)
- Automatic adjustment is not possible for transparent or colored media. Use manual adjustment.  
 [“The prints are not what you expected” on page 193](#)
- Results of adjustment will differ depending on the paper type.  
 [“Epson Special Media Table” on page 216](#)  
 [“Before Printing on Commercially Available Paper” on page 222](#)

## Easy Adjustment

The sensor reads adjustment patterns while it is printing, and automatically registers the optimum adjustment value to the printer. This takes approximately 5 minutes.

The following shows the length and number of sheets of paper used for adjustment pattern printing.

- Roll paper: Approx. 344 mm
- Cut sheet: 1 sheet for A3+ or larger, 2 sheets for smaller than A3+

**1**

Touch the following in order from the Home screen.

- Roll paper  
Roll paper information area - **Media Adjust**

## Loading and Setting the Paper

- Cut sheet  
**Paper Setting - Cut Sheet (1 sheet) - Media Adjust**

### 2 Touch Easy Adjustment - Start.

Printing of the adjustment patterns starts.

When **Print head alignment complete...** appears, the procedure is finished.

The adjustment results are saved as settings of the currently selected paper type.

**Note:**

*A print head nozzle clogging check is performed automatically before adjustment pattern printing. If nozzles are determined to be clogged, cleaning starts and the adjustment patterns will be printed after cleaning finishes.*

Refer to the following when the error message **Auto Adjustment is unable to start because there is a problem with the paper or printing status...** appears, or when the adjustment results are not satisfactory.

 [“The prints are not what you expected” on page 193](#)

## Paper Feed Adjust (Auto)

The following shows the length and number of sheets of paper used for adjustment pattern printing.

- Roll paper: Approx. 230 mm
- Cut sheet: 1 sheet for A4 or larger

### 1 Touch the following in order from the Home screen.

- Roll paper  
Roll paper information area - **Media Adjust**
- Cut sheet  
**Paper Setting - Cut Sheet (1 sheet) - Media Adjust**

### 2 Touch Paper Feed Adjust - Auto - Start.

Printing of the adjustment patterns starts.

When **Print head alignment complete...** appears, the procedure is finished.

The adjustment results are saved as settings of the currently selected paper type.

**Note:**

*A print head nozzle clogging check is performed automatically before adjustment pattern printing. If nozzles are determined to be clogged, cleaning starts and the adjustment patterns will be printed after cleaning finishes.*

Refer to the following when the error message **Auto Adjustment is unable to start because there is a problem with the paper or printing status...** appears, or when the adjustment results are not satisfactory.

 [“The prints are not what you expected” on page 193](#)

## Print Head Alignment (Auto)

The following shows the length and number of sheets of paper used for adjustment pattern printing.

- Roll paper: Approx. 227 mm
- Cut sheet: 1 sheet for A4 or larger

### 1 Touch the following in order from the Home screen.

- Roll paper  
Roll paper information area - **Media Adjust**
- Cut sheet  
**Paper Setting - Cut Sheet (1 sheet) - Media Adjust**

### 2 Touch Print Head Alignment - Auto - Start.

Printing of the adjustment patterns starts.

When **Print head alignment complete...** appears, the procedure is finished.

The adjustment results are saved as settings of the currently selected paper type.

**Note:**

*A print head nozzle clogging check is performed automatically before adjustment pattern printing. If nozzles are determined to be clogged, cleaning starts and the adjustment patterns will be printed after cleaning finishes.*

## Loading and Setting the Paper

Refer to the following when the error message **Auto Adjustment is unable to start because there is a problem with the paper or printing status...** appears, or when the adjustment results are not satisfactory.

 [“The prints are not what you expected” on page 193](#)



Printing with the Printer Driver from Your Computer

# Printing with the Printer Driver from Your Computer

## Basic Operating Procedures (Windows)

### Printing Procedure

This section describes the basic procedure to print various data, including the data of Word, Excel, and PowerPoint of Microsoft Office and PDFs of Adobe Acrobat, using the printer driver from a computer.

- 1 Turn on the printer, and load the paper.
  - [“Loading Roll Paper” on page 33](#)
  - [“Loading Cut Sheet \(1 sheet\)” on page 40](#)
- 2 When you have created the data in the application, click **Print** in the **File** menu.

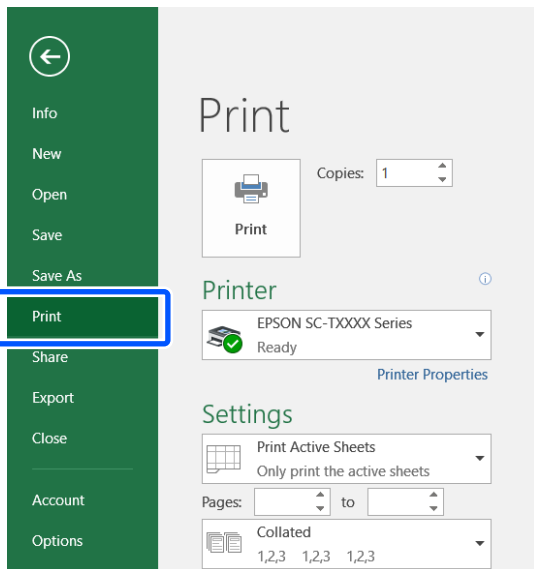

- 3 Select the printer in **Printer** and then click **Printer Properties**.

The printer driver dialog will be displayed.

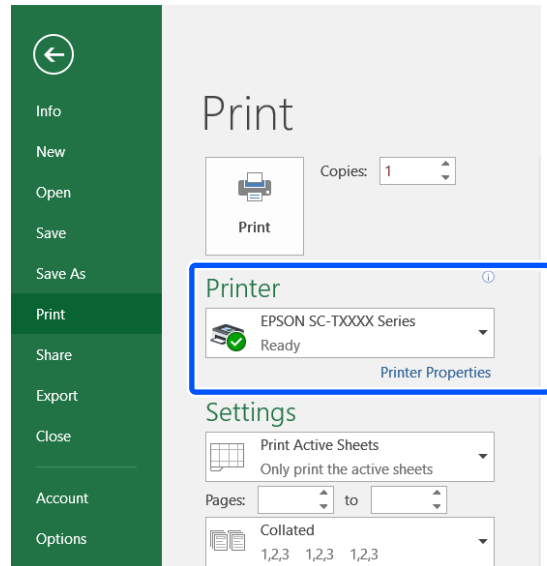

**Note:**

*When printing a PDF file  
In the Print dialog box of Adobe Acrobat, select the **Actual size** (or **Page Scaling: None**) radial button and **Choose paper source by PDF page size** check box. To enlarge or reduce the size, configure the setting in the printer driver settings dialog box.*

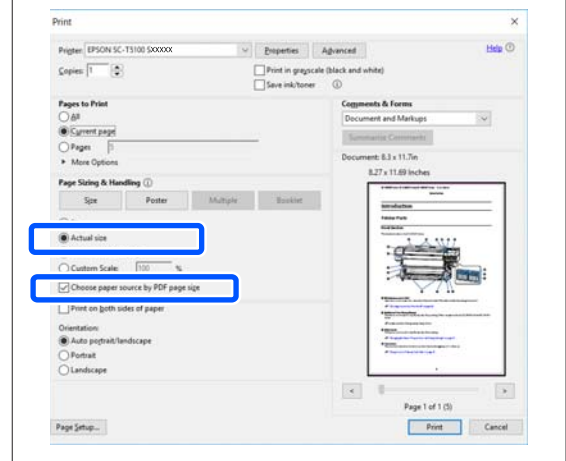

- 4 Check **Document Size** on the Printer Settings tab of the printer driver.

The paper size set in the application is displayed automatically. However, the paper sizes (page sizes) of some applications such as PowerPoint may not be displayed correctly. In such a case, click **Settings...** and specify the size in the displayed Change Paper Size dialog box.

## Printing with the Printer Driver from Your Computer

If the desired size is not available in the pull-down menu of the Change Paper Size dialog box, click **Custom Paper Size...** and then set and save a custom size.

[“Printing at Non-Standard Sizes” on page 66](#)

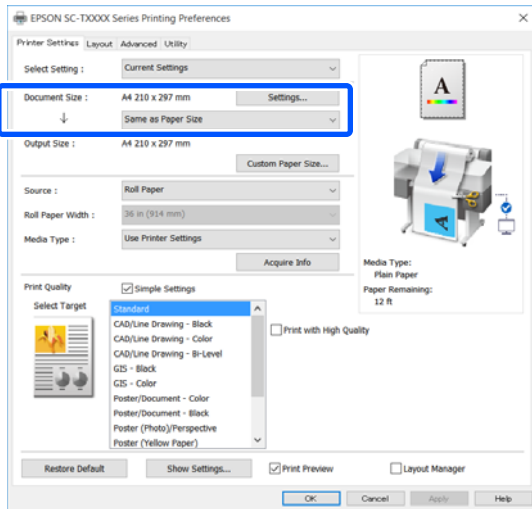

### 5 Set Output Size.

To enlarge or reduce the size, select from the pull-down menu below the Document Size.

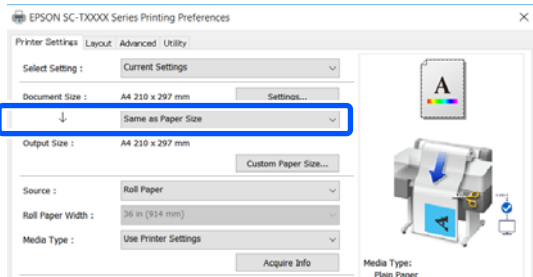

See the following for more details on enlargement settings.

[“Enlargements and Horizontal and Vertical Banners” on page 61](#)

### 6 Select Source and check the roll paper width (paper size when cut sheet) and paper type.

Select from Roll Paper and Sheet. If you select a paper source for which paper is not loaded in the printer, appears.

For Roll Paper Width (Paper Size when cut sheet) and Media Type, the settings configured in the control panel of the printer are applied automatically.

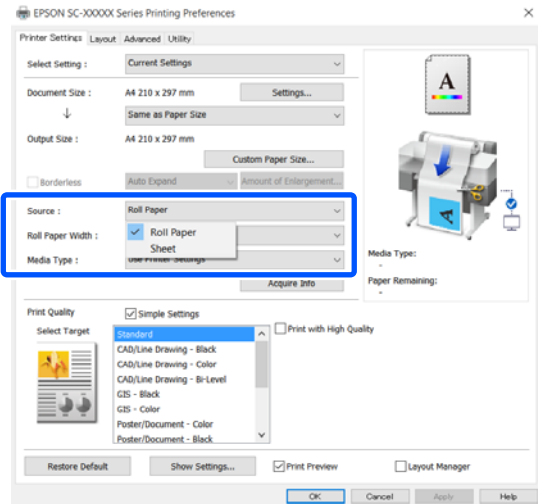

#### Note:

*If the paper is loaded or changed after opening the printer driver's dialog box, the paper size and paper type settings configured on the printer will not be applied. In this case, click the **Acquire Info** button to apply the settings.*

### 7 Select Select Target in Print Quality.

Choose an option according to the type of document and how it will be used.

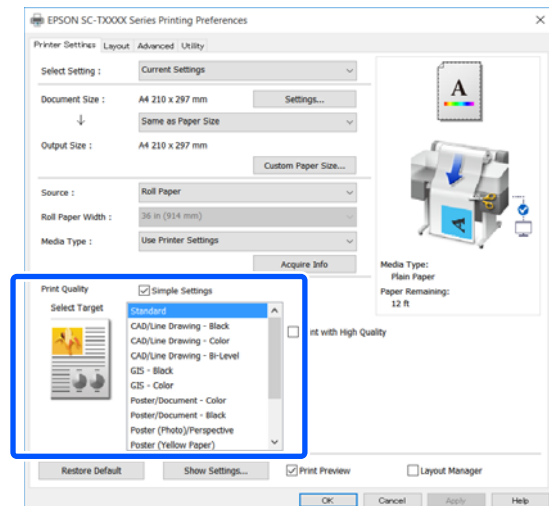

To set the color correction method or color balance in detail to match your preferences, clear the **Simple Settings** check box. See the following for more details.

[“Correct color and print” on page 74](#)

## Printing with the Printer Driver from Your Computer

- 8** Check that the **Print Preview** check box is selected and then click **OK**.
- If a preview is not necessary, clear the check box and then click **OK**.

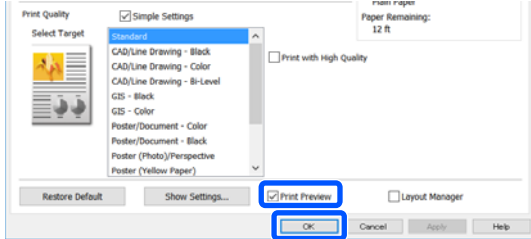

**Note:**  
In the print preview, you can check and change the print settings while viewing the image to be actually printed. We recommend to check with the preview when printing on roll paper or large-sized paper.

- 9** Click **Print** in the Print dialog box of the application.
- The print preview screen appears.
- 10** Check the print settings in the print preview screen, and if there is no problem, click **Print** to start printing.

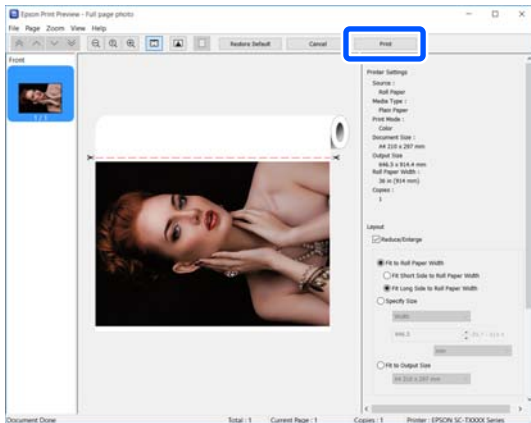

The icons and menus at the top of the preview screen allow you to change the image display settings. You can change the print settings using the menus on the right side. See the help for more details.

**Note:**  
See the printer driver help for more details on setting items. You can display the help in the following two ways:

- Click **Help** at the bottom right of the screen.
- Right-click the item you want to check and then click **Help**. (This is not possible in the print preview screen.)

## Canceling Printing

There are a few ways to stop printing operations depending on the situation. When the computer has finished sending data to the printer, you cannot cancel the print job from the computer. Cancel on the printer.

## Canceling from a Computer

### When the Progress Bar is displayed

Click **Cancel**.

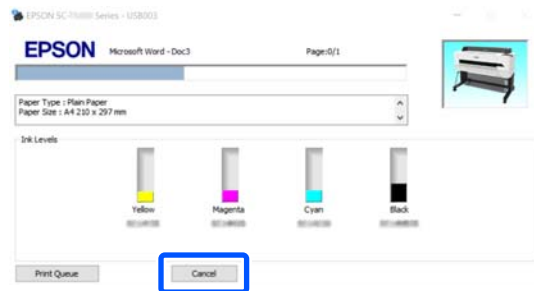

### When the Progress Bar is not displayed

- 1** Click the printer icon on the taskbar.



Whether or not an icon is displayed depends on the settings selected for Windows.

## Printing with the Printer Driver from Your Computer

- 2** Select the print data you want to cancel and click **Cancel** in the **Document** menu.

To cancel all print data, click **Cancel All Documents** in the **Printer** menu.

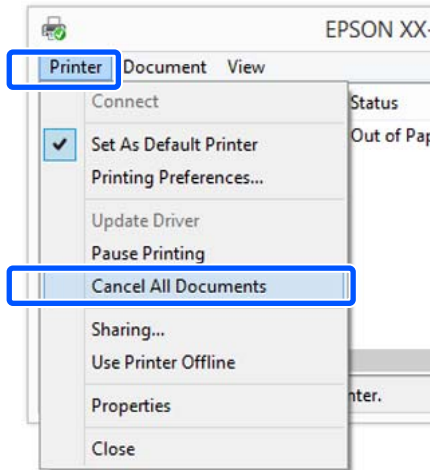

If the job has been sent to the printer, print data is not displayed on the above screen.

### Canceling on the printer

The **Cancel** button is displayed on the control panel screen during printing. Touch the **Cancel** button. The print job is canceled even in the middle of printing. It may take a while before the printer returns to the ready status.

However, print jobs in the print queue on a computer cannot be deleted in this way. Use the procedure of "Canceling from a Computer" to delete print jobs in the print queue.

## Customizing the Printer Driver

You can save the settings or change the display items as you prefer.

### Saving Frequently Used Settings

If you start the printer driver from the Control Panel, change the settings to those you use frequently, and then save the settings, the printer driver's dialog box will be displayed with the saved settings from any application that it is displayed.

- 1** Open **View devices and printers** or **Devices and Printers**.

**Windows 10/8.1/8/7**

Click in the following order: **Hardware and Sound** (or **Hardware**) > **View devices and printers** (or **Devices and Printers**).

**Windows Vista**

Click in the following order: **Hardware and Sound** and then **Printer**.

**Windows XP**

Click in the following order: **Printers and Other Hardware**, and then **Printers and Faxes**.

**Note:**

*If your Windows XP Control Panel is in **Classic View**, click **Start**, **Control Panel**, and then **Printers and Faxes**.*

- 2** Right-click your printer icon, and click **Printing preferences**.

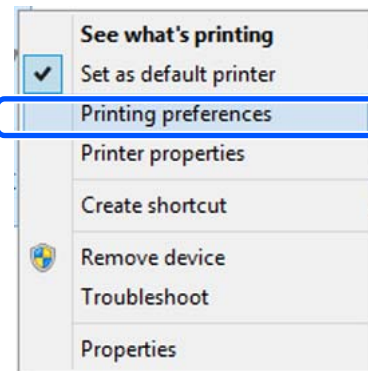

- 3** The printer driver setting screen is displayed.

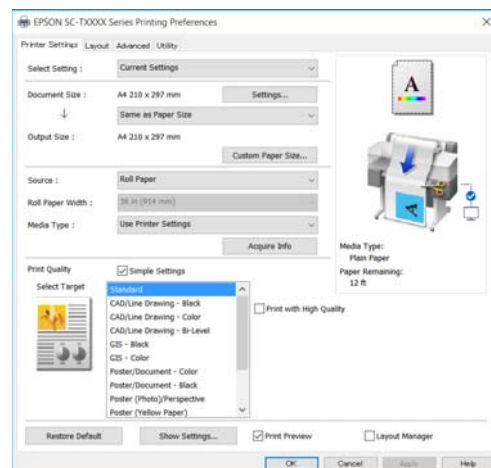

## Printing with the Printer Driver from Your Computer

Make the necessary settings. These settings become the default settings of the printer driver.

### Saving various settings as your Select Settings

You can save all printer driver settings as a Select Setting. This allows you to easily load settings that have been stored in Select Settings, and repeatedly print using exactly the same settings.

**1** Set each item on the Printer Settings, Layout, and Advanced tabs to the settings you want to save as Select Settings.

**2** Click **Custom Settings**.

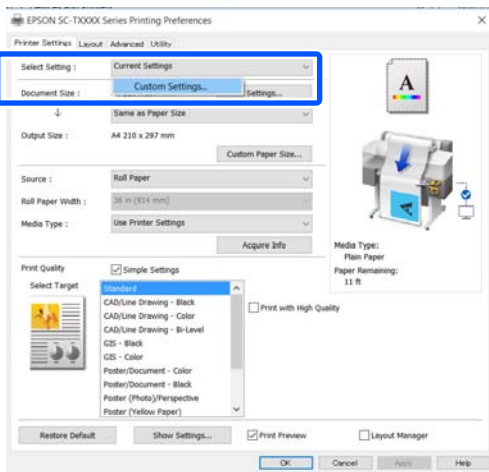

**3** Enter the desired name in **Name**, and then click **Save**.

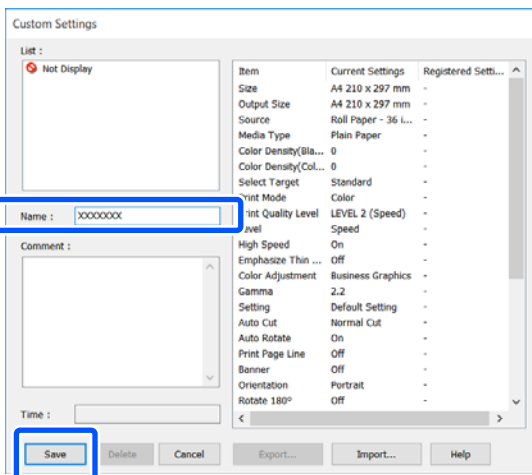

You can save up to 100. The saved select settings can be recalled from **Select Setting**.

**Note:**

**How to share Select Setting settings with multiple computers**

Select the settings you want to share, click **Export...**, and then export the settings to a file. Display the same screen of the printer driver on another computer, click **Import...**, and then import the settings.

### Rearranging display items

The display items of **Select Setting**, **Media Type**, and **Paper Size** can be arranged as follows to display the ones you use normally right away.

- Hide unnecessary items.
- Rearrange in an order of most frequent use.
- Arrange in groups (folders).

**1** Click **Utility** tab - **Menu Arrangement**.

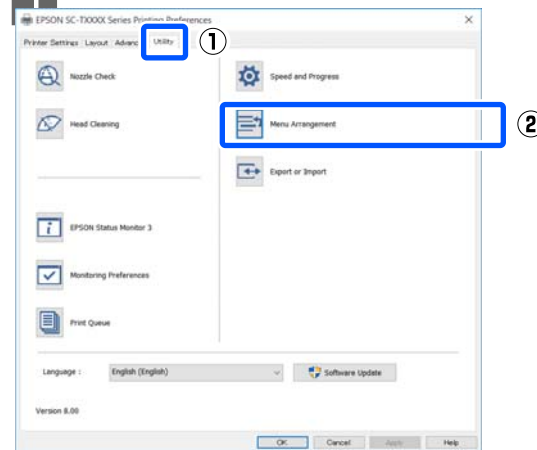

## Printing with the Printer Driver from Your Computer

### 2 Select **Edit Item**.

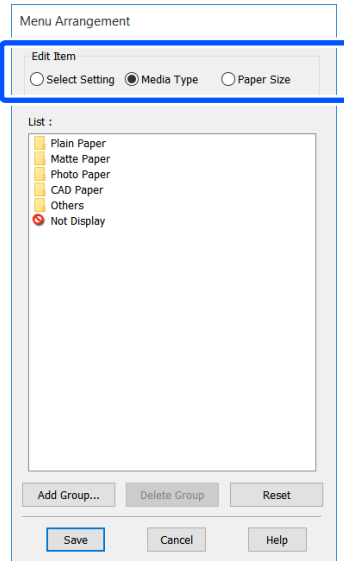

### 4 Click **Save**.

### 3 Change the display order and groups in **List**.

- ❑ You can move and order items by dragging and dropping.
- ❑ To add a new group (folder), click **Add Group...**
- ❑ To delete a group (folder), click **Delete Group**.
- ❑ Drag and drop unnecessary items to **Not Display**.

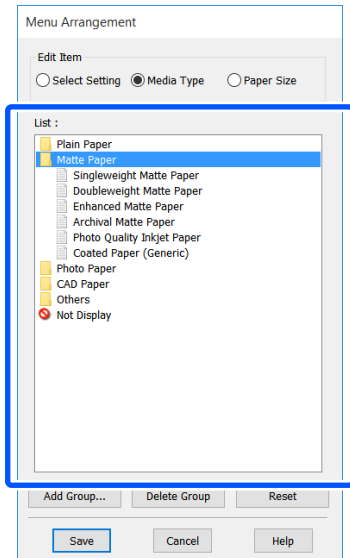

**Note:**

When **Delete Group** is performed, the group (folder) is deleted, but the settings in the deleted group (folder) remain. Delete them individually from **List** in the save location.

## Printing with the Printer Driver from Your Computer

# Basic Operating Procedures (Mac)

## Printing Procedure

This section describes the basic procedure to print using the printer driver from a computer.

### Basic Printing Procedure

- 1 Turn on the printer, and load the paper.
  - ☞ “Loading Roll Paper” on page 33
  - ☞ “Loading Cut Sheet (1 sheet)” on page 40
- 2 When you have created the data in the application, click **Print** in the **File** menu.

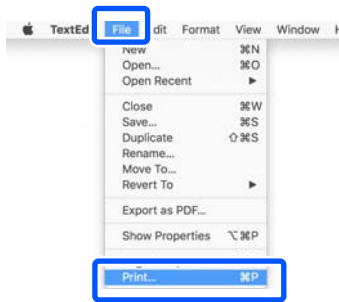

- 3 Click **Show Details** (or ) at the bottom of the screen.

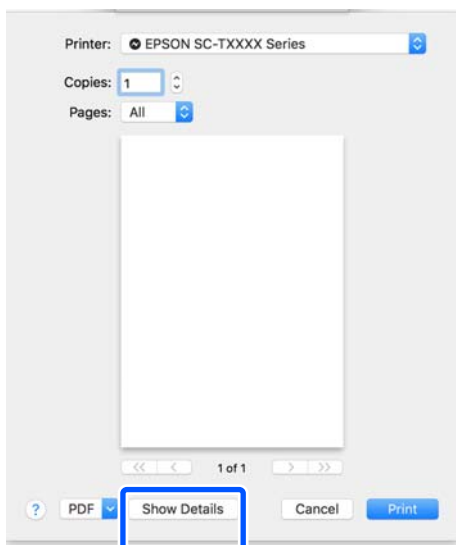

**Note:**

If page settings are not displayed in the print dialog, click the “page settings” option (e.g., **Page Setup**) in the **File** menu.

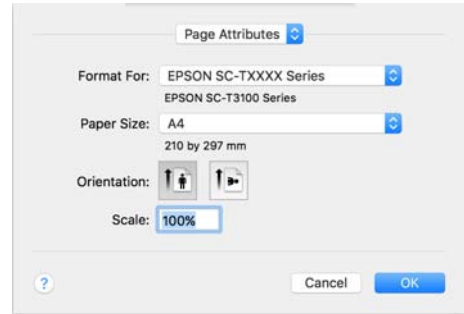

- 4 Check that this printer is selected, and then set the paper size.  
Paper size settings set items including paper size, borderless methods, and paper source.

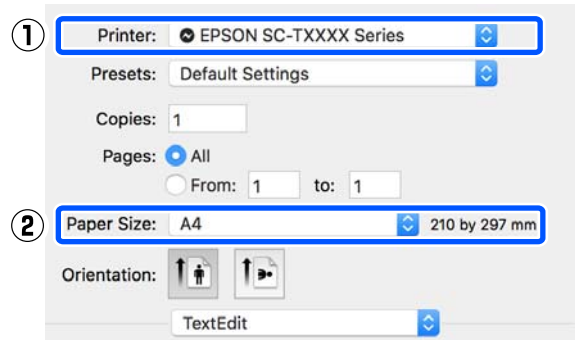

- 5 Select **Printer Settings** from the list and set **Output Size**.  
If **Printer Settings** is not displayed in the list, the dedicated printer driver for this printer has not been added. See the following and then add the printer driver.

☞ “How to Select the Dedicated Printer Driver for This Printer” on page 57

## Printing with the Printer Driver from Your Computer

To enlarge or reduce the size, select from the pull-down menu below the Paper Size.

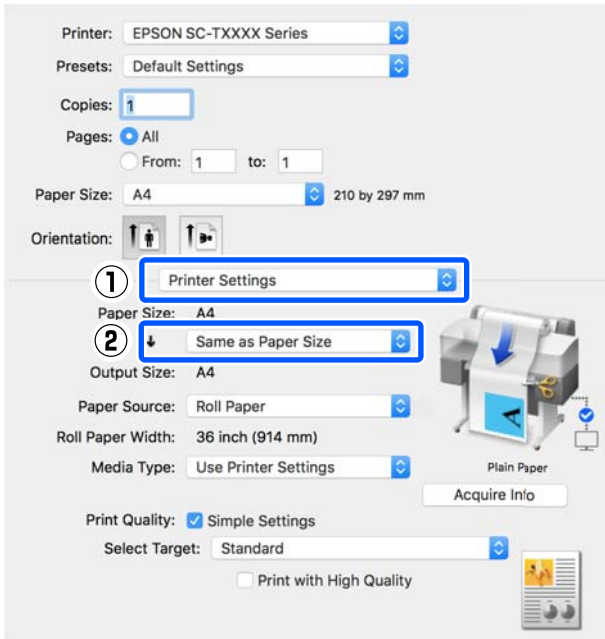

See the following for more details on enlargement settings.

[“Enlargements and Horizontal and Vertical Banners” on page 61](#)

- 6** Select Select Target in **Print Quality**.  
Choose an option according to the type of document and how it will be used.

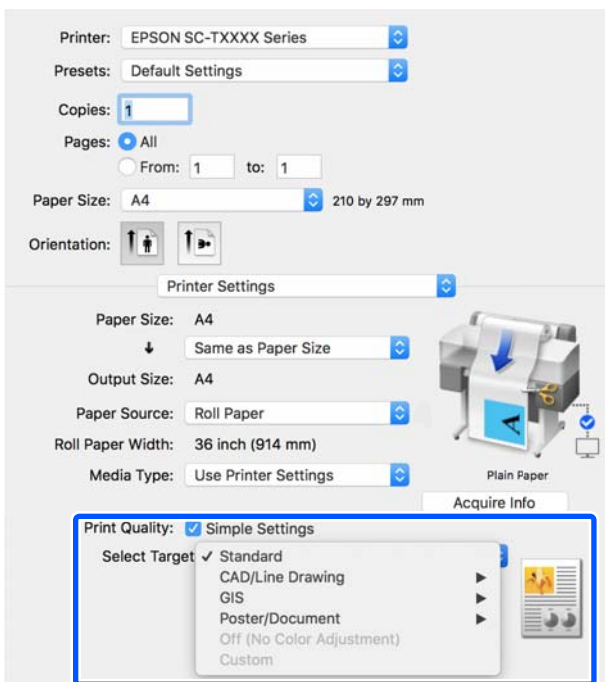

To set the color correction method or color balance in detail to match your preferences, clear the **Simple Settings** check box. See the following for more details.

[“Correct color and print” on page 74](#)

- 7** Check that the **Print Preview** check box is selected and then click **Print**.

If a preview is not necessary, clear the check box and then click **Print**.

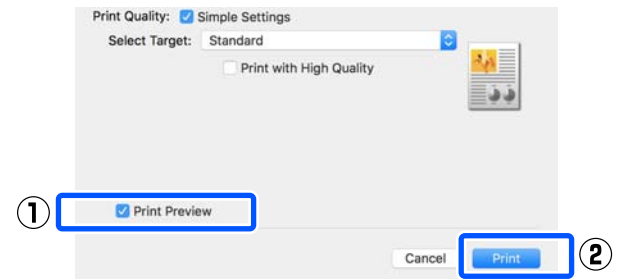

**Note:**

*In the print preview, you can check and change the print settings while viewing the image to be actually printed. We recommend to check with the preview when printing on roll paper or large-sized paper.*

- 8** Check the print settings in the print preview screen, and if there is no problem, click **Print** to start printing.

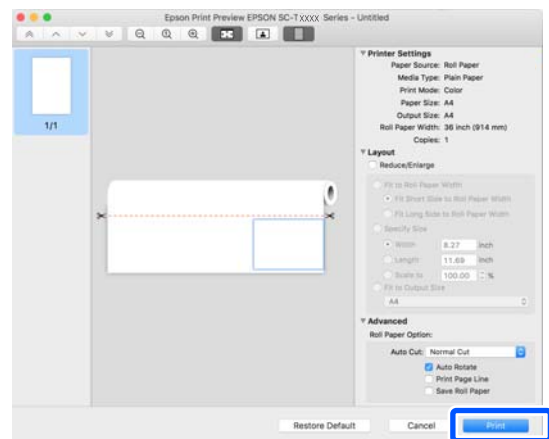

The icons and menus at the top of the preview screen allow you to change the image display settings. You can change the print settings using the menus on the right side. See the help for more details.



## Printing with the Printer Driver from Your Computer

### Note:

See the printer driver help for more details on setting items. Click  in the printer driver settings dialog box to display Help.

## How to Select the Dedicated Printer Driver for This Printer

If the menus described in the previous section "Basic Printing Procedure" are not displayed, select the dedicated printer driver for the printer in **Printer**. The dedicated printer driver for this printer is displayed as follows.

- When USB connection  
EPSON SC-TXXXX
- When network connection  
EPSON TXXXX or EPSON TXXXX-YYYYYY

\*: "XXXX" is the product model number. "YYYYYY" is the last six digits of the MAC address.

If the dedicated printer driver for this printer is not displayed in the list, add it with the following procedure.

- 1 Select **System Preferences - Printers & Scanners** (or **Print & Scan / Print & Fax**) from the Apple menu.
- 2 Click **[+]** and select **Add Printer or Scanner**.
- 3 When the list of devices appears, select the dedicated printer driver for this printer and click **Add**.

## Canceling Printing

There are a few ways to stop printing operations depending on the situation. When the computer has finished sending data to the printer, you cannot cancel the print job from the computer. Cancel on the printer.

## Canceling from a Computer

- 1 Click the icon of this printer in the Dock.

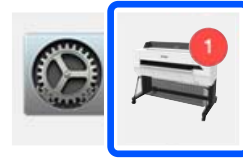

- 2 Select the job you want to cancel, and then click **Delete**.

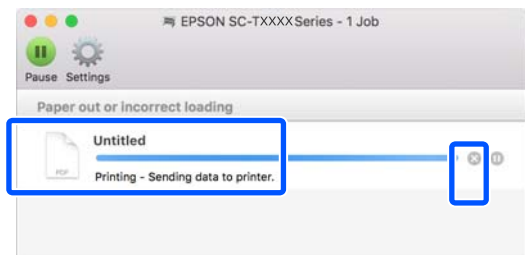

If the job has been sent to the printer, print data is not displayed on the above screen.

## Canceling on the printer

The **Cancel** button is displayed on the control panel screen during printing. Touch the **Cancel** button. The print job is canceled even in the middle of printing. It may take a while before the printer returns to the ready status.

However, print jobs in the print queue on a computer cannot be deleted in this way. Use the procedure of "Canceling from a Computer" to delete print jobs in the print queue.

## Customizing the Printer Driver

You can assign a name to frequently used setting information (paper size and each item of the basic settings) and then save the information to **Presets**. This allows you to easily load settings and repeatedly print using exactly the same settings.

## Saving Frequently Used Settings as Preset

- 1 Set each item on the Paper Size and Printer Settings tabs to the settings you want to save as Presets.

## Printing with the Printer Driver from Your Computer

- 2** Click **Save Current Settings as Preset** in **Presets**.

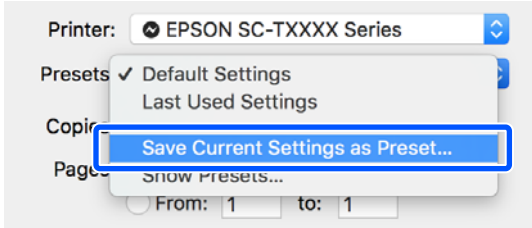

- 3** Enter a name, and then click **OK**.

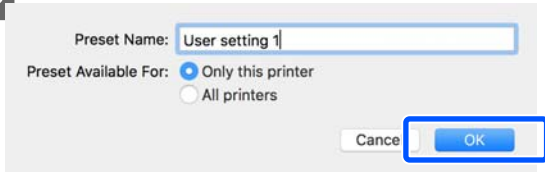

**Note:**  
When **All printers** is selected from **Preset Available For**, you can select the saved **Presets** from all printer drivers installed on your computer.

The settings are saved to **Presets**. You can then select the settings you saved from **Presets**.

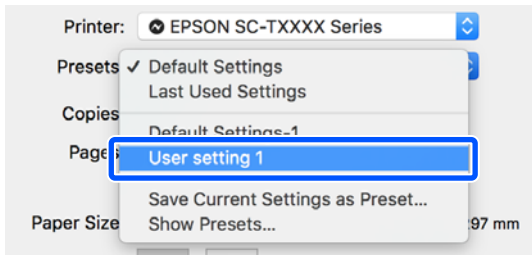

## Deleting from Presets

- 1** Click **Show Presets...** in **Presets** of the Print dialog box.

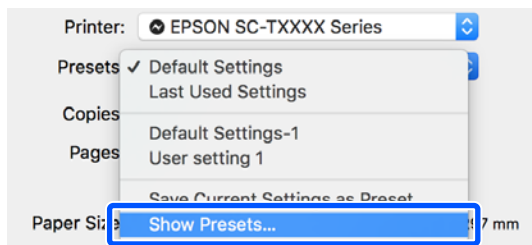

- 2** Select the setting you want to delete, click **Delete**, and then click **OK**.

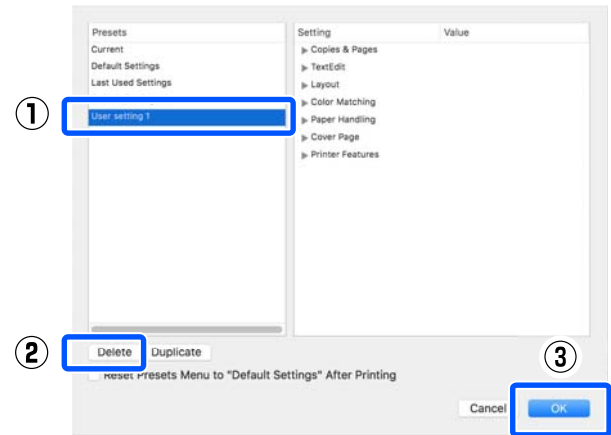

## Printing with the Printer Driver from Your Computer

# Printing CAD Drawings

There are the following two methods to print CAD drawings.

### Printing with the printer driver

This method is best suited for printing CAD drawings such as the appearance views of buildings at high quality. This section describes the procedure to print using the printer driver from AutoCAD 2018.



**Important:**

*If lines or parts in your drawing are not printed properly, print using the HP-GL/2 or HP RTL mode.*

### Printing using the HP-GL/2 or HP RTL mode

This method is best suited for printing CAD and GIS drawings such as maps and blueprints.

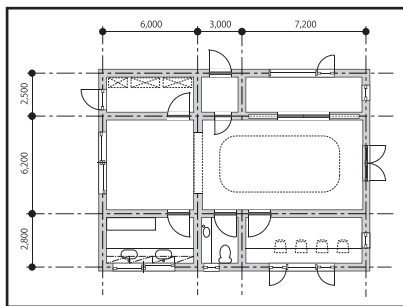

You can print from an application that supports HP-GL/2 (compatible with HP Designjet 750C) and HP RTL. See the following for more details.

[“Printing Using the HP-GL/2 or HP RTL Mode from a Computer” on page 95](#)

**1** Open the data to be printed and then click **Plot**.

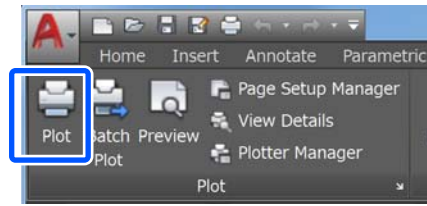

**2** Select the printer in **Printer/plotter** and then click **Properties**.

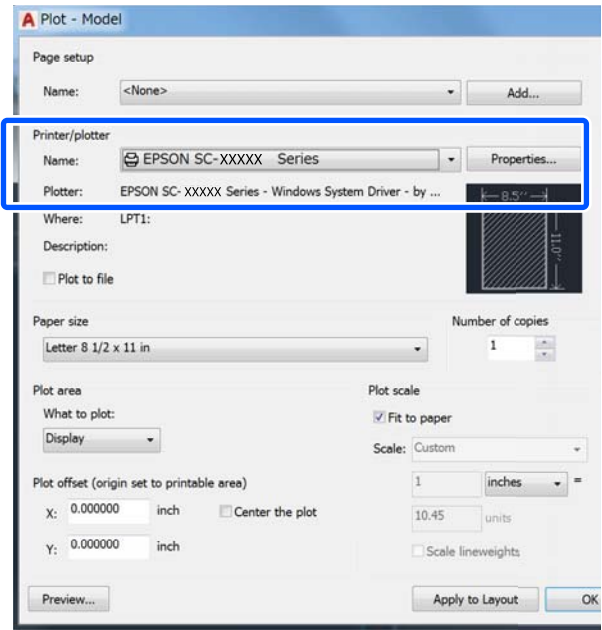

**3** Click **Custom Properties**.

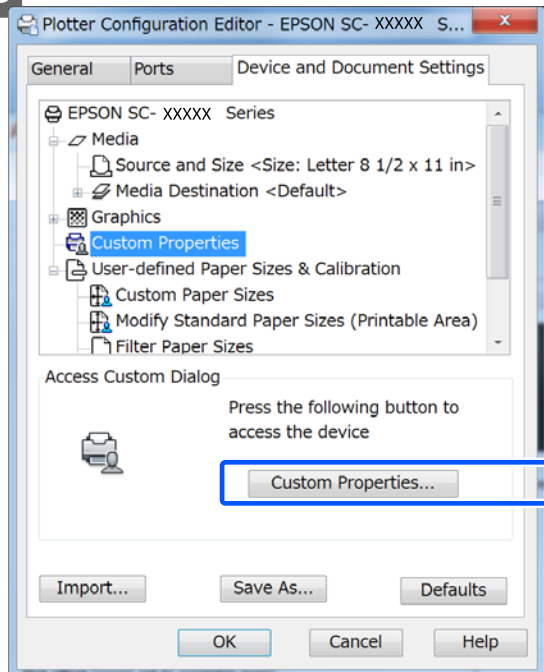

## Printing with the Printer Driver from Your Computer

The printer driver's dialog box for this printer appears.

**4** Set Output Size and Source in the printer driver.

☞ “Basic Operating Procedures (Windows)” on page 49

☞ “Basic Operating Procedures (Mac)” on page 55

**5** Select **CAD/Line Drawing - Black**, **CAD/Line Drawing - Color**, or **CAD/Line Drawing - Bi-Level** from the **Select Target** list.

### Windows

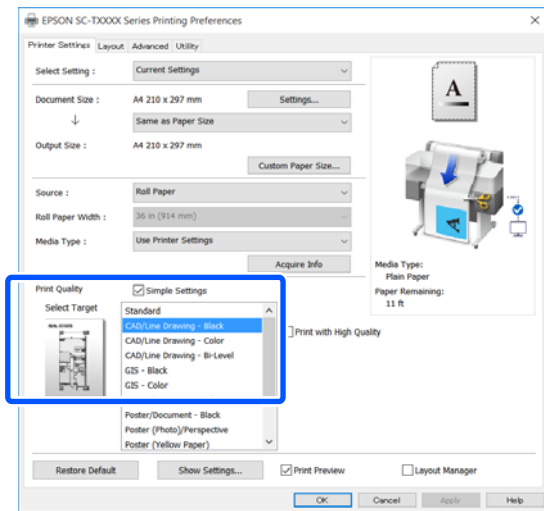

### Mac

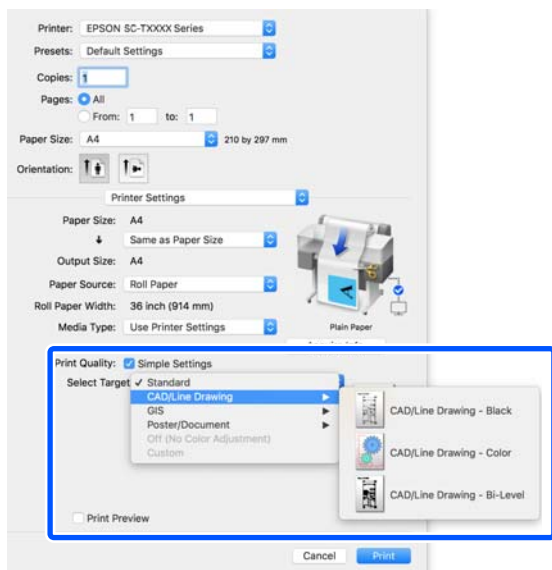

**6** Check other settings, and then start printing.

**Note:**

*If the output size is portrait and the height is smaller than the width of the roll paper, the print image is printed rotated 90° to save paper. This function is enabled if the **Auto Rotate** check box is selected in **Roll Paper Option** on the **Advanced** tab.*

## Printing with the Printer Driver from Your Computer

# Enlargements and Horizontal and Vertical Banners

The printer driver can enlarge or reduce documents for different paper sizes. There are three setting methods.

Before printing at non-standard sizes, including vertical or horizontal banners and documents with equal sides, enter the desired paper size in the printer driver.

 [“Printing at Non-Standard Sizes” on page 66](#)

- Fit to Roll Paper Width**  
Automatically enlarges or reduces the image size to fit the roll paper width.



- Fit to Output Size**  
Automatically enlarges or reduces the image size to fit the paper size.

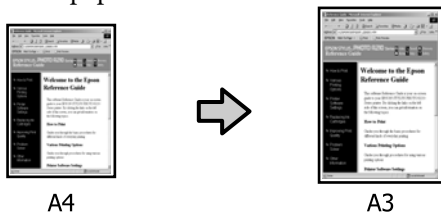

- Specify Size**  
You can specify the enlargement or reduction ratio. Use this method for a non-standard paper size.

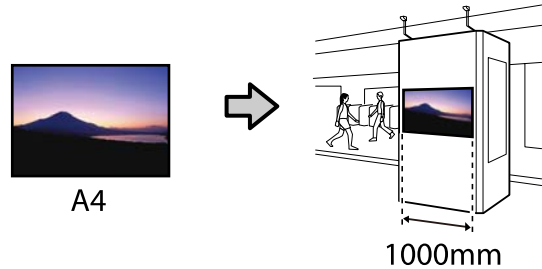

### Note:

- When printing from applications designed expressly for horizontal or vertical banners, adjust printer driver settings as described in the application documentation.
- When using a Windows application designed for banners, select **Print Banner** on the Layout tab if necessary.

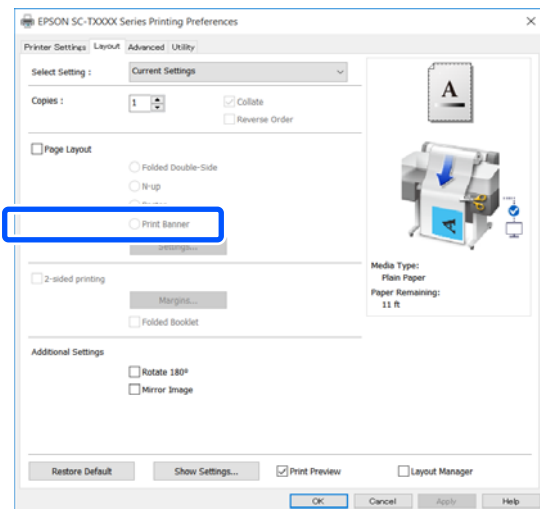

## Printing with the Printer Driver from Your Computer

### Fitting Documents to the Width of the Roll Paper

1 Check the document size (or paper size) setting on the Printer Settings tab of the printer driver.

#### Windows

Display the Printer Settings tab of the printer driver from the application and check that the document size is the same as the setting of the application.

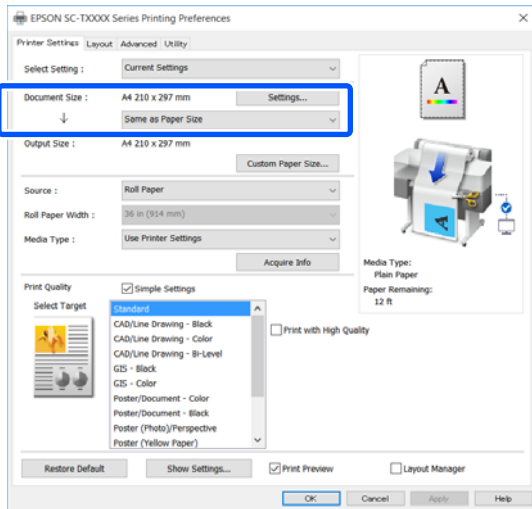

If it differs, click **Settings...** and specify the correct size in the Change Paper Size dialog box.

📖 “Basic Operating Procedures (Windows)” on page 49

#### Mac

Open the page setup screen of the application and check that this printer is selected in **Printer** and check the paper size.

Select a paper size that does not have (Retain Scale) or (Roll Paper Banner).

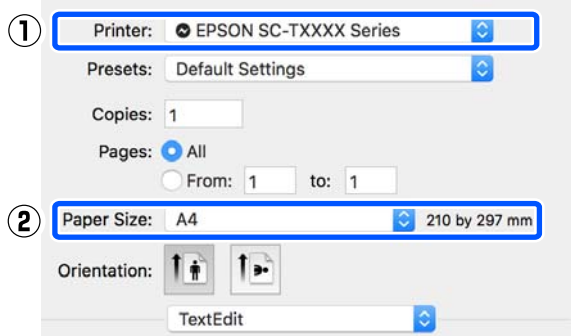

If the size is different, select the correct size from the pull-down menu.

📖 “Basic Operating Procedures (Mac)” on page 55

#### Note:

*In the case of an application without a page setup menu item, you can set the paper size if you open the Print dialog box from the **Print** menu item.*

2 Click **Fit to Roll Paper Width** on the Printer Settings tab of the printer driver and select either **Fit Short Side to Roll Paper Width** or **Fit Long Side to Roll Paper Width**.

#### Windows

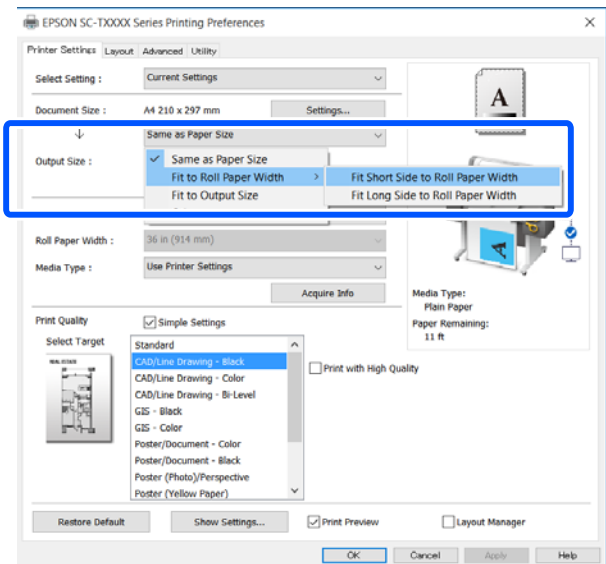

#### Mac

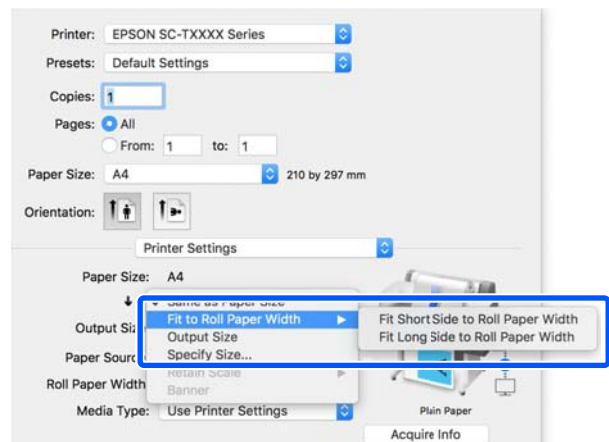

## Printing with the Printer Driver from Your Computer

### Fit Short Side to Roll Paper Width

Select this when you want to print with the print image enlarged to the maximum size for the loaded roll paper.

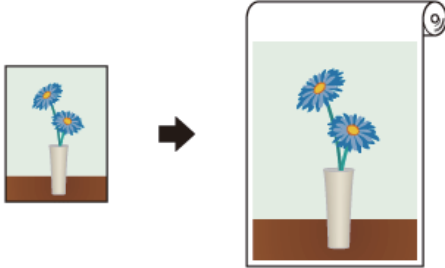

### Fit Long Side to Roll Paper Width

Select this when you want to print with the print image enlarged as much as possible to the extent that paper will not be wasted.

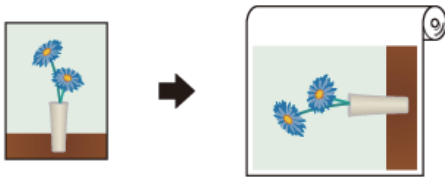

- 3 Check other settings, and then start printing.

## Fitting Documents to the Output Size

- 1 Check the document size (or paper size) setting on the Printer Settings tab of the printer driver.

### Windows

Display the Printer Settings tab of the printer driver from the application and check that the document size is the same as the setting of the application.

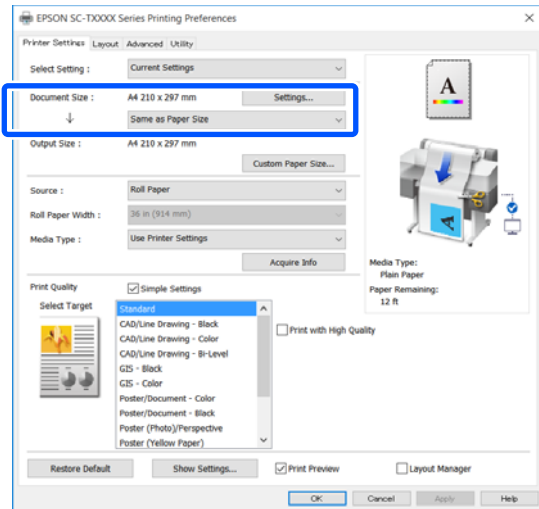

If it differs, click **Settings...** and specify the correct size in the Change Paper Size dialog box.

[“Basic Operating Procedures \(Windows\)” on page 49](#)

### Mac

Open the page setup screen of the application and check that this printer is selected in **Printer** and check the paper size.

Select a paper size that does not have (Retain Scale) or (Roll Paper Banner).

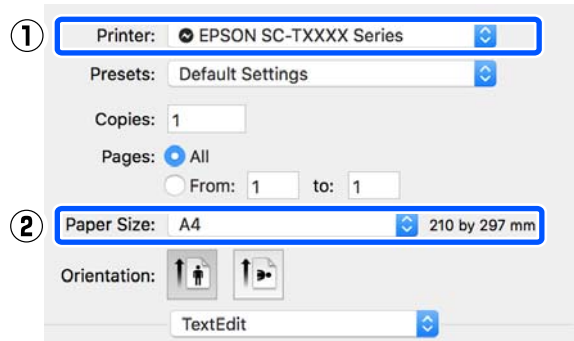

## Printing with the Printer Driver from Your Computer

If the size is different, select the correct size from the pull-down menu.

 [“Basic Operating Procedures \(Mac\)” on page 55](#)

- 2 Select **Fit to Output Size** on the Printer Settings tab of the printer driver.

### Windows

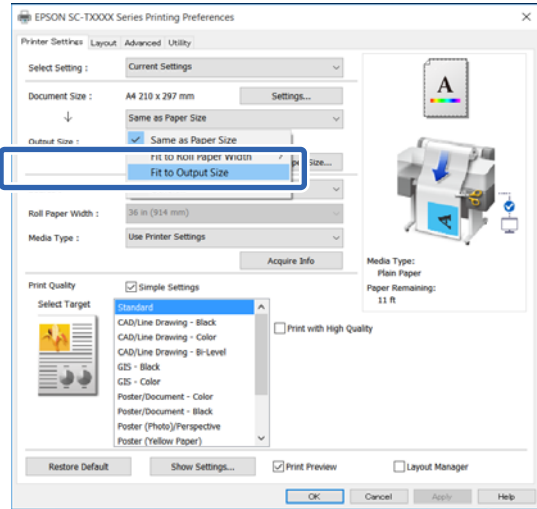

### Mac

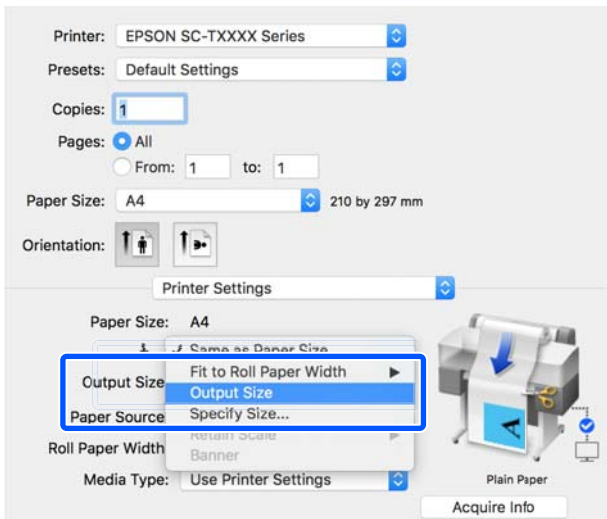

- 3 Select the desired size from the **Output Size** pull-down menu.

### Windows

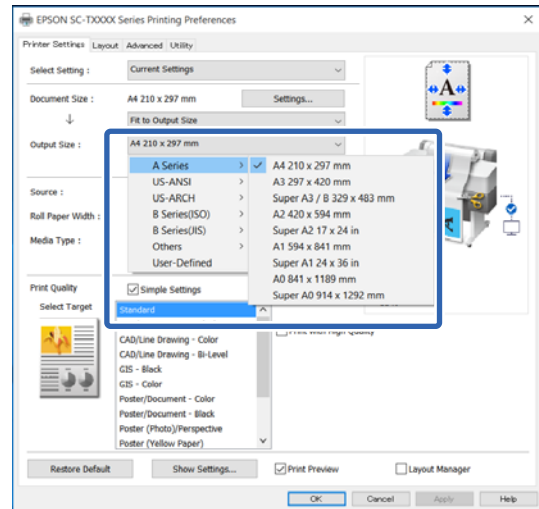

### Mac

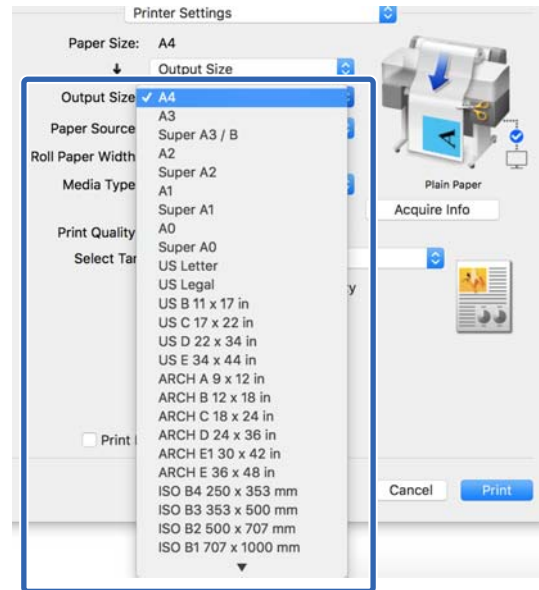

- 4 Check other settings, and then start printing.



## Printing with the Printer Driver from Your Computer

### Choosing a Print Size

- 1 Check the document size (or paper size) setting on the Printer Settings tab of the printer driver.

#### Windows

Display the Printer Settings tab of the printer driver from the application and check that the document size is the same as the setting of the application.

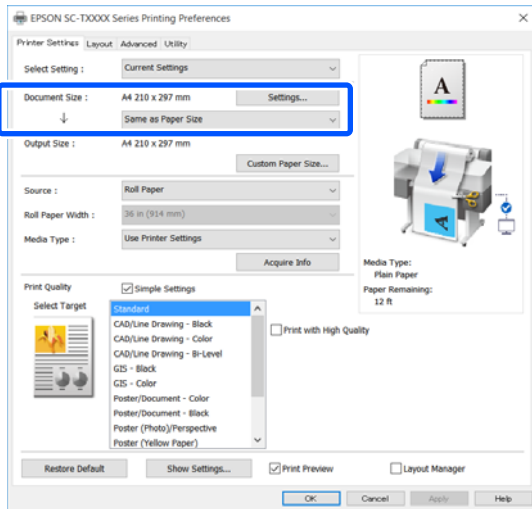

If it differs, click **Settings...** and specify the correct size in the Change Paper Size dialog box.

[Basic Operating Procedures \(Windows\)](#) on page 49

#### Mac

Open the page setup screen of the application and check that this printer is selected in **Printer** and check the paper size.

Select a paper size that does not have (Retain Scale) or (Roll Paper Banner).

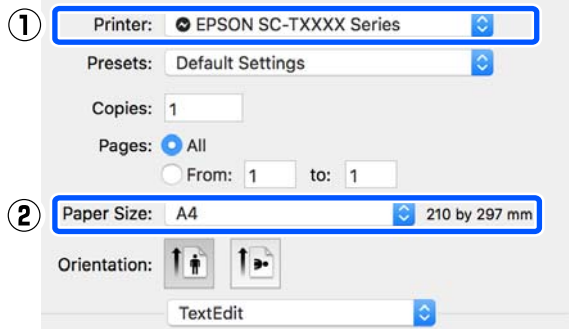

If the size is different, select the correct size from the pull-down menu.

[Basic Operating Procedures \(Mac\)](#) on page 55

#### Note:

*In the case of an application without a page setup menu item, you can set the paper size if you open the Print dialog box from the **Print** menu item.*

- 2 Display the Output Size input screen from the Printer Settings tab of the printer driver.

#### Windows

Select **Others...** and then select **Specify Size** in the displayed Output Size dialog box.

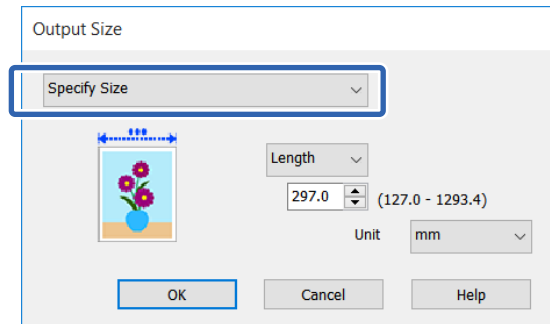
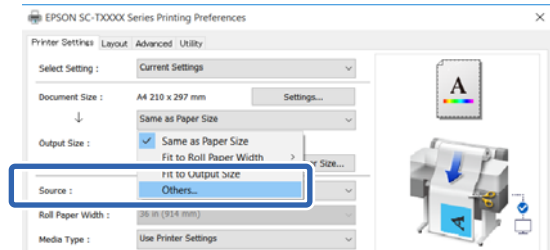

#### Mac

Select **Specify Size**.

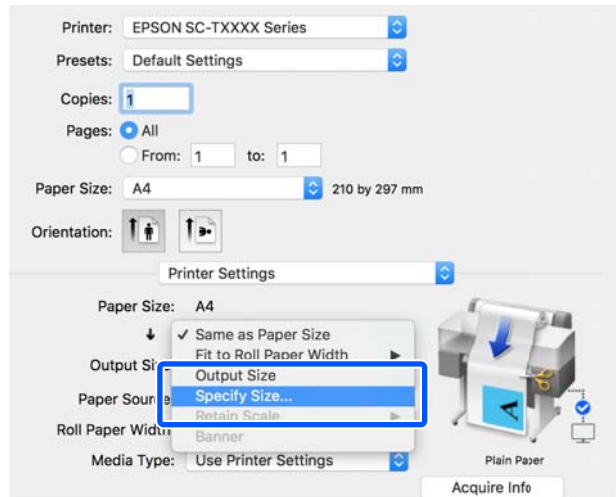

**Printing with the Printer Driver from Your Computer**

**3** Select the size specification method from Width, Length, and Scale to and then enter the setting value.

The print image is enlarged or reduced so that it becomes the specified width, length, or scale while maintaining the aspect ratio of the print data.

**Windows**

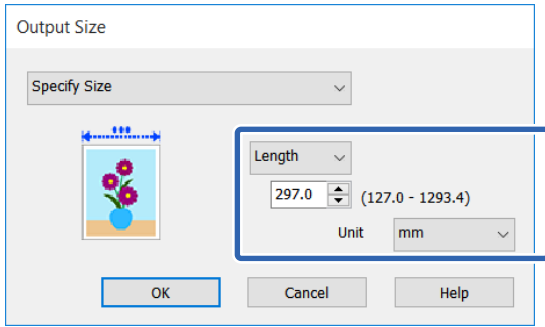

**Mac**

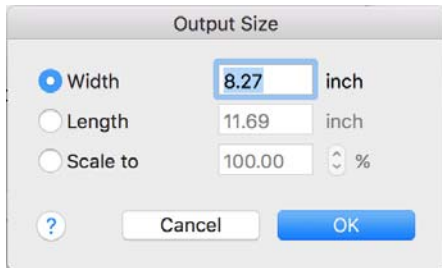

**4** Check other settings, and then start printing.

**Printing at Non-Standard Sizes**

Before printing at non-standard sizes, including vertical or horizontal banners and documents with equal sides, save the desired paper size in the printer driver. Once they have been saved in the printer driver, custom sizes can be selected in the application **Page Setup** and other print dialogs.

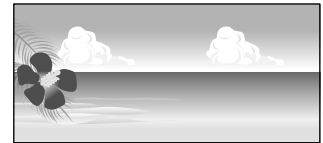

The following sizes can be used.

Paper Width	SC-T5400 Series	89 to 914 mm
	SC-T3400 Series/ SC-T3400N Series	89 to 610 mm
Paper Length*	127 to 18000 mm	

\*: The paper length can be longer when using an application that supports banner printing. However, the actual print size depends on the application, the paper size loaded in the printer, and the computer environment.

**! Important:**

- ❑ The smallest size supported by the printer is 89 mm wide × 127 mm long. When a smaller size than this is set in **Custom Paper Size...** of the printer driver, trim the unnecessary margins.
- ❑ For Custom Paper Sizes of a Mac, although you can specify a large paper size which cannot be loaded in this printer, it will not be printed properly.
- ❑ The available output size is limited depending on the application.

## Printing with the Printer Driver from Your Computer

### Settings in Windows

- 1 Display the Printer Settings tab of the printer driver from the application and then click **Custom Paper Size...**

The User-Defined Paper Size dialog box appears.

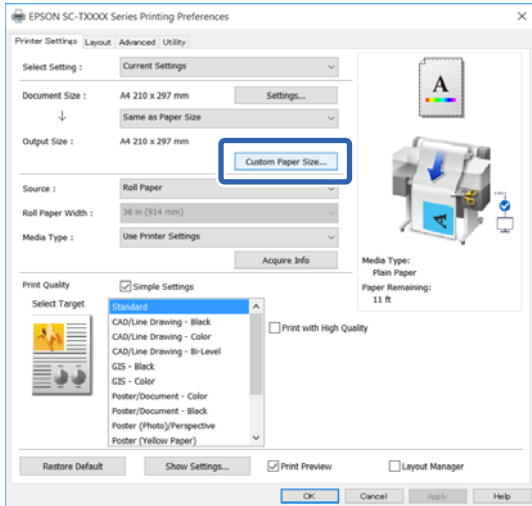

- 2 Set the paper size to use in the User-Defined Paper Size dialog box and then click **Save**.

- The **Paper Size Name** is displayed as a document size or output size option. Set a meaningful name such as "400x500mm" or "Horizontal Banner".
- To view the **Paper Width** and **Paper Height** values for a standard size close to the desired custom size, select the appropriate option in **Base Paper Size**.
- If you select an aspect ratio in **Fix Aspect Ratio** and select **Landscape** or **Portrait** for **Base**, you can set the size by just entering a value in either **Paper Width** or **Paper Height**.

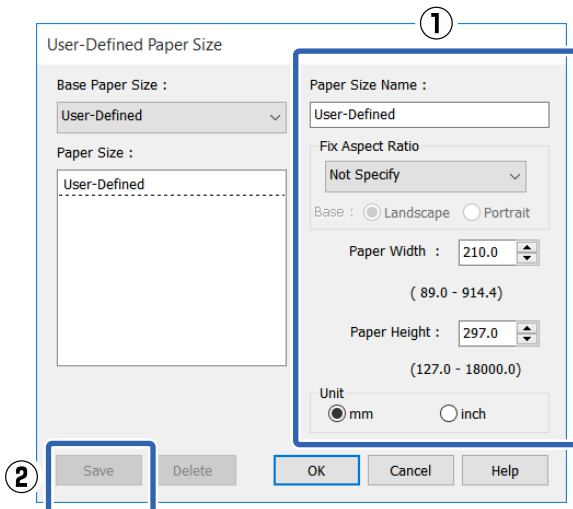

#### Note:

- To change the paper size you saved, select the paper size name from the list on the left.
- To delete a saved paper size, select the paper size name from the list on the left of the screen and then click **Delete**.
- You can save up to 100 paper sizes.

- 3 Click **OK** to close the User-Defined Paper Size dialog box. Also close the printer driver's dialog box.

Registration of the user-defined size is now complete.

- 4 Select the registered paper size in, for example, the page size settings of the application and then create the data.

#### Note:

If the registered paper size is not displayed in the application, check whether it exceeds the sizes supported by the application.

- 5 When you have finished creating the data, display the Printer Settings tab of the printer driver from the Print dialog box.

The registered paper size is displayed in Paper Size on the Printer Settings tab.

["Basic Operating Procedures \(Windows\)" on page 49](#)

- 6 Check other settings, and then start printing.

## Printing with the Printer Driver from Your Computer

### Settings in Mac

- 1 Open the page setup screen of the application and check that this printer is selected in **Printer** and then select **Manage Custom Sizes** from **Paper Size**.

“Basic Operating Procedures (Mac)” on page 55

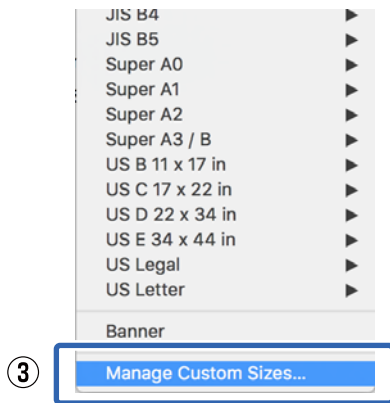
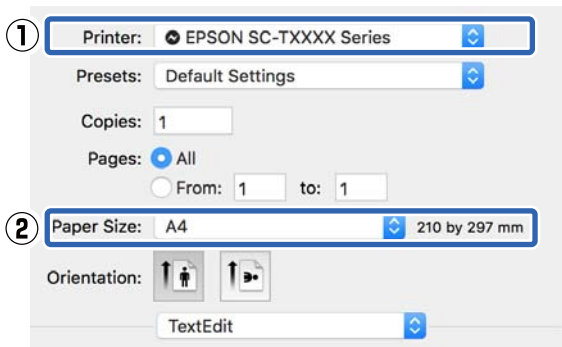

**Note:**

In the case of an application without a page setup menu item, the paper size settings can be displayed by opening the **Print** dialog box from the **Print** menu item.

- 2 Click **+** and then enter the paper size name.

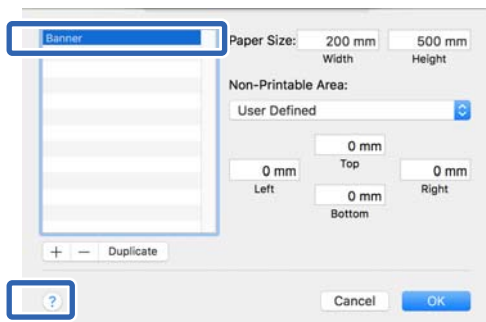

- 3 Enter values in **Width** and **Height** of the **Paper Size**, enter the margins, and then click **OK**.

The ranges of page sizes and margin sizes that can be specified differ depending on your printer model and the settings on the printer.

“Printable area” on page 223

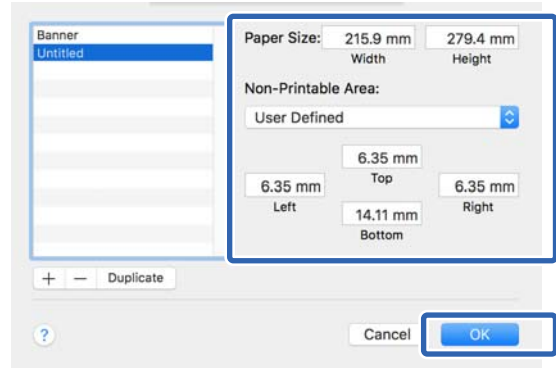

**Note:**

- To edit a saved custom size, choose its name from the list on the left.
- To duplicate a saved paper size, select its name from the list on the left of the screen and click **Duplicate**.
- To delete a saved paper size, select its name from the list on the left of the screen and click **-**.
- The custom paper size setting differs depending on the operating system version. See your operating system's documentation for details.

- 4 Click **OK** to close the Custom Paper Sizes dialog box. Also close the printer driver's dialog box by clicking **Cancel**.

Registration of the custom paper size is now complete.

- 5 Select the registered paper size in, for example, the page size settings of the application and then create the data.

**Note:**

If the registered paper size is not displayed in the application, check whether it exceeds the sizes supported by the application.

## Printing with the Printer Driver from Your Computer

**6** When you have finished creating the data, display the Printer Settings tab of the printer driver from the Print dialog box.

The registered paper size is displayed in Document Size on the Printer Settings tab.

 [“Basic Operating Procedures \(Mac\)” on page 55](#)

**7** Check other settings, and then start printing.

## Printing with the Printer Driver from Your Computer

### Borderless Printing

You can print your data without margins on the paper.

The types of borderless printing you can choose vary as shown below depending on the media type.

Roll Paper: No margins for all edges, no margins for the left and right

Cut Sheets: No margins for the left and right only

When printing borderless for all edges, you can also configure the cutting operation.

[“About Roll Paper Cutting” on page 71](#)

When performing left and right borderless printing, margins appear on the top and bottom of the paper.

Top and bottom margin values

[“Printable area” on page 223](#)

---

### Types of Borderless Printing Methods

You can perform borderless printing using the following two methods.

- Auto Expand**  
The printer driver enlarges the print data to a size slightly larger than the paper size and prints the enlarged image. The sections which are beyond the paper edges are not printed; therefore, resulting in borderless printing.  
Use settings such as Page Setup in the applications to set the size of the image data as follows.
  - Match the paper size and page setting for the print data.
  - If the application has margin settings, set the margins to 0 mm.
  - Make the image data as large as the paper size.

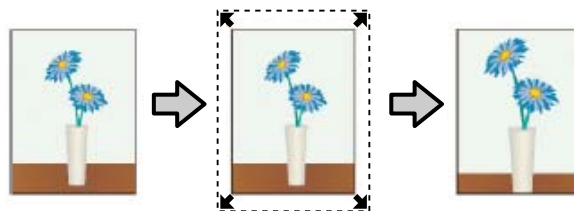

- Retain Size**  
Create the print data larger than the paper size in the applications to produce borderless output. The printer driver does not enlarge the image data. Use settings such as Page Setup in the applications to set the size of the image data as follows.
  - Create print data larger than its actual print size by 3 mm on the left and right (6 mm in total).
  - If the application has margin settings, set the margins to 0 mm.
  - Make the image data as large as the paper size.

Select this setting if you want to avoid image enlargement by the printer driver.

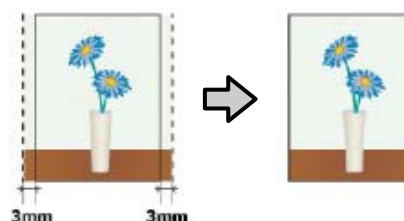

---

### Supported Paper

Depending on the media type and size, the print quality may decline or borderless printing cannot be selected.

[“Epson Special Media Table” on page 216](#)

[“Supported Commercially Available Paper” on page 220](#)

**Printing with the Printer Driver from Your Computer**

**About Roll Paper Cutting**

When performing borderless printing on roll paper, you can specify whether it is left and right borderless printing or all edges borderless printing, and how to cut the paper in the printer driver's **Roll Paper Option**. The cutting operation for each value is shown in the following chart.

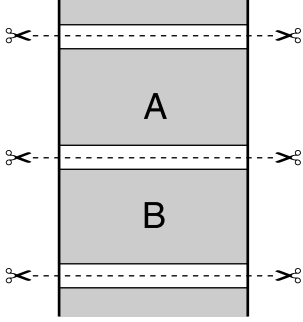
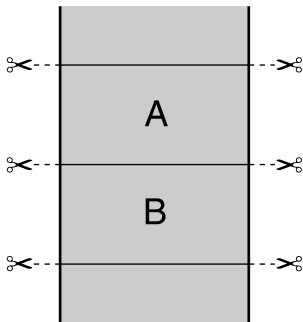
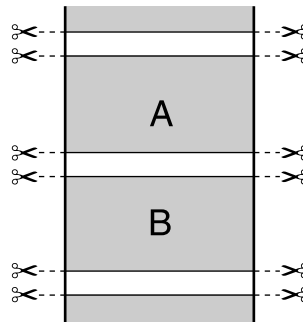
Printer driver settings	Borderless	Single Cut	Double Cut
Cutting Operation			
Explanation	<p>The default printer driver setting is <b>Borderless</b>.</p>	<ul style="list-style-type: none"> <li><input type="checkbox"/> The top area may become slightly uneven depending on the image since the print operation stops while cutting the top edge of the roll paper.</li> <li><input type="checkbox"/> When you print one page only or print one page multiple times, the operation is the same as that for <b>Double Cut</b>. When continuously printing multiple sheets, the printer cuts 1 mm inside on the top edge of the first page and the bottom edge of the subsequent pages to avoid showing margins.</li> </ul>	<ul style="list-style-type: none"> <li><input type="checkbox"/> The top area may become slightly uneven depending on the image since the print operation stops while cutting the top edge of the roll paper.</li> <li><input type="checkbox"/> The printed paper is approximately 2 mm shorter than the specified size since the printer cuts the paper inside the image to avoid showing top and bottom margins.</li> <li><input type="checkbox"/> After cutting the bottom edge of the previous page, the printer feeds the paper, and then cuts the top edge of the following page. Although this produces 60 to 127 mm cut-off pieces, the cut is more accurate.</li> </ul>

## Printing with the Printer Driver from Your Computer

### Setting Procedures for Printing

#### Settings in Windows

**1** Display the printer driver's **Printer Settings** tab and adjust the following settings.

☞ “Basic Operating Procedures (Windows)” on page 49

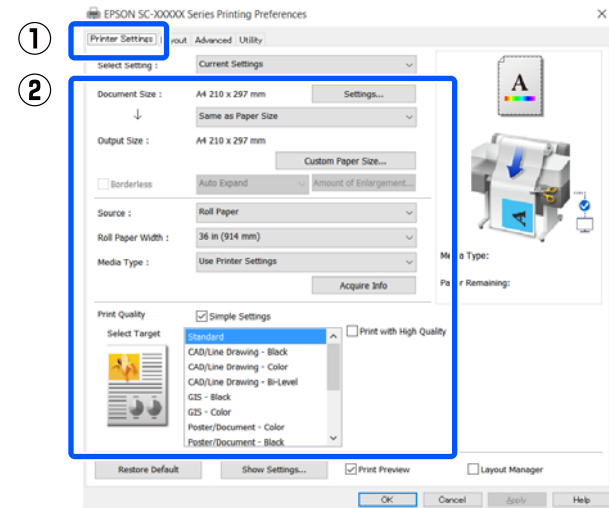

**2** Select **Borderless**.

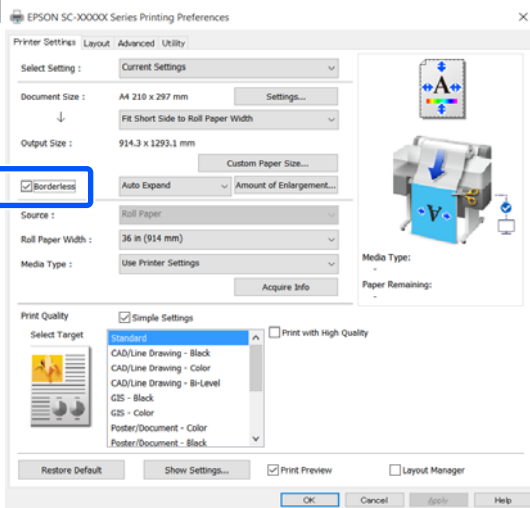

**3** For **Borderless** settings, select from **Auto Expand** or **Retain Size**.

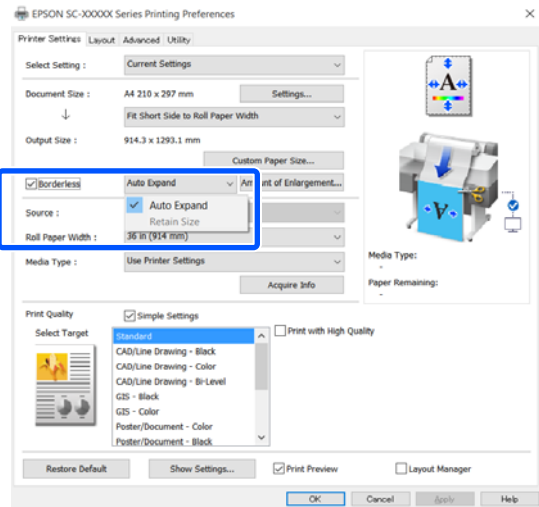

If **Auto Expand** is selected, select the amount of enlargement from the following.

**Max** : 3 mm for left and 5 mm for right  
(the image shifts 1 mm to the right)

**Standard** : 3 mm for left and right

**Min** : 1.5mm for left and right

#### Expansion

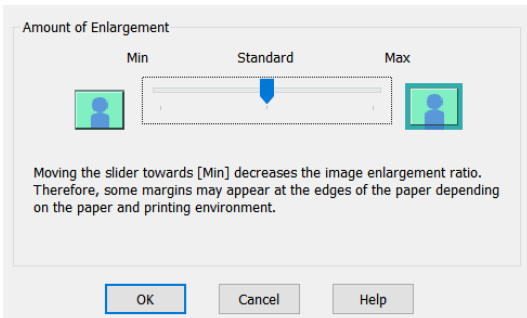

#### Note:

Moving the slider towards **Min** decreases the image enlargement ratio. Therefore, some margins may appear at the edges of the paper depending on the paper and printing environment.

**4** When printing on roll paper, select the **Advanced** tab, and configure the **Auto Cut** setting in the **Roll Paper Option** area.

☞ “About Roll Paper Cutting” on page 71



## Printing with the Printer Driver from Your Computer

**5** Check other settings, and then start printing.

### Settings in Mac

**1** Open the Print screen and select the paper size from the **Paper Size** option, and then select a borderless printing method.

[“Basic Operating Procedures \(Mac\)” on page 55](#)

The selections for borderless printing methods are displayed as shown below.

xxxx (Roll Paper - Borderless, Auto Expand)

xxxx (Roll Paper - Borderless, Retain Size)

xxxx (Roll Paper - Borderless, Banner)

xxxx (Sheet - Borderless, Auto Expand)

xxxx (Sheet - Borderless, Retain Size)

Paper size such as A4 will be displayed in xxxx.

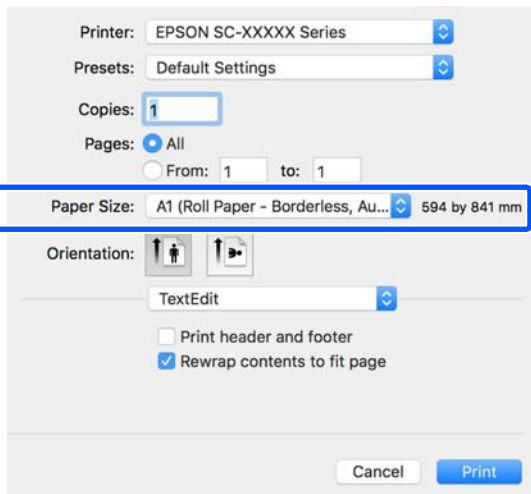

**Note:**

*If page setting options are not available in the application's print dialog, display the page settings dialog.*

**2** If **Auto Expand** is selected for paper size, select **Advanced** from the list, and click **Expansion**.

You can only select **Expansion** if **Auto Expand** is selected in **Paper Size**. The expansion values for each of the settings are as follows.

Max : 3 mm for left and 5 mm for right  
(the image shifts 1 mm to the right)

Standard : 3 mm for left and right

Min : 1.5mm for left and right

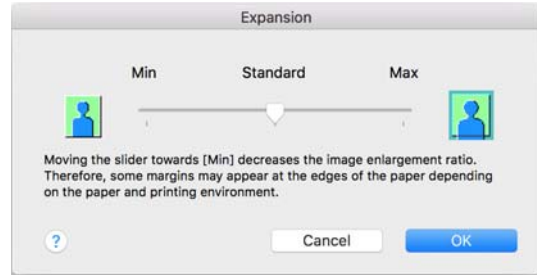

**Note:**

*Moving the slider towards **Min** decreases the image enlargement ratio. Therefore, some margins may appear at the edges of the paper depending on the paper and printing environment.*

**3** When printing on roll paper, select **Advanced** from the list, and choose an **Auto Cut** option.

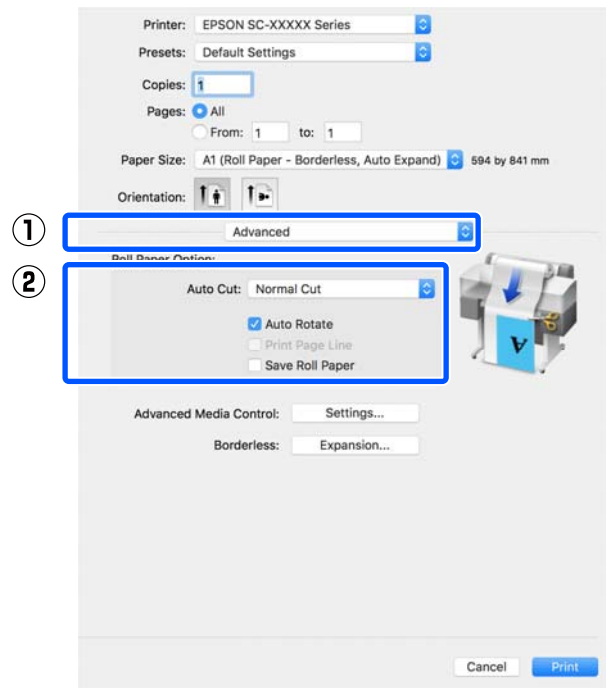



**4** Check other settings, and then start printing.

## Printing with the Printer Driver from Your Computer

### Correct color and print

The optimal method is selected from the following color correction methods for each print target in the print quality settings of the printer driver.

- EPSON Standard (sRGB)  
Optimizes the sRGB space and corrects the color.
- Business Graphics  
Performs color correction to sharpen your images based on the sRGB space.
- Line Drawing  
Optimizes color correction for line drawing by processing the border between lines and the background as discontinuous.
- GIS  
Performs the optimal printing for topographic maps and other data of the geographic information system (GIS).
- ICM  
Performs color management to match the colors in the image data to those in the printed output (Windows only).  
 ["Color Management Printing" on page 78](#)
- Off (No Color Adjustment)  
Color correction is not performed by the printer driver. Choose if color management is performed by the application.  
 ["Color Management Printing" on page 78](#)

If you clear the **Simple Settings** check box, you can check which of the above color correction methods is used. **Standard of Select Target** is the most suitable setting for the currently selected paper type.

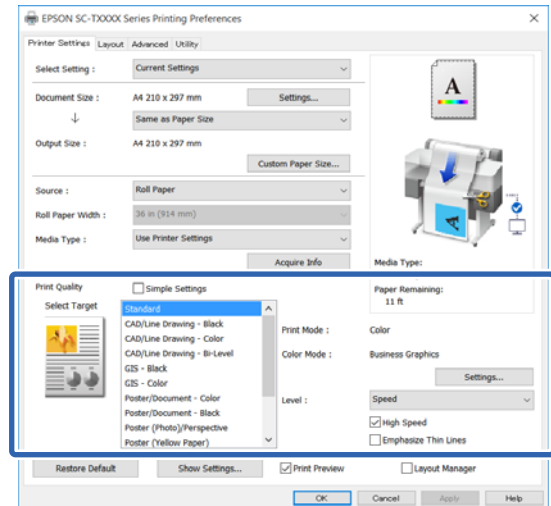

Clicking the **Settings** button allows you to, for example, finely adjust the Gamma, Brightness, Contrast, Saturation, and color balance.

Use this option when the application in use does not have a color correction function.

**Note:**

*The color correction options available vary with the operating system and the type of paper used.*

If you want to select the color correction method yourself, select **Custom** at the very bottom of the print target list.

#### Settings in Windows

- 1** When using applications featuring a color management function, specify how to adjust colors from these applications.

When using applications without a color management function, start from Step 2.

Depending on the type of the application, make the settings following the table below.

Adobe Photoshop CS3 or later  
Adobe Photoshop Elements 6 or later  
Adobe Photoshop Lightroom 1 or later

### Printing with the Printer Driver from Your Computer

OS	Color Management Settings
Windows 10, Windows 8.1, Windows 8, Windows 7, Windows Vista	Printer Manages Colors
Windows XP (Service Pack 2 or later and .NET 3.0 or later)	
Windows XP (other than the above)	No Color Management

In other applications, set **No Color Management**.

**Note:**

For information on supported platforms, see the website for the application in question.

Setting example of Adobe Photoshop CC

Open the **Print** dialog box.

Select **Color Management**, then select **Printer Manages Colors** in **Color Handling**, and click **Print**.

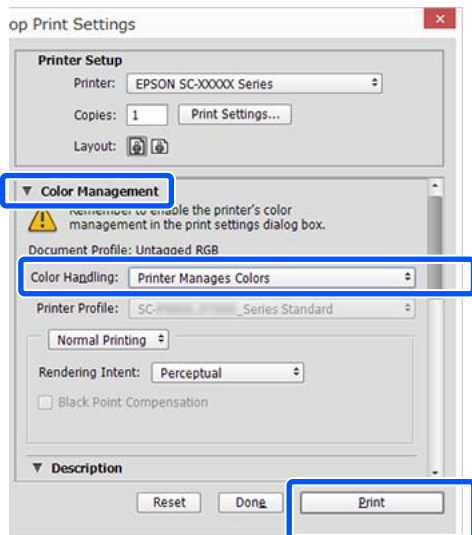

**2** Display the Printer Settings tab of the printer driver and then clear the **Simple Settings** check box in the **Print Quality** area.

[“Basic Operating Procedures \(Windows\)”](#) on page 49

**3** Select the print target. If you want to select the color correction method yourself, select **Custom** at the very bottom of the list.

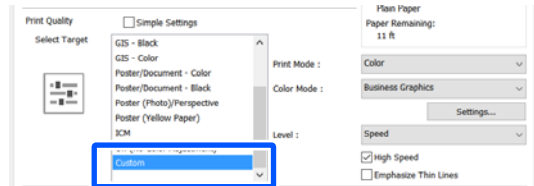

**4** When **Custom** is selected for the print target, select the color and color correction method settings.

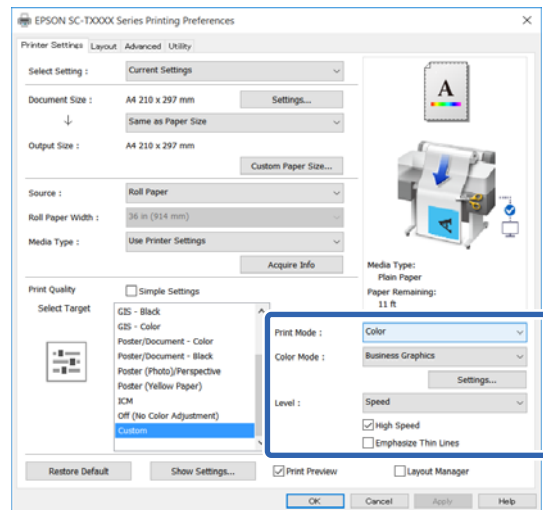

## Printing with the Printer Driver from Your Computer

- 5** If necessary, click **Settings** and then adjust items such as the Gamma, Brightness, Contrast, Saturation, and color balance.

See the printer driver help for more details on each item.

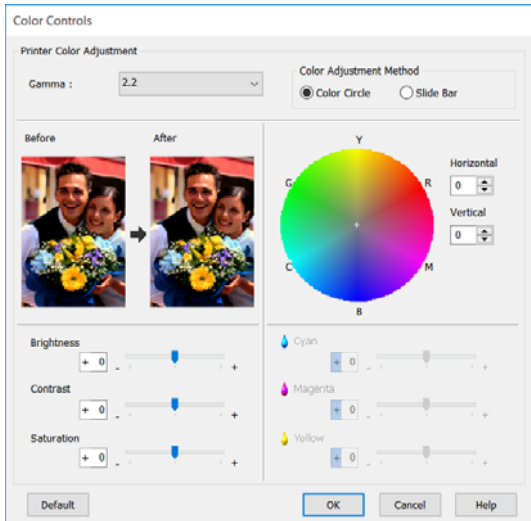

**Note:**

You can adjust the correction value by checking the sample image on the left side of the screen. Furthermore, you can select **Color Circle** or **Slide Bar** of **Color Adjustment Method** and finely adjust the color balance.

- 6** Check other settings, and then start printing.

### Settings in Mac

- 1** When using applications featuring a color management function, specify how to adjust colors from these applications.

When using applications without a color management function, start from Step 2.

When using the following applications, set the color management setting to **Printer Manages Colors**.

- Adobe Photoshop CS3 or later
- Adobe Photoshop Elements 6 or later
- Adobe Photoshop Lightroom 1 or later

In other applications, set **No Color Management**.

**Note:**

For information on supported platforms, see the website for the application in question.

Settings example of Adobe Photoshop CC

Open the **Print** dialog box.

Select **Color Management**, then select **Printer Manages Colors** in **Color Handling**, and click **Print**.

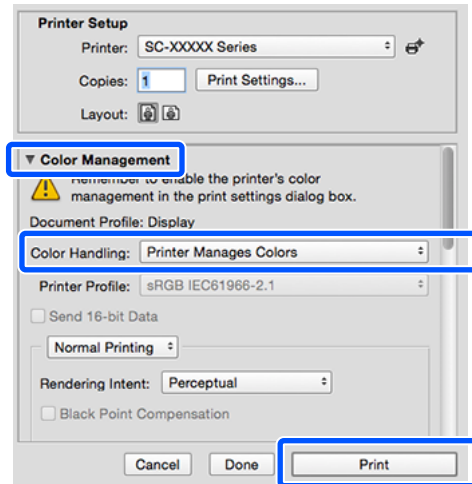

- 2** Display the Print screen.

➦ [“Basic Operating Procedures \(Mac\)” on page 55](#)

- 3** Select **Color Matching** from the list, and then click **EPSON Color Controls**.

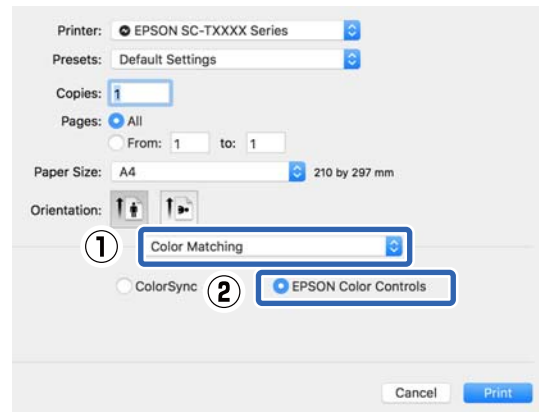

**Note:**

**EPSON Color Controls** will not be available in the following applications if Step 1 is omitted.

- Adobe Photoshop CS3 or later
- Adobe Photoshop Lightroom 1 or later
- Adobe Photoshop Elements 6 or later

### Printing with the Printer Driver from Your Computer

- 4** Select **Printer Settings** from the list and then clear the **Simple Settings** check box in the **Print Quality** area.

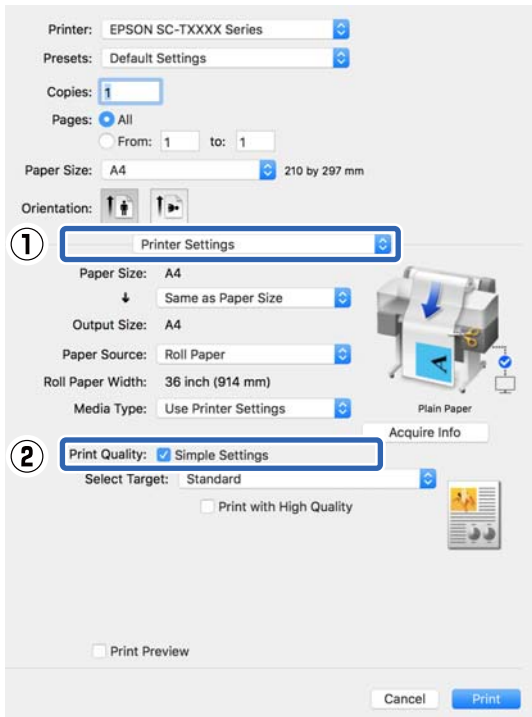

- 5** Select the print target. If you want to select the color correction method yourself, select **Custom** at the very bottom of the list.

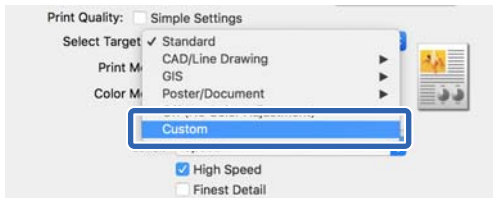

- 6** When **Custom** is selected for the print target, select the color and color correction method settings.

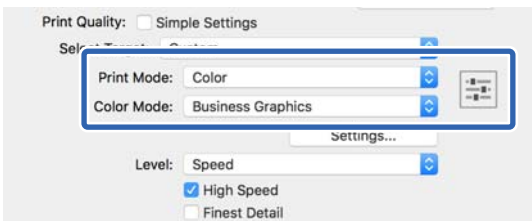

- 7** If necessary, click **Settings** and then adjust items such as the Gamma, Brightness, Contrast, Saturation, and color balance.

See the printer driver help for more details on each item.

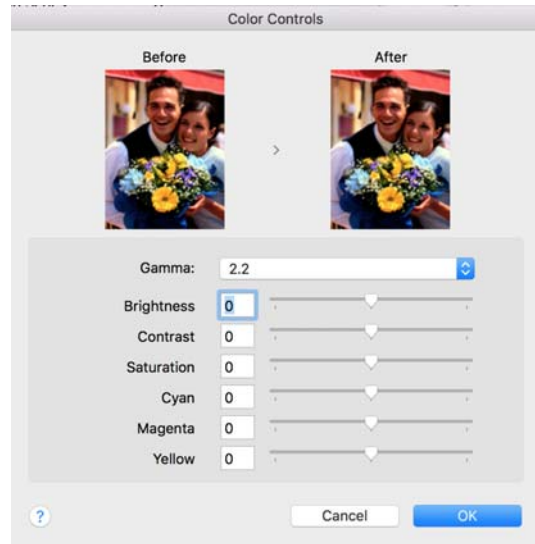

- 8** Check other settings, and then start printing.

## Printing with the Printer Driver from Your Computer

# Color Management Printing

## About Color Management

Even when using the same image data, the original image and the displayed image may look different, and the printed results may look different to the image you see on the display. This occurs due to the difference in characteristics when input devices such as scanners and digital cameras capture colors as electronic data, and when output devices such as display screens and printers reproduce colors from the color data. The color management system is a means to adjust differences in color conversion characteristics among input and output devices. A color management system is included with operating systems such as Windows and Mac OS, in addition to image processing applications. Windows and Mac OS X include the ICM and ColorSync color management systems, respectively.

In a color management system, a color definition file called a "Profile" is used to perform color matching between devices. (This file is also called an ICC profile.) The profile of an input device is called an input profile (or source profile), and the profile of an output device, such as a printer, is called a printer profile (or output profile). A profile is prepared for each media type in this printer's driver.

The color conversion areas by the input device and the color reproduction area by the output device differ. As a result, there are color areas that do not match even when performing color matching using a profile. In addition to specifying profiles, the color management system also specifies conversion conditions for areas where color matching failed as "intent". The name and type of intent vary depending on the color management system you are using.

You cannot match the colors on the printed results and display by color management between the input device and the printer. To match both colors, you need to perform color management between the input device and the display as well.

## Color Management Print Settings

You can perform color management printing using this printer's printer driver in the following two ways.

Choose the best method according to the application you are using, the operating system environment, the aim of the print out, and so on.

### Setting color management with the applications

This method is for printing from applications that support color management. All color management processes are carried out by the application's color management system. This method is useful when you want to obtain the same color management print results using a common application among different operating system environments.

[🔗 “Setting color management with the applications” on page 79](#)

### Setting color management with the printer driver

The printer driver uses the operating system's color management system and carries out all color management processes. You can configure the color management settings in the printer driver using the following two methods.

- ❑ Host ICM (Windows) / ColorSync (Mac OS X)  
Set when printing from applications that support color management. This is effective in producing similar print results from different applications under the same operating systems.  
[🔗 “Color Management Printing by Host ICM \(Windows\)” on page 81](#)  
[🔗 “Color Management Printing by ColorSync \(Mac\)” on page 82](#)
- ❑ Driver ICM (Windows only)  
This allows you to perform color management printing from applications that do not support color management.  
[🔗 “Color Management Printing by Driver ICM \(Windows Only\)” on page 83](#)

## Printing with the Printer Driver from Your Computer

### Setting profiles

Settings for the input profile, printer profile, and intent (matching method) vary between three types of color management printing since their color management engines are used differently. This is because color management usage differs between the engines. Make settings in the printer driver or application as described in the following table.

	Input profile settings	Printer profile settings	Intent settings
Driver ICM (Windows)	Printer Driver	Printer Driver	Printer Driver
Host ICM (Windows)	Application	Printer Driver	Printer Driver
ColorSync (Mac OS X)	Application	Printer Driver	Application
Application	Application	Application	Application

Printer profiles for each paper type that is needed when performing color management are installed with the printer's printer driver. You can select the profile from the printer driver's settings screen.

You can select the profile from the printer driver's settings screen.

[“Color Management Printing by Driver ICM \(Windows Only\)” on page 83](#)

[“Color Management Printing by Host ICM \(Windows\)” on page 81](#)

[“Color Management Printing by ColorSync \(Mac\)” on page 82](#)

[“Setting color management with the applications” on page 79](#)

### Setting color management with the applications

Print using applications with a color management function. Make the color management settings in the application and disable the printer driver's color adjustment function.

**1** Make color management settings in the applications.

Settings example of Adobe Photoshop CC

Open the **Print** dialog box.

Select **Color Management**, select **Photoshop Manages Colors** in **Color Handling**, select **Printer Profile** and **Rendering Intent**, and click **Print**.

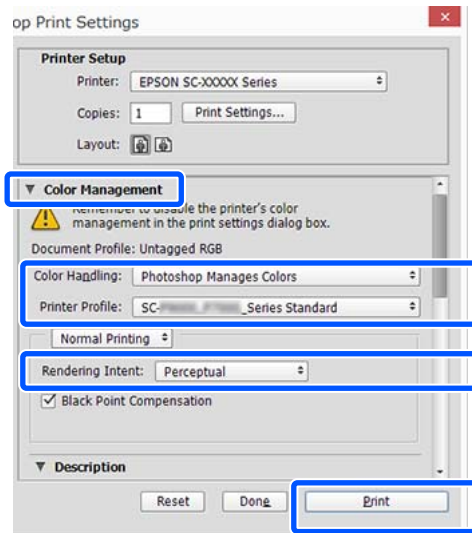

**2** Display the printer driver's settings screen (Windows) or Print screen (Mac).

Make printer driver settings.

**For Windows**

[“Basic Operating Procedures \(Windows\)” on page 49](#)

**For Mac**

[“Basic Operating Procedures \(Mac\)” on page 55](#)

## Printing with the Printer Driver from Your Computer

**3** Set color management to off.

### For Windows

Clear the **Simple Settings** check box in the Print Quality area of the **Printer Settings** tab and select **Off (No Color Adjustment)** from the print target list.

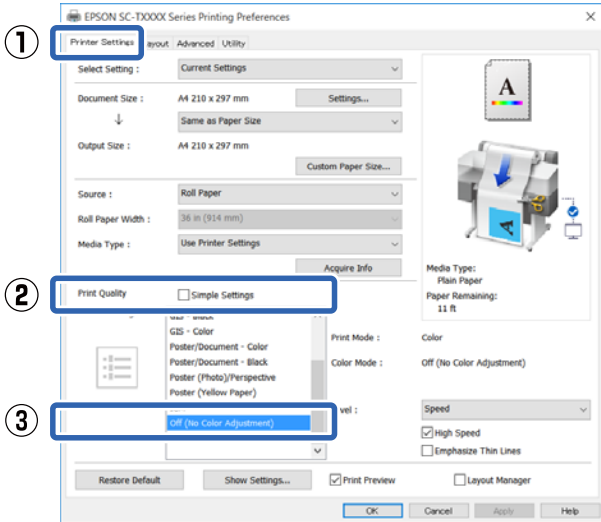

**Note:**

In Windows 7, Windows Vista, and Windows XP (Service Pack 2 or later and .NET 3.0), **Off (No Color Adjustment)** is selected automatically.

### For Mac

Select **Printer Settings** from the list and clear the **Simple Settings** check box in the Print Quality area, and select **Off (No Color Adjustment)** from the print target list.

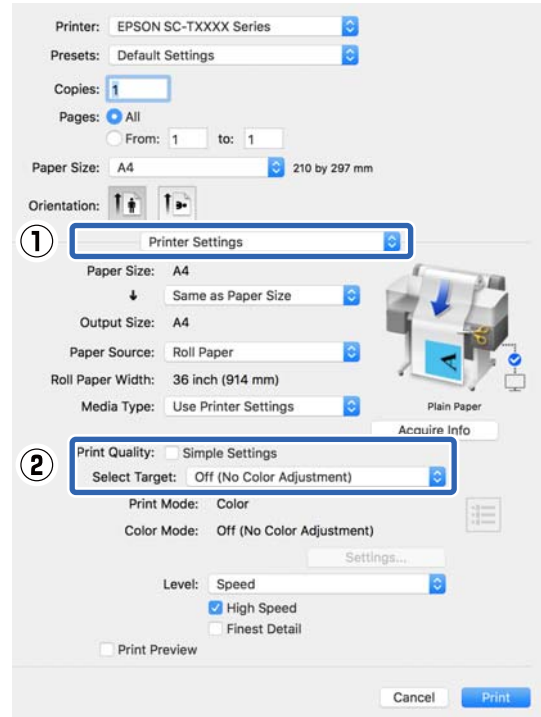

**4** Check other settings, and then start printing.



Printing with the Printer Driver from Your Computer

Setting color management with the printer driver

Color Management Printing by Host ICM (Windows)

Use image data in which an input profile has been embedded. Also, the application must support ICM.

1 Make the settings for color adjustment using the application.

Depending on the type of the application, make the settings following the table below.

Adobe Photoshop CS3 or later  
 Adobe Photoshop Elements 6.0 or later  
 Adobe Photoshop Lightroom 1 or later

OS	Color Management Settings
Windows 8.1, Windows 8, Windows 7, Windows Vista	Printer Manages Colors
Windows XP (Service Pack 2 or later and .NET 3.0 or later)	Printer Manages Colors
Windows XP (other than the above)	No Color Management

In other applications, set **No Color Management**.

**Note:**  
 For information on supported platforms, see the website for the application in question.

Settings example of Adobe Photoshop CC

Open the **Print** dialog box.

Select **Color Management**, then select **Printer Manages Colors** in **Color Handling**, and click **Print**.

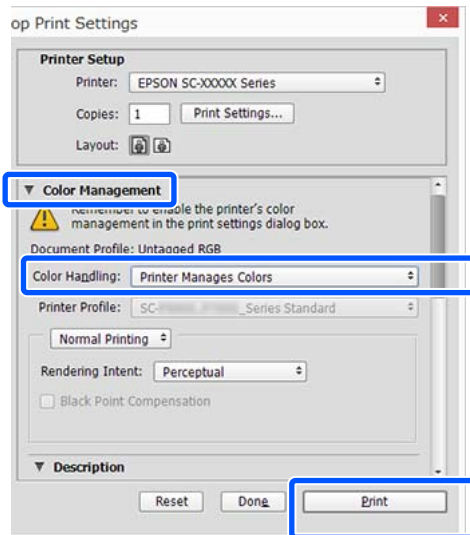

When using an application without a color management function, start from step 2.

2 Clear the **Simple Settings** check box in the **Print Quality** area on the **Printer Settings** tab of the printer driver and then select **ICM** from the **Select Target** list.

[“Basic Operating Procedures \(Windows\)” on page 49](#)

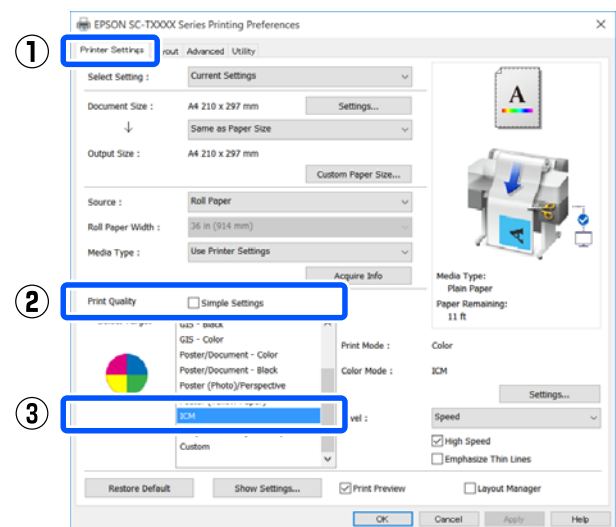

## Printing with the Printer Driver from Your Computer

- 3 Click **Settings**.

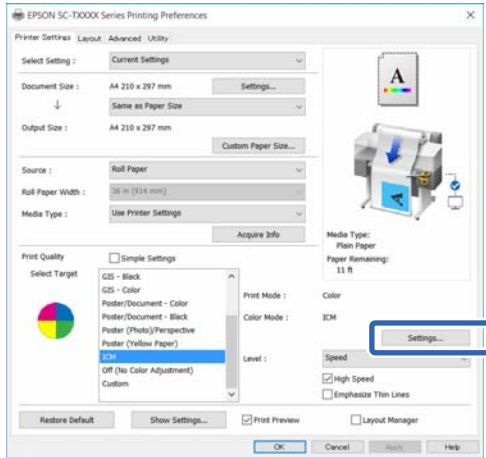

- 4 Select **Host ICM** in **ICM Mode**.  
See the printer driver help for more details.

The printer profile corresponding to the **Media Type\*** selected on the **Printer Settings** tab is set automatically and is displayed in the **Printer Profile Description** area.

To change the profile, select the **Show all profiles** check box.

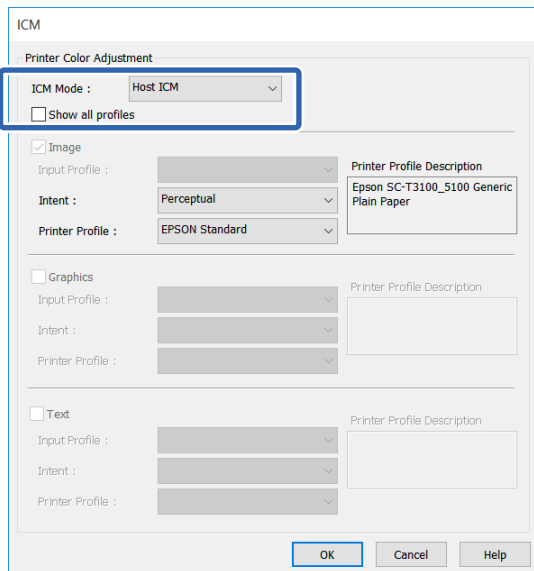

\*: If **Source** is selected on the **Printer Settings** tab, the paper type set on the printer is set automatically. **Media Type** becomes **Use Printer Settings**, and the paper type name is displayed on the right side.

- 5 Check other settings, and then start printing.

## Color Management Printing by ColorSync (Mac)

Use image data in which an input profile has been embedded. Also, the application must support ColorSync.

**Note:**  
Depending on the application, color management printing by **ColorSync** may not be supported.

- 1 Disable the color management functions in the application.
- 2 Display the Print screen.  
[“Basic Operating Procedures \(Mac\)” on page 55](#)
- 3 Select **Color Matching** from the list, and then click **ColorSync**.

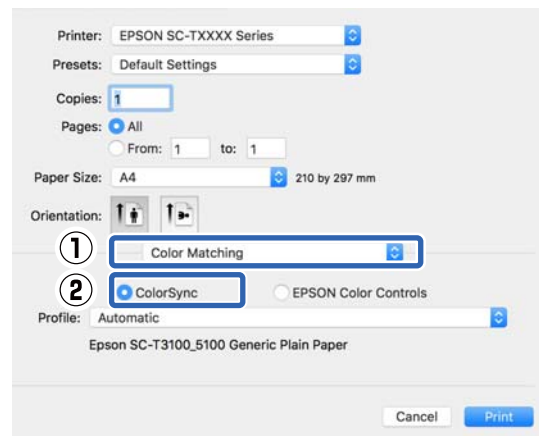

The printer profile corresponding to the currently selected paper type\* is specified automatically and displayed at the bottom of the profile area. To change the profile, select the desired profile from the **Profile** pull-down menu.

\*: It is set in the screen displayed by selecting **Printer Settings** from the list. If **Paper Source** is selected, the paper type set on the printer is set automatically, and **Use Printer Settings** is displayed. The paper type name is displayed on the right side of it.

- 4 Check other settings, and then start printing.

## Printing with the Printer Driver from Your Computer

### Color Management Printing by Driver ICM (Windows Only)

The printer driver uses its own printer profiles to perform color management. You can use the following two color correction methods.

- ❑ Driver ICM (Basic)  
Specify one type of profile and intent for processing the entire image data.
- ❑ Driver ICM (Advanced)  
The printer driver distinguishes the image data into the **Image**, **Graphics**, and **Text** areas. Specify a different profile and intent for each of the three areas.

#### When using applications featuring a color management function

Make the settings for color processing using the application before making printer driver settings.

Depending on the type of the application, make the settings following the table below.

Adobe Photoshop CS3 or later  
 Adobe Photoshop Elements 6.0 or later  
 Adobe Photoshop Lightroom 1 or later

OS	Color Management Settings
Windows 8.1, Windows 8, Windows 7, Windows Vista	Printer Manages Colors
Windows XP (Service Pack 2 or later and .NET 3.0 or later)	
Windows XP (other than the above)	No Color Management

In other applications, set **No Color Management**.

**Note:**  
 For information on supported platforms, see the website for the application in question.

Settings example of Adobe Photoshop CC

Open the **Print** dialog box.

Select **Color Management**, then select **Printer Manages Colors** in **Color Handling**, and click **Print**.

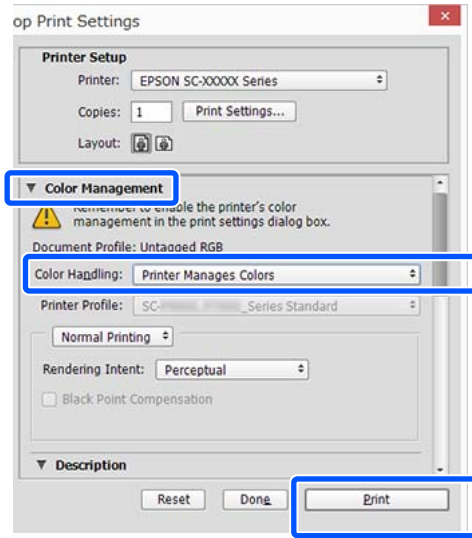

- 1 Clear the **Simple Settings** check box in the Print Quality area on the **Printer Settings** tab of the printer driver and then select ICM from the Select Target list.

[“Basic Operating Procedures \(Windows\)” on page 49](#)

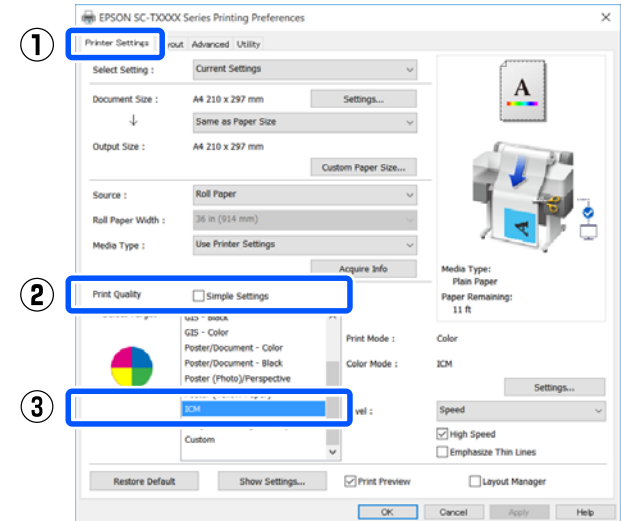

## Printing with the Printer Driver from Your Computer

### 2 Click Settings.

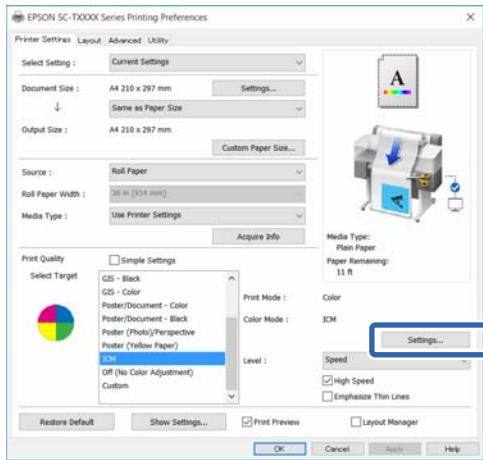

### 3 Select Driver ICM (Basic) or Driver ICM (Advanced) in ICM Mode of the ICM dialog box.

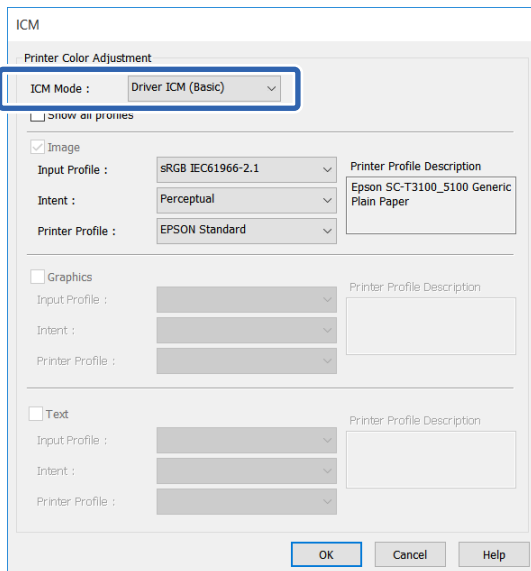

If you select **Driver ICM (Advanced)**, you can specify the profile and intent for each of image data such as photos, graphics data, and text data.

Intent	Explanation
Saturation	Keeps the current saturation unchanged and converts the data.
Perceptual	Converts the data so that a more visually natural image is produced. This feature is used when a wider gamut of color is used for image data.

Intent	Explanation
Relative Colorimetric	Converts the data so that a set of color gamut and white point (or color temperature) coordinates in the original data match their corresponding print coordinates. This feature is used for many types of color matching.
Absolute Colorimetric	Assigns absolute color gamut coordinates to the original and print data and converts the data. Therefore, color tone adjustment is not performed on any white point (or color temperature) for the original or print data. This feature is used for special purposes such as logo color printing.

### 4 Check other settings, and then start printing.

Printing with the Printer Driver from Your Computer

# Multi-Page Printing (N-up)

Two or four consecutive pages can be printed on a single sheet.

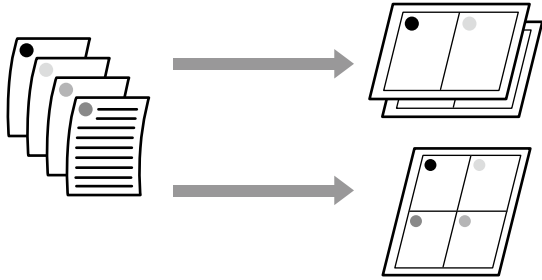

**Note:**

- ❑ In Windows, you cannot use the multi-page printing function when performing borderless printing.
- ❑ In Windows, you can use the Reduce/Enlarge function (Fit to Page) to print the data on different sizes of paper.

[“Printing at Non-Standard Sizes” on page 66](#)

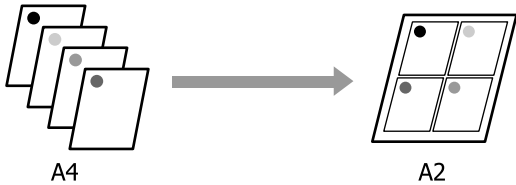

## Settings in Windows

- 1 Display the Layout tab of the printer driver and select the **Page Layout** check box. Then, select **N-up** and click the **Settings** button.

[“Basic Operating Procedures \(Windows\)” on page 49](#)

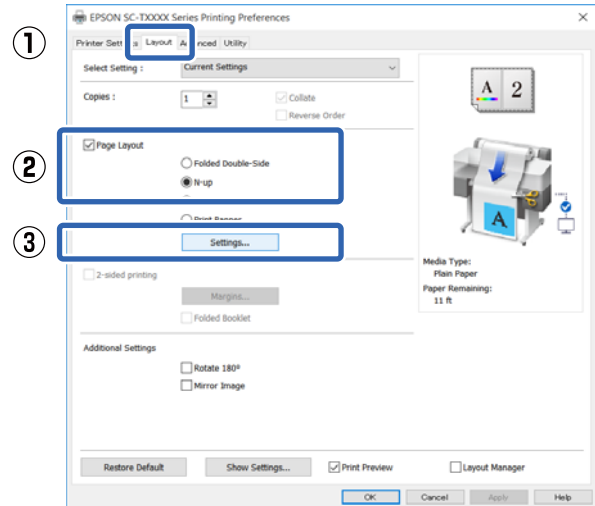

- 2 Set **Number of pages per sheet** and **Page Order** in the Print Layout dialog box.

If the **Print page frames** check box is selected, page frames are printed on each page.

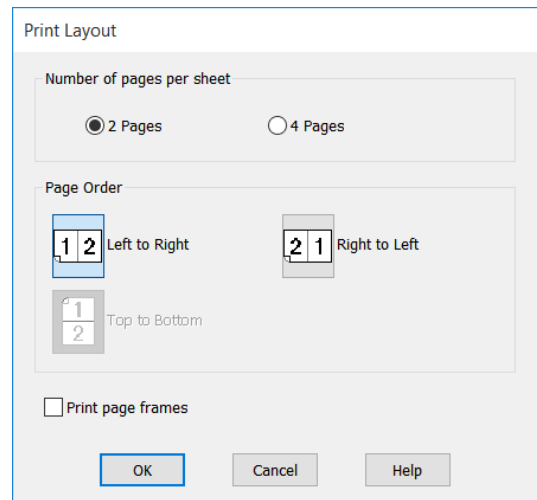

- 3 Check other settings, and then start printing.

## Printing with the Printer Driver from Your Computer

### Settings in Mac

- 1 Display the Print dialog box, select **Layout** from the list, and specify the number of pages per sheet and so on.

 [“Basic Operating Procedures \(Mac\)” on page 55](#)

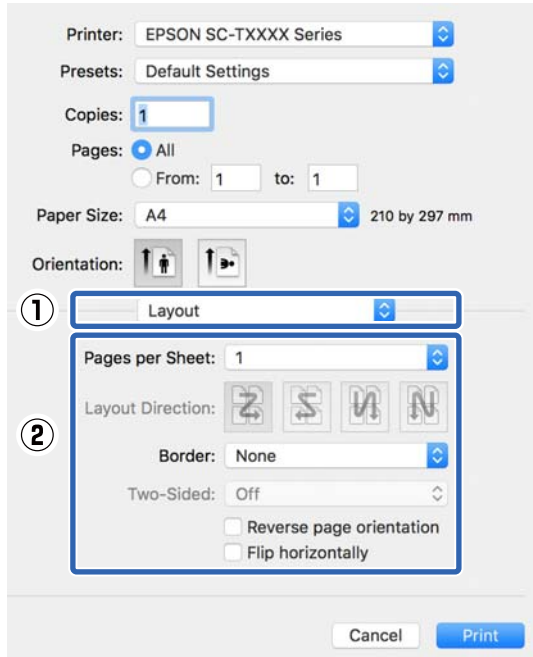

**Note:**

You can print frames around arranged pages using the **Border** function.

- 2 Check other settings, and then start printing.

## Folded 2-Sided Printing (Windows only)

Two consecutive pages can be printed on a single sheet. The second page is flipped 180° and printed adjacent to the first page, allowing the paper to be folded to make a 2-sided document.

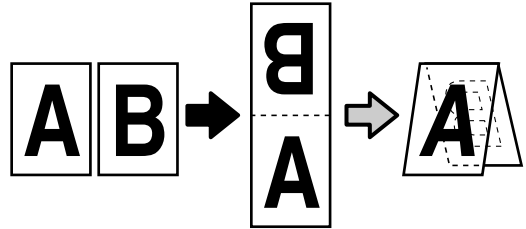

- 1 Display the Layout tab of the printer driver and select the **Page Layout** check box. Then, select **Folded Double-Side** and click the **Settings...** button.

 [“Basic Operating Procedures \(Windows\)” on page 49](#)

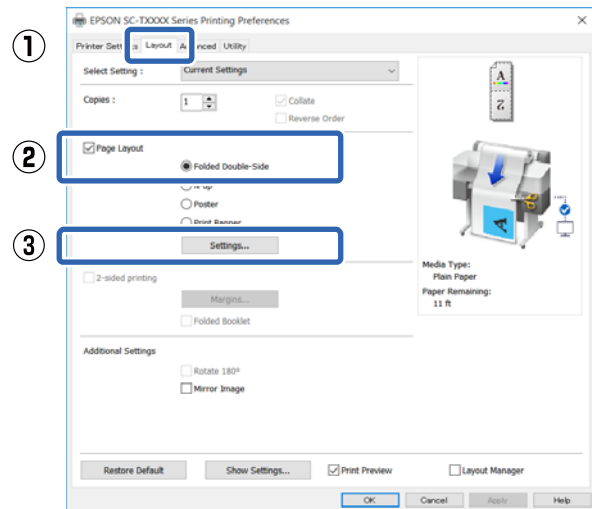

**Printing with the Printer Driver from Your Computer**

- 2 Set **Binding Edge** and **Binding Margin** in the **Folded Double-Side Setting** dialog box.

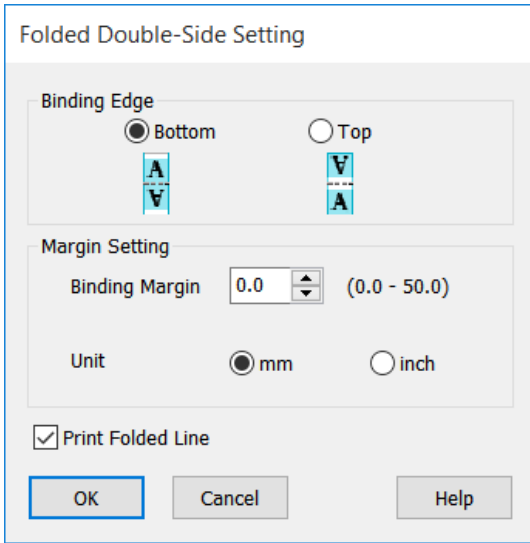

- 3 Check other settings, and then start printing.

## Poster Printing (Windows Only)

A single page can be printed across multiple sheets. The sheets can then be joined together to form large posters (up to 16 times the original size). If **Borderless Poster Print** is selected, the sheets can be joined without trimming the margins, but because the portions outside the edges of the paper will be lost using borderless printing, images at the joins may be imperfect.

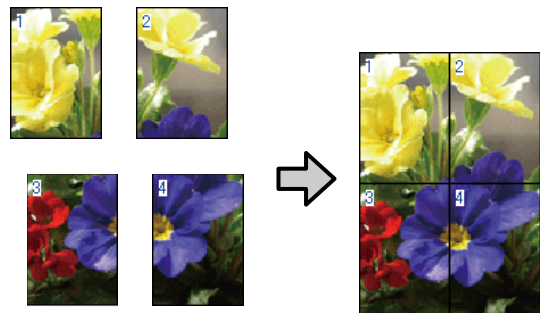

- 1 Display the **Layout** tab of the printer driver and select the **Page Layout** check box. Then, select **Poster** and click the **Settings...** button.

[“Basic Operating Procedures \(Windows\)” on page 49](#)

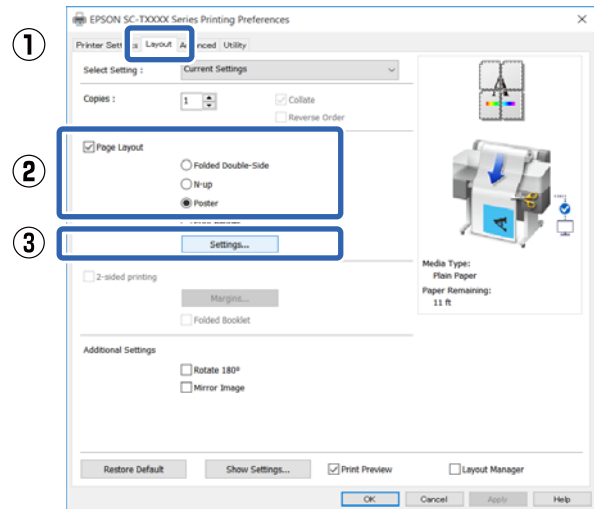

## Printing with the Printer Driver from Your Computer

### 2 Set Number of panels in the Poster dialog box.

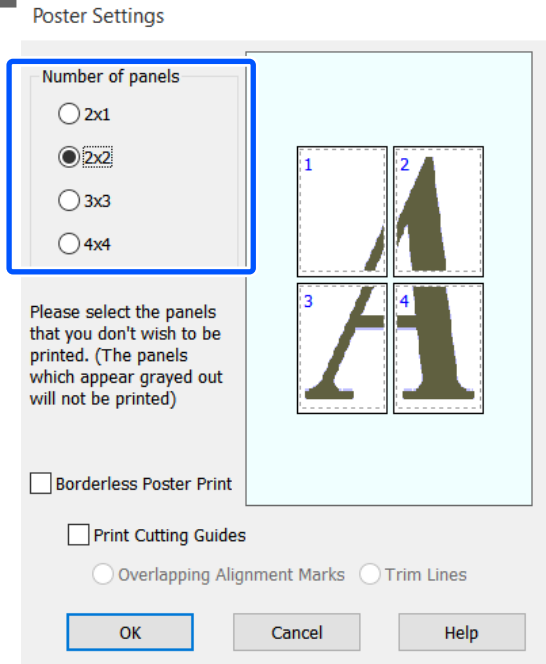

### 3 If you want to print marks to serve as a guide when joining together paper printed with poster printing, select the **Print Cutting Guides** check box.

**When borderless is selected:**

Select **Borderless Poster Print**.

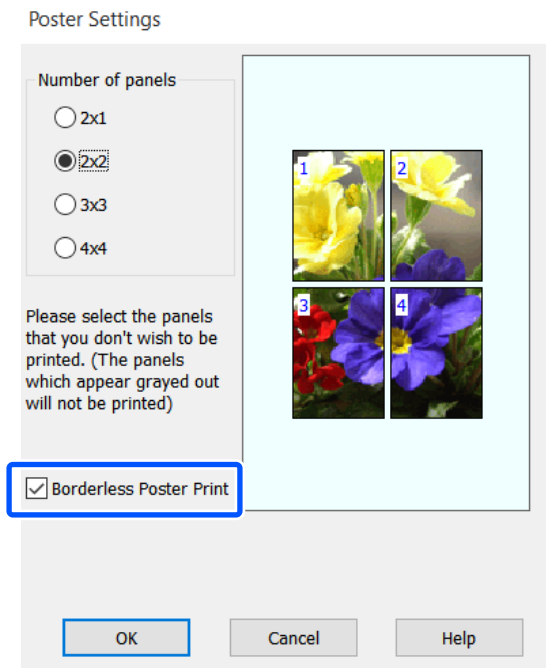

**Note:**

- If **Borderless Poster Print** is grayed out, the selected paper or the size does not support borderless printing.  
[☞ “Epson Special Media Table” on page 216](#)
- If **Single Cut** or **Double Cut** is selected for **Auto Cut**, the paper will be cut 1 or 2 mm inside the image, resulting in imperfect joins where the images meet.

**When with margins is selected:**

Clear the **Borderless Poster Print** check box.

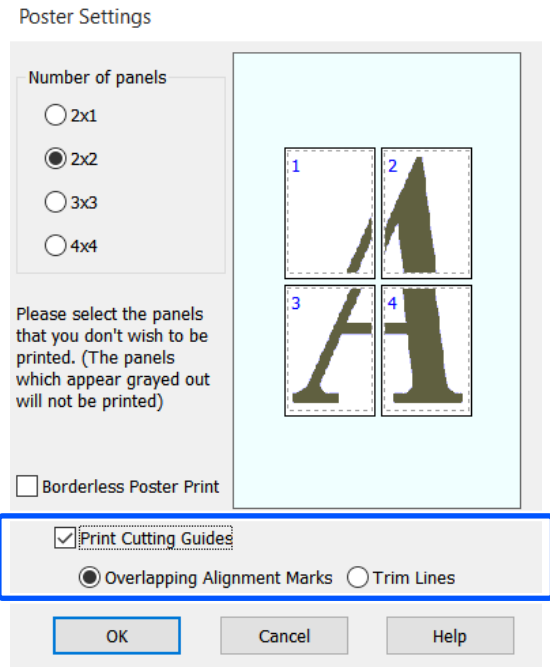

**Note:**

If **Borderless Poster Print** is not selected, a **Print Cutting Guides** option will be displayed.

### Overlapping Alignment Marks

Prints guides for joining the paper with overlapping. The finished size is smaller only for the overlapping portions.

### Print page frames

Prints frames for joining the paper without overlapping.

### 4 Check other settings, and then start printing.



## Printing with the Printer Driver from Your Computer

### Joining poster sheets with printed borders

If **Overlapping Alignment Marks** is selected, join guides (indicated by the lines drawn through and around the X marks in the illustration below) will be printed on each sheet.

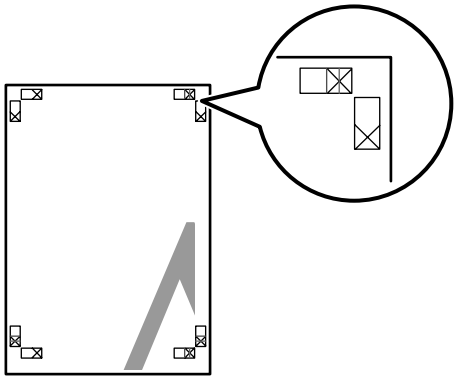

**Note:**

*If the output is in color, the join guides will be in blue and the cut guides in red; otherwise, all the guides will be printed in black.*

The following section describes how to join four printed pages together.

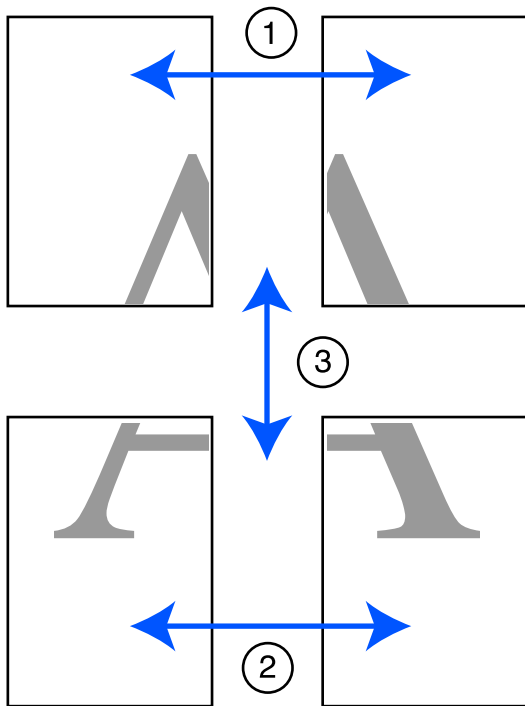

- 1 Ready the two top sheets and trim the excess from the left sheet by cutting along the line joining the two join guides (the centers of the X marks).

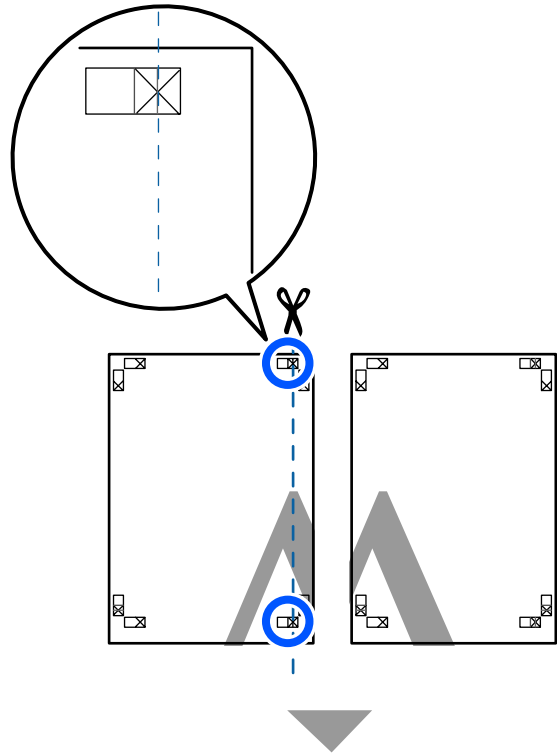

- 2 Lay the upper left sheet on top of upper right sheet. Lineup the X marks as shown in the illustration below, and temporarily fasten them using an adhesive tape on the back.

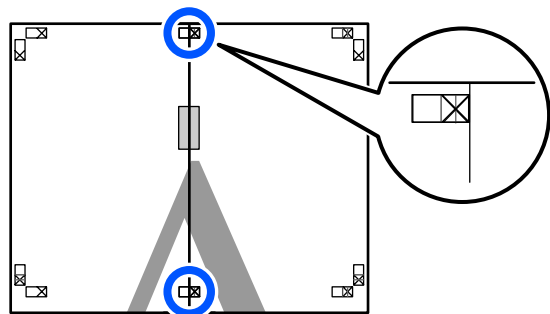

**Printing with the Printer Driver from Your Computer**

- 3** With the two sheets overlapping, trim the excess by cutting along the line joining the two cut guides (the lines to the left of the X marks).

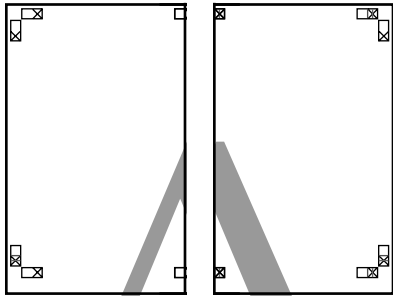
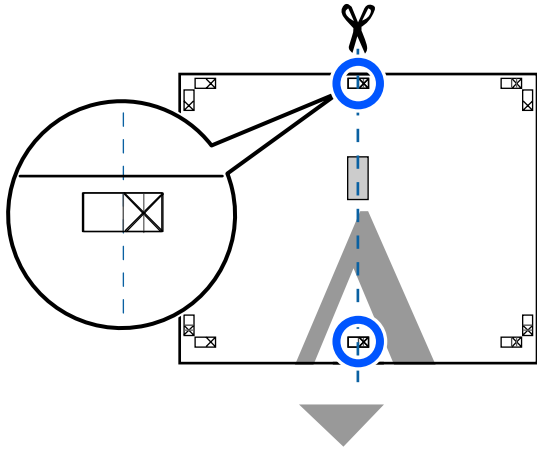

- 4** Rejoin the two sheets.  
Use an adhesive tape to stick the backs of the sheets together.

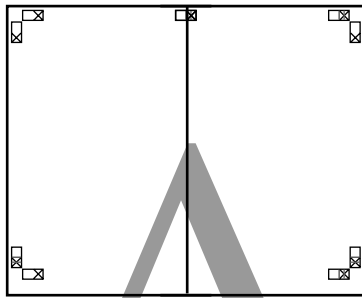

- 5** Repeat steps 1 to 4 for the lower two sheets.

- 6** Trim the bottom from the upper sheets by cutting along the line joining the two guides (the lines above the X marks).

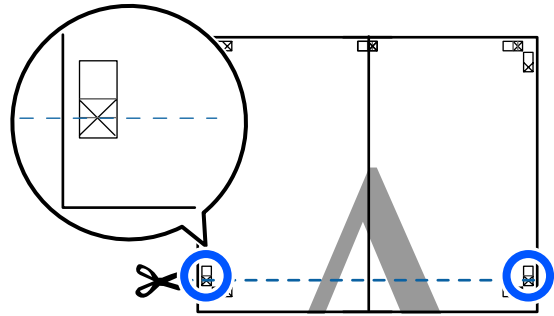

- 7** Lay the upper sheet on top of the lower sheet. Lineup the X marks as shown in the illustration below, and temporarily fasten them using an adhesive tape on the back.

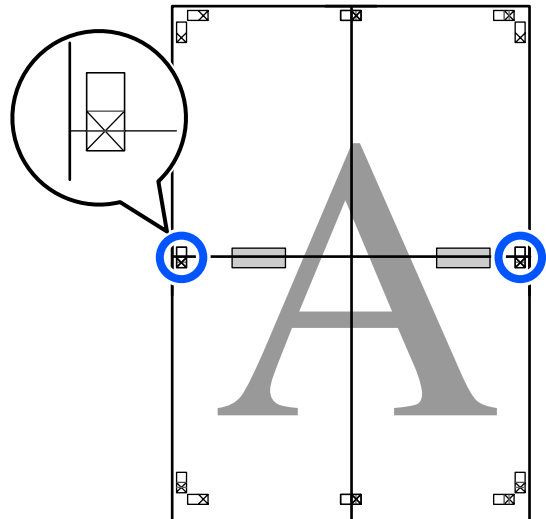

### Printing with the Printer Driver from Your Computer

- 8** With the two sheets overlapping, trim the excess by cutting along the line joining the two cut guides (the lines above the X marks).

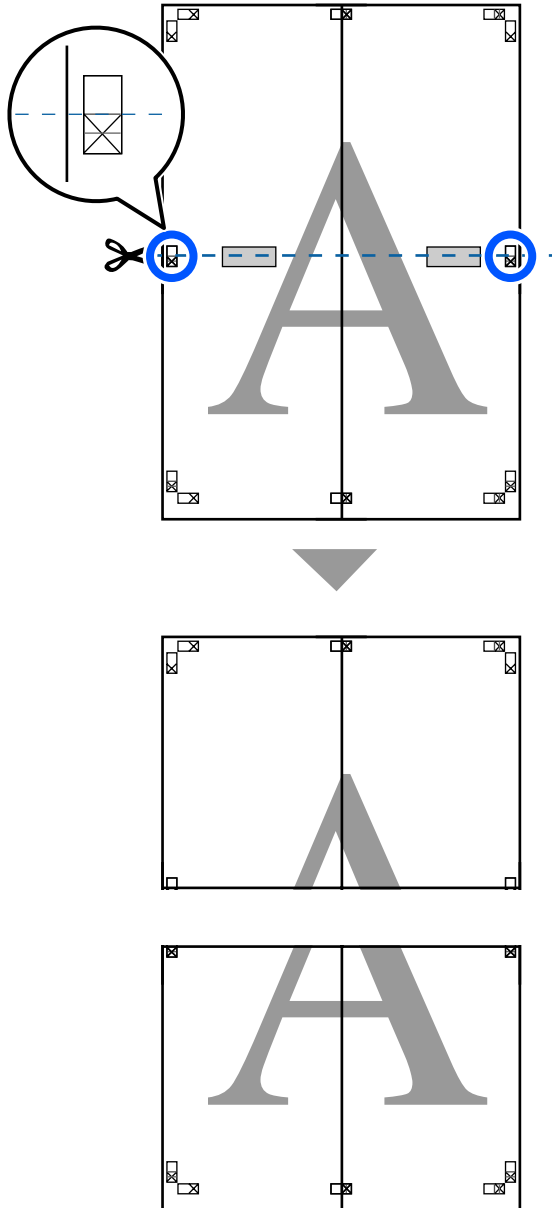

- 9** Join the upper and lower sheets together. Use an adhesive tape to stick the backs of the sheets together.

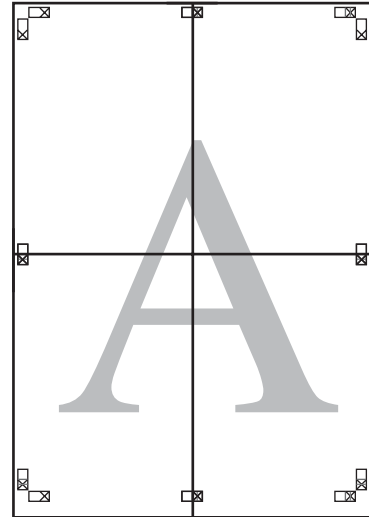

**Printing with the Printer Driver from Your Computer**

**10** After joining all the sheets, trim off the borders by cutting along the cut guides (outside the X marks).

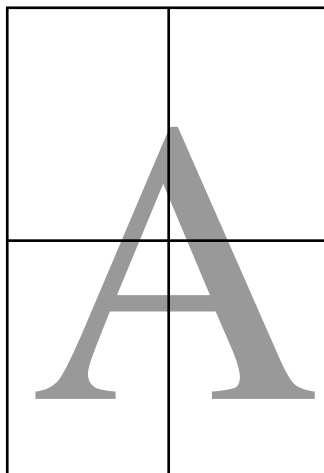
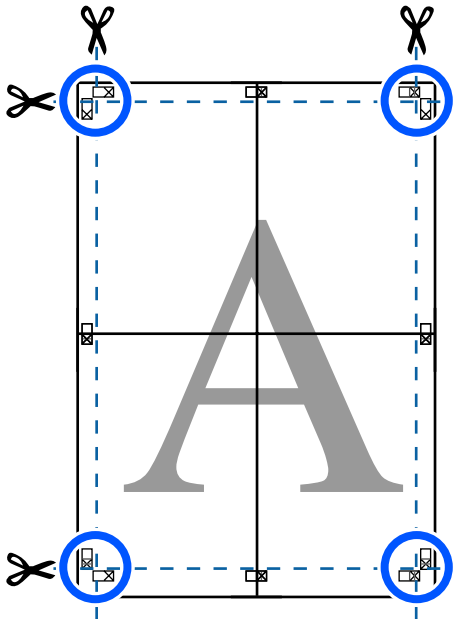

**Printing Multiple Documents (Layout Manager) (Windows Only)**

Documents created in different applications can be printed together in your choice of layout. This allows you to improve print work efficiency and conserve paper.

**Sample Multi-Document Layout**

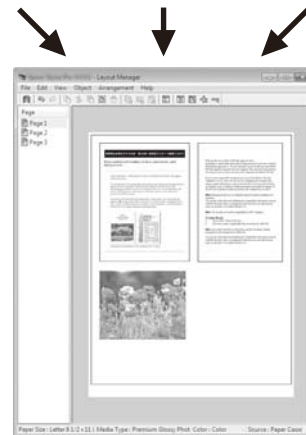
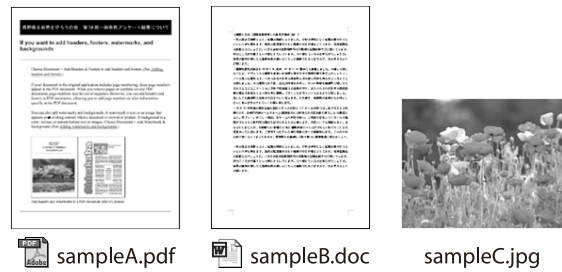

**Sample Free Vertical/Horizontal Layout**

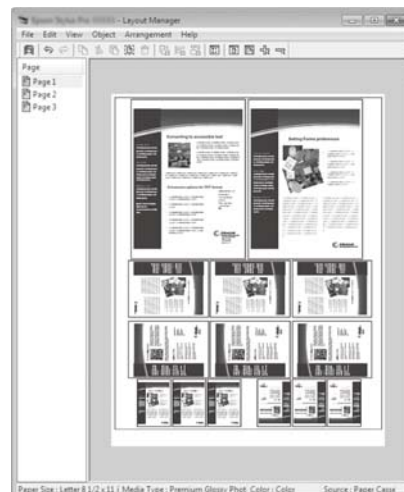

## Printing with the Printer Driver from Your Computer

### Setting Procedures for Printing

- 1 Open the file you want to print in your application.
- 2 Select the **Layout Manager** check box on the Printer Settings tab of the printer driver and check that the size set in the application is displayed in Document Size.

“Basic Operating Procedures (Windows)” on page 49

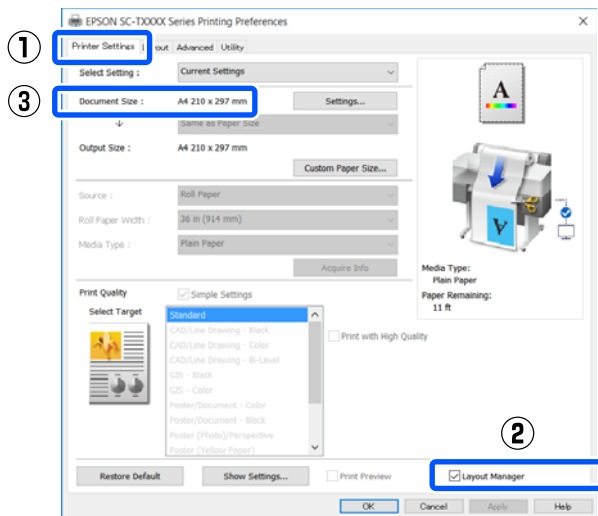

**Note:**

*Document Size is the size of the document to be placed on the Layout Manager screen. The actual printing paper size is set in the screen in Step 6.*

- 3 Click **OK**. When printing from an application, the Layout Manager screen opens.

The print data is not printed, but one page is placed on the paper of the Layout Manager screen as one object.

- 4 Leaving the Layout Manager screen open, repeat steps 1 to 3 until all the print data has been added to the layout.

The objects are added to the Layout Manager screen.

- 5 Arrange the objects on the Layout Manager screen.

Objects can be moved or resized by dragging as well as rearranged or rotated using the tool buttons or the options in the **Object** menu.

The overall size and placement of the objects can be changed using the **Preferences** and **Arrangement** options in the **File** menu.

See the Layout Manager screen help for more details on each function.

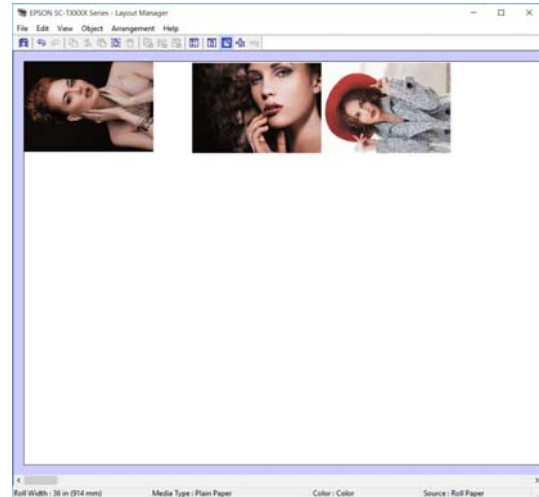

- 6 Click **Properties** in the **File** menu and set the print settings in the printer driver dialog box.

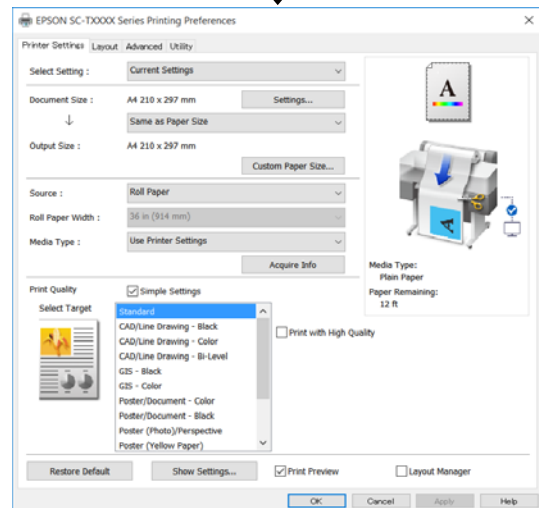

Check **Media Settings**, and set **Print Quality**.

- 7 Click the **File** menu in the Layout Manager screen, and then click **Print**.

Printing starts.

## Printing with the Printer Driver from Your Computer

### Saving and Recalling Settings

The layout and setting information on the Layout Manager screen can be saved as a file. If you need to close your application in the middle of a job, you can save it to a file and then open it later to continue your work.

#### Saving

- 1 Click the **File** menu on the Layout Manager screen, and then click **Save As...**
- 2 Enter the file name, select the location, and then click **Save**.
- 3 Close the Layout Manager screen.

#### Opening saved files

- 1 Right-click the printer icon (  ) on the Windows taskbar, and then click **Layout Manager** in the displayed menu.

The Layout Manager screen appears.

**Note:**

**When the printer icon is not displayed on the Windows taskbar**

Open the **Utility** tab of the printer driver and click the **Monitoring Preferences**. Select the **Register the shortcut icon to the taskbar** check box in the **Monitoring Preferences** dialog box.

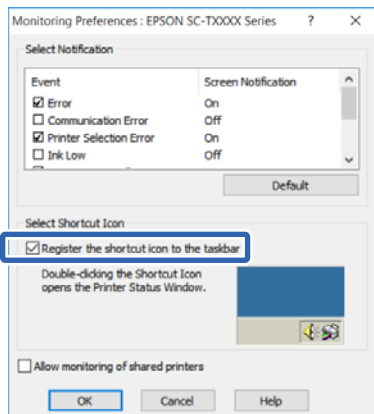

- 2 Click **Open** in the **File** menu on the Layout Manager screen.
- 3 Select the location and open the required file.

## Printing Using the HP-GL/2 or HP RTL Mode from a Computer

# Printing Using the HP-GL/2 or HP RTL Mode from a Computer

The printer can emulate\* HP-GL/2 (compatible with HP Designjet 750C) and HP RTL. This section describes the settings of the printer and the settings in the CAD application for printing while emulating.

\* Not all functions are supported. If you will use an untested application, test its output in advance.

For a list of applications that have been tested, visit the Epson website at <http://www.epson.com>.

### Important:

*The printer may not perform as expected if the size of the data to be printed is extremely large.*

### Note:

*CAD drawings can also be printed using the CAD/ line drawing mode of the supplied printer driver. We recommend printing from the printer driver when you want to print with better image quality.*

 ["Printing CAD Drawings" on page 59](#)

## Printer Settings

Change the printer settings for printing in the HP-GL/2 or HP RTL mode as necessary in the control panel of the printer. The printer settings include basic print settings such as the paper source and margins (Universal Print Settings) and HP-GL/2 specific settings such as palette settings (HP-GL/2 Unique Settings).

## Basic Print Settings

**1** Touch **Settings - General Settings - Printer Settings - Universal Print Settings** from the Home screen.

**2** Check **Paper Source** and change the setting if necessary.

The default setting is Roll Paper. When HP-GL/2 or HP RTL print data is sent, an error occurs if paper is not loaded for the paper source set here.

**3** Check the other items and make changes if necessary.

See the following for more details on Universal Print Settings items.

 ["General Settings - Printer Settings" on page 142](#)

## HP-GL/2 Specific Print Settings

If you want to change HP-GL2 specific settings such as rotating print data, merging lines, and changing the Define Palette set in the application, use the following procedure.

**1** Touch **Settings - General Settings - Printer Settings - HP-GL/2 Unique Settings** from the Home screen.

**2** Touch and change the settings of the desired items.

See the following for more details on HP-GL/2 Unique Settings items.

 ["General Settings - Printer Settings" on page 142](#)

## Printing Using the HP-GL/2 or HP RTL Mode from a Computer

**Note:**

**When HP-GL/2 or HP RTL printing is not performed properly**

The printer automatically determines whether normal printing from the printer driver or emulation printing of HP-GL/2 or HP RTL from the sent print data and then switches the print mode accordingly. If mode switching is not performed correctly and printing is not performed properly, configure the setting as follows.

- ❑ When the computer and printer are connected via USB  
 Select **Settings - General Settings - Printer Settings - Printing Language - USB** from the Home screen and then change the setting from **Auto** to **HP-GL/2**.
- ❑ When the computer and printer are connected via a network  
 Select **Settings - General Settings - Printer Settings - Printing Language - Network** from the Home screen and then change the setting from **Auto** to **HP-GL/2**.

To print from the printer driver as usual after HP-GL/2 or HP RTL finishes, return the setting to **Auto**.

- ❑ SC-T3400 Series/SC-T3400N Series:  
 HP Designjet 750C C3195A

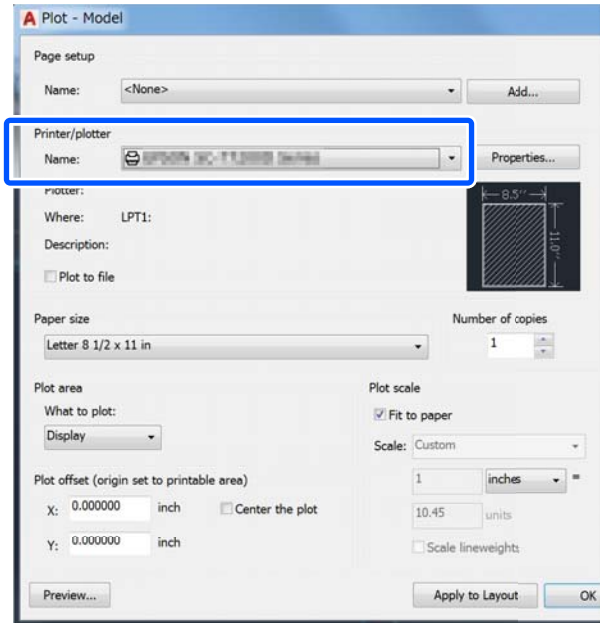

## CAD Application Settings

Set the output device as follows according to your model. This explanation uses AutoCAD 2018 as an example.

- 1 Click **Plot**.

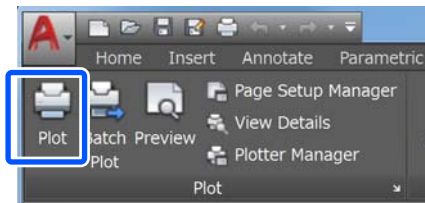

- 2 Set the plotter in **Printer/plotter**.

- ❑ SC-T5400 Series/SC-T5400M Series:  
 HP Designjet 750C C3196A



## Printing without Using the Printer Driver

# Printing without Using the Printer Driver

This section explains how you can print, even if the printer driver is not installed on your computer, if you are connected to a network; it also explains how to connect a USB flash memory to the printer and print the files on the USB flash memory.

## Using AirPrint

AirPrint enables instant wireless printing from iPhone, iPad, and iPod touch with the latest version of iOS, and Mac with the latest version of OS X.

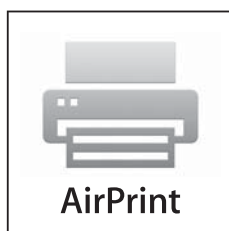

- 1 Load paper in your product.
- 2 Set up your product for wireless printing. See the link below.  
<http://epson.sn>
- 3 Connect your Apple device to the same wireless network that your product is using.
- 4 Print from your device to your product.

**Note:**  
For details, see the AirPrint page on the Apple website.

# Direct Printing via the Web (Upload and Print) (SC-T5400M Series Only)

## Function Summary

Upload and Print is a function that prints by running Web Config from a computer on which the printer driver is not installed.

“How to Use Web Config” on page 26

You can print by simply selecting the file you want to print, and then uploading it to the printer. If the browser you are using supports drag and drop, you can upload multiple files in a batch and print them in order.

The following are files that can print from an upload.

- JPEG
- HP-GL/2
- TIFF (data created on the printer only)
- PDF (data created on the printer only)

## Upload and Print Procedure

- 1 Load the paper into the printer.  
 “Loading Roll Paper” on page 33  
 “Loading Cut Sheet (1 sheet)” on page 40
- 2 Start Web Config.  
 “How to Start” on page 26
- 3 The **Print** tab appears. Click **Upload and Print**.

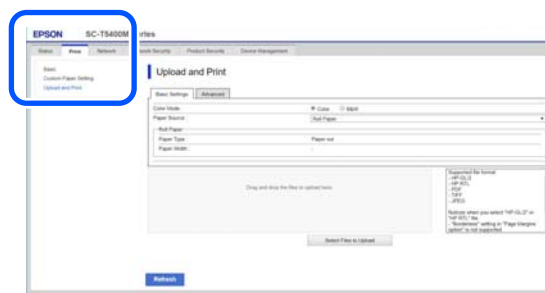

## Printing without Using the Printer Driver

**Note:**  
If the **Print** tab does not appear, contact your system administrator.

- Do the settings for printing.  
Select Color Mode and Paper Source in **Basic Settings**.

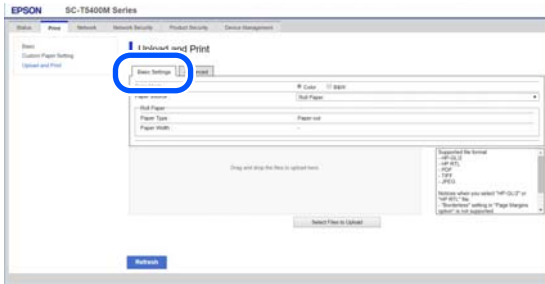

Do the settings, such as Quality, from **Advanced**.

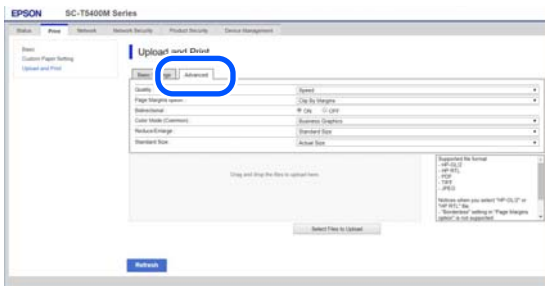

- Start printing by dragging and dropping the data.

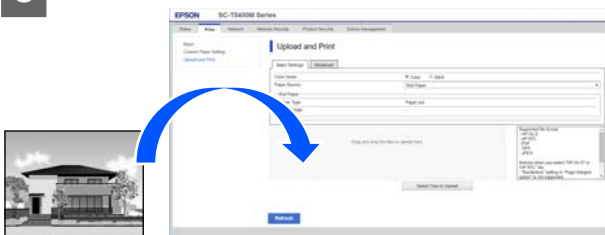

## Printing Files from a Shared Folder (Print from Folder) (SC-T5400M Series Only)

### Function Summary

You can select and print a file from a shared folder on the network that has been setup in advance.

Do the settings for the shared folder on the printer's screen or on Web Config.

☞ [“Preparing a Shared Folder” on page 98](#)

The following files can be printed from a network folder/FTP.

- JPEG
- HP-GL/2
- TIFF (data created on the printer only)
- PDF (data created on the printer only)

## Preparing a Shared Folder

### Setup from the printer

- Touch **Settings** on the Home screen.
- Touch, in order, **General Settings - Network Settings - Advanced - Shared Folder**.  
The shared folder settings screen appears.

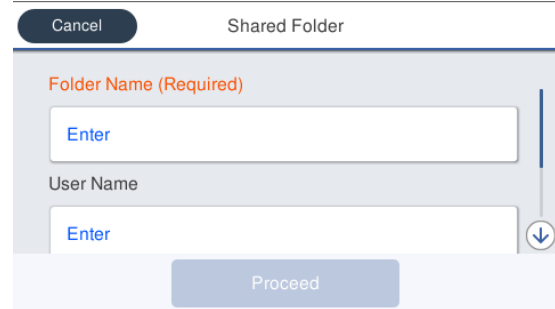

- Enter each item.
  - Folder Name: Within 255 characters, enter the network path for the shared folder.
  - User Name: Enter the user name that you use to log into the computer.
  - Password: Enter the password that you use to log into the computer.
- Touch **Proceed** to complete the settings for the shared folder.

## Printing without Using the Printer Driver

### Setup from Web Config

- 1 Start Web Config.  
[☞ “How to Start” on page 26](#)
- 2 The **Print** tab appears. Click **Basic**.

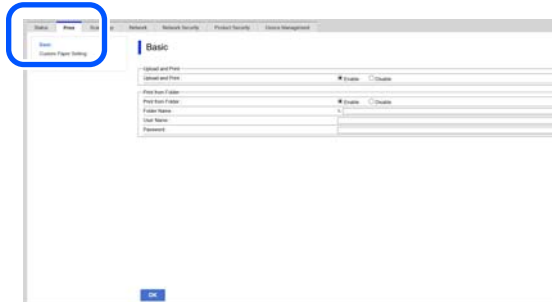

**Note:**  
 If the **Print** tab does not appear, contact your system administrator.

- 3 Enter each item for **Print from Folder**.
  - Print from Folder: Select enable.
  - Folder Name: Enter the network path for the shared folder.
  - User Name: Enter the user name that you use to log into the computer.
  - Password: Enter the password that you use to log into the computer.

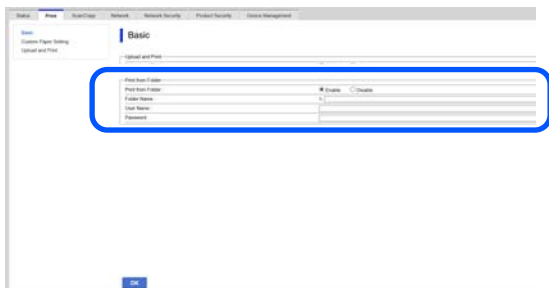

- 4 Click **OK** to complete the settings for the shared folder.

### Print from Folder Procedure

The procedure to print from a folder from the printer's screen is as follows.

- 1 On the Home screen, touch **Network Folder**.  
 After a short while, a list of the files in the shared folder appears.

- 2 Select 1 file to print.

- 3 Select **Black/White** or **Color**.  
**Using advanced settings such as enlarging or reducing size**

Proceed to step 4.

**Printing at actual size without advanced settings**

Proceed to step 5.

- 4 Touch the **Advanced** tab.  
 You can do the settings for reducing and enlarging in **Reduce/Enlarge**. Set **Auto Fit Page** to **On** to print after the file is automatically enlarged to fit either the width of the roll paper, or the size of the cut sheets, that is/are loaded in the printer.

See the following for more details on other settings items.

[☞ “Network Folder menu \(SC-T5400M Series Only\)” on page 179](#)

- Note:**
- If **HP-GL/2** files are selected in **Page Margins** option - **Borderless**, either **Clip By Margins** or **Oversize in Settings - General Settings - Printer Settings - Universal Print Settings - Page Margins** option is applied.
  - You can select **Reduce/Enlarge** in **HP-GL/2** files, but it is not applied.

- 5 Touch the **Print** button.

## Direct Printing of Files on USB Flash Memory

You can connect your USB flash memory to the printer, and print JPEG and TIFF files stored on the memory directly from the printer.

## Printing without Using the Printer Driver

USB flash memories formatted in FAT and exFAT file systems can be used. However, you cannot use USB flash memories with security functions such as password protected ones.

- 1 Connect the USB flash memory, in which the data to be printed is saved, to the printer.

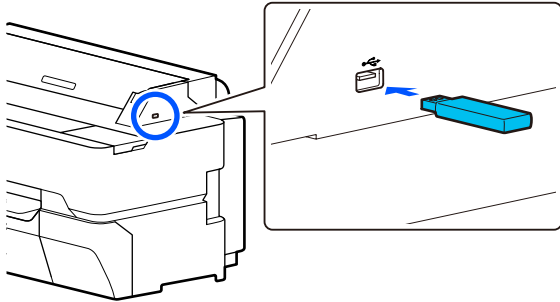

- 2 Touch **Memory Device** on the Home screen.
- 3 Touch **JPEG** or **TIFF**.  
Touch **JPEG** to display thumbnails of JPEG files.  
Touch **TIFF** to display a list of TIFF files.
- 4 Select one file to print.

### Printing JPEG files

Touch to select the file image to print, then touch **Proceed to Print**. This will add a check mark to the selected image. Touch **Single View** to enlarge the selected image to confirm. To change the display order of files, touch .

### Printing TIFF files

From the list, touch a file name to select it. To change the display order of files, touch .

#### Note:

- Files other than JPEG or TIFF files are not displayed on the printer screen.
- Any characters in the folder or file names that cannot be displayed by the printer will be displayed as "?".

- 5 Select **Black/White** or **Color**.  
**Using advanced settings such as enlarging or reducing size**

Proceed to step 6.

### Printing at actual size without advanced settings

Proceed to step 7.

- 6 Touch the **Advanced** tab.  
Enlarge/reduce settings can be configured in Reduce/Enlarge. If you set **Auto Fit Page** to **On**, printing is performed by automatically enlarging to fit the width of the roll paper or the size of the cut sheet paper loaded in the printer.

See the following for more details on other settings items.

 [“Memory Device menu” on page 164](#)

#### Note:

If you touch ☆ (Presets), you can assign a name to frequently used print settings and then register them to Presets.

The screen for entering a name can be switched as shown below with the button marked.

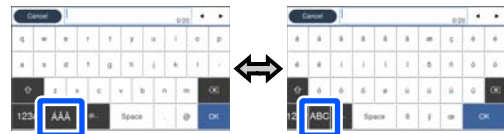

Also, each touch of the following bottom left icon switches the input method as follows.

ABC: Enters alphabet letters.

123#: Enters numbers and symbols.

- 7 Touch the numeric value for the number of prints and then enter the number of prints in the keypad screen.

#### Note:

Use the **Preview** button to confirm the print image.

- 8 Touch the **Print** button.

**Copy (SC-T5400M Series Only)**

---

# Copy (SC-T5400M Series Only)

---

## Placing Documents in the Scanner

You can load one document.

The document sizes and paper types that can be loaded and the documents that cannot be loaded are as follows.

**Important:**

If a document covered in dust is loaded, the dust may adhere inside the scanner and decrease the quality of copied or scanned images. Before loading a document into the scanner, remove any dust from the document.

---

## Loadable Document Sizes

Width of document: 148 mm to 914 mm (36 inches)

Length of document: 148 mm to 30480 mm (120 inches)\*

Thickness of original: 0.8 mm or less (or 0.55 mm or less with the optional carrier sheet)

\* Depending on the settings and the data format, the maximum length may be different.

---

## Loadable Paper Types

- Plain paper
- Recycled paper
- Coated paper
- Glossy paper
- Tracing paper

- Film
- Blueprint
- Actual printing stock
- Newspaper
- Flyer
- Drafting paper
- Japanese calligraphy paper

**Important:**

If tracing paper is loaded, the printer cannot automatically detect the width. On the control panel, set **Original Size** or **Scan Size**.

 [“Copy menu \(SC-T5400M Series Only\)” on page 167](#)

 [“Scan menu \(SC-T5400M Series Only\)” on page 171](#)

---

## Documents That Cannot Be Loaded

Do not load originals such as the following. Failure to observe this precaution could cause paper jams or damage the printer.

- Originals that are bound
- Originals that are bent
- Originals with carbon backing
- Originals that are attached with staples, paper clips, or glue
- Originals that have many holes, such as loose leaf paper
- Originals that are shaped irregularly or not cut at right angles
- Originals with photos, stickers, or labels attached
- Originals that are transparent
- Originals that are glossy

**Copy (SC-T5400M Series Only)**

- Originals that have become deteriorated
- Originals that are torn

**When loading documents that are thin, that are easily torn, or that you do not want to damage**

Use the optional carrier sheet for thin documents and documents that you do not want to damage.

 [“Options and Consumable Products” on page 214](#)

**Documents That Need the Carrier Sheet**

- Valuable documents that you do not want to damage (documents on loan, master copies, old drawings, antique maps, works of art, etc.)
- Documents with fragile surfaces and/or materials (collages, newspapers, rice paper, oil pastel drawings, etc.)
- Transparent and translucent film

**Notes for When Putting Documents into the Carrier Sheet**

Insert the document in the carrier sheet as shown.

- Insert the document with the side to be scanned facing the transparent sheet.
- Align the top edge of the document with part **A** of the carrier sheet.

- Align the side of the document with line **B**.

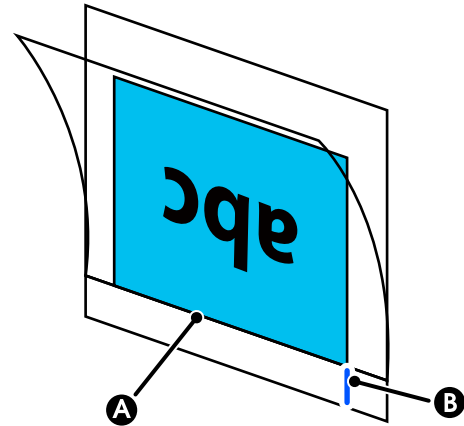

**! Important:**

*If the carrier sheet is loaded, the printer cannot automatically detect the width. On the control panel, set the **Original Size** or the **Scan Size** and **Top Offset**.*

 [“Copy menu \(SC-T5400M Series Only\)” on page 167](#)

 [“Scan menu \(SC-T5400M Series Only\)” on page 171](#)

**How to Load Documents**

**! Important:**

- If the original tends to curl, load the original after straightening the curl.*
- Smooth the creases in the original, and then load it.*

- 1** Align the document guide on the right side with the document loading position.

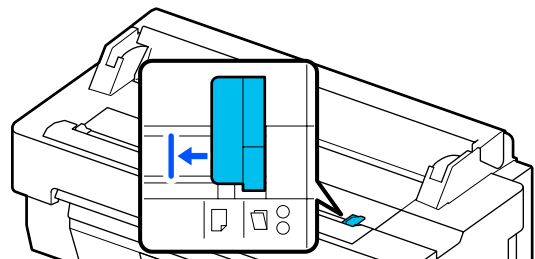

### Copy (SC-T5400M Series Only)

If you are using the carrier sheet to scan, align the document guide with the position indicated in the illustration.

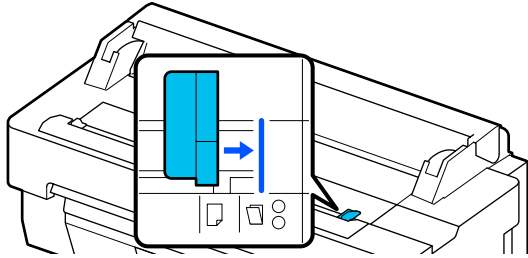

- 2 Face the scanning side upward and align the right edge of the document with the document guide. Insert the leading edge of the document into the scanner's paper slot until you hear a beep.

Load the document in the direction indicated by the illustration.

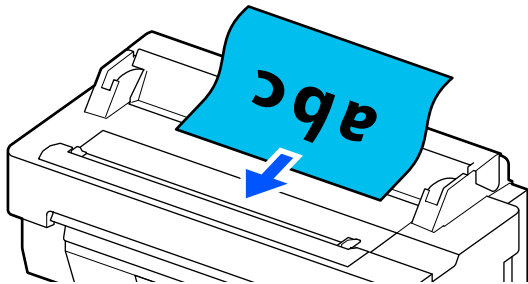

- 3 Align the document guide on the left side with the edge of the document.

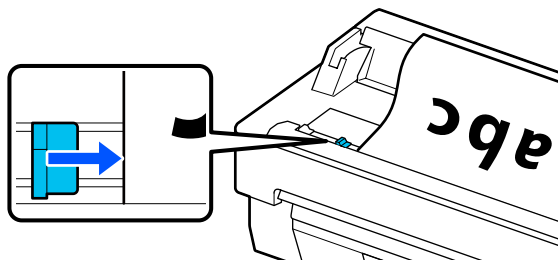

- 4 Check that the paper basket is open.

## Procedure for Copying

- 1 Load the paper into the printer.  
[“Loading and Setting the Paper” on page 32](#)

- 2 Load the document into the printer.  
[“How to Load Documents” on page 102](#)

- 3 Touch **Copy** on the Home screen.

- 4 In **Basic Settings**, do the settings for Color, Quality, Density, and Reduce/Enlarge.  
[“Copy menu \(SC-T5400M Series Only\)” on page 167](#)

If you are doing detailed settings, such as Original Type, do the settings from **Advanced**.

- [“Copy menu \(SC-T5400M Series Only\)” on page 167](#)

If you are using the optional carrier sheet, you must do the following settings in **Advanced**.

- Specify the **Original Size** from a standard size.
- Set **Top Offset** to 19 mm.

- 5 Touch the numeric value for the number of prints and then enter the number of prints in the keypad screen.

- 6 Press the **Copy** button to start scanning the document.

- 7 Remove the original when scanning is complete.  
 While holding the original, press the **OK** button on the screen, and then remove the original.

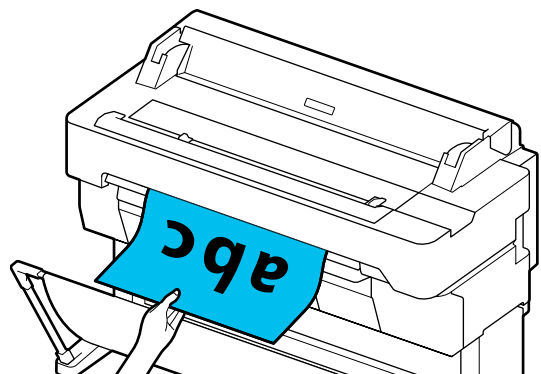

Printing starts when the original has been completely removed.

## Scanning (SC-T5400M Series Only)

# Scanning (SC-T5400M Series Only)

## Function Summary

The following are 3 ways that you can save or send the data of scanned images.

**Network Folder/FTP:** Save the scanned image in a folder via the network. For the recipient, you can specify a shared folder (a folder that uses SMB protocol) that was created on a computer or a folder on the FTP server. You must do the settings for the shared folder or FTP server in advance.

**Email:** Attach the scanned image directly into an email to be able to send it from the printer. You must register an email server and do its settings in advance.

**Memory Device:** You can save the scanned image to a USB flash memory that is installed in the printer. You do not have to do any settings in advance.

## Preparing to Scan

The following settings must be done in advance to save a scanned image to a folder or send a scanned image via email.

- Shared folder settings and FTP server settings**  
Do the settings in Web Config. See the *Administrator's Guide* for more details.
- Mail server settings**  
Do the settings in Web Config. See the *Administrator's Guide* for more details.

- Settings for the recipient email addresses and the contacts for the shared folder**  
Do the settings from the printer's screen or from Web Config. This section explains the contacts settings in the shared folder from the printer's screen.  
See the *Administrator's Guide* for how to do settings in Web Config.

### Creating Contacts

- 1** Touch **Settings** on the Home screen.
- 2** Touch, in order, **Contacts Manager - Register/Delete**.
- 3** Touch, in order, **Add Entry - Add Contact - Network Folder/FTP**.

The Add Entry screen appears.

- 4** Check the details for each item and input any necessary information.
  - Registry Number:** Set a registry number for the address.
  - Name:** Name that appears in your contacts (up to 30 characters).
  - Index Word:** Use to search your contacts (up to 30 characters).
  - Communication Mode:** Select SMB.
  - Location:** Enter a shared folder's network path (within 255 characters). When you enter letters, numbers, and symbols, specify single-byte and double-byte characters correctly. If the setting for single-byte and double-byte characters is incorrect, you will not be able to save to the shared folder.
  - User Name:** Enter the user name that you use to log into the computer.
  - Password:** Enter the password that you use to log into the computer.



### Scanning (SC-T5400M Series Only)

- ❑ Assign to Frequent Use: Register an address for frequent use. When an address is specified, it will appear on the top screen.

**Note:**

*If you do not have a password set on your computer, you do not have to enter a user name or password.*

- 5 Touch **OK** to finish registering a shared folder to your contacts.

## Procedure for Scanning

These settings must be done in advance to save a scanned image to a folder or send a scanned image via email.

[🔗 “Preparing to Scan” on page 104](#)

### Scanning and Saving an Image to a Shared Folder or FTP Server

**Note:**

*First, check that the printer's **Date/Time** and **Time Difference** are set correctly. From the control panel, select, in order, **Settings - General Settings - Basic Settings - Date/Time Settings**.*

- 1 Load the original.
  - [🔗 “Placing Documents in the Scanner” on page 101](#)
  - [🔗 “How to Load Documents” on page 102](#)
- 2 Touch **Scan** on the Home screen.
- 3 Touch **Network Folder/FTP**.  
A screen from which you specify a location appears.

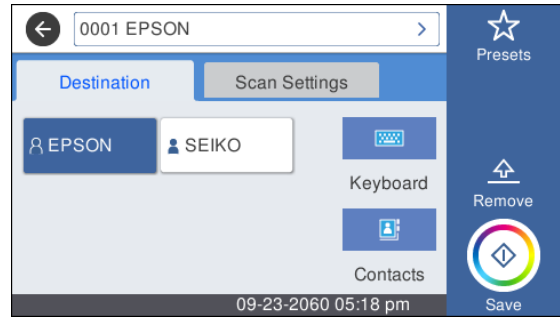

- 4 Specify the Location using one of the 3 following methods.
  - ❑ Select a recipient that is registered for frequent use: Touch the icon that is displayed.
  - ❑ Keyboard: Touch **Keyboard**. Select **Communication Mode** and enter the location in **Location (Required)**. Set any other locations as necessary.  
Enter the Location in the following formats.  
If the communication mode is SMB (when using a shared folder on a computer): \\host name (server name)\ folder path  
If the communication mode is FTP (when using an FTP server): ftp://host name (server name)/folder path
  - ❑ Select from the contacts: Touch **Contacts**, select a recipient, and then touch **Close**. You can search the folders from your contacts. Enter search keywords into the search box at the top of the screen.

**Note:**

*You can print a history of the saved folders by touching .*

- 5 Touch **Scan Settings**, and then do the settings for scanning.  
Select settings, such as the Color Mode and the File Format.  
[🔗 “Scan menu \(SC-T5400M Series Only\)” on page 171](#)  
If you are using the optional carrier sheet, you must do the following settings.
  - ❑ Specify the **Scan Size** from a standard size.
  - ❑ Set **Top Offset** to 19 mm.
- 6 Press the **Save** button to start scanning.

### Scanning (SC-T5400M Series Only)

- 7 Remove the original when scanning is complete.  
While holding the original, press the **OK** button on the screen, and then remove the original.

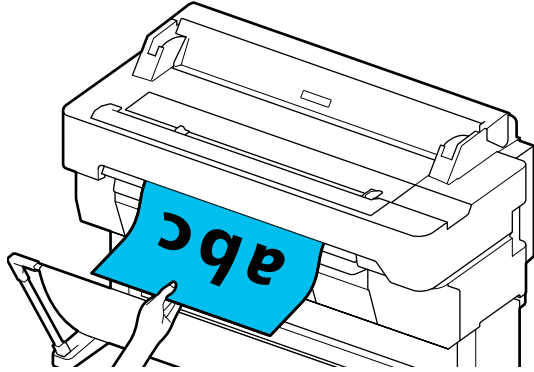

## Scanning and Attaching an Image to an Email

- 1 Load the original.  
  - ☞ “Placing Documents in the Scanner” on page 101
  - ☞ “How to Load Documents” on page 102

- 2 Touch **Scan** on the Home screen.

- 3 Touch **Email**.  
A screen from which you specify a recipient appears.

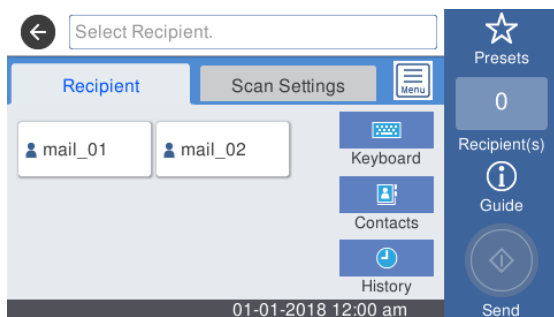

- 4 Specify the recipient using one of the 4 following methods.
  - ☐ Select a recipient that is registered for frequent use: Touch the icon that is displayed.
  - ☐ Keyboard: Touch **Keyboard** and enter a recipient. Touch **OK**.
  - ☐ Select from your contacts: Touch **Contacts**, select a recipient or group, and then touch **Close**.

You can search the recipients from your contacts. Enter search keywords into the search box at the top of the screen.

- ☐ Select from your history: Touch **History**, select a recipient, and then touch **Close**.

**Note:**

- ☐ The number of recipient that you have selected appears on the right side of the screen. You can send an email to up to 10 recipients (email addresses or groups). If you include a group in your recipients, you can also add the addresses in the group and send an email to up to 200 email addresses.
- ☐ You can check a list of the selected addresses by touching the box at the top of the screen.
- ☐ You can display or print a history of sent emails or change the email server settings by touching .

- 5 Touch **Scan Settings**, and then do the settings for scanning.  
Select settings, such as the Color Mode and the File Format.

☞ “Scan menu (SC-T5400M Series Only)” on page 171

If you are using the optional carrier sheet, you must do the following settings.

- ☐ Specify the **Scan Size** from a standard size.
- ☐ Set **Top Offset** to 19 mm.

- 6 Press the **Save** button to start scanning.

- 7 Remove the original when scanning is complete.  
While holding the original, press the **OK** button on the screen, and then remove the original.

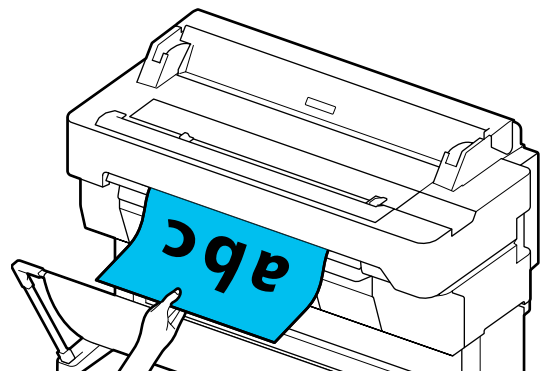

## Scanning (SC-T5400M Series Only)

## Scanning and Saving an Image to a Memory Device

- 1** Connect a USB flash memory to the printer.

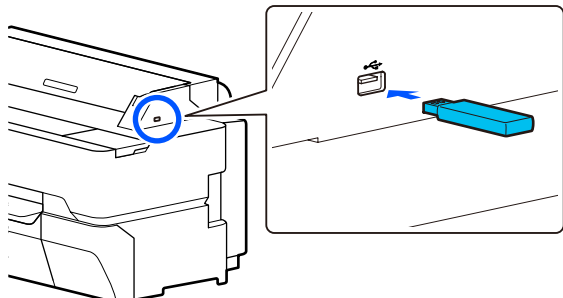

- 2** Load the original.

[“Placing Documents in the Scanner” on page 101](#)

[“How to Load Documents” on page 102](#)

- 3** Touch **Scan** on the Home screen.

- 4** Touch **Memory Device**.

- 5** In **Basic Settings**, select settings, such as Color Mode or File Format.

[“Scan menu \(SC-T5400M Series Only\)” on page 171](#)

If you are setting the scanning density, do the setting from **Advanced**.

[“Copy menu \(SC-T5400M Series Only\)” on page 167](#)

If you are using the optional carrier sheet, you must do the following settings.

- Specify the **Scan Size** from a standard size.
- Set **Top Offset** to 19 mm.

- 6** Press the **Save** button to start scanning.

- 7** Remove the original when scanning is complete.

While holding the original, press the **OK** button on the screen, and then remove the original.

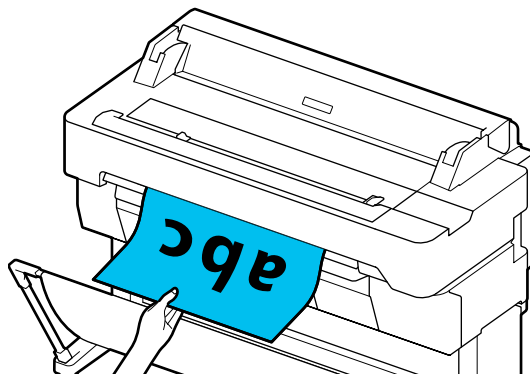

**Making Enlarged Copies with an A3 or A4 Scanner (SC-T5400 Series/SC-T3400 Series/SC-T3400N Series Only)**

# Making Enlarged Copies with an A3 or A4 Scanner (SC-T5400 Series/SC-T3400 Series/SC-T3400N Series Only)

Connecting an Epson A3 or A4 scanner to the printer makes creating enlarged copies a snap; no computer is required.

**Supported scanners**

- DS-530
- DS-6500
- DS-60000

Check the Epson website for the latest information on supported scanners.

<http://www.epson.com>

**Supported Sizes**

Document Size <sup>*1</sup>	Output Size
5 × 7 inch	A2
Letter	US C (17x22in)
A5	JIS B2
B5	US D (22x34in)
A4	A1
B4	JIS B1 <sup>*2</sup>
A3	US E (34x44in) <sup>*2</sup>
	A0 <sup>*2</sup>
	User-Defined <sup>*3</sup>

\*1 Differs depending on the specifications of the scanner to be connected.

\*2 Not supported by SC-T3400 Series/SC-T3400N Series.

\*3 89 to 914 mm wide (up to 610 mm for SC-T3400 Series/SC-T3400N Series)

**Supported paper**

Roll paper only. Enlarged copying to cut sheet is not possible.

**Connecting the Scanner**

- 1** Ready both the printer and the scanner.  
For information on setting up the scanner, see the documentation supplied with the scanner.
- 2** Turn the printer and scanner off.

**Making Enlarged Copies with an A3 or A4 Scanner (SC-T5400 Series/SC-T3400 Series/SC-T3400N Series Only)**

- 3** Connect the scanner to the printer using the USB cable supplied with the scanner.

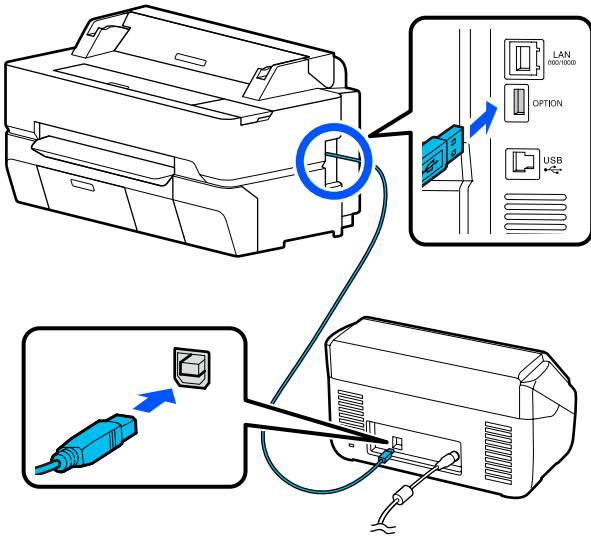

**! Important:**  
 Connect the scanner directly to the printer.  
 Enlarged copies are only available when the scanner is connected directly to the printer.

**Making Enlarged Copies**

- 1** Turn the printer and scanner on.  
 The devices may be turned on in any order.
- 2** Load roll paper supported by the enlarged copying function into the printer.  
 ↗ “Loading Roll Paper” on page 33
- 3** Place the document on the scanner glass or in the auto document feeder (ADF).  
 ↗ “Placing Documents in the Scanner” on page 110  
 For information on using the scanner, see the documentation supplied with the device.
- 4** Touch **Enlarged Copy** on the Home screen.  
 The enlarged copy dialog box is displayed.

**Note:**  
 If **Enlarged Copy** is not displayed on the Home screen, check the following.

- Are the connectors of the USB cable connecting the printer and scanner inserted firmly?
- Is the power of the scanner on?
- Is the scanner a model that supports enlarged copying?

- 5** Select the size of the document loaded in the scanner in **Original Size** and set the enlargement setting in **Reduce/Enlarge**.  
 If you set **Auto Fit Page** to **On**, printing is performed by automatically enlarging to fit the width of the roll paper loaded in the printer.

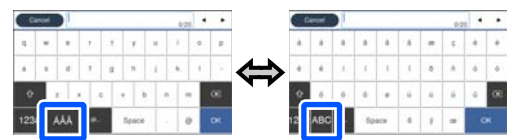

**! Important:**  
 The image quality may decline or streaks may appear depending on the document or magnification.  
 If streaks appear, try performing paper adjustment.  
 ↗ “Optimizing Paper Settings (Media Adjust)” on page 46  
 If the problem is not resolved, refer to the scanner manual and then clean the inside of the scanner.

**Note:**  
 If you touch ☆ (Presets), you can assign a name to frequently used copy settings and then register them to Presets.  
 The screen for entering a name can be switched as shown below with the button marked.



Also, each touch of the following bottom left icon switches the input method as follows.  
 ABC: Enters alphabet letters.  
 123#: Enters numbers and symbols.

## Making Enlarged Copies with an A3 or A4 Scanner (SC-T5400 Series/SC-T3400 Series/SC-T3400N Series Only)

- 6 Touch the numeric value for the number of copies and then enter the number of copies in the keypad screen.
- 7 Touch  to start copying.  
Copying can also be started by touching the  button of the scanner.

## Placing Documents in the Scanner

Failure to observe the following precautions when placing the original in the scanner may result in reduced print quality or scanning failures.

- ❑ DS-530 is a scanner that scans both sides simultaneously but it cannot scan both sides of the document with enlarged copying. Place the side you want copying facing downward in the ADF.
- ❑ Be sure to insert the original in landscape (wide) orientation.

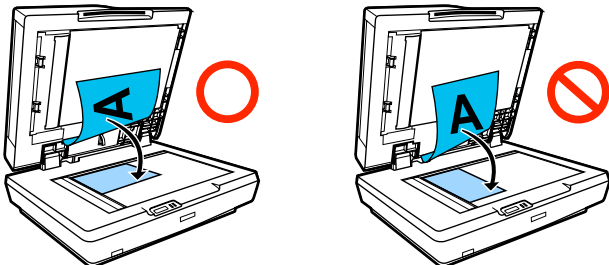

- ❑ If there are documents both on the glass and in the ADF, the document in the ADF will be scanned. Remove documents from the ADF before placing a document on the glass.
- ❑ The ADF can not be used when:
  - ❑ When **JIS B1** or **A0** is selected for Reduce/Enlarge and multiple copies will be made
  - ❑ The original is printed on thick stock (e.g., postcards or photographs)
- ❑ When multiple copies are made from an original placed on the glass, the original may be scanned once for each copy. Wait until all the copies have been printed before opening the scanner cover.

- ❑ Use the ADF to scan multi-page documents.
- ❑ If multiple copies are set for scanning multiple sheets continuously, the copies will be printed on a page basis as shown below.  
Example: Order in which pages are output when the printer is used to make two copies of a two page document

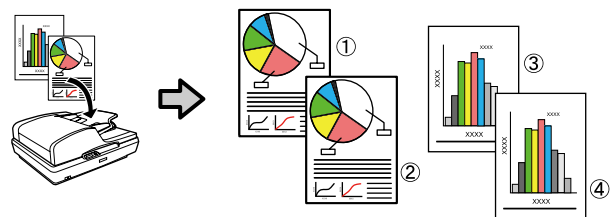

## Using the Menu

---

# Using the Menu

---

## Menu List

The items and options available in the menu are described below. See the reference pages for more details on each item.

### Paper Setting

The Paper Setting menu is displayed if paper is loaded.

Details of each item [↗](#) [“Paper Setting menu” on page 133](#)

Settings item	Settings value
Roll Paper	

## Using the Menu

Settings item	Settings value
Remove	Display the removal method
Feed/Cut Paper	Backward, Forward, Cut
Media Adjust	
Easy Adjustment	Start
Paper Feed Adjust	
Auto	Start
Manual	Start
Print length adjustment	Start
Print Head Alignment	
Auto	Start
Manual	Start
Advanced Media Setting	
Platen Gap	1.2, 1.6, 2.1 (Displayed when in Paper Type, Custom Paper is selected.)
Top/Bottom Margins	Standard, Top 3 mm/Bottom 3 mm, Top 15 mm/Bottom 15 mm, Top 35 mm/Bottom 15 mm
Paper Suction	-4 to +3
Back Tension	Auto, Standard, High, Extra High
Drying Time	
Drying Time per Pass	0 to 10.0 sec
Drying Time per Page	0 to 60 min
Paper Size Check	On, Off (Displayed when in Paper Type, Custom Paper is selected.)
Auto Cut	On, Off
Remove Skew	On, Off



### Using the Menu

Settings item	Settings value
Manage Remaining Amount	
Setup	On, Off
Remaining Amount	5.0 to 150.0 m
Remaining Alert	1.0 to 15.0 m
Change Paper Type	
Paper Type	
Plain paper	Display supported paper types
Coated Paper(Generic)	
Premium Glossy Sheet	
Others	
Paper Width	
A Series	Display supported paper widths. (Displayed if <b>Paper Size Check</b> is set to <b>Off</b> .)
US-ANSI	
US-ARCH	
B Series (ISO)	
B Series (JIS)	
Others	
User-Defined	Display paper size input screen
Cut Sheet (1 sheet)	

### Using the Menu

Settings item	Settings value
Remove	Eject paper
Media Adjust	
Easy Adjustment	Start
Paper Feed Adjust	
Auto	Start
Manual	Start
Print Head Alignment	
Auto	Start
Manual	Start
Advanced Media Setting	
Platen Gap	1.2, 1.6, 2.1 (Displayed when in Paper Type, Custom Paper is selected.)
Paper Suction	-4 to +3
Paper Size Check	On, Off (Displayed when in Paper Type, Custom Paper is selected.)
Change Paper Type/Paper Size	
Paper Type	
Plain paper	Display supported paper types
Coated Paper(Generic)	
Premium Glossy Sheet	
Others	
Paper Size	
A Series	Display supported paper sizes
US-ANSI	
US-ARCH	
B Series (ISO)	
B Series (JIS)	
Others	
User-Defined	Display paper size input screen

## Using the Menu

### Printer Status

Details of each item [↗](#) [“Printer Status menu” on page 139](#)

Settings item	Settings value
Supply Status	Display approximate remaining amounts, as well as product number of consumables
Message List	Display list of messages communicating printer status
Firmware Version	Display firmware version
Print Status Sheet	
Configuration Status Sheet	Print

### Settings

Items marked with an asterisk (\*) are displayed only for SC-T5400M Series.

Settings item	Settings value
General Settings	
Basic Settings (Details of each item <a href="#">↗</a> <a href="#">“General Settings - Basic Settings” on page 140</a> )	
LCD Brightness	1 to 9
Sound	
Mute	On, Off

### Using the Menu

Settings item	Settings value
Normal Mode	
Button Press	0 to 10
Error Notice	0 to 10
Sound Type	Pattern1, Pattern2
Sleep Timer	1 to 210 minutes (SC-T5400M Series only: 1 to 60 minutes)
Power Off Timer	Off, 30minutes, 1h, 2h, 4h, 8h, 12h
Circuit Breaker Interlock Startup	On, Off
Date/Time Settings	
Date/Time	Date: yyyy.mm.dd, mm.dd.yyyy, dd.mm.yyyy Time: 12h, 24h
Time Difference	-12:45 to +13:45 (15 minute increments)
Language	Display supported languages
Operation Time Out	On, Off
Keyboard	QWERTY, AZERTY, QWERTZ
Length Unit	m, ft / in
Printer Settings (Details of each item <a href="#">↗ "General Settings - Printer Settings" on page 142</a> )	
Paper Source Settings	
Error Notice	
Paper Size Notice	On, Off
Paper Type Notice	On, Off
Roll Paper Setup	
Detect Paper Meandering	On, Off
Print Cutting Guideline	On, Off
Cut for Borderless Print	Two Cuts, One Cut
Quick Cut	On, Off
Cut Mode	Normal, Quiet
Margin Refresh	On, Off
Back Tension 2	1 to 5
Custom Paper Setting (Custom paper types 01 to 10 are displayed, and touching any of these will display settings items.)	
Change Name	Registered name input screen

## Using the Menu

Settings item	Settings value
Change Reference Paper	
Plain paper	Display supported paper types
Matte Paper	
Photo Paper	
CAD	
Others	
Advanced Media Setting	
Platen Gap	1.2, 1.6, 2.1
Top/Bottom Margins	Standard, Top 3 mm/Bottom 3 mm, Top 15 mm/Bottom 15 mm, Top 35 mm/Bottom 15 mm
Paper Suction	-4 to +3
Back Tension	Auto, Standard, High, Extra High
Drying Time	
Drying Time per Pass	0.0 to 10.0 sec
Drying Time per Page	0.0 to 60 min
Paper Size Check	On, Off
Auto Cut	On, Off
Remove Skew	On, Off
Restore Default	Yes, No
Printing Language	
USB	Auto, HP-GL/2
Network	Auto, HP-GL/2
Universal Print Settings	
Paper Source	Roll Paper, Cut Sheet (1 sheet)
Quality	Standard, Speed, Fine, Super Fine, Draft
Color Mode	Color, Black/White
Page Margins option	Clip By Margins, Oversize
Page Margin	3 mm, 5 mm
Smoothing	On, Off

## Using the Menu

Settings item	Settings value
<b>Base Output Size</b>	
Auto	-
A Series	Display supported paper sizes
US-ANSI	
US-ARCH	
B Series (ISO)	
B Series (JIS)	
Others	
User-Defined	
Resolution	Standard, 300dpi, 600dpi, 1200dpi
Color Mode (Common)	EPSON Standard (sRGB), Business Graphics, GIS, Line Drawing, Off (No Color Management)
<b>HP-GL/2 Unique Settings</b>	
Rotate	0°, 90°, 180°, 270°
Origin Setup	Left Edge, Center
Mirror Image	On, Off
Line Merge	On, Off
Color Mode (HP-GL/2)	EPSON Standard (sRGB), Business Graphics, GIS, Line Drawing, Off (No Color Management)
Select Palette	Software, Default, Palette A, Palette B
Print Color Palette	Print
<b>Define Palette</b>	
Palette A	Display screen to set pen width and pen color
Palette B	
Restore default HP-GL/2 Unique Settings	Yes, No
<b>Memory Device Interface</b>	
Memory Device	Enable, Disable
Thick Paper	Off, On
Self Check and Cleaning	Off, Once, Twice, Three times
Bidirectional	On, Off
PC Connection via USB	Enable, Disable
USB I/F Timeout Setting	0 sec, or 5 to 300 sec

### Using the Menu

Settings item	Settings value
Network Settings (Details of each item  <a href="#">"General Settings - Network Settings" on page 154</a> )	
Wi-Fi Setup	
Router	
Connect via Wi-Fi	When wireless LAN connection disabled: Display <b>Connect via Wi-Fi</b> menu When wireless LAN connection connected: Display connection status and settings information
Wi-Fi Setup Wizard	
Push Button Setup(WPS)	
Others	
PIN Code Setup(WPS)	
Wi-Fi Auto Connect	
Disable Wi-Fi	
Wi-Fi Direct	
Wi-Fi Direct	When Wi-Fi Direct disabled: Display <b>Wi-Fi Direct</b> wizard When Wi-Fi Direct enabled: Display settings information and number of connected devices
Change Password	
Disable Wi-Fi Direct	
Delete Registered Device	
Wired LAN Setup	Start Setup (Displayed when connected to a wireless LAN.)
Network Status	
Wired LAN/Wi-Fi Status	Display current connection settings
Wi-Fi Direct Status	
Email Server Status *	Display setting items
Print Status Sheet	Print
Connection Check	Start network connection check

### Using the Menu

Settings item	Settings value
<b>Advanced</b>	
Device Name	Display settings change screen
TCP/IP	
Proxy Server	
Email Server *	Display <b>General Settings - Scan Settings - Email Server</b>
Shared Folder *	Display settings change screen
IPv6 Address	Enable, Disable
Link Speed & Duplex	Auto, 10BASE-T Half Duplex, 10BASE-T Full Duplex, 100BASE-TX Half Duplex, 100BASE-TX Full Duplex
Redirect HTTP to HTTPS	Enable, Disable
Disable IPsec/IP Filtering	Proceed
Disable IEEE802.1X	(Displayed when enabled.)
iBeacon Transmission *	Enable, Disable
Scan Settings* (Details of Each Item <a href="#">🔗</a> <b>"General Settings - Scan Settings (SC-T5400M Series Only)"</b> on page 156)	
Confirm Recipient	On, Off
Email Server	
Server Settings	Off, POP before SMTP, SMTP-AUTH
Connection Check	Start a test
<b>Scan Options</b>	
Confirm Before Ejecting Scanned Document	On, Off
Correct Skewed Image	On, Off
Document Feed Adjustment	-1.00 to 1.00
Image Stitching Adjustment	-5 to 5
System Administration (Details of each item <a href="#">🔗</a> <b>"General Settings - System Administration"</b> on page 158)	
<b>Contacts Manager *</b>	
Register/Delete	Display the Register/Delete screen for Contacts
<b>Frequent</b>	
Email	Display the screen for registering frequently used addresses
Network Folder/FTP	Display the screen for registering frequently used addresses
<b>Print Contacts</b>	
List of all Contacts	Specify the print area, and then print
List of Email Contacts	Specify the print area, and then print
List of Folder/FTP Contacts	Specify the print area, and then print



### Using the Menu

Settings item	Settings value
View Options	Tile View, List View
Search Options	Begins with, Ends with, Includes
<b>Security Settings</b>	
<b>Restrictions *</b>	
Access to Register/Delete	Off, On
Access to Recent of Scan to Email	Off, On
Access to Show Sent History of Scan to Email	Off, On
Access to Language	Off, On
Access to Thick Paper	Off, On
Protection of Personal Data	Off, On
Access Control *	Off, On
<b>Admin Settings</b>	
Admin Password	Register, Change, Clear All Settings
Lock Setting	Off, On
<b>Restore Default Settings</b>	
all Wi-Fi/network settings	Yes, No
Copy Settings	Yes, No
Scan Settings	Yes, No
Clear All Data and Settings	Yes, No
<b>Firmware Update</b>	
Update	Start Checking
Notification	Off, On
Supply Status	Display approximate remaining amounts, as well as product number of consumables
Maintenance (Details of each item  "Maintenance" on page 160)	

## Using the Menu

Settings item	Settings value
Print Quality Adjustment	Start
Print Head Nozzle Check	Start
Head Cleaning	Start
Ink Cartridge(s) Replacement	Display procedure
Replace Maintenance Box	Display procedure
Replace Cutter	Start
Powerful Cleaning	Start
Discharging/Charging Ink	Start
Language	Display supported languages
Printer Status/Print (Details of each item <a href="#">☞</a> "Printer Status/Print" on page 161)	
Print Status Sheet	
Configuration Status Sheet	Print
Network	Display <b>General Settings - Network Settings - Network Status</b>
Contacts Manager *	Display <b>General Settings - System Administration - Contacts Manager</b>

### Enlarged Copy (SC-T5400 Series/SC-T3400 Series/SC-T3400N Series Only)

Displayed when an Epson A3 or A4 scanner is connected to the printer. Set scaling in this menu to enable enlarged printing of the scanned documents.

Details of each item

[☞](#) "Enlarged Copy menu (SC-T5400 Series/SC-T3400 Series/SC-T3400N Series Only)" on page 162

Settings item	Settings value
Copies	1 to 99
Color Mode	Black/White, Color
Original Size	A4, A5, A3, B5, B4, Letter, 13 × 18 cm (5 × 7 in)
Reduce/Enlarge	
Auto Fit Page	On, Off
Custom Size	A0*, US E (34x44in)*, JIS B1*, A1, US D (22x34in), JIS B2, US C (17x22in), A2, User-Defined *Only SC-T5400 Series is displayed.
Density	-4 to 4
Quality	Speed, Fine

## Using the Menu

### Memory Device

Displayed when a USB flash memory is connected to the printer. JPEG files and TIFF files stored on the memory can be printed directly from the printer.

Details of each item  [“Memory Device menu” on page 164](#)

Settings item	Settings value
Basic Settings	
Copies	1 to 99
Paper Source	Roll Paper, Cut Sheet (1 sheet)
Color Mode	Black/White, Color
Advanced	
Quality	Speed, Fine, Super Fine
Page Margins option	Clip By Margins, Oversize, Borderless
Bidirectional	On, Off
Reduce/Enlarge	
Auto Fit Page	On, Off
Custom Size	Actual Size, A4, A3, Super A3, A2, Super A2, A1, Super A1, A0 *, Super A0 *, Letter, Legal, US B (11x17in), US C (17x22in), US D (22x34in), US E (34x44in) *, ARCH A (9x12in), ARCH B (12x18in), ARCH C (18x24in), ARCH D (24x36in), ARCH E1 (30x42in) *, ARCH E (36x48in) *, ISO B4, ISO B3, ISO B2, ISO B1 *, JIS B5, JIS B4, JIS B3, JIS B2, JIS B1 *, 24 x 30 in, 30 x 40 in *, 36 x 44 in *, 30 x 40 cm, 40 x 60 cm, 50 x 70 cm, 60 x 90 cm, 70 x 100 cm *, User-Defined *Only SC-T5400 Series is displayed.
Color Mode (SC-T5400 Series/SC-T3400 Series/SC-T3400N Series Only)	EPSON Standard (sRGB), Business Graphics, GIS, Line Drawing, Off (No Color Management)
Select Target (SC-T5400M Series Only)	Poster(Photo)/Perspective, Poster/Document, GIS, CAD/Line Drawing, Off (No Color Management)

### Copy (SC-T5400M Series Only)

Details of each item  [“Copy menu \(SC-T5400M Series Only\)” on page 167](#)

Settings item	Settings value
Basic Settings	

### Using the Menu

Settings item	Settings value
Copies	1 to 99
Color Mode	Black/White, Color
Quality	Speed, Fine, Super Fine, Draft
Density	-4 to 4
Paper Source	Roll Paper, Cut Sheet (1 sheet)
Reduce/Enlarge	
Auto Fit Page	On, Off
Custom Size	Actual Size, ISO A4->A0, ISO A3->A0, ISO A4->A1, ISO A2->A0, ISO A3->A1, ISO A1->A0, ISO A2->A1, ISO A0->A1, ISO A1->A2, ISO A0->A2, ISO A1->A3, ISO A0->A3, ISO A1->A4, ISO A0->A4, US ANSI/ARCH A->E, US ANSI/ARCH B->E, US ANSI/ARCH A->D, US ANSI/ARCH C->E, US ANSI/ARCH B->D, US ANSI/ARCH D->E, US ANSI/ARCH C->D, US ANSI/ARCH E->D, US ANSI/ARCH D->C, US ANSI/ARCH E->C, US ANSI/ARCH D->B, US ANSI/ARCH E->B, US ANSI/ARCH D->A, US ANSI/ARCH E->A
Page Margins option	Clip By Margins, Oversize, Borderless
Advanced	

### Using the Menu

Settings item	Settings value
Original Type	Text & Image, Tracing Paper, Recycled, Blueprint, Blueprint Inverted, Watercolor Rendering
Original Size	
Auto Detect	-
ISO A	Display supported sizes for originals
US-ANSI	
US-ARCH	
JIS B	
ISO B	
User-Defined	
Top Offset	0.0 to 100.0 mm 0.00 to 3.94 inch
Image Quality	
Contrast	-4 to 4
Sharpness	-4 to 4
Remove Background	-4 to 4
Bidirectional	On, Off
Color Mode	EPSON Standard (sRGB), Business Graphics, GIS, Line Drawing, Off (No Color Management)
Reset	Yes, No

#### Scan (SC-T5400M Series Only)

Details of each item [🔗](#) “Scan menu (SC-T5400M Series Only)” on page 171

Settings item	Settings value
Network Folder/FTP	

### Using the Menu

Settings item	Settings value
Destination	Display the Location Selection screen
Scan Settings	
Color Mode	Black/White, Color
File Format	
File Format	JPEG, PDF, PDF/A, TIFF (Multi Page)
Compression Ratio	High Compression, Standard Compression, Low Compression
PDF Settings	
Document Open Password	
Password Setting	Off, On
Password	Enter password
Permissions Password	
Password Setting	Off, On
Password	Enter password
Printing	Allowed, Not Allowed
Editing	Allowed, Not Allowed
Resolution	200dpi, 300dpi, 400dpi, 600dpi
Scan Size	
Auto Detect	-
ISO A	Display supported scan sizes
US-ANSI	
US-ARCH	
JIS B	
ISO B	
User-Defined	Display the Scan Size Input screen
Top Offset	0.0 to 100.0 mm 0.00 to 3.94 inch
Original Type	Text & Image, Tracing Paper, Recycled, Blueprint, Blueprint Inverted, Watercolor Rendering
Density	-4 to 4

### Using the Menu

Settings item	Settings value
<b>Image Quality</b>	
Contrast	-4 to 4
Sharpness	-4 to 4
Remove Background	-4 to 4
<b>File Name</b>	
Filename Prefix	Enter the filename prefix
Add Date	On, Off
Add Time	On, Off
Reset	Yes, No
<b>Email</b>	

### Using the Menu

Settings item	Settings value
Destination	Display the Recipient Selection screen
Scan Settings	
Color Mode	Black/White, Color
File Format	
File Format	JPEG, PDF, PDF/A, TIFF (Multi Page)
Compression Ratio	High Compression, Standard Compression, Low Compression
PDF Settings	
Document Open Password	
Password Setting	Off, On
Password	Enter password
Permissions Password	
Password Setting	Off, On
Password	Enter password
Printing	Allowed, Not Allowed
Editing	Allowed, Not Allowed
Resolution	200dpi, 300dpi, 400dpi, 600dpi
Scan Size	
Auto Detect	-
ISO A	Display supported scan sizes
US-ANSI	
US-ARCH	
JIS B	
ISO B	



### Using the Menu

Settings item		Settings value
	User-Defined	Display the Scan Size Input screen
	Top Offset	0.0 to 100.0mm 0.00 to 3.94inch
	Original Type	Text & Image, Tracing Paper, Recycled, Blueprint, Blueprint Inverted, Watercolor Rendering
	Density	-4 to 4
Image Quality		
	Contrast	-4 to 4
	Sharpness	-4 to 4
	Remove Background	-4 to 4
	Subject	Enter subject
	Attached File Max Size	1MB, 2MB, 5MB, 10MB, 20MB, 30MB
File Name		
	Filename Prefix	Enter the filename prefix
	Add Date	On, Off
	Add Time	On, Off
	Reset	Yes, No
Memory Device		

### Using the Menu

Settings item	Settings value
Basic Settings	
Color Mode	Black/White, Color
File Format	
File Format	JPEG, PDF, PDF/A, TIFF (Multi Page)
Compression Ratio	High Compression, Standard Compression, Low Compression
PDF Settings	
Document Open Password	
Password Setting	Off, On
Password	Enter password
Permissions Password	
Password Setting	Off, On
Password	Enter password
Printing	Allowed, Not Allowed
Editing	Allowed, Not Allowed
Resolution	200dpi, 300dpi, 400dpi, 600dpi

### Using the Menu

Settings item	Settings value
Scan Size	
Auto Detect	-
ISO A	Display supported scan sizes
US-ANSI	
US-ARCH	
JIS B	
ISO B	
User-Defined	
Top Offset	0.0 to 100.0 mm 0.00 to 3.94 inch
Original Type	Text & Image, Tracing Paper, Recycled, Blueprint, Blueprint Inverted, Watercolor Rendering
Advanced	
Density	-4 to 4
Image Quality	
Contrast	-4 to 4
Sharpness	-4 to 4
Remove Background	-4 to 4
File Name	
Filename Prefix	Enter the filename prefix
Add Date	On, Off
Add Time	On, Off
Reset	Yes, No

#### Network Folder (SC-T5400M Series Only)

Details of each item  [“Network Folder menu \(SC-T5400M Series Only\)” on page 179](#)

Settings item	Settings value
Basic Settings	
Paper Source	Roll Paper, Cut Sheet (1 sheet)
Color Mode	Black/White, Color
Advanced	

## Using the Menu

Settings item	Settings value
Quality	Speed, Fine, Super Fine
Page Margins option	Clip By Margins, Oversize, Borderless
Bidirectional	On, Off
Color Mode	EPSON Standard (sRGB), Business Graphics, GIS, Line Drawing, Off (No Color Management)
Reduce/Enlarge	
Auto Fit Page	On, Off
Custom Size	Actual Size, User-Defined



## Using the Menu

## Paper Setting menu







### Roll Paper menu

- ❑ The Paper Setting menu is displayed if paper is loaded.
- ❑ **Media Adjust** adjustment results, and settings in **Advanced Media Setting** and **Manage Remaining Amount** are stored for each paper type in **Paper Type**. Changing adjustments and settings will save these as the currently selected paper type settings even if the power is turned off.

\*Default setting

Settings item	Settings value	Explanation
Remove		Rewind the roll paper until it is ejected from inside the printer.  <a href="#">"Removing Roll Paper" on page 38</a>
Feed/Cut Paper	Backward	Use Backward and Forward to move the paper to the desired position. Touch Cut to cut the paper using the built-in cutter.  <a href="#">"Cutting the Roll Paper" on page 36</a>
	Forward	
	Cut	
Media Adjust		



### Using the Menu

Settings item	Settings value	Explanation
Easy Adjustment	Start	<p>Run this adjustment when there is a problem with print results, or after registering custom paper settings.</p> <p>Touch <b>Start</b> and the printer will run Paper Feed Adjust and Print Head Alignment automatically.</p> <p> <a href="#">"Optimizing Paper Settings (Media Adjust)" on page 46</a></p>
Paper Feed Adjust		
Auto	Start	<p>Run this adjustment when streaks (horizontal banding or uneven colors) appear in print results.</p> <p>For details on <b>Auto</b>, see the following.</p> <p> <a href="#">"Paper Feed Adjust (Auto)" on page 47</a></p> <p>Run <b>Manual</b> if an error appears during automatic adjustment or you are not satisfied with the automatic adjustment results.</p> <p> <a href="#">"Paper Feed Adjust (Manual) Procedure" on page 195</a></p> <p>Run <b>Print length adjustment</b> if you want to precisely adjust the paper feed amount for printing drawings and other information.</p> <p> <a href="#">"Lengths differ between the print results and print data" on page 199</a></p>
Manual	Start	
Print length adjustment	Start	
Print Head Alignment		
Auto	Start	<p>Run this adjustment when ruled lines are duplicated, lettering is warped, or print results are grainy.</p> <p>For details on <b>Auto</b>, see the following.</p> <p> <a href="#">"Print Head Alignment (Auto)" on page 47</a></p> <p>Run <b>Manual</b> if an error appears during automatic adjustment or you are not satisfied with the automatic adjustment results.</p> <p> <a href="#">"Print Head Alignment (Manual) Procedure" on page 195</a></p>
Manual	Start	
Advanced Media Setting		
Platen Gap	1.2	<p>Displayed when <b>Custom Paper</b> is selected in <b>Paper Type</b>. When registering Custom Paper, this is the Platen Gap (distance between print head and paper) for the paper selected in <b>Change Reference Paper</b>, so it does not normally need to be changed. Change this to a setting that will widen the gap (a higher value) if print results are smeared.</p>
	1.6	
	2.1	

### Using the Menu

Settings item	Settings value	Explanation
Top/Bottom Margins	Standard *	Setting this to Standard will set the top/bottom margins as follows depending on the printer driver print targets. <input type="checkbox"/> CAD/Line Drawing: 3 mm/3 mm <input type="checkbox"/> Other: 30 mm/30 mm  Left and right margins will remain at 3 mm regardless of settings. If there is any soiling on the top section of the print results, increase the top margin. <a href="#">🔗 "Printable area" on page 223</a>
	Top 3 mm/Bottom 3 mm	
	Top 15 mm/Bottom 15 mm	
	Top 35 mm/Bottom 15 mm	
Paper Suction	-4 to +3	It is important to choose the appropriate amount of suction for the paper used in order to maintain the correct distance between the paper and print head. Choosing too high a value for thin or soft paper will increase the distance between the paper and print head too much, causing print quality to decline or preventing the paper feeding correctly. In such cases, you will need to lower the paper suction. The lower the setting value, the weaker the suction power.
Back Tension	Auto *	If there is any wrinkling on the paper during printing, set this to <b>High</b> or <b>Extra High</b> .  When this is set to <b>Extra High</b> , the following setting is enabled.  <b>Settings - General Settings - Printer Settings - Paper Source Settings - Roll Paper Setup - Back Tension 2</b>
	Standard	
	High	
	Extra High	
Drying Time		
Drying Time per Pass	0.0 to 10.0 seconds (0.0*)	Select the time the print head pauses to allow drying after each pass. Choose from values between 0.0 and 10.0 seconds. Depending on the paper type, the ink may take a while to dry. If the ink blurs on the paper, set a longer time for drying the ink. Increasing the drying time increases the time needed to print.
Drying Time per Page	0.0 to 60 minutes (0.0*)	Specify how long the printer pauses to allow the ink to dry after printing each page; choose from values between 0.0 and 60 minutes. Depending on the ink density or paper type, the ink may take a while to dry. If the ink blurs on the paper, set a longer time for drying the ink. The longer the drying time, the more time required for printing.
Paper Size Check	On *	Displayed when <b>Custom Paper</b> is selected in <b>Paper Type</b> . Select whether to detect (On) or not detect (Off) the paper width when paper is loaded. Try choosing Off if a paper setting error is displayed even though the paper is correctly loaded. Note, however, that the printer may print outside the paper when Off is selected. If it prints beyond the edges of the paper, the inside of the printer becomes dirty with ink. We generally recommend using the printer with this set to On.  The changes are applied after the paper is reloaded. Note that they are not applied if you just change the menu items.
	Off	
Auto Cut	On *	Select whether to automatically cut (On) or not cut (Off) using the built-in cutter as each page is printed on roll paper. Set On to automatically cut the edge if it is not a horizontal cut when paper is loaded. The setting selected with the printer driver takes priority when the printer driver is used.  <a href="#">🔗 "Cutting the Roll Paper" on page 36</a>
	Off	

## Using the Menu

Settings item	Settings value	Explanation
Remove Skew	On *	Select whether to enable (On) or disable (Off) paper skew reduction.
	Off	
Manage Remaining Amount		
Setup	On	Select whether to display/record (On) or not to display/ record (Off) the amount of remaining roll paper. Set <b>On</b> to enable <b>Remaining Amount</b> and <b>Remaining Alert</b> .  <a href="#">"For Roll Paper" on page 42</a>
	Off *	
Remaining Amount	5.0 to 150.0 m (30 <sup>*</sup> )	Entering the total length of the loaded roll paper in <b>Remaining Amount</b> displays an estimate of remaining amount of roll paper on the printer's Home screen and on the printer driver screen.
Remaining Alert	1.0 to 15.0 m (5.0 <sup>*</sup> )	In <b>Remaining Alert</b> , set the limit at which to display a warning when the amount of remaining roll paper drops below that limit. You can set in 0.1 m increments.  Also, when the roll paper is removed, the remaining amount, setting value of Remaining Alert, and paper type are automatically converted to a barcode which is printed at the end of the roll paper. The printer automatically reads the barcode and sets the settings when you load the roll paper next time.
Change Paper Type		
Paper Type	Plain paper *	Select the type of the loaded paper. The three options other than <b>Others</b> display the most recently selected paper type. When the desired paper type is not displayed, touch <b>Others</b> to display the other paper types and then select a paper type.   <a href="#">"For Roll Paper" on page 42</a>
	Coated Paper(Generic)	
	Premium Glossy Sheet	
	Others	
Paper Width	A Series	This is displayed if <b>Advanced Media Setting - Paper Size Check</b> is set to <b>Off</b> .
	US-ANSI	Select the width of the loaded paper.
	US-ARCH	If the desired size is not in the options, select User-Defined and enter the paper width.
	B Series (ISO)	
	B Series (JIS)	
	Others	
	User-Defined	









## Using the Menu

## Cut Sheet (1 sheet) menu

The Paper Setting menu is displayed if paper is loaded.

\*Default setting

Settings item	Settings value	Explanation
Remove		Touch to eject the loaded cut sheet (1 sheet) without printing. Touch to eject to the front.  <a href="#">"Removing Cut Sheet (1 Sheet)" on page 41</a>
Media Adjust		
Easy Adjustment	Start	Run this adjustment when there is a problem with print results, or after registering custom paper settings. Simply touch <b>Start</b> and the printer will run Paper Feed Adjust and Print Head Alignment automatically.  <a href="#">"Optimizing Paper Settings (Media Adjust)" on page 46</a>
Paper Feed Adjust		
Auto	Start	Run this adjustment when streaks (horizontal banding or uneven colors) appear in print results. For details on <b>Auto</b> , see the following.  <a href="#">"Paper Feed Adjust (Auto)" on page 47</a> Run <b>Manual</b> if an error appears during automatic adjustment or you are not satisfied with the automatic adjustment results.  <a href="#">"Paper Feed Adjust (Manual) Procedure" on page 195</a>
Manual	Start	
Print Head Alignment		
Auto	Start	Run this adjustment when ruled lines are duplicated, lettering is warped, or print results are grainy. For details on <b>Auto</b> , see the following.  <a href="#">"Print Head Alignment (Auto)" on page 47</a> Run <b>Manual</b> if an error appears during automatic adjustment or you are not satisfied with the automatic adjustment results.  <a href="#">"Print Head Alignment (Manual) Procedure" on page 195</a>
Manual	Start	
Advanced Media Setting		



### Using the Menu

Settings item	Settings value	Explanation
Platen Gap	1.2	This is displayed when <b>Custom Paper</b> is selected in <b>Paper Type</b> . When registering Custom Paper, this is the Platen Gap (distance between print head and paper) for the paper selected in <b>Change Reference Paper</b> , so it does not normally need to be changed. Change this to a setting that will widen the gap (a higher value) if print results are smeared.
	1.6	
	2.1	
Paper Suction	-4 to +3	It is important to choose the appropriate amount of suction for the paper used in order to maintain the correct distance between the paper and print head. Choosing too high a value for thin or soft paper will increase the distance between the paper and print head too much, causing print quality to decline or preventing the paper feeding correctly. In such cases, you will need to lower the paper suction. The lower the setting value, the weaker the suction power.
Paper Size Check	On *	This is displayed when <b>Custom Paper</b> is selected in <b>Paper Type</b> . Select whether to detect (On) or not detect (Off) the paper width when paper is loaded. Try choosing Off if a paper setting error is displayed even though the paper is correctly loaded. Note, however, that the printer may print outside the paper when Off is selected. If it prints beyond the edges of the paper, the inside of the printer becomes dirty with ink. We generally recommend using the printer with this set to On.  The changes are applied after the paper is reloaded. Note that they are not applied if you just change the menu items.
	Off	
Change Paper Type/Paper Size		
Paper Type	Plain paper *	Select the type of the loaded paper. The three options other than <b>Others</b> display the most recently selected paper type. When the desired paper type is not displayed, touch <b>Others</b> to display the other paper types and then select a paper type.   <a href="#">"For Cut Sheet (1 sheet)" on page 43</a>
	Coated Paper(Generic)	
	Premium Glossy Sheet	
	Others	
Paper Size	A Series	Select the size of the loaded paper.
	US-ANSI	If the desired size is not in the options, then select <b>User-Defined</b> , and enter the paper width and length.
	US-ARCH	
	B Series (ISO)	
	B Series (JIS)	
	Others	
	User-Defined	

Using the Menu

# Printer Status menu

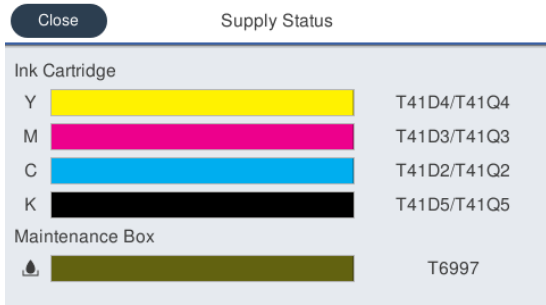
\*Default setting

Settings item	Settings value	Explanation
Supply Status		<p>Display the approximate remaining amounts of each color in ink cartridge and its product number, and the approximate capacity in and product number of the Maintenance Box.</p>  <p>The shorter a bar is, the lower the remaining amount of ink or space. Even if  is displayed, printing is possible until replacement is instructed. However, ensure that a new ink cartridge of that color, or a new Maintenance Box is readied in advance.</p> <p>Furthermore, the ink color codes beside the bars indicate the following.</p> <ul style="list-style-type: none"> <li><input type="checkbox"/> Y: Yellow</li> <li><input type="checkbox"/> M: Magenta</li> <li><input type="checkbox"/> C: Cyan</li> <li><input type="checkbox"/> K: Black</li> </ul>
Message List		Display a list of messages communicating printer status. Select a message from the list to display detailed information.
Firmware Version		Display the printer firmware version.
Print Status Sheet		
Configuration Status Sheet		Print a list of current printer settings. Use this to view all information at a glance.

## Using the Menu

# Settings menu

## General Settings

### General Settings - Basic Settings

\*Default setting

Settings item	Settings value	Explanation
LCD Brightness	1 to 9 (9*)	Adjust screen brightness.
Sound		
Mute	On	Setting this to <b>On</b> will mute the sound output when touching the menu or other items on the control panel screen, and the confirmation sound output when inserting paper into the paper slot when loading paper.
	Off *	
Normal Mode		
Button Press	0 to 10 (5*)	Adjust the volume of the sound when touching the menu or other items on the control panel screen, and of the confirmation sound when inserting paper into the paper slot when loading paper.
Error Notice	0 to 10 (5*)	Adjust the volume of the sound notifying of an error.
Sound Type	Pattern1 *	Adjust the type of the sound when touching the menu or other items on the control panel screen, and of the confirmation sound when inserting paper into the paper slot when loading paper.
	Pattern2	
Sleep Timer	1 to 210 minutes (15*) SC-T5400M Series only: 1 to 60 minutes (15*)	The printer will enter sleep mode if no errors have occurred, no print jobs have been received, and no actions are performed on the control panel for an extended period of time. This setting selects the amount of time until the printer enters sleep mode. <a href="#">🔗 "Saving Power" on page 23</a>
Power Off Timer	Off	You can select the time after which the printer will turn off automatically if no errors have occurred, no print jobs have been received, or no actions are performed on the control panel for an extended period of time. <a href="#">🔗 "Saving Power" on page 23</a>
	30minutes	
	1h	
	2h	
	4h	
	8h *	
	12h	
Circuit Breaker Interlock Startup	On *	Select whether to turn the printer on (On) or off (Off) when the breaker switch is turned on.
	Off	
Date/Time Settings		

## Using the Menu

Settings item	Settings value	Explanation
Date/Time	-	Enter the current date and time.
Time Difference	-12:45 to +13:45 (0.00*)	Set the difference with coordinated universal time (UTC) in 15 minute increments.  In network environments with a time difference, set this as necessary when administrating the printer.
Language	Japanese	Select the language used on the control panel's screen.
	English	
	French	
	Italian	
	German	
	Portuguese	
	Spanish	
	Dutch	
	Polish	
	Russian	
	Korean	
	Simplified Chinese	
Traditional Chinese		
Operation Time Out	On *	Setting this to <b>On</b> will display a message and return to the Home screen if there is no operation within a certain amount of time while a screen other than the Home screen is displayed.
	Off	
Keyboard	QWERTY *	Select the key arrangement for the text input screen displayed when entering the name of Custom Paper or other name.
	AZERTY	
	QWERTZ	
Length Unit	m *	Select the units of length to use when displaying the length of roll paper and other items.
	ft / in	

**Using the Menu**

**General Settings - Printer Settings**

\*Default setting

Settings item	Settings value	Explanation
Paper Source Settings		

### Using the Menu

Settings item	Settings value	Explanation
Error Notice		
Paper Size Notice	On	Setting this to <b>On</b> will display an error message when the output size or paper type settings of print jobs sent to the printer differ from those settings in the printer.
	Off*	
Paper Type Notice	On	
	Off*	
Roll Paper Setup		
Detect Paper Meandering	On*	If On is selected, an error will be displayed in the control panel and printing will stop if the paper is skewed; select Off to disable this feature. On is recommended in most circumstances as skewed paper may cause the printer to jam.
	Off	
Print Cutting Guideline	On	If Auto Cut is Off, you can choose to print (On) or not print (Off) cut lines on roll paper. Cut lines are not printed if Auto Cut is On or when cut sheets are used. Note, however, that if the roll width selected with the computer is narrower than the paper loaded in the printer, cut lines will be printed regardless of the option selected for Auto Cut. The setting selected with the printer driver takes priority when the printer driver is used.
	Off*	
Cut for Borderless Print	Two Cuts*	Select whether to insert a margin and cut twice between pages (Two Cuts) or cut once between pages (One Cut) when printing multiple pages with borderless printing.  The setting selected with the printer driver takes priority when the printer driver is used.  <a href="#">🔗 "About Roll Paper Cutting" on page 71</a>
	One Cut	
Quick Cut	On*	Specify the cutting operation for printing multiple page jobs.  Setting this to <b>On</b> will cut the preceding printout when its trailing edge reaches the cutting position while the next job is being printed. This shortens the printing time because printing and cutting are done in tandem.  The details of the cutting operation are the same as <b>One Cut</b> of <b>Cut for Borderless Print</b> or <b>Single Cut</b> of the printer driver.  <a href="#">🔗 "About Roll Paper Cutting" on page 71</a>  Setting this to <b>Off</b> will start the next print job after the preceding print job is fed to its cutting position and cutting is completed.
	Off	
Cut Mode	Normal*	If you want to reduce operation noise during cutting, set <b>Quiet</b> . If <b>Quiet</b> is set, the cutting speed is reduced.
	Quiet	
Margin Refresh	On*	Select whether to automatically cut (On) or not cut (Off) the leading edge in order to remove ink stains that may have been left by previous borderless printing before printing with borders.
	Off	

## Using the Menu

Settings item	Settings value	Explanation
Back Tension 2	1 to 5 (2*)	<p>When one of the following settings is set, this setting is enabled.</p> <ul style="list-style-type: none"> <li><input type="checkbox"/> Roll paper information area - <b>Advanced Media Setting - Back Tension - Extra High</b></li> <li><input type="checkbox"/> <b>Settings - General Settings - Printer Settings - Custom Paper Setting - Advanced Media Setting - Back Tension - Extra High</b></li> </ul> <p>If wrinkles are formed in the paper during printing even when <b>High</b> is set in the above <b>Back Tension</b> menu, select <b>Extra High</b> and then configure the strength of the back tension in this setting.</p> <p>A higher value produces a higher tension.</p>

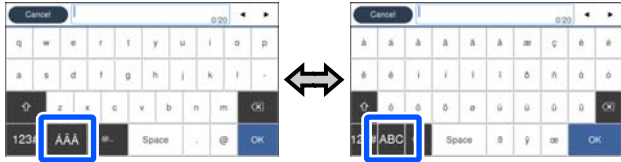

### Using the Menu

Settings item	Settings value	Explanation
<b>Custom Paper Setting</b> (Touching any of registry number 01 to 10 will display settings items.)		
Change Name		Register and change the name of the custom paper settings. The name registered here is displayed in the <b>Paper Type</b> list.  Touch this to display the keypad screen. Up to 20 characters may be input for the name. The keypad screen can be switched as shown below with the button marked.
		
Touch the icons at bottom left to switch between input methods. ABC: Enters alphabet letters. 123#: Enters numbers and symbols.  To change the key layout of the full keyboard, use <b>Keyboard</b> in the Basic Settings menu. <a href="#">🔗 "General Settings - Basic Settings" on page 140</a>		
Change Reference Paper	Plain paper *	You can select the media type that is the closest to the paper you are using.
	Matte Paper	
	Photo Paper	
	CAD	
	Others	
<b>Advanced Media Setting</b>		
Platen Gap	1.2	This is the Platen Gap (distance between print head and paper) for the paper selected in <b>Change Reference Paper</b> , so it does not normally need to be changed. Change this to a setting that will widen the gap (a higher value) if print results are smeared.
	1.6	
	2.1	
Top/Bottom Margins	Standard *	Setting this to Standard will set the top/bottom margins as follows depending on the printer driver print targets.  <input type="checkbox"/> CAD/Line Drawing: 3 mm/3 mm <input type="checkbox"/> Other: 30 mm/30 mm  Left and right margins will remain at 3 mm regardless of settings. If there is any soiling on the top section of the print results, increase the top margin.  <a href="#">🔗 "Printable area" on page 223</a>
	Top 3 mm/Bottom 3 mm	
	Top 15 mm/Bottom 15 mm	
	Top 35 mm/Bottom 15 mm	

### Using the Menu

Settings item	Settings value	Explanation
Paper Suction	-4 to +3	It is important to choose the appropriate amount of suction for the paper used in order to maintain the correct distance between the paper and print head. Choosing too high a value for thin or soft paper will increase the distance between the paper and print head too much, causing print quality to decline or preventing the paper feeding correctly. In such cases, you will need to lower the paper suction. The lower the setting value, the weaker the suction power.
Back Tension	Auto *	<p>If there is any wrinkling on the paper during printing, select <b>High</b> or <b>Extra High</b>.</p> <p>When this is set to <b>Extra High</b>, the following setting is enabled.</p> <p><b>Settings - General Settings - Printer Settings - Paper Source Settings - Roll Paper Setup - Back Tension 2</b></p>
	Standard	
	High	
	Extra High	
Drying Time		
Drying Time per Pass	0.0 to 10.0 seconds (0.0*)	Select the time the print head pauses to allow drying after each pass. Choose from values between 0.0 and 10.0 seconds Depending on the paper type, the ink may take a while to dry. If the ink blurs on the paper, set a longer time for drying the ink. Increasing the drying time increases the time needed to print.
Drying Time per Page	0.0 to 60 minutes (0.0*)	Specify how long the printer pauses to allow the ink to dry after printing each page; choose from values between 0 and 60 minutes. Depending on the ink density or paper type, the ink may take a while to dry. If the ink blurs on the paper, set a longer time for drying the ink. The longer the drying time, the more time required for printing.
Paper Size Check	On *	<p>Select whether to detect (On) or not detect (Off) the paper width when paper is loaded. Try choosing Off if a paper setting error is displayed even though the paper is correctly loaded. Note, however, that the printer may print outside the paper when Off is selected. If it prints beyond the edges of the paper, the inside of the printer becomes dirty with ink. We generally recommend using the printer with this set to On.</p> <p>The changes are applied after the paper is reloaded. Note that they are not applied if you just change the menu items.</p>
	Off	
Auto Cut	On *	<p>Select whether to automatically cut (On) or not cut (Off) using the built-in cutter as each page is printed on roll paper. Set On to automatically cut the edge if it is not a horizontal cut when paper is loaded.</p> <p>The setting selected with the printer driver takes priority when the printer driver is used.</p> <p> <a href="#">"Cutting the Roll Paper" on page 36</a></p>
	Off	
Remove Skew	On *	Select whether to enable (On) or disable (Off) paper skew reduction.
	Off	
Restore Default		Restore the selected Custom Paper settings to default settings.
Printing Language		

### Using the Menu

Settings item	Settings value	Explanation
USB	Auto *	Normally, leave the setting as Auto. If HP-GL/2 or HP RTL print data is sent from a CAD application or plotter, this is automatically determined, and switched to HP-GL/2 mode. If HP-GL/2 mode printing is not carried out normally, or if normally printing in HP-GL/2 or HP RTL, set as <b>HP-GL/2</b> .
	HP-GL/2	
Network	Auto *	
	HP-GL/2	

Using the Menu

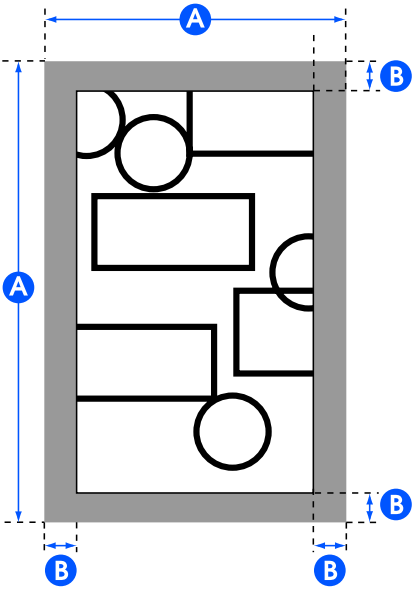
Settings item	Settings value	Explanation
Universal Print Settings		
Paper Source	Roll Paper *	Select the paper source. If the paper is not loaded as in the set paper source, then an error will occur during printing.
	Cut Sheet (1 sheet)	
Quality	Standard *	Select the print quality. <b>Standard</b> will print with the quality mode appropriate for the Paper Type setting for the paper selected in <b>Paper Source</b> .
	Speed	
	Fine	
	Super Fine	
	Draft	
Color Mode	Color *	Specify whether to print in color or switch to black and white and then print.
	Black/White	
Page Margins option	Clip By Margins *	<p>Depending on the base output size setting, adds the value selected for the page margin (area of <b>B</b> in the following illustration) inside the hard clip area of the PS command of the data or the size selected for base output size (area of <b>A</b> in the following illustration). When there is a print object in the margin section, it is clipped and not printed.</p> 

Using the Menu

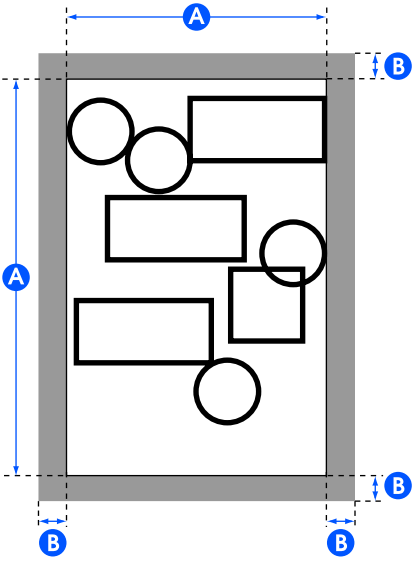
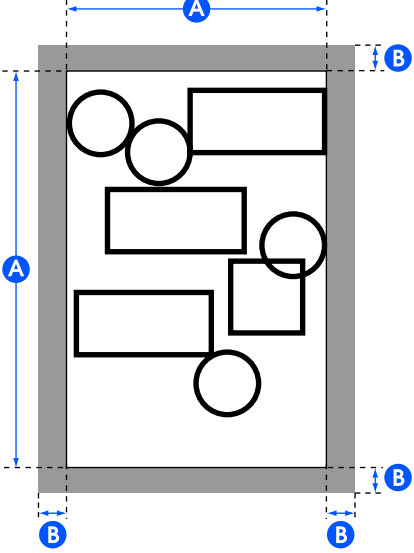
Settings item	Settings value	Explanation
	Oversize	<p>The position at which the margin is added depends on the base output size setting, as shown below.</p> <ul style="list-style-type: none"> <li> <input type="checkbox"/> When set to Auto                      Adds the value selected for page margin (area of <b>B</b> in the following illustration) outside the hard clip area of the PS command of the data (area of <b>A</b> in the following illustration).                 </li> </ul>  <ul style="list-style-type: none"> <li> <input type="checkbox"/> When set to a standard size or user defined size                      Adds the value selected for page margin (area of <b>B</b> in the following illustration) outside the size selected for base output size (area of <b>A</b> in the following illustration). With the actual output size, the margin section becomes larger than the selected size (the area of <b>A</b> in the following illustration).                 </li> </ul> 

Using the Menu

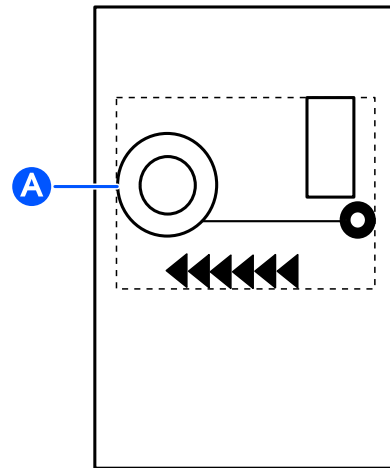

Settings item	Settings value	Explanation
Page Margin	3 mm *	Select the top, bottom, left, and right margin values.
	5 mm	For a cut sheet, the top, bottom, left, and right margin values are 3 mm regardless of the settings.
Smoothing	On	This setting is enabled when <b>Resolution</b> is set to <b>Standard</b> and there is no resolution specification in the sent print data. Setting this to <b>On</b> will print at the maximum resolution corresponding to the Paper Type setting for the paper selected in <b>Paper Source</b> , but depending on the data, this may result in a long print time, or failures in printing because of insufficient memory.
	Off *	
Base Output Size	Auto *	The hard clip area of the PS command of the data becomes the base output size. The actual output size depends on the Page Margins option. When the data does not contain a PS command, the smallest rectangle area <b>A</b> of in the following illustration including the print object becomes the base output size.
	A Series	The compatible standard sizes for the selected <b>Paper Source</b> are displayed, therefore select the Base Output Size. The actual output size depends on the Page Margins option. For a cut sheet, this setting is available only when the data does not contain a PS command. If the data contains a PS command, this setting is not available, and the hard clip area of the PS command becomes the Base Output Size.
	US-ANSI	
	US-ARCH	
	B Series (ISO)	
	B Series (JIS)	
	Others	
User-Defined	Select this option when outputting at non-standard sizes. After selecting this setting, set Paper Width and Paper Height. You can set in 0.1 mm increments.  The actual output size depends on the Page Margins option.	
Resolution	Standard *	This setting is enabled when the resolution is not specified in the sent print data. <b>Standard</b> will print at the resolution corresponding to the Paper Type setting for the paper selected in <b>Paper Source</b> and the <b>Quality</b> setting.
	300dpi	
	600dpi	
	1200dpi	

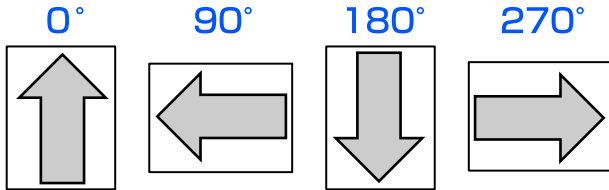
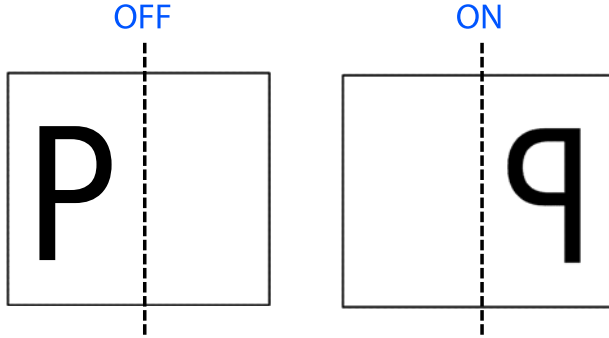

### Using the Menu

Settings item	Settings value	Explanation
Color Mode (Common)	EPSON Standard (sRGB)	Optimize the sRGB space and correct the color.
	Business Graphics *	Perform color correction to sharpen your images based on the sRGB space.
	GIS	Perform color correction suitable for when printing GIS (Geographic Information System) topographical maps or similar.
	Line Drawing	Perform color correction suitable for CAD drawings and other line drawings.
	Off (No Color Management)	Do not perform color correction.
<b>HP-GL/2 Unique Settings</b> (Print settings inherent to HP-GL/2 or HP RTL modes.)		
Rotate	0°	You can rotate the coordinates of the drawn data counterclockwise in units of 90° before printing. Note that objects drawn by RTL are not rotated. When both this setting and the RO command specify rotation, rotation is performed using the combined amount of both values. Note that rotation by the RO command is for objects only (the arrow section in the following illustration), and rotation is not performed for the drawn area (the square section in the following illustration). As a result, objects in a section that protrude from the drawn area are not printed.
	90°	
	180°	
	270°	
		
Origin Setup	Left Edge *	Set the data coordinate origin.
	Center	
Mirror Image	On	Select whether to flip horizontally (mirror) using the center of the output size width as the basis line and then print (On) or print without flipping horizontally (Off).
	Off *	
		
If an angle is specified for rotate, the rotated result is flipped horizontally.		

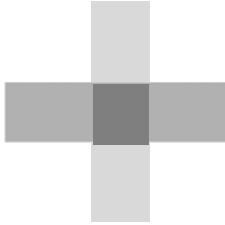
### Using the Menu

Settings item	Settings value	Explanation
Line Merge	On	Select whether to merge the intersection of the overlapping lines within the image according to the MC command of the data (On), or move lines to be printed later to the front at intersections (Off).  <div style="display: flex; justify-content: space-around; align-items: center;"> <div style="text-align: center;"> <p><b>ON</b></p>  </div> <div style="text-align: center;"> <p><b>OFF</b></p>  </div> </div>
	Off *	
Color Mode (HP-GL/2)	EPSON Standard (sRGB)	Optimize the sRGB space and correct the color.
	Business Graphics	Perform color correction to sharpen your images based on the sRGB space.
	GIS	Perform color correction suitable for when printing GIS (Geographic Information System) topographical maps or similar.
	Line Drawing *	Perform color correction suitable for CAD drawings and other line drawings.
	Off (No Color Management)	Do not perform color correction.
Select Palette	Software *	From the following selections, choose the palette that specifies the color and thickness of the logical pen.  <input type="checkbox"/> Software: Print according to the pen configuration set in the application, and ignore the built-in palette of the printer.  <input type="checkbox"/> Default: Print according to the settings of the built-in palette of the printer specified in advance. The settings of the palette cannot be changed. The built-in palette specifies a logical pen with a pen width of 0.35 mm and 256 colors.  <input type="checkbox"/> Palette A / Palette B: Print according to the settings of the built-in palette that you specified for Define Palette. If Define Palette setting is not set, the results are the same as when Default is selected.  When Default / Palette A / Palette B are set, the pen configuration set in the application is ignored. Selected palette settings can be printed with <b>Print Color Palette</b> and confirmed.
	Default	
	Palette A	
	Palette B	
Print Color Palette	Print	Settings of the palette selected in <b>Select Palette</b> are printed as A3 size. You can check the colors corresponding to the color number for the pen colors.
Define Palette		
Palette A		
Pen 0 to Pen 15		
Pen Width	0.13 to 12.00 mm	In <b>Select Palette</b> , selecting <b>Palette A</b> will print in accordance with the settings defined here. You can define a unique built-in palette by specifying the pen width and color for the 16 types of logical pen. Select the pen number, and then define the pen width and pen color for each pen. You can use <b>Print Color Palette</b> to print and check the colors corresponding to the color number for the pen colors.
Pen Color	0 to 255	



## Using the Menu

Settings item	Settings value	Explanation
Palette B		
Pen 0 to Pen 15		
Pen Width	0.13 to 12.00 mm	In <b>Select Palette</b> , selecting <b>Palette B</b> will print in accordance with the settings defined here. Settings details are the same as for Palette A.
Pen Color	0 to 255	
Restore default HP-GL/2 Unique Settings	No	Select <b>Yes</b> to restore all HP-GL/2 Unique Settings settings to the default settings.
	Yes	
Memory Device Interface	Enable *	Select whether to permit (Enable) or not permit (Disable) connecting a USB flash memory to the printer and then directly printing the data in the memory.
	Disable	
Thick Paper	Off *	If the paper is thick, the print head may scuff the print surface. Choose <b>On</b> to prevent scuffing. If <b>On</b> is set, the platen gap, which is the distance between the print head and paper, will widen. However, if the platen gap is already at its maximum, then setting this to <b>On</b> will have no effect.
	On	
Self Check and Cleaning	Off	Self Check and Cleaning is a function to automatically perform a print head clogging check and perform cleaning if there is clogging at times such as when the power is turned on or before starting printing. Select the number of times to perform automatic cleaning when there is clogging. If <b>Off</b> is selected, both the check and cleaning will not be performed.
	Once *	
	Twice	
	Three times	
Bidirectional	On *	Setting this to <b>On</b> will cause the print head to print while moving both left and right. Setting this to <b>Off</b> will reduce the ruled line misalignment, but printing will take more time.
	Off	
PC Connection via USB	Enable *	Setting this to <b>Enable</b> allows access from a USB-connected computer. Setting this to <b>Disable</b> does not allow access.
	Disable	
USB I/F Timeout Setting	0 sec, or 5 to 300 sec (60*)	If printing stops mid-way when the printer and computer are connected by a USB cable, set a longer time.



## Using the Menu

## General Settings - Network Settings

\*Default setting

Settings item	Settings value	Explanation
Wi-Fi Setup		
Router (Connect via Wi-Fi)		<p><b>Disconnected or disabled</b></p> <p>This is displayed in gray. Touch this, and on the next screen touching <b>Start Setup</b> will display a <b>Wi-Fi Setup Wizard</b> menu, performing a connection operation.</p> <p><b>Connected</b></p> <p>Touch to display the connection status and settings information. Touch <b>Change Settings</b> to display <b>Wi-Fi Setup Wizard</b> and other menus, where you can switch the access point.</p> <p> <a href="#">"Switching to Wireless LAN" on page 30</a></p>
Wi-Fi Setup Wizard		The list of SSIDs for the detected access points is displayed. From the list, select the SSID to connect to, and connect.
Push Button Setup(WPS)		If the access point to use supports WPS (Wi-Fi Protected Setup), then this menu item can be used for connection. Input of SSID and password is not required. After selecting this menu item, touch and hold the push button on the access point until it flashes, then again touch <b>Start Setup</b> on the printer screen to connect.
Others		
PIN Code Setup(WPS)		If the access point to use supports WPS (Wi-Fi Protected Setup), then this menu item can be used for connection. Touch this to display the PIN code and <b>Start Setup</b> . Input the displayed PIN code from a computer into the access point within 2 minutes, then touch <b>Start Setup</b> to connect.
Wi-Fi Auto Connect		The menu used after installing software from the Software Disc, and connecting to the printer by following the wizard.
Disable Wi-Fi		Selecting this means that the wireless LAN connection will be initialized and disconnected. In the event of problems with the wireless LAN connection, use this menu to reconnect and attempt to resolve the problem.

### Using the Menu

Settings item	Settings value	Explanation
Wi-Fi Direct		<p><b>Disconnected or disabled</b></p> <p>This is displayed in gray. Touch this, and on the next screen touching <b>Start Setup</b> will display <b>Start Setup</b>. Touch <b>Start Setup</b> to enable Wi-Fi Direct, and display the SSID and password of the printer.</p> <p><b>Connected</b></p> <p>Touch to display the printer SSID and password, as well as the number of connected devices. Touch <b>Change Settings</b> to display <b>Change Password</b> and other menus.</p> <p> <a href="#">"Directly Connection Wirelessly (Wi-Fi Direct)" on page 31</a></p>
	Change Password	You can change the Wi-Fi Direct password. Changing the password will disconnect all connected computers and smart devices.
	Disable Wi-Fi Direct	Performing this operation will disconnect all connected computers and smart devices. To disconnect only a specific device, disconnect the connection from the device.
	Delete Registered Device	<p>Android smart device menu item.</p> <p>When using the Wi-Fi Direct function on an Android smart device to connect to the printer, a screen upon which to select whether to approve or refuse this connection will be displayed on the printer. If refuse is selected, then subsequent connection with this device will not be possible. To connect with devices for which connection has been refused, open this menu, and delete registered device information.</p>
Wired LAN Setup		<p>Touch to change a wireless LAN connection to a wired LAN connection. Touch <b>Start Setup</b> to disable the wireless LAN connection.</p> <p> <a href="#">"Switching to Wired LAN" on page 30</a></p>
Network Status		
	Wired LAN/Wi-Fi Status	Display current communications status and connection settings such as IP address, etc.
	Wi-Fi Direct Status	Display number of connected devices and connection settings such as SSID.
	Email Server Status (SC-T5400M Series Only)	The current method of authentication and authenticated accounts are displayed. The settings also can be changed.
	Print Status Sheet	Print current network connection detailed information.
Connection Check		Confirm the network status of the printer, and print a network connection check report. In the event of problems, respond in accordance with the diagnostics results.
Advanced		



### Using the Menu

Settings item	Settings value	Explanation
Device Name		Set the name of the printer to use on the network.
TCP/IP	Auto *	Automatically assign the printer IP address using DHCP functionality in the router.
	Manual	Select this to manually assign a fixed IP address, then input the IP address, subnet mask, and other required information. For details, see the <i>Administrator's Guide</i> .
Proxy Server	Use	When using a proxy server to directly connect from the intranet to the Internet so that the printer may directly access the Internet for firmware updates or similar, select <b>Use</b> , and set the server name and port number.
	Do Not Use *	
Email Server (SC-T5400M Series Only)		The details are the same as displayed in <b>General Settings - Scan Settings - Email Server</b> .
Shared Folder (SC-T5400M Series Only)		Used when you want to print from a folder. You must set up a shared folder before printing from a folder.  <a href="#">"Printing Files from a Shared Folder (Print from Folder) (SC-T5400M Series Only)" on page 98</a>
IPv6 Address	Enable *	Select whether to enable or disable the IPv6 function.
	Disable	
Link Speed & Duplex	Auto *	Normally, set this to <b>Auto</b> .
	10BASE-T Half Duplex	
	10BASE-T Full Duplex	
	100BASE-TX Half Duplex	
	100BASE-TX Full Duplex	
Redirect HTTP to HTTPS	Enable *	Select whether to enable or disable the function to auto-redirect HTTP to HTTPS.
	Disable	
Disable IPsec/IP Filtering	Enable	To enable IPsec/IP filtering functionality, use Web Config. For details, see the <i>Administrator's Guide</i> .
	Disable *	
Disable IEEE802.1X	Enable	To enable IEEE802.1X functionality, use Web Config. For details, see the <i>Administrator's Guide</i> .
	Disable *	
iBeacon Transmission (SC-T5400M Series Only)	Enable *	Set whether to enable or disable iBeacon Transmission. Set to enable to be able to search from iBeacon-compatible devices.
	Disable	

### General Settings - Scan Settings (SC-T5400M Series Only)

\*Default setting

## Using the Menu

Settings item	Settings value	Explanation
Confirm Recipient	On	Set to <b>On</b> to be able to check the recipients before scanning the original.
	Off*	
Email Server		
Server Settings	Off	Select this when not setting an email server.
	POP before SMTP	Authenticates on the POP3 server (receiving mail server) before sending the email. When you select this item, set the POP3 server.
	SMTP-AUTH	Authenticates on the SMTP server (outgoing mail server) when sending the email. The mail server needs to support SMTP authentication.
Connection Check		Able to check the connection with the email server.
Scan Options		
Confirm Before Ejecting Scanned Document	On*	Set to <b>On</b> to keep the original at the paper eject slot after it is scanned and display the removal confirmation screen. If you want to eject the original right after scanning it, set this to <b>Off</b> .
	Off	
Correct Skewed Image	On*	Automatically corrects a scanned image that is skewed, and then saves it. The range of correction is from the origin to a width of 914.4 mm.  Enable this only if the <b>Original Size</b> or <b>Scan Size</b> has been set to <b>Auto Detect</b> .
	Off	
Document Feed Adjustment	-1.00 to 1.00 (0*)	If the length of the original and the print results of the copied or scanned files do not match, adjust the document feeding. If you want to shorten the length of the print out, press the minus button. If you want to lengthen it, press the plus button. Differences in length may occur due to the type of paper used for printing.   <a href="#">"Paper Feed Adjust (Auto)" on page 47</a>
Image Stitching Adjustment	-5 to 5 (0*)	Correct the position for image stitching if the scanned results are misaligned.   <a href="#">"Image Stitching Adjustment" on page 212</a>

Using the Menu

General Settings - System Administration

\*Default setting

Settings item	Settings value	Explanation
Contacts Manager (SC-T5400M Series Only)		
Register/Delete		Register or delete addresses that are used in Scan to Email and Scan to Network Folder/FTP.
Frequent		
Email		Register frequently used addresses for each item to be able to access them easily. You can also change the order of the addresses.
Network Folder/FTP		
Print Contacts		
List of all Contacts		Print the email addresses of your contacts.
List of Email Contacts		
List of Folder/FTP Contacts		
View Options	Tile View *	Change how to view your contacts.
	List View	
Search Options	Begins with *	Change how to search for contacts.
	Ends with	
	Includes	
Security Settings		
Restrictions (SC-T5400M Series Only)		
Access to Register/Delete Contacts	Off *	Administrators can be permitted individually to view and change settings.
	On	
Access to Recent of Scan to Email	Off	
	On *	
Access to Show Sent History of Scan to Email	Off	
	On *	
Access to Language	Off	
	On *	
Access to Thick Paper	On *	
	On	





### Using the Menu

Settings item	Settings value	Explanation
Protection of Personal Data	Off*	
	On	
Access Control (SC-T5400M Series Only)	Off*	<p>With Access Control, you can control the functions that users can use by linking the functions to the accounts registered to the users on the printer. If administrators want to restrict users, set this to <b>On</b>. User accounts must be created ahead of time.</p> <p>Do the settings for creating user accounts in Web Config. See the <i>Administrator's Guide</i> for more details.</p>
	On	
Admin Settings		
Admin Password	Register	<p>When using the Lock Setting function, touch <b>Register</b> and set the administrator password. If changing a password that has already been set, touch <b>Change</b> and set the new password.</p> <p>Set the password and set <b>Lock Setting</b> to <b>On</b> to ask for input of a password when displaying specific settings menus such as network configuration.</p> <p>These menus will only be displayed if the correct password is entered, preventing non-administrators from accidentally changing settings.</p> <p>Keep the password in a safe place.</p> <p>Should you forget the password, contact your dealer or Epson Support.</p>
	Change	
	Clear All Settings	
Lock Setting	Off*	<p>Setting <b>On</b> will result in the administrator password being requested when any of the following menu items are selected, and unless the password is entered, changing the setting or running the function will not be possible. When selecting On, first set the Admin Password.</p> <ul style="list-style-type: none"> <li><input type="checkbox"/> Sleep Timer</li> <li><input type="checkbox"/> Power Off Timer</li> <li><input type="checkbox"/> Circuit Breaker Interlock Startup</li> <li><input type="checkbox"/> Date/Time Settings</li> <li><input type="checkbox"/> Operation Time Out</li> <li><input type="checkbox"/> Printing Language</li> <li><input type="checkbox"/> Universal Print Settings</li> <li><input type="checkbox"/> Memory Device Interface</li> <li><input type="checkbox"/> Self Check and Cleaning</li> <li><input type="checkbox"/> PC Connection via USB</li> <li><input type="checkbox"/> USB I/F Timeout Setting</li> <li><input type="checkbox"/> Network Settings</li> <li><input type="checkbox"/> Powerful Cleaning</li> <li><input type="checkbox"/> Discharging/Charging Ink</li> </ul>
	On	
Restore Default Settings		

## Using the Menu

Settings item	Settings value	Explanation
all Wi-Fi/network settings	Yes	Touch <b>Yes</b> to restore all Wi-Fi/network settings to the default settings.
	No	
Copy Settings	Yes	Touch <b>Yes</b> to restore Copy Settings to the default settings.
	No	
Scan Settings	Yes	Touch <b>Yes</b> to restore Scan Settings to the default settings.
	No	
Clear All Data and Settings	Yes	Touch <b>Yes</b> to restore all settings with the exception of Date/Time Settings, Length Unit, and Language in the Settings menu to the default settings.
	No	
Firmware Update		
Update		<p>Using this function requires that the printer be connected to a network that can be connected to the Internet. Touch <b>Start Checking</b> to access the Epson website, and to start a search for new firmware. If there is a display indicating that there is new firmware, then follow the on-screen instructions to update the firmware.</p> <p>Updating firmware takes approximately 5 minutes. However, this may take longer depending on the network environment.</p> <p>During update, do not turn off the printer or unplug the power cable from the outlet. Failure to observe this precaution could lead to damage.</p>
Notification	Off*	Set <b>On</b> to automatically check periodically for new firmware. If new firmware is found, a message will be displayed when the power is turned on.
	On	

## Maintenance

Settings item	Settings value	Explanation
Print Quality Adjustment	Start	<p>Perform the same adjustment as in <b>Media Adjust</b> in the Paper Setting menu. When carrying out this action from this menu, select the paper source from the first screen.</p> <p> <a href="#">"Optimizing Paper Settings (Media Adjust)" on page 46</a></p>
Print Head Nozzle Check	Start	<p>Check for clogged nozzles by printing a check pattern.</p> <p> <a href="#">"When you want to unclog the print head" on page 196</a></p>
Head Cleaning	Start	<p>Perform if the printed check pattern has faint or missing areas.</p> <p> <a href="#">"When you want to unclog the print head" on page 196</a></p>
Ink Cartridge(s) Replacement	Display procedure	<p>Select when replacing an ink cartridge while confirming the procedure. If you are familiar with replacement and do not need to confirm the procedure, you can replace the ink cartridge without selecting this menu item.</p> <p> <a href="#">"Replacing Ink Cartridges" on page 183</a></p>



## Using the Menu

Settings item	Settings value	Explanation
Replace Maintenance Box	Display procedure	Select when replacing the Maintenance Box while confirming the procedure. If you are familiar with replacement and do not need to confirm the procedure, you can replace the Maintenance Box without selecting this menu item. <a href="#">☞ "Replacing Maintenance Box" on page 185</a>
Replace Cutter	Start	Select to replace the cutter if the paper is not cut cleanly. Follow the on-screen instructions to replace. <a href="#">☞ "Replacing the Cutter" on page 186</a>
Powerful Cleaning	Start	Check the remaining amounts of ink cartridges and the amount of empty space in the Maintenance Box and provide new ink cartridges and Maintenance Box in advance if they are low.  If the nozzles are still clogged after performing this, turn off the printer and leave it overnight or longer. When left for some time, the clogged ink may dissolve.  If the nozzles are still clogged, contact your dealer or Epson Support.
Discharging/Charging Ink	Start	The print head may fail if the environmental temperature becomes -10°C or lower. Perform this action if you expect to be transporting/storing the printer in an environment of -10°C or less.  Touch <b>Start</b> , and follow the on-screen instructions to discharge the ink.  When operations are complete, the power turns off automatically. <a href="#">☞ "Handling if Transporting/Leaving the Printer in an Environment of -10°C or Less" on page 226</a>

## Printer Status/Print

Settings item	Settings value	Explanation
Print Status Sheet		
	Configuration Status Sheet	Print a list of current printer settings. Use this to view all information at a glance.
Network		Display current network settings details. Displayed details are the same as displayed in <b>General Settings - Network Settings - Network Status</b> .

## Using the Menu

## Enlarged Copy menu (SC-T5400 Series/SC-T3400 Series/SC-T3400N Series Only)

Displayed when an Epson A3 or A4 scanner is connected to the printer. Set scaling in this menu to enable enlarged printing of the scanned documents.

 [“Making Enlarged Copies with an A3 or A4 Scanner \(SC-T5400 Series/SC-T3400 Series/SC-T3400N Series Only\)” on page 108](#)

\*Default setting

Settings item	Settings value	Explanation
Copies	1 to 99	Specify the number of copies.
Color Mode	Black/White	Choose whether to do enlarged copying in color or in black and white.
	Color *	
Document Size	A4 A5 A3 B5 B4 Letter 13 x 18 cm (5 x 7 in)	Select the document size loaded on the scanner. The sizes available vary with the scanner. Sizes other than those shown here cannot be used.
Reduce/Enlarge		
Auto Fit Page	On *	Set <b>On</b> to enlarge the copy so that the short edge of the document fits the width of the roll paper currently loaded in the printer.  If the short edge of the document is wider than the roll paper, this will be printed at actual size.  If the printer is unable to detect the width of the roll paper, then an error will occur when copying is started.
	Off	
Custom Size	Actual Size A0 US E (34x44in) JIS B1 A1 US D (22x34in) JIS B2 US C (17x22in) A2 User-Defined	Select the output size. To the left of each size, the percentage of enlargement of the selected document size is displayed.  A0, US E, and B1 are displayed only for SC-T5400 Series.  If the desired size is not in the list, set the desired size in <b>User-Defined</b> .
Density	-4 to 4 (0*)	Choose copy density.

**Using the Menu**

Settings item	Settings value	Explanation
Quality	Speed	Choose Copy Quality in view of image quality and print speed.
	Fine	

Using the Menu

# Memory Device menu

Displayed when a USB flash memory is connected to the printer. JPEG files and TIFF files stored on the memory can be printed directly from the printer.

 [“Direct Printing of Files on USB Flash Memory” on page 99](#)

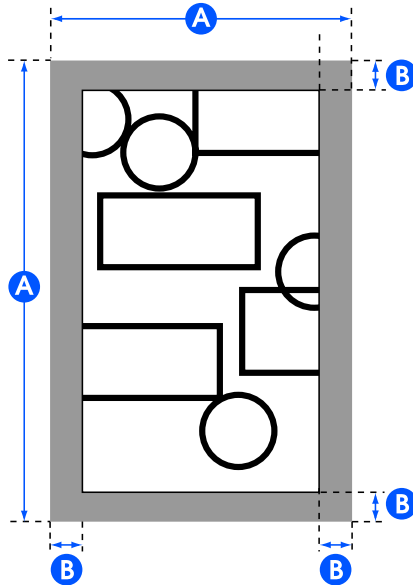
Settings item	Settings value	Explanation
Basic Settings		
Copies	1 to 99	Specify the number of copies.
Paper Source	Roll Paper *	Select the paper source. If the paper is not loaded as in the set paper source, then an error will occur during printing.
	Cut Sheet (1 sheet)	
Color Mode	Black/White	Select whether to print in color or black and white.
	Color *	
Advanced		
Quality	Speed *	Select the print quality.
	Fine	
	Super Fine	
Page Margins option	Clip By Margins *	<p>Add margins (areas of <b>B</b> in the following illustration) inside the output size (areas of <b>A</b> in the following illustration) set in the Reduce/Enlarge settings. When there is a print object in the margin section, it is clipped and not printed.</p> 

Using the Menu

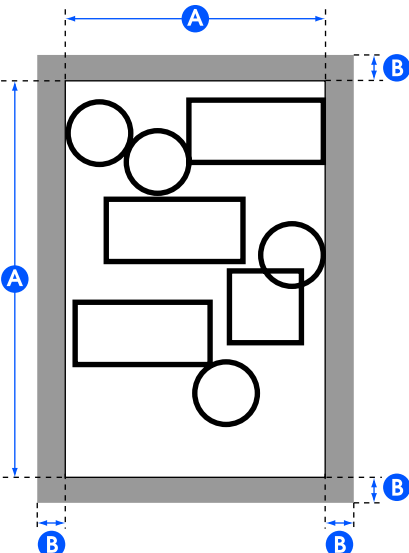
Settings item	Settings value	Explanation
	Oversize	<p>Add margins (areas of <b>B</b> in the following illustration) outside the output size (areas of <b>A</b> in the following illustration) set in the Reduce/Enlarge settings. With the actual output size, the margin sections become larger than the set output size (areas of <b>A</b> in the following illustration).</p> 
	Borderless	<p>This is enabled when <b>Roll Paper</b> is selected in <b>Paper Source</b>.</p> <p>The print data is enlarged slightly in respect to the output size set in Reduce/Enlarge to print so that margins do not appear inside the output size. However, if a custom size is set, a margin may appear on the right side depending on the data.</p> <p>When printing multiple pages with borderless printing on roll paper, you can select whether to insert a margin and cut twice between pages or cut once between pages in the following menu item.</p> <p><b>Settings - General Settings - Printer Settings - Paper Source Settings - Roll Paper Setup - Cut for Borderless Print</b></p>
Bidirectional	On *	<p>Setting this to <b>On</b> will cause the print head to print while moving both left and right. Setting this to <b>Off</b> will reduce the ruled line misalignment, but printing will take more time.</p>
	Off	
Color Mode (SC-T5400 Series/ SC-T3400 Series/ SC-T3400N Series On-ly)	EPSON Standard (sRGB)	Optimize the sRGB space and correct the color.
	Business Graphics *	Perform color correction to sharpen your images based on the sRGB space.
	GIS	Perform color correction suitable for when printing GIS (Geographic Information System) topographical maps or similar.
	Line Drawing	Perform color correction suitable for the data of CAD drawings and other line drawings.
	Off (No Color Management)	Do not perform color correction.

### Using the Menu

Settings item	Settings value	Explanation
Select Target (SC-T5400M Series Only)	Poster(Photo)/Perspective	Print posters and perspective drawings that use photos with their natural colors.
	Poster/Document *	Print posters that combine letters and illustrations with vivid colors.
	GIS	Print maps clearly.
	CAD/Line Drawing	Print letters and fine lines clearly.
	Off (No Color Management)	Do not perform color correction.
Reduce/Enlarge		
Auto Fit Page	On	Set <b>On</b> to print so that the short edge of the document fits the width of the paper loaded in the printer.
	Off	<p>If the short edge of the document is wider than the paper, printing will be at actual size.</p> <p>If paper is not loaded as set in Paper Source of Basic Settings, this cannot be set to <b>On</b>. Furthermore, if the Paper Source setting is changed without replacing or loading the paper after setting this to <b>On</b>, this setting is returned to Actual Size.</p> <p>If the printer is unable to detect the width of the paper, an error will occur when the Print button is touched.</p>
Custom Size	Actual Size *, A4, A3, Super A3, A2, Super A2, A1, Super A1, A0, Super A0, Letter, Legal, US B (11x17in), US C (17x22in), US D (22x34in), US E (34x44in), ARCH A (9x12in), ARCH B (12x18in), ARCH C (18x24in), ARCH D (24x36in), ARCH E1 (30x42in), ARCH E (36x48in), ISO B4, ISO B3, ISO B2, ISO B1, JIS B5, JIS B4, JIS B3, JIS B2, JIS B1, 24 x 30 in, 30 x 40 in, 36 x 44 in, 30 x 40 cm, 40 x 60 cm, 50 x 70 cm, 60 x 90 cm, 70 x 100 cm, User-Defined	<p>Select the output size. To the left of each size, the percentage of enlargement of the selected document size is displayed. If the desired size is not in the list, set the desired size in <b>User-Defined</b>.</p> <p>The following setting values are displayed only for SC-T5400 Series.                      A0, Super A0, US E, ARCH E1, ARCH E, ISO B1, JIS B1,                      762 x 1016 mm, 914 x 1118 mm, 70 x 100 cm</p>

## Using the Menu

## Copy menu (SC-T5400M Series Only)

\*Default setting

Settings item	Settings value	Explanation
Basic Settings		
Copies	1 to 99	Specify the number of copies.
Color Mode	Black/White	Select whether to copy in color or black and white.
	Color *	
Quality	Speed *	Select the print quality.
	Fine	
	Super Fine	
	Draft	
Density	-4 to 4 (0*)	Choose the density for the copy results. Negative values (-) are lighter and positive values (+) are darker.
Paper Source	Roll Paper *	Select the paper source for copying and printing.
	Cut Sheet (1 sheet)	
Reduce/Enlarge		
Auto Fit Page	On	Set to <b>On</b> to enlarge the copy so that the short edge of the original fits the width of the roll paper currently loaded in the printer.  If the short edge of the document is wider than the roll paper, this will be printed at actual size.  If the printer is unable to detect the width of the roll paper, then an error will occur when copying is started.
	Off *	
Custom Size	Actual Size, ISO A4->A0, ISO A3->A0, ISO A4->A1, ISO A2->A0, ISO A3->A1, ISO A1->A0, ISO A2->A1, ISO A0->A1, ISO A1->A2, ISO A0->A2, ISO A1->A3, ISO A0->A3, ISO A1->A4, ISO A0->A4, US ANSI/ ARCH A->E, US ANSI/ ARCH B->E, US ANSI/ ARCH A->D, US ANSI/ ARCH C->E, US ANSI/ ARCH B->D, US ANSI/ ARCH D->E, US ANSI/ ARCH C->D, US ANSI/ ARCH E->D, US ANSI/ ARCH D->C, US ANSI/ ARCH E->C, US ANSI/ ARCH D->B, US ANSI/ ARCH E->B, US ANSI/ ARCH D->A, US ANSI/ ARCH E->A	Select the output size.

Using the Menu

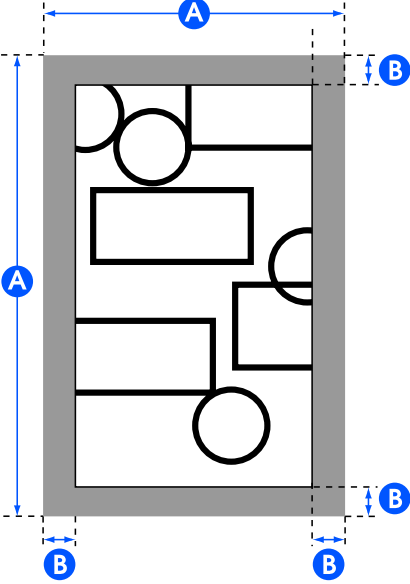
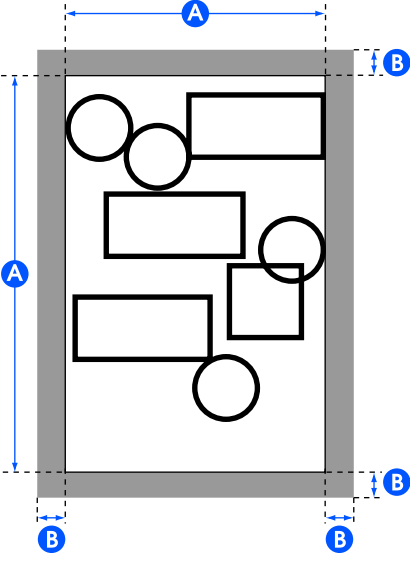
Settings item	Settings value	Explanation
Page Margins option	Clip By Margins *	<p>Add margins (areas of <b>B</b> in the following illustration) inside the output size (areas of <b>A</b> in the following illustration) set in the Reduce/Enlarge settings. When there is a print object in the margin section, it is clipped and not printed.</p> 
	Oversize	<p>Add margins (areas of <b>B</b> in the following illustration) outside the output size (areas of <b>A</b> in the following illustration) set in the Reduce/Enlarge settings. With the actual output size, the margin sections become larger than the set output size (areas of <b>A</b> in the following illustration).</p> 
	Borderless	<p>This is enabled when <b>Roll Paper</b> is selected in <b>Paper Source</b>.</p> <p>The print data is enlarged slightly in respect to the output size set in Reduce/Enlarge to print so that margins do not appear within the output size when copied. However, if a custom size is set, a margin may appear on the right side depending on the data.</p>

Advanced



## Using the Menu

Settings item	Settings value	Explanation
Original Type	Text & Image *	Select the type in accordance with the loaded original.
	Tracing Paper	
	Recycled	
	Blueprint	
	Blueprint Inverted	
	Watercolor Rendering	
Original Size		
Auto Detect	-	The default setting of <b>Auto Detect</b> is recommended in most situations. Note that, depending on the original, it may not be possible to detect the width correctly even when the setting is <b>Auto Detect</b> . Similarly, tracing paper and the optional carrier sheet are not detected automatically. In such cases, change from the standard size and specify a width of your choosing. If the desired size is not in the options, then select User-Defined, and enter the length and width of the original.
ISO A	Display supported sizes for originals	
US-ANSI		
US-ARCH		
JIS B		
ISO B		
User-Defined	Display the Original Size Input screen	
Top Offset	0.0 to 100.0mm (0.0*) 0.00 to 3.94inch (0.00*)	If you do not want to copy the top margin of the original, you can adjust the top, and then copy the original. Enter the value for the length from the top of where you want to start copying.  If the carrier sheet is loaded, set the value to 19 mm.
Image Quality		
Contrast	-4 to 4 (0*)	Set the contrast. Negative values (-) are weaker and positive values (+) are stronger.
Sharpness	-4 to 4 (0*)	Set the sharpness. Negative values (-) are weaker and positive values (+) are stronger.
Remove Background	-4 to 4 (0*)	Set the adjustment value for removing the background. Configure this setting when you are scanning originals with colors or originals that are thin or when removing unwanted backgrounds. Negative values (-) are weaker and positive values (+) are stronger.
Bidirectional	On *	Setting this to <b>On</b> causes the print head to print while moving both left and right. Setting this to <b>Off</b> reduces ruled line misalignment, but printing takes more time.
	Off	

## Using the Menu

Settings item	Settings value	Explanation
Color Mode	EPSON Standard (sRGB)	Optimize the sRGB space and correct the color.
	Business Graphics *	Perform color correction to sharpen your images based on the sRGB space.
	GIS	Perform color correction suitable for when printing GIS (Geographic Information System) topographical maps or similar.
	Line Drawing	Perform color correction suitable for the data of CAD drawings and other line drawings.
	Off (No Color Management)	Do not perform color correction.
Clear All Settings	Yes	Touch <b>Yes</b> to restore all Basic Settings and Advanced to the default settings.
	No	

## Using the Menu

**Scan menu (SC-T5400M Series Only)**

\*Default setting

Settings item	Settings value	Explanation
Network Folder/FTP		

### Using the Menu

Settings item	Settings value	Explanation
Destination	Display the Location Selection screen	Specify the location for the scanned image.  Specify the location from the recipients registered for frequent use or the recipients registered in your Contacts. If a recipient is not registered in your Contacts, touch <b>Keyboard</b> , and then edit the location.
Scan Settings		
Color Mode	Black/White	Select whether to scan in color or black and white.
	Color *	
File Format		
File Format	JPEG *	Select the file format in which to save the scanned image.
	PDF	
	PDF/A	
	TIFF (Multi Page)	
Compression Ratio	High Compression	Select the compression ratio for when you save the scanned image.
	Standard Compression *	
	Low Compression	
PDF Settings		
Document Open Password		Setting the file format to <b>PDF</b> allows you to set the security for the PDF.  Set Document Open Password when you create a PDF that requires a password to be opened. To create a PDF file for which a password is needed to print or edit, set the Permissions Password.
Password Setting	Off *	
	On	
Password	Enter password	
Permissions Password		
Password Setting	Off *	
	On	
Password	Enter password	
Printing	Allowed *	
	Not Allowed	
Editing	Allowed *	
	Not Allowed	
Resolution	200dpi	Select the resolution for scanning.
	300dpi *	
	400dpi	
	600dpi	

### Using the Menu

Settings item	Settings value	Explanation
Scan Size		
Auto Detect	-	The default setting of <b>Auto Detect</b> is recommended in most situations. Note that, depending on the original, it may not be possible to detect the width correctly even when the setting is <b>Auto Detect</b> . Similarly, tracing paper and the optional carrier sheet are not detected automatically. In such cases, change from the standard size and specify a width of your choosing. If the desired size is not in the options, then select User-Defined, and enter the length and width of the original.
ISO A	Display supported scan sizes	
US-ANSI		
US-ARCH		
JIS B		
ISO B		
User-Defined	Display the Scan Size Input screen	
Top Offset	0.0 to 100.0mm (0.0*) 0.00 to 3.94inch (0.00*)	If you do not want to scan the top margin of the original, you can adjust the top, and then scan. Enter the value for the length from the top of where you want to start scanning.  If the carrier sheet is loaded, set the value to 19 mm.
Original Type	Text & Image *	Select the type in accordance with the loaded original.
	Tracing Paper	
	Recycled	
	Blueprint	
	Blueprint Inverted	
	Watercolor Rendering	
Density	-4 to 4 (0*)	Select the density for scanning. Negative values (-) are lighter and positive values (+) are darker.
Image Quality		
Contrast	-4 to 4 (0*)	Set the contrast. Negative values (-) are weaker and positive values (+) are stronger.
Sharpness	-4 to 4 (0*)	Set the sharpness. Negative values (-) are weaker and positive values (+) are stronger.
Remove Back-ground	-4 to 4 (0*)	Set the adjustment value for removing the background. Configure this setting when you are scanning originals with colors or originals that are thin or when removing unwanted backgrounds. Negative values (-) are weaker and positive values (+) are stronger.
File Name		
Filename Pre-fix-4-4	Enter the filename prefix	Use single-byte alphanumeric characters or symbols to enter the prefix for the file name of the image.
Add Date	On *	Add the date to the file name.
	Off	
Add Time	On *	Add the time to the file name.
	Off	

### Using the Menu

Settings item	Settings value	Explanation
Clear All Settings	Yes	Touch <b>Yes</b> to restore all Scan Settings to the default settings.
	No	
Email		
Destination	Display the Location Selection screen	Specify the recipient of the scanned image. Specify a recipient from the recipients registered for frequent use or the recipients registered in your Contacts. If a recipient is not registered in your Contacts, touch <b>Keyboard</b> , and then enter the recipient.
Scan Settings		
Color Mode	Black/White	Select whether to scan in color or black and white.
	Color *	
File Format		
File Format	JPEG *	Select the file format in which to save the scanned image.
	PDF	
	PDF/A	
	TIFF (Multi Page)	
Compression Ratio	High Compression	Select the compression ratio for when you save the scanned image.
	Standard Compression *	
	Low Compression	
PDF Settings		
Document Open Password		Setting the file format to <b>PDF</b> allows you to set the security for the PDF. Set Document Open Password when you create a PDF that requires a password to be opened. To create a PDF file for which a password is needed to print or edit, set the Permissions Password.
Password Setting	Off *	
	On	
Password	Enter password	
Permissions Password		
Password Setting	Off *	
	On	
Password	Enter password	
Printing	Allowed *	
	Not Allowed	
Editing	Allowed *	
	Not Allowed	

### Using the Menu

Settings item	Settings value	Explanation
Resolution	200dpi	Select the resolution for scanning.
	300dpi *	
	400dpi	
	600dpi	
Scan Size		
Auto Detect	-	The default setting of <b>Auto Detect</b> is recommended in most situations. Note that, depending on the original, it may not be possible to detect the width correctly even when the setting is <b>Auto Detect</b> . Similarly, tracing paper and the optional carrier sheet are not detected automatically. In such cases, change from the standard size and specify a width of your choosing. If the desired size is not in the options, then select User-Defined, and enter the length and width of the original.
ISO A	Display supported scan sizes	
US-ANSI		
US-ARCH		
JIS B		
ISO B		
User-Defined	Display the Scan Size Input screen	
Top Offset	0.0 to 100.0mm (0.0*) 0.00 to 3.94inch (0.00*)	If you do not want to scan the top margin of the original, you can adjust the top, and then scan. Enter the value for the length from the top of where you want to start scanning.  If the carrier sheet is loaded, set the value to 19 mm.
Original Type	Text & Image *	Select the type in accordance with the loaded original.
	Tracing Paper	
	Recycled	
	Blueprint	
	Blueprint Inverted	
	Watercolor Rendering	
Density	-4 to 4 (0*)	Select the density for scanning. Negative values (-) are lighter and positive values (+) are darker.
Image Quality		
Contrast	-4 to 4 (0*)	Set the contrast. Negative values (-) are weaker and positive values (+) are stronger.
Sharpness	-4 to 4 (0*)	Set the sharpness. Negative values (-) are weaker and positive values (+) are stronger.
Remove Background	-4 to 4 (0*)	Set the adjustment value for removing the background. Configure this setting when you are scanning originals with colors or originals that are thin or when removing unwanted backgrounds. Negative values (-) are weaker and positive values (+) are stronger.

### Using the Menu

Settings item	Settings value	Explanation
Subject	Enter subject	Use single-byte alphanumeric characters or symbols to enter the subject of the email.
Attached File Max Size	1MB	Select a maximum size for files that are attached to emails.
	2MB	
	5MB	
	10MB	
	20MB	
	30MB *	
File Name		
Filename Prefix	Enter the filename prefix	Use single-byte alphanumeric characters or symbols to enter the prefix for the file name of the image.
Add Date	On *	Add the date to the file name.
	Off	
Add Time	On *	Add the time to the file name.
	Off	
Clear All Settings	Yes	Touch <b>Yes</b> to restore all Scan Settings to the default settings.
	No	
Memory Device		
Basic Settings		
Color Mode	Black/White	Select whether to scan in color or black and white.
	Color *	
File Format		
File Format	JPEG *	Select the file format in which to save the scanned image.
	PDF	
	PDF/A	
	TIFF (Multi Page)	
Compression Ratio	High Compression	Select the compression ratio for when you save the scanned image.
	Standard Compression *	
	Low Compression	



### Using the Menu

Settings item	Settings value	Explanation
PDF Settings		
Document Open Password		Setting the file format to <b>PDF</b> allows you to set the security for the PDF.  Set Document Open Password when you create a PDF that requires a password to be opened. To create a PDF file for which a password is needed to print or edit, set the Permissions Password.
Password Setting	Off *	
	On	
Password	Enter password	
Permissions Password		
Password Setting	Off *	
	On	
Password	Enter password	
Printing	Allowed *	
	Not Allowed	
Editing	Allowed *	
	Not Allowed	
Resolution	200dpi	Select the resolution for scanning.
	300dpi *	
	400dpi	
	600dpi	
Scan Size		
Auto Detect	-	The default setting of <b>Auto Detect</b> is recommended in most situations. Note that, depending on the original, it may not be possible to detect the width correctly even when the setting is <b>Auto Detect</b> . Similarly, tracing paper and the optional carrier sheet are not detected automatically. In such cases, change from the standard size and specify a width of your choosing. If the desired size is not in the options, then select User-Defined, and enter the length and width of the original.
ISO A	Display supported scan sizes	
US-ANSI		
US-ARCH		
JIS B		
ISO B		
User-Defined	Display the Scan Size Input screen	
Top Offset	0.0 to 100.0mm (0.0*)	If you do not want to scan the top margin of the original, you can adjust the top, and then scan. Enter the value for the length from the top of where you want to start scanning.  If the carrier sheet is loaded, set the value to 19 mm.
	0.00 to 3.94inch (0.00*)	

### Using the Menu

Settings item	Settings value	Explanation
Original Type	Text & Image *	Select the type in accordance with the loaded original.
	Tracing Paper	
	Recycled	
	Blueprint	
	Blueprint Inverted	
	Watercolor Rendering	
Advanced		
Density	-4 to 4 (0*)	Select the density for scanning. Negative values (-) are lighter and positive values (+) are darker.
Image Quality		
Contrast	-4 to 4 (0*)	Set the contrast. Negative values (-) are weaker and positive values (+) are stronger.
Sharpness	-4 to 4 (0*)	Set the sharpness. Negative values (-) are weaker and positive values (+) are stronger.
Remove Back-ground	-4 to 4 (0*)	Set the adjustment value for removing the background. Configure this setting when you are scanning originals with colors or originals that are thin or when removing unwanted backgrounds. Negative values (-) are weaker and positive values (+) are stronger.
File Name		
Filename Prefix	Enter the filename prefix	Use single-byte alphanumeric characters or symbols to enter the prefix for the file name of the image.
Add Date	On *	Add the date to the file name.
	Off	
Add Time	On *	Add the time to the file name.
	Off	
Clear All Settings	Yes	Touch <b>Yes</b> to restore all Basic Settings and Advanced to the default settings.
	No	

Using the Menu

# Network Folder menu (SC-T5400M Series Only)

\*Default setting

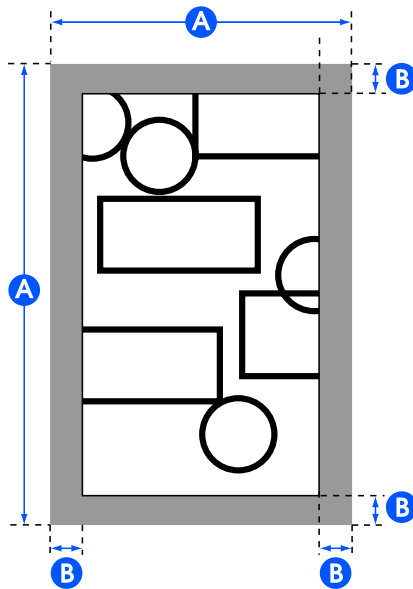
Settings item	Settings value	Explanation
Basic Settings		
Paper Source	Roll Paper *	Select the paper source. If the paper is not loaded as in the set paper source, then an error will occur during printing.
	Cut Sheet (1 sheet)	
Color Mode	Black/White	Select whether to print in color or black and white.
	Color *	
Advanced		
Quality	Speed *	Select the print quality.
	Fine	
	Super Fine	
Page Margins option	Clip By Margins *	<p>Add margins (areas of <b>B</b> in the following illustration) inside the output size (areas of <b>A</b> in the following illustration) set in the Reduce/Enlarge settings. When there is a print object in the margin section, it is clipped and not printed.</p> 

Using the Menu

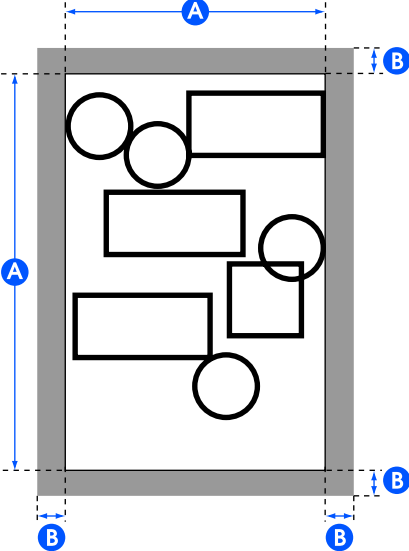
Settings item	Settings value	Explanation
	Oversize	<p>Add margins (areas of <b>B</b> in the following illustration) outside the output size (areas of <b>A</b> in the following illustration) set in the Reduce/Enlarge settings. With the actual output size, the margin sections become larger than the set output size (areas of <b>A</b> in the following illustration).</p> 
	Borderless	<p>This is enabled when <b>Roll Paper</b> is selected in <b>Paper Source</b>.</p> <p>The print data is enlarged slightly in respect to the output size set in Reduce/Enlarge to print so that margins do not appear inside the output size. However, if a custom size is set, a margin may appear on the right side depending on the data.</p> <p>When printing multiple pages with borderless printing on roll paper, you can select whether to insert a margin and cut twice between pages or cut once between pages in the following menu item.</p> <p><b>Settings - General Settings - Printer Settings - Paper Source Settings - Roll Paper Setup - Cut for Borderless Print</b></p>
Bidirectional	On *	Setting this to <b>On</b> causes the print head to print while moving both left and right. Setting this to <b>Off</b> reduces ruled line misalignment, but printing takes more time.
	Off	
Color Mode	EPSON Standard (sRGB)	Optimize the sRGB space and correct the color.
	Business Graphics *	Perform color correction to sharpen your images based on the sRGB space.
	GIS	Perform color correction suitable for when printing GIS (Geographic Information System) topographical maps or similar.
	Line Drawing	Perform color correction suitable for CAD drawings and other line drawings.
	Off (No Color Management)	Do not perform color correction.

## Using the Menu

Settings item	Settings value	Explanation
Reduce/Enlarge		
Auto Fit Page	On	Set to <b>On</b> to print so that the short edge of the original fits the width of the paper loaded in the printer.
	Off *	<p>If the short edge of the document is wider than the paper, printing will be at actual size.</p> <p>If the paper is not loaded as set in Paper Source of Basic Settings, this cannot be set to <b>On</b>. Furthermore, if the settings for the Paper Source are changed without replacing or loading the paper after setting this to <b>On</b>, the settings return to the actual size in the default settings. If the printer is unable to detect the width of the paper, an error will occur when the Print button is touched.</p>
Custom Size	Actual Size *, User-Defined	Select the output size. If the Actual Size is not selected, set the desired size in User-Defined.

## Maintenance

# Maintenance

## Cleaning the Platen

Periodically (about once a month) clean the platen by doing the following procedure.

- 1 Turn the printer off and make sure that nothing is displayed on the screen, and then unplug the power cable from the outlet.
- 2 Leave the printer for a minute after removing the power plug.
- 3 Open the front cover.

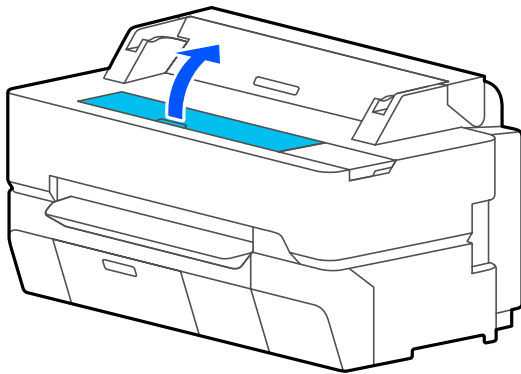

**!** **Important:**

- Never touch the rollers inside the printer during cleaning. Doing so may cause soiled prints and other problems.
- Do not touch the ink tubes inside the printer because doing so may cause a failure.
- Do not rub the pads for borderless printing. Doing so may cause the pads to become detached.

- 4 Use a soft cloth to remove any dust or dirt from the platen.

Thoroughly wipe the area shown in blue in the illustration below. To avoid spreading the dirt, wipe from the inside to the outside.

For stubborn dirt, clean it using a soft cloth that has been dampened with a small amount of neutral detergent and then thoroughly wrung out. Then, dry off the inside of the printer with a dry, soft cloth.

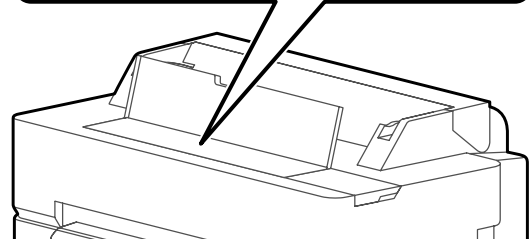
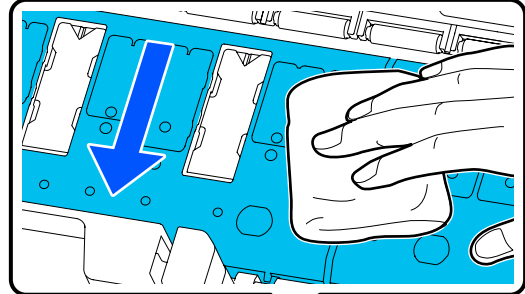

- 5 If any paper particles (resemble white powder) have accumulated in the holes shown in the illustration below, use a pointed object such as a toothpick to push them in.

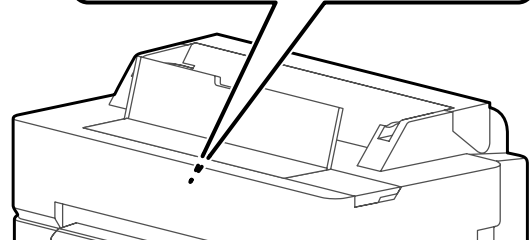
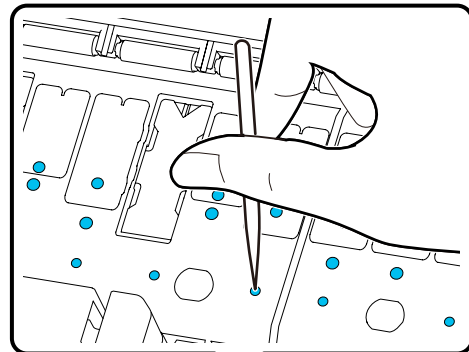

- 6 After cleaning, close the front cover.

## Maintenance

### Handling of Used Consumables

If using the printer in an office or other business, dispose of used consumables in accordance with laws and regulations, such as by contracting an industrial waste disposal company.

If using the printer in a domestic situation, place these in a plastic bag, then dispose of in accordance with laws and regulations as well as regional ordinances, and as directed by local government.

### Replacing Ink Cartridges

If any of the ink colors remaining amount falls below the minimum amount, printing will not be possible.

If an ink cartridge remaining amount falls below the minimum amount, you can continue printing after replacing the ink cartridge.

If the remaining ink amount drops yet printing is continued, then replacement of an ink cartridge during printing may be required. When replacing ink during a print job, you may see a difference in color depending on the drying conditions. When this is not permissible, we recommend first replacing the ink cartridge with a new one before printing. The removed ink cartridge can be installed again and used until the remaining amount falls below the minimum amount. However, if an ink cartridge with not much ink remaining is removed and reinstalled, it may not be usable because some ink is consumed to ensure the reliability of the printer.

Supported ink cartridges

 [“Options and Consumable Products” on page 214](#)

#### Important:

*Epson recommends the use of genuine Epson ink cartridges. Epson cannot guarantee the quality or reliability of non-genuine ink. The use of non-genuine ink may cause damage that is not covered by Epson's warranties, and under certain circumstances, may cause erratic printer behavior. Information about non-genuine ink levels may not be displayed, and use of non-genuine ink is recorded for possible use in service support.*

#### Note:

*You can replace the ink cartridges while viewing the procedure on the screen. To view the procedure on the screen, touch **Settings - Maintenance - Ink Cartridge(s) Replacement** from the Home screen.*

**1** Make sure the printer is on.

**2** Open the cartridge cover.

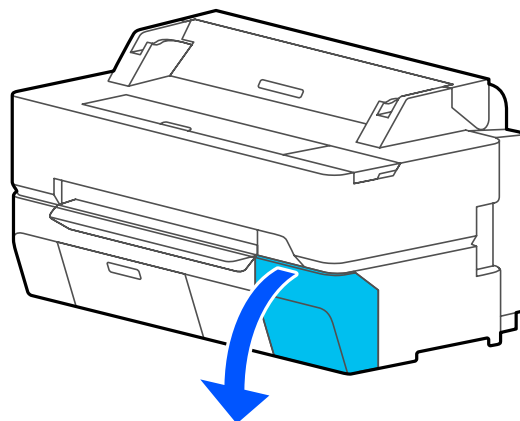

**3** Remove the new ink cartridge from the bag. Shake the ink cartridge for 10 seconds 30 times horizontally in approximately 5 cm movements as shown in the illustration.

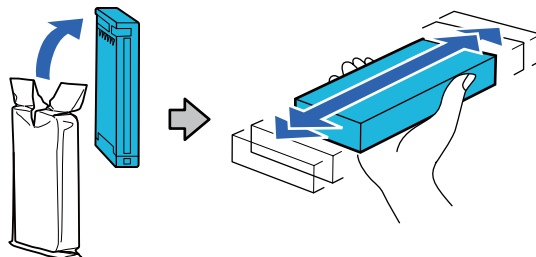

## Maintenance

**!** **Important:**

*Do not touch the IC chip on the ink cartridge. You may not be able to print properly.*

- 4** Hook a finger into the indentation on the top of the ink cartridge to be replaced and pull it straight toward you.

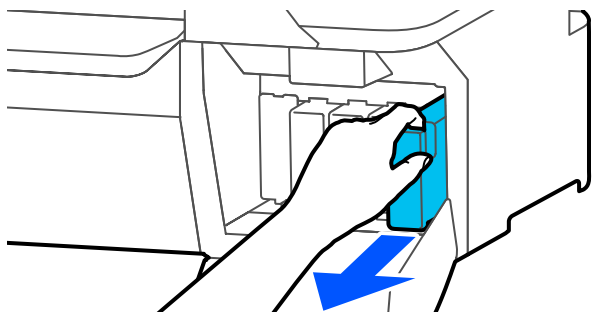

**!** **Important:**

*Removed ink cartridges may have ink around the ink supply port, so be careful not to get any ink on the surrounding area when removing the cartridges.*

- 5** Holding the new ink cartridge with the label facing toward you, slide it all the way into the slot.
- Match the color of the ink cartridge to the color of the label on the printer.

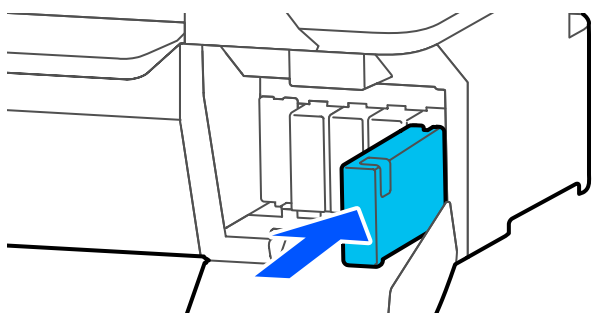

Repeat Steps 3 to 5 to replace the other ink cartridges.

**!** **Important:**

*Install ink cartridges into all slots. You cannot print if any of the slots are empty.*

- 6** Close the cartridge cover.

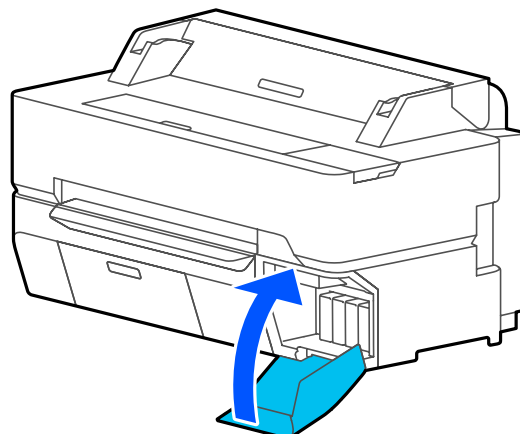

**!** **Important:**

*We recommend that you remove and shake the installed ink cartridges once every three months to ensure good print quality.*



Maintenance

# Replacing Maintenance Box

If **The Maintenance Box is at the end of its service life.** is displayed, replace the Maintenance Box.

If **The Maintenance Box is nearing the end of its service life.** is displayed, ready a new Maintenance Box. Printing is possible until replacement is instructed.

Supported maintenance box

 [“Options and Consumable Products”](#) on page 214

 **Important:**

*Do not replace the Maintenance Box while printing. Waste ink may leak.*

**Note:**

*You can replace the Maintenance Box while viewing the procedure on the screen. To see the guide, from the Home screen, touch **Settings - Maintenance - Replace Maintenance Box.***

When you open the Maintenance Box cover for SC-T5400 Series/SC-T5400M Series, you will find a Maintenance Box on both the left and right sides. The replacement procedure is the same for both of them.

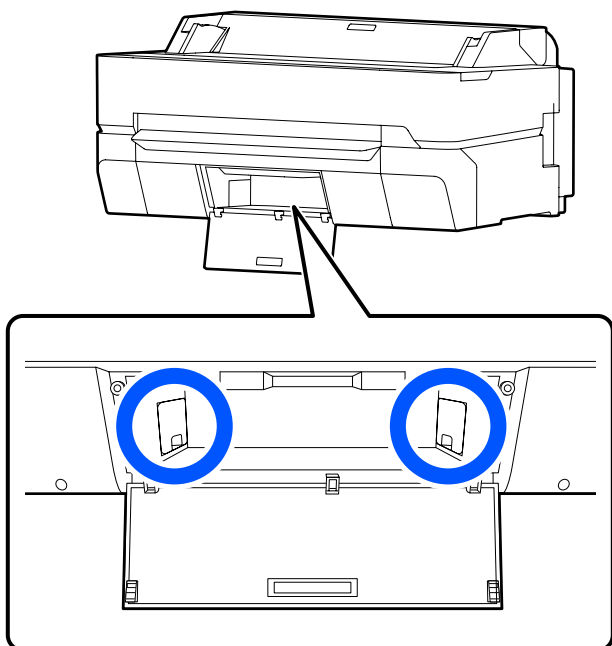

**1** Open the Maintenance Box cover.

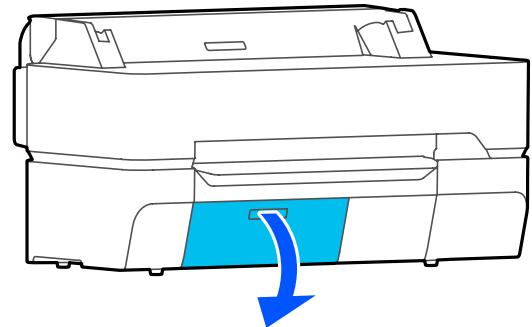

**2** Pull out the Maintenance Box.

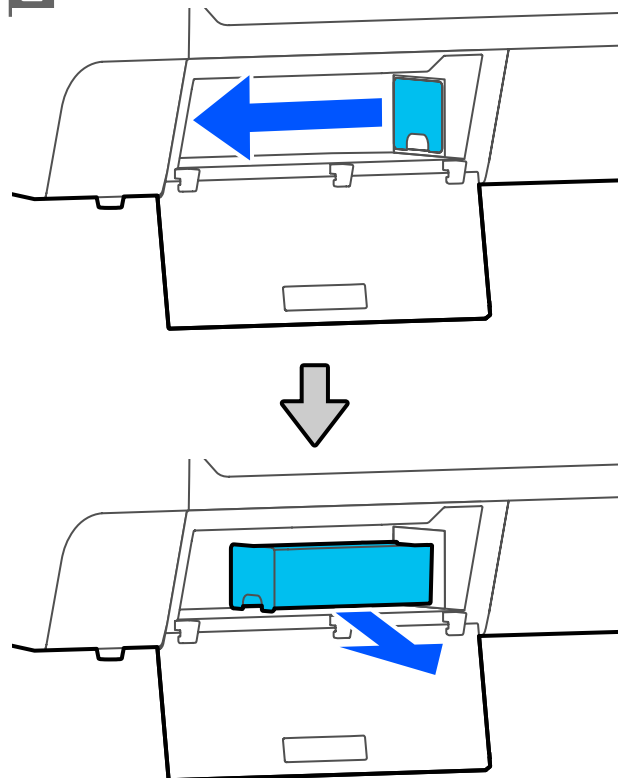

**3** Place the used Maintenance Box in the clear bag included with the new Maintenance Box, and make sure that the zipper is closed tight.

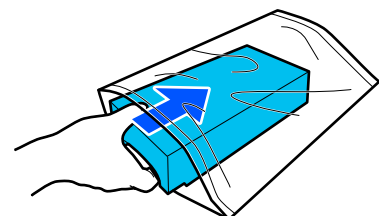

 **Important:**

*Until the fastener is closed securely, do not tilt the Maintenance Box. Waste ink may leak.*

**Maintenance**

**4** Insert a new Maintenance Box.

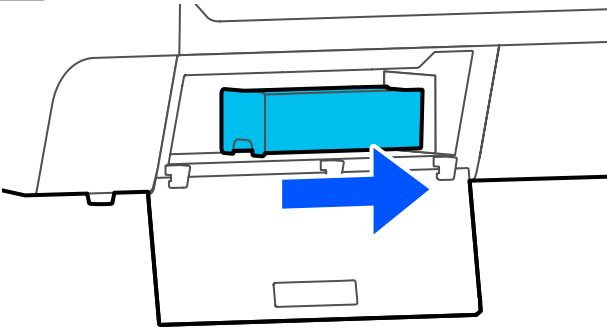

**!** **Important:**  
Do not touch the IC chip on the Maintenance Box. Doing so may prevent normal operation and printing.

**5** Close the Maintenance Box cover.

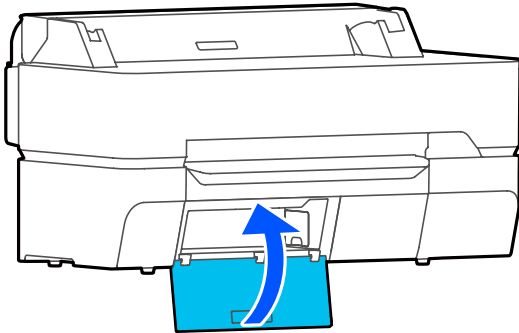

## Replacing the Cutter

Replace the cutter when it is not cutting paper cleanly.

Supported cutter

[“Options and Consumable Products”](#) on page 214

Use a cross-head screwdriver to replace the cutter. Make sure you have a cross-head screwdriver with you before you start work.

**!** **Caution:**

Store the cutter out of the reach of children. The cutter's blade could cause an injury. Pay careful attention when replacing the cutter.

**!** **Important:**

- Dropping the cutter, or knocking it against hard objects may chip the blade.
- The protective sheet inserted in the new cutter is to protect the blade. Do not remove it until you are instructed to do so.

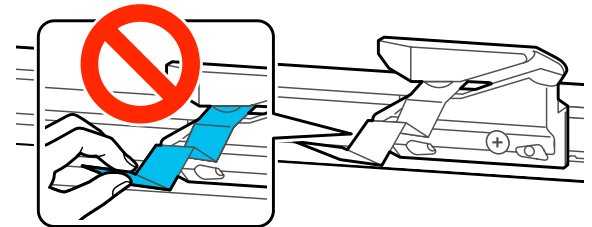

**1** Remove any paper from the printer.

[“Removing Roll Paper”](#) on page 38

[“Removing Cut Sheet \(1 Sheet\)”](#) on page 41

**2** From the Home screen, touch **Settings - Maintenance - Replace Cutter**.

The Replace Cutter screen appears.

**3** Touch **Start**.

The cutter moves to the replacement position.

**Maintenance**

- 4** Loosen the screw holding the cutter in place using a cross-head screwdriver and pull the cutter straight out.

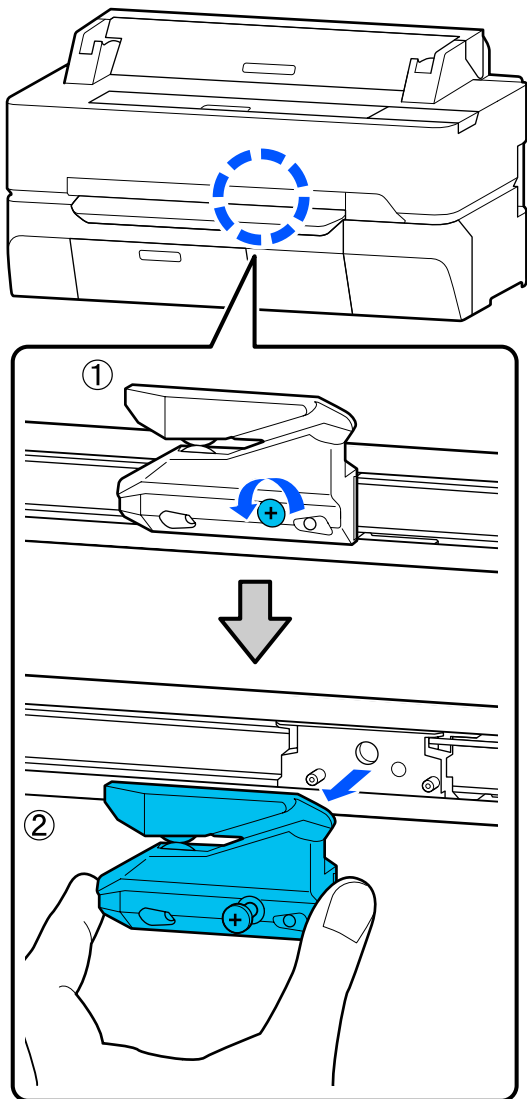

**Note:**  
Place the used cutter in a plastic bag, then dispose of in accordance with regional ordinances, and as directed by local government.

- 5** Install the new cutter.  
Insert the cutter so that the pin on the printer matches up with the hole on the cutter. Use a cross-head screwdriver to tighten down the screw to hold the cutter in place.

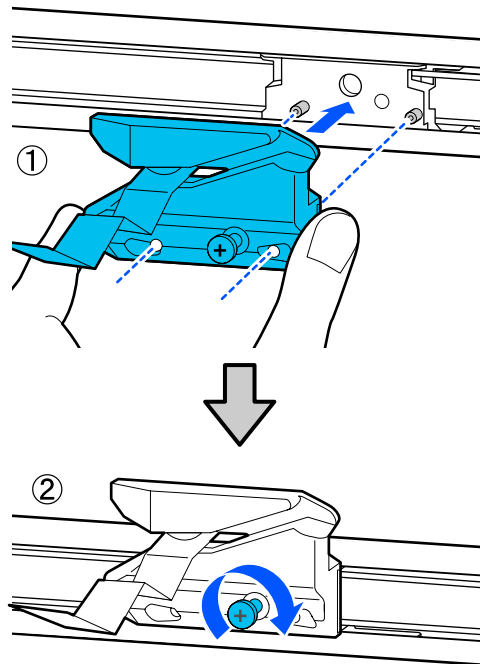

**! Important:**  
Screw the cutter firmly, otherwise the cut position may be slightly shifted or skewed.

- 6** Touch **OK**.  
The cutter returns to its original position, and the protective sheet inserted in the cutter comes out. Remove the protective sheet.

## Problem Solver

# Problem Solver

## What to do When a Message is Displayed

If the printer displays one of the messages shown below, refer to the solution listed and take the necessary steps.

Messages	What to do
Cannot recognize ink cartridges. Try installing again.	<ul style="list-style-type: none"> <li><input type="checkbox"/> Remove and reinsert the ink cartridge. If the message persists, insert a new ink cartridge (do not reinstall the cartridge that caused the error). <a href="#">☞ "Replacing Ink Cartridges" on page 183</a></li> <li><input type="checkbox"/> Condensation may occur in the ink cartridge. Leave it at room temperature for at least three hours before installing the ink cartridge again. <a href="#">☞ "Notes on handling ink cartridges" on page 21</a></li> </ul>
Ink is low.	The ink is low. Ready a new ink cartridge. Printing is possible until replacement is instructed. <a href="#">☞ "Options and Consumable Products" on page 214</a>
The maintenance box is not recognized. Install it correctly.	Reinstall the Maintenance Box. If the message persists after reinstalling it, replace with a new Maintenance Box (do not reinstall the Maintenance Box that caused the error). <a href="#">☞ "Replacing Maintenance Box" on page 185</a>
There is not enough space in maintenance box to perform head cleaning. You can continue printing until replacement is required.	The Maintenance Box does not have enough capacity to store ink discharged in print head cleaning, therefore do not perform cleaning. To perform cleaning, replace the Maintenance Box with a new one. The used Maintenance Box may be reinstalled after cleaning is completed. <a href="#">☞ "Replacing Maintenance Box" on page 185</a>
Command Error Check the printer driver setting.	Touch <b>Cancel</b> to stop printing. Confirm that the printer driver you are using supports this printer.
Recovery Mode	Firmware update has failed, so the printer has started in recovery mode. Use the procedure below to update the firmware again.  (1) Connect a computer and the printer using a USB cable. (Updates during recovery mode cannot use a network connection.)  (2) Download the latest firmware from the Epson website, and start update. Refer to the firmware download page for update methods.
Memory Full. Document was not printed.	Print from the printer driver.

## Problem Solver

# When a Maintenance Call/Printer Error Occurs

Error messages	What to do
Maintenance Request Replace Parts Soon/End Of Parts Service Life XXXXXXXX	<p>A part used in the printer is nearing the end of its service life.</p> <p>Contact your dealer or Epson Support and tell them the maintenance request code.</p> <p>You cannot clear a maintenance error until the part is replaced. A service call occurs if you continue to use the printer.</p>
Printer Error Printer error. Turn the power off and on again. For details, see your documentation. XXXXXX	<p>Turn off the printer, disconnect the power cable from the outlet and from the AC inlet on the printer, and then reconnect. Turn on the printer again multiple times.</p> <p>If the same error is displayed on the LCD panel, contact your dealer or Epson Support for assistance. Tell them the error code is "XXXXXX".</p>

## Problem Solver

# Troubleshooting

## You cannot print (because the printer does not work)

### The printer does not turn on.

■ **Is the power cable plugged into the electrical outlet or the printer?**

Make sure the power cable is securely plugged into the printer.

■ **Is there a problem with the power outlet?**

Make sure your outlet works by connecting the power cable for another electric product.

### The printer turns off automatically.

■ **Is the automatic power off configured?**

To prevent the printer turning off automatically, select **Off**.

["General Settings - Basic Settings" on page 140](#)

### The printer driver is not installed properly (Windows).

■ **Is the icon for this printer displayed in the Devices and Printers/ Printers/Printers and Faxes folder?**

- Yes  
The printer driver is installed. See the "The printer is not communicating with the computer" section.
- No  
The printer driver is not installed. Install the printer driver.

■ **Does the printer port setting match the printer connection port?**

Check the printer port.

Click the **Port** tab in the printer Properties dialog and check the option selected for **Print to the following port(s)**.

- USB: **USBxxx** (x stands for the port number) for the USB connection
- Network: The correct IP address for the network connection

If it is not indicated, the printer driver is not installed correctly. Delete and reinstall the printer driver.

["Uninstalling Software" on page 29](#)

### The printer driver is not installed properly (Mac).

■ **Is the printer added to the printer list?**

Select **System Preferences > Printers & Scanners** (or **Print & Fax**) from the Apple menu.

If the printer name is not displayed, add the printer.

["How to Select the Dedicated Printer Driver for This Printer" on page 57](#)

### The printer is not communicating with the computer.

■ **Is the cable plugged in properly?**

Confirm that the interface cable is securely connected to both the printer port and the computer. Also, make sure the cable is not broken nor bent. If you have a spare cable, try connecting with the spare cable.

■ **Does the interface cable specification match the specifications for the computer?**

Make sure the interface cable specifications match the specifications for the printer and the computer.

["System Requirements" on page 227](#)

## Problem Solver

### ■ When using a USB hub, is it being used correctly?

In the USB specification, daisy-chains of up to five USB hubs are possible. However, we recommend that you connect the printer to the first hub connected directly to the computer. Depending on the hub you are using, the operation of the printer may become unstable. If this should occur, plug the USB cable directly into your computer's USB port.

### ■ Is the USB hub recognized correctly?

Make sure the USB hub is recognized correctly on the computer. If the computer correctly detects the USB hub, disconnect all USB hubs from the computer and connect the printer directly to the computer USB port. Ask the USB hub manufacturer about USB hub operation.

## You cannot print under the network environment.

### ■ Are the network settings correct?

Ask your network administrator for the network settings.

### ■ Connect the printer directly to the computer using a USB cable, and then try to print.

If you are able to print via USB, there is a problem with network settings. Ask your system administrator, or refer to the manual for your network system.

## Printing from iPhone or iPad is not possible.

### ■ Check printer settings.

- Connect the iPhone or iPad to the same network (SSID) as the printer.
- In Web Config, enable AirPrint settings.  
 ["How to Use Web Config" on page 26](#)

## The printer has an error.

### ■ View the message displayed in the control panel.

 ["What to do When a Message is Displayed" on page 188](#)

## The printer stops printing.

### ■ Is the status of print queue Pause? (Windows)

If you stop printing or the printer stops printing because of an error, the print queue enters a **Pause** status. You cannot print in this status.

Double-click the printer icon in the **Devices and Printers, Printers**, or **Printers and Faxes** folder; if printing is paused, open the **Printer** menu and clear the **Pause** check box.

### ■ Does the current printer status show Paused? (Mac)

Open the status dialog for your printer and check whether printing is paused.

(1) Select **System Preferences > Printers & Scanners** (or **Print & Fax**) > **Open Print Queue** from the **Apple** menu.

(2) Double-click the icon for any printer that is **Paused**.

(3) Click **Resume Printer**.

## Problem Solver

### Your problem is not listed here.

#### ■ **Decide whether the trouble is caused by the printer driver or the application. (Windows)**

Perform a test print from the printer driver so that you can check that the connection between the printer and computer is correct and the printer driver settings are correct.

- (1) Make sure that the printer is turned on and in ready status, and load A4 or larger paper.
- (2) Open the **Devices and Printers, Printers**, or **Printers and Faxes** folder.
- (3) Right-click the printer icon, and select **Properties**.
- (4) In the Properties dialog, select the **General** tab and click **Print Test Page**.

After a while the printer starts to print a test page.

- If the test page is printed correctly, the connection between the printer and computer is correct. Go to the next section.
- If the test page is not printed correctly, check the items above again.  
 ["You cannot print \(because the printer does not work\)" on page 190](#)

The "Driver Version" shown on the test page is the version number of the Windows internal driver. This differs from the Epson printer driver version that you installed.

---

### The print head moves, but nothing prints.

#### ■ **Confirm the printer operation.**

Print a nozzle check pattern.

 ["When you want to unclog the print head" on page 196](#)

If the printer has not been used for a long time, the nozzles of the print head may have dried up and become clogged.

#### ■ **Is the message Motor self adjustment running. displayed on the control panel's screen?**

The printer adjusts the internal motor. Wait for a while without turning off the printer.



## Problem Solver

### The prints are not what you expected

#### Main troubleshooting procedures

If the following problems with print quality occur, then respond by following the process flow on this page.

#### Horizontal or vertical banding



#### Duplicated ruled lines or warped lettering

enthalten alle  
Aufdruck. W  
5008 "Regel

#### Wrinkling, smearing, or uneven coloring



#### ■ Check the paper

- ❑ Check that the paper is compatible with the printer, and that there are no wrinkles, folds, or bending.  
[🔗 "Epson Special Media" on page 214](#), ["Supported Commercially Available Paper" on page 220](#)  
[🔗 "Notes on Loading the Paper" on page 32](#)
- ❑ Check that the paper type setting matches the loaded paper, and if not, change it.  
[🔗 "Setting Loaded Paper" on page 42](#)



**If print results do not improve**

#### ■ Perform Easy Adjustment

Paper settings are optimized for the paper loaded.





[🔗 "Optimizing Paper Settings \(Media Adjust\)" on page 46](#)



**If "Auto Adjustment is unable to start because there is a problem with the paper or printing status..." is displayed**  
**If not satisfied with the results of adjustment**

## Problem Solver

### ■ Check the print results and take one of the following measures

- If streaks (horizontal banding or uneven colors) appear in print results  
Check the print head nozzles for clogging  
 ["When you want to unclog the print head" on page 196](#)  
  
 The nozzles are not clogging / Clogging is resolved but streaks still appear in the print results  
  
Perform Paper Feed Adjust (Manual)  
 ["Paper Feed Adjust \(Manual\) Procedure" on page 195](#)
  
- If ruled lines are duplicated, lettering is warped, or print results are grainy  
Perform Print Head Alignment (Manual)  
 ["Print Head Alignment \(Manual\) Procedure" on page 195](#)

**Problem Solver**

**Paper Feed Adjust (Manual) Procedure**

The adjustment patterns are printed twice. Visually check the adjustment patterns to make the adjustments.

The following shows the length and number of sheets of paper used for adjustment pattern printing.

- Roll paper: Approx. 156 mm
- Cut sheet: 2 sheets of A4 or larger

**1** Touch the following in order from the Home screen.

- Roll paper  
Roll paper information area - **Media Adjust**
- Cut sheet  
**Paper Setting - Cut Sheet (1 sheet) - Media Adjust**

**2** Touch **Paper Feed Adjust - Manual - Start**.  
Printing of the first set of adjustment patterns starts.

**! Important:**  
*When using roll paper with the auto cut turned off, the paper cannot be removed to print the second set of patterns even though printing of the first set of patterns has finished. Do not pull the printed paper.*

**3** Enter the numeric value of the pattern with the least streaks among the printed adjustment patterns of #1 and then touch **Adjustment #2**.  
In the following example, pattern 0 has the least streaks so you would enter 0.

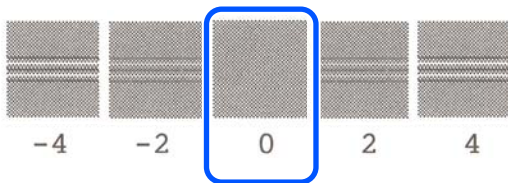

If there is no difference between two adjacent patterns and you are unsure which is the best one to choose, enter the numeric value that comes between them. For example, if you are unsure whether to enter pattern 0 or 2, enter 1.

**4** Select the adjustment pattern of #2 in the same way as for #1.

**5** Touch **OK**.  
Printing of the second set of adjustment patterns starts. For cut sheet smaller than A2 size, load the second sheet of paper.

**! Important:**  
*When using roll paper with the auto cut turned off, the part with the first set of patterns printed on it is pulled inside the printer in order to print the second set of patterns. Do not touch the paper with your hands.*

**6** Enter the numeric value of the pattern with the least streaks among the printed adjustment patterns of #1 and then touch **Adjustment #2**.  
In the following example, pattern 0 has the least streaks so you would enter 0.

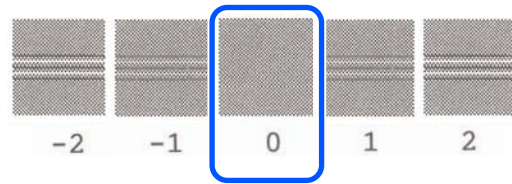

If you are unsure which of two adjacent patterns is the best one to choose, select the one that you think has the least streaks. You cannot enter the numeric value that becomes between them.

**7** Select the adjustment pattern of #2 in the same way as for #1.

**8** Touch **OK**.

When **Print head alignment complete...** appears, the procedure is finished.

The adjustment results are saved as settings of the currently selected paper type.

**Print Head Alignment (Manual) Procedure**

Visually check the adjustment patterns to make adjustments.

The following shows the length and number of sheets of paper used for adjustment pattern printing.

### Problem Solver

- ❑ Roll paper: Approx. 285 mm
- ❑ Cut sheet: 1 sheet of A4 or larger

- 1** Touch the following in order from the Home screen.
  - ❑ Roll paper  
Roll paper information area - **Media Adjust**
  - ❑ Cut sheet  
**Paper Setting - Cut Sheet (1 sheet) - Media Adjust**
- 2** Touch **Print Head Alignment - Manual - Start**.  
The adjustment patterns are printed.
- 3** Enter the numeric value of the pattern with the most visible straight line among the printed adjustment patterns of #1 and then touch **Adjustment #2**.

In the following example, pattern 0 has the least streaks so you would enter 0.

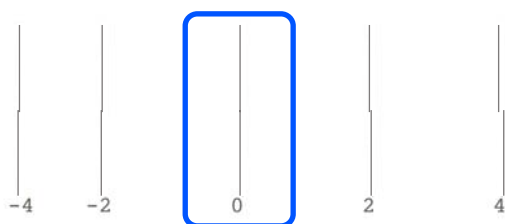

If there is no difference between two adjacent patterns and you are unsure which is the best one to choose, enter the numeric value that comes between them. For example, if you are unsure whether to enter pattern 0 or 2, enter 1.

- 4** Select the adjustment patterns of #2 and #3 in the same way as for #1.
- 5** Enter the numeric value of the pattern with the least streaks among the adjustment patterns of #4 and then touch **OK**.

In the following example, pattern 0 has the least streaks so you would enter 0.

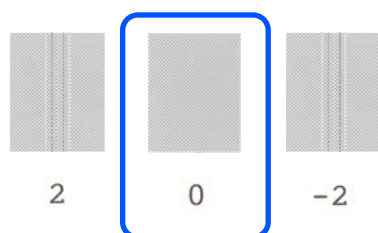

If there is no difference between two adjacent patterns and you are unsure which is the best one to choose, enter the numeric value that comes between them. For example, if you are unsure whether to enter pattern 0 or 2, enter 1.

When **Print head alignment complete...** appears, the procedure is finished.

The adjustment results are saved as settings of the currently selected paper type.

### When you want to unclog the print head

We recommend checking for clogging by performing a print head nozzle check if the printer has not been used for an extended period or before important print jobs.

If the nozzle check results indicate clogging, carry out print head cleaning.

Ink is consumed during print head cleaning.

Check the remaining amounts of ink cartridges and the amount of empty space in the Maintenance Box and provide new ink cartridges and Maintenance Box in advance if they are low.

- 1** From the Home screen, touch **Settings - Maintenance - Print Head Nozzle Check**.
- 2** Touch **Start** to start printing a check pattern.  
When changing the paper source displayed on the start screen, touch **Paper Source**.
- 3** Check the printed check pattern for clogging.  
**Example of clean nozzles**

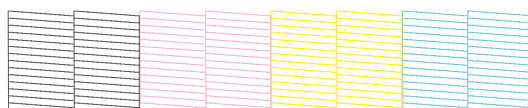

If none of the pattern is missing, then the print head nozzles are not clogged. Touch **OK** to end the nozzle clogging check.

## Problem Solver

### Example of clogged nozzles

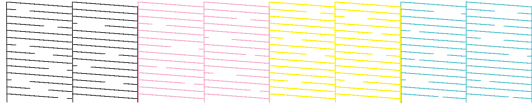

If the pattern has missing areas, touch  to display the **Head Cleaning** screen. Proceed to the next step.

**4**

Touch **Start** to start cleaning.

When cleaning is complete, **Print the pattern?** will be displayed. Touch **Yes** to return to Step 2. Repeat Steps 2 to 4, and check if the problem has been resolved.

If the nozzles are still clogged after performing print head cleaning three times in a row, then perform Powerful Cleaning.

Select **Maintenance - Powerful Cleaning** to perform Powerful Cleaning.

 [“Maintenance” on page 160](#)

## Problem Solver

### Ink drips



#### ■ Dirt has accumulated around the nozzles of the print head.

Perform print head cleaning.

 ["When you want to unclog the print head" on page 196](#)

### Fine lines in drawings are not printed

#### ■ Is a suitable resolution set?

Try the following measures.

- In your application software, set the resolution to 600 dpi.
- Confirm that the data paper size is correctly set in the printer driver document size, and remedy if different.
- If PDF, print directly from the source data for that PDF.
- In the printer driver, select **Emphasize Thin Lines**.  
**Emphasize Thin Lines** is displayed by clearing the Simple Settings check box in the Print Quality section on the Printer Settings screen.

### Differences in color/light/dark

If there are differences in color/light/dark, then handle these by following the process below.

 ["The prints are not what you expected" on page 193](#)

If these measures do not resolve the issue, check the following items.

#### ■ Is the Color Density setting appropriate?

If you feel that lines in drawings are too light, then on the printer driver Advanced screen, click **Paper Configuration**, and increase the ink density.

Conversely, if the ink density is too high on tracing paper, either reduce the ink density or select **Tracing Paper <LowDuty>** in the Paper Type settings of the printer, and then print.

#### ■ Are you using a genuine Epson ink cartridge?

This printer is developed for use with Epson ink cartridges. If you use non-Epson ink cartridges, printouts may be faint, or the color of the printed image may be changed because the remaining ink level is not correctly detected. Be sure to use the correct ink cartridge.

#### ■ Are you using an old ink cartridge?

The print quality drops when an old ink cartridge is used. Replace the old ink cartridge with a new one. We recommend using all the ink in the cartridge before the expiry date printed on the package (within 6 months of installation in the printer).

#### ■ Have you tried changing the print quality settings?

In the printer driver **Printer Settings- Print Quality**, select **Print with High Quality** and try printing. If this is not selected, this places priority on speed, however this can adversely impact print quality to some extent.

#### ■ Is color management enabled?

Enable color management.

 ["Color Management Printing" on page 78](#)

#### ■ Have you compared the printing result with the image on the display monitor?

Since the monitor and the printer produce colors differently, printed colors will not always match on-screen colors perfectly.

#### ■ Did you open the front cover while printing?

If the front cover is opened while printing, the print head stops suddenly, causing unevenness in color. Do not open the front cover while printing.

## Problem Solver

### The color is not exactly the same as another printer.

■ **Colors vary depending on the printer type due to each printer's characteristics.**

Because inks, printer drivers, and printer profiles are developed for each printer model, the colors printed by different printer models are not exactly the same.

You can achieve similar colors with the same color adjustment method or the same gamma setting by using the printer driver.

 ["Correct color and print" on page 74](#)

### The print is not positioned properly on the media.

■ **Have you specified the print area?**

Check the print area in the settings of the application and the printer.

■ **Is the Document Size setting correct?**

If the option selected for **Document Size** in the print driver or **Paper Size** driver does not match the paper loaded in the printer, the print may not be in the correct position or some of the data may not be printed. In this case, check the print settings.

■ **Is the paper skewed?**

If **Off** is selected for **Detect Paper Meandering** in the Printer Settings menu, printing will continue even if the paper is skewed, resulting in printing outside of the print area. In the Printer Settings menu, set **Detect Paper Meandering** to **On**.

 ["General Settings - Printer Settings" on page 142](#)

■ **Is the roll paper margin set wide?**

If margins narrower than the margins set in the roll paper **Advanced Media Setting - Top/ Bottom Margins** menu are set in the application software, then priority is given to the printer settings.

 ["Roll Paper menu" on page 133](#)

### Lengths differ between the print results and print data

If you want to print to roll paper with lengths exactly as specified in the print data, such as when printing CAD drawings, make the following adjustments. You will need a ruler so get one ready before performing this work.

The length of the paper used for adjustment pattern printing is approximately 555 mm.

**1** Touch the Roll paper information area - **Media Adjust** from the Home screen.

**2** Touch **Paper Feed Adjust - Print length adjustment - Start**.

The adjustment patterns are printed.

**3** Measure the distance between the "+" symbols on the printed patterns with a ruler.

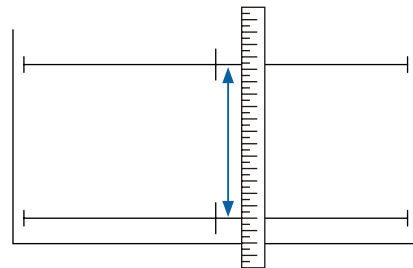

**4** Enter the measured length in the screen.

**5** Touch **OK**.

When **Print head alignment complete...** appears, the procedure is finished.

The adjustment results are saved as settings of the currently selected paper type.

### Vertical ruled lines are misaligned.

■ **Has Print Head Alignment been carried out?**

Confirm that paper type settings that match the paper are selected, and perform **Print Head Alignment**.

 ["Setting Loaded Paper" on page 42](#)

 ["Optimizing Paper Settings \(Media Adjust\)" on page 46](#)

## Problem Solver

### ■ After Print Head Alignment, does the same problem occur?

In the printer driver Printer Settings screen, clear the **Simple Settings** check box in the Print Quality field. Select **Level - Max Quality**, clear the **High Speed** check box, and try printing.

However, printing may take some time.

Bidirectional printing moves the print head left and right while printing, so if the print head is misaligned (with gaps), ruled lines may be printed as misaligned.

### ■ Is the print head scuffing the printed surface?

Enable the Thick Paper function, and try printing. From the Home screen, touch **Settings - Printer Settings - Thick Paper - On**.

 ["General Settings - Printer Settings" on page 142](#)

When using commercially available roll paper registered as custom paper, touch the Roll paper information area - **Advanced Media Setting - Platen Gap** and try changing the setting to a value that will widen the platen gap (a higher value).

## The printed surface is scuffed or soiled.

### ■ Is the paper too thick or too thin?

Check that the paper specifications are compatible with this printer.

 ["Epson Special Media Table" on page 216](#)

 ["Supported Commercially Available Paper" on page 220](#)

### ■ Is the paper wrinkled or creased?

Do not use old paper or paper with creases in it. Always use new paper.

### ■ Is the paper wavy or curled?

Changes in temperature and humidity may cause paper to become wavy or curled which can cause scratching.

Check the following points.

- Load the paper just before printing.
- Do not use wavy or curled paper. For roll paper, cut off the wavy or curled parts and then load it again. For cut sheets, use new paper.

 ["Notes on Loading the Paper" on page 32](#)

### ■ Is the print head scuffing the edge of the paper?





If smearing or soiling occurs on the edge of the roll paper, touch the Roll paper information area - **Advanced Media Setting - Top/Bottom Margins** from the Home screen, change the edge setting to 35 mm, and try printing.

### ■ Is the print head scuffing the trailing edge of the paper?

Depending on the paper usage, storage conditions, and the content of the print data, the bottom edge may be scuffed when printing. In this situation it is best to create your data with a wider bottom margin.

## Soiling occurs at a specific position on the print surface

Follow the steps below to clean the roller by feeding plain paper.

- 1** Turn on the printer, and load it with widest available roll paper.  
 ["Loading Roll Paper" on page 33](#)
- 2** Touch **Paper Setting - Roll Paper - Feed/Cut Paper** from the Home screen.
- 3** Touch and hold the  (Forward) button until the paper is no longer marked.  
Paper is fed while the  (Forward) button is touched. If the paper is not soiled, cleaning is complete.
- 4** Touch the  (Cut) button to cut the paper.



## Problem Solver

### The paper is creased.

#### ■ Are you using the printer at normal room temperature?

Epson special media should be used at normal room temperature (temperature: 15 to 25°C, humidity: 40 to 60%). For information about paper such as thin paper from other manufacturers that requires special handling, see the documentation supplied with the paper.

#### ■ Is there a gap between both edges of the roll paper and the flanges?

Confirm that the spindle flanges are right up against both edges of the roll paper, with no gaps. If there are any gaps, then the paper is fed at an angle, and this may result in wrinkling.

 ["Loading Roll Paper" on page 33](#)

#### ■ Has Media Adjust been carried out?

Confirm that paper type settings that match the paper being used, and perform Media Adjust.

 ["Setting Loaded Paper" on page 42](#)

 ["Optimizing Paper Settings \(Media Adjust\)" on page 46](#)

#### ■ Is the roll paper tension weak?

If wrinkles occur on the roll paper, increase the paper tension settings. In the Roll paper information area - **Advanced Media Setting - Back Tension**, select **High** or **Extra High**.

### The reverse side of the printed paper is soiled.

Carry out cleaning with the following procedure.

#### ① Clean the platen and outer edges of the pads for borderless printing.

 ["Cleaning the platen and outer edges of the pads for borderless printing" on page 201](#)

 Soiling occurs on the back of the paper again right after cleaning

#### ② Replace the pads for borderless printing.

 ["Replacing the pads for borderless printing" on page 202](#)

#### **Important:**

*Continuing use with paper particles and dust adhered to the platen and the pads for borderless printing may cause a print head failure or nozzle clogging.*

#### **Cleaning the platen and outer edges of the pads for borderless printing**

You can see the procedure in a video on YouTube.

#### [Epson Video Manuals](#)

- 1 Turn the printer off and make sure that nothing is displayed on the screen, and then unplug the power cable from the outlet.
- 2 Leave the printer for a minute after removing the power plug.
- 3 Open the front cover.

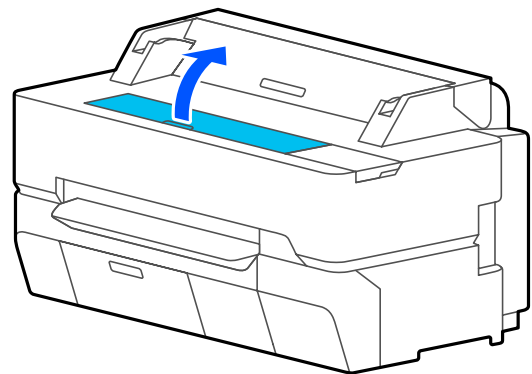

#### **Important:**

- Never touch the rollers inside the printer during cleaning. Doing so may cause soiled prints and other problems.
- Do not touch the ink tubes inside the printer because doing so may cause a failure.
- Do not rub the pads for borderless printing. Doing so may cause the pads to become detached.

**Problem Solver**

- 4** Use a soft cloth to remove any dust or dirt from the platen.

Thoroughly wipe the area shown in blue in the illustration below. To avoid spreading the dirt, wipe from the inside to the outside.

For stubborn dirt, clean it using a soft cloth that has been dampened with a small amount of neutral detergent and then thoroughly wrung out. Then, dry off the inside of the printer with a dry, soft cloth.

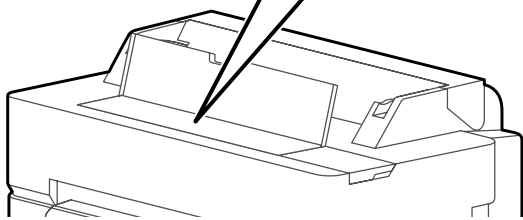
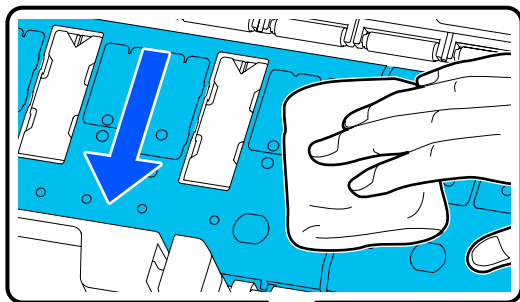

- 5** If any paper particles (resemble white powder) have accumulated in the holes shown in the illustration below, use a pointed object such as a toothpick to push them in.

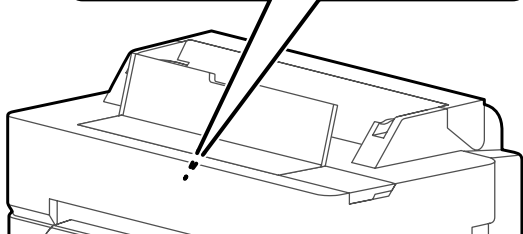
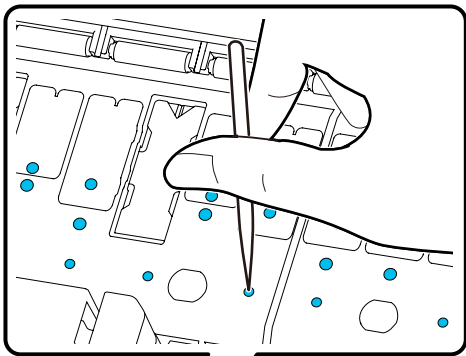

- 6** Remove paper particles and dust around the outer edges with commercially available cotton swabs.

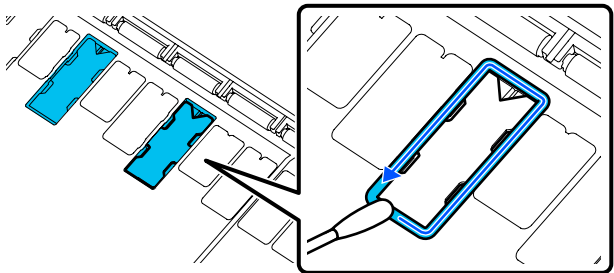

- 7** After cleaning, close the front cover.

**Replacing the pads for borderless printing**

Obtain the Borderless Replacement Pad Kit for this printer and then replace the pads for borderless printing.

[👉 “Options and Consumable Products” on page 214](#)

When replacing the pads for borderless printing, replace only the ones at the places where soiling occurs on the paper back side. There is no need to replace all of the pads for borderless printing.

You can see the procedure in a video on YouTube.

[Epson Video Manuals](#)

- 1** Turn the printer off and make sure that nothing is displayed on the screen, and then unplug the power cable from the outlet.
- 2** Leave the printer for a minute after removing the power plug.
- 3** Open the front cover.

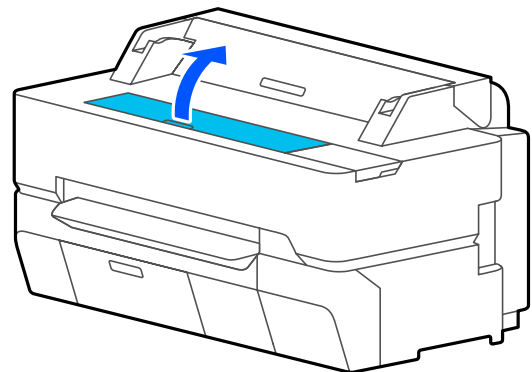

**Problem Solver**

- 4** Use tweezers to pull out the pads for borderless printing that are located at the places where soiling occurs.

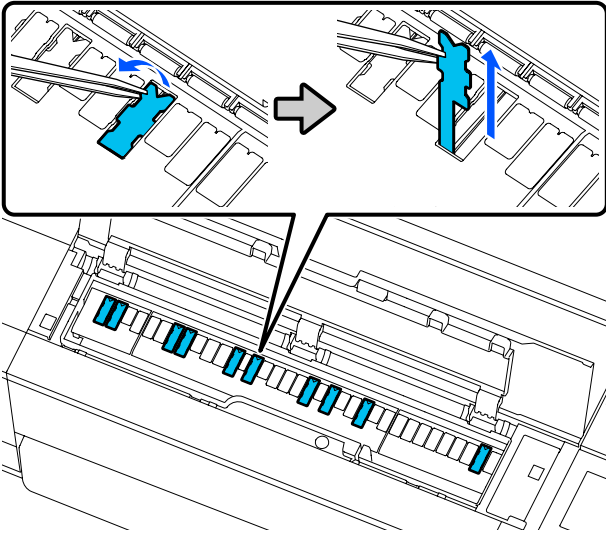

- 5** Use cleaning sticks to wipe off all ink that has accumulated at the following three places.

**Bottom**

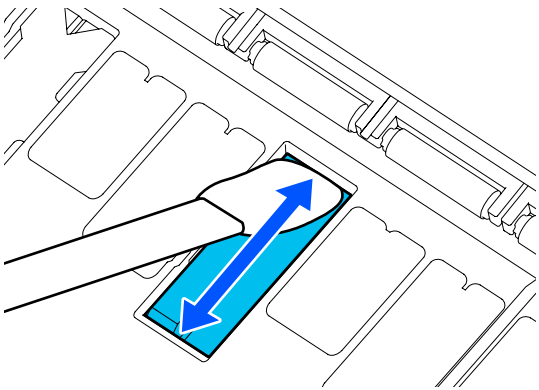

**Sides**

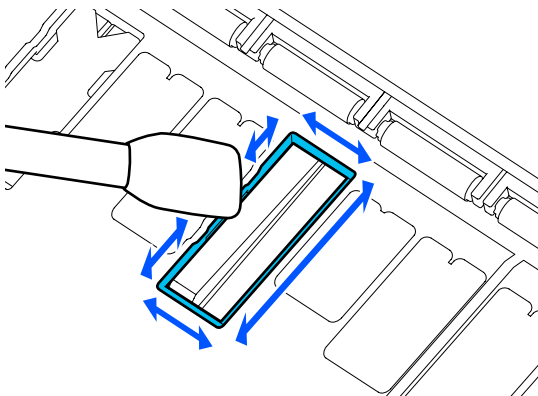

**Center groove**

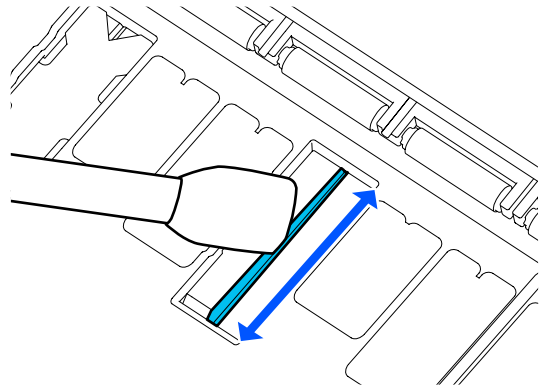

- 6** Bend a new pad for borderless printing as shown in the illustration.

**! Important:**

*Do not bend the new pads for borderless printing at other than the specified place.*

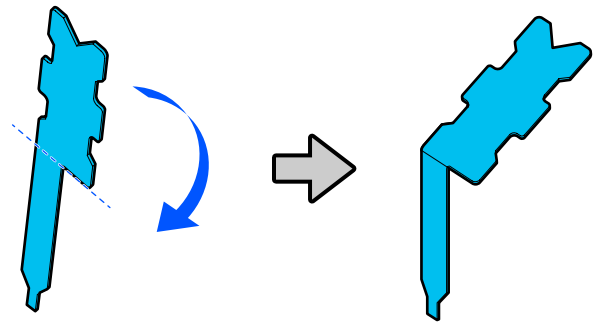

**Problem Solver**

- 7** Insert the leg of the pad for borderless printing all the way into the hole.

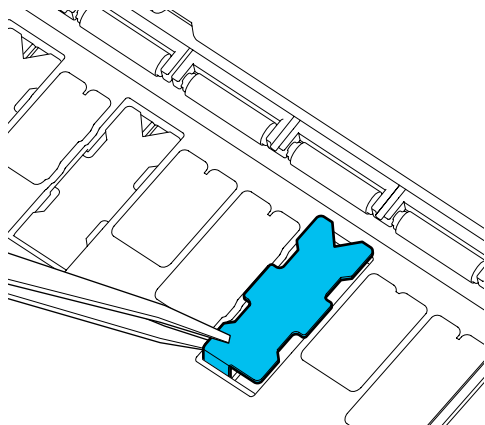
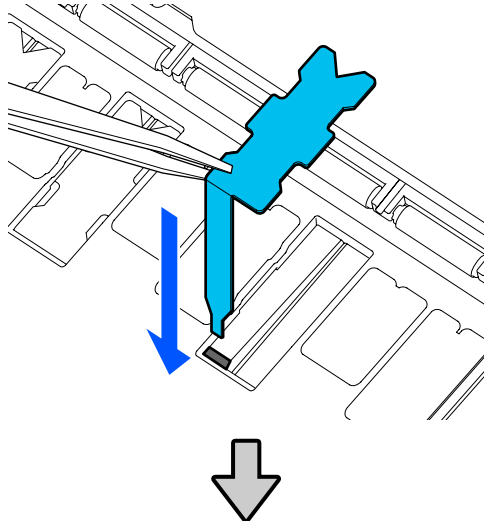

- 8** Push the protrusions on the left and right of the pads for borderless printing into the grooves on the left and right.

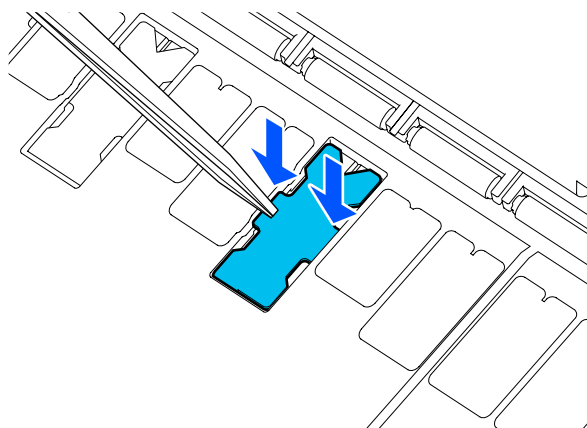

- 9** Gently press the pad for borderless printing until it is seated flatly in place.

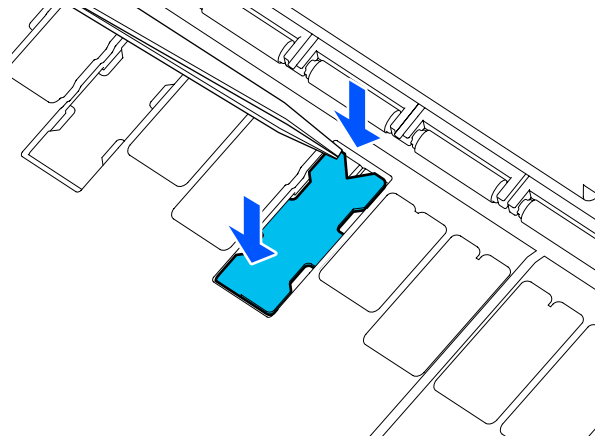

**! Important:**

*Make sure that no portion of the pads for borderless printing is higher than the surrounding surface.*

*If any portion of the pads is higher than the surrounding surface, it will rub against the print head and may result in printer failure.*

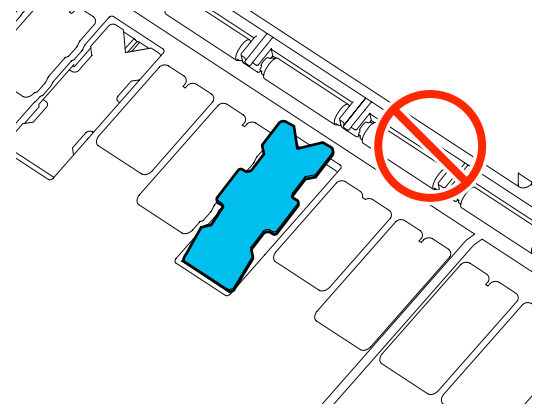

- 10** Close the front cover.

Dispose of the used pads for borderless printing and cleaning sticks.

 [“Handling of Used Consumables” on page 183](#)

To store any unused new pads for borderless printing, return them into the bag and close the fastener.

## Problem Solver

### ■ Is ink dry on the printed surface?

Depending on the printing density and media type, the ink may take a while to dry. Do not stack the paper until the printed surface is dry.

Additionally, setting the drying time on the printer in **Roll Paper - Advanced Media Setting - Drying Time - Drying Time per Page** to a longer time will stop post-print processing (ejection, cutting), waiting for the paper to dry naturally.

 ["Roll Paper menu" on page 133](#)

## Blurred text, lines, and images

### ■ Is the Media Type setting correct?

Confirm that the paper type selected with the printer matches the paper being used, and that the printer driver Media Type settings are **Use Printer Settings**. The amount of ink to be fired is controlled according to the media type. If the settings do not match the paper loaded, too much ink may be fired.

 ["Setting Loaded Paper" on page 42](#)

### ■ Is the Color Density setting appropriate?

On the printer driver Advanced screen, click **Paper Configuration**, and decrease the ink density. The printer may be printing with much ink for some paper. We recommend that black and color densities be decreased similarly.

### ■ Are you printing on tracing paper?

If too much ink is discharged, on the printer driver Advanced screen, click **Paper Configuration**, and decrease the ink density. Alternatively, changing **Paper Type** to **Tracing Paper <LowDuty>** may result in an improvement.

## Printed over the barcode for Manage Remaining Amount

### ■ Depending on the paper, the printer may not be able to read the barcode for Manage Remaining Amount.

Set Setup to Off to use the printer. Touch, in order from the Home screen, Roll paper information area - **Manage Remaining Amount**, and then change **Setup** from **On** to **Off**.

## Feeding or ejecting problems

### Unable to feed or eject paper.

#### ■ Is the paper loaded in the correct position?

See the following for the correct paper loading positions.

 ["Loading Roll Paper" on page 33](#)

 ["Loading Cut Sheet \(1 sheet\)" on page 40](#)

#### ■ Is the paper loaded in the correct direction?

Load cut sheets vertically. If they are not loaded in the correct direction, the paper may not be recognized and an error may occur.

 ["Loading Cut Sheet \(1 sheet\)" on page 40](#)

#### ■ Is the paper wrinkled or creased?

Do not use old paper or paper with creases in it. Always use new paper.

#### ■ Is the paper damp?

Do not use paper that is damp. Also, Epson special media should be left in the bag until you intend to use it. If it is left out for a long time, the paper curls up and gets damp so that it does not feed properly.

#### ■ Is the paper wavy or curled?

If changes in temperature and humidity cause paper to become wavy or curled, the printer may not be able to recognize the paper size correctly.

Check the following points.

- Load the paper just before printing.
- Do not use wavy or curled paper.  
For roll paper, cut off the wavy or curled parts and then load it again.  
For cut sheets, use new paper.

 ["Notes on Loading the Paper" on page 32](#)

#### ■ Are the edges of the roll paper uneven?

Loading roll paper with the right and left edges uneven may cause paper feeding problems or paper meandering may occur during printing. Rewind the paper to make the edges even before using roll paper or use roll paper with no problem.

 ["Notes on Loading the Paper" on page 32](#)

## Problem Solver

### ■ Is the paper too thick or too thin?

Check that the paper specifications are compatible with this printer.

 "Epson Special Media" on page 214

 "Supported Commercially Available Paper" on page 220

### ■ Are you using the printer at normal room temperature?

Epson special media should be used at normal room temperature (temperature: 15 to 25°C, humidity: 40 to 60%). For information about paper from other manufacturers, see the documentation supplied with the paper.

### ■ Is paper jammed in the printer?

Open the front cover of the printer and check that there are no paper jams or foreign objects in the printer. If paper is jammed, see "Roll paper jam" or "Cut sheets jam" below and clear the jammed paper.

## Roll paper skews while printing

### ■ If Roll paper is meandering. keeps appearing during printing and printing stops, first load the paper again, and then try setting the Back Tension settings to High.

Do the settings by touching, in order from the Home screen, Roll paper information area (from the Home screen) - **Advanced Media Setting - Back Tension - High**.

## Paper does not collect in the paper basket or is creased or folded

### ■ Does the print job require a lot of ink, or is the humidity of the workplace high?

Depending on the job and the work environment, paper may not collect in the paper basket. Take the following measures as appropriate.

- Paper does not collect in the paper basket: Use your hands to lightly press the paper into the paper basket as it is ejected from the printer.
- The paper folds after it has been cut automatically: Select manual cutting and take the paper in both hands after it is cut.
- The paper creases and does not collect well in the paper basket: Resume printing after closing the paper basket. Before the paper ejected from the printer touches the floor, take it in both hands close to the paper eject slot and continue to lightly support it until printing is complete.

## Roll paper jam

To remove jammed paper, follow the steps below:

- 1 Open the cut sheet cover and the roll paper cover.

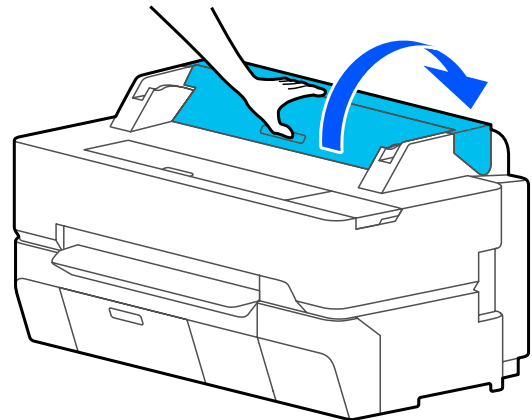

- 2 Cut the top portion of any torn or crinkled areas using a commercially available cutter.

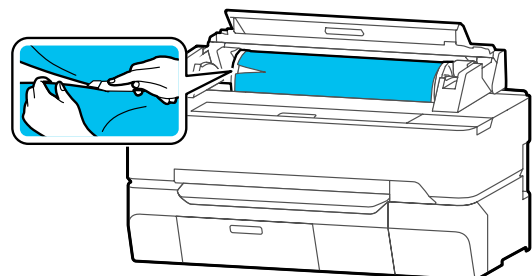

**Problem Solver**

**3** Close the roll paper cover and cut sheet cover.

**4** When ejecting paper from the front, grasp the paper with both hands, and slowly pull it out towards you.

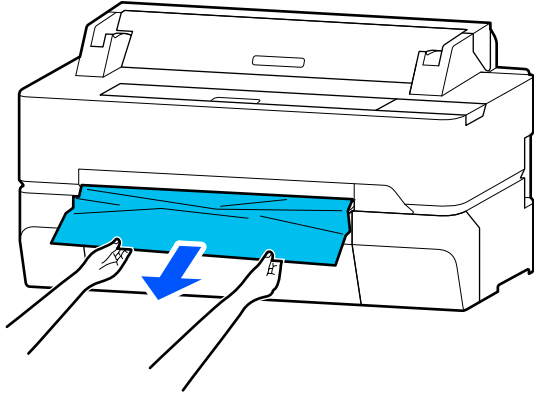

**5** Open the front cover.

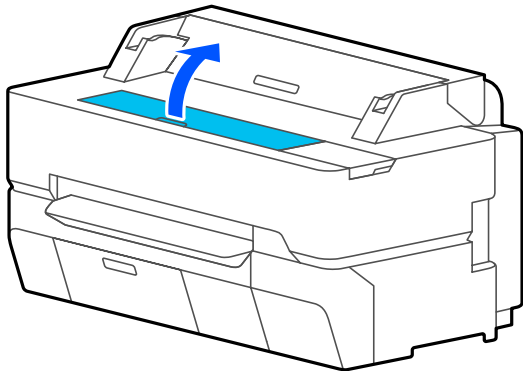

**6** Remove the jammed paper and then close the front cover.

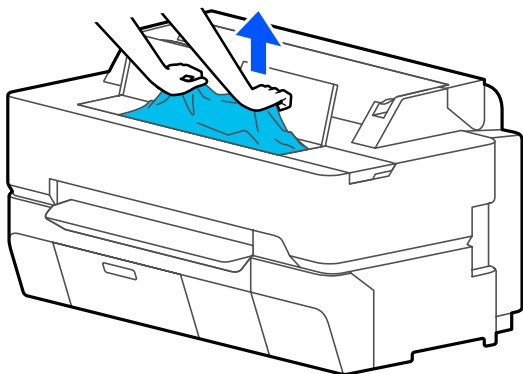

**! Important:**

*Do not touch the print head. If you touch the print head with your hand, static electricity may cause a malfunction.*

**7** If **Then turn the power off and on again** is displayed on the screen, turn off the printer, and then turn it back on.

After removing the paper, reload the paper and restart printing.

[“Loading Roll Paper” on page 33](#)

**! Important:**

*Before you reload the roll paper, cut the edge straight horizontally. Cut any wavy or creased sections.*

*If there are any wrinkles on the edge, then paper may not be fed, or it may jam.*

**Cut sheets jam**

To remove jammed paper, follow the steps below:

**1** Open the front cover.

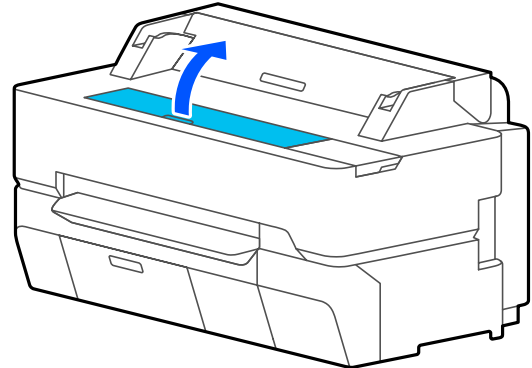

**2** When ejecting paper from the front, grasp the paper with both hands, and slowly pull it out towards you.

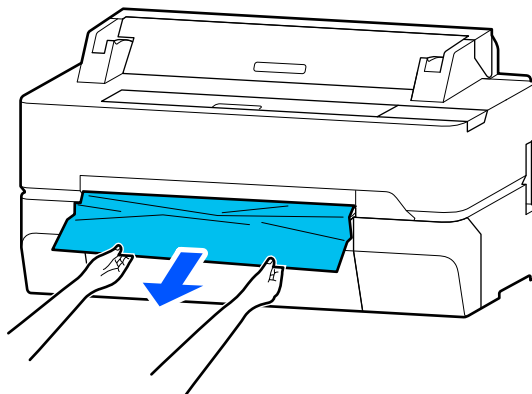

**Problem Solver**

- 3** Remove the jammed paper, then close the front cover.

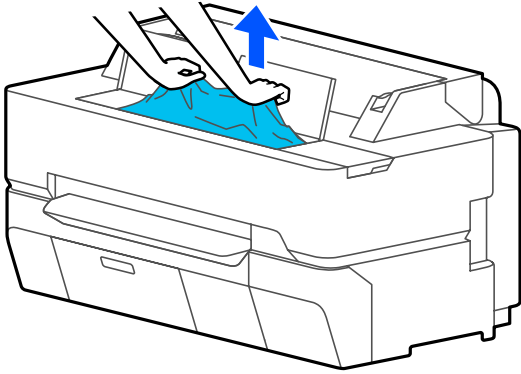

**!** **Important:**  
 Do not touch the print head. If you touch the print head with your hand, static electricity may cause a malfunction.

- 4** If **Then turn the power off and on again.** is displayed on the screen, turn off the printer, and then turn it back on.

After removing the paper, reload the paper and restart printing.

 [“Loading Cut Sheet \(1 sheet\)” on page 40](#)

**Original Is Jammed (SC-T5400M Series Only)**

To remove a jammed original, follow the steps.

- 1** Open the scanner cover.

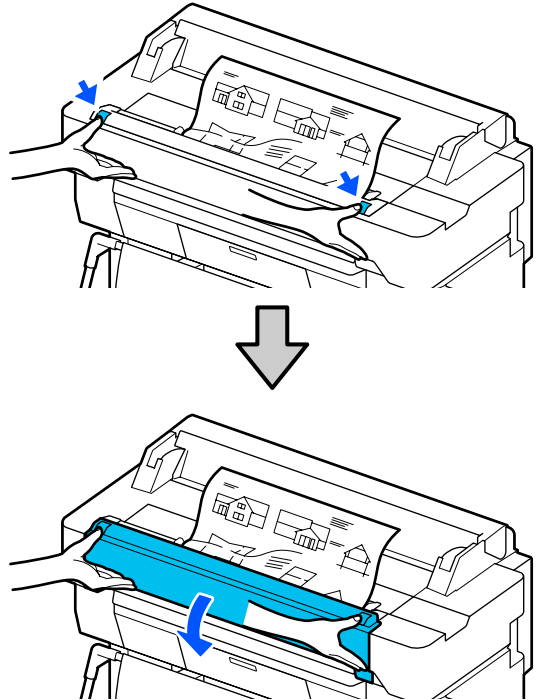

**!** **Important:**  
 Do not lean against or place objects on the scanner cover.

- 2** Remove the jammed original.

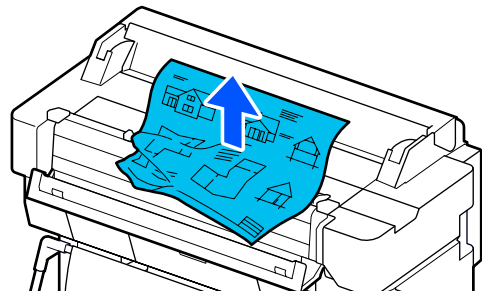

- 3** Close the scanner cover.

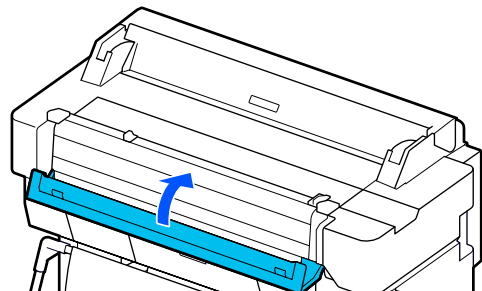



## Problem Solver

### Others

#### The control panel display keeps turning off.

- **Is the printer in sleep mode?**

Sleep mode is exited if a print job is received or the screen of the control panel is touched. The delay before entering sleep mode can be changed from the Basic Settings menu.

[👉 "General Settings - Basic Settings" on page 140](#)

#### Color ink runs out quickly even when printing in the Black&White mode or when printing black data.

- **Color ink may be consumed even if in printing in black and white mode, or printing black data.**

- **Color ink is also consumed during the print head cleaning process.**

When performing **Head Cleaning** or **Powerful Cleaning**, ink of all colors will be consumed even if black and white mode is selected.

#### The paper is not cut cleanly.

- **Replace the cutter.**

If the paper is not cut cleanly, replace the cutter.

[👉 "Replacing the Cutter" on page 186](#)

#### A light is visible inside the printer.

- **This is not a failure.**

The light is a light inside the printer.

#### The administrator password has been lost

- Should you forget the administrator password, contact your dealer or Epson Support.

### Print head is automatically cleaned

- To ensure print quality, the printer may automatically perform head cleaning when the printer is turned on or before starting printing.

### The printer turned off due to a power cut

- **Turn off the printer, and then turn it back on.**

When the printer is not turned off normally, the print head may not be capped correctly. If the print head is left uncapped for a long time, the print quality may decline.

When you turn on the printer, capping is performed automatically after a few minutes.

## Copying or Scanning Problems (SC-T5400M Series Only)

### Lines Appear on Scanned or Copied Documents

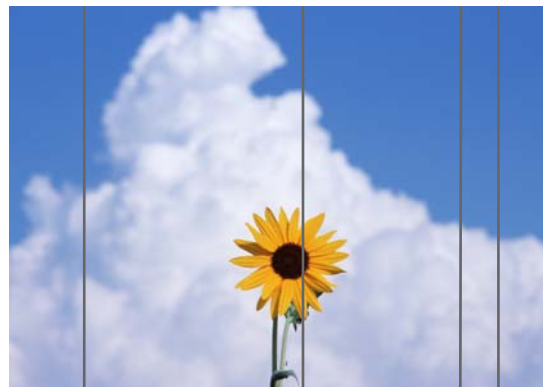

Follow the steps below to clean the inside of the scanner. Dust or dirt that is stuck to the rollers or the scanner's glass surface may cause unwanted lines or marks on copy results and scanned images.

If the rollers or the scanner's glass surface is very dirty, use the optional cleaning kit. Add a small amount of cleaner to the cleaning cloth and wipe off the dirt.

[👉 "Options and Consumable Products" on page 214](#)

**Problem Solver**

**! Important:**

- ❑ Do not use volatile chemicals, such as alcohol or paint thinners. Deformation or discoloration could occur.
- ❑ Do not apply liquids to or directly spray lubricant on the scanner. Otherwise the equipment and circuits may become damaged, so the printer may not operate correctly.

**1** Open the scanner cover.

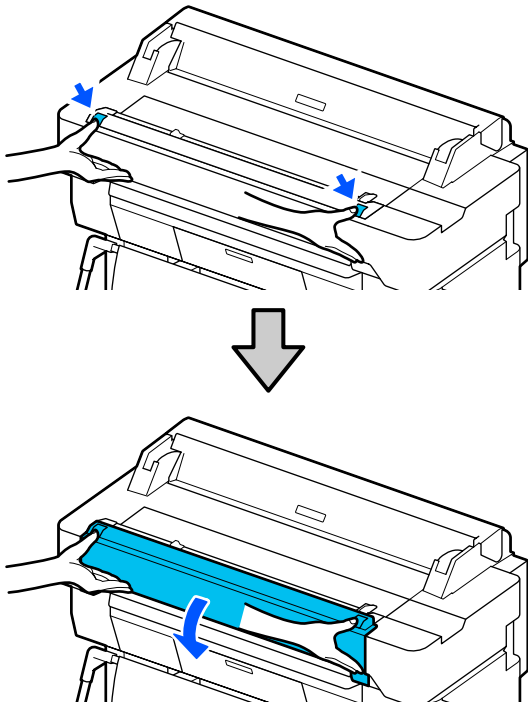

**2** Using a soft cloth, wipe off any dust, dirt, or paper particles (resembles white powder). Thoroughly wipe the area shown in blue in the illustration below.

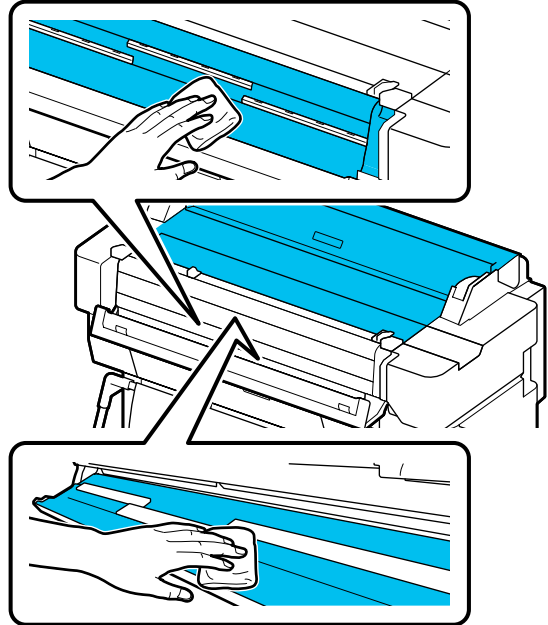

**3** Use the cleaning kit, or the clean side of the soft cloth, to thoroughly wipe the area shown in blue in the illustration below.

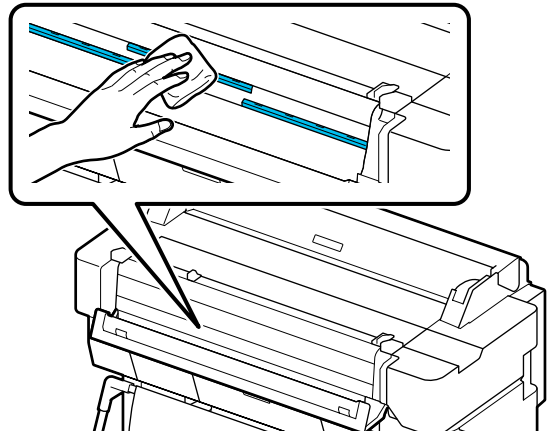

## Problem Solver

- 4** Use the cleaning kit, or the clean side of the soft cloth, to wipe the glass surface.

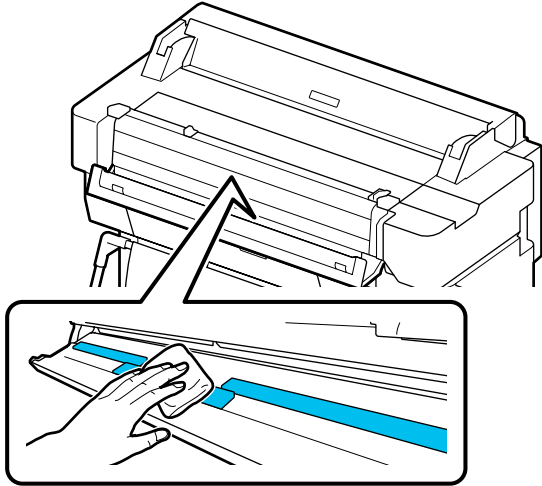

**! Important:**

- Do not apply excessive force to glass surfaces.
- Do not use brushes or hard objects. They may scratch the glass surface and affect the scan quality.
- Do not directly spray cleaner onto the glass surface.

- 5** After you have finished cleaning, close the scanner cover.

**! Important:**

Close the scanner cover right after you have finished cleaning to prevent dust from getting inside.

### Unable to Properly Feed Originals

If the right side of the original's loading position is incorrect, the original cannot be fed properly.

Check the position of the document guide on the right side.

### If you do not want to use the optional carrier sheet

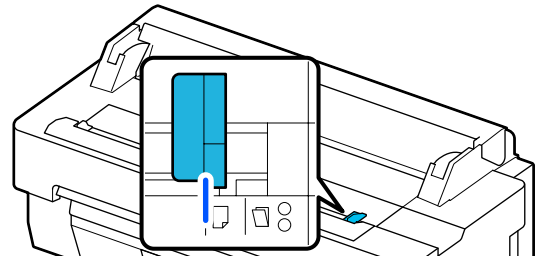

If the original's loading position is correct, check the following items. If the original still cannot be fed properly, change **Original Size** or **Scan Size** to the standard size from **Auto Detect**.

■ **Is the original loaded with skew?**

Reload the original. If the original is loaded with skew, it cannot be fed properly.

■ **Is the original folded?**

Unfold the original.  
If the original is folded while the printer is set to **Auto Detect** in **Original Size** or **Scan Size**, the width of the original may not be read correctly, which may cause the original to not feed properly.

■ **Clean inside of the scanner.**

If the printer is set to **Auto Detect** in **Original Size** or **Scan Size**, the width of the original may not be read correctly, which may cause the original to not feed properly.

How to Clean Inside the Scanner  
 ["Lines Appear on Scanned or Copied Documents" on page 209](#)

### If you are using the optional carrier sheet

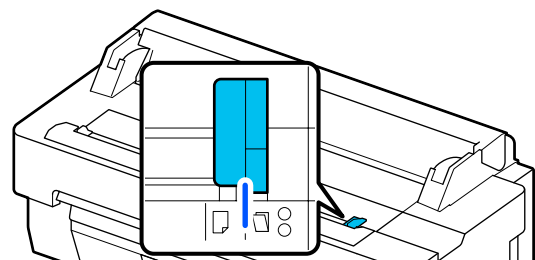

### Problem Solver

**■ Is the original loaded with skew?**  
 Reload the original. If the original is loaded with skew, it cannot be fed properly.

### Scanned Image Is Misaligned

**■ Change the direction that the original is loaded.**  
 Changing the direction that the original is loaded may improve scan results.

**■ Is the original curled?**  
 If the original is curled, smooth out the original and place it flat. Then scan the original.

**■ Try Image Stitching Adjustment.**  
 Doing Image Stitching Adjustment may improve scan results.  
[☞ "Lines Appear on Scanned or Copied Documents" on page 209](#)

**■ Try using the optional carrier sheet.**  
 Putting the original into the carrier sheet smooths out any wrinkles and may improve scan results.

### Document Feed Adjustment

If the print results and the length of the original of copied or scanned files do not match, use the following procedure to do Document Feed Adjustment. If you want to shorten the length of the print out, press the minus button. If you want to lengthen it, press the plus button. Differences in length may occur due to the type of paper used for printing.

- 1** Touch **Settings** on the Home screen.
- 2** Touch, in order, **General Settings - Scan Settings - Scan Options - Document Feed Adjustment**.  
 The adjustment value settings screen appears. The adjustment values are shown in %.

- 3** Either touch - or + to show the intended adjustment values or touch the adjustment entry area to enter the adjustment values via the keyboard screen.

Adjustment values are determined as shown below.

Example) When the length of the original is 50 cm and the print result is 50.1 cm:  
 $50/50.1 \times 100 - 100 = -0.1996$ , rounded at the second decimal.

Adjustment value: -0.2

- 4** Touch **OK**.

### Image Stitching Adjustment

As for the original ( **A** ) shown in the figure below, if a misalignment occurs in the scanned image, such as in **B** , do Image Stitching Adjustment using the following procedure.

The arrow in **B** indicates the feed direction of the original.

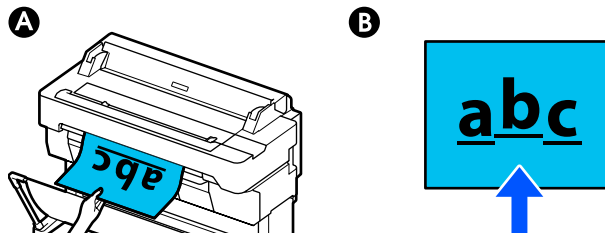

- 1** Touch **Settings** on the Home screen.
- 2** Touch, in order, **General Settings - Scan Settings - Scan Options - Image Stitching Adjustment**.  
 The adjustment value settings screen appears.
- 3** Either touch - or + to show the intended adjustment values or touch the adjustment entry area to enter the adjustment values via the keyboard screen.  
 Shifting the adjustment value by 1 will correct the misalignment by about 0.1 mm in the actual size.

**Problem Solver****When the Scan Results Are Shifted Up in Relation to the Feed Direction of the Original**

Set the adjustment value toward the plus sign.

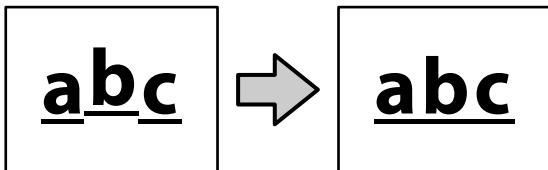
**When the Scan Results Are Shifted Down in Relation to the Feed Direction of the Original**

Set the adjustment value toward the minus sign.

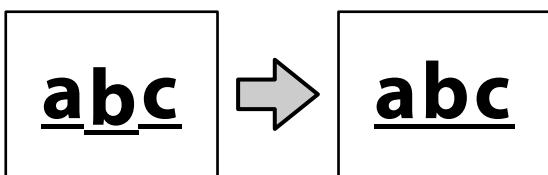
**4**

Touch OK.

## Appendix

---

# Appendix

---

## Options and Consumable Products

The following options and consumable products are available for use with your printer. (As of July, 2018)

For the latest information, see the Epson Web site.

---

### Epson Special Media

 [“Epson Special Media Table” on page 216](#)

---

### Ink Cartridges

Epson recommends the use of genuine Epson ink cartridges. Epson cannot guarantee the quality or reliability of non-genuine ink. The use of non-genuine ink may cause damage that is not covered by Epson's warranties, and under certain circumstances, may cause erratic printer behavior.





Information about non-genuine ink levels may not be displayed, and use of non-genuine ink is recorded for possible use in service support.

Printer model	Ink color	Product Number	
		350 ml	110 ml
SC-T5400	Black	T41F5	T41R5
SC-T5400M	Cyan	T41F2	T41R2
SC-T3400	Magenta	T41F3	T41R3
SC-T3400N	Yellow	T41F4	T41R4
SC-T5430	Black	T41D5	T41Q5
SC-T5430M	Cyan	T41D2	T41Q2
SC-T3430	Magenta	T41D3	T41Q3
	Yellow	T41D4	T41Q4
SC-T5460	Black	T41M5	T41V5
SC-T5460M	Cyan	T41M2	T41V2
SC-T3460	Magenta	T41M3	T41V3
SC-T3460N	Yellow	T41M4	T41V4

## Appendix

Printer model	Ink color	Product Number	
		350 ml	110 ml
SC-T5480	Black	T41K5	T41U5
SC-T5480M	Cyan	T41K2	T41U2
SC-T3480N	Magenta	T41K3	T41U3
	Yellow	T41K4	T41U4

## Others

Product	Part number	Explanation
Maintenance Box	T6997	Replacement Maintenance Box for when there is insufficient empty space in the Maintenance Box.  <a href="#">"Replacing Maintenance Box" on page 185</a>
Auto Cutter Spare Blade	S902007	 <a href="#">"Replacing the Cutter" on page 186</a>
Roll Feed Spindle (36") (except for SC-T5480/SC-T3480N)	C12C933301	This is the same as the roll paper spindle supplied with the printer. Select the width in accordance with a model you are using.
Roll Feed Spindle (36") (for SC-T5480/SC-T3480N)	C12C933311	
Roll Feed Spindle (24") (except for SC-T5480/SC-T3480N)	C12C933281	
Roll Feed Spindle (24") (for SC-T5480/SC-T3480N)	C12C933291	
Borderless Replacement Pad Kit	S400064	Pads for borderless printing.  <a href="#">"The reverse side of the printed paper is soiled." on page 201</a>
Document Carrier Sheet (A0)	C12C935381	Used when loading thin originals and originals that you do not want to damage when copying or scanning.  <a href="#">"When loading documents that are thin, that are easily torn, or that you do not want to damage" on page 102</a>
Cleaning Kit	B12B819291	Used when cleaning the inside of the scanner if there are marks when copying or scanning.  <a href="#">"Lines Appear on Scanned or Copied Documents" on page 209</a>

## Appendix

# Supported Media

We recommend you use the following Epson special media for high-quality printing results. Refer to the following for supported commercially available paper.

 [“Supported Commercially Available Paper” on page 220](#)

---

## Epson Special Media Table

Epson paper supported by this printer is described below. (As of August, 2019)

The titles of the tables below have the following meanings.

- Paper name  
Brand name of paper.
- Size  
Provided paper sizes. The paper width is indicated in the case of roll paper.
- Borderless  
Describes whether borderless printing is available.  
✓: available, ✓\*: available but not recommended, -: not available
- Auto media adjust  
Describes the availability of auto media adjustments (Easy Adjustment, Paper Feed Adjust(Auto) , and Print Head Alignment(Auto)). ✓: available, ✓\*: available but may be less effective, -: not available

**Note:**

The paper names in the following table are displayed by the paper type settings in the menu of the printer driver or the printer. Some parts of paper names may be omitted.

Example: Premium Glossy Photo Paper (170) may be abbreviated to Premium Glossy 170.

## Roll Paper

Not all paper types and sizes are available in all countries or regions.

Paper Name	Size	Borderless	Auto media adjust
Singleweight Matte Paper	420 mm/A2	-	
	432 mm/17 in.		
	515 mm/B2		
	594 mm/A1	✓	✓*
	610 mm/24 in.		
	728 mm/B1*		
	914 mm/36 in.*		



## Appendix

Paper Name	Size	Borderless	Auto media adjust
Doubleweight Matte Paper	594 mm/A1		
	610 mm/24 in.	✓	✓
	728 mm/B1*		
	914 mm/36 in.*		
Premium Glossy Photo Paper (170)	420 mm/A2	-	
	594 mm/A1		
	610 mm/24 in.	✓	✓
	728 mm/B1*		
Premium Semigloss Photo Paper (170)	420 mm/A2	-	
	594 mm/A1		
	610 mm/24 in.	✓	✓
	728 mm/B1*		
Enhanced Synthetic Paper	432 mm/17 in.		
	610 mm/24 in.	✓*	✓*
	914 mm/36 in.*		
Enhanced Adhesive Synthetic Paper	610 mm/24 in.	✓*	✓*
	914 mm/36 in.*		
Enhanced Low Adhesive Synthetic Paper	610 mm/24 in.	✓*	✓*
	914 mm/36 in.*		
Backlight Film Roll	610 mm/24 in.	✓*	✓*
	914 mm/36 in.*		

\* Available only with SC-T5400 Series.

## Cut Sheet

Not all paper types and sizes are available in all countries or regions.

**Appendix**

<b>Paper Name</b>	<b>Size*</b>	<b>Borderless</b>	<b>Auto media adjust</b>
Photo Quality Inkjet Paper	A4		
	Letter	-	
	Legal		
	A3		
	A3+ SuperB	✓*	✓*
	A2	-	
	US-C	✓*	
Archival Matte Paper	A4		
	Letter	-	
	A3		
	A3+ SuperB	✓	✓
	A2	-	
	US C	✓	
Photo paper Glossy	A4		
	Letter	-	
	A3		
	A3+ SuperB	✓	✓
	US-B	-	
Premium Glossy Photo Paper	A4		
	Letter	-	
	11 x 14 in.		
	A3		
	A3+ SuperB	✓	✓
	A2	-	
	US-C	✓	

**Appendix**

<b>Paper Name</b>	<b>Size*</b>	<b>Borderless</b>	<b>Auto media adjust</b>
Premium Semigloss Photo Paper	A4		
	Letter	-	
	A3		
	A3+ SuperB	✓	✓
	A2	-	
	US-C	✓	
Premium Luster Photo Paper	A4		
	Letter	-	
	A3		✓
	A2	-	
	US-C	✓*	

## Appendix

### Supported Commercially Available Paper

This printer supports the following paper specifications for non-Epson media.

 **Important:**

- Do not use paper that is wrinkled, scuffed, torn, or dirty.
- Commercially available paper corresponding to the paper types in the table can be loaded in and fed through the printer as long as they meet the following specifications, however Epson cannot guarantee the print quality.
- Commercially available paper types not in the table can be loaded in the printer as long as they meet the following specifications, however Epson cannot guarantee the feed and print quality.

#### Roll Paper

Paper type	Plain paper, coated paper, photo paper, tracing paper, matte film, backlight film
Roll core size	2 inches and 3 inches * * Only plain paper with a 3-inch core is supported.
Roll paper outer diameter	170 mm or less
Paper width	SC-T5400 Series/SC-T5400M Series: 254 to 914 mm (36 inches) SC-T3400 Series/SC-T3400N Series: 254 to 610 mm (24 inches)
Paper thickness	0.08 to 0.3 mm
Roll weight	12 kg or less

#### Cut Sheet (1 Sheet)

Paper type	Plain paper, coated paper, photo paper, tracing paper, matte film
Paper width	SC-T5400 Series/SC-T5400M Series: 210 to 914 mm (36 inches) SC-T3400 Series/SC-T3400N Series: 210 to 610 mm (24 inches)
Length	279.4 mm (Letter) to 1,580 mm
Paper thickness	0.08 to 0.3 mm

#### Paper Widths Supported for Borderless Printing (Common for Both Roll Paper and Cut Sheet)

Printing borderless at the top, bottom, left, and right is possible for roll paper. Printing borderless is possible only at the left and right for cut sheet.

**Appendix**

254 mm / 10 inches	A1 / 594 mm
300 mm / 11.8 inches	A1+ / ARCH D / 610 mm / 24 inches
A3+ / 329 mm / 13 inches	700 mm / 27.5 inches*
406 mm / 16 inches	JIS B1 / 728 mm*
A2+ / US C / 432 mm / 17 inches	A0 / 841 mm*
ISO B2 / 500 mm	A0+ / ARCH E / 914 mm / 36 inches*
JIS B2 / 515 mm	

\* Only supported by SC-T5400 Series/SC-T5400M Series

## Appendix

### Before Printing on Commercially Available Paper

When using commercially available paper, select the paper type setting that matches to the paper from the following settings.

- Plain paper
- Coated Paper (Generic)
- Photo Paper (Generic)
- Tracing Paper
- Tracing Paper <LowDuty>
- Matte Film

Refer to the following if there is banding, wrinkling, smearing, or uneven colors in the printing results.

 [“The prints are not what you expected” on page 193](#)

### When using Commercially Available Synthetic, Canvas or Film-type Paper

Before printing, carry out one of the following.

- Add as a new paper type setting (register as custom paper), and carry out media adjust.  
From the Home screen, touch **Settings - General Settings - Printer Settings - Custom Paper Setting**, and register a custom paper. After registering the paper, perform Media Adjust. Paper adjustment results will be saved as the newly added paper type settings.  
Refer to the following menu for details on custom paper settings.  
 [“General Settings - Printer Settings” on page 142](#)
- Select the paper type from the following Epson Special Media settings, and perform Media Adjust.  
Enhanced Adhesive Syn., Enhanced Low Adh. Syn., Heavyweight Polyester, Glossy Film2, Backlight Film Roll  
By performing the Media Adjust, paper settings for Epson Special Media will be overwritten by the settings for the paper you use.

There are automatic and manual paper adjustments. We recommend manual adjustments for Synthetic, Canvas, or Film-type Paper. If automatic adjustments are made, an error may occur or the effect of adjustment may be minimal.

 [“Paper Feed Adjust \(Manual\) Procedure” on page 195](#)

 [“Print Head Alignment \(Manual\) Procedure” on page 195](#)

**Note:**

*Test the print quality with this printer before purchasing a large amount of paper.*

Appendix

# Printable area

This section describes the printable areas for the printer.

If the print range settings in application software are larger than the following printer printable areas, sections beyond the specified margins are not printed.

## Roll Paper

The gray area in the illustration below shows the printable area.

When printing borderless at the left and right, the left and right margins will be 0 mm. When printing borderless at all edges, all margins will be 0 mm.

The arrow in the illustration indicates the direction that the paper is ejected.

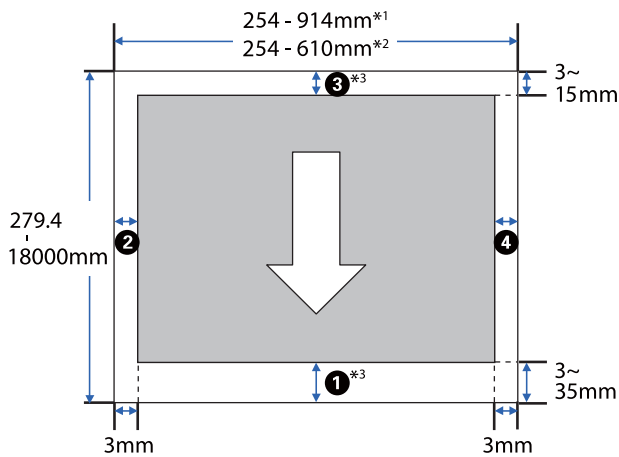

- \*1 SC-T5400 Series/SC-T5400M Series
- \*2 SC-T3400 Series/SC-T3400N Series
- \*3 In the printer driver **Layout** screen, selecting **Print Banner** sets the top and bottom margins of the paper to 0 mm.

Margins for roll paper depend on the settings values for **Top/Bottom Margins** in the menu, as shown in the table below.

Settings of **Top/Bottom Margins**  
 ☞ [“Roll Paper menu” on page 133](#)

The default setting is **Standard**.

Settings of Top/Bottom Margins	Margin Values
Standard	①,③ = 15 mm*
	②,④ = 3 mm
Top 3 mm/Bottom 3 mm	①,③ = 3 mm
	②,④ = 3 mm
Top 15 mm/Bottom 15 mm	①,③ = 15 mm
	②,④ = 3 mm
Top 35 mm/Bottom 15 mm	① = 35 mm
	③ = 15 mm
	②,④ = 3 mm
3 mm	①,②,③,④ = 3 mm
5 mm	①,②,③,④ = 5 mm

\* If **Standard** is selected when the following two conditions are met, then the top and bottom margins will be 3 mm.

- The paper type settings are one of the following Singleweight Matte, Coated Paper(Generic), Plain paper, Plain Paper Thin, Plain Paper Thick, Tracing Paper, Tracing Paper <LowDuty>, Matte Film
- The printer driver print targets are one of the following CAD/Line Drawing - Black, CAD/Line Drawing - Color, CAD/Line Drawing - Bi-Level

**Appendix**

**Important:**

- ❑ *Printing is distorted when the trailing edge of the roll paper comes off the core. Make sure the trailing edge does not come inside the printing area.*
- ❑ *If the print range settings width **A** is smaller than the print data width **B**, then the sections beyond the printable width **C** will not be printed.*

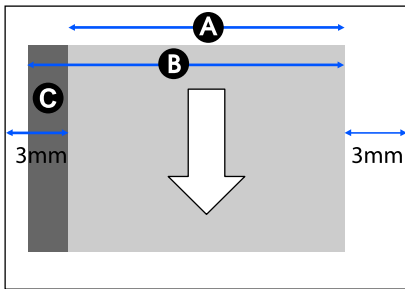

\*4 SC-T5400M Series. The top and bottom margins vary depending on the print quality setting (Speed, Fine, etc.).

**Cut Sheet**

When printing borderless at the left and right, the left and right margins will be 0 mm.

The gray area in the illustration below shows the printable area. The arrow in the illustration indicates the direction that the paper is ejected.

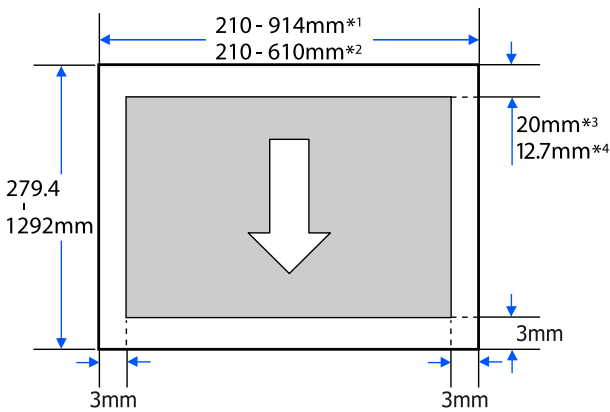

- \*1 SC-T5400 Series/SC-T5400M Series
- \*2 SC-T3400 Series/SC-T3400N Series
- \*3 SC-T5400 Series/SC-T3400 Series/SC-T3400N Series. The top and bottom margins vary depending on the print quality setting (Speed, Fine, etc.).



Appendix

# Moving or Transporting the Printer

This section describes methods for moving and transporting the product.

## Notes for Moving or Transporting the Printer

- ❑ The printer is heavy, so ensure more than one person is used for these actions. When packing and moving the printer, make sure that it is carried by the following number of persons.  
 SC-T5400 Series/SC-T5400M Series: 3 or more persons  
 SC-T3400 Series/SC-T3400N Series: 2 or more persons
- ❑ When you lift the printer, maintain a natural posture.
- ❑ When you lift the printer, place your hands at the specified locations on the left and right as indicated in the following illustration. If you lift the printer while holding other sections, you may be injured. For example, you may drop the printer or your fingers may be pinched when lowering the printer.

SC-T5400 Series/SC-T5400M Series

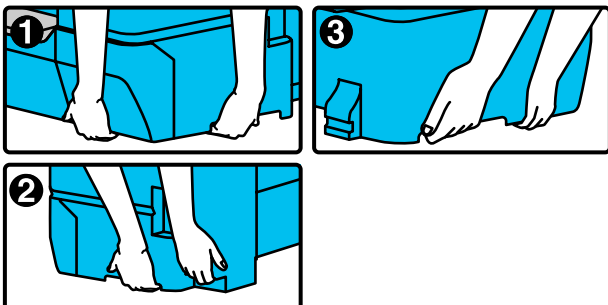
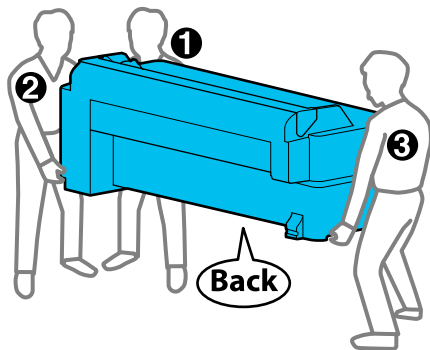

SC-T3400 Series/SC-T3400N Series

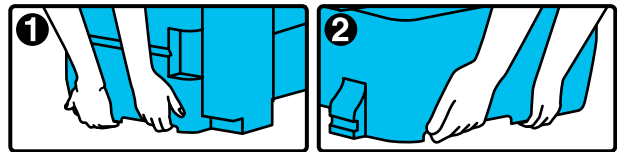
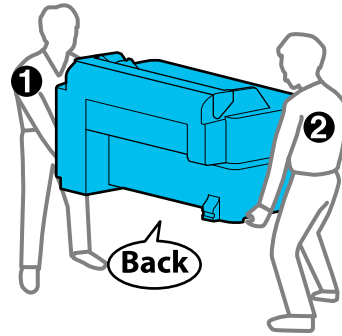

- ❑ Do not tilt the product more than 10 degrees forward, back, left, or right while moving it. Failure to observe this precaution could result in the printer falling over, causing accidents.

**! Important:**

*The print head may fail if the environmental temperature becomes -10°C or lower.*

*Eject the ink prior to turning off the power if you expect to be moving or transporting the printer in an environment of -10°C or below.*

*See the following procedure for detailed instructions.*

*☞ “Handling if Transporting/Leaving the Printer in an Environment of -10°C or Less” on page 226*

## Moving to a Different Location in the Same Building

### Preparations for Moving

This explains preparations for moving the printer a short distance, for example within the same building. See the following section for information on moving the printer between floors or to another building.

*☞ “When Transporting” on page 226*

## Appendix

For models with stands, moving the printer on casters is possible providing there are no steps or unevenness in the floor along the route, however pay attention to the following points.

### **Caution:**

*For models with stands, ensure that you abide by the following points in order to prevent damage from falling over.*

- Do not move the printer with casters locked
- Avoid areas with steps or unevenness
- After moving, ensure the casters are locked before use

### **Important:**

*Ensure you move and transport the printer with the ink cartridges installed. Do not remove the ink cartridges; otherwise, the nozzles may be clogged and make it impossible to print, or ink may leak.*

- 1** Remove all paper from the printer.
- 2** Close all covers on the printer. For models with stands, close the paper basket.
- 3** Turn off the printer, and unplug all cables, including the power cord and LAN cables, etc.
- 4** For models with stands, release the locks on the casters.

## Operations after Moving

This explains operations to prepare for use after moving the printer.

- 1** Connect the power cable, and turn the printer on.
- 2** Check for print head nozzle clogging, and if these are clogged, carry out print head cleaning.  
[👉 “When you want to unclog the print head” on page 196](#)

## When Transporting

Before transporting the printer, contact your dealer or Epson Support.

[👉 “Where To Get Help” on page 233](#)

## Handling if Transporting/ Leaving the Printer in an Environment of -10°C or Less

The print head may fail if the environmental temperature becomes -10°C or lower. Discharge the ink following the procedures below if you expect the printer to encounter environments of -10°C or below.

### **Important:**

*This procedure discharges ink into the Maintenance Box, therefore the Maintenance Box requires adequate remaining capacity. If the remaining capacity box is low, first prepare a new replacement Maintenance Box.*

- 1** If paper is loaded, remove all paper.  
[👉 “Removing Roll Paper” on page 38](#)  
[👉 “Removing Cut Sheet \(1 Sheet\)” on page 41](#)
- 2** From the Home screen, touch **Settings - Maintenance - Discharging/Charging Ink**.
- 3** Touch **Start**.  
Ink discharging starts, and the power turns off automatically when it finishes.

### **Important:**

*Do not open the cover or turn the printer off during ink discharge.*

After this, refer to the following for preparations for movement/transport.

[👉 “Moving to a Different Location in the Same Building” on page 225](#)

[👉 “When Transporting” on page 226](#)

## Appendix

# System Requirements

Software for this printer can be used in the following environments. (As of April, 2019)  
Supported OS and other elements may change.

For the latest information, see the Epson Web site.

---

## Printer Driver

### Windows

Operating system	Windows 10/Windows 10 x64 Windows 8.1/Windows 8.1 x64 Windows 8/Windows 8 x64 Windows 7/Windows 7 x64 Windows Vista/Windows Vista x64 Windows XP/Windows XP x64 Windows Server 2019 Windows Server 2016 Windows Server 2012 R2 Windows Server 2012 Windows Server 2008 R2 Windows Server 2008 Windows Server 2003 R2 Windows Server 2003 SP2 or later
CPU	Intel Core2 Duo 3.05 GHz or more
Available memory space	1 GB or more
Hard disk (Available volume to install)	32 GB or more
Display resolution	WXGA (1280×800) or better
Connection method with the printer*	USB, Ethernet, or Wi-Fi

\* For details on the connection methods (interface specifications), see the following.

 ["Specifications Table" on page 230](#)

### Mac

Operating system	Mac OS X v10.6.8 or later
CPU	Intel Core2 Duo 3.05 GHz or more
Available memory space	4 GB or more
Hard disk (Available volume to install)	32 GB or more
Display resolution	WXGA+ (1440×900) or better
Connection method with the printer*	USB, Ethernet, or Wi-Fi

\* For details on the connection methods (interface specifications), see the following.

 ["Specifications Table" on page 230](#)

## Appendix

### Web Config

Web Config is software installed in the printer that will run in a web browser on a computer or smart device connected to the same network as the printer.

 *Administrator's Guide*

#### Windows

Browser	Internet Explorer 11, Microsoft Edge, Firefox <sup>*1</sup> , Chrome <sup>*1</sup>
Connection method with the printer <sup>*2</sup>	Ethernet or Wi-Fi

\*1 Use the latest version.

\*2 See the following for details on the network interfaces.

 ["Specifications Table" on page 230](#)

#### Mac

Browser	Safari <sup>*1</sup> , Firefox <sup>*1</sup> , Chrome <sup>*1</sup>
Connection method with the printer <sup>*2</sup>	Ethernet or Wi-Fi

\*1 Use the latest version.

\*2 See the following for details on the network interfaces.

 ["Specifications Table" on page 230](#)

#### Smart device

Operating system	iOS <sup>*1</sup>
Connection method with the printer <sup>*2</sup>	Wi-Fi

\*1 Use the latest version.

\*2 See the following for details on the network interfaces.

 ["Specifications Table" on page 230](#)

## Appendix

### Epson Edge Dashboard

 **Important:**

*Make sure the computer on which the Epson Edge Dashboard is installed meets the following requirements.*

*If these requirements are not met, the software cannot monitor the printer correctly.*

- Disable your computer's hibernate function.*
- Disable the sleep function so that the computer does not enter sleep status.*

#### Windows

Operating system	Windows 10/Windows 10 x64 Windows 8.1/Windows 8.1 x64 Windows 8/Windows 8 x64 Windows 7 SP1/Windows 7 x64 SP1
CPU	Intel Core2 Duo 2.5 GHz or more
Available memory space	1 GB or more
Hard disk (Available volume to install)	10 GB or more
Display resolution	1024 × 768 or higher
Connection method with the printer	SuperSpeed USB Ethernet 1000Base-T
Browser	Windows Internet Explorer / Microsoft Edge Use the latest version. (Internet Explorer 11 or later)

#### Mac

Operating system	Mac OS X 10.7 Lion or later
CPU	Intel Core2 Duo 2.0 GHz or more
Available memory space	1 GB or more
Hard disk (Available volume to install)	10 GB or more
Display resolution	1024 × 768 or higher
Connection method with the printer	SuperSpeed USB Ethernet 1000Base-T
Browser	Safari 6 or higher

Appendix

# Specifications Table

The (A) to (D) letters used in the table represent the printer models as shown below.

- (A): SC-T5400 Series
- (B): SC-T3400 Series
- (C): SC-T3400N Series
- (D): SC-T5400M Series

Printer Specifications	
Printing method	PrecisionCore inkjet technology
Nozzle configuration	800 nozzles x 4 colors (Black, Cyan, Magenta, Yellow)
Resolution (maximum)	2400 x 1200 dpi
Control code	ESC/P raster (undisclosed command), HP-GL/2, HP RTL
Built-in memory	1.0 GB
Rated voltage	AC100-240 V
Rated frequency	50/60 Hz
Rated current	2.8 A
Power consumption	
Printing	(A), (D): Approx. 38 W (B): Approx. 34 W (C): Approx. 34 W
Ready mode	(A), (B), (C): Approx. 13 W (D): Approx. 19 W
Sleep mode	(A), (B), (C): Approx. 1.3 W (D): Approx. 1.6 W
Power off	Approx. 0.25 W
Temperature	
Printing	10 to 35 °C (15 to 25°C is recommended)
In storage (Before unpacking)	-20 to 60 °C (Within 120 hours at 60 °C, within a month at 40 °C)
In storage (After unpacking)	Ink charged: -10 to 40 °C (Within a month at 40 °C)  Ink discharged*1: -20 to 25 °C (Within a month at 25 °C)

Printer Specifications	
Humidity	
Printing	20 to 80% (40 to 60% is recommended, without condensation)
In storage	5 to 85% (without condensation)
Temperature and humidity range for operating (the range shown by diagonal lines is recommended)	
Dimensions (Width x Depth x Height)	
Printing*2	(A), (D): 1385 x 966 x 1060 mm (B): 1080 x 966 x 1060 mm (C): 1080 x 668 x 585 mm
Storage	(A), (D): 1385 x 750 x 1060 mm (B): 1080 x 750 x 1060 mm (C): 1080 x 668 x 585 mm
Weight*3	(A): Approx. 76 kg (B): Approx. 64 kg (C): Approx. 49 kg (D): Approx. 89 kg

\*1 Use the **Discharging/Charging Ink** menu in the Maintenance menu to discharge ink from the printer.  
["Handling if Transporting/Leaving the Printer in an Environment of -10°C or Less" on page 226](#)

\*2 With the paper basket open

\*3 Not including the ink cartridges



**Important:**

Use the printer at an altitude of 2000 m or less.

Appendix

Printer's Scanner Specifications*1	
Scanner type	Color Simplex Sheet-fed Scanner
Sensor	RGB color filter CIS
Number of effective pixels	21600 pixels (600 dpi) (main scanning direction)
Document size	Max. 914.4 mm × 30480 mm*2 Min. 148.0 mm × 148.0 mm
Document thickness	0.064 mm – 0.80 mm
Direction of feed	Printable side loaded facing up
Direction of ejection	Scanned side ejected facing down
Number of sheets that can be loaded	1 sheet
Scan resolution	600 dpi (main scanning) 600 dpi (sub-scanning)
Output resolution	200, 300, 400, 600 dpi
Tone	Color <input type="checkbox"/> 30-bit input (10 bits per pixel per color internal) <input type="checkbox"/> 24-bit output (8 bits per pixel per color internal)  Grayscale <input type="checkbox"/> 10-bit input <input type="checkbox"/> 8-bit output  Black and white <input type="checkbox"/> 10-bit input <input type="checkbox"/> 1-bit output
Light source	Dual LED (white)

\*1 SC-T5400M Series only.

\*2 Depending on the settings and the data format, the maximum length may be different.  
 TIFF (no tilt compensation): 30480 mm (full resolution)  
 JPEG/TIFF (with tilt compensation): 2624 mm (600 dpi), 3972 mm (400 dpi), 5260 mm (300 dpi), 7895 mm (200 dpi)  
 PDF (black and white; no tilt compensation): 5080 mm (full resolution)  
 PDF (color, grayscale, black and white (with tilt compensation)): 2624 mm (600 dpi), 3972 mm (400 dpi), 5080 mm (300 dpi), 5260 mm (200 dpi)  
 Copy: 5260 mm (Draft, Speed), 2624 mm (Fine, Super Fine)

Interface Specifications	
USB port for a computer	SuperSpeed USB
Option port (USB port for a scanner)	Hi-Speed USB
Ethernet*1 Standards	IEEE802.3u (100BASE-TX) IEEE802.3ab (1000BASE-T) IEEE802.3az (Energy Efficient Ethernet)*2
Wi-Fi	
Standards	IEEE802.11b/g/n*3
Frequency Range	2.4 GHz
Coordination Modes	Infrastructure Wi-Fi Direct (Simple AP)*4
Wireless Securities	WEP (64/128bit) WPA-PSK (TKIP) WPA2-PSK (AES)*5
Network Printing Protocols/Functions*6	EpsonNet Print (Windows) Standard TCP/IP (Windows) WSD Printing (Windows) Bonjour Printing (Mac) IPP Printing (Mac) AirPrint (iOS, Mac) Printing from FTP client
Security Protocols	SSL/TLS (HTTPS Server/Client, IPSS) IEEE802.1X IPsec/IP Filtering SMTPS (STARTTLS, SSL/TLS) SNMPv3
USB Flash Drive*7	
File system	FAT32, exFAT
File format	JPEG, TIFF, PDF*8

\*1 Use a category 5 or higher STP (Shielded twisted pair) cable.

\*2 The connected device should comply with IEEE802.3az standards.

\*3 IEEE802.11n is only available for the HT20.

\*4 Not supported for IEEE 802.11b.

\*5 Complies with WPA2 standards with support for WPA/WPA2 Personal.

\*6 EpsonNet Print supports IPv4 only. The others support both IPv4 and IPv6.

\*7 USB Flash Drive with security settings cannot be used.

\*8 SC-T5400M Series only. Only data that was scanned using this printer is supported.

Appendix



**Warning:**

*To prevent radio interference to the licensed service, this device is intended to be operated indoors and away from windows to provide maximum shielding. Equipment (or its transmit antenna) that is installed outdoors is subject to licensing*

Ink Specifications	
Type	Dedicated ink cartridges
Pigment ink	Black, Cyan, Magenta, Yellow
Use by date	See the expiration date printed on the ink cartridge package or on the cartridge (store at normal temperature)
Print quality guarantee expiry	One year (after installing to the printer)
Storage temperature	
Uninstalled	-20 to 40°C (Within four days at -20 °C, within a month at 40 °C)
Installed	-20 to 40°C (Within four days at -20 °C, within a month at 40 °C)
Transporting	-20 to 60°C (Within four days at -20 °C, within a month at 40 °C, within 72 hours at 60 °C)
Cartridge Dimensions (Width x Depth x Height)	
350 ml	40 x 200 x 110 mm
110 ml	25 x 200 x 110 mm



**Important:**

- We recommend that you remove and shake the installed ink cartridges once every three months to ensure good print quality.
- The ink freezes if left at below -20 °C for a long time. If it does freeze, leave it at room temperature (25°C) for at least four hours.
- Do not refill the ink cartridges.

## For European users

### Radio Equipment Information

This product intentionally emit radio wave described as follows.

- (a) frequency band in which the radio equipment operates; 2.4 to 2.4835 GHz
- (b) maximum radio-frequency power transmitted in the frequency band in which the radio equipment operates; 20dBm (eirp power)



## Where To Get Help

---

# Where To Get Help

---

## Technical Support Web Site

Epson's Technical Support Web Site provides help with problems that cannot be solved using the troubleshooting information in your product documentation. If you have a Web browser and can connect to the Internet, access the site at:

<http://support.epson.net/>

If you need the latest drivers, FAQs, manuals, or other downloadables, access the site at:

<http://www.epson.com>

Then, select the support section of your local Epson Web site.

## Contacting Epson Support

---

### Before Contacting Epson

If your Epson product is not operating properly and you cannot solve the problem using the troubleshooting information in your product documentation, contact Epson support services for assistance. If Epson support for your area is not listed below, contact the dealer where you purchased your product.

Epson support will be able to help you much more quickly if you give them the following information:

- Product serial number  
(The serial number label is usually on the back of the product.)
- Product model
- Product software version  
(Click **About**, **Version Info**, or similar button in the product software.)
- Brand and model of your computer
- Your computer operating system name and version
- Names and versions of the software applications you normally use with your product

## Where To Get Help

### Help for Users in North America

Epson provides the technical support services listed below.

#### Internet Support

Visit Epson's support website at <http://epson.com/support> and select your product for solutions to common problems. You can download drivers and documentation, get FAQs and troubleshooting advice, or e-mail Epson with your questions.

#### Speak to a Support Representative

Dial: (562) 276-1300 (U.S.), or (905) 709-9475 (Canada), 6 am to 6 pm, Pacific Time, Monday through Friday. Days and hours of support are subject to change without notice. Toll or long distance charges may apply.

Before you call Epson for support, please have the following information ready:

- Product name
- Product serial number
- Proof of purchase (such as a store receipt) and date of purchase
- Computer configuration
- Description of the problem

**Note:**

*For help using any other software on your system, see the documentation for that software for technical support information.*

#### Purchase Supplies and Accessories

You can purchase genuine Epson ink cartridges, ribbon cartridges, paper, and accessories from an Epson authorized reseller. To find the nearest reseller, call 800-GO-EPSON (800-463-7766). Or you can purchase online at <http://www.epsonstore.com> (U.S. sales) or <http://www.epson.ca> (Canadian sales).

### Help for Users in Europe

Check your **Pan-European Warranty Document** for information on how to contact Epson support.

### Help for Users in Australia

Epson Australia wishes to provide you with a high level of customer service. In addition to your product documentation, we provide the following sources for obtaining information:

#### Your Dealer

Don't forget that your dealer can often help identify and resolve problems. The dealer should always be the first call for advice on problems; they can often solve problems quickly and easily as well as give advice on the next step to take.

#### Internet URL

<http://www.epson.com.au>

Access the Epson Australia World Wide Web pages. Worth taking your modem here for the occasional surf! The site provides a download area for drivers, Epson contact points, new product information and technical support (e-mail).

#### Epson Helpdesk

Epson Helpdesk is provided as a final backup to make sure our clients have access to advice. Operators on the Helpdesk can aid you in installing, configuring and operating your Epson product. Our Pre-sales Helpdesk staff can provide literature on new Epson products and advise where the nearest dealer or service agent is located. Many types of queries are answered here.

The Helpdesk numbers are:

Phone: 1300 361 054

Fax: (02) 8899 3789

## Where To Get Help

We encourage you to have all the relevant information on hand when you ring. The more information you prepare, the faster we can help solve the problem. This information includes your Epson product documentation, type of computer, operating system, application programs, and any information you feel is required.

---

### Help for Users in Singapore

Sources of information, support, and services available from Epson Singapore are:

#### World Wide Web

(<http://www.epson.com.sg>)

Information on product specifications, drivers for download, Frequently Asked Questions (FAQ), Sales Enquiries, and Technical Support via e-mail are available.

#### Epson HelpDesk (Phone: (65) 6586 3111)

Our HelpDesk team can help you with the following over the phone:

- Sales inquiries and product information
- Product usage questions or problems
- Inquiries on repair service and warranty

---

### Help for Users in Thailand

Contacts for information, support, and services are:

#### World Wide Web

(<http://www.epson.co.th>)

Information on product specifications, drivers for download, Frequently Asked Questions (FAQ), and e-mail are available.

#### Epson Hotline (Phone: (66) 2685 -9899)

Our Hotline team can help you with the following over the phone:

- Sales inquiries and product information
- Product usage questions or problems
- Inquiries on repair service and warranty

---

### Help for Users in Vietnam

Contacts for information, support, and services are:

Epson Hotline (Phone): 84-8-823-9239

Service Center: 80 Truong Dinh Street,  
District 1, Hochiminh City  
Vietnam

---

### Help for Users in Indonesia

Contacts for information, support, and services are:

#### World Wide Web

(<http://www.epson.co.id>)

- Information on product specifications, drivers for download
- Frequently Asked Questions (FAQ), Sales Enquiries, questions through e-mail

#### Epson Hotline

- Sales inquiries and product information
- Technical support
 

Phone	(62) 21-572 4350
Fax	(62) 21-572 4357

#### Epson Service Center

Jakarta      Mangga Dua Mall 3rd floor No 3A/B  
Jl. Arteri Mangga Dua,  
Jakarta

Phone/Fax: (62) 21-62301104

## Where To Get Help

Bandung	Lippo Center 8th floor Jl. Gatot Subroto No.2 Bandung  Phone/Fax: (62) 22-7303766
Surabaya	Hitech Mall It IIB No. 12 Jl. Kusuma Bangsa 116 – 118 Surabaya  Phone: (62) 31-5355035 Fax: (62) 31 -5477837
Yogyakarta	Hotel Natour Garuda Jl. Malioboro No. 60 Yogyakarta  Phone: (62) 274-565478
Medan	Wisma HSBC 4th floor Jl. Diponegoro No. 11 Medan  Phone/Fax: (62) 61-4516173
Makassar	MTC Karebosi Lt. Ill Kav. P7-8 Jl. Ahmad Yani No.49 Makassar  Phone: (62)411-350147/411-350148

---

## Help for Users in Hong Kong

To obtain technical support as well as other after-sales services, users are welcome to contact Epson Hong Kong Limited.

### Internet Home Page

Epson Hong Kong has established a local home page in both Chinese and English on the Internet to provide users with the following information:

- Product information
- Answers to Frequently Asked Questions (FAQs)
- Latest versions of Epson product drivers

Users can access our World Wide Web home page at:

<http://www.epson.com.hk>

## Technical Support Hotline

You can also contact our technical staff at the following telephone and fax numbers:

Phone: (852) 2827-8911

Fax: (852) 2827-4383

---

## Help for Users in Malaysia

Contacts for information, support, and services are:

### World Wide Web

<http://www.epson.com.my>

- Information on product specifications, drivers for download
- Frequently Asked Questions (FAQ), Sales Enquiries, questions through e-mail

## Epson Trading (M) Sdn. Bhd.

Head Office.

Phone: 603-56288288

Fax: 603-56288388/399

### Epson Helpdesk

- Sales enquiries and product information (Infoline)  
Phone: 603-56288222
- Enquiries on repair services & warranty, product usage and technical support (Techline)  
Phone: 603-56288333

---

## Help for Users in India

Contacts for information, support, and services are:

## Where To Get Help

### World Wide Web

(<http://www.epson.co.in>)

Information on product specifications, drivers for download, and products enquiry are available.

### Epson India Head Office - Bangalore

Phone: 080-30515000

Fax: 30515005

### Epson India Regional Offices:

Location	Telephone number	Fax number
Mumbai	022-28261515/ 16/17	022-28257287
Delhi	011-30615000	011-30615005
Chennai	044-30277500	044-30277575
Kolkata	033-22831589/90	033-22831591
Hyderabad	040-66331738/39	040-66328633
Cochin	0484-2357950	0484-2357950
Coimbatore	0422-2380002	NA
Pune	020-30286000/ 30286001/ 30286002	020-30286000
Ahmedabad	079-26407176/77	079-26407347

### Helpline

For Service, Product info or to order a cartridge - 18004250011 (9AM - 9PM) - This is a Toll-free number.

For Service (CDMA & Mobile Users) - 3900 1600 (9AM - 6PM) Prefix local STD code

## Help for Users in the Philippines

To obtain technical support as well as other after sales services, users are welcome to contact the Epson Philippines Corporation at the telephone and fax numbers and e-mail address below:

Trunk Line: (63-2) 706 2609

Fax: (63-2) 706 2665

Helpdesk Direct Line: (63-2) 706 2625

E-mail: [epchelpdesk@epc.epson.com.ph](mailto:epchelpdesk@epc.epson.com.ph)

### World Wide Web

(<http://www.epson.com.ph>)

Information on product specifications, drivers for download, Frequently Asked Questions (FAQ), and E-mail Inquiries are available.

**Toll-Free No. 1800-1069-EPSON(37766)**

Our Hotline team can help you with the following over the phone:

- Sales inquiries and product information
- Product usage questions or problems
- Inquiries on repair service and warranty