

Smart Headset
MOVERIO Pro

User's Guide

EPSON®
EXCEED YOUR VISION

Safety Instructions.....2

Part Names and Functions.....5

Getting Ready.....6

Turning On and Off.....8

Wearing the Controller.....9

For Both Headsets

Included Items 11

Supported Helmet Sizes 11

Part Names and Functions..... 12

Wearing the Product 13

BT-2200

BT-2200

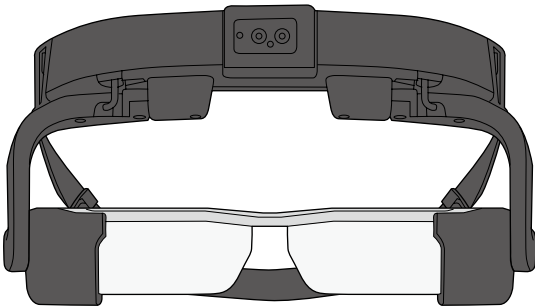

Included Items 15

Part Names and Functions..... 16

Wearing the Product 17

BT-2000

BT-2000

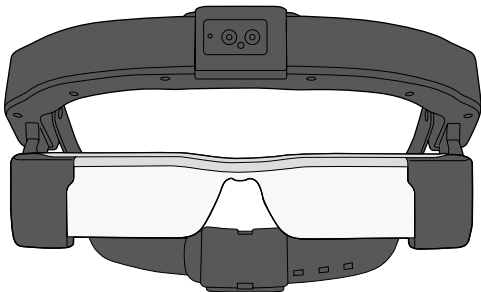

Maintenance 19

Troubleshooting..... 20

Optional Items..... 21

Specifications..... 22

Intellectual Property Rights..... 23

General Notes..... 23

Contact List 26





413918500

Safety Instructions





For your safety, read the attached documents carefully to use the product correctly.

After you have read the documents, keep them in a safe place so that you can refer to them quickly at a later date.

Safety symbols

 Warning	This symbol indicates information that, if ignored, could possibly result in serious personal injury or even death due to incorrect handling.
 Caution	This symbol indicates information that, if ignored, could possibly result in personal injury or physical damage due to incorrect handling.

General information symbols

 Caution	Indicates procedures which may result in damage or injury if sufficient care is not taken.
 Note	Indicates additional information and points which may be useful to know regarding a topic.
 []	Indicates controller keys, icons, and menu items displayed on the screen.
 ➔	Indicates a reference to related topics.

Warning Usage environment and condition precautions

Only use this product at the stated power-supply voltage.

Only use the supplied AC cable and AC adapter. Using other power supply devices could result in heat, fire, explosion, malfunction, or liquid leakage.

Take the following precautions when handling the plug. Doing so could result in fire or electric shock.

- Do not plug the AC adapter into an outlet being used by many other devices.
- Do not insert the plug into a dusty outlet.
- Insert the plug firmly into the outlet.
- Do not hold the plug with wet hands.
- Do not pull the power cable when disconnecting the plug.

Do not use the supplied power cable if it is damaged. Doing so could result in fire or electric shock.

- Do not modify the supplied power cable.
- Do not place heavy objects on top of the supplied power cable.
- Do not bend, twist, or pull the power cable with excessive force.
- Keep the power cable away from hot electrical appliances.

For your safety, unplug the product when it is not being used. The insulation may deteriorate, which may result in electric shock, fire, or malfunction.

Do not touch the plug during a thunderstorm. Doing so could result in fire or electric shock.

Do not leave this product in locations subject to temperatures beyond the specified operating range, such as cars with the windows closed, in direct sunlight, or in front of air-conditioning or heater outlets. Also, avoid locations subject to sudden changes in temperature. Doing so may result in deformation due to heat, fire, malfunction, failure, or damage.

Do not use the product in locations where it may get wet or is subject to high levels of humidity such as in a bath or shower. Doing so could result in fire or electric shock.

Do not place this product in locations subject to smoke, steam, high humidity, or dust such as kitchen counters or near humidifiers. Doing so may result in fire, electric shock, or deterioration in image quality.

Do not cover this product with a cloth or similar material during use. Doing so may change the shape of the case through heat, or fire.

Do not expose the camera lens to direct sunlight for a long time. Doing so may result in fire or explosion due to condensed beams of light from the lens.

Warning Product usage precautions

 Do not start using this product at a high volume. Doing so may result in hearing impairment. Lower the volume before turning off the product, and gradually increase the volume after turning on the product. To prevent possible hearing damage, do not listen at high volume for prolonged periods of time.

Do not allow any conductive foreign objects to touch the charging connector, external device connector, or earphone microphone socket, and do not put any conductive foreign objects into the connection ports. Doing so may cause a short circuit and result in fire or electric shock.

Do not allow solvents such as alcohol, benzene, or thinner to touch the product. Also, do not clean this product with a wet cloth or solvents. Doing so may warp or crack the product housing and may result in electric shock, malfunction, or fire.

The product housing should only be opened by qualified service personnel unless you are explicitly instructed to do so in the User's Guide. Also, do not disassemble or remodel the product (including consumable items). Many of the parts inside the product carry a high voltage and could cause fire, electric shock, accident, or poisoning.

Do not subject the lens of the product to strong shocks or knock it against hard objects. If the lens is damaged, it could splinter and cause serious injuries to the eyes and face.

Do not throw the product into a fire and do not heat the product. Do not place combustible items, such as candles, near this product. Doing so may result in heat, fire, or explosion.

Make sure the cable does not catch on anything in the surrounding area while wearing the product. Also, make sure the cable does not wind around your neck. Doing so may result in accident or injury.

Make sure the cable does not get damaged. Otherwise, it may result in fire or electric shock.

- Do not damage the cable.
- Do not place heavy objects on top of the cable.
- Do not bend, twist, or pull the cable with excessive force.
- Keep the power cable away from hot electrical appliances.

Warning Viewing image precautions

Do not wear this product while driving a car, riding a motor bike or bicycle, or performing any other dangerous tasks. Doing so may result in accident or injury.

Do not use this product in unstable locations such as stairs or at altitude. Also, do not use the product while walking in dangerous locations such as near machinery or equipment that might get caught on the cables, where there is a lot of traffic, or where it is dark. Doing so may result in accident or injury.

When walking while using this product, or when using this product in a dangerous location, be careful not to injure yourself through accidents, falling over, tripping over, or running into any thing or anyone. As much as possible, slide up the lens so that it does not impede your vision.

When viewing in dark locations, it is difficult to see your surroundings due to the brightness of the image. Be aware of your surroundings.

When using this product in small locations, be aware of your surroundings.

When wearing this product, do not look directly at the sun or other light sources even if you are using the shade. This could cause serious injury to your eyes or loss of eyesight.

Warning Product abnormality precautions

In the following situations, turn off this product immediately, unplug the power plug, and contact your local dealer or the Epson service call center. Continuing to use under these conditions may result in fire or electric shock. Do not try to repair this product yourself.

- If you see smoke, or notice any strange odors or noises.
- If any water, beverages, or foreign objects get into the product.
- If the product was dropped or the case was damaged.

Warning Wireless function precautions

When taking this product into areas in which the use of electromagnetic waves is prohibited, such as in an aircraft or in hospitals, follow the instructions in the area and turn off this product or disable the Bluetooth or wireless LAN function. Do not use the Bluetooth or wireless LAN function near automatically controlled devices such as automatic doors or fire alarms. If the product has an auto power on function, disable it before turning off the product. The electromagnetic waves may cause electromagnetic interference with medical equipment or cause the equipment to malfunction.

Note the following points when using the Bluetooth or wireless LAN function in medical institutions.

- Do not bring this product into operating rooms, Intensive Care Units (ICUs), or Cardiac Care Units (CCUs).
- When on wards, turn off this product or stop the electromagnetic waves.
- Even when not on wards, turn off this product or stop the electromagnetic waves if there is any electronic medical equipment in the area.
- Follow any rules stipulated by medical institutions that prohibit the use of devices emitting electromagnetic waves, or that prohibit entry to certain areas with such devices.
- If the product has an auto power on function, disable it before turning off the product.

If you have an implanted pacemaker or implanted defibrillator, make sure you keep a distance of at least 22 cm between this product and the implanted device when using the Bluetooth or the wireless LAN function. The electromagnetic waves may influence the operation of implanted pacemakers or implanted defibrillators. Turn off this product or stop the electromagnetic waves if you are in a location where someone near you may have a pacemaker, such as a crowded train.

Caution Usage environment and condition precautions

Do not place the product in locations subjected to vibrations or shocks.

While using the product to view images, make sure you confirm the safety of your surroundings and do not leave any fragile items in your immediate vicinity. The images you are viewing may cause you to move your body involuntarily, resulting in damage to nearby items or personal injury.

Do not place this product near high-voltage lines or magnetized items. Doing so may result in breakdown, malfunction, or failure.

When performing maintenance, make sure you turn off the product, unplug the power plug and the power connector, and disconnect all wires. Otherwise, it may result in electric shock.

Stop charging the battery if the charging does not end in the stated period of time. Continuing the charge may result in liquid leakage, heat, explosion, or fire.

If the batteries are not handled correctly, the battery could explode or leak which could cause a fire, injury, and corrode the product. Take the following precautions to make sure you use this product safely.

- Do not use different types of batteries at the same time, and do not use a mixture of old and new batteries.
- Do not use any batteries other than those specified in the User's Guide.
- If the battery leaks, wipe up the leaked liquid with a cloth and replace it with a new battery (if any leaked liquid gets on your hands, wash in water immediately).
- Immediately remove batteries when it is time to replace them.
- Remove the batteries if you will not be using the product for a while.
- Do not heat the batteries or throw them into fire or water.

Caution Product usage precautions

Do not over tighten the head band while wearing the product. Doing so may result in injury or rash due to the pressure.

Stop using this product if the skin that touches the product (head, face, and so on) feels itchy when wearing the product, or any unusual rashes occur, and consult your local dermatologist. Sometimes allergies may occur due to the coating or material of the product.

If you sweat while using the product, wipe the sweat from your head, face, and the device. Continuing to use under these conditions may result in itching or a rash.

Hold the controller securely or place it on a stable surface and make sure the cables are not pulled with undue force. Dropping the headset due to the weight of the controller may result in injury or malfunction.

Dispose of this product in accordance with your local laws and regulations.

Caution Viewing image precautions

Always take periodic breaks when viewing images using this product. Long periods of viewing images may result in eye fatigue. If you feel fatigued or uncomfortable even after taking a break, stop viewing immediately.

Do not drop this product or treat it with unnecessary force. Also, if the product breaks due to an impact such as a fall, stop using the product. Continuing to use this product may result in injury due to glass fragments.

Do not place your finger between the moving parts of this product, such as the hinges. Doing so may result in injury.

Make sure you are wearing this product correctly. Continuing to view images that are not being displayed correctly could make you feel nauseous.

This product should only be used for the purposes stated in the manuals. Using it for anything else may result in injury.

If a problem or malfunction occurs, stop using this product immediately. Continuing to use this product may result in injury or could make you feel nauseous.

How a 3D image is perceived varies depending on the individual. Stop using the 3D function if you feel strange or cannot see in 3D. Continuing to view the 3D images could make you feel nauseous.

Six-year-old children and under should not use this product as their eyesight is still developing.
For seven-year-old children and over, avoid using the product for too long, and make sure the child is always supervised to monitor their physical condition and make sure their eyes do not become strained.

Do not use this product if you are sensitive to light, or feel nauseous. Doing so may aggravate your pre-existing conditions.

Do not use this product if you have prior eye conditions. Doing so may aggravate the symptoms such as strabismus, amblyopia, or anisometropia.

Caution Product abnormality precautions

Data such as video or images stored on the product may be lost or damaged when the product malfunctions, is repaired, or undergoes other services. Epson shall not be responsible for the loss of any data, damage to data, or loss of profits that occurs at such a time.



You can recycle used lithium-ion batteries. When the product's internal battery reaches the end of its service life, contact a service center for information on recycling.

Dust-proofing and Water-proofing

When the product's battery cover and port covers are installed correctly, the product is dust-proof and water-proof up to the IP54 standard based on JISC0920 (IEC60529:2001) confirmed by tests from a third party. The dust-proof and water-proof features do not guarantee that the product will operate under all conditions or protect against malfunctions. The warranty is invalid if malfunctions are determined to have occurred due

to incorrect handling of the product by the user.

Dust-proofing level compliant with IP5X

- This prevents dust from getting inside the product.
- Even if a small amount of dust does enter the product, it can still be operated normally.

Water-proofing level compliant with IPX4

If the product is subjected to water from a faucet at normal temperatures at a rate of 10 L/min for over five minutes, water does not enter the product and it can be operated normally.

Caution Dust-proofing and water-proofing precautions

When using the product, remove all connected cables, and close the battery cover, AC adapter port cover and micro USB port cover securely. When you open these covers for battery replacement or other purposes, open it in location away from water or dust and do not handle with wet hands. If tiny pieces of trash such as hairs or sand become inserted between the ports, this may allow water or dust to enter the product. When the power cable or the microUSB cable are connected to the product, the dust-proof and water-proof performance is not maintained.

Do not drop or damage the product. This could cause the dust-proof and water-proof performance to degrade.

Do not peel off or damage the rubber packing on the back of each cover. Do not allow trash to stick to the rubber packing. This could cause the dust-proof and water-proof performance to degrade.

Do not allow other liquids (such as organic solvents, soapy water, hot spring water, and seawater) to splash onto the product, and do not place it in water intentionally.

Do not leave the product in locations subject to humidity such as bathrooms.

Do not use this product in heavy rain.

If rain or water splash onto the product, wipe it with a dry cloth as soon as possible.

Controller

The illustrations show the controller when it has been removed from the controller holder.

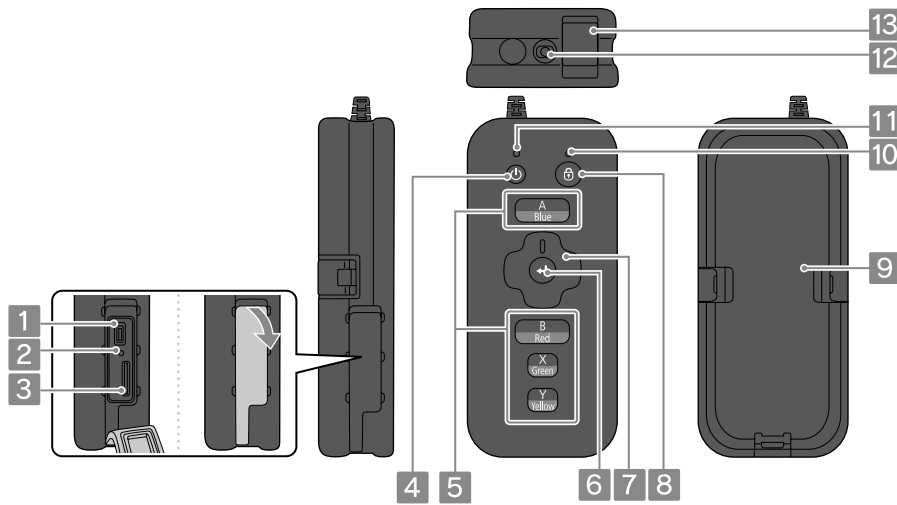

1 MicroUSB port

When connecting to a computer and so on, connect a commercially available USB cable.

2 Reset button

If the product stops working, press this button to force the product to turn off.

3 microSD card slot

Insert a commercially available microSD card.

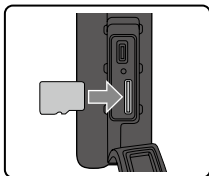

4 [⏻] Power button

Turns the product on or off.

➔ "Turning On and Off" p. 8

5 ABXY keys

The key functions vary depending on the application being used. The following shows the default settings.

Key	Function
A (Blue) key	Displays the previous screen.
B (Red) key	Press to return to the Home screen.
X (Green) key	Displays available menus for the current screen.
Y (Yellow) key	Switches the operation performed when you press the cross-key between adjusting the volume, adjusting the brightness, and switching between 2D/3D mode.

6 [↵] Enter key

Selects or confirms the item when making settings or operating an application.

7 Cross-key

Selects items and moves the cursor when making settings or operating an application.

8 [🔒] Key lock button

Disables controller operations (Key lock mode) to prevent accidental operations.

➔ "Disabling controller operations (Key lock)" p. 8

9 Battery cover

Remove the cover when removing the battery.

You cannot remove the cover when the controller is in the controller holder.

10 Key lock indicator

Turns blue when the key lock is on.

11 Power indicator

You can check the status of the product according to the color and lit status of the indicator.

Indicator Status	Product Status
Light blue	Operating
Flashing light blue (one second intervals)	Starting up / Shutting down
Flashing light blue (once every three seconds)	Charging
Blue	Sleep mode
Flashing red	Battery running low/Startup error
Flashing red three times	Insufficient battery to start up
Flashing red and blue	Battery replacement mode

12 Earphone socket

Connects the supplied mono earphones with mic.

13 AC adapter port

Connects the AC adapter to charge the product.

➔ "Charging the Battery" p. 6

Getting Ready

Charging the Battery

Make sure you charge the product when using it for the first time. Initial charging takes approximately three hours.

Caution

Make sure you install two batteries when using the product.

1 Remove the battery cover.

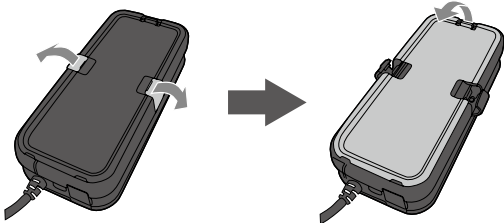

2 Install two batteries.

Align the charging connectors on the battery with those on the device, and then press the battery down until you hear it click into place.



3 Attach the battery cover.

4 Connect the controller, AC adapter, and AC cable.

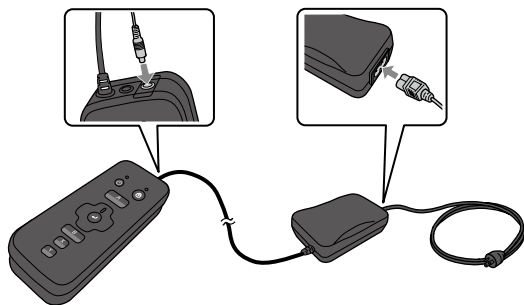

5 Plug in the AC cable.

The power indicator flashes light blue. Charging is complete when the power indicator stops flashing and turns light blue. Disconnect the AC adapter and the AC cable.

Note

When charging is complete with two batteries installed, you can use the product for approximately four hours. Battery life may vary depending on the environmental and application usage conditions.

Replacing the Battery

This section explains how to replace a battery that is running low with a battery that is charged. You need to purchase optional batteries and a battery charger for replacement.

The batteries can be replaced when the product is on.

Caution

- Do not remove two batteries at the same time when the product is on. Stored data and settings may be lost.
- When not using this product for a long time, the charge in the back-up battery that maintains the date and time settings may run out, and the date and time are returned to their defaults.
 - ➔ "Date and time settings are reset" p. 20

Note

This product comes with a function that shows you how to replace the batteries in Battery replacement mode. Press the [⏻] power button and the [🔒] key lock button at the same time, and then replace the batteries by following the directions displayed by the headset.

1 Remove the battery cover.

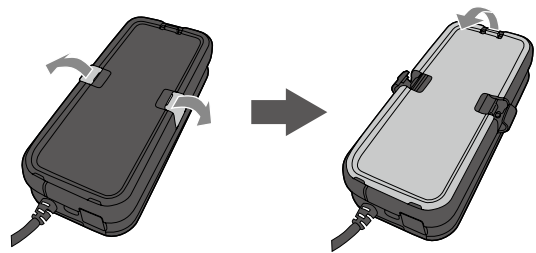

The battery indicator for the battery being replaced flashes red.

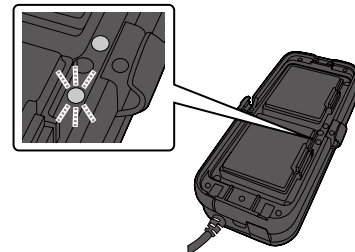

Note

When the product is off, the battery indicator does not operate.

2 Remove one battery.

While pressing the battery catch, lift out the battery.

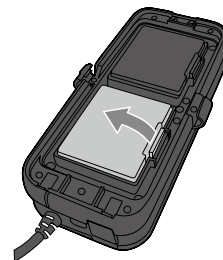

3 Install the charged battery.

Align the charging connectors on the battery with those on the device, and then press the battery down until you hear it click into place.



The battery indicator lights green for a while before turning off.

If the battery indicator for the other battery flashes red, repeat the procedure to replace this battery. When both battery indicators turn off, battery replacement is complete.

4 Attach the battery cover.**Note**

If the battery indicator flashes red and green, there is an error with the battery. Turn off the product, wait for a while, and then turn it back on.

Replacing the Inner Pad

There are three types (A/B/C) of replacement inner pads available for the BT-2000, and one for the BT-2200.

When you purchase the BT-2000, inner pad B is attached to the headset. If the headset feels tight, replace this with the inner pad A or C. Using a smaller inner pad loosens the headset.

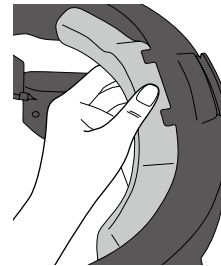
1 Grip the center of the inner pad and carefully pull it to remove.**2 Align the groove at the bottom of the replacement inner pad with the tabs on the headset.**

Press the groove at the top and the tabs on the left and right of the inner pad into the headset to install.

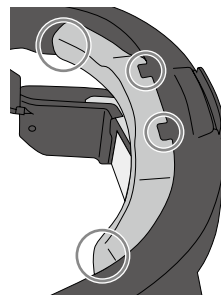
**Installing the Shade/Protective Shield/Lens Holder**

Install the shade/protective shield/lens holder using the hexagon wrench and screws supplied with the product.

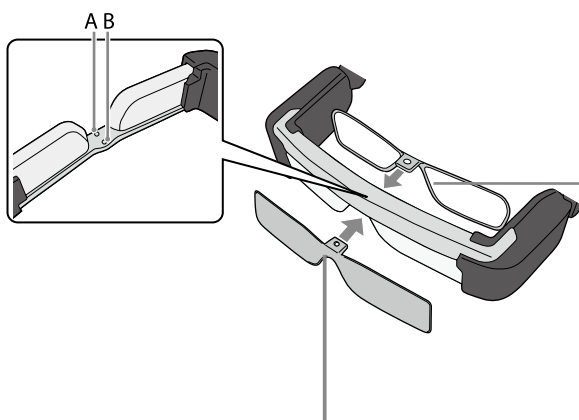

Install the shade or protective shield to the outside of the headset, and secure it in place using screw hole (A). You cannot install the shade and protective shield at the same time.

Before installing the lens holder on the headset, visit your local opticians and have them install lenses in the lens holder. After lenses have been installed, install the holder to the inside of the headset, and secure it in place using screw hole (B).

(The customer is responsible for the cost of the lenses. Depending on the opticians, they may not be able to perform this procedure.)

Lens holder supported lenses

Lens (W x H)	50 x 24 mm
Nose pads	20 mm
Frame PD	70mm
Curve	4

Note

You may not be able to view images when using special lenses such as colored lenses, mirrored lenses, and polarized lenses.

Turning On and Off

Note

Before turning on the product, check that the battery is charged.

→ "Charging the Battery" p. 6

Turning On

Press the [⏻] power button until the power indicator is lit light blue.



The power indicator flashes light blue when starting up. Startup is complete when the power indicator changes from flashing to turn light blue.

When you turn on the product, images are displayed approximately 4 m away from you when viewed through the lens.

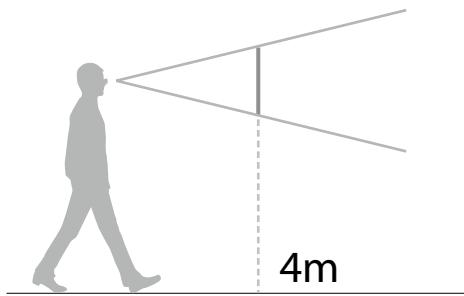

Note

How an image is perceived varies depending on the individual.

Turning off the screen while the product is on (Sleep mode)

When you press the [⏻] power button briefly, the power indicator turns blue, and the product enters sleep mode. Press the [⏻] power button briefly again to wake the product from sleep mode.

Disabling controller operations (Key lock)

When you hold down the [🔒] key lock button, the key lock indicator is lit blue, and the key lock turns on. Press the [🔒] key lock button again to release the key lock.

Turning Off

Hold down the [⏻] power button for more than one second, and then select [OK] in the message displayed by the headset.

Note

If operations freeze, you can force the product to shutdown by using one of the following methods.

- Hold on the [⏻] power button for more than eight seconds.
- Use something thin to press the reset button for at least two seconds.

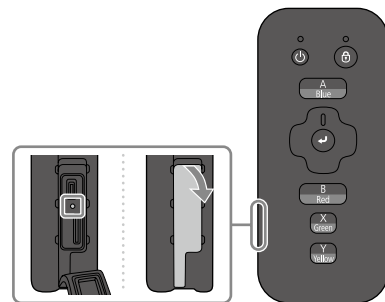

Caution

Do not force the product to shutdown unless operations freeze. Stored data and settings may be lost.

Wearing the Controller

Warning Product usage precautions

- Make sure you check that the following parts are not damaged each time you use this product.
 - Controller holder
 - Armband
 - Shoulder holder (optional)
 - Reel clip

If you notice any problems with any of these items, do not use the product as when it cannot be secured safely, it could cause an accident or injury.

- If the cables come loose when you are wearing the controller, they could get caught or entangled in something and cause an accident or injury. Make sure all cables are connected securely.

You can wear the controller on your waist or arm.

When using the optional shoulder holder, you can also wear this product on your chest.

When working, make sure you wear the product in a position that does not interfere with your movements.

Note

Before wearing the controller and headset, put on the supplied mono earphones with mic. Connect it to the earphone socket on the controller, and wear them as shown in the illustration on the right.



Caution

When removing the controller from the controller holder, push the controller out of the hole on the bottom of the controller holder. Do not pull it out by the cables.

Wearing the Controller on Your Waist

Attach the controller holder to the belt around your waist.

Caution

If you are not wearing a belt, you cannot wear the controller on your waist.

1 Placing the controller in the controller holder.

Place it in the holder so that the control panel of the controller is visible.

2 Thread the band at the back of the controller holder between your belt and trousers.

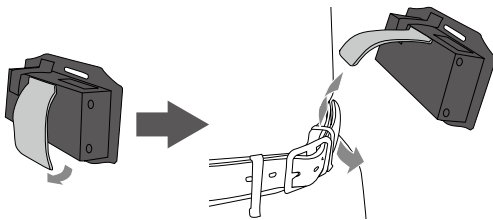

3 Attach the band to the bottom of the controller holder.

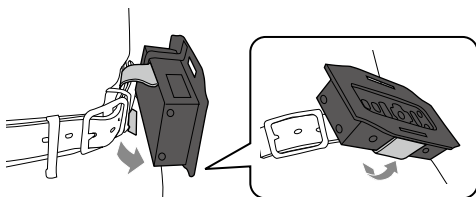

4 Wind up the extra cable, and secure it in place with the strap.

Make sure the cable does not catch on anything in the surrounding area.

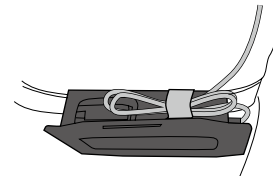

5 Secure the cable with the reel clip.

Secure the reel clip to your collar so that the cable runs down close to your abdomen.

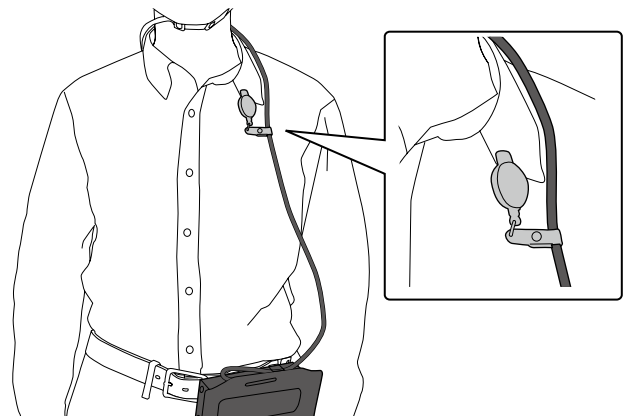

Wearing the Controller on Your Arm

This section explains how to wear the controller on your arm using the armband.

- 1 Placing the controller in the controller holder.**
Place it in the holder so that the control panel of the controller is visible.
- 2 Run the armband through the controller holder, and create a loop the thickness of your arm.**

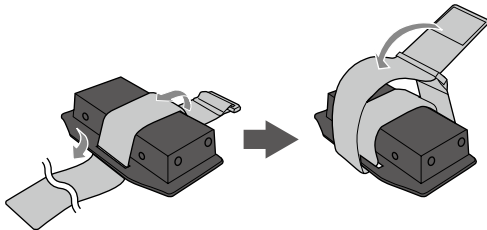

Note

The armband can also be threaded vertically.

- 3 Place the controller holder on your arm and secure it with the armband.**

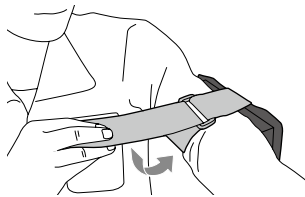

- 4 Wind up the extra cable, and secure it in place with the strap.**

Make sure the cable does not catch on anything in the surrounding area.

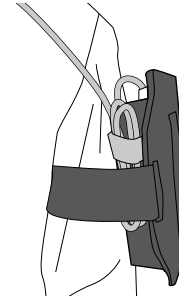

- 5 Secure the cable with the reel clip.**

Secure the reel clip to your collar.

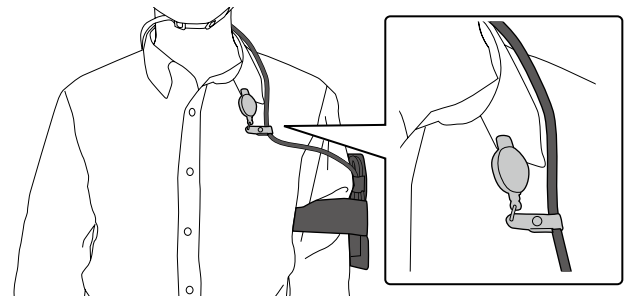

Wearing the Shoulder Holder

You can use the optional shoulder holder to wear the controller on your chest.

Note

- Make sure you use the snap fastener on the accessory case to prevent the product from falling.
- You can also attach a headlight to the shoulder holder.

- 1 Placing the controller in the controller holder.**
Place it in the holder so that the control panel of the controller is visible.
- 2 Adjust the shoulder holder so that the controller is at the front, and then fasten the adjuster.**
Wear the shoulder holder so that the control panel of the controller is at the front.



- 3 Adjust the length of the belt.**

Adjust the length so that the controller is in a position where it can be operated comfortably.

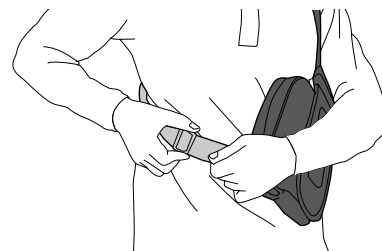









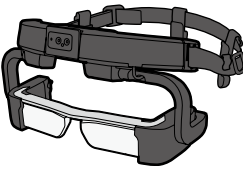
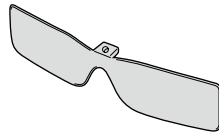

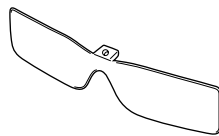
- 4 Secure the cable with the reel clip.**

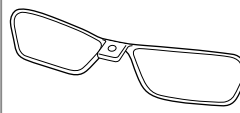
Attach the reel clip to the belt of the shoulder holder, and route the cable behind your back.

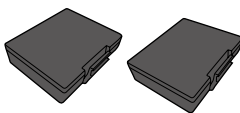
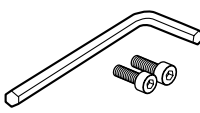

Included Items

	<p>Headset Attach to the helmet to view images. ➔ "4. Wearing the headset" p. 14</p>		<p>Shade Shades the product from too much exterior light. ➔ "Installing the Shade/Protective Shield/Lens Holder" p. 7</p>
	<p>Controller (with controller holder) Operates the product. ➔ "Wearing the Controller" p. 9</p>		<p>Protective shield Protects the product's lens from foreign objects and air-borne objects. ➔ "Installing the Shade/Protective Shield/Lens Holder" p. 7</p>
	<p>Armband Allows you to wear the controller on your arm.</p>		<p>Lens holder Install lenses to the holder and attach it to the headset. This allows users who wear glasses to remove their glasses before wearing the headset. ➔ "Installing the Shade/Protective Shield/Lens Holder" p. 7</p>
	<p>Reel clip Use this to secure the cable.</p>		<p>Mono earphones with mic Outputs audio from the product, and inputs audio to the product.</p>
	<p>Battery packs (x2) Powers the product. ➔ "Charging the Battery" p. 6</p>		<p>Hexagon wrench and screws (x2) Use these to attach the lens holder, shade, and protective shield.</p>
	<p>AC adapter/AC cable Charges the product. ➔ "Charging the Battery" p. 6</p>		<p>Helmet holders (x4) Use these to secure the helmet to the headset.</p>
			<p>User's Guide</p>

Supported Helmet Sizes

External Dimensions	Width 260 mm, depth less than 300 mm
Brim length	Less than 45 mm
Perimeter	Less than 800 mm
Brim width	Less than 180 mm

* This cannot be used for headsets with a protective mask at the front or when a shield is attached to the helmet.

* This cannot be used with a helmet which has a brim all around the helmet.

* This cannot be used with bike helmets, motor bike helmets, or disaster prevention helmets.

Headset (BT-2200)

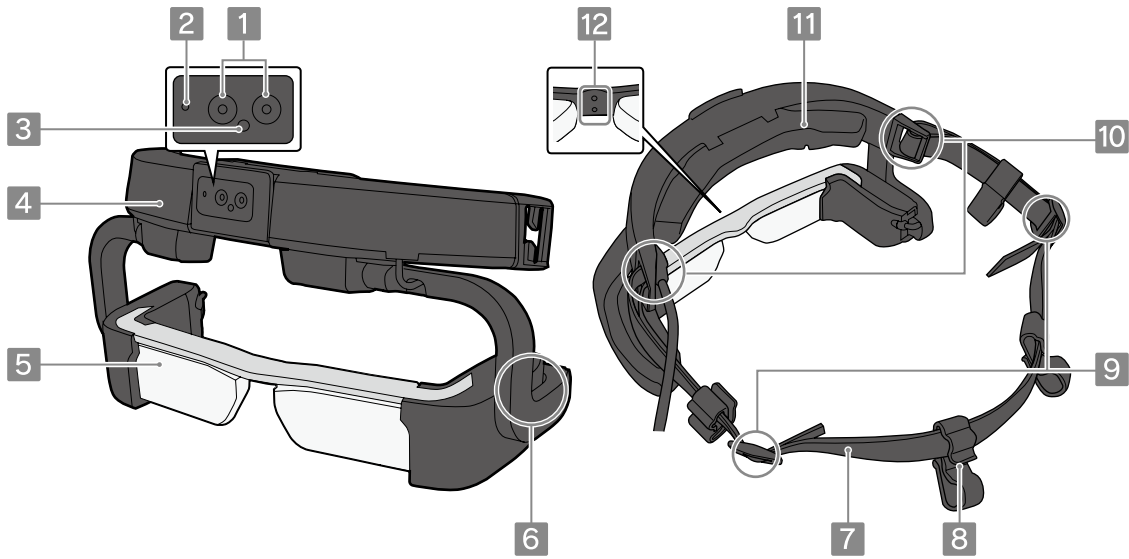

1 Camera

Captures images and movies. Remove the protective film before use. You can adjust the angle of the camera.

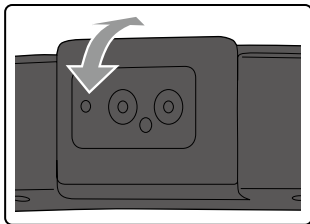

2 Camera indicator

Flashes while the camera is operating.

3 Light sensor

Senses the brightness of your surroundings and automatically adjusts the brightness of the screen.

4 Head pad

Fits against your forehead when wearing the headset. The head pad is equipped with a built-in sensor to detect the position and direction of the product.

5 Lens

Displays images. When not displaying images, you can slide up the lens to the head pad.

6 Lens justifier

You can adjust the position of the lens vertically. Adjust the left and right by the same amount so that the lens is not tilted during adjustment.

7 Rubber band

Secures the headset to your helmet.

➔ "Replacing the Rubber Band (BT-2200)" p. 14

8 Helmet holder

Use the four helmet holders to make sure the headset does not come off during use.

This also secures cables when wearing the headset.

9 Adjuster

Adjusts the length of the rubber band according to the size of the helmet.

10 Band holder

Route the band through each of these when replacing the rubber band.

11 Inner pad

Sticks to the front of the helmet.

12 Screw holes to secure the shade/protective shield/lens holder

Install the shade/protective shield using the exterior screw holes. Install the lens holder using the interior screw holes.

➔ "Installing the Shade/Protective Shield/Lens Holder" p. 7

Wearing the Product

For the BT-2200 you need to secure the headset to the helmet before wearing.

➔ "Supported Helmet Sizes" p. 11

Warning Product usage precautions

Make sure you check that the following items each time you use this product.

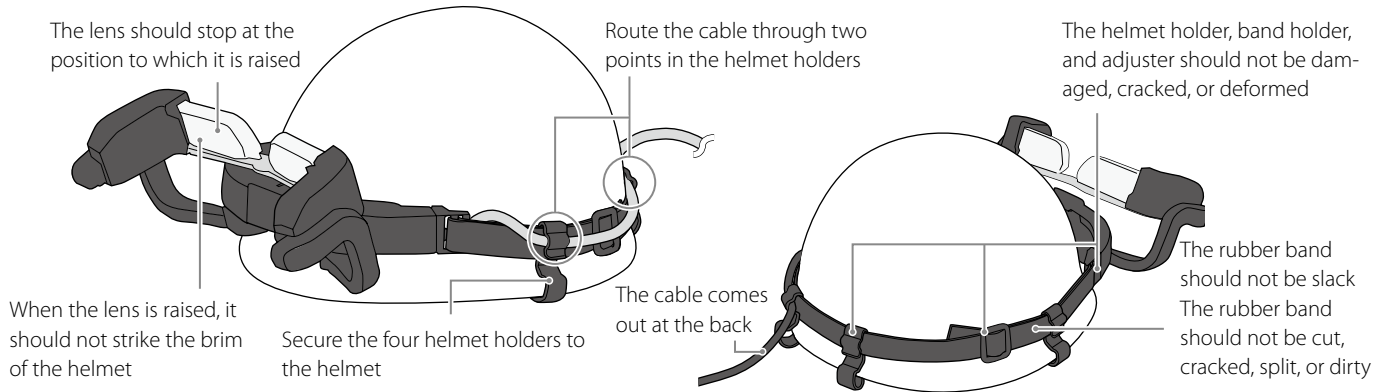

If you notice any problems with any of these items, do not use the product as when it cannot be secured safely, it could cause an accident or injury. Also, make sure you replace any consumable items if they are damaged or worn.

- Before operating this product, make sure it can be worn according to the procedures in "Wearing the Controller" p. 9 as well as on this page and the following pages.
- As much as possible, make sure that the cables are secured to your body and do not sag or droop. If the cables come loose, they could get caught or entangled in something and cause an accident or injury.

1. Securing the headset to the helmet

1 Adjust the length of the rubber band according to the size of the helmet.

Adjust so that there is no slack in the rubber band.

2 Attach the helmet holders to the rubber band.

Attach two at the front (where the rubber is doubled), and two at the back.

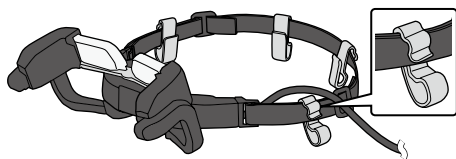

Caution

Make sure the helmet holders are facing the right way.

3 With the head pad stuck to the front of the helmet, secure the rubber band at the lower part of the helmet.

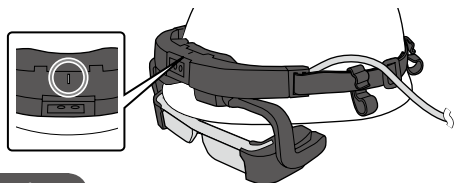

Caution

- Adjust the headset so that it is aligned with the centerline of the helmet.
- Route the cable over the top of the rubber band.

Note

Due to the characteristics of the material of the rubber band, the color of the band may rub off on the helmet. When cleaning, see the cleaning method recommended for the helmet.

4 Attach the four helmet holders to the helmet.

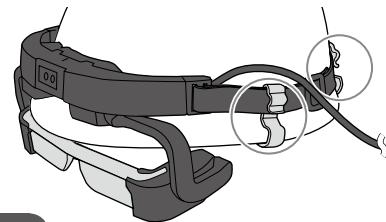

Caution

Make sure you attach the helmet holders in positions where they do not damage the protective material inside the helmet.

5 Route the cables through the helmet holders (two points) and out the back of the helmet.

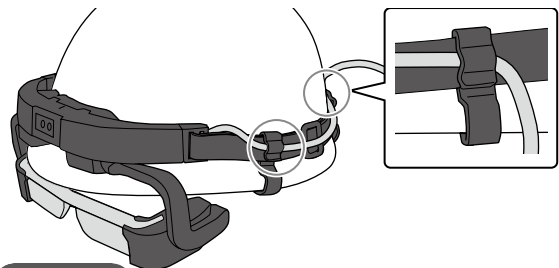

Caution

- Make sure the cable is not damaged when you pass it through the helmet holders.
- When the headset is attached to the helmet, do not subject it to powerful shocks.
- When you are not wearing the helmet, place it on a table or a workbench and so on. If the helmet is hung on a hook on a wall and so on, the headset may fall off and be damaged.

2. Wearing the controller

➔ "Wearing the Controller" p. 9

3. Turning on

➔ "Turning On and Off" p. 8

Check that the power indicator on the product is light blue (turned on).

4. Wearing the headset

Since the weight of the headset makes it easy for the helmet to slip forwards, make sure the helmet is firmly secured to your head.

Caution

When the lens is lowered, your field of vision is narrowed even when nothing is displayed. When not viewing images, make sure you slide up the lens for your own safety.

Note

The headset can be worn over glasses that are up to 143 mm wide.

1 Put on the helmet.

Secure the chin strap and the adjuster so that the helmet does not slip off while you are working.

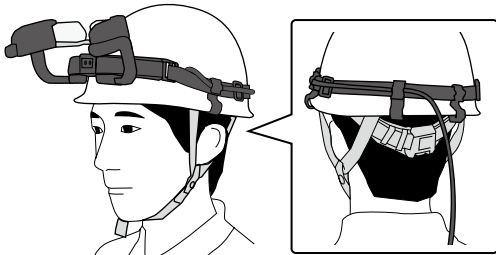

2 Lower the lens below the brim of the helmet.

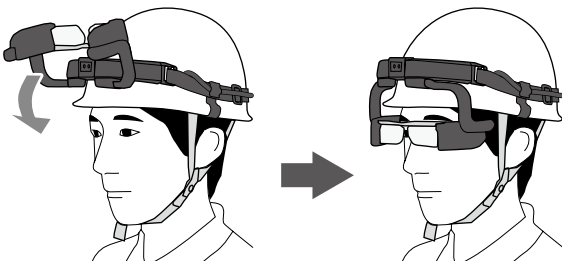

If the lens bumps the brim of the helmet when you lower it, you need to attach the headset again.

➔ "1. Securing the headset to the helmet" p. 13

3 Adjust the position of the head pad so that the image is displayed in the correct position in the lens.

Raise and lower the lens and adjust so that it does not hit the brim of the helmet.

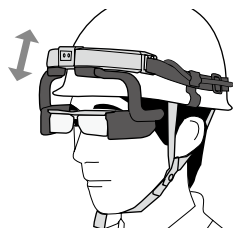

Note

If the lens is below eye level and you cannot see the images, use the dedicated helmet inner cap.

4 If you cannot view a part or any of the image, adjust the lens justifier on either side of the lens.

Adjust the left and right by the same amount so that the lens is not tilted.

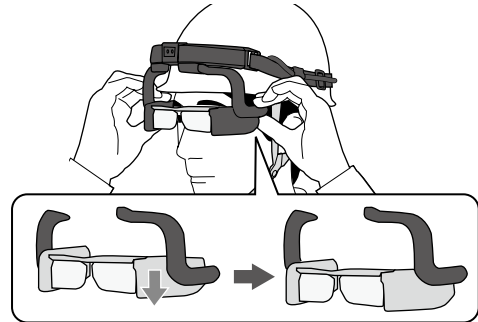

If you still cannot view images even after adjusting the lens justifier, start again from step 3.

5 Check that you can slide up the lens and secure visibility.

If visibility cannot be secured when sliding up the lens, or if you cannot raise the lens, start again from step 1.

Caution

To prevent the headset from being dropped while removing the helmet, hold the head pad in one hand while removing the helmet.

Replacing the Rubber Band (BT-2200)

If the headset's rubber band deteriorates, replace it with a new rubber band.

1 With the rubber folded in half, route it through the adjuster.

Make sure you route the rubber through the uneven side at the back of the adjuster.

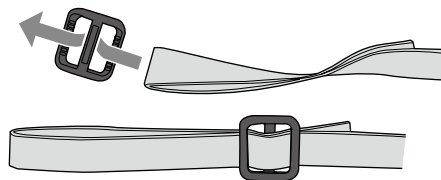



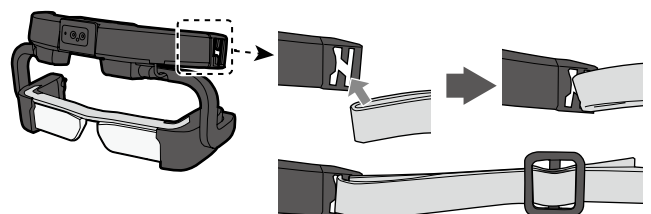

2 Route the rubber through the gap in the center of the adjuster.

Pull the leading edge of the folded over rubber band to the helmet side (inner round section).

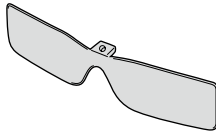
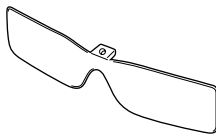
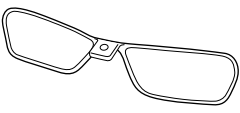

Included Items

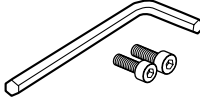
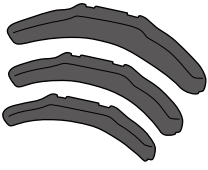
	Headset Wear the headset to view images. ➔ "3. Wearing the headset" p. 17
	Controller (with controller holder) Operates the product. ➔ "Wearing the Controller" p. 9
	Armband Allows you to wear the controller on your arm.
	Reel clip Use this to secure the cable.
	Battery packs (x2) Powers the product. ➔ "Charging the Battery" p. 6
	AC adapter/AC cable Charges the product. ➔ "Charging the Battery" p. 6

	Shade Shades the product from too much exterior light. ➔ "Installing the Shade/Protective Shield/Lens Holder" p. 7
	Protective shield Protects the product's lens from foreign objects and air-borne objects. ➔ "Installing the Shade/Protective Shield/Lens Holder" p. 7
	Lens holder Install lenses to the holder and attach it to the headset. This allows users who wear glasses to remove their glasses before wearing the headset. ➔ "Installing the Shade/Protective Shield/Lens Holder" p. 7
	Mono earphones with mic Outputs audio from the product, and inputs audio to the product.
	Hexagon wrench and screws (x2) Use these to attach the lens holder, shade, and protective shield.
	Inner pads (A/B/C) Attach inside the headset to adjust the headset to a comfortable position. Inner pad B is attached to the headset at the time of purchase. ➔ "Replacing the Inner Pad" p. 7
	User's Guide

Headset (BT-2000)

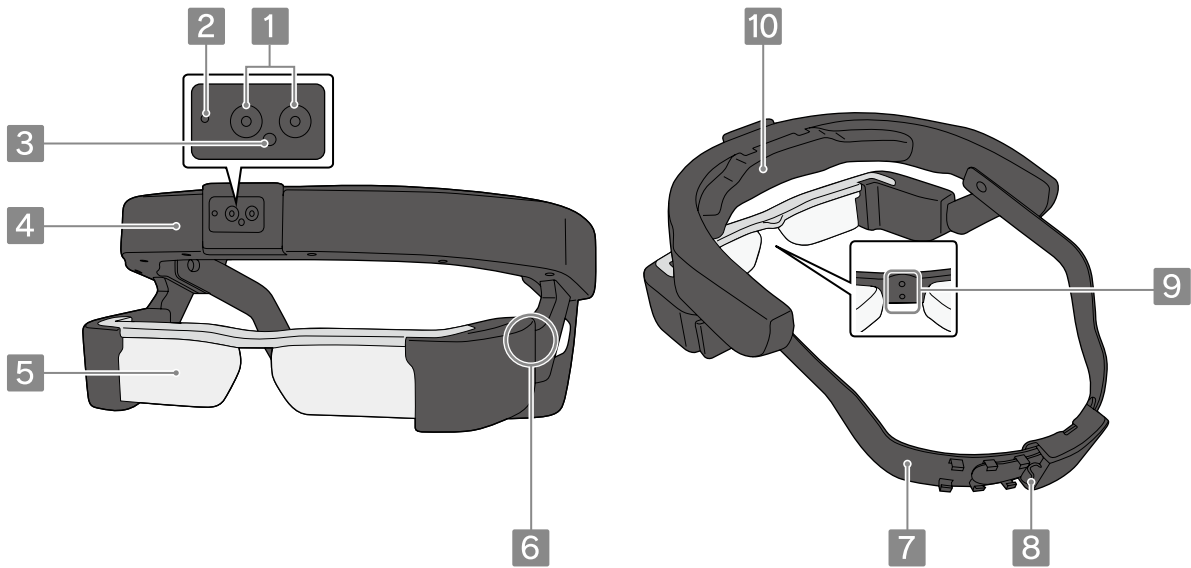

For Both Headsets

BT-2200

BT-2000

1 Camera

Captures images and movies. Remove the protective film before use. You can adjust the angle of the camera.

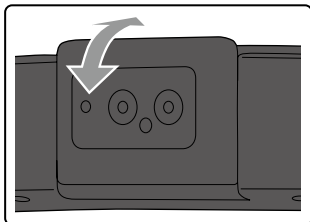

2 Camera indicator

Flashes while the camera is operating.

3 Light sensor

Senses the brightness of your surroundings and automatically adjusts the brightness of the screen.

4 Head pad

Fits against your forehead when wearing the headset. The head pad is equipped with a built-in sensor to detect the position and direction of the product.

5 Lens

Displays images. When not displaying images, you can slide up the lens to the head pad.

6 Lens justifier

You can adjust the position of the lens vertically. Adjust the left and right by the same amount so that the lens is not tilted during adjustment.

7 Head band

Secures the headset on to your head. You can adjust the length to fit the size of your head (head circumference: 560 to 640 mm).

8 Cable securer

Secures cables when wearing the headset.

9 Screw holes to secure the shade/protective shield/lens holder

Install the shade/protective shield using the exterior screw holes. Install the lens holder using the interior screw holes.

➔ "Installing the Shade/Protective Shield/Lens Holder" p. 7

10 Inner pad (B)

If the headset feels tight, replace this with the inner pad A or C. Using a smaller inner pad loosens the headset.

➔ "Replacing the Inner Pad" p. 7

Wearing the Product

Warning Product usage precautions

- Before operating this product, make sure it can be worn according to the procedures in "Wearing the Controller" p. 9 as well as on this page and the following pages.
- As much as possible, make sure that the cables are secured to your body and do not sag or droop. If the cables come loose, they could get caught or entangled in something and cause an accident or injury.

1. Wearing the controller

➔ "Wearing the Controller" p. 9

2. Turning on

➔ "Turning On and Off" p. 8

Check that the power indicator on the product is light blue (turned on).

3. Wearing the headset

Caution

When the lens is lowered, your field of vision is narrowed even when nothing is displayed. When not viewing images, make sure you slide up the lens for your own safety.

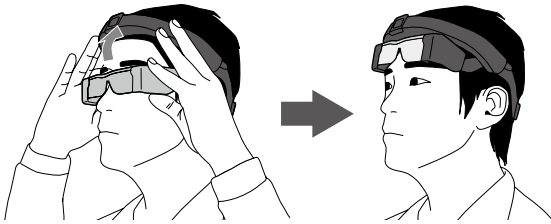

Note

The headset can be worn over glasses that are up to 143 mm wide.

- 1 Move the lens as far away from the head pad as possible.

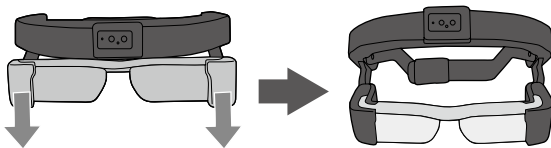

Note

When wearing the headset over a cap, remove the cap and fit it into the headset.

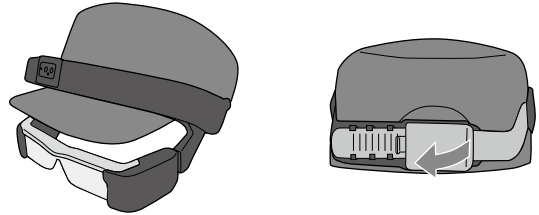

- You may not be able to attach this product to helmets with large brims. Also, if the brim of the helmet sticks out too far, it may interfere with the camera image. The recommended brim length is 40 mm or less.
- Match the size of the cap with your head in advance.
- Place the head pad on the brim of the cap.
- Adjust the length of the head band according to the size of the cap.



- 2 Run the cable through the cable securing section of the headset.

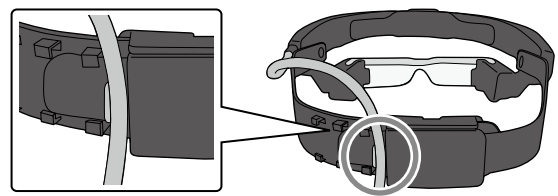

3 Tighten the head band and secure the head pad.

Position the headset while adjusting the position of the lens so that you can see the images clearly.

Tighten the head band at the back of your head so that the head pad does not slip out of position.

**Note**

When wearing the headset with a cap, make sure there is no gap between the brim of the cap and the head pad.

4 If you cannot view a part or any of the image, adjust the lens justifier on either side of the lens.

Make sure the head pad does not slip out of position while adjusting.

Adjust the left and right by the same amount so that the lens is not tilted.

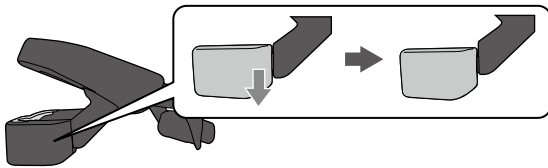

If you still cannot view images even after adjusting the lens justifier, start again from step 3.

5 Check that you can slide up the lens and secure visibility.

If visibility cannot be secured when sliding up the lens, or if you cannot raise the lens, start again from step 1.

Caution

Do not use too much force when adjusting the position of the headset.

Note

- If the headset feels tight, replace this with the inner pad A or C. Using a smaller inner pad loosens the headset.
 - ➔ "Replacing the Inner Pad" p. 7
- To prevent the product from being dropped, hold the head pad in one hand while loosening the headband and removing the headset.

**Re-tightening Screws (BT-2000)**

After using the product for an extended period, the screws securing the lens may become loose.

Re-tighten the screws periodically using the hexagon wrench supplied.

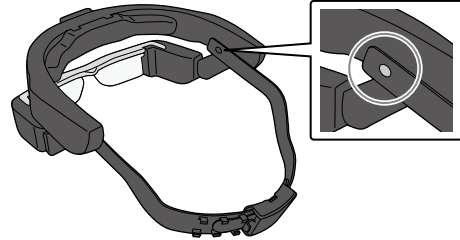

Cleaning the Headset

- If you can see marks in the image or if the image is hazy, check that there is no dust, fingerprints, and other dirt on the lens. If the lenses are dirty, wipe them carefully with a soft cloth.

Caution

When wiping the lenses, do not use lens cleaning liquids or organic solvents.

- If the camera is dirty, wipe it carefully with a soft cloth.
- If the inner pad is dirty, dampen a cloth in warm water, wring it out thoroughly, and then wipe the inner pad carefully.

Storing and Transporting the Headset

- When storing the product, place it in the box it came in, or on the optional hard carry case.
- If you will not be using the product for a while, remove the batteries before storing the product.
- When placing the headset, make sure it is placed horizontally so that it does not touch against hard objects. If the headset is placed with the lens facing down and the lens touches hard objects, the lens could be damaged.
- When carrying the headset, make sure you grip both sides of the headset firmly so that it is not dropped.

Cleaning the Charging Connectors

If the controller's power connectors (x2) or the battery's connectors are soiled or if there are foreign objects stuck to them, you may not be able to charge correctly. Disconnect the AC adapter and the AC cable, and wipe off any dirt with a dry cloth or a cotton swab. We recommend cleaning the charging connectors regularly (once every three months).

Caution

- Do not damage the charging connectors with your finger or a hard object.
- Do not expose the charging connectors to water. When cleaning the charging connectors, use a dry cloth or a cotton swab.

Troubleshooting

If you think a malfunction has occurred, check the following.

The product does not turn on

- Check that the batteries are installed in the controller correctly.
- Check that the batteries are fully charged.
- If the product cannot turn on due to insufficient power, the power indicator flashes red three times.
- Press the [] power button until the power indicator is lit light blue. When the power indicator flashes light blue, the product is starting up. Startup is complete when the power indicator changes from flashing to lit light blue.
 - ➔ "Turning On and Off" p. 8
- When charging cannot be performed or operations are unresponsive, force the product to turn off, and then restart the device.
- If the controller gets too hot due to prolonged use or the usage environment, the product may turn off for safety reasons. If you use this product while it is charging, the controller may get very hot and charging may stop. Wait for the temperature to fall, and then turn the product back on.

Cannot see images

The headset may not be at the correct height.



(BT-2200) ➔ "4. Wearing the headset" p. 14

(BT-2000) ➔ "3. Wearing the headset" p. 17

Cannot hear audio

To listen to audio from the product, use the mono earphones with mic supplied.

Cannot use the controller

- You cannot perform controller operations when the key lock indicator is lit (Key lock enabled). Press the [] key lock button to release key lock.
 - ➔ "Disabling controller operations (Key lock)" p. 8
- When the power indicator is blue (during Sleep mode), press the [] power button briefly.
 - ➔ "Turning off the screen while the product is on (Sleep mode)" p. 8

Cannot connect to the network

- Check that the wireless LAN (Wi-Fi) environment can be accessed from where you are using the product.
- Check that the product's network settings are correct. Contact your network administrator for more details.

Date and time settings are reset

This product is equipped with a backup battery to maintain the date and time settings even if the main battery runs out. If you do not use this product for a long time, the charge in the backup battery may run out, and the date and time are returned to their defaults.

- Make sure you charge this product when the battery is installed. The backup battery takes about five days to charge completely. You can still use the product while charging the backup battery.
 - ➔ "Charging the Battery" p. 6
- When the backup battery has been charged, turn on the product, select [Settings] - [SYSTEM] - [Date & time], and then set the date and time.

Optional Items

You can purchase replacement parts for parts that wear out through normal use. See the following website to inquire about purchasing replacement parts.
<https://tech.moverio.epson.com/ja/store.html>

For Both Headsets	
	<p>Hard carrying case BO-HC2200 Use this case when carrying or storing the product.</p>
	<p>Quad battery charger BO-QC2000 Allows you to charge four battery packs simultaneously. (The battery packs are not included.)</p>
	<p>Battery packs (x2)* BO-BP2000</p>
	<p>Shade/Protective shield pack* BO-SD2000</p>
	<p>Armband/Controller holder pack BO-PW2000</p>
	<p>Controller holder* BO-CH2200</p>
	<p>Shoulder holder BO-SH2200</p>

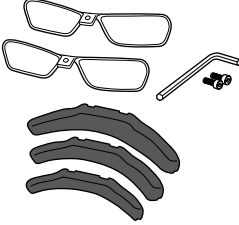
BT-2000	
	<p>Inner pads (A/B/C)/Lens holder pack* BO-IP2000</p>

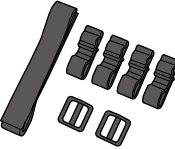
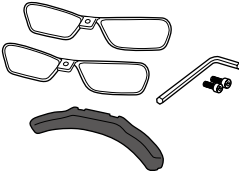
BT-2200	
	<p>Helmet holder/Rubber band pack* BO-HP2200</p>
	<p>Inner pads/Lens holder pack* BO-IP2200</p>

* Included with the product at time of purchase.

Specifications

Model Number		BT-2000(H725A)/BT-2200(H853A)	
Material		Polysilicon TFT active matrix	
LCD panel size		0.42" wide panel (16:9)	
LCD panel pixel count		Horizontal 960 x Vertical 540 dots	
Angle of view		Approximately 23 degrees (diagonally)	
Virtual screen size		64" support (virtual viewing distance 4 m)	
Color reproduction		24 bit color (approximately 16,770,000 colors)	
Supported movie formats		MP4 (MPEG4+AAC), MPEG2 (H.264+AAC)	
Supported still image formats		JPEG, PNG, BMP, GIF	
Supported audio formats		WAV, MP3, AAC	
Supported 3D		Side-by-side format	
Internal memory	Main memory	1 GB	
	User memory	8 GB	
External memory		microSD (2 GB maximum), microSDHC (32 GB maximum)	
Connector ports		microUSB, 4 pin mini jack (earphones with microphone complying with the CTIA standard)*1, microSD card slot	
Operating temperature		0 to 40°C, humidity 20 to 80% (no condensation)	
Charging temperature		5 to 35°C, humidity 20 to 80% (no condensation)	
Storage temperature		-10 to 60°C, humidity 10 to 90% (no condensation)	
Power voltage	Controller	11 VDC 1.64 A (when AC adapter connected)	
AC adapter	Model Number	AST1116Z2-1	
	Manufacturer	PHIHONG TECHNOLOGY CO., LTD.	
	Rated output voltage/ Current	1.64A/11V	
Power consumption		When operating at full capacity 4000 mW, when in sleep mode 80 mW, when off 5 mW	
Battery	Type	Lithium-ion batteries 1240 mAh (x2)	
	Lithium content	Less than 1.5 g	
	Amount of watt hour rating	Less than 20 Wh	
Frequency band		IEEE 802.11 b/g/n/a	
Frequency range		2.4 GHz band 1 to 13 ch, 5 GHz band 36 to 140 ch	
Modulation		OFDM, DS-SS	
Potential interference range		10 m	
Battery life		Approx. 4 hours (When operating at high-capacity)	
Reliability	Life span	10,000 h (When brightness is set to the default, and used continuously in an environment of 25°C. Screen luminance declines by 50% from the initial stages, and points begin to appear in the wear out failure period.)	
	MTBF	180,000 hours (Failure means a random failure during the random failure period.)	
Exterior dimensions (W x D x H)	Headset	BT-2000: 205 x 136 x 100 mm (without the head band) BT-2200: 206 x 96 x 109 mm (without the rubber band)	
	Controller	70 x 157 x 35.3 mm (without protruding section)	
Mass	Headset	BT-2000: 290 g (without cables) BT-2200: 270 g (without cables)	
	Controller	265 g (without batteries, 1 battery is approx. 50 g)	
Camera	Pixel count	5 million pixels	
	Image resolutions	Still images	2596 x 1948 dots
		Movies	1920 x 1080 dots
		Depth sensing	640 x 480 dots (depth sensing distance 30 to 100 cm)
Earphones with mic	Earphone impedance	16Ω ±15%	
	Earphone output	Max. voltage 150 mV or less Voltage with broadband characteristics 75 mV or more	
	Mic	Capacitor microphone	
Sensors		GPS/geomagnetic sensor/IMU (accelerometer/gyroscopic sensor)/illumination sensor	
Bluetooth 3.0		HSP/A2DP/HID/OPP/SPP/AVRCP	
Bluetooth 4.0 LE *2		PXP/FMP	

*1 Restrictions in operation may occur when using an adapter plug.

*2 You can only connect to a beacon with devices specified by Epson.

Intellectual Property Rights

Trademarks



microSDHC Logo is a trademark of SD-3C, LLC.

Wi-Fi® and Wi-Fi Direct™ are the trademarks or registered trademarks of the Wi-Fi Alliance.

Other product names used herein are also for identification purposes only and may be trademarks of their respective owners. Epson disclaims any and all rights in those marks.

OPEN SOURCE SOFTWARE LICENSE

As well as software owned by Epson, this product also uses open source software.

The following provides information on the open source software used in this product.

1. This product includes open source software programs according to the license terms of each program.
The open source software programs are without warranty; however, any malfunctions (including malfunctions caused by the open source software programs) that occur in this product do not influence the warranty conditions provided for this product.
2. We provide the source code of some open source software programs. If you desire to receive the source code above, please see the "http://www.epson.com" and contact the customer support of your region. We provide the source code until five (5) years after the release of this product. You shall comply with the license terms of each open source software program.
3. The open source software programs are WITHOUT ANY WARRANTY; without even the implied warranty of MERCHANTABILITY AND FITNESS FOR A PARTICULAR PURPOSE. See the license agreements of each open source software program for more details, which are described in the product.
4. The license terms of each open source software program are described in Home screen > Settings > About device > Legal information > Open source licenses of the product.

General Notes

Notes Regarding Wireless LAN

If you purchase this product outside of North America and Taiwan, please note that this product emits wireless LAN electromagnetic waves on channels 1 to 13. Therefore, do not use the wireless LAN function in North America and Taiwan where wireless LAN channels are limited to 1 to 11 by the Wireless Telegraphy Act.
Follow local laws and regulations when using in other regions.

Wireless Telegraphy Act Regulations

The following acts are prohibited by the Wireless Telegraphy Act.

- Modifying and disassembling (including the antenna)
- Removing the label of conformance
- Using the 5 GHz bandwidth LAN when outdoors

Restriction of Use

This product is manufactured based on the specifications of the country of sale. When using this product outside the country of sale, contact your nearest support center.

When this product is used for applications requiring high reliability/safety of function and precision, such as transportation devices related to aviation, rail, marine, automotive; disaster prevention devices; various safety devices, you should use this product only after giving consideration to including fail-safes and redundancies into your design to maintain safety and total system reliability.

Because this product was not intended for use in applications requiring extremely high reliability/safety such as aerospace equipment, main communication equipment, nuclear power control equipment, or medical equipment related to direct medical care, please make your own judgment on this product's suitability after a full evaluation.

Notes on Frequency

This product operates in the same frequency bandwidth as industrial devices such as microwave ovens, scientific, and medical devices and mobile object identification (RF-ID) systems (licensed premises radio stations, amateur, and unlicensed specified low-power radio stations (hereafter "other radio stations")) used in factory production lines.

1. Before using this device, make sure there are no "other radio stations" being used in the vicinity.
2. If this device causes RF interference between the device and "other radio stations", promptly move to a different location, stop using the device, and contact your local dealer to ask for advice on preventing interference (for example setting up partitions).
3. In addition, when harmful radio wave interference occurs between the device and "other radio stations", contact your local dealer.

Authentication information

U.S.A.

Contains FCC ID : RYYWYSAVDXB-E , RYYEYSFCN



Japan



R 001-A05576
R 001-A01718



Canada

Contains IC : 4389B-WYSAVDXBE , 4389B-EYSFCN

Singapore

Complies with IMDA Standards DB101624

Europe



Operating frequency range:
WLAN:2412-2472MHz, Below 20dBm e.i.r.p. / 5180-5240MHz 5260-5320MHz 5500-5700MHz, Below 20dBm e.i.r.p.
Bluetooth:2402-2480MHz, Below 20dBm e.i.r.p.

General Notes

CE
DECLARATION of CON-
FORMITY



The purpose of the WLAN function is to connect to a 2.4 GHz access point.

Radio equipments are restricted to indoor operation only in the band 5150-5250MHz and 5250-5350MHz in Austria (AT), Belgium (BE), Bulgaria (BG), Cyprus (CY), Czech Republic (CZ), Germany (DE), Denmark (DK), Estonia (EE), Spain (ES), Finland (FI), France (FR), United Kingdom (GB), Greece (GR), Croatia (HR), Hungary (HU), Ireland (IE), Italy (IT), Lithuania (LT), Luxembourg (LU), Latvia (LV), Malta (MT), Netherlands (NL), Poland (PL), Portugal (PT), Romania (RO), Sweden (SE), Slovenia (SI) and Slovakia (SK).

FCC Compliance State-
ment

This equipment has been tested and found to comply with the limits for a Class A digital device, pursuant to part 15 of the FCC Rules. These limits are designed to provide reasonable protection against harmful interference when the equipment is operated in a commercial environment. This equipment generates, uses, and can radiate radio frequency energy and, if not installed and used in accordance with the instruction manual, may cause harmful interference to radio communications. Operation of this equipment in a residential area is likely to cause harmful interference in which case users will be required to correct the interference at their own expense.

WARNING

The connection of a non-shielded equipment interface cable to this equipment will invalidate the FCC Certification or Declaration of this device and may cause interference levels which exceed the limits established by the FCC for this equipment. It is the responsibility of the user to obtain and use a shielded equipment interface cable with this device. If this equipment has more than one interface connector, do not leave cables connected to unused interfaces. Changes or modifications not expressly approved by the manufacturer could void the user's authority to operate the equipment.

FCC/Industry Canada (IC)
Notices

FCC Notices

This device complies with Part 15 of the FCC Rules. Operation is subject to the following two conditions: (1) this device may not cause harmful interference, and (2) this device must accept any interference received, including interference that may cause undesired operation.

This equipment complies with FCC radiation exposure limits set forth for an uncontrolled environment. End-users must follow the specific operating instructions for satisfying RF exposure compliance. This transmitter must not be co-located or operating in conjunction with any other antenna or transmitter.

Caution:

You are cautioned that changes or modifications not expressly approved by the party responsible for compliance could void your authority to operate the equipment.

Industry Canada (IC) Notices

CAN ICES-3 (A)/NMB-3(A)

This Class A digital apparatus complies with Canadian ICES-003.

Cet appareil numérique de la classe A est conforme à la norme NMB-003 du Canada.

This equipment complies with RF radiation exposure limits set forth for an uncontrolled environment. End-users must follow the specific operating instructions for satisfying RF exposure compliance. This transmitter must not be co-located or operating in conjunction with any other antenna or transmitter.

This device complies with Industry Canada's licence-exempt RSSs. Operation is subject to the following two conditions:

- (1) This device may not cause interference; and
- (2) This device must accept any interference, including interference that may cause undesired operation of the device.

Le présent appareil est conforme aux CNR d'Industrie Canada applicables aux appareils radio exempts de licence. L'exploitation est autorisée aux deux conditions suivantes :

- (1) l'appareil ne doit pas produire de brouillage, et (2) l'utilisateur de l'appareil doit accepter tout brouillage radioélectrique subi, même si le brouillage est susceptible d'en compromettre le fonctionnement.

SAR Notices

This device with the WLAN device has been tested to SAR and complies to FCC and IC exposure requirements for portable devices. SAR testing has been done at distance of 0 cm from the body.

Cet appareil avec l'appareil W-LAN a été testé aux SAR et est conforme aux exigences des FCC et IC exposition pour les appareils portables. Le test SAR a été fait à distance de 0 cm du corps.













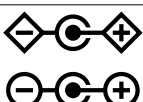

Indication of the manufacturer and the importer in accordance with requirements of EU directive

Manufacturer: SEIKO EPSON CORPORATION
Address: 3-5, Owa 3-chome, Suwa-shi, Nagano-ken 392-8502 Japan
Telephone: 81-266-52-3131
<http://www.epson.com/>

Importer: EPSON EUROPE B.V.
Address: Atlas Arena, Asia Building, Hoogoorddreef 5, 1101 BA Amsterdam Zuidoost The Netherlands
Telephone: 31-20-314-5000
<http://www.epson.eu/>

List of Safety Symbols

The following table lists the meaning of the safety symbols labeled on the equipment.

No.	Symbol mark	Approved standards	Meaning
1		IEC60417 No. 5007	"ON" (power) To indicate connection to the mains.
2		IEC60417 No. 5008	"OFF" (power) To indicate disconnection from the mains.
3		IEC60417 No. 5009	Stand-by To identify the switch or switch position by means of which part of the equipment is switched on in order to bring it into the stand-by condition.
4		ISO7000 No. 0434B IEC3864-B3.1	Caution To identify general caution when using the product.
5		IEC60417 No. 6042 ISO3864-B3.6	Caution, risk of electric shock To identify equipment that has risk of electric shock.
6		IEC60417 No. 5957	For indoor use only To identify electrical equipment designed primarily for indoor use.
7		IEC60417 No. 5926	Polarity of d.c. power connector To identify the positive and negative connections (the polarity) on a piece of equipment to which a d.c. power supply may be connected.
8		IEC60417 No. 5017	Earth To identify an earth (ground) terminal.
9		IEC60417 No. 5032	Alternating current To indicate on the rating plate that the equipment is suitable for alternating current only; to identify relevant terminals.
10		IEC60417 No. 5031	Direct current To indicate on the rating plate that the equipment is suitable for direct current only; to identify relevant terminals.
11		IEC60417 No. 5172	Class II equipment To identify equipment meeting the safety requirements specified for Class II equipment according to IEC 61140.
12		ISO 3864	General prohibition To identify actions or operations that are prohibited.
13		ISO 3864	Contact prohibition To indicate injury that could occur due to touching a specific part of the equipment.
14		IEC60417 No. 5266	Standby, partial standby To indicate that part of the equipment is in the ready status.

Contact List

This address list is current as of March 2019.

A more up-to-date contact address can be obtained from the corresponding website listed here. If you do not find what you need on any of these pages, please visit the main Epson home page at www.epson.com.

EUROPE, MIDDLE EAST & AFRICA

ALBANIA ITD Sh.p.k. http://www.itd-al.com	AUSTRIA Epson Deutschland GmbH https://www.epson.at	BELGIUM Epson Europe B.V. Branch office Belgium https://www.epson.be	BOSNIA AND HERZEGOVINA NET d.o.o. Computer Engineering http://www.net.com.ba
BULGARIA Epson Service Center Bulgaria http://www.kolbis.com	CROATIA MR servis d.o.o. http://www.mrservis.hr	CYPRUS Mechatronic Ltd. http://www.mechatronic.com.cy	CZECH REPUBLIC Epson Europe B.V. Branch Office Czech Republic https://www.epson.cz
DENMARK Epson Denmark https://www.epson.dk	ESTONIA Epson Service Center Estonia https://www.epson.ee	FINLAND Epson Finland https://www.epson.fi	FRANCE & DOM-TOM TERRITORY Epson France S.A. https://www.epson.fr
GERMANY Epson Deutschland GmbH https://www.epson.de	GREECE Oktabit S.A. https://www.oktabit.gr	HUNGARY Epson Europe B.V. Branch Office Hungary https://www.epson.hu	IRELAND Epson (UK) Ltd. https://www.epson.ie
ISRAEL Epson Israel https://www.epson.co.il	ITALY Epson Italia s.p.a. https://www.epson.it	KAZAKHSTAN Epson Kazakhstan Rep. Office http://www.epson.kz	LATVIA Epson Service Center Latvia https://www.epson.lv
LITHUANIA Epson Service Center Lithuania https://www.epson.lt	LUXEMBURG Epson Europe B.V. Branch office Belgium https://www.epson.be	NORTH MACEDONIA Digit Computer Engineering http://digit.net.mk/	NETHERLANDS Epson Europe B.V. Benelux sales office https://www.epson.nl
NORWAY Epson Norway https://www.epson.no	POLAND Epson Europe B.V. Branch Office Poland https://www.epson.pl	PORTUGAL Epson Ibérica S.A.U. Branch Office Portugal https://www.epson.pt	ROMANIA Epson Europe B.V. Branch Office Romania https://www.epson.ro
RUSSIA Epson CIS http://www.epson.ru	UKRAINE Epson Kiev Rep. Office http://www.epson.ua	SERBIA Atom partner http://www.atompartner.rs/wp/ EWE Comp https://www.ewe.rs	SLOVAKIA Epson Europe B.V. Branch Office Czech Republic https://www.epson.sk
SLOVENIA Birotehna d.o.o. http://www.birotehna.si	SPAIN Epson Ibérica, S.A.U. https://www.epson.es	SWEDEN Epson Sweden https://www.epson.se	SWITZERLAND Epson Deutschland GmbH Branch office Switzerland https://www.epson.ch
TURKEY Tecpro Bilgi Teknolojileri Tic. ve San. Ltd. Sti. http://www.tecpro.com.tr	UK Epson (UK) Ltd. https://www.epson.co.uk	AFRICA https://www.epson.co.za or https://www.epson.fr	SOUTH AFRICA Epson South Africa https://www.epson.co.za
MIDDLE EAST Epson (Middle East) https://www.epson.ae			

NORTH, CENTRAL AMERICA & CARIBBEAN ISLANDS**CANADA**

Epson Canada, Ltd.
<https://epson.ca>

COSTA RICA

Epson Costa Rica, S.A.
<https://epson.co.cr>

MEXICO

Epson Mexico, S.A. de C.V.
<https://epson.com.mx>

ECUADOR

Epson Ecuador
<https://epson.com.ec>

U. S. A.

Epson America, Inc.
<https://epson.com/usa>

SOUTH AMERICA**ARGENTINA**

Epson Argentina S.R.L.
<https://epson.com.ar>

BRAZIL

Epson do Brasil
<https://epson.com.br>

CHILE

Epson Chile S.A.
<https://epson.cl>

COLOMBIA

Epson Colombia Ltd.
<https://epson.com.co>

PERU

Epson Peru S.A.
<https://epson.com.pe>

VENEZUELA

Epson Venezuela S.A.
<https://epson.com.ve>

ASIA & OCEANIA**AUSTRALIA**

Epson Australia Pty. Ltd.
<https://www.epson.com.au>

CHINA

Epson (China) Co., Ltd.
<https://www.epson.com.cn>

HONG KONG

Epson Hong Kong Ltd.
<https://www.epson.com.hk>

INDIA

Epson India Pvt., Ltd.
<https://www.epson.co.in>

INDONESIA

PT. Epson Indonesia
<https://www.epson.co.id>

JAPAN

Seiko Epson Co.
 Toyoshina Plant
<https://www.epson.jp>

KOREA

Epson Korea Co., Ltd.
<http://www.epson.co.kr>

MALAYSIA

Epson Malaysia Sdn. Bhd.
<https://www.epson.com.my>

NEW ZEALAND

Epson New Zealand
<https://www.epson.co.nz>

PHILIPPINES

Epson Philippines Co.
<https://www.epson.com.ph>

SINGAPORE

Epson Singapore Pte. Ltd.
<https://www.epson.com.sg>

TAIWAN

Epson Taiwan Technology & Trading Ltd.
<https://www.epson.com.tw>

THAILAND

Epson (Thailand) Co.,Ltd.
<https://www.epson.co.th>

