

DS-50000 DS-60000 DS-70000

User's Guide

Copyright

No part of this publication may be reproduced, stored in a retrieval system, or transmitted in any form or by any means, electronic, mechanical, photocopying, recording, or otherwise, without the prior written permission of Seiko Epson Corporation. No patent liability is assumed with respect to the use of the information contained herein. Neither is any liability assumed for damages resulting from the use of the information herein. The information contained herein is designed only for use with this Epson product. Epson is not responsible for any use of this information as applied to other products.

Neither Seiko Epson Corporation nor its affiliates shall be liable to the purchaser of this product or third parties for damages, losses, costs, or expenses incurred by the purchaser or third parties as a result of accident, misuse, or abuse of this product or unauthorized modifications, repairs, or alterations to this product, or (excluding the U.S.) failure to strictly comply with Seiko Epson Corporation's operating and maintenance instructions.

Seiko Epson Corporation and its affiliates shall not be liable for any damages or problems arising from the use of any options or any consumable products other than those designated as Original Epson Products or Epson Approved Products by Seiko Epson Corporation.

Seiko Epson Corporation shall not be held liable for any damage resulting from electromagnetic interference that occurs from the use of any interface cables other than those designated as Epson Approved Products by Seiko Epson Corporation.

© 2021 Seiko Epson Corporation

The contents of this manual and the specifications of this product are subject to change without notice.

Trademarks

- ❑ EPSON® is a registered trademark, and EPSON EXCEED YOUR VISION or EXCEED YOUR VISION is a trademark of the Seiko Epson Corporation.
- ❑ Microsoft, Windows, Windows Server, and Windows Vista are either registered trademarks or trademarks of Microsoft Corporation in the United States and/or other countries.
- ❑ Apple, macOS, and OS X are trademarks of Apple Inc., registered in the U.S. and other countries.
- ❑ Adobe, Adobe Reader, and Acrobat are registered trademarks of Adobe Systems Incorporated.
- ❑ Intel® is a registered trademark of Intel Corporation.
- ❑ General Notice: Other product names used herein are for identification purposes only and may be trademarks of their respective owners. Epson disclaims any and all rights in those marks.

Contents

Copyright

Trademarks

About This Manual

Introducing the Manuals.	6
Marks and Symbols.	6
Descriptions Used in this Manual.	6
Operating System References.	7

Important Instructions

Safety Instructions.	8
Restrictions on Copying.	9
Restriction on Disassembling and Decompiling.	10

Scanner Basics

Product Parts.	11
Buttons.	13
Lights.	14
Information on Applications.	14
Epson Scan 2.	14
Document Capture Pro / Document Capture.	14
Document Capture Pro Server.	15
EPSON Software Updater.	15
Option Items and Consumables Information.	16
Network Interface Panel Codes.	16
Roller Assembly Kit Codes.	16
Cleaning Kit Codes.	17

Specifications of Originals and Placing Originals

Loading Documents in the ADF(For DS-60000/ DS-70000).	18
Document specifications.	18
Loading documents in the ADF.	19
Placing Documents on the Document Glass.	20
Placing Thick Documents on the Document Glass.	22

Basic Scanning

Scanning from the Button.	24
Scanning Using Document Capture Pro (Windows).	24

Scanning Using Document Capture (Mac OS).	29
Scanning Using Epson Scan 2.	35

Advanced Scanning

Setting a Job (Scan, Save, and Send).	39
Creating and Registering a Job (Windows).	39
Creating and Registering a Job (Mac OS).	40
Enabling a Job to Run from the Control Panel (Button Assignment).	40
Assigning a Job to the Control Panel (Windows).	40
Assigning a Job to the Control Panel (Mac OS).	41
Separation Feature (for Windows Only).	41
Sorting and Saving Scanned Images into a Separate Folder.	43
Saving as an Office Format File (for Windows Only).	48

Maintenance

Cleaning the Scanner.	50
Replacing the Roller Assembly Kit.	52
Resetting the Number of Scans in Epson Scan 2 Utility.	56
Energy Saving.	57
Transporting the Scanner.	58
Updating Applications and Firmware.	59

Solving Problems

Problems Indicated by Status Light.	61
Problems When Starting a Scan.	61
Using the ADF.	62
Cannot Start Document Capture Pro (Windows) or Document Capture (Mac OS).	62
You Cannot Start EPSON Scan 2.	62
Paper Feeding Problems.	63
The paper jams in the ADF.	63
Multiple Originals Are Fed.	65
The Originals Get Dirty.	65
Scanning Takes a Long Time.	65
Scanned Image Problems.	65
Scan quality is unsatisfactory.	65
Straight Lines Appear when Scanning from ADF.	66
Offset Appears in the Background of Images.	66

Scanned Image or Text is Blurred.	66
Character is not Recognized Correctly.	67
Moiré Patterns (Web-Like Shadows) Appear.	68
Cannot Scan the Correct Area on the Document Glass.	68
The Edge of the Original is Not Scanned when Automatically Detecting the Size of the Original.	68
Cannot Solve Problems in the Scanned Image.	69
Uninstalling and Installing Applications.	69
Uninstalling Your Applications.	69
Installing Your Applications.	71

Technical Specifications

General Scanner Specifications.	72
Dimensions and Weight Specifications.	73
Electrical Specifications.	73
Scanner Electrical Specifications.	73
Environmental Specifications.	74
System Requirements.	74

Standards and Approvals

Standards and Approvals for European Models.	76
Standards and Approvals for Australian Model.	76

Where to Get Help

Technical Support Web Site.	77
Contacting Epson Support.	77
Before Contacting Epson.	77
Help for Users in Europe.	77
Help for Users in Taiwan.	78
Help for Users in Australia.	78
Help for Users in Singapore.	79
Help for Users in Thailand.	79
Help for Users in Vietnam.	79
Help for Users in Indonesia.	80
Help for Users in Hong Kong.	82
Help for Users in Malaysia.	83
Help for Users in India.	83
Help for Users in the Philippines.	84

About This Manual

Introducing the Manuals

The latest versions of the following manuals are available from the Epson support website.

<http://www.epson.eu/Support> (Europe)

<http://support.epson.net/> (outside Europe)

Setup Guide (paper manual)

Provides you with information on setting up the product and installing the application.

User's Guide (digital manual)

Provides instructions on using the product, maintenance, and solving problems.

As well as the manuals above, see the help included in the various Epson applications.

Marks and Symbols



Caution:

Instructions that must be followed carefully to avoid bodily injury.



Important:

Instructions that must be observed to avoid damage to your equipment.

Note:

Provides complementary and reference information.

Related Information

➔ Links to related sections.

Descriptions Used in this Manual

- Screenshots for the applications are from Windows 10 or macOS High Sierra. The content displayed on the screens varies depending on the model and situation.
- Illustrations used in this manual are for reference only. Although they may differ slightly from the actual product, the operating methods are the same.

Operating System References

Windows

In this manual, terms such as "Windows 10", "Windows 8.1", "Windows 8", "Windows 7", "Windows Vista", "Windows XP", "Windows Server 2019", "Windows Server 2016", "Windows Server 2012 R2", "Windows Server 2012", "Windows Server 2008 R2", "Windows Server 2008", "Windows Server 2003 R2", and "Windows Server 2003" refer to the following operating systems. Additionally, "Windows" is used to refer to all versions and "Windows Server" is used to refer to "Windows Server 2016", "Windows Server 2012 R2", "Windows Server 2012", "Windows Server 2008 R2", "Windows Server 2008", "Windows Server 2003 R2", and "Windows Server 2003".

- Microsoft® Windows® 10 operating system
- Microsoft® Windows® 8.1 operating system
- Microsoft® Windows® 8 operating system
- Microsoft® Windows® 7 operating system
- Microsoft® Windows Vista® operating system
- Microsoft® Windows® XP operating system Service Pack 3
- Microsoft® Windows® XP Professional x64 Edition operating system Service Pack 2
- Microsoft® Windows Server® 2019 operating system
- Microsoft® Windows Server® 2016 operating system
- Microsoft® Windows Server® 2012 R2 operating system
- Microsoft® Windows Server® 2012 operating system
- Microsoft® Windows Server® 2008 R2 operating system
- Microsoft® Windows Server® 2008 operating system
- Microsoft® Windows Server® 2003 R2 operating system
- Microsoft® Windows Server® 2003 operating system Service Pack 2

Mac OS

In this manual, "Mac OS" is used to refer to macOS Mojave, macOS High Sierra, macOS Sierra, OS X El Capitan, OS X Yosemite, OS X Mavericks, OS X Mountain Lion, Mac OS X v10.7.x, and Mac OS X v10.6.8.

Important Instructions

Safety Instructions

Read and follow these instructions to ensure safe use of this product and options. Make sure you keep this manual for future reference. Also, be sure to follow all warnings and instructions marked on the product and options.

- Some of the symbols used on your product are to ensure safety and proper use of the product. Visit the following Web site to learn the meaning of the symbols.
<http://support.epson.net/symbols>
- Place the product and options on a flat, stable surface that extends beyond the base of the product and options in all directions. If you place the product and options by the wall, leave more than 10 cm between the back of the product and options and the wall.
- Avoid places subject to dust, shocks, or vibrations.
- Place the product close enough to the computer for the interface cable to reach it easily. Do not place or store the product or the power cord outdoors, near excessive dirt or dust, water, heat sources, or in locations subject to shocks, vibrations, high temperature or humidity, direct sunlight, strong light sources, or rapid changes in temperature or humidity.
- Do not use with wet hands.
- Place the product and options near an electrical outlet where the adapter can be easily unplugged.
- The power cord should be placed to avoid abrasions, cuts, fraying, crimping, and kinking. Do not place objects on top of the cord and do not allow the power cord to be stepped on or run over. Be particularly careful to keep the cord straight at the end.
- Use only the power cord supplied with the product and do not use the cord with any other equipment. Use of other cords with this product or the use of the supplied power cord with other equipment may result in fire or electric shock.
- Use only the type of power source indicated on the product's label, and always supply power directly from a standard domestic electrical outlet.
- When connecting this product and options to a computer or other device with a cable, ensure the correct orientation of the connectors. Each connector has only one correct orientation. Inserting a connector in the wrong orientation may damage both devices connected by the cable.
- Avoid using outlets on the same circuit as photocopiers or air control systems that regularly switch on and off.
- If you use an extension cord with the product, make sure the total ampere rating of the devices plugged into the extension cord does not exceed the cord's ampere rating. Also, make sure the total ampere rating of all devices plugged into the wall outlet does not exceed the wall outlet's ampere rating.
- Never disassemble, modify, or attempt to repair the product, or product option by yourself except as specifically explained in the product's guides.
- Do not insert objects into any opening as they may touch dangerous voltage points or short out parts. Beware of electrical shock hazards.
- If damage occurs to the plug, replace the cord set or consult a qualified electrician. If there are fuses in the plug, make sure you replace them with fuses of the correct size and rating.

Important Instructions

- ❑ Unplug the product and the power cord, and refer servicing to qualified service personnel under the following conditions: The power cord or plug is damaged; liquid has entered the product; the product or the power cord has been dropped or the case has been damaged; the product or the power cord does not operate normally or exhibits a distinct change in performance. (Do not adjust controls that are not covered by the operating instructions.)
- ❑ Unplug the product and the power cord before cleaning. Clean with a damp cloth only. Do not use liquid or aerosol cleaners.
- ❑ If you are not going to use the product or options for a long period, be sure to unplug the power cord from the electrical outlet.
- ❑ After replacing consumable parts, dispose of them correctly following the rules of your local authority. Do not disassemble them.
- ❑ Because the product is heavy, one person should never attempt to lift or carry it alone. Two people should lift and carry the product.

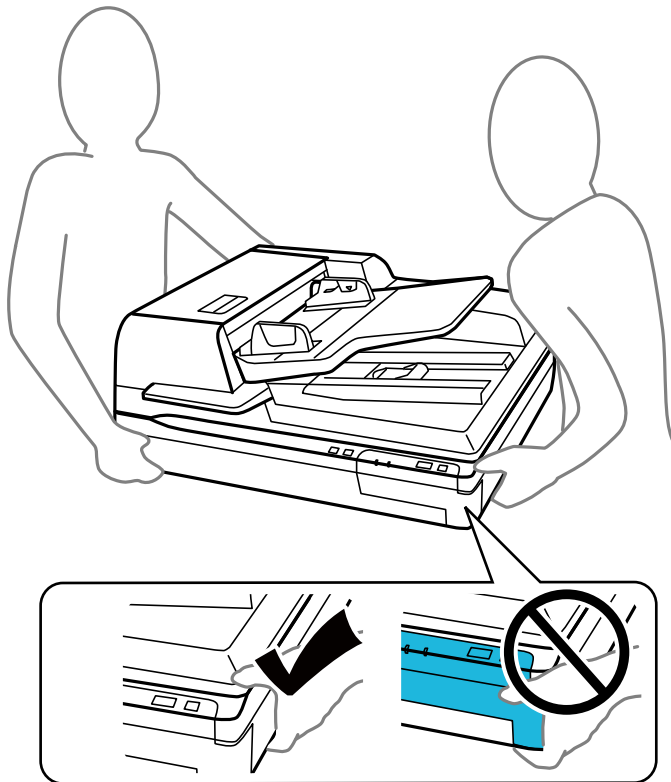

- ❑ Do not place heavy objects on the scanner glass and do not press the glass with too much force.

Restrictions on Copying

Observe the following restrictions to ensure the responsible and legal use of your product.

Copying of the following items is prohibited by law:

- ❑ Bank bills, coins, government-issued marketable securities, government bond securities, and municipal securities
- ❑ Unused postage stamps, pre-stamped postcards, and other official postal items bearing valid postage
- ❑ Government-issued revenue stamps, and securities issued according to legal procedure

Important Instructions

Exercise caution when copying the following items:

- Private marketable securities (stock certificates, negotiable notes, checks, etc.), monthly passes, concession tickets, etc.
- Passports, driver's licenses, warrants of fitness, road passes, food stamps, tickets, etc.

Note:

Copying these items may also be prohibited by law.

Responsible use of copyrighted materials:

Products can be misused by improperly copying copyrighted materials. Unless acting on the advice of a knowledgeable attorney, be responsible and respectful by obtaining the permission of the copyright holder before copying published material.

Restriction on Disassembling and Decompiling

You may not disassemble, decompile or otherwise attempt to derive the source code of any software included with this product.

Scanner Basics

Product Parts

The illustrations used in this guide are of the Automatic Document Feeder (ADF) scanner (shown on the left).

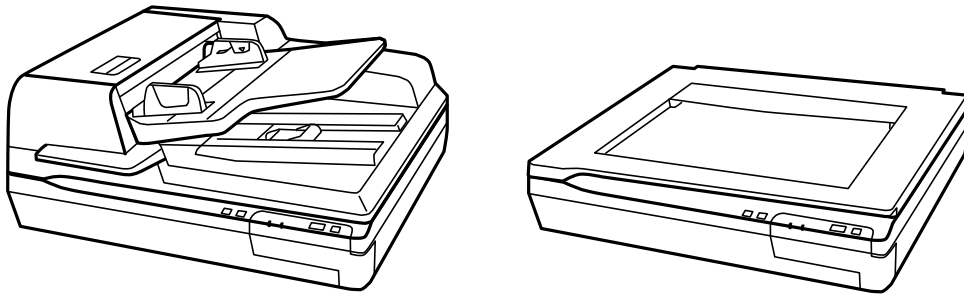

Note:

Use all the items that came with your product.

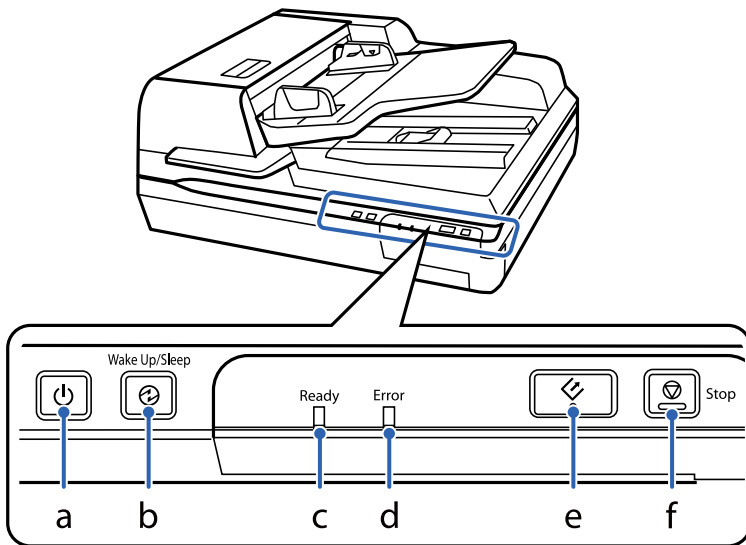

a	⏻ Power button
b	⏻ Wake Up/Sleep button
c	Ready light
d	Error light
e	⏻ Start button
f	⏻ Stop button

Scanner Basics

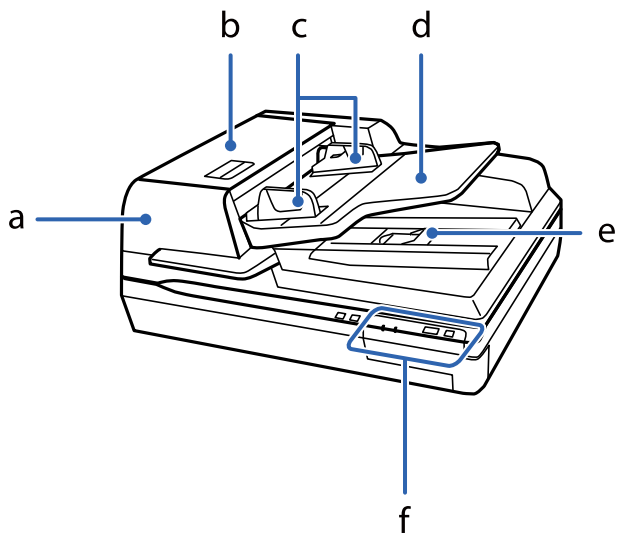

a	Automatic Document Feeder (ADF)
b	ADF cover
c	edge guides
d	ADF input tray
e	ADF output tray
f	Control panel

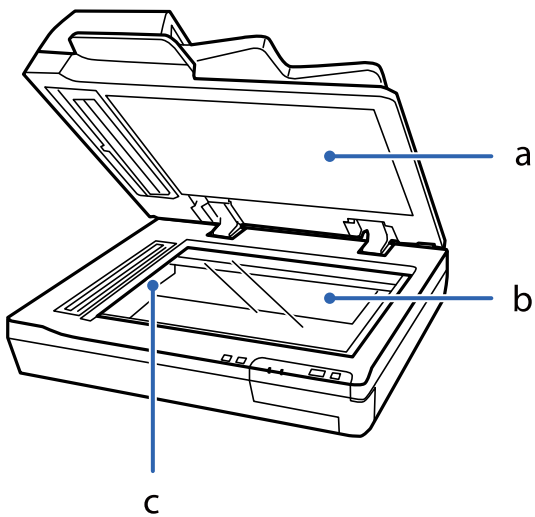

a	Document cover
b	Document glass
c	Carriage (in the document glass)

Note:

Do not remove the document mat located on the underside of the document cover.

Scanner Basics

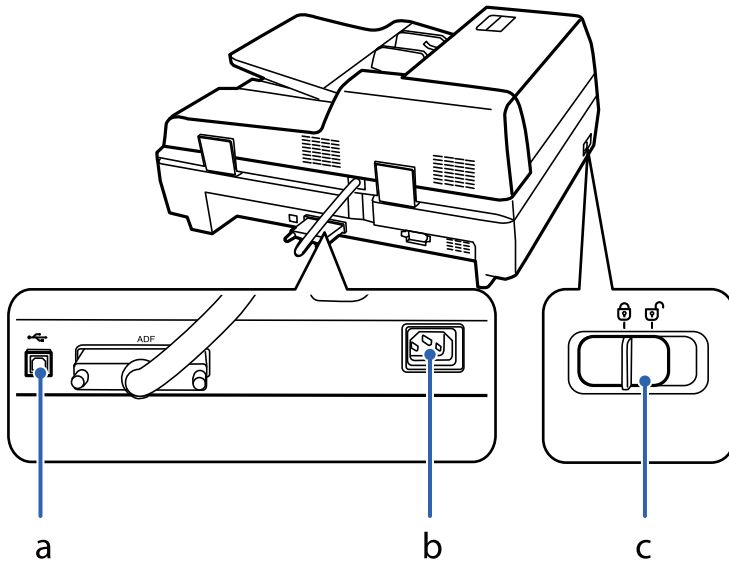

a	USB port
b	AC inlet
c	Transportation lock lever

Buttons

The product has four buttons for scanning operations.

Before using the product buttons, make sure you have installed your scanning software.

Button	Function
⏻ button	Turns the product on if pressed once. Press again to turn the product off.
⏸ button	Changes to Sleep mode. Press again to return the scanner to ready status.
▶ button	Lets you start scan.
⏹ button	Cancels scanning.



You can customize button controls from Document Capture Pro (for Windows) and Document Capture (for Mac OS).

Related Information

- ➔ [“Assigning a Job to the Control Panel \(Windows\)” on page 40](#)
- ➔ [“Assigning a Job to the Control Panel \(Mac OS\)” on page 41](#)

Lights

The Status light indicates whether the product is operating normally.

Light	Indicator Status	Meaning
Ready	On	Ready to scan images.
	Flashing	Initializing or scanning.
Ready and Error	Flashing	Updating firmware.
Error	On	An error has occurred.
	Flashing	Recovering firmware.
	On	The product is in sleep mode. Press the  button to wake the product.
(All)	Off	The product is off.

Related Information

➔ [“Problems Indicated by Status Light” on page 61](#)

Information on Applications

This section introduces the application products available for your scanner. The latest application can be installed at the Epson Web site.

Epson Scan 2

Epson Scan 2 is a driver for controlling your scanner, enabling a variety of scan settings. This also allows you to start either as a standalone application or by using TWAIN-compliant application software.

See the Epson Scan 2 help for details on using the application.

Document Capture Pro / Document Capture

Document Capture Pro is an application that allows you to easily digitize originals such as documents and forms.

You can save scanned images to a specified folder, send by email, and perform copying functions by linking to a printer. You can also split documents by using separation information such as barcodes and automatically process new files. This allows you to streamline the way electronic documents are handled, such as reading large documents and making best use of network capabilities.

Document Capture Pro is for Windows only. For Mac OS, use Document Capture, and for Windows Server, use Document Capture Pro Server.

See the Document Capture Pro help (Windows) or Document Capture (Mac OS) for details on using the application.

Scanner Basics

Note:

Document Capture Pro does not support Windows Vista/Windows XP.

Job:

When performed in order, the following operations are known as a job: **1. Scan > 2. Save > 3. Send.**

By registering a series of operations in advance as a job, you can perform all of the operations by simply selecting the job. By assigning a job to the scanner's control panel, you can start a job from the control panel (Button Assignment).

Separation Function:

You can automatically process complicated sorting or organizing by using a variety of detection methods such as blank pages with/without barcodes which are inserted between the originals, or barcodes on the originals.

You can also sort multiple scanned images as separate files and save each file in specific folders by using these methods or by setting specific pages.

Document Capture Pro Server

Document Capture Pro Server is an application for Windows Server that allows you to manage up to 100 scanners on the network through servers.

By using a web browser, you can register and monitor scanners or register jobs: **1. Scan > 2. Save > 3. Send** and assign them to individual scanners. You can scan by simply selecting a job on a scanner managed by Document Capture Pro Server.

For further information, contact your local Epson office.

Note:

The optional Network Interface Unit is required to use this application.

EPSON Software Updater

EPSON Software Updater is an application that checks for new or updated applications on the internet and installs them.

You can also update the scanner's digital manual.

Note:

Windows Server operating systems are not supported.

Option Items and Consumables Information

Network Interface Panel Codes

You can scan through a network by using Document Capture Pro (Windows only). By registering frequently used scan process settings such as save, sort, transfer, and so on, with a name such as "job", you can reduce the workload and increase efficiency by simply selecting "job" on the control panel. See the manual for more details.

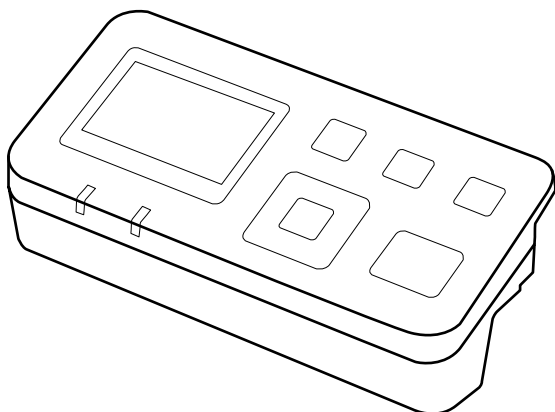

Part name	Codes *2	Specifications
Network Interface Panel *1	B12B808411	Available for 1000BASE-T/100BASE-TX/ 10BASE-T, IPv6, IEEE802.3az

*1 When mounted, you cannot use the scanner or a computer over a USB connection.

*2 Codes may vary by region.

Installing the Network Interface Panel

Epson Scan 2 works with the optional Network Interface Panel together to enable direct control of all of the features of your scanner in a network environment.

You can download the User's Guide for the Network Interface Panel from the following website.

<http://support.epson.net/netscan/>

Roller Assembly Kit Codes

Parts (the pickup roller and a retard roller) should be replaced when the number of scans exceeds the service number. You can check the latest number of scans in Epson Scan 2 Utility.

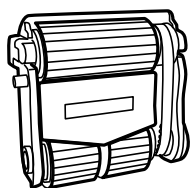

A

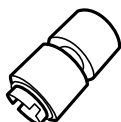

B

Scanner Basics

A: pickup roller, B: retard roller

Part name	Codes ^{*1}	Life cycle
Roller Assembly Kit	B12B813501	100,000 ^{*2}

*1 You cannot use any parts except for the codes specified.

*2 This number was reached by consecutively scanning using Epson test original papers, and is a guide to the replacement cycle. The replacement cycle may vary depending on different paper types, such as paper that generates a lot of paper dust or paper with a rough surface that may shorten the life cycle.

Related Information

➔ [“Replacing the Roller Assembly Kit” on page 52](#)

Cleaning Kit Codes

Use this when cleaning inside the ADF. This kit is composed of cleaning liquid and a cleaning cloth.

Part name	Codes
Cleaning Kit	B12B819291

Specifications of Originals and Placing Originals

Loading Documents in the ADF(For DS-60000/DS-70000)

You can load your original documents in the ADF to scan multiple pages quickly.

Document specifications

Only load documents that meet the following specifications into the product.

Paper size	Measurements
A3	297×420 mm (11.7×16.5 inches)
B4	257×364 mm (10.1×14.3 inches)
A4	210×297 mm (8.3×11.7 inches)
Letter	215.9×279.4 mm (8.5×11 inches)
Legal	215.9×355.6 mm (8.5×14 inches)
B5	182×257 mm (7.2×10.1 inches)
A5	148.5×210 mm (5.8×8.3 inches)
B6	128×182 mm (5.0×7.2 inches)
A6 (Portrait)	105×148.5 mm (4.1×5.8 inches)

Size	Width: 68 to 297 mm (2.7 to 11.7 inches) Length: 120 to 2,540 mm (4.7 to 100 inches)
Weight	Thickness (All sizes): 35 to 128 g/m ² Less than A6: 60 to 190g/m ²
Paper type	Standard paper, High-quality paper, Recycled paper

Note:

Even when the original meets the specifications for originals that can be placed in the ADF, it may not feed from the ADF or the scan quality may decline depending on the paper properties or quality.

Document with the following conditions cannot be loaded.

- Photos
- The ink is wet.
- The document is ripped, wrinkled, or curled.

Specifications of Originals and Placing Originals

- The document has staples, paper clips, or other objects attached to it; these may damage the feeder mechanism.
- The document has folds or multiple pages are stuck together.
- The document has cut-out areas.
- The document is a multi-part form or bound.
- The document has rear carbon coating.
- The document is not paper. For example, if you have loaded a transparent file holder.
- The document is transparent.
- The document has been created using glossy paper.

Loading documents in the ADF

! *Important:*

- Do not feed photographs or valuable original artwork into the ADF. Misfeeding may wrinkle or damage the original. Scan these documents on the document glass instead.*
- Remove any documents from the document glass. Make sure there is no dust on the glass before loading documents in the ADF.*

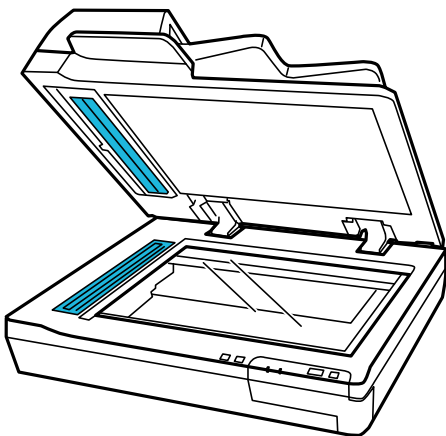

1. Slide the edge guides on the ADF input tray all the way outward.

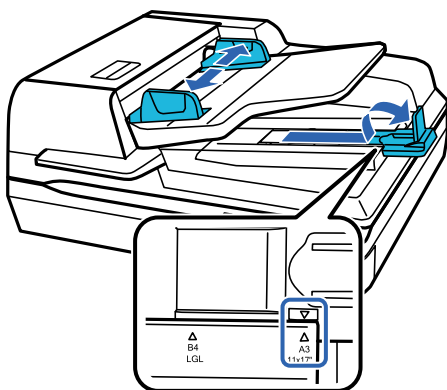

Specifications of Originals and Placing Originals

- Place the first page of your document in the ADF input tray with the printed side facing up and the top edge facing into the feeder. Slide the paper into the feeder until it meets resistance. Then slide the edge guides over to the edge of the paper.

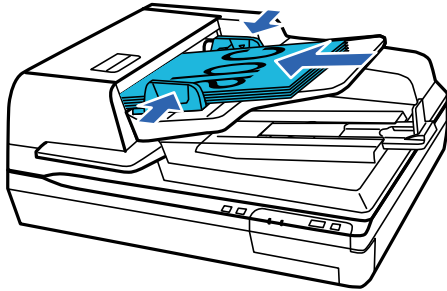

! *Important:*

- Do not load paper above the line just under the ▼ arrow mark on the edge guides.
- When loading a stack of paper, fan the paper to remove any paper powder, tap the edges of the paper on a flat surface to align the sheets, and then load it correctly.
- Do not load additional documents while the current document is being scanned.

Related Information

- ➔ [“Scanning from the Button” on page 24](#)
- ➔ [“Scanning Using Document Capture Pro \(Windows\)” on page 24](#)
- ➔ [“Scanning Using Epson Scan 2” on page 35](#)

Placing Documents on the Document Glass

! *Important:*

Do not place heavy objects on the document glass and do not press the glass with too much force.

Note:

The illustrations used in this guide are of the ADF scanner.

Specifications of Originals and Placing Originals

1. Open the document cover.

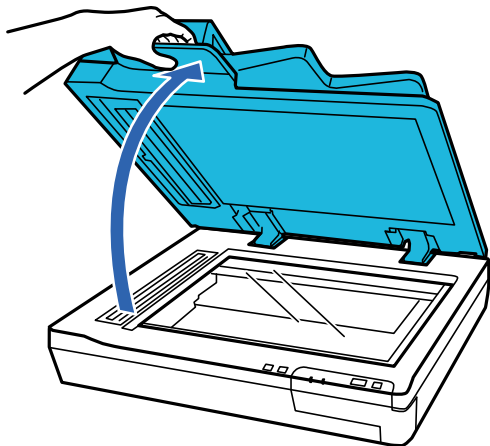

2. Place your document face-down on the document glass. Make sure the top of the document is against the left edge and centered on the arrow mark.

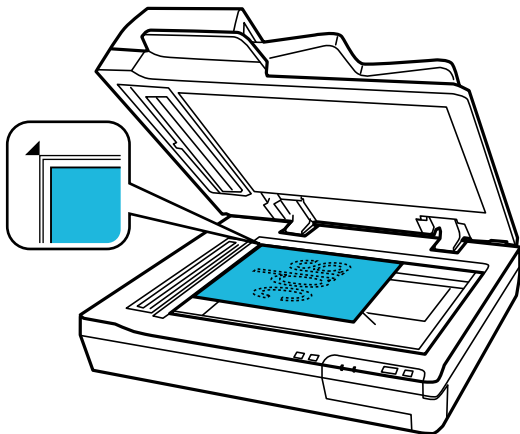

3. Close the document cover gently so that your original does not move.

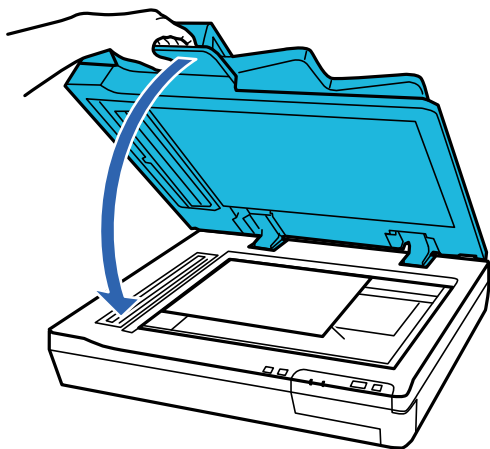

Important:

Make sure you use the handle when opening or closing the ADF.

Specifications of Originals and Placing Originals

Note:

- ❑ Do not leave photos on the document glass for an extended period of time as they may stick to the glass.
- ❑ Always keep the document glass clean.
- ❑ You can place documents up to 15 mm (0.6 inch) thick.

Related Information

- ➔ [“Scanning from the Button” on page 24](#)
- ➔ [“Scanning Using Document Capture Pro \(Windows\)” on page 24](#)
- ➔ [“Scanning Using Epson Scan 2” on page 35](#)

Placing Thick Documents on the Document Glass

! Important:

Do not place heavy objects on the document glass and do not press the glass with too much force.

Note:

The illustrations used in this guide are of the ADF scanner.

Follow these steps to scan a large or thick document on the document glass:

1. Place a large or thick document face-down on the document glass. Make sure the top of the document is against the left edge and centered on the arrow mark.

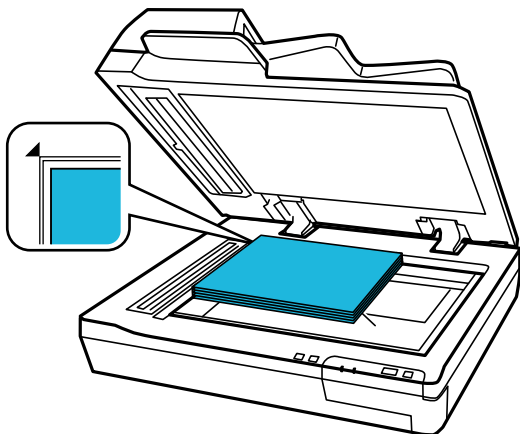

Specifications of Originals and Placing Originals

2. Close the document cover and hold it down firmly as you scan.

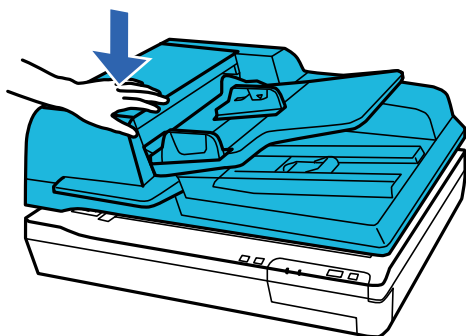

Note:

- When scanning without the document cover, gently press down on your document to flatten it.
- If your document is very thick or curled at the edges, cover the edges with paper to block external light as you scan.
- You can place documents up to 15 mm (0.6 inch) thick.

Related Information

- ➔ [“Scanning from the Button” on page 24](#)
- ➔ [“Scanning Using Document Capture Pro \(Windows\)” on page 24](#)
- ➔ [“Scanning Using Epson Scan 2” on page 35](#)

Basic Scanning

Scanning from the Button

1. Place the originals.
2. Press the  button.

The scanned image is saved to the folder you specified.

Related Information

- ➔ [“Specifications of Originals and Placing Originals” on page 18](#)
- ➔ [“Assigning a Job to the Control Panel \(Windows\)” on page 40](#)
- ➔ [“Assigning a Job to the Control Panel \(Mac OS\)” on page 41](#)

Scanning Using Document Capture Pro (Windows)

This application allows you to perform various tasks such as saving the image to your computer, sending it by email, printing, and uploading to a server or a cloud service. You can also use a variety of methods to sort the documents into separate files, such as detecting barcodes or characters on the pages. You can also register scanning settings for a job to simplify scanning operations.

See the Document Capture Pro help for details on the features.

Note:

Document Capture Pro does not support Windows Vista, Windows XP, and Windows Server.

1. Start Document Capture Pro.
 - Windows 10
Click the start button, and then select **Epson Software > Document Capture Pro**.
 - Windows 8.1/Windows 8
Enter the application name in the search charm, and then select the displayed icon.
 - Windows 7
Click the start button, and then select **All Programs > Epson Software > Document Capture Pro**.

Note:

You may need to select the scanner you want to use from the scanners list.

Basic Scanning

2. Click **Job Settings**.

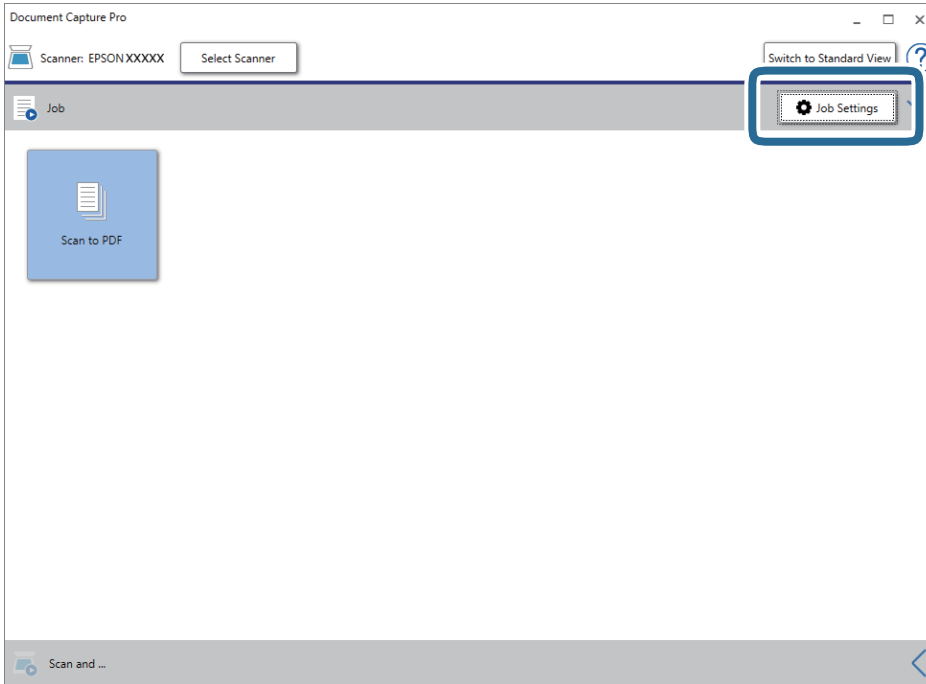

The job list screen is displayed.

Note:

A preset job is available that allows you to save scanned images as a PDF. When using this job, skip this procedure and go to procedure 10.

3. Click **New Job**.

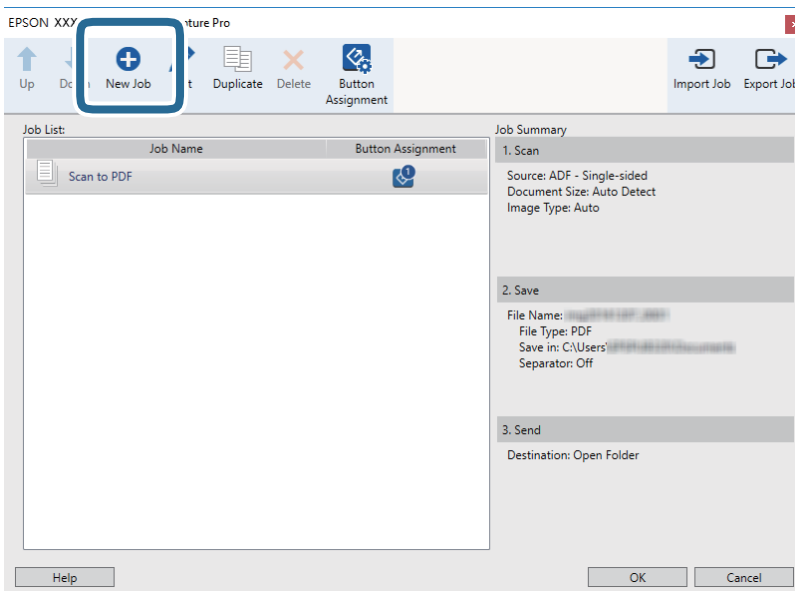

The **Job Settings** screen is displayed.

Basic Scanning

4. Set the Job Name.

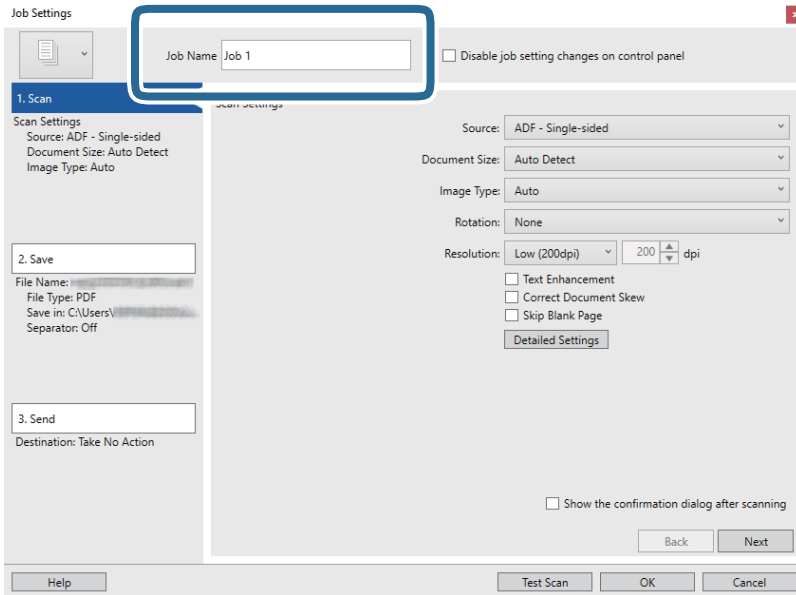

5. Make scanning settings on the 1. Scan tab.

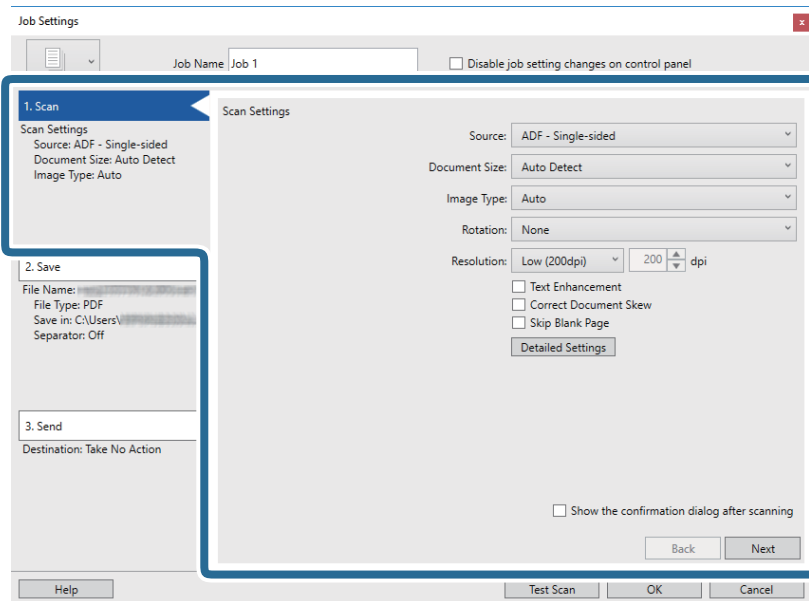

- Source:** Select the source where the original is placed. Select double-sided to scan both sides of the originals.
- Document Size:** Select the size of the original you placed.
- Image Type:** Select the color you want to use to save the scanned image.
- Rotation:** Select the rotation angle depending on the original you want to scan.
- Resolution:** Select the resolution.

Basic Scanning

Note:

You can also adjust the image using following items.

- Text Enhancement:** Select to make blurred letters in the original clear and sharp.
- Correct Document Skew:** Select to correct the slant of the original.
- Skip Blank Page:** Select to skip blank pages if there are any in the originals.
- Detailed Settings** button: Select to use Epson Scan 2 features to adjust scanned images.

6. Click **2. Save**, and then make the save settings.

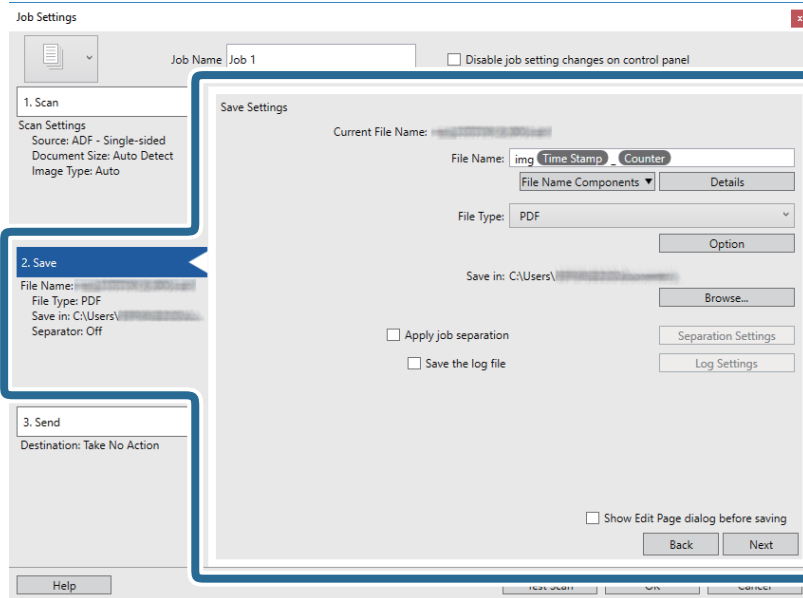

- File Name:** Set the file name you want to use when saving the scanned image. Click **Details** to change the settings for component items for the file name, and then click **File Name Components** to add the items.
- File Type:** Select the save format from the list. Click **Option** to make detailed settings for the file.
- Browse:** Select the save folder for the scanned image.
- Apply job separation:** Select to make separation settings.

Basic Scanning

- Click **3. Send**, and then select the **Destination**.

Destination setting items are displayed according to the destination you selected. Make detailed settings as necessary. Click **Help** for details on each item.

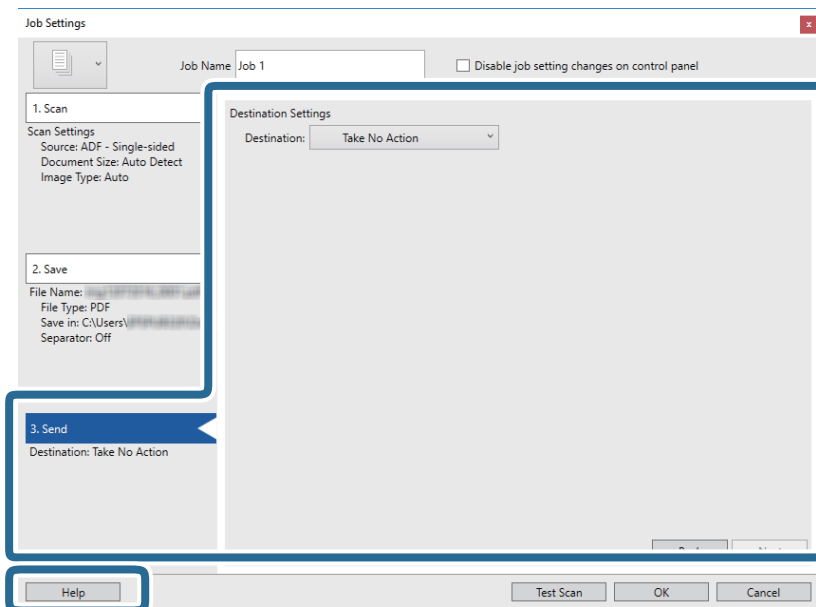

Note:

- If you want to upload to a cloud service, you need to set up your account with the cloud service in advance.
- If you want to use Evernote as the destination, download the Evernote application from the Evernote Corporation Website and install it before using this feature.

- Click **OK** to close the **Job Settings** screen.
- Click **OK** to close the job list screen.
- Place the original.

Basic Scanning

11. Click the job icon.

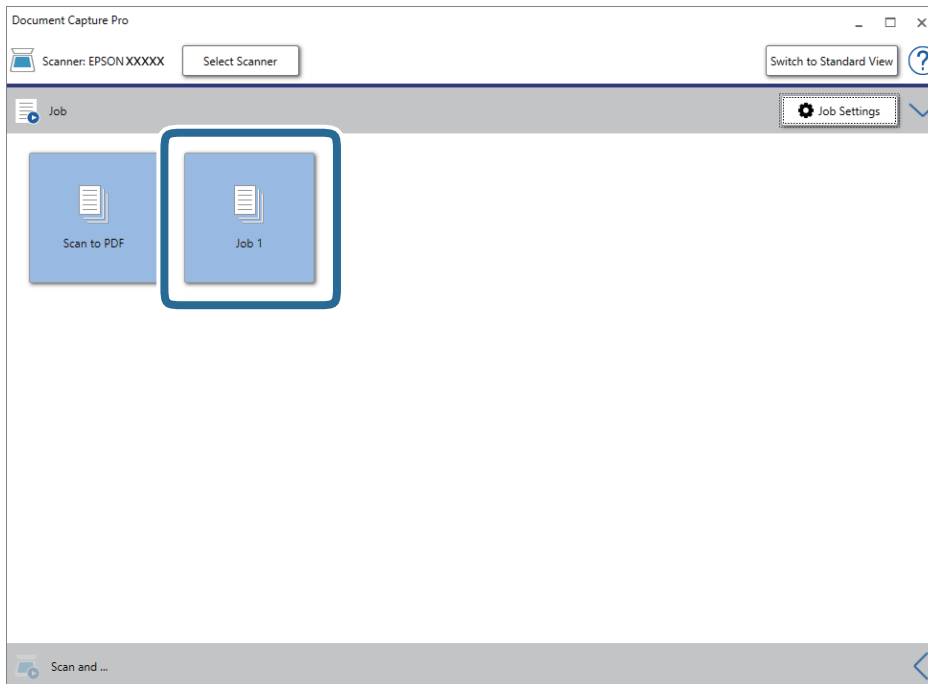

The selected job is performed.

12. Follow the on-screen instructions.

The scanned image is saved using the settings you made for the job.

Note:

You can scan the originals and send the scanned image without using the job. Click  on the **Scan and** bar, and then click the destination to which you want to send the scanned image.

Related Information

- ➔ [“Document Capture Pro / Document Capture” on page 14](#)
- ➔ [“Specifications of Originals and Placing Originals” on page 18](#)

Scanning Using Document Capture (Mac OS)

This application allows you to perform various tasks such as saving the image to your computer, sending it by email, printing, and uploading to a server or a cloud service. You can also register scanning settings for a job to simplify scanning operations.

See the Document Capture help for details on the features.

Note:

Do not use the Fast User Switching function while using your scanner.

Basic Scanning

1. Start Document Capture.

Select **Finder > Go > Applications > Epson Software > Document Capture**.

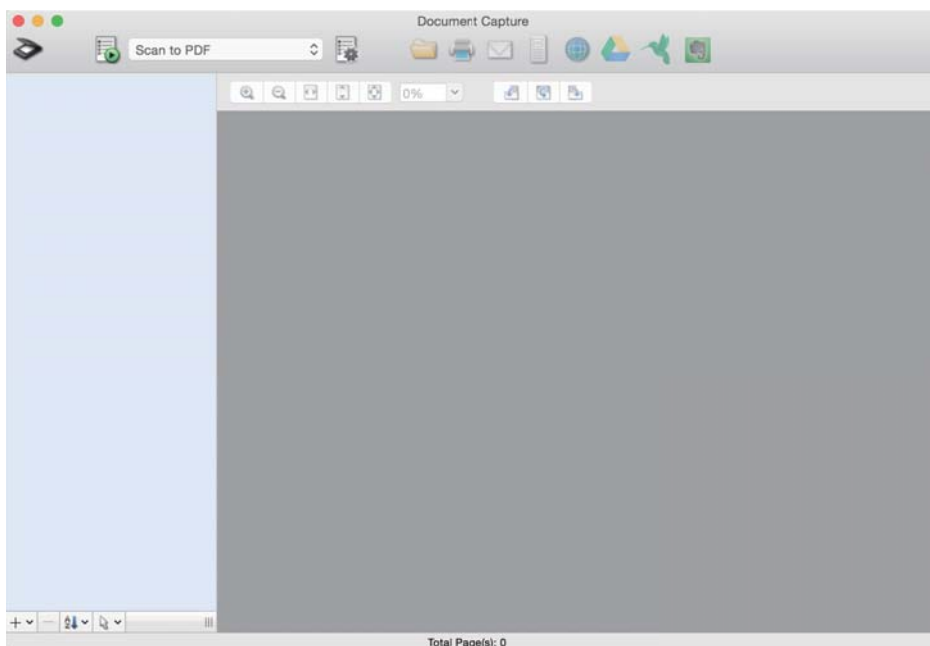

Note:

You may need to select the scanner you want to use from the scanners list.

2. Click .

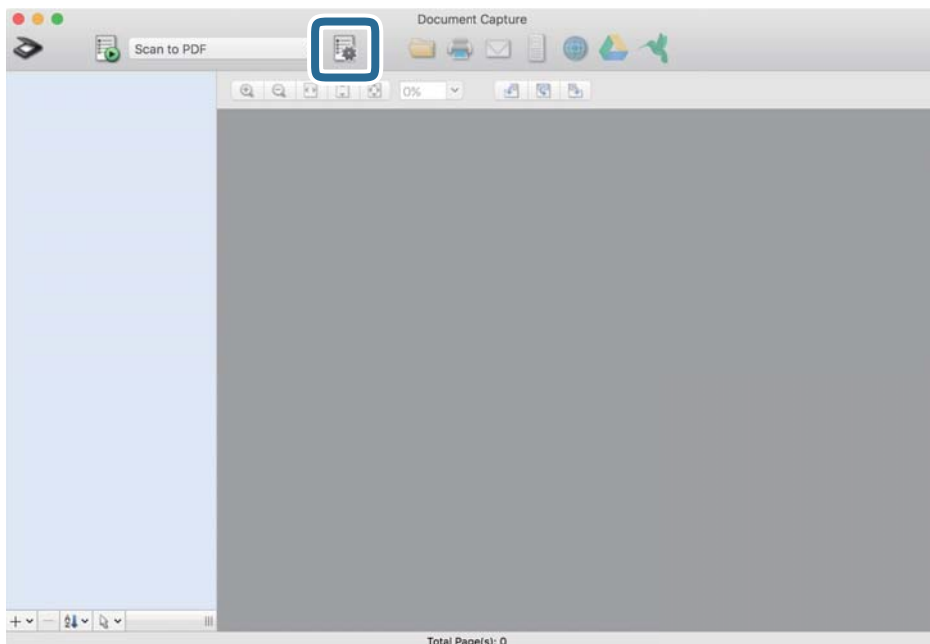

The **Job List** screen is displayed.

Note:

A preset job is available that allows you to save scanned images as a PDF. When using this job, skip this procedure and go to procedure 10.

Basic Scanning

3. Click the + icon.

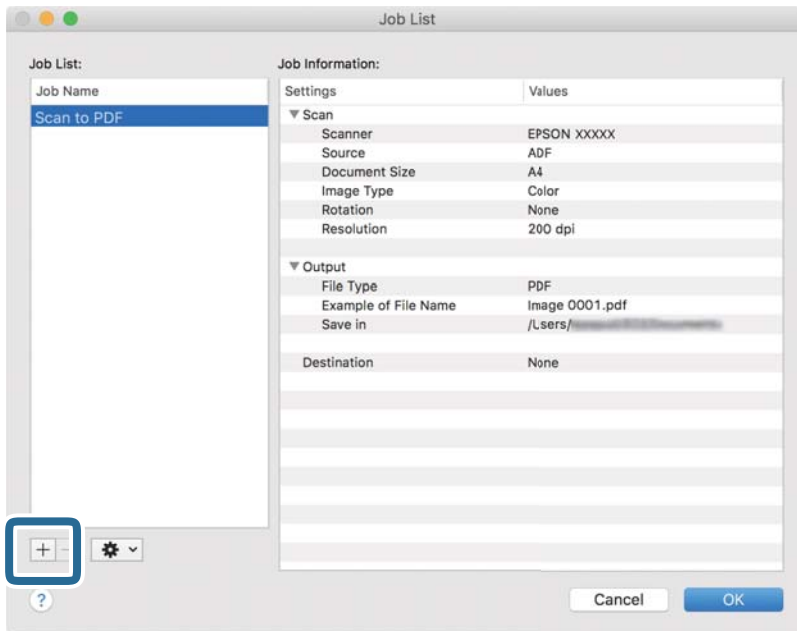

The job setting screen is displayed.

4. Set the **Job Name**.

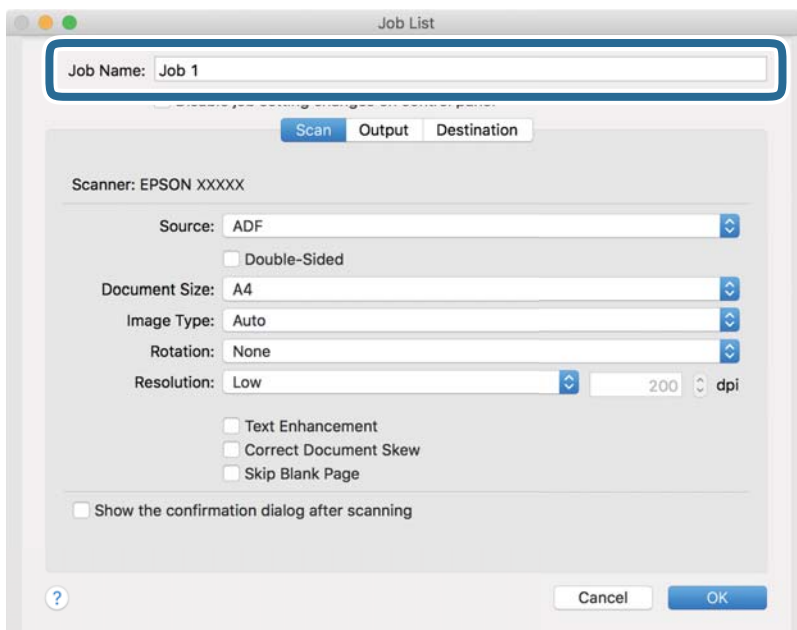

Basic Scanning

5. Make scanning settings on the **Scan** tab.

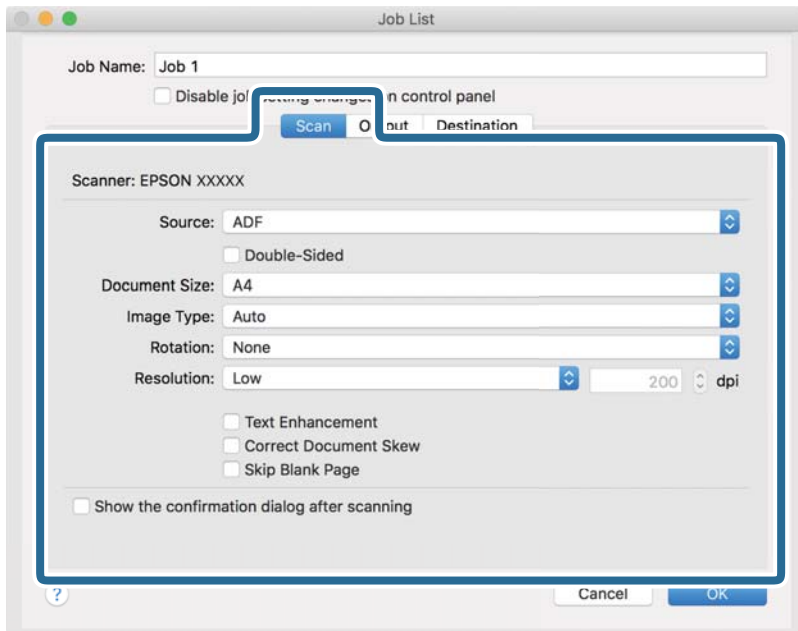

- Source:** Select the source where the original is placed. Select double-sided to scan both sides of the originals.
- Document Size:** Select the size of the original you placed.
- Image Type:** Select the color you want to use to save the scanned image.
- Rotation:** Select the rotation angle depending on the original you want to scan.
- Resolution:** Select the resolution.

Note:

You can also adjust the image using following items.

- Text Enhancement:** Select to make blurred letters in the original clear and sharp.
- Correct Document Skew:** Select to correct the slant of the original.
- Skip Blank Page:** Select to skip blank pages if there are any in the originals.

Basic Scanning

- Click **Output**, and then make the output settings.

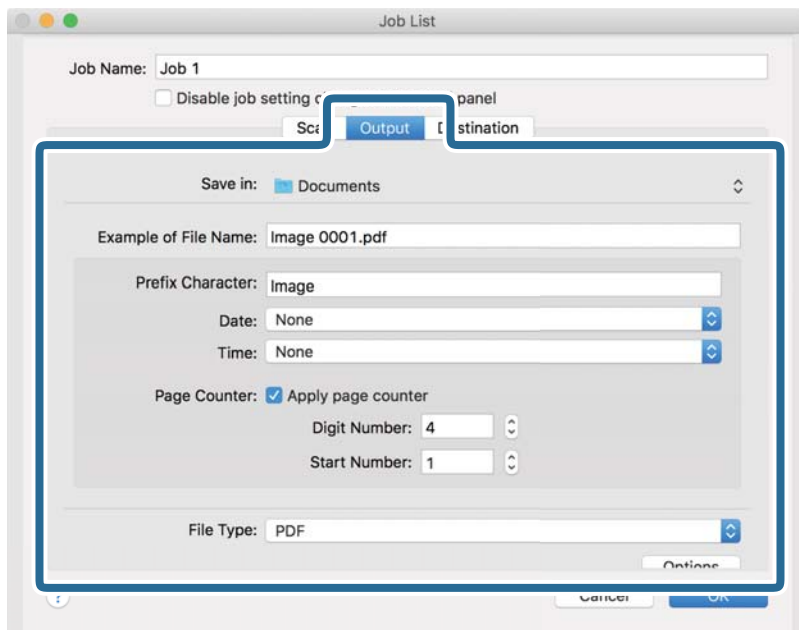

- Save in:** Select the save folder for the scanned image.
- Example of File Name:** Display an example of the file name for the current settings.
- Prefix Character:** Set a prefix for the file name.
- Date:** Add the date to the file name.
- Time:** Add the time to the file name.
- Page Counter:** Add the page counter to the file name.
- File Type:** Select the save format from the list. Click **Options** to make detailed settings for the file.

Basic Scanning

7. Click **Destination**, and then select the **Destination**.

Destination setting items are displayed according to the destination you selected. Make detailed settings as necessary. Click the ? (Help) icon for details on each item.

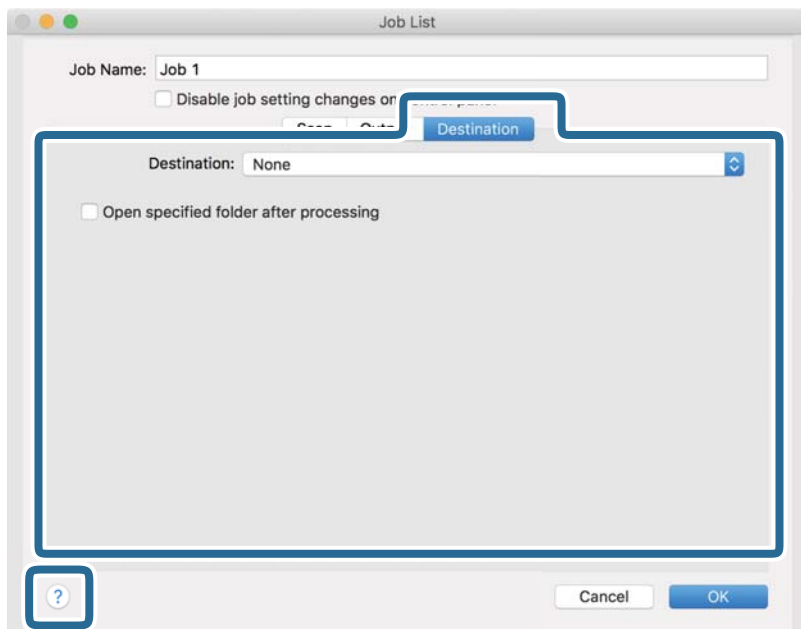

Note:

- If you want to upload to a cloud service, you need to set up your account with the cloud service in advance.
- If you want to use Evernote as the destination, download the Evernote application from the Evernote Corporation Website and install it before using this feature.

8. Click **OK** to close the job settings screen.
9. Click **OK** to close the **Job List** screen.
10. Place the original.

Basic Scanning

11. Select the job from the pull down list, and then click the  icon.

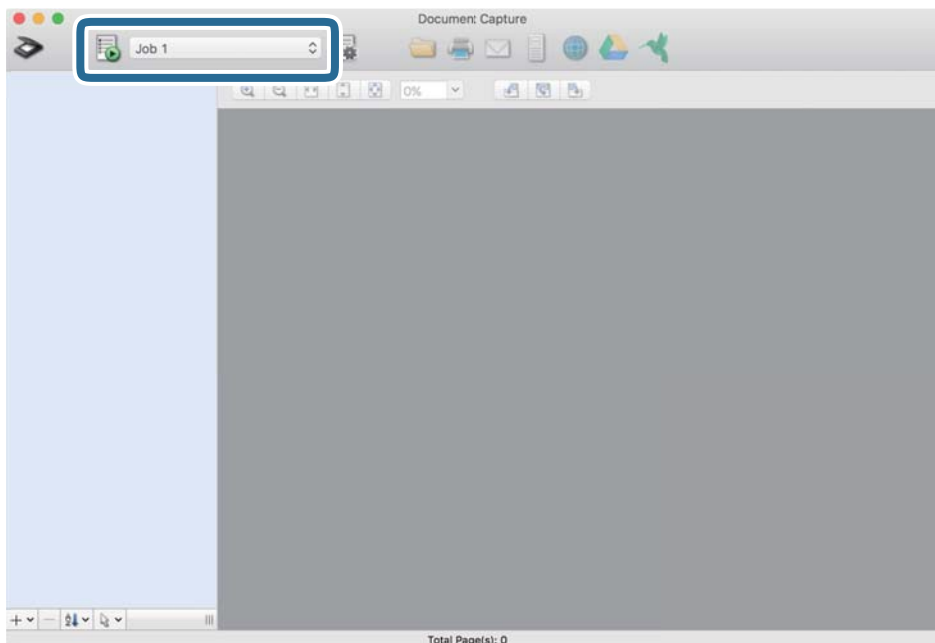

The selected job is performed.

12. Follow the on-screen instructions.

The scanned image is saved using the settings you made for the job.

Note:

You can scan the originals and send the scanned image without using the job. Click  and make scanning settings, and then click **Preview Scan**. Next, click the destination to which you want to send the scanned image.

Related Information

- ➔ [“Document Capture Pro / Document Capture” on page 14](#)
- ➔ [“Specifications of Originals and Placing Originals” on page 18](#)

Scanning Using Epson Scan 2

You can scan the originals using detailed settings that are suitable for text documents.

1. Place the original.

Note:

If you want to scan multiple originals, place them into the ADF.

2. Start Epson Scan 2.

- Windows 10/Windows Server 2019/Windows Server 2016

Click the start button, and then select **EPSON > Epson Scan 2**.

- Windows 8.1/Windows 8/Windows Server 2012 R2/Windows Server 2012

Enter the application name in the search charm, and then select the displayed icon.

Basic Scanning

- ❑ Windows 7/Windows Vista/Windows XP/Windows Server 2008 R2/Windows Server 2008/Windows Server 2003 R2/Windows Server 2003

Click the start button, and then select **All Programs** or **Programs > EPSON > Epson Scan 2 > Epson Scan 2**.

- ❑ Mac OS

Select **Go > Applications > Epson Software > Epson Scan 2**.

3. Make the following settings on the **Main Settings** tab.



- ❑ **Document Source:** Select the source where the original is placed.
- ❑ **Scanning Side:** Select the side of the original you want to scan when scanning from ADF.
- ❑ **Document Size:** Select the size of the original you placed.
- ❑  (Original orientation) buttons: Select the set orientation of the original you placed. Depending on the size of the original, this item may be set automatically and cannot be changed.
- ❑ **Image Type:** Select the color for saving the scanned image.
- ❑ **Resolution:** Select the resolution.

Basic Scanning

Note:

On the **Main Settings** tab, you can also make the following settings.

- Stitch Images:** Select to stitch the images on the front and rear when scanning both sides of the original.
- Rotate:** Select to rotate the original clockwise and scan it.
- Correct Document Skew:** Select to correct the slant of the original.
- Add or edit pages after scanning:** Select to add different originals or edit (rotate, move, and delete) the scanned pages after scanning.
- Skip Blank Pages:** Select to skip blank pages if there are any in the originals.
- Detect Double Feed:** Select to display a warning when multiple originals are fed at the same time.

4. Make other scan settings if necessary.

- You can preview the scanned image by clicking the **Preview** button. The preview window opens, and the previewed image is displayed.
When you preview using the ADF, the original is ejected from the ADF. Place the ejected original again.
- On the **Advanced Settings** tab, you can make detailed image adjustment settings that are suitable for text documents, such as the following.
 - Remove Background:** Remove the background of the originals.
 - Text Enhancement:** You can make blurred letters in the original clear and sharp.
 - Auto Area Segmentation:** You can make letters clear and images smooth when performing black and white scanning for a document that contains images.
 - Color Enhance:** You can enhance the color specified for the scanned image, and then save it in grayscale or black and white.
 - Threshold:** You can adjust the border for monochrome binary (black and white).
 - Unsharp Mask:** You can enhance and sharpen the outlines of the image.
 - Descreening:** You can remove moiré patterns (web-like shadows) that appear when scanning printed papers such as a magazine.
 - Edge Fill:** You can remove the shadow created around the scanned image.
 - Dual Image Output (Windows Only):** You can scan once and save two images with different output settings at the same time.

Note:

Some items may not be available depending on other settings you made.

Basic Scanning

- Set the file saving settings.

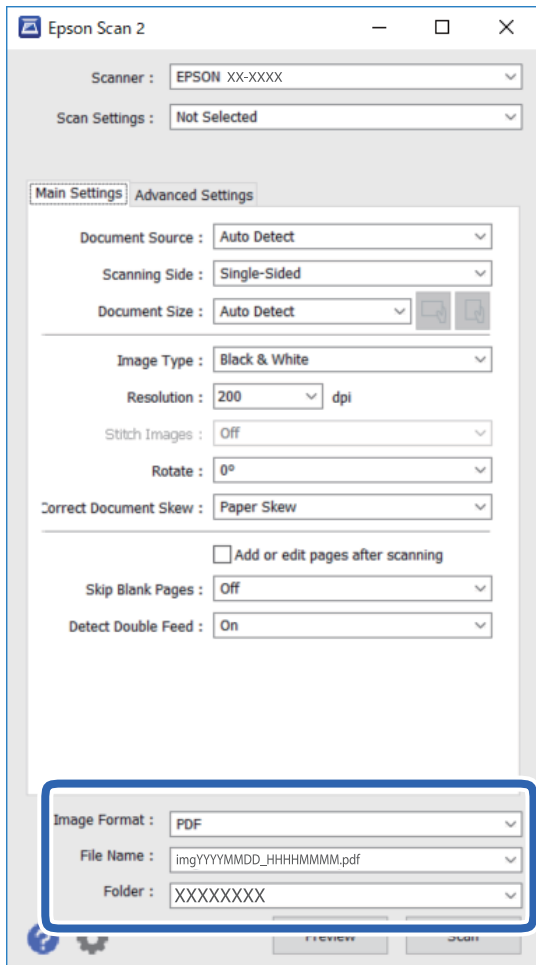

- ❑ **Image Format:** Select the save format from the list.
You can make detailed settings for each save format except BITMAP and PNG. After selecting the save format, select **Options** from the list.
- ❑ **File Name:** Check the save file name displayed.
You can change settings for file name by selecting **Settings** from the list.
- ❑ **Folder:** Select the save folder for the scanned image from the list.
You can select other folder or create a new folder by selecting **Select** from the list.

- Click **Scan**.

The scanned image is saved to the folder you specified.

Related Information

- ➔ [“Specifications of Originals and Placing Originals” on page 18](#)

Advanced Scanning

Setting a Job (Scan, Save, and Send)

When performed in order, the following operations are known as a job: **1. Scan > 2. Save > 3. Send.**

By registering a series of operations in advance as a job using Document Capture Pro (Windows), Document Capture (Mac OS) or Document Capture Pro Server (Windows Server), you can perform all of the operations by simply selecting the job.

Note:

Document Capture Pro does not support Windows Vista, Windows XP, and Windows Server.

Creating and Registering a Job (Windows)

Explains how to set a job in Document Capture Pro. See the Document Capture Pro help for details on the features.

1. Start Document Capture Pro.
2. Click **Job Settings** on the top screen.
The **Job List** is displayed.
3. Click **New Job**.
The **Job Settings** screen is displayed.
4. Make job settings on the **Job Settings** screen.
 - Job Name:** Enter the name of the job you want to register.
 - 1. Scan (Scan Settings):** Make scan settings such as the size of the originals or the resolution.
 - 2. Save (Save Settings):** Set the saving destination, the saving format, the naming rules of the files, and so on. You can sort and save continued scanned images automatically by using detection methods such as blank pages inserted between the originals or barcodes on the originals.
 - 3. Send (Destination Settings):** Select the destination of the scanned images. You can send them by email or forward them to an FTP server or Web server.
5. Click **OK** to return to the **Job List** screen.
The created job is registered in the **Job List**.
6. Click **OK** to return to the top screen.

Related Information

- ➔ [“Document Capture Pro / Document Capture” on page 14](#)
- ➔ [“Scanning from the Button” on page 24](#)

Creating and Registering a Job (Mac OS)

Explains how to set a job in Document Capture. See the Document Capture help for details on the features.

1. Start Document Capture.
2. Click the  icon on the main window.
The **Job List** window is displayed.
3. Click the + icon.
The **Job Settings** window is displayed.
4. Make the job settings on the **Job Settings** window.
 - Job Name:** Enter the name of the job you want to register.
 - Scan:** Make scan settings such as the size of the originals or the resolution.
 - Output:** Set the saving destination, the saving format, the naming rules of the files, and so on.
 - Destination:** Select the destination of the scanned images. You can send them by email or forward them to an FTP server or Web server.
5. Click **OK** to return to the **Job List** window.
The created job is registered in the **Job List**.
6. Click **OK** to return to the main window.

Related Information

- ➔ [“Document Capture Pro / Document Capture” on page 14](#)
- ➔ [“Scanning from the Button” on page 24](#)

Enabling a Job to Run from the Control Panel (Button Assignment)

By assigning a job to the scanner's control panel in advance using Document Capture Pro (Windows), Document Capture (Mac OS) or Document Capture Pro Server (Windows Server), you can run jobs from the control panel.

Note:

Document Capture Pro does not support Windows Vista, Windows XP, and Windows Server.

Assigning a Job to the Control Panel (Windows)

Explains how to assign a job to the scanner's control panel in Document Capture Pro. See the Document Capture Pro help for details on the features.

1. Start Document Capture Pro.

Advanced Scanning



2. Click **Job Settings** on the top screen
The **Job List** is displayed.
3. Click **Button Assignment**.
The **Button Assignment** screen is displayed.
4. Select the job you want to run on the control panel from the pull-down menu.
5. Click **OK** to return to the **Job List** screen.
The job is assigned to the scanner's control panel.
6. Click **OK** to return to the top screen.

Related Information

➔ [“Scanning from the Button” on page 24](#)

Assigning a Job to the Control Panel (Mac OS)

Explains how to assign a job to the scanner's control panel in Document Capture. See the Document Capture help for details on the features.

1. Start Document Capture.
2. Click the  icon on the main window.
The **Job List** window is displayed.
3. Click the  icon and select **Event Settings**.
4. Select the job you want to run on the control panel from the pull-down menu.
5. Click **OK** to return to the **Job List** window.
The job is assigned to the scanner's control panel.
6. Click **OK** to return to the main window.

Related Information

➔ [“Scanning from the Button” on page 24](#)

Separation Feature (for Windows Only)

You can use the separation feature when using Document Capture Pro.

By entering barcode or text information, you can automatically identify and separate or sort complicated documents using the barcode information on the document, or by inserting blank pages in between pages in a document.

Advanced Scanning

When scanning multiple documents and using separator information or a specified number of pages to separate the document into multiple files, each separated file can be saved to a specific folder.

For example, you can make separation settings such as the following.

Note:

Document Capture Pro does not support Windows Vista, Windows XP, and Windows Server.

Split the data every three pages and save as multi-page PDFs (fixed pages)

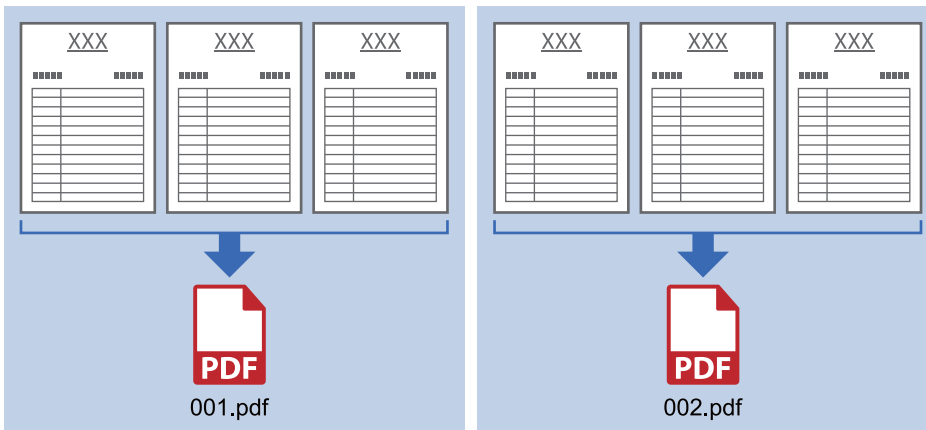

Enter barcode information and save as multi-page PDFs



Enter barcode information and separate into folders

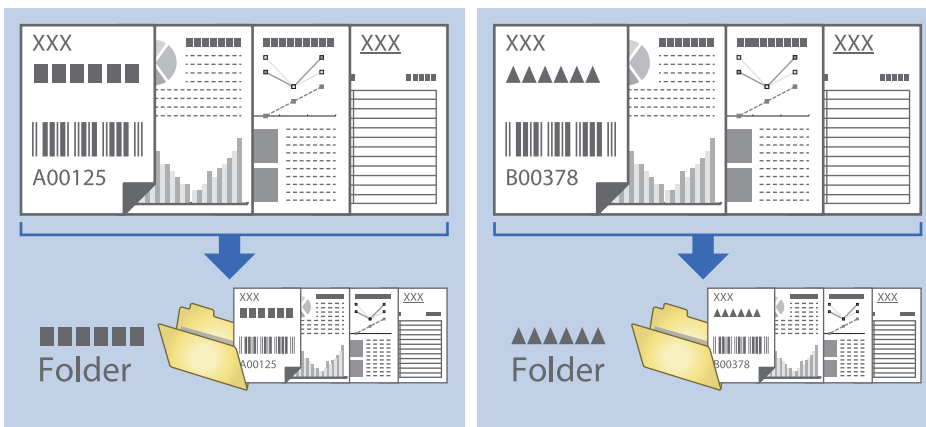

Advanced Scanning

Sorting and Saving Scanned Images into a Separate Folder

You can sort scanned images automatically and save them to a separate folder using Document Capture Pro.

To sort scanned images, you can use a variety of detection methods such as blank pages inserted between the originals or barcodes on the originals.

1. Place the originals including indicators, such as blank pages, between the pages where you want to separate the scanned images.
2. Start Document Capture Pro.
3. Click **Job Settings**.

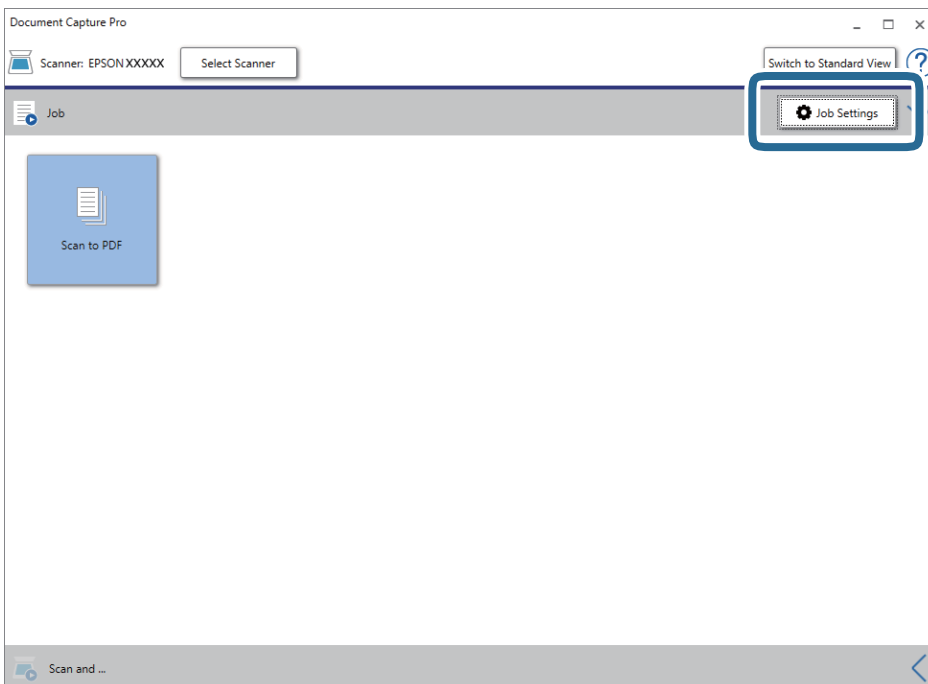

4. Click **New Job**.

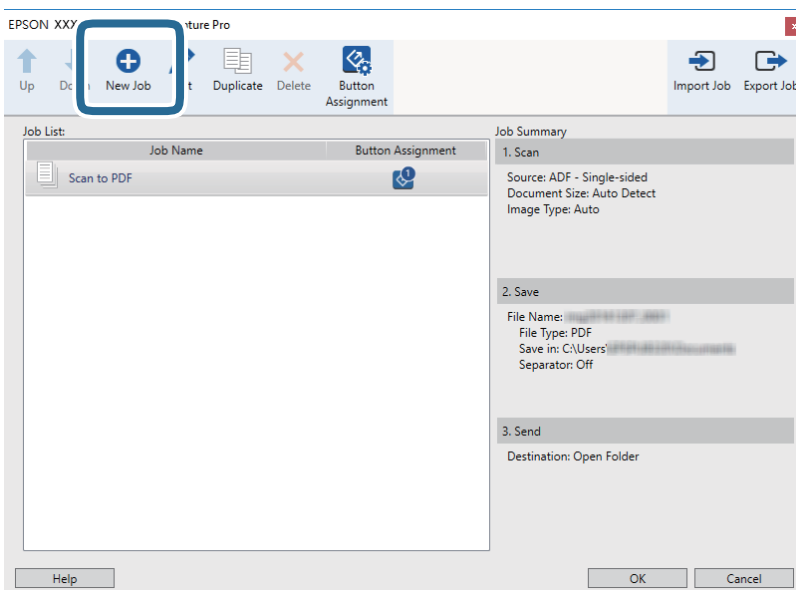

Advanced Scanning

5. Set the Job Name.

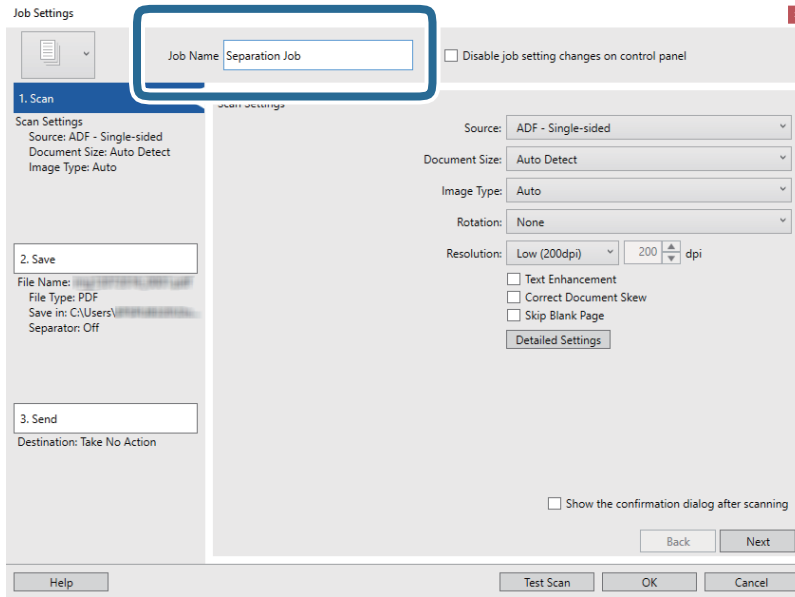

6. Make scanning settings on the 1. Scan tab.

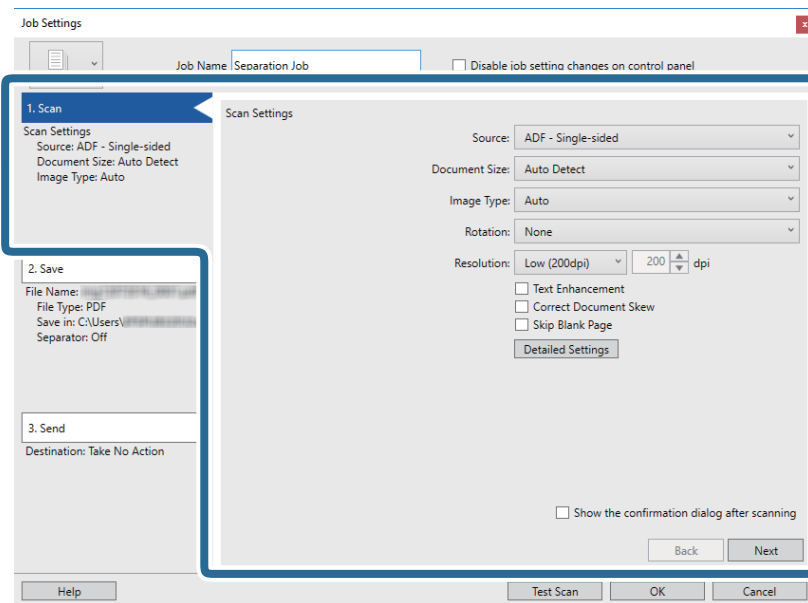

Advanced Scanning

- Click **2. Save**, make the save settings, and then select **Apply job separation**.

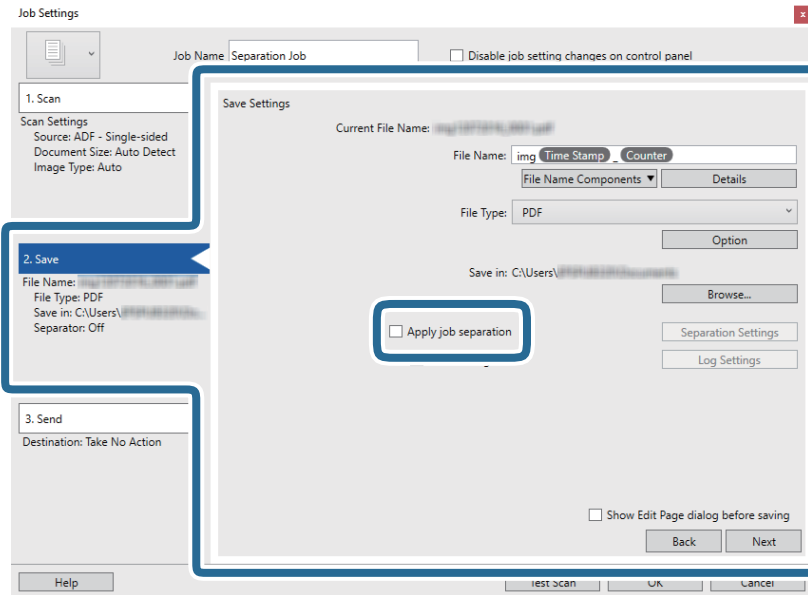

- Click **Separation Settings**.

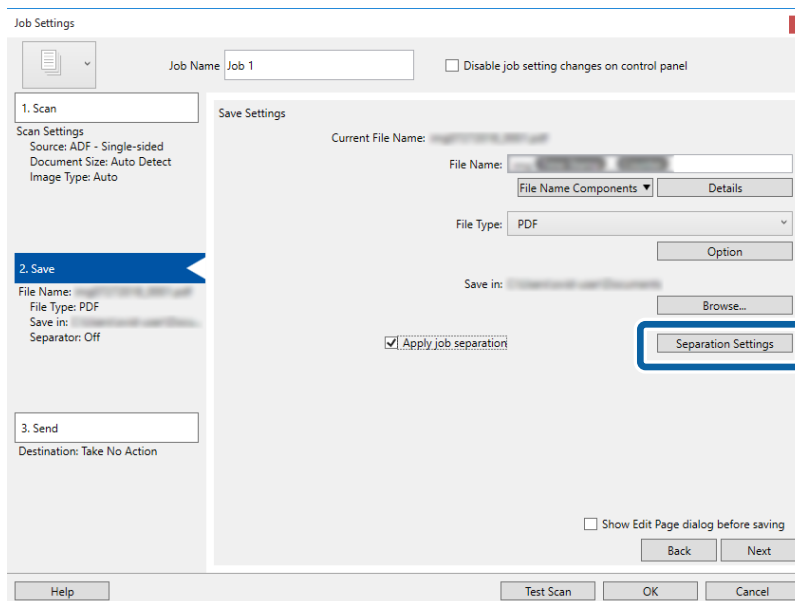

Advanced Scanning

9. Select **Separator** on the **Job Separation Settings** screen.

Job Separation Settings

Separator: Fixed Page

Page: 3

Count blank pages in total

Create Folder

Folder Name: folder Counter

Folder Name Components

Current Folder Name:

Add job separation

Separator: Barcode

Settings

Help OK Cancel

- Fixed Page:** Select to separate by each specified page and split into files.
 - Blank Page:** Select to separate by detecting blank pages.
 - Barcode:** Select to separate by detecting barcodes.
 - OCR:** Select to detect characters using OCR (Optical Character Recognition) and separate accordingly.
 - Form:** Select to separate by detecting the type of **Form**.
 - File Size:** Select to separate by detecting the file size of scanned images.
 - Patch Code:** Select to separate by detecting the **Patch Code**.
10. Set detailed settings for separation, and then click **OK**.

Settings for separation vary depending on the **Separator** you selected. For details on the settings for separation, click **Help** on the window and see the help for Document Capture Pro.

Advanced Scanning

- Click **3. Send**, and then select the **Destination**.

Destination setting items are displayed according to the destination you selected. Make detailed settings as necessary. Click **Help** for details on each item.

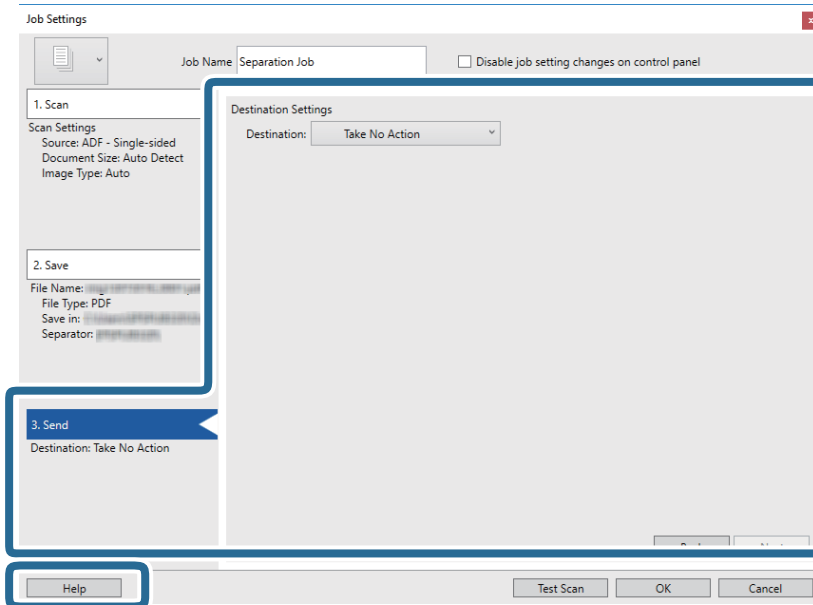

- Click **OK** to close the **Job Settings** screen.

- Click **OK** to close the job list screen.

The separation job is created.

- Click the job icon.

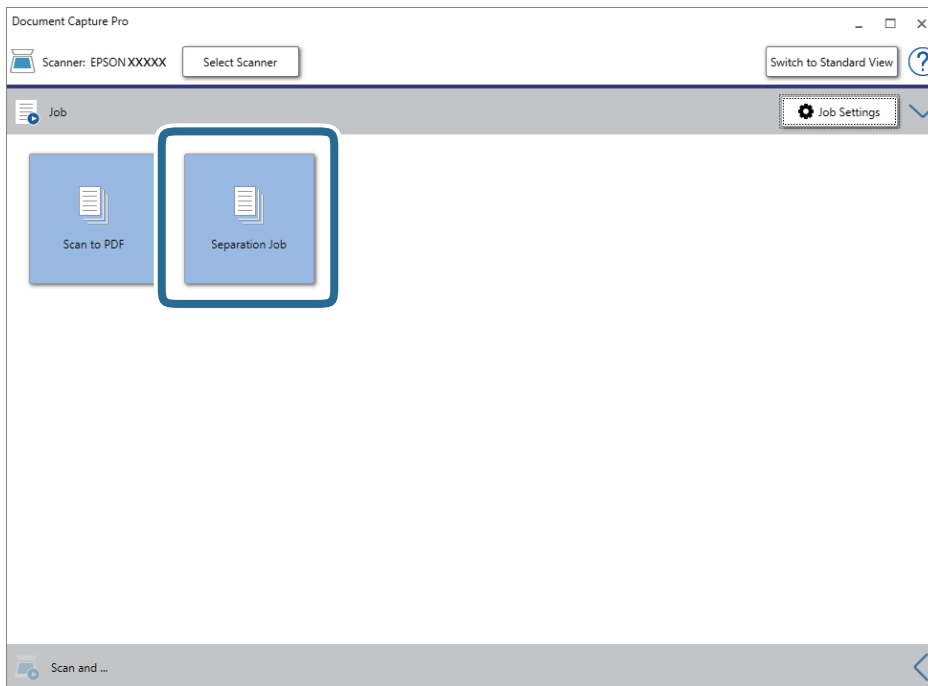

The separation job is performed.

Advanced Scanning

15. Follow the on-screen instructions.

The scanned image is separated and saved using the settings you made for the job.

Saving as an Office Format File (for Windows Only)

You can save the scanned image as a Microsoft® Office format file using Document Capture Pro.

Note:

- ❑ *Document Capture Pro does not support Windows Vista, Windows XP, and Windows Server.*
- ❑ *This feature is only available when the EPSON Scan OCR component is installed.*

1. Place the original.
2. Start Document Capture Pro.
3. Click  on the **Scan and** bar to display the destination screen.

If you have already displayed the destination screen, skip this procedure.

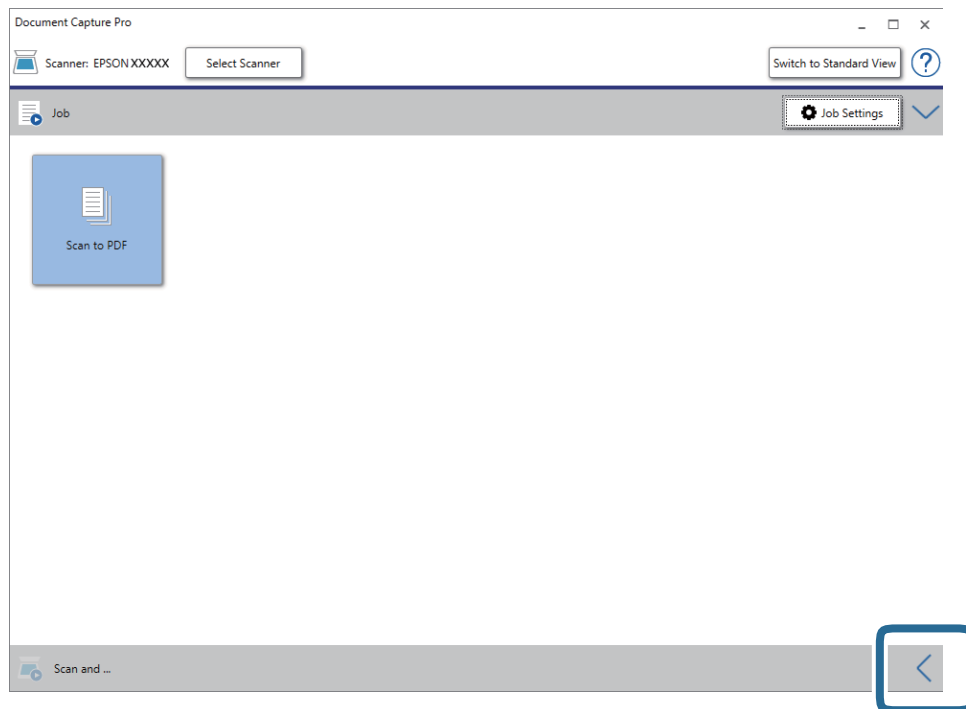

Advanced Scanning

- Click **Scan Settings** to display the **Scan Settings** screen.

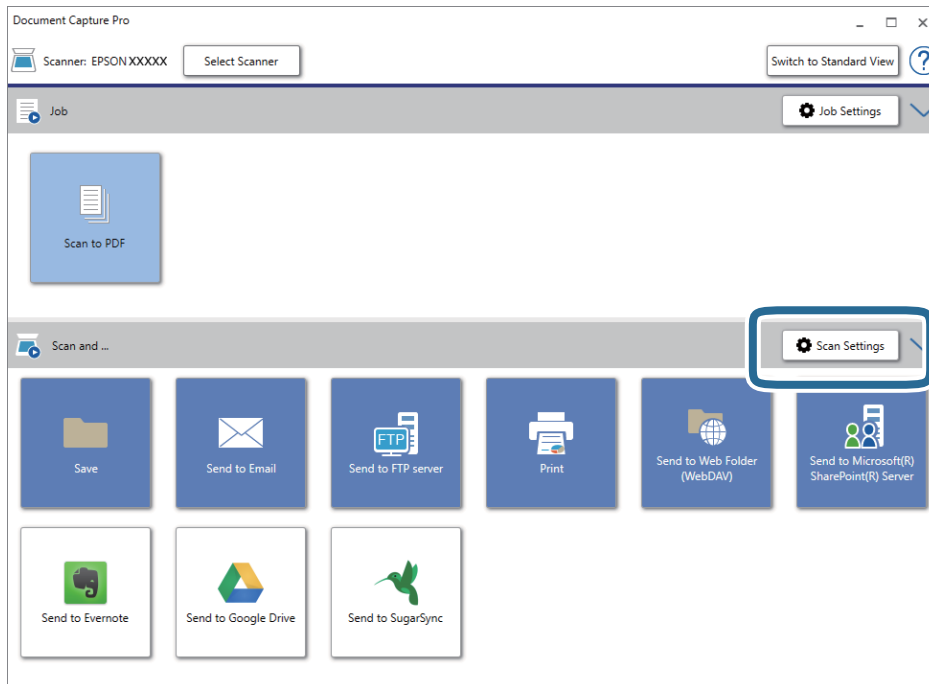

- Make the scanning settings, and then click **OK**.
- Click one of the destination icons.
Scanning starts. After scanning, the **Save Settings** window or **Transfer Settings** window is displayed.
- Select the Office format file you want to save as from the **File Type** list.
- Click **Option** to display the optional settings window.
- Make settings for each item in the window, and then click **OK**.
- Make other settings on the **Save Settings** window or the **Transfer Settings** window, and then click **OK**.
The scanned image is saved as an Office format file.

Maintenance

Cleaning the Scanner

To keep your scanner operating at its best, clean it periodically using the following procedure.

If the glass surface of the ADF is stained with a hard-to-remove substance, use a genuine Epson cleaning kit to remove the stains. Use a small amount of cleaner on the cleaning cloth to remove the stains.

! *Important:*

- Do not press the glass surface of the document glass with any force.*
- Be careful not to scratch or damage the glass surface of the document glass, and do not use a hard or abrasive brush to clean it. A damaged glass surface can decrease the scan quality.*
- Never use alcohol, thinner, or any corrosive solvent to clean the scanner. Deformation or discoloration may occur.*
- Be careful not to spill liquid into the product mechanism or electronic components. This could permanently damage the mechanism and circuitry.*
- Do not spray lubricants to the product.*
- Never open the scanner case.*
- When using the Epson cleaning kit, make sure to put the liquid in the cleaning cloth before use. If the liquid dropped directly inside the scanner, the product could be damaged.*

1. Turn off the product.
2. Unplug the power cord from the product.
3. Clean the outer case with a cloth dampened with mild detergent and water.
4. If the glass surface gets dirty, clean it with a soft dry cloth. If the glass surface is stained with grease or some other hard-to-remove material, use a small amount of glass cleaner and a soft cloth to remove it. Wipe off all remaining liquid.

Make sure that dust does not build up on the glass surface. Dust can cause spots and straight lines in your scanned images.

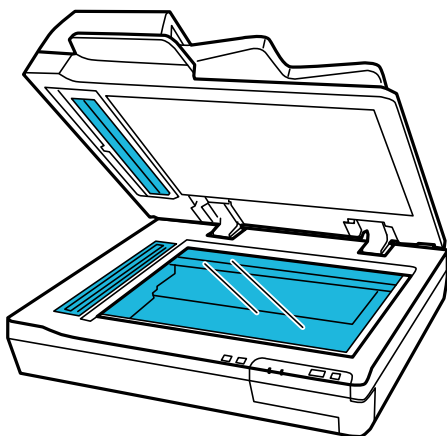

Maintenance

! **Important:**

- ❑ Do not spray glass cleaner directly on the glass surface.
- ❑ Do not use the Epson cleaning kit for the surface of the document glass.
It should only be used to clean the glass for the ADF.

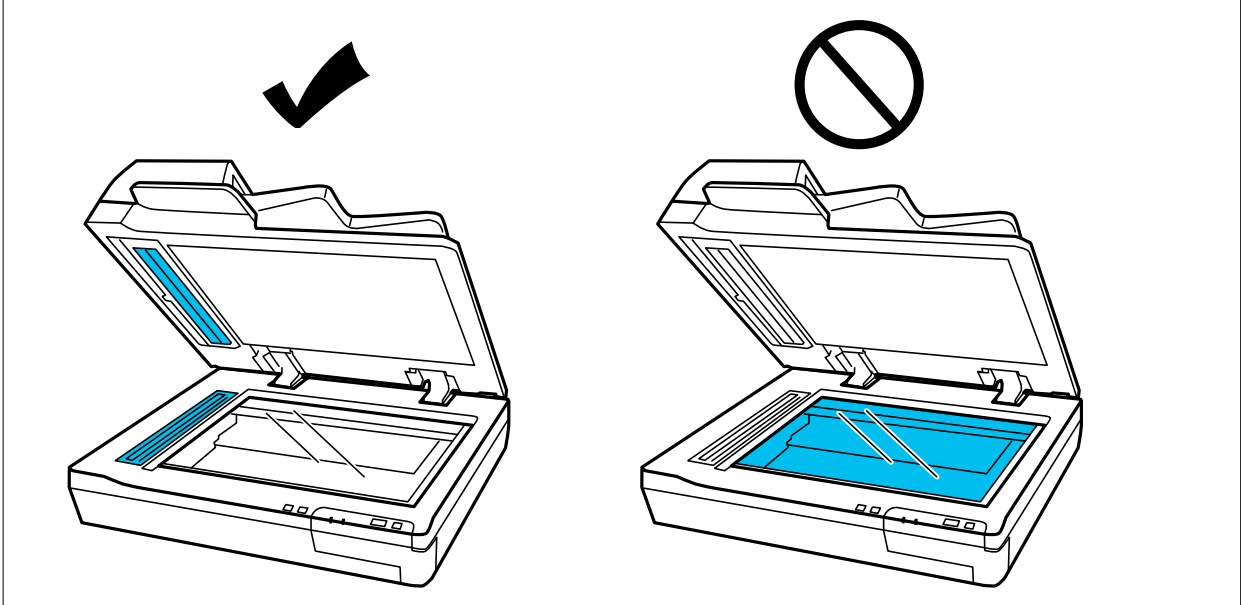

5. Clean the document cover if it gets dirty.

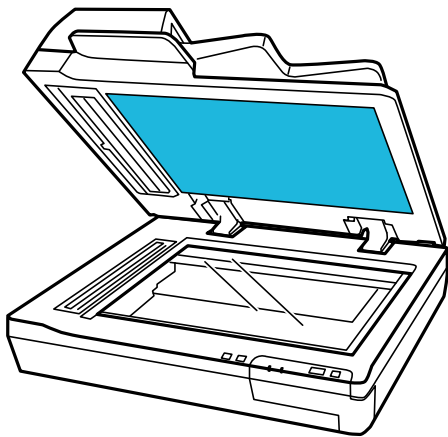

Maintenance

6. Open the ADF cover and use a genuine Epson cleaning kit or a soft, dry, clean cloth to clean the roller and the interior of the ADF.

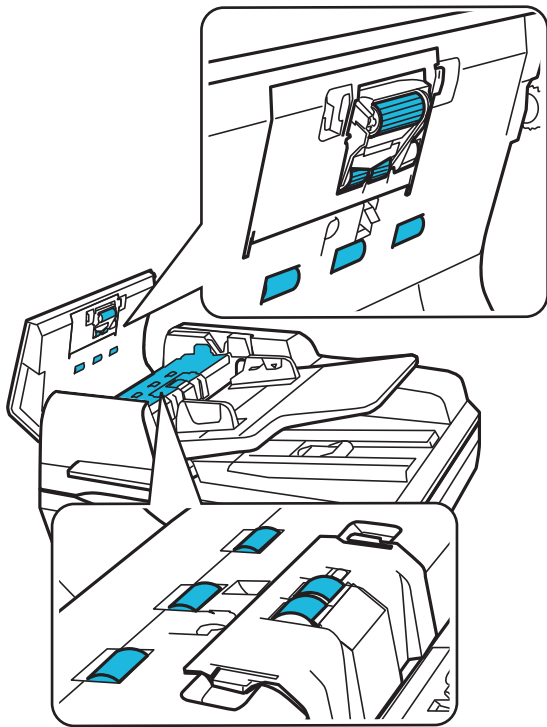

Important:

Do not touch the part shown in the illustration below.

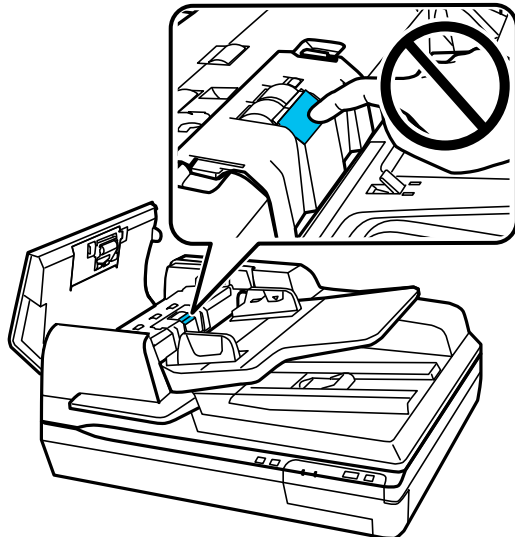

Replacing the Roller Assembly Kit

You need to replace the parts on the Roller Assembly Kit after scanning every 100,000 times.

Maintenance

Removal part	Part number	Number of scanning
Roller Assembly Kit	B12B813501	100,000

To replace the Roller Assembly Kit, follow the steps below.

1. Turn off the scanner.
2. Remove all paper from the input tray.
3. Unplug the power cord from the product.
4. Open the ADF cover.

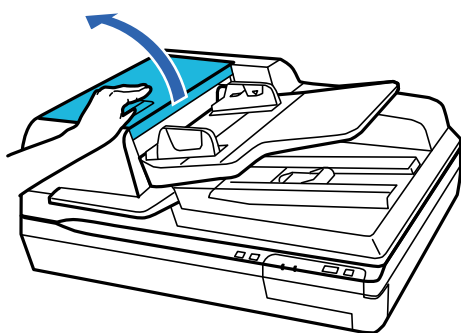

5. Press the hook on both sides of the pickup roller cover, then open the cover.

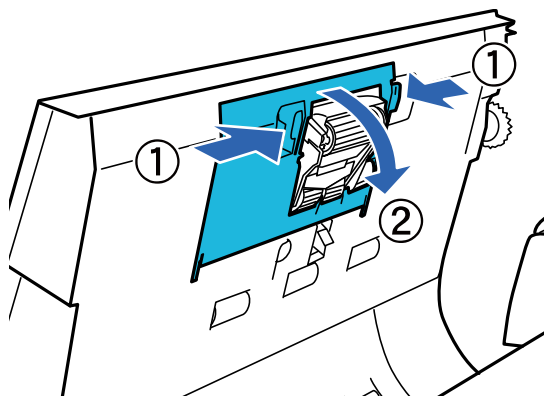

6. Slide and remove the installed pickup roller.

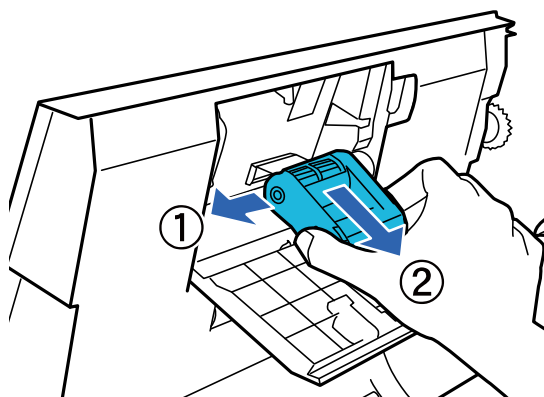

Maintenance

7. Attach the new pickup roller to the correct position.

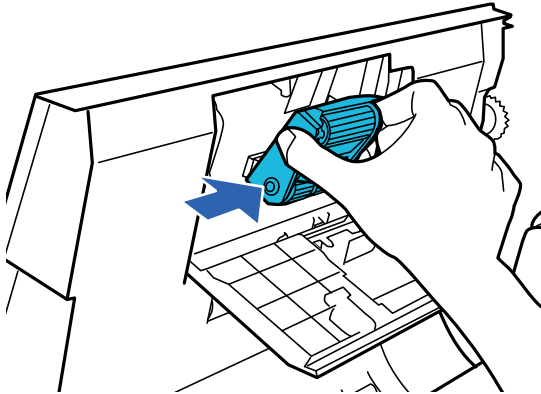

! *Important:*

Do not touch the surface of the roller.

8. Close the pickup roller cover.
9. Press in the hooks on both sides of the retard roller cover, and then open the cover.

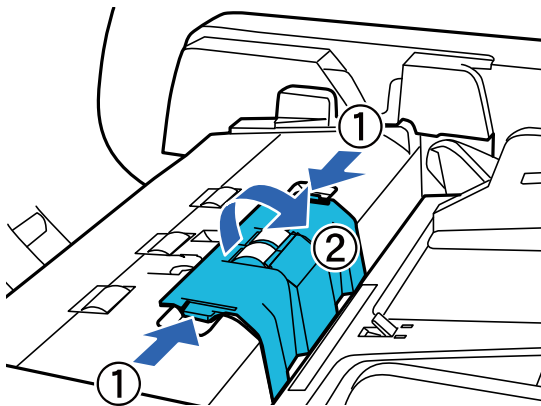

Maintenance

10. Grip the shaft of the retard roller, lift it up, and then remove the retard roller.

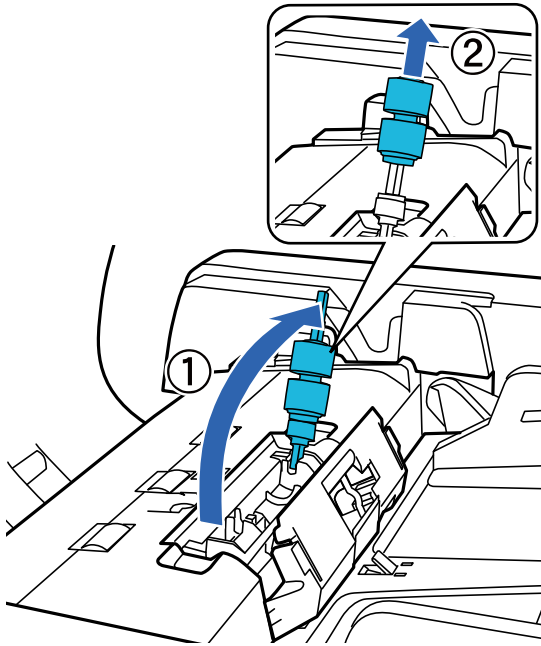

11. Attach the new retard roller to the correct position.

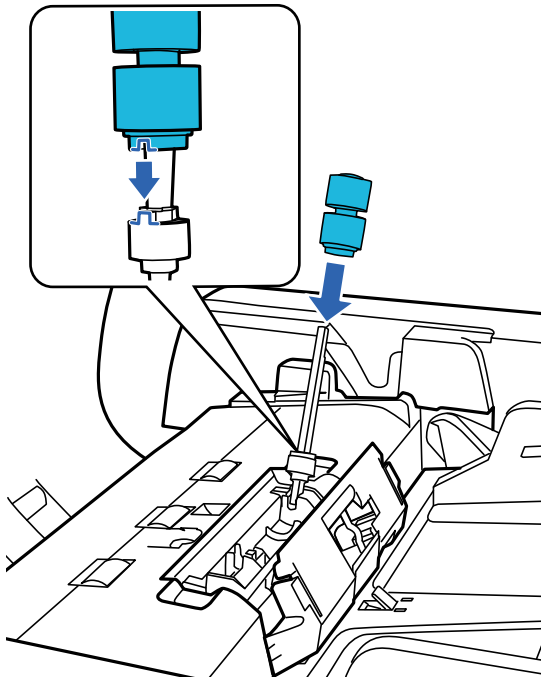

Maintenance

- Press the shaft of the retard roller down until you hear it click into place.

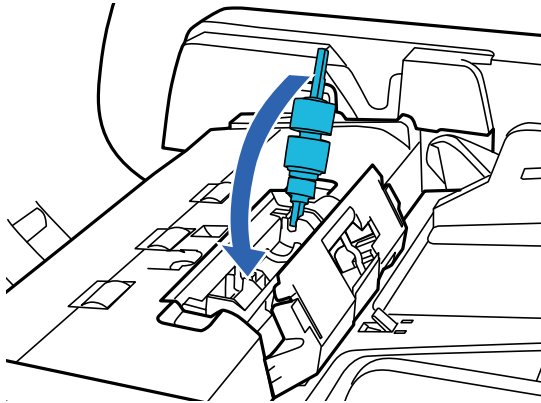

- Close the retard roller cover.
- Close the ADF cover.
- Plug the power cord, and then turn on the scanner.
- Reset the scan number on the control panel or by using Epson Scan 2 Utility.

Note:

Dispose of the pickup roller and the separation roller following the rules and regulations of your local authority. Do not disassemble them.

Related Information

➔ [“Roller Assembly Kit Codes” on page 16](#)

Resetting the Number of Scans in Epson Scan 2 Utility

Reset the number of scans using Epson Scan 2 Utility after replacing the Roller Assembly Kit.

- Turn on the scanner.
- Start Epson Scan 2 Utility.
 - Windows 10/Windows Server 2019/Windows Server 2016
Click the start button, and then select **EPSON > Epson Scan 2 > Epson Scan 2 Utility**.
 - Windows 8.1/Windows 8/Windows Server 2012 R2/Windows Server 2012
Start screen > Apps > Epson > Epson Scan 2 Utility.
 - Windows 7/Windows Vista/Windows XP/Windows Server 2008 R2/Windows Server 2008/Windows Server 2003 R2/Windows Server 2003
Click the start button, and then select **All Programs (or Programs) > EPSON > Epson Scan 2 > Epson Scan 2 Utility**.
 - Mac OS
Select **Go > Applications > EPSON Software > Epson Scan 2 Utility**.
- Click the **Counter** tab.

Maintenance

- Click **Reset** for the roller assembly kit.

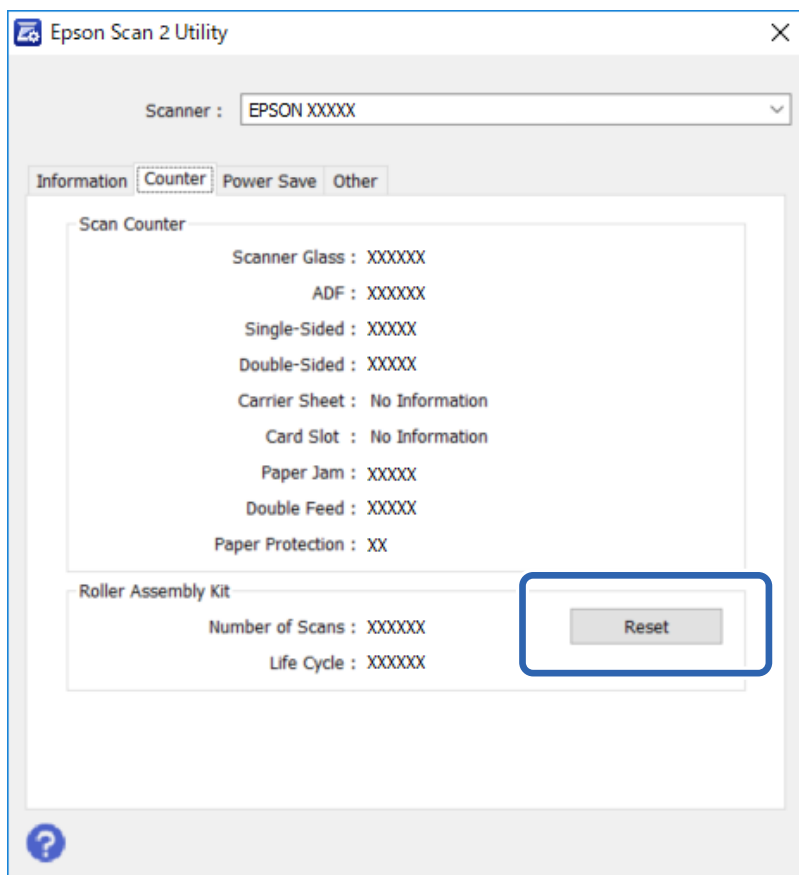

Energy Saving

The product turns off automatically if no operations are performed for the selected period. You can adjust the time before power management is applied. Any increase will affect the product's energy efficiency. Please consider the environment before making any change.

- Start Epson Scan 2 Utility.
 - Windows 10/Windows Server 2019/Windows Server 2016
Click the start button, and then select **EPSON > Epson Scan 2 > Epson Scan 2 Utility**.
 - Windows 8.1/Windows 8/Windows Server 2012 R2/Windows Server 2012
Start screen > Apps > Epson > Epson Scan 2 Utility.
 - Windows 7/Windows Vista/Windows XP/Windows Server 2008 R2/Windows Server 2008/Windows Server 2003 R2/Windows Server 2003
Click the start button, and then select **All Programs (or Programs) > EPSON > Epson Scan 2 > Epson Scan 2 Utility**.
 - Mac OS
Select **Go > Applications > EPSON Software > Epson Scan 2 Utility**.
- Click the **Power Save** tab.

Maintenance

3. Set the **Power Off Timer (minutes)**, and then click **Set**.

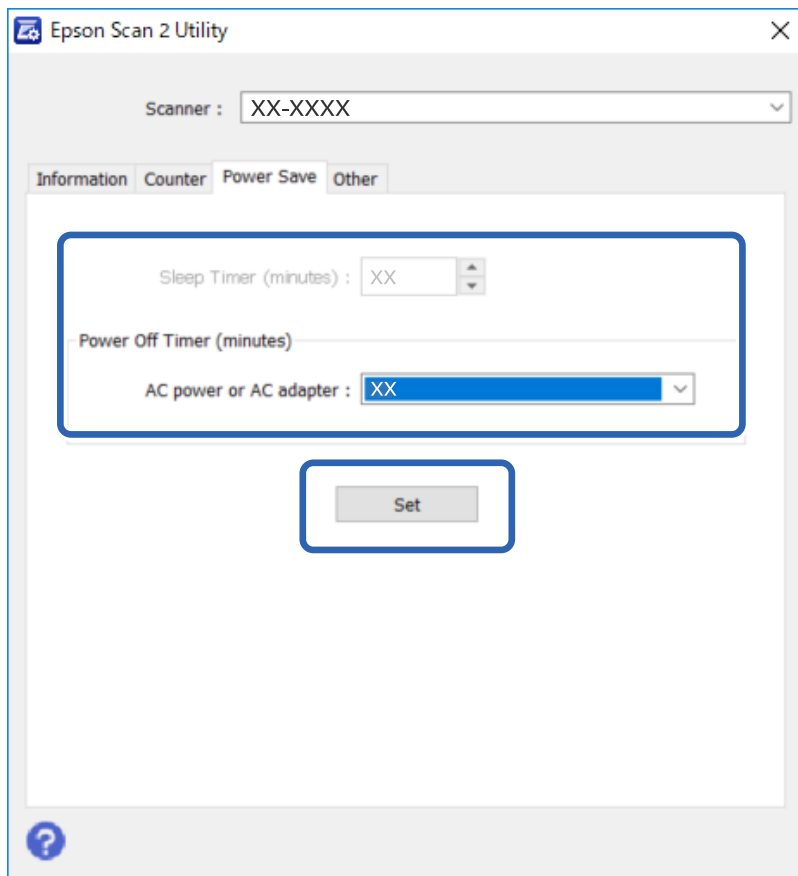

Transporting the Scanner

Before you transport the scanner for a long distance or store it for an extended period of time, you need to lock the carriage to prevent damage.

1. Make sure the carriage is in the home position on the left side of the product. If the carriage is not in the home position, turn on the product and wait until the carriage moves to the home position.
2. Turn off the product, then unplug the power cord.
3. Disconnect the USB cable from the product.

Maintenance

- Return the protective material to the position shown in the following illustration.

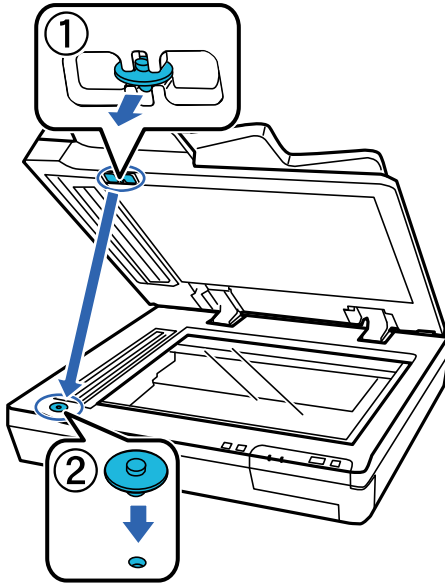

- Slide the transportation lock lever on the left of the scanner to the locked position to secure the scanner carriage.

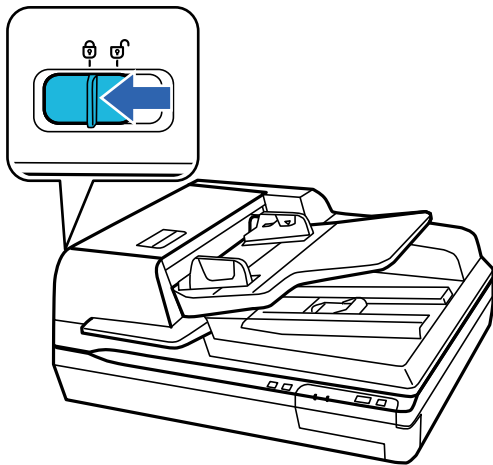

- Attach the packing materials that came with the product, then repack the product in its original box or a similar box that fits the product snugly.

Updating Applications and Firmware

You may be able to clear certain problems and improve or add functions by updating the applications and the firmware. Make sure you use the latest version of the applications and firmware.

! *Important:*

- Do not turn off the computer or the scanner while updating.

- Make sure that the scanner and the computer are connected, and the computer is connected to the internet.

Maintenance

2. Start EPSON Software Updater, and update the applications or the firmware.

Note:

Windows Server operating systems are not supported.

- Windows 10

Click the start button, and then select **Epson Software > EPSON Software Updater**.

- Windows 8.1/Windows 8

Enter the application name in the search charm, and then select the displayed icon.

- Windows 7/Windows Vista/Windows XP

Click the start button, and then select **All Programs** or **Programs > Epson Software > EPSON Software Updater**.

- Mac OS

Select **Go > Applications > Epson Software > EPSON Software Updater**.

Note:

If you cannot find the application you want to update in the list, you cannot update using the EPSON Software Updater. Check for the latest versions of the applications on your local Epson website.

<http://www.epson.com>

Solving Problems

Problems Indicated by Status Light

- Make sure the product is connected to your computer properly.
- Turn off the product and turn it on again. If the problem is not solved, the product may be malfunctioning, or the light source in the scanner unit may need to be replaced. Contact your dealer.
- Make sure the transportation lock has been released.
- If you start the product in recovery mode, you need to update the firmware again.
 1. Connect the computer and the scanner with a USB cable. You cannot perform an update in recovery mode over a network connection.
 2. Download the latest firmware version from the Epson home page, and then start the update.
- Contact your dealer if you cannot clear the error.

Related Information

- ➔ [“Lights” on page 14](#)

Problems When Starting a Scan

- Make sure the scanning software is fully installed.

See the paper manual for instructions on installing the scanning software.
- Check the status light and make sure the product is ready to scan.
- Make sure your cables are securely connected to the product and a working electrical outlet.
- Check that the electrical outlet is working. Plug another device into the electrical outlet and check that you can turn the power on.
- Turn off the product and computer, and then check the interface cable connection between them to make sure it is secure.
- Make sure you select the correct product if a scanner list appears when starting to scan.
- Connect the product directly to the computer's external USB port or through one USB hub only. The product may not work properly when connected to the computer through more than one USB hub. If the problem persists, try connecting the product directly to the computer.
- If more than one product is connected to your computer it may not work. Connect only the product you want to use, and then try scanning again.
- If the scanning software does not work properly, uninstall the software first and then reinstall it as described in the paper manual.
- If the Network Interface Panel is installed, you cannot scan from a computer connected by a USB cable.
- If the light source has reached the end of its service life, it must be replaced by a professional. For details, contact your dealer.

Related Information

➔ [“Installing Your Applications” on page 71](#)

Using the ADF

If the ADF or ADF cover is open, close it and try scanning again.

Cannot Start Document Capture Pro (Windows) or Document Capture (Mac OS)

- Make sure the following applications are installed:
 - Document Capture Pro (Windows) or Document Capture (Mac OS)
 - Epson Scan 2
 - Epson Event Manager

If the applications are not installed, install them again.

- Document Capture Pro does not support Windows Vista, Windows XP, and Windows Server. Use Epson Scan 2 instead.
- Check the correct setting is assigned to the scanner button in Document Capture Pro (Windows) or Document Capture (Mac OS).
- Check the USB cable connection.
 - Make sure the USB cable is securely connected to the scanner and the computer.
 - Use the USB cable that came with the scanner.
 - Connect the scanner directly to the computer's USB port. The scanner may not work properly when connected to the computer through one or more USB hubs.
- Make sure the scanner is turned on.
- Wait until the status light stops flashing indicating that the scanner is ready to scan.
- If you are using any TWAIN-compliant applications, make sure that the correct scanner is selected as the scanner or source setting.

Related Information

➔ [“Installing Your Applications” on page 71](#)

You Cannot Start EPSON Scan 2

Make sure the scanner is connected to your computer properly.

- Check the USB cable connection.
 - Make sure the USB cable is securely connected to the scanner and the computer.
 - Use the USB cable that came with the scanner.
 - Connect the scanner directly to the computer's USB port. The scanner may not work properly when connected to the computer through one or more USB hubs.

Solving Problems

- ❑ If you are using the scanner with the Network Interface Unit, make sure the network cable is securely connected.
- ❑ Make sure the scanner is turned on.
- ❑ Wait until the status light stops flashing indicating that the scanner is ready to scan.
- ❑ If you are using any TWAIN-compliant applications, make sure that the correct scanner is selected as the scanner or source setting.

Related Information

➔ [“Installing Your Applications” on page 71](#)

Paper Feeding Problems

The paper jams in the ADF

If paper jams inside the ADF, open the ADF and remove any paper from the document glass. Then look to see if paper is extending from either end of the feeder.

To clear the jammed paper, follow these steps.

Note:

Remove any pages remaining at either end of the ADF.

1. Turn off the product.
2. If the ADF is open, close it.
3. Open the ADF cover.

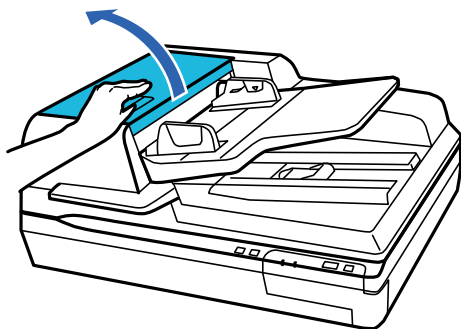

Solving Problems

4. While turning the dial, slowly remove the jammed paper.

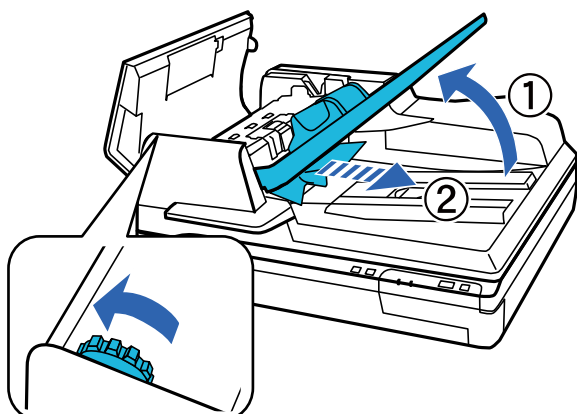

5. If most of the paper has been ejected to the ADF input tray, remove the jammed paper while turning the dial.

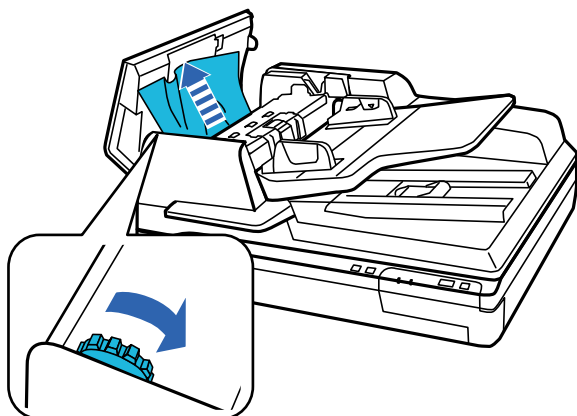

! **Important:**

Remove the paper carefully. If the paper is removed with too much force, the documents or the product could be damaged.

6. After you have removed the paper, close the ADF cover.

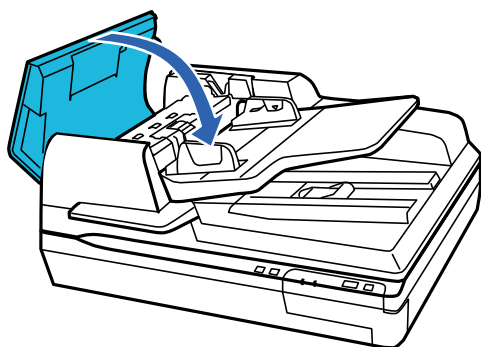

Note:

- If you load unsupported papers, the product may feed more than one sheet of paper at a time.
- You may need to clean the interior of the product.

Multiple Originals Are Fed

If multiple originals are fed frequently, try the following.

- If you load unsupported originals, the scanner may feed multiple originals at a time.
- Clean the ADF.
- Reduce the number of originals being placed at a time.

Related Information

➔ [“Cleaning the Scanner” on page 50](#)

The Originals Get Dirty

Clean the inside of the scanner.

Related Information

➔ [“Cleaning the Scanner” on page 50](#)

Scanning Takes a Long Time

- When the resolution is high, scanning may take some time.
- Computers with USB 2.0 (Hi-Speed) ports can scan faster than those with USB 1.1 ports. If you are using a USB 2.0 port with the scanner, make sure it meets the system requirements.
- When using security software, exclude the TWAIN.log file from monitoring, or set the TWAIN.log as a read-only file. For more information on your security software's functions, see the help and so on supplied with the software. The TWAIN.log file is saved in the following locations.
 - Windows 10/Windows 8.1/ Windows 8/ Windows 7/ Windows Vista:
C:\Users*(user name)*\AppData\Local\Temp
 - Windows XP:
C:\Documents and Settings*(user name)*\Local Settings\Temp

Scanned Image Problems

Scan quality is unsatisfactory

Scan quality can be improved by changing the current settings or adjusting the scanned image.

Straight Lines Appear when Scanning from ADF

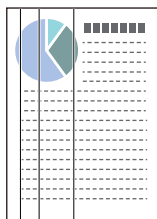

- Clean the ADF.

Straight lines may appear in the image when trash or dirt gets into the ADF.

- Remove any trash or dirt that adheres to the original.

Related Information

➔ [“Cleaning the Scanner” on page 50](#)

Offset Appears in the Background of Images

Images on the back of the original may appear in the scanned image.

- When scanning from the scanner glass, place black paper over the original.

- When **Auto**, **Color**, or **Grayscale** is selected as the **Image Type**:

- Check that **Remove Background** is selected in the Epson Scan 2 window. When you are using Document Capture Pro, you can open the window by pressing the **Detailed Settings** button on the **Scan Settings** screen.

Click the **Advanced Settings** tab > **Remove Background**.

- Check that **Text Enhancement** is selected.

Document Capture Pro (Windows): Click **Scan Settings** > **Text Enhancement**.

Epson Scan 2 (Mac OS): Click the **Advanced Settings** tab > **Text Enhancement**.

- When **Black & White** is selected as the **Image Type**:

Check that **Text Enhancement** is selected.

Document Capture Pro (Windows): Click **Scan Settings** > **Text Enhancement**.

Epson Scan 2 (Mac OS): Click the **Advanced Settings** tab > **Text Enhancement**.

Depending on the condition of your scanned image, click **Settings** in the Epson Scan 2 window and try setting a lower level for **Edge Enhancement** or a higher level for **Noise Reduction Level**.

Scanned Image or Text is Blurred

You can adjust the appearance of the scanned image or text by increasing the resolution or adjusting the image quality.

- Change the resolution, and then scan again.

Set the appropriate resolution for the purpose of your scanned image.

Solving Problems

- Check that **Text Enhancement** is selected.

Document Capture Pro (Windows): Click **Scan Settings** > **Text Enhancement**.

Epson Scan 2 (Mac OS): Click the **Advanced Settings** tab > **Text Enhancement**.

- When **Black & White** is selected as the **Image Type**:

Depending on the condition of your scanned image, click **Settings** in the Epson Scan 2 window and try setting a lower level for **Edge Enhancement** or a higher level for **Noise Reduction Level**.

- If you are scanning in JPEG format, try changing the compression level.

Document Capture Pro (Windows): Click **Option** on the **Save Settings** screen, and then change the image quality for JPEG.

Epson Scan 2 (Mac OS): Click **Image Format** > **Options**, and then change the **Image Quality**.

List of Recommended Resolutions to Suit Your Purpose

See the table and set the appropriate resolution for the purpose of your scanned image.

Purpose	Resolution (Reference)
Displaying on a screen Sending by email	Up to 200 dpi
Using Optical Character Recognition (OCR) Creating a text searchable PDF	200 to 300 dpi
Printing using a printer Sending by fax	200 to 300 dpi

Character is not Recognized Correctly

Check the following to increase the recognition rate of OCR (Optical Character Recognition).

- Check that the original is placed straight.
- Use an original with clear text. Text recognition may decline for the following types of originals.
 - Originals that have been copied a number of times
 - Originals received by fax (at low resolutions)
 - Originals on which the letter spacing or line spacing is too small
 - Originals with ruled lines or underlining over the text
 - Originals with hand-written text
 - Originals with creases or wrinkles
- Paper type made of thermal paper such as receipts may deteriorate due to age or friction. Scan them as soon as possible.
- When saving to Microsoft® Office or **Searchable PDF** files, check that the correct languages are selected.

Solving Problems

Moiré Patterns (Web-Like Shadows) Appear

If the original is a printed document, moiré patterns (web-like shadows) may appear in the scanned image.

- ❑ Check that **Descreening** is selected in the Epson Scan 2 window. When you are using Document Capture Pro, you can open the window by pressing the **Detailed Settings** button on the **Scan Settings** screen.

Click the **Advanced Settings** tab > **Descreening**.



- ❑ Change the resolution, and then scan again.

Cannot Scan the Correct Area on the Document Glass

- ❑ Make sure the original is placed correctly against the alignment marks.
- ❑ If the edge of the scanned image is missing, move the original about more than 3 mm (0.12 inch) away from the horizontal and vertical edges of the document glass to avoid cropping.

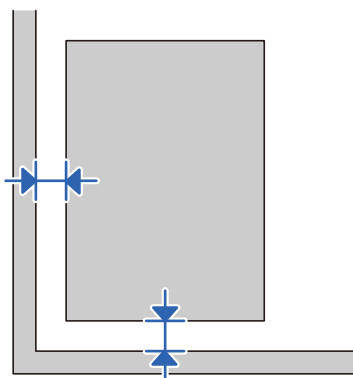

Related Information

➔ [“Cleaning the Scanner” on page 50](#)

The Edge of the Original is Not Scanned when Automatically Detecting the Size of the Original

Depending on the original, the edge of the original may not be scanned when automatically detecting the size of the original.

Solving Problems

- ❑ Adjust **Crop Margins for Size "Auto"** in the Epson Scan 2 window. When you are using Document Capture Pro, you can open the window by pressing the **Detailed Settings** button on the **Scan Settings** screen. Click the **Main Settings** tab > **Document Size** > **Settings**. On the **Document Size Settings** screen, adjust **Crop Margins for Size "Auto"**.
- ❑ Depending on the original, the area of the original may not be detected correctly when using the **Auto Detect** feature. Select the appropriate size of the original from the **Document Size** list.

Note:

If the size of the original you want to scan is not on the list, create the size manually in the Epson Scan 2 window. When you are using Document Capture Pro, you can open the window by pressing the **Detailed Settings** button on the **Scan Settings** screen.

Click the **Main Settings** tab > **Document Size**, and then select **Customize**.

Cannot Solve Problems in the Scanned Image

If you have tried all of the solutions and have not solved the problem, initialize the Epson Scan 2 settings using Epson Scan 2 Utility.

Note:

Epson Scan 2 Utility is an application that comes with Epson Scan 2.

1. Start Epson Scan 2 Utility.
 - ❑ Windows 10/Windows Server 2019/Windows Server 2016
Click the start button, and then select **EPSON** > **Epson Scan 2 Utility**.
 - ❑ Windows 8.1/Windows 8/Windows Server 2012 R2/Windows Server 2012
Enter the application name in the search charm, and then select the displayed icon.
 - ❑ Windows 7/Windows Vista/Windows XP/Windows Server 2008 R2/Windows Server 2008/Windows Server 2003 R2/Windows Server 2003
Click the start button, and then select **All Programs** or **Programs** > **EPSON** > **Epson Scan 2** > **Epson Scan 2 Utility**.
 - ❑ Mac OS
Select **Go** > **Applications** > **Epson Software** > **Epson Scan 2 Utility**.
2. Select the **Other** tab.
3. Click **Reset**.

Note:

If initialization does not solve the problem, uninstall and re-install Epson Scan 2.

Uninstalling and Installing Applications

Uninstalling Your Applications

You may need to uninstall and then reinstall your applications to solve certain problems or if you upgrade your operating system. Log on to your computer as an administrator. Enter the administrator password if the computer prompts you.

Uninstalling Your Applications for Windows

1. Quit all running applications.
2. Disconnect the scanner from your computer.
3. Open the Control Panel:
 - Windows 10/Windows Server 2019/Windows Server 2016
Click on the start button, and then select **Windows System > Control Panel**.
 - Windows 8.1/Windows 8/Windows Server 2012 R2/Windows Server 2012
Select **Desktop > Settings > Control Panel**.
 - Windows 7/Windows Vista/Windows XP/Windows Server 2008 R2/Windows Server 2008/Windows Server 2003 R2/Windows Server 2003
Click the start button and select **Control Panel**.
4. Open **Uninstall a program** (or **Add or Remove Programs**):
 - Windows 10/Windows 8.1/Windows 8/Windows 7/Windows Vista/Windows Server 2019/Windows Server 2016/Windows Server 2012 R2/Windows Server 2012/Windows Server 2008 R2/Windows Server 2008
Select **Uninstall a program** in **Programs**.
 - Windows XP/Windows Server 2003 R2/Windows Server 2003
Click **Add or Remove Programs**.
5. Select the application you want to uninstall.
6. Uninstall the applications:
 - Windows 10/Windows 8.1/Windows 8/Windows 7/Windows Vista/Windows Server 2019/Windows Server 2016/Windows Server 2012 R2/Windows Server 2012/Windows Server 2008 R2/Windows Server 2008
Click **Uninstall/Change** or **Uninstall**.
 - Windows XP/Windows Server 2003 R2/Windows Server 2003
Click **Change/Remove** or **Remove**.

Note:

If the User Account Control window is displayed, click Continue.

7. Follow the on-screen instructions.

Note:

*A message may be displayed prompting you to restart your computer. If it is displayed, make sure **I want to restart my computer now** is selected, and then click **Finish**.*

Uninstalling Your Applications for Mac OS

Note:

Make sure you installed EPSON Software Updater.

1. Download the Uninstaller using EPSON Software Updater.
Once you have downloaded the Uninstaller, you do not need to download it again each time you uninstall the application.

Solving Problems

2. Disconnect the scanner from your computer.
3. To uninstall the scanner driver, select **System Preferences** from the Apple menu > **Printers & Scanners** (or **Print & Scan, Print & Fax**), and then remove the scanner from the enabled scanner list.
4. Quit all running applications.
5. Select **Go > Applications > Epson Software > Uninstaller**.
6. Select the application you want to uninstall, and then click Uninstall.

**Important:**

The Uninstaller removes all drivers for Epson scanners on the computer. If you use multiple Epson scanners and you only want to delete some of the drivers, delete all of them first, and then install the necessary scanner drivers again.

Note:

*If you cannot find the application you want to uninstall in the application list, you cannot uninstall using the Uninstaller. In this situation, select **Go > Applications > Epson Software**, select the application you want to uninstall, and then drag it to the trash icon.*

Installing Your Applications

Follow the steps below to install the necessary applications.

Note:

- Log on to your computer as an administrator. Enter the administrator password if the computer prompts you.
- When reinstalling applications, you need to uninstall them first.

1. Quit all running applications.
2. When installing Epson Scan 2, disconnect the scanner and the computer temporarily.

Note:

Do not connect the scanner and the computer until you are instructed to do so.

3. Install the application by following the instructions on the Website below.

<http://epson.sn>

Note:

For Windows, you can also use the software disc that came with the scanner.

Technical Specifications

General Scanner Specifications

Note:

Specifications are subject to change without notice.

Scanner type	Flatbed color
Photoelectric device	Color CCD line sensor
Effective pixels	7,020×10,200 at 600 dpi
Light source	White LED
Scanning resolution	600 dpi (main scan) 600 dpi (sub scan)
Output resolution	50 to 9600 dpi (in 1 dpi increments) *
Document Size	Document glass: 297×432 mm (11.7×17 inches) ADF 297×2,540 mm (11.7×100 inches)
ADF Paper input	Face-up loading
ADF Paper output	Face-down ejection
ADF Paper capacity	200 sheets of paper at 80 g/m ²
Color Depth	16 bits per pixel per color internal 1 to 8 bits per pixel per color external
Interface	Hi-speed USB port

Note:

Optional optical resolution is the maximum scan resolution of the CCD elements, using the definition of ISO 14473. ISO 14473 defines optical resolution as the fundamental sampling rate of the scan sensor.

Technical Specifications

Dimensions and Weight Specifications

Dimensions *	<p>DS-50000:</p> <p>Width: 640 mm (25.1 inches)</p> <p>Depth: 468 mm (18.4 inches)</p> <p>Height: 156 mm (6.1 inches)</p> <p>DS-60000/DS-70000:</p> <p>Width: 640 mm (25.1 inches)</p> <p>Depth: 522 mm (20.6 inches)</p> <p>Height: 289 mm (11.4 inches)</p>
Weight	<p>DS-50000:</p> <p>Approx. 14.8 kg (32.6 lb)</p> <p>DS-60000/DS-70000:</p> <p>Approx. 27.2 kg (60.0 lb)</p>

* Without protruding parts and the input tray.

Electrical Specifications

Scanner Electrical Specifications

Rated Input Voltage	AC 100 to 240 V
Rated Input Current	1.2 A
Power Consumption	<p>DS-50000:</p> <ul style="list-style-type: none"> <input type="checkbox"/> Operating: Approx. 25.5 W <input type="checkbox"/> Ready mode: Approx. 9.5 W <input type="checkbox"/> Sleep mode: Approx. 1.5 W <input type="checkbox"/> Power off: 0.3 W or below <p>DS-60000/DS-70000:</p> <ul style="list-style-type: none"> <input type="checkbox"/> Operating: Approx. 79 W <input type="checkbox"/> Ready mode: Approx. 12.5 W <input type="checkbox"/> Sleep mode: Approx. 1.5 W <input type="checkbox"/> Power off: 0.3 W or below

Note:

For European users, see the following Website for details on power consumption.

<http://www.epson.eu/energy-consumption>

Technical Specifications

Environmental Specifications

Temperature	When operating	5 to 35 °C (41 to 95 °F)
	When stored	-25 to 60 °C (-13 to 140 °F)
Humidity	When operating	10 to 80% (without condensation)
	When stored	10 to 85% (without condensation)
Operating conditions		Ordinary office or home conditions. Avoid operating the scanner in direct sunlight, near a strong light source, or in extremely dusty conditions.

System Requirements

Windows* ¹	<p>Windows 10 (32-bit, 64-bit)</p> <p>Windows 8.1 (32-bit, 64-bit)</p> <p>Windows 8 (32-bit, 64-bit)</p> <p>Windows 7 (32-bit, 64-bit)</p> <p>Windows Vista (32-bit, 64-bit)</p> <p>Windows XP Professional x64 Edition Service Pack 2</p> <p>Windows XP (32-bit) Service Pack 3</p> <p>Windows Server 2019</p> <p>Windows Server 2016</p> <p>Windows Server 2012 R2</p> <p>Windows Server 2012</p> <p>Windows Server 2008 R2</p> <p>Windows Server 2008 (32-bit, 64-bit)</p> <p>Windows Server 2003 R2 (32-bit, 64-bit)</p> <p>Windows Server 2003 (32-bit, 64-bit) Service Pack 2</p>
Mac OS* ² * ³	<p>macOS Mojave</p> <p>macOS High Sierra</p> <p>macOS Sierra</p> <p>OS X El Capitan</p> <p>OS X Yosemite</p> <p>OS X Mavericks</p> <p>OS X Mountain Lion</p> <p>Mac OS X v10.7.x</p> <p>Mac OS X v10.6.8</p>

*1 Document Capture Pro does not support Windows Vista/Windows XP, and Windows Server.

*2 Fast User Switching on Mac OS or later is not supported.

Technical Specifications

*3 The UNIX File System (UFS) for Mac OS is not supported.

Standards and Approvals

Standards and Approvals for European Models

Low Voltage Directive 2006/95/EC	EN 60950-1
EMC Directive 2004/108/EC	EN55032 Class B EN55024 EN 61000-3-2 EN 61000-3-3

Standards and Approvals for Australian Model

EMC	AS/NZS CISPR22 Class B
-----	------------------------

Where to Get Help

Technical Support Web Site

If you need further help, visit the Epson support website shown below. Select your country or region and go to the support section of your local Epson website. The latest drivers, FAQs, manuals, or other downloadables are also available from the site.

<http://support.epson.net/>

<http://www.epson.eu/support> (Europe)

If your Epson product is not operating properly and you cannot solve the problem, contact Epson support services for assistance.

Contacting Epson Support

Before Contacting Epson

If your Epson product is not operating properly and you cannot solve the problem using the troubleshooting information in your product manuals, contact Epson support services for assistance. If Epson support for your area is not listed below, contact the dealer where you purchased your product.

Epson support will be able to help you much more quickly if you give them the following information:

- Product serial number
(The serial number label is usually on the back of the product.)
- Product model
- Product software version
(Click **About**, **Version Info**, or a similar button in the product software.)
- Brand and model of your computer
- Your computer operating system name and version
- Names and versions of the software applications you normally use with your product

Note:

Depending on the product, the dial list data for fax and/or network settings may be stored in the product's memory. Due to breakdown or repair of a product, data and/or settings may be lost. Epson shall not be responsible for the loss of any data, for backing up or recovering data and/or settings even during a warranty period. We recommend that you make your own backup data or take notes.

Help for Users in Europe

Check your Pan-European Warranty Document for information on how to contact Epson support.

Where to Get Help

Help for Users in Taiwan

Contacts for information, support, and services are:

World Wide Web

<http://www.epson.com.tw>

Information on product specifications, drivers for download, and products enquiry are available.

Epson HelpDesk

Phone: +886-2-80242008

Our HelpDesk team can help you with the following over the phone:

- Sales enquiries and product information
- Product usage questions or problems
- Enquiries on repair service and warranty

Repair service center:

<http://www.tekcare.com.tw/branchMap.page>

TekCare corporation is an authorized service center for Epson Taiwan Technology & Trading Ltd.

Help for Users in Australia

Epson Australia wishes to provide you with a high level of customer service. In addition to your product manuals, we provide the following sources for obtaining information:

Internet URL

<http://www.epson.com.au>

Access the Epson Australia World Wide Web pages. Worth taking your modem here for the occasional surf! The site provides a download area for drivers, Epson contact points, new product information and technical support (e-mail).

Epson Helpdesk

Phone: 1300-361-054

Epson Helpdesk is provided as a final backup to make sure our clients have access to advice. Operators on the Helpdesk can aid you in installing, configuring and operating your Epson product. Our Pre-sales Helpdesk staff can provide literature on new Epson products and advise where the nearest dealer or service agent is located. Many types of queries are answered here.

We encourage you to have all the relevant information on hand when you ring. The more information you prepare, the faster we can help solve the problem. This information includes your Epson product manuals, type of computer, operating system, application programs, and any information you feel is required.

Transportation of Product

Epson recommends retaining product packaging for future transportation.

Where to Get Help

Help for Users in Singapore

Sources of information, support, and services available from Epson Singapore are:

World Wide Web

<http://www.epson.com.sg>

Information on product specifications, drivers for download, Frequently Asked Questions (FAQ), Sales Enquiries, and Technical Support via e-mail are available.

Epson HelpDesk

Toll Free: 800-120-5564

Our HelpDesk team can help you with the following over the phone:

- Sales enquiries and product information
- Product usage questions or problem troubleshooting
- Enquiries on repair service and warranty

Help for Users in Thailand

Contacts for information, support, and services are:

World Wide Web

<http://www.epson.co.th>

Information on product specifications, drivers for download, Frequently Asked Questions (FAQ), and e-mail are available.

Epson Call Centre

Phone: 66-2685-9899

Email: support@eth.epson.co.th

Our Call Centre team can help you with the following over the phone:

- Sales enquiries and product information
- Product usage questions or problems
- Enquiries on repair service and warranty

Help for Users in Vietnam

Contacts for information, support, and services are:

Epson Service Center

65 Truong Dinh Street, District 1, Ho Chi Minh City, Vietnam.

Phone(Ho Chi Minh City): 84-8-3823-9239, 84-8-3825-6234

29 Tue Tinh, Quan Hai Ba Trung, Hanoi City, Vietnam

Where to Get Help

Phone(Hanoi City): 84-4-3978-4785, 84-4-3978-4775

Help for Users in Indonesia

Contacts for information, support, and services are:

World Wide Web

<http://www.epson.co.id>

- Information on product specifications, drivers for download
- Frequently Asked Questions (FAQ), Sales Enquiries, questions through e-mail

Epson Hotline

Phone: +62-1500-766

Fax: +62-21-808-66-799

Our Hotline team can help you with the following over the phone or fax:

- Sales enquiries and product information
- Technical support

Epson Service Center

Province	Company Name	Address	Phone E-mail
JAKARTA	Epson Sales and Service Jakarta (SUDIRMAN)	Wisma Keiai Lt. 1 Jl. Jenderal Sudirman Kav. 3 Jakarta Pusat - DKI JAKARTA 10220	021-5724335 ess@epson-indonesia.co.id ess.support@epson-indonesia.co.id
SERPONG	Epson Sales and Service Serpong	Ruko Melati Mas Square Blok A2 No.17 Serpong-Banten	082120090084 / 082120090085 esstag@epson-indonesia.co.id esstag.support@epson-indonesia.co.id
SEMARANG	Epson Sales and Service Semarang	Komplek Ruko Metro Plaza Block C20 Jl. MT Haryono No. 970 Semarang -JAWA TENGAH	024 8313807 / 024 8417935 esssmg@epson-indonesia.co.id esssmg.support@epson-indonesia.co.id
JAKARTA	Epson Sales and Service Jakarta (MANGGA DUA)	Ruko Mall Mangga Dua No. 48 Jl. Arteri Mangga Dua, Jakarta Utara - DKI JAKARTA	021 623 01104 jkt-technical1@epson-indonesia.co.id jkt-admin@epson-indonesia.co.id
BANDUNG	Epson Sales and Service Bandung	Jl. Cihampelas No. 48 A Bandung Jawa Barat 40116	022 420 7033 bdg-technical@epson-indonesia.co.id bdg-admin@epson-indonesia.co.id
MAKASSAR	Epson Sales and Service Makassar	Jl. Cendrawasih NO. 3A, kunjung mae, mariso, MAKASSAR - SULSEL 90125	0411- 8911071 mksr-technical@epson-indonesia.co.id mksr-admin@epson-indonesia.co.id

Where to Get Help

Province	Company Name	Address	Phone E-mail
MEDAN	Epson Service Center Medan	Jl. Bambu 2 Komplek Graha Niaga Nomor A-4, Medan - SUMUT	061- 42066090 / 42066091 mdn-technical@epson-indonesia.co.id mdn-adm@epson-indonesia.co.id
PALEMBANG	Epson Service Center Palembang	Jl. H.M Rasyid Nawawi No. 249 Kelurahan 9 Ilir Palembang Sumatera Selatan	0711 311 330 escplg.support@epson-indonesia.co.id
PEKANBARU	Epson Service Center Pekanbaru	Jl. Tuanku Tambusai No. 459 A Kel. Tangkerang barat Kec Marpoyan damai Pekanbaru - Riau 28282	0761- 8524695 pkb-technical@epson-indonesia.co.id pkb-admin@epson-indonesia.co.id
PONTIANAK	Epson Service Center Pontianak	Komp. A yani Sentra Bisnis G33, Jl. Ahmad Yani - Pontianak Kalimantan Barat	0561- 735507 / 767049 pontianak-technical@epson-indonesia.co.id pontianak-admin@epson-indonesia.co.id
SAMARINDA	Epson Service Center Samarinda	Jl. KH. Wahid Hasyim (M. Yamin) Kelurahan Sempaja Selatan Kecamatan Samarinda UTARA - SAMARINDA - KALTIM	0541 7272 904 escsmd@epson-indonesia.co.id escsmd.support@epson-indonesia.co.id
SURABAYA	Epson Sales & Service Surabaya (barat)	Jl. Haji Abdul Wahab Saimin, Ruko Villa Bukit Mas RM-11, Kec. Dukuh Pakis, Surabaya - 60225	031- 5120994 sby-technical@epson-indonesia.co.id sby-admin@epson-indonesia.co.id
YOGYAKARTA	Epson Service Center Yogyakarta	YAP Square, Block A No. 6 Jl. C Simanjutak Yogyakarta - DIY	0274 581 065 ygy-technical@epson-indonesia.co.id ygy-admin@epson-indonesia.co.id
JEMBER	Epson Service Center Jember	JL. Panglima Besar Sudirman Ruko no.1D Jember-Jawa Timur (Depan Balai Penelitian & Pengolahan Kakao)	0331- 488373 / 486468 jmr-admin@epson-indonesia.co.id jmr-technical@epson-indonesia.co.id
MANADO	EPSON SALES AND SERVICE Manado	Jl. Piere Tendean Blok D No 4 Kawasan Mega Mas Boulevard - Manado 95111	0431- 8805896 MND-ADMIN@EPSON-INDONESIA.CO.ID MND-TECHNICAL@EPSON-INDONESIA.CO.ID
CIREBON	EPSON SERVICE CENTER Cirebon	Jl. Tuparev No. 04 (Depan Hotel Apita) Cirebon, JAWA BARAT	0231- 8800846 cbn-technical@epson-indonesia.co.id
CIKARANG	EPSON SALES AND SERVICE CIKARANG	Ruko Metro Boulevard B1 Jababeka cikarang - Jawa Barat,	021- 89844301 / 29082424 ckg-admin@epson-indonesia.co.id ckg-technical@epson-indonesia.co.id
MADIUN	EPSON SERVICE CENTER MADIUN	Jl. Diponegoro No.56, MADIUN - JAWA TIMUR	0351- 4770248 mun-admin@epson-indonesia.co.id mun-technical@epson-indonesia.co.id

Where to Get Help

Province	Company Name	Address	Phone E-mail
PURWOKERTO	EPSON SALES AND SERVICE Purwokerto	Jl. Jendral Sudirman No. 4 Kranji Purwokerto - JAWA TENGAH	0281- 6512213 pwt-admin@epson-indonesia.co.id pwt-technical@epson-indonesia.co.id
BOGOR	EPSON SALES AND SERVICE Bogor	Jl.Pajajaran No 15B Kel Bantarjati Kec Bogor Utara - JAWA BARAT 16153	0251- 8310026 bgr-admin@epson-indonesia.co.id bgr-technical@epson-indonesia.co.id
SERANG	EPSON SERVICE CENTER Serang	Jl. Ahmad Yani No.45C, SERANG - BANTEN	0254- 7912503 srg-admin@epson-indonesia.co.id srg-technical@epson-indonesia.co.id
PALU	EPSON SALES AND SERVICE Palu	Jl. Juanda No. 58, Palu - Sulteng	0451- 4012 881 plw-admin@epson-indonesia.co.id plw-technical@epson-indonesia.co.id
BANJARMASIN	EPSON SERVICE CENTER BANJARMASIN	Jl. Gatot Soebroto NO. 153 BANJARMASIN - KALSEL 70235	0511- 6744135 (TEKNISI) / 3266321(ADMIN) bdj-admin@epson-indonesia.co.id bdj-technical@epson-indonesia.co.id
DENPASAR	EPSON SALES AND SERVICE Denpasar	JL. MAHENDRADATA NO. 18, DENPASAR - BALI	0361- 3446699 / 9348428 dps-admin@epson-indonesia.co.id dps-technical@epson-indonesia.co.id
JAKARTA	EPSON SALES AND SERVICE CILANDAK	CIBIS Business Park Tower 9 LT. MEZZANINE, Jalan TB Simatupang No.2, Jakarta Selatan - DKI JAKARTA 12560	021- 80866777 esscibis.support1@epson-indonesia.co.id esscibis.support2@epson-indonesia.co.id esscibis.admin@epson-indonesia.co.id esscibis.sales@epson-indonesia.co.id
SURABAYA	EPSON SALES AND SERVICE SURABAYA (GUBENG)	JL. RAYA GUBENG NO. 62, SURABAYA - JAWA TIMUR	031- 99444940 / 99446299 / 99446377 esssby@epson-indonesia.co.id esssby.support@epson-indonesia.co.id
AMBON	EPSON SERVICE CENTER AMBON	Jl. Diponegoro No.37 (Samping Bank Mandiri Syariah) Kel.Ahusen, Kec.Sirimau - Ambon 97127	-

For other cities not listed here, call the Hot Line: 08071137766.

Help for Users in Hong Kong

To obtain technical support as well as other after-sales services, users are welcome to contact Epson Hong Kong Limited.

Where to Get Help

Internet Home Page

<http://www.epson.com.hk>

Epson Hong Kong has established a local home page in both Chinese and English on the Internet to provide users with the following information:

- Product information
- Answers to Frequently Asked Questions (FAQs)
- Latest versions of Epson product drivers

Technical Support Hotline

You can also contact our technical staff at the following telephone and fax numbers:

Phone: 852-2827-8911

Fax: 852-2827-4383

Help for Users in Malaysia

Contacts for information, support, and services are:

World Wide Web

<http://www.epson.com.my>

- Information on product specifications, drivers for download
- Frequently Asked Questions (FAQ), Sales Enquiries, questions through e-mail

Epson Call Centre

Phone: 1800-81-7349 (Toll Free)

Email: websupport@msb.epson.com.my

- Sales enquiries and product information
- Product usage questions or problems
- Enquiries on repair services and warranty

Head Office

Phone: 603-56288288

Fax: 603-5628 8388/603-5621 2088

Help for Users in India

Contacts for information, support, and services are:

World Wide Web

<http://www.epson.co.in>

Information on product specifications, drivers for download, and products enquiry are available.

Where to Get Help

Helpline

- Service, product information, and ordering consumables (BSNL Lines)
Toll-free number: 18004250011
Accessible 9am to 6pm, Monday through Saturday (Except public holidays)
- Service (CDMA & Mobile Users)
Toll-free number: 186030001600
Accessible 9am to 6pm, Monday through Saturday (Except public holidays)

Help for Users in the Philippines

To obtain technical support as well as other after sales services, users are welcome to contact the Epson Philippines Corporation at the telephone, fax numbers and e-mail address below:

World Wide Web

<http://www.epson.com.ph>

Information on product specifications, drivers for download, Frequently Asked Questions (FAQ), and E-mail Enquiries are available.

Epson Philippines Customer Care

Toll Free: (PLDT) 1-800-1069-37766

Toll Free: (Digital) 1-800-3-0037766

Metro Manila: (632) 8441 9030

Web Site: <https://www.epson.com.ph/contact>

E-mail: customercare@epc.epson.com.ph

Accessible 9am to 6pm, Monday through Saturday (Except public holidays)

Our Customer Care team can help you with the following over the phone:

- Sales enquiries and product information
- Product usage questions or problems
- Enquiries on repair service and warranty

Epson Philippines Corporation

Trunk Line: +632-706-2609

Fax: +632-706-2663