



**AL-M320DN/AL-M310DN/AL-M220DN**

# **User's Guide**

---

NPD5658-06 EN

## Contents

### Contents

#### Introduction

|                                                      |   |
|------------------------------------------------------|---|
| Where to Find Information. . . . .                   | 5 |
| Warning, Caution, Important and Note. . . . .        | 5 |
| Prerequisites of Description in This Manual. . . . . | 5 |
| Abbreviations of Operating Systems. . . . .          | 5 |
| Note For This Publication. . . . .                   | 6 |

#### Important Instructions

|                                                                     |    |
|---------------------------------------------------------------------|----|
| Important Safety Instructions. . . . .                              | 7  |
| Setting up the printer. . . . .                                     | 7  |
| Finding the place for the printer. . . . .                          | 8  |
| Using the printer. . . . .                                          | 8  |
| Handling the consumable products and maintenance parts. . . . .     | 9  |
| Safety Information. . . . .                                         | 10 |
| Laser safety labels. . . . .                                        | 10 |
| Internal laser radiation. . . . .                                   | 10 |
| Ozone safety. . . . .                                               | 10 |
| Restrictions on Making Copies. . . . .                              | 11 |
| Making copies of the following items is prohibited by law. . . . .  | 11 |
| Exercise caution when making copies of the following items. . . . . | 11 |
| Responsible use of copyrighted materials. . . . .                   | 11 |

#### Getting to Know Your Printer

|                                                                      |    |
|----------------------------------------------------------------------|----|
| Printer Parts. . . . .                                               | 12 |
| Front and right side view. . . . .                                   | 12 |
| Inside the printer. . . . .                                          | 12 |
| Rear view. . . . .                                                   | 12 |
| Control Panel for AL-M320DN/AL-M310DN . . . . .                      | 14 |
| Control Panel for AL-M220DN. . . . .                                 | 15 |
| Using the Control Panel. . . . .                                     | 17 |
| When to make control panel settings. . . . .                         | 17 |
| How to access the control panel menus (AL-M320DN/AL-M310DN). . . . . | 17 |
| How to access the control panel menus (AL-M220DN). . . . .           | 17 |
| Language. . . . .                                                    | 19 |
| System Information. . . . .                                          | 19 |
| Quick Print JobMenu (AL-M320DN/AL-M310DN only). . . . .              | 20 |

|                                                         |    |
|---------------------------------------------------------|----|
| ConfidentialJobMenu (AL-M320DN/AL-M310DN only). . . . . | 20 |
| Common Settings. . . . .                                | 21 |
| Printer Settings. . . . .                               | 27 |
| Admin Settings. . . . .                                 | 37 |
| Bookmark Menu (For AL-M320DN/AL-M310DN). . . . .        | 38 |

#### Loading Paper

|                                            |    |
|--------------------------------------------|----|
| Available Paper and Capacities. . . . .    | 39 |
| Available paper types and weights. . . . . | 41 |
| Loading Paper. . . . .                     | 43 |
| Paper cassette. . . . .                    | 43 |
| MP tray. . . . .                           | 44 |
| Paper Output Settings. . . . .             | 45 |
| Orientation to eject paper. . . . .        | 45 |
| Selecting and Using Print Media. . . . .   | 45 |
| Envelopes. . . . .                         | 45 |
| Other paper. . . . .                       | 46 |
| Custom paper size. . . . .                 | 46 |

#### Printing Tasks

|                                                                                   |    |
|-----------------------------------------------------------------------------------|----|
| Basics of Printing. . . . .                                                       | 48 |
| Setting the Main Screen. . . . .                                                  | 49 |
| Setting the More Options Screen. . . . .                                          | 50 |
| Setting the Maintenance Screen. . . . .                                           | 52 |
| Setting Advanced Features. . . . .                                                | 53 |
| Printing multiple print jobs at one time. . . . .                                 | 53 |
| Printing a booklet. . . . .                                                       | 53 |
| Printing data for a single page across multiple sheets (poster printing). . . . . | 54 |
| Using the Reserve Job function (AL-M320DN/AL-M310DN). . . . .                     | 56 |
| Printing with an overlay. . . . .                                                 | 57 |
| Improving the clarity of color documents. . . . .                                 | 58 |
| Making Printer Settings (AL-M220DN only). . . . .                                 | 58 |
| Using Deep Sleep Mode to Save Energy. . . . .                                     | 58 |
| Entering the deep sleep mode manually (For AL-M320DN/AL-M310DN). . . . .          | 59 |
| Entering the deep sleep mode automatically. . . . .                               | 59 |
| Changing the Printer Driver's Default Settings (for Administrators). . . . .      | 59 |
| Changing the default settings. . . . .                                            | 60 |
| Locking the default settings. . . . .                                             | 60 |
| Using EPSON Status Monitor. . . . .                                               | 60 |

## Contents

|                                                                                      |    |                                                                                                                  |     |
|--------------------------------------------------------------------------------------|----|------------------------------------------------------------------------------------------------------------------|-----|
| Accessing EPSON Status Monitor. . . . .                                              | 60 | The ready light is on. . . . .                                                                                   | 90  |
| Notice Settings. . . . .                                                             | 61 | Printout Problems. . . . .                                                                                       | 91  |
| Tray Icon Settings. . . . .                                                          | 61 | Print quality is poor. . . . .                                                                                   | 91  |
| Canceling a Print Job. . . . .                                                       | 61 | The printout is not what you expected. . . . .                                                                   | 92  |
| From the printer. . . . .                                                            | 61 | Printing in the PS3 Mode Problems. . . . .                                                                       | 93  |
| From the computer. . . . .                                                           | 61 | The printer does not print correctly in the<br>PostScript mode. . . . .                                          | 94  |
| <b>Uninstalling and Installing Software</b>                                          |    | The printer does not print. . . . .                                                                              | 94  |
| Uninstalling Software. . . . .                                                       | 62 | The printer or its driver does not appear in<br>utilities in the printer configuration (Mac OS<br>only). . . . . | 94  |
| Installing Software. . . . .                                                         | 62 | The font on the printout is different from that<br>on the screen. . . . .                                        | 94  |
| Installing the PostScript printer driver with<br>Windows. . . . .                    | 63 | The edges of texts and/or images are not<br>smooth. . . . .                                                      | 95  |
| Installing the PostScript printer driver with<br>Mac OS. . . . .                     | 64 | The printer does not print normally via the<br>USB interface. . . . .                                            | 95  |
| Installing the PCL printer driver (For<br>Windows only). . . . .                     | 65 | The printer does not print normally via the<br>network interface. . . . .                                        | 95  |
|                                                                                      |    | An undefined error occurs (Mac OS only). . . . .                                                                 | 95  |
| <b>Maintaining the Printer</b>                                                       |    | Other Problems. . . . .                                                                                          | 96  |
| Replacing Consumable Products/Maintenance<br>Parts. . . . .                          | 66 | The optional product is not available. . . . .                                                                   | 96  |
| Precautions during replacement. . . . .                                              | 66 | Correcting USB problems. . . . .                                                                                 | 96  |
| Replacement Messages/Lights. . . . .                                                 | 66 | Cannot access the shared printer. . . . .                                                                        | 97  |
| Cleaning the Printer. . . . .                                                        | 68 | Transporting the Printer. . . . .                                                                                | 98  |
| Cleaning the inner roller. . . . .                                                   | 68 | For short distances. . . . .                                                                                     | 98  |
|                                                                                      |    | For long distances. . . . .                                                                                      | 98  |
| <b>Troubleshooting</b>                                                               |    | Installing Options (AL-M320DN/AL-M310DN)<br>. . . . .                                                            | 99  |
| Status and Error Messages on the Control Panel<br>(for AL-M320DN/AL-M310DN). . . . . | 70 | Optional paper cassette unit. . . . .                                                                            | 99  |
| Status and Error Lights (for AL-M220DN). . . . .                                     | 76 | <b>Appendix</b>                                                                                                  |     |
| Printing a Status Sheet. . . . .                                                     | 82 | Technical Specifications. . . . .                                                                                | 101 |
| Printing from the control panel (For AL-<br>M320DN/310DN). . . . .                   | 82 | General. . . . .                                                                                                 | 101 |
| Printing from the control panel (For AL-<br>M220DN). . . . .                         | 82 | Electrical. . . . .                                                                                              | 103 |
| Clearing Jammed Paper. . . . .                                                       | 82 | Supported operating systems. . . . .                                                                             | 103 |
| F (Cover F). . . . .                                                                 | 83 | Support Mode Settings using the control panel<br>. . . . .                                                       | 103 |
| E (Cover E). . . . .                                                                 | 85 | Consumable Products and Options. . . . .                                                                         | 107 |
| C1 DM (Cassette1/DM knob). . . . .                                                   | 86 | Consumable products. . . . .                                                                                     | 107 |
| MP (MP tray). . . . .                                                                | 86 | Options. . . . .                                                                                                 | 107 |
| C1 - C3 (Cassette 1 - 3). . . . .                                                    | 87 | Copyrights, Trademarks, and Licenses. . . . .                                                                    | 108 |
| Paper Does Not Feed Properly. . . . .                                                | 88 | SOFTWARE LICENSE. . . . .                                                                                        | 108 |
| Power and Control Panel Problems. . . . .                                            | 88 | Standard and Approvals. . . . .                                                                                  | 108 |
| The ready light does not turn on. . . . .                                            | 88 | German Blue Angel. . . . .                                                                                       | 108 |
| The printer turns off automatically. . . . .                                         | 89 | Energy Star. . . . .                                                                                             | 108 |
| The Printer does not turn off. . . . .                                               | 89 |                                                                                                                  |     |
| The Printer Does Not Print. . . . .                                                  | 90 |                                                                                                                  |     |
| Ready light is off. . . . .                                                          | 90 |                                                                                                                  |     |

**Contents**

***Where To Get Help***

|                                            |     |
|--------------------------------------------|-----|
| Technical Support Web Site. . . . .        | 109 |
| Contacting Epson Support. . . . .          | 109 |
| Before Contacting Epson. . . . .           | 109 |
| Help for Users in Europe. . . . .          | 110 |
| Help for Users in Taiwan. . . . .          | 110 |
| Help for Users in Singapore. . . . .       | 110 |
| Help for Users in Thailand. . . . .        | 111 |
| Help for Users in Vietnam. . . . .         | 111 |
| Help for Users in Indonesia. . . . .       | 111 |
| Help for Users in Hong Kong. . . . .       | 115 |
| Help for Users in Malaysia. . . . .        | 116 |
| Help for Users in the Philippines. . . . . | 116 |

## Introduction

## Introduction

# Where to Find Information

### ❑ Setup Guide

Provides you with information on assembling the printer and installing the printer software.

### ❑ Password Setup Sheet (for AL-M320DN/AL-M310DN)

Provides you with information on how to set a password for the printer. When using it as a network printer, an administrator password must be set for the printer.

### ❑ IP Address and Password Setup Sheet (for AL-M220DN)

Provides you with information on how to set an IP Address and password. When using it as a network printer, an administrator password must be set for the printer. This sheet provides you with information on how to set a password for the printer.

### ❑ User's Guide (this manual)

Provides you with detailed information on the printer's functions, optional products, maintenance, troubleshooting, and technical specifications.

### ❑ Network Guide

Provides network administrators with information on both the printer driver and network settings.

### ❑ Font Guide

Provides you with information on fonts used on the printer. There are two font guides for the printer. Confirm the printer's internal fonts by printing the font list from **System Report**, and see the appropriate *font guide*.

### ❑ Online Help for printer software

Click **Help** for detailed information and instructions on the printer software that controls

your printer. Online help is automatically installed when you install the printer software.

## Warning, Caution, Important and Note



### Warning

*must be followed carefully to avoid serious bodily injury.*



### Caution

*must be observed to avoid bodily injury.*



### Important

*must be observed to avoid damage to your equipment.*

### Note

*contains important information and useful tips on the operation of your printer.*

## Prerequisites of Description in This Manual

The following illustrations and screenshots are used in this guide unless otherwise indicated.

❑ AL-M320DN

❑ Windows 7

The PostScript used on this printer is compatible with PostScript Level 3.

## Abbreviations of Operating Systems

In this manual, the following abbreviations are used.

Windows 10

Microsoft® Windows® 10 Operating System

## Introduction

|                        |                                                     |
|------------------------|-----------------------------------------------------|
| Windows 8.1            | Microsoft® Windows® 8.1 Operating System            |
| Windows 8              | Microsoft® Windows® 8 Operating System              |
| Windows 7              | Microsoft® Windows® 7 Operating System              |
| Windows Vista          | Microsoft® Windows Vista® Operating System          |
| Windows XP             | Microsoft® Windows® XP Operating System             |
| Windows Server 2016    | Microsoft® Windows Server® 2016 Operating System    |
| Windows Server 2012 R2 | Microsoft® Windows Server® 2012 R2 Operating System |
| Windows Server 2012    | Microsoft® Windows Server® 2012 Operating System    |
| Windows Server 2008 R2 | Microsoft® Windows Server® 2008 R2 Operating System |
| Server 2008            | Microsoft® Windows Server® 2008 Operating System    |
| Server 2003            | Microsoft® Windows Server® 2003 Operating System    |
| Windows                | Generic name of operating systems above             |

|                   |                                         |
|-------------------|-----------------------------------------|
| Mac OS X v10.12.x | macOS Sierra                            |
| Mac OS X v10.11.x | OS X El Capitan                         |
| Mac OS X v10.10.x | OS X Yosemite                           |
| Mac OS X v10.9.x  | OS X Mavericks                          |
| Mac OS X v10.8.x  | OS X Mountain Lion                      |
| Mac OS X v10.7.x  | OS X Lion                               |
| Mac OS X v10.6.8  | OS X Snow Leopard                       |
| Mac OS            | Generic name of operating systems above |

## Note For This Publication

No part of this publication may be reproduced, stored in a retrieval system, or transmitted in any form or by any means, mechanical, photocopying, recording, or otherwise, without the prior written permission of Seiko Epson Corporation. No patent liability is assumed with respect to the use of the information contained herein. Neither is any liability assumed for damages resulting from the use of the information contained herein.

Neither Seiko Epson Corporation nor its affiliates shall be liable to the purchaser of this product or third parties for damages, losses, costs, or expenses incurred by purchaser or third parties as a result of: accident, misuse, or abuse of this product or unauthorized modifications, repairs, or alterations to this product, or (excluding the U.S.) failure to strictly comply with Seiko Epson Corporation's operating and maintenance instructions.

Seiko Epson Corporation and its affiliates shall not be liable against any damages or problems arising from the use of any options or any consumable products other than those designated as Original Epson Products or Epson Approved Products by Seiko Epson Corporation.

## Important Instructions

### Important Instructions

## Important Safety Instructions

### Setting up the printer

- ❑ Be sure to lift the printer by the correct positions as shown below.

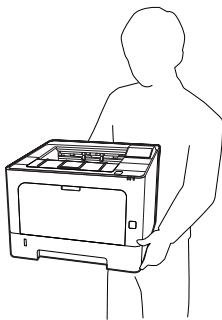

- ❑ When moving the printer, always keep it horizontal.
- ❑ If you are unable to insert the AC plug into the electrical outlet, contact an electrician.
- ❑ Do not connect to an uninterruptible power source. If you connect to one, it may cause malfunctions or damage.
- ❑ Be sure the AC power cord meets the relevant local safety standards. Use only the power cord that comes with this product. Use of another cord may result in fire or electric shock. This product's power cord is for use with this product only. Use with other equipment may result in fire or electric shock.
- ❑ If damage occurs to the plug, replace the cord set or consult a qualified electrician. If there are fuses in the plug, make sure you replace them with fuses of the correct size and rating.
- ❑ Use a grounded outlet that matches the printer's power plug. Do not use an adapter plug.
- ❑ Avoid using an electrical outlet that is controlled by wall switches or automatic timers. Accidental disruption of power can erase valuable information in your computer's and printer's memory.

- ❑ Make sure that there is no dust on the socket.
- ❑ Be sure to insert the plug completely into the electrical outlet.
- ❑ Do not handle the plug with wet hands.
- ❑ Unplug this printer from the wall outlet and refer servicing to a qualified service representative under the following conditions:

|    |                                                                                                                                                                                                                                                                                                                                      |
|----|--------------------------------------------------------------------------------------------------------------------------------------------------------------------------------------------------------------------------------------------------------------------------------------------------------------------------------------|
| A. | When the power cord or plug is damaged or frayed.                                                                                                                                                                                                                                                                                    |
| B. | If liquid has been spilled into it.                                                                                                                                                                                                                                                                                                  |
| C. | If it has been exposed to rain or water.                                                                                                                                                                                                                                                                                             |
| D. | If it does not operate normally when the operating instructions are followed. Adjust only those controls that are covered by the operating instructions since improper adjustment of other controls may result in damage and will often require extensive work by a qualified technician to restore the product to normal operation. |
| E. | If it has been dropped or the cabinet has been damaged.                                                                                                                                                                                                                                                                              |
| F. | If it exhibits a distinct change in performance, indicating a need for service.                                                                                                                                                                                                                                                      |

- ❑ Avoid sharing outlets with other appliances.
- ❑ Connect all equipment to properly grounded power outlets. Avoid using outlets on the same circuit as photocopiers or air control systems that regularly switch on and off.
- ❑ Connect your printer to an electrical outlet that meets the power requirements of this printer. Your printer's power requirements are indicated on a label attached to the printer. If you are not sure of the power supply specifications in your area, contact your local power company or consult your dealer.
- ❑ If you use an extension cord, make sure that the total of the ampere ratings on the products plugged into the extension cord does not exceed the extension cord ampere rating.

## Important Instructions

- ❑ When connecting this product to a computer or other device with a cable, ensure the correct orientation of the connectors. Each connector has only one correct orientation. Inserting a connector in the wrong orientation may damage both devices connected by the cable.
- ❑ Use only optional products, such as the paper cassette units and the printer stand, produced specifically for this product. Using options produced for other products may cause the product to fall over and injure someone.

## Finding the place for the printer

When relocating the printer, always choose a location that has adequate space for easy operation and maintenance. Use the following illustration as a guide for the amount of space required around the printer to ensure smooth operation.

**Note:**

Figures are rounded off to the nearest whole number.

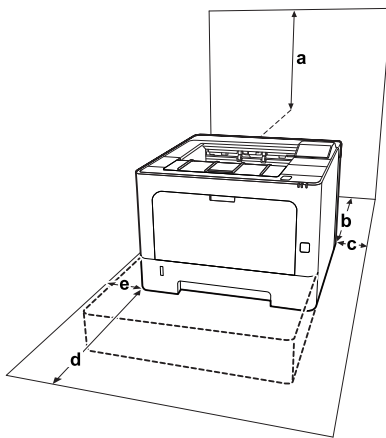

|   |       |   |       |
|---|-------|---|-------|
| a | 20 cm | d | 50 cm |
| b | 30 cm | e | 30 cm |
| c | 30 cm |   |       |

In addition to space considerations, always heed the following precautions when finding a place to locate the printer:

- ❑ Place the printer near an electrical outlet where you can easily plug in and unplug the power cord.
- ❑ Do not put your printer where the cord will be stepped on.

- ❑ Do not use printer in a damp environment.
- ❑ Avoid locations that are subject to direct sunlight, excessive heat, moisture, oil vapor, or dust.
- ❑ Avoid locations that are subject to the air coming directly from an air conditioner.
- ❑ Do not place the printer on an unstable surface.
- ❑ Slots and openings in the cabinet and the back or bottom are provided for ventilation. Do not block or cover them. Do not put the printer on a bed, sofa, rug, or other similar surface or in a built-in installation unless proper ventilation is provided.
- ❑ Keep the entire computer and printer system away from potential sources of interference, such as loudspeakers or the base units of cordless telephones.
- ❑ Leave adequate room around the printer to allow for sufficient ventilation.

## Using the printer

- ❑ Some of the symbols used on your printer are to ensure safety and proper use of the printer. Visit the following web site to learn the meaning of the symbols:  
<http://support.epson.net/symbols/>



Be careful not to touch the fuser, which is marked with a caution label, or the surrounding areas. If the printer has been in use, the fuser and the surrounding areas may be very hot. If you must touch one of these areas, wait 40 minutes to allow the heat to subside before doing so.



Be careful of the sharp edges. Do not touch the sharp edges. It may hurt your fingers, etc.



## Important Instructions

### Rear view

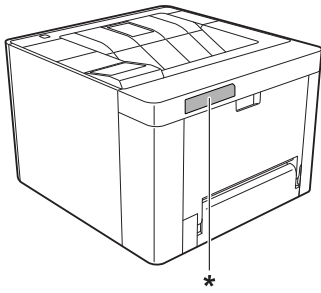

\* caution label



### Front view

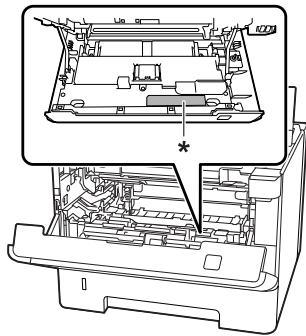

\* caution label



- Do not insert your hand deep into the fuser unit as some components are sharp and may cause injury.
- Never push objects of any kind through cabinet slots as they may touch dangerous voltage points or short out parts that could result in a risk of fire or electric shock.
- Do not sit or lean on the printer. Do not put heavy objects on the printer.
- Do not use any kind of combustible gases in or around the printer.
- Never force the printer's components into place. Although the printer is designed to be sturdy, rough handling can damage it.

- Do not leave jammed paper inside the printer. This can cause the printer to overheat.
- Never spill liquid of any kind on the printer.
- Adjust only those controls that are covered by the operating instructions. Improper adjustment of other controls may result in damage and may require repair by a qualified service representative.
- Do not turn off the printer:
  - After turning on the printer, wait until **Ready** appears on the LCD panel (AL-M320DN/AL-M310DN), or the Ready light turns on (AL-M220DN).
  - While the **Data** light is on or flashing.
  - While printing.
- Avoid touching the components inside the printer unless instructed to do so in this guide.
- Follow all warnings and instructions marked on the printer.
- Except as specifically explained in the printer's documentation, do not attempt to service this product yourself.
- Periodically disconnect the plug from the electrical outlet and clean the blades.
- Do not disconnect the plug while the printer is on.
- If the printer will not be used for a long time, disconnect the plug from the electrical outlet.
- Unplug this printer from the wall outlet before cleaning.
- Use a well-wrung cloth for cleaning and do not use liquid or aerosol cleaners.

## Handling the consumable products and maintenance parts

- Do not burn used consumable products and maintenance parts because they might explode and injure someone. Dispose of them according to local regulations.
- Be sure to keep consumable products and maintenance parts out of the reach of children.

## Important Instructions

- ❑ When handling a toner cartridge, always place it on a clean, smooth surface.
- ❑ Do not attempt to modify or take it apart consumable products and maintenance parts.
- ❑ Do not touch the toner. Always keep toner away from your eyes. If toner gets on your skin or clothes, wash it off with soap and water immediately.
- ❑ If toner is spilled, use a broom and dustpan or a damp cloth with soap and water to clean it up. Because the fine particles can cause a fire or explosion if they come into contact with a spark, do not use a vacuum cleaner.
- ❑ Wait at least one hour before using a toner cartridge or photoconductor after moving it from a cool to a warm environment to prevent damage from condensation.
- ❑ To get the best print quality, do not store the toner cartridge in an area subject to direct sunlight, dust, salty air, or corrosive gases (such as ammonia). Avoid locations subject to extreme or rapid changes in temperature or humidity.
- ❑ When removing the photoconductor unit, do not expose it to sunlight at all and avoid exposing it to room light for more than three minutes. The photoconductor unit contains a light-sensitive drum. Exposure to light can damage the drum, causing dark or light areas to appear on the printed page and reducing the service life of the drum. If you need to keep the photoconductor unit out of the printer for long periods, cover it with an opaque cloth.
- ❑ Be careful not to scratch the surface of the drum. When you remove the photoconductor unit from the printer, always place it on a clean, smooth surface. Avoid touching the drum, since oil from your skin can permanently damage its surface and affect print quality.
- ❑ Do not touch the transfer roller to avoid damaging it.
- ❑ Do not let the paper's edge slide across your skin because the edge of the paper may cut you.

## Safety Information

### Laser safety labels



#### Warning:

*The performance of procedures and adjustments other than those specified in the printer's documentation may result in hazardous radiation exposure. Your printer is a Class 1 laser product as defined in the IEC60825 specifications and a consumer class 1 laser product as defined by the EN50689:2021 specifications. The label similar to the one shown below is attached to the back of the printer in countries where required.*



### Internal laser radiation

There is a Class III b Laser Diode Assembly that has an invisible laser beam inside the printer head unit. The printer head unit is NOT A SERVICE ITEM, therefore, the printer head unit should not be opened under any circumstances. An additional laser warning label is affixed to the inside of the printer.

### Ozone safety

#### Ozone emission

Ozone gas is generated by laser printers as a by-product of the printing process. Ozone is produced only when the printer is printing.

#### Ozone exposure limit

The Epson laser printer generates less than 1.5 mg/h of continuous printing.

#### Minimize the risk

To minimize the risk of exposure to ozone, you should avoid the following conditions:

## Important Instructions

- Use of multiple laser printers in a confined area
- Operation in conditions of extremely low humidity
- Poor room ventilation
- Long, continuous printing together with any of the above

### Printer location

The printer should be located so that the exhaust gases and heat generated are:

- Not blown directly into the user's face
- Vented directly out of the building whenever possible

## Restrictions on Making Copies

Observe the following restrictions in order to ensure the responsible and legal use of this printer.

---

### Making copies of the following items is prohibited by law

- Bank bills, coins, government-issued marketable securities, government bond securities, and municipal securities
- Unused postage stamps, pre-stamped postcards, and other official postal items bearing valid postage
- Government-issued revenue stamps, and securities issued according to legal procedure

---

### Exercise caution when making copies of the following items

- Private marketable securities (stock certificates, negotiable notes, checks, etc.), monthly passes, concession tickets, etc.
- Passports, driver's licenses, warrants of fitness, road passes, food stamps, tickets, etc.

---

## Responsible use of copyrighted materials

The printer may be used mistakenly or improperly to illegally copy copyrighted materials. You must act responsibly when copying copyrighted materials; by acquiring the permission of the copyright holder or acting on the advice of a knowledgeable attorney.

Getting to Know Your Printer

# Getting to Know Your Printer

## Printer Parts

### Front and right side view

#### AL-M320DN/AL-M310DN

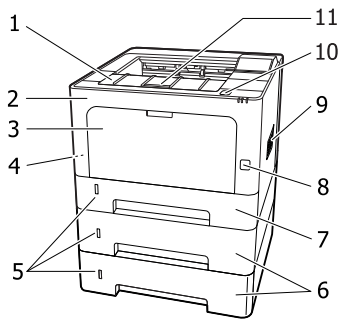

#### AL-M220DN

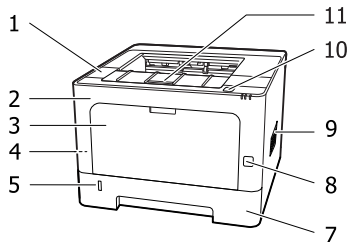

|     |                                                  |
|-----|--------------------------------------------------|
| 1.  | cover F2                                         |
| 2.  | cover F1                                         |
| 3.  | MP tray                                          |
| 4.  | security slot                                    |
| 5.  | window for knowing the remaining amount of paper |
| 6.  | cassette 2/3 (optional paper cassette)           |
| 7.  | cassette 1 (standard paper cassette)             |
| 8.  | power switch                                     |
| 9.  | ventilation window                               |
| 10. | button to open covers F1 and F2                  |

|     |               |
|-----|---------------|
| 11. | paper support |
|-----|---------------|

### Inside the paper cassette

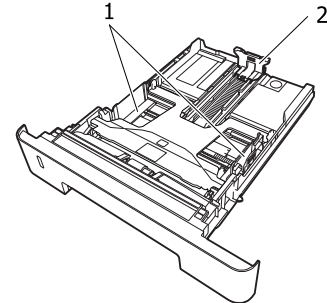

|    |                          |
|----|--------------------------|
| 1. | paper guide (side guide) |
| 2. | paper guide (back guide) |

### Inside the printer

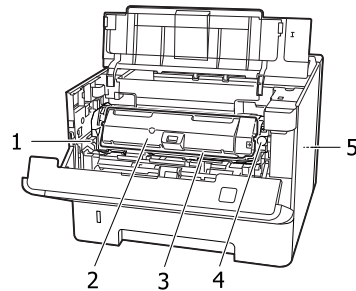

|    |                                         |
|----|-----------------------------------------|
| 1. | lever to remove maintenance unit A      |
| 2. | toner cartridge                         |
| 3. | maintenance unit A                      |
| 4. | lock release button for toner cartridge |
| 5. | maintenance unit B                      |

### Rear view

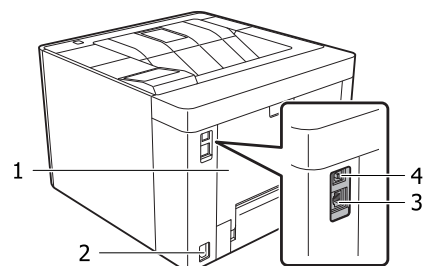

## Getting to Know Your Printer

|    |                                                                                                                                              |
|----|----------------------------------------------------------------------------------------------------------------------------------------------|
| 1. | cover E                                                                                                                                      |
| 2. | AC inlet                                                                                                                                     |
| 3. | Ethernet interface connector<br>LED1: data light<br>LED2: status light<br>For the information that the lights indicate, see the table below. |
| 4. | USB interface connector                                                                                                                      |

### LED Status

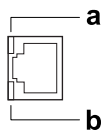

| a: LED1           | b: LED2     | Network Status                                             |
|-------------------|-------------|------------------------------------------------------------|
| Yellow            | Green       | Ready (1000BASE-T)                                         |
| Yellow (Flashing) | Green       | Receiving packets (1000BASE-T)                             |
| Yellow            | Orange      | Ready (100BASE-TX)                                         |
| Yellow (Flashing) | Orange      | Receiving packets (100BASE-TX)                             |
| Yellow            | Off         | Ready (10BASE-Te)                                          |
| Yellow (Flashing) | Off         | Receiving packets (10BASE-Te)                              |
| Off               | Green / Off | Deep sleep mode* (1000BASE-T)                              |
| Off               | Off         | Deep sleep mode* (100BASE-TX/10BASE-Te)<br>Power off mode* |

\* See "Energy Saver Menu" on page 25 for details.

Getting to Know Your Printer

Control Panel for AL-M320DN/AL-M310DN

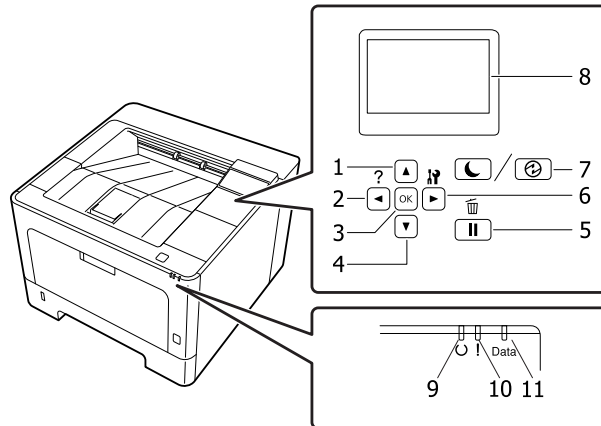

|     |                             |                                                                                                                                                                                                                                                                                                                                                                                                                                                                                                                                                  |
|-----|-----------------------------|--------------------------------------------------------------------------------------------------------------------------------------------------------------------------------------------------------------------------------------------------------------------------------------------------------------------------------------------------------------------------------------------------------------------------------------------------------------------------------------------------------------------------------------------------|
| 1.  | <b>▲ Up</b> button          | Press to scroll the items on the control panel menus.                                                                                                                                                                                                                                                                                                                                                                                                                                                                                            |
| 2.  | <b>◀ Left</b> button        | Press to go back to the previous menu, or press to show the help if <code>◀Press for help</code> is displayed.                                                                                                                                                                                                                                                                                                                                                                                                                                   |
| 3.  | <b>OK</b> button            | Press to set the menu, item or setting.<br>When the error light is flashing, pressing this button clears the error and switches the printer to ready status.                                                                                                                                                                                                                                                                                                                                                                                     |
| 4.  | <b>▼ Down</b> button        | Press to scroll the items on the control panel menus.                                                                                                                                                                                                                                                                                                                                                                                                                                                                                            |
| 5.  | <b>Pause/Release</b> button | Press once to pause. Press again to recover from pause. While paused, the following operations are available on the control panel. <ul style="list-style-type: none"> <li><input type="checkbox"/> Canceling the current print job or stored print jobs. See <a href="#">"Cancelling a Print Job" on page 61</a>.</li> <li><input type="checkbox"/> Interrupting print jobs to print a stored print job.</li> <li><input type="checkbox"/> Ejecting a paper (Form Feed) by holding down the <b>OK</b> button for more than 2 seconds.</li> </ul> |
| 6.  | <b>▶ Right</b> button       | Press to go to the next menu, item or setting.                                                                                                                                                                                                                                                                                                                                                                                                                                                                                                   |
| 7.  | <b>Wakeup/Sleep</b> button  | Press to switch the status between available for printing and saving power. This button lights up or blinks when the printer is in the deep sleep mode. This button blinks when the printer enters the power off mode, which saves power because almost all functions are not available.<br>For more details about the power off mode, see <a href="#">"Energy Saver Menu" on page 25</a> .                                                                                                                                                      |
| 8.  | LCD panel                   | Displays printer status messages and control panel menu settings.                                                                                                                                                                                                                                                                                                                                                                                                                                                                                |
| 9.  | <b>Ready</b> light          | On when the printer is ready, indicating that the printer is ready to receive and print data.<br>Off when the printer is not ready, or in the deep sleep mode.                                                                                                                                                                                                                                                                                                                                                                                   |
| 10. | <b>Error</b> light (Orange) | On or flashes when an error has occurred.<br>Pressing the <b>OK</b> button or <code>Auto Cont</code> setting in the <code>Setup Menu</code> clears the errors that are flashing.                                                                                                                                                                                                                                                                                                                                                                 |

**Getting to Know Your Printer**

|     |                   |                                                                                                                                                                                                                              |
|-----|-------------------|------------------------------------------------------------------------------------------------------------------------------------------------------------------------------------------------------------------------------|
| 11. | <b>Data light</b> | On when print data is stored in the print buffer (the section of printer memory reserved for receiving data) but not yet printed. Flashes when the printer is processing data. Off when no data remains in the print buffer. |
|-----|-------------------|------------------------------------------------------------------------------------------------------------------------------------------------------------------------------------------------------------------------------|

**Control Panel for AL-M220DN**

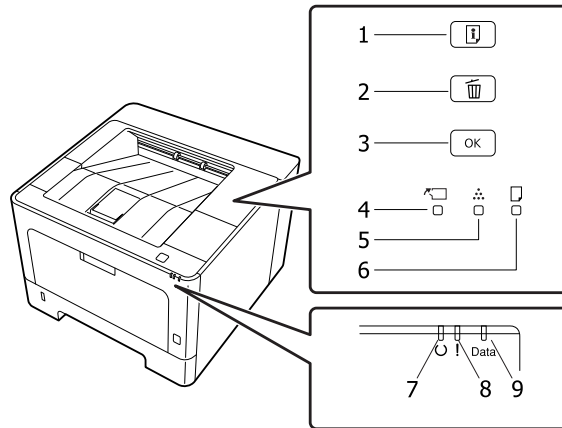

|    |                                      |                                                                                                                                                                                                                                                            |
|----|--------------------------------------|------------------------------------------------------------------------------------------------------------------------------------------------------------------------------------------------------------------------------------------------------------|
| 1. | <b>Information button</b>            | Prints status sheets when the Error light is off and no warning is indicated. Prints a status sheet when pressed once. Pressing this button for more than two seconds prints a network status sheet. Clears the warning when a warning is indicated.       |
| 2. | <b>Job Cancel button</b>             | Press once to cancel the current print job. Press and hold for more than two seconds to delete all jobs from the printer memory.                                                                                                                           |
| 3. | <b>OK button</b>                     | When the error light is flashing, pressing this button clears the error and switches the printer to ready status.                                                                                                                                          |
| 4. | <b>Cover &amp; Maintenance light</b> | Lit when the printer's cover is open, or when an error related to consumable products or maintenance parts other than toner occurred. Flashes when a warning related to these occurred.                                                                    |
| 5. | <b>Toner light</b>                   | On when the printer's toner cartridge has run out of toner. Flashes to indicate that toner is running low. If this light is flashing, have a new toner cartridge ready.                                                                                    |
| 6. | <b>Paper light</b>                   | Turns on or flashes, and when in combination with the Error light, usually indicates a paper-related problem. On usually indicates a paper jam, while flashing usually indicates a paper-related error or warning, such as when the paper source is empty. |
| 7. | <b>Ready light</b>                   | On when the printer is ready, indicating that the printer is ready to receive and print data. Off when the printer is not ready. This light also comes on in combination with other lights to indicate error situations.                                   |
| 8. | <b>Error light (Orange)</b>          | On or flashes when an error has occurred.                                                                                                                                                                                                                  |
| 9. | <b>Data light</b>                    | On when print data is stored in the print buffer (the section of printer memory reserved for receiving data) but not yet printed. Flashes when the printer is processing data. Off when no data remains in the print buffer.                               |

## Getting to Know Your Printer

**Note:**

- ❑ *When the printer is in deep sleep mode, all lights are off. When in deep sleep mode, pressing any button returns the printer to the ready state.*
- ❑ *For details about LED light statuses, see [“Status and Error Lights \(for AL-M220DN\)”](#) on page 76.*



## Getting to Know Your Printer

## Using the Control Panel

### When to make control panel settings

In general, printer driver settings override settings made using the control panel.

You should make the following settings by using the control panel because these settings cannot be made in the printer driver.

- Settings to select emulation modes and IES (Intelligent Emulation Switching) mode
- Settings to specify a channel and configure the interface
- Settings to specify the size of the memory buffer used to receive data

For AL-M220DN, which does not have an LCD panel, you can do the control panel settings using EpsonNet Config. See [“How to access the control panel menus \(AL-M220DN\)”](#) on page 17.

### How to access the control panel menus (AL-M320DN/AL-M310DN)

**Note:**

Some menus and items appear only when a corresponding optional device is installed or an appropriate setting has been done.

- 1 Press the **▶ Right** button to access the control panel menus.

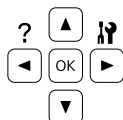

- 2 Use the **▲ Up** and **▼ Down** buttons to scroll through the menus.

- 3 Press the **▶ Right** button to view the items in a menu. Depending on the menu, the LCD panel displays an item and the current setting separated (**▲YYY=ZZZZ**), or only an item (**▲YYY**).

- 4 Use the **▲ Up** and **▼ Down** buttons to scroll through the items, or press the **◀ Left** button to return to the previous level.

- 5 Press the **▶ Right** button to carry out the operation indicated by an item, such as printing a configuration status sheet or resetting the printer, or to view the settings available for an item, such as paper sizes or emulation modes.

Use the **▲ Up** and **▼ Down** buttons to scroll through available settings, then press the **▶ Right** button to select a setting and return to the previous level. Press the **◀ Left** button to return to the previous level without changing the setting.

**Note:**

- You need to turn the printer off and then on to activate the settings you changed in the Network Menu, USB Menu or RAM Disk in the Setup Menu.
- The OK button can be used instead of the **▶ Right** button in step 3 or 5.

- 6 Press the **◀ Left** button once or more times to exit the control panel menus.

### How to access the control panel menus (AL-M220DN)

Although there are no panels that can display menus, you can do settings that correspond to the operation panel menus from a computer that is connected to the printer. You can do the settings using the following procedure.

#### From EpsonNet Config (web version)

You can do settings when the printer is connected to the network.

The method to open the settings screen is shown below.

## Getting to Know Your Printer

- 1 Connect the printer to the same network as your computer.

**Note:**

See the following manuals for how to connect the printer to the network.

- Setup Guide
- IP Address and Password Setup Sheet

- 2 Enter the printer's IP address into the address bar of your web browser.

### From the printer driver

You can set the following items that you think you will use often as printer settings, whether the printer is connected via USB or a network.

- MP Tray Size / MP Tray Type
- Cassette1 Size / Cassette1 Type
- Density
- Emphasize Thin Lines
- Paper Source
- Wide A4
- MP Tray Priority
- Page Protect
- Auto Eject Page
- I/F Time Out
- Size Ignore
- Time Setting
- Auto Cont
- Time to Sleep
- Language (Status Sheet)

**Note:**

For references for the corresponding control panel menus, see the following sections.

- ["Tray Menu" on page 27](#)
- ["Printing Menu" on page 28](#)
- ["Setup Menu" on page 21](#)
- ["Energy Saver Menu" on page 25](#)

To open the screen to do settings, follow the steps below:

- 1 Access the printer driver's properties from Start -Devices and Printers.

- 2 Click the **Optional Settings** tab, and then click the **Printer Settings** button.

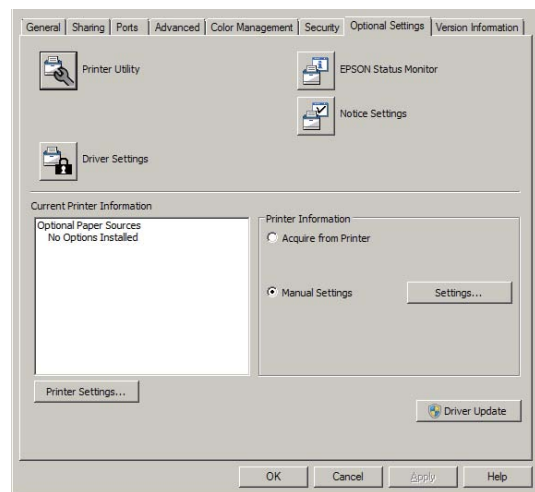

**Note:**

A warning appears if the time is not set after purchasing the printer. Use Printer Settings to set the time.

## Getting to Know Your Printer

### Language

| Item     | Explanation                                                                                                                                                                                                        |
|----------|--------------------------------------------------------------------------------------------------------------------------------------------------------------------------------------------------------------------|
| Language | Specifies the language displayed on the LCD panel (AL-M320DN/AL-M310DN only) and that printed on the status sheet.                                                                                                 |
|          | Settings (default in bold):<br><b>English</b> , Français, Deutsch, Italiano, ESPAÑOL, SVENSKA, Dansk, Nederlands, SUOMI, Português, Norsk, CATALÀ, РУССКИЙ, Türkçe, Polski, Čeština, Magyar, Română, 中文, 繁體中文, 한국어 |

### System Information

#### System Information

**Note:**

To use EpsonNet Config with a web browser to confirm settings, access **Information > System > System Information**.

| Item         | Explanation                                                     |
|--------------|-----------------------------------------------------------------|
| Main Version | Displays the version of the firmware installed on each printer. |
| IPL Version  |                                                                 |
| MCU Version  |                                                                 |
| Serial No    | Displays the serial number of each printer.                     |
| Memory       | Displays the amount of memory of each printer.                  |
| MAC Address  | Displays the MAC address of each printer.                       |

### System Report

**Note:**

To use EpsonNet Config with a web browser to print a report, access **Information > Confirmation**.

| Item                                        | Explanation                                                                                                                                                        |
|---------------------------------------------|--------------------------------------------------------------------------------------------------------------------------------------------------------------------|
| Print Configuration Status Sheet            | Prints a sheet showing the current printer settings and installed options. This sheet can be useful to confirm whether option have been installed correctly.       |
| Print Supplies Status Sheet                 | Prints a sheet showing information about consumables.                                                                                                              |
| Print Usage History Sheet                   | Prints a sheet showing the history of the printer's usage.                                                                                                         |
| Reserve Job List (AL-M320DN/AL-M310DN only) | Prints a list of reserved print jobs stored on the printer's memory.<br>This item is available only when the jobs are stored by using the Quick Print Job feature. |

## Getting to Know Your Printer

| Item                 | Explanation                                                                                                                                         |
|----------------------|-----------------------------------------------------------------------------------------------------------------------------------------------------|
| Network Status Sheet | Prints a sheet showing the working status of the network.<br>This item is available only when the Network I/F setting in Network Menu is set to On. |
| PS3 Font List        | Prints a sample of the fonts available for your selected printer emulation.                                                                         |
| PCL Font Sample      |                                                                                                                                                     |
| ESCP2 Font Sample    |                                                                                                                                                     |
| FX Font Sample       |                                                                                                                                                     |
| I239X Font Sample    |                                                                                                                                                     |

## Machine Status

**Note:**

To use EpsonNet Config with a web browser to do settings, access **Information > System > Machine status**.

| Item                                               | Explanation                                                                                                                                                                                       |
|----------------------------------------------------|---------------------------------------------------------------------------------------------------------------------------------------------------------------------------------------------------|
| Toner                                              | The number of asterisks (*) between "E" and "F" indicates the remaining service lives of replacement parts. If a non-genuine replacement part is used, "?" is displayed instead of the indicator. |
| Fuser Unit Life (AL-M320DN only)                   |                                                                                                                                                                                                   |
| Maintenance Unit A Life (AL-M320DN/AL-M310DN only) |                                                                                                                                                                                                   |
| Maintenance Unit B Life (AL-M320DN/AL-M310DN only) |                                                                                                                                                                                                   |
| Total Pages                                        | Displays the total number of pages printed by the printer.                                                                                                                                        |

---

## Quick Print JobMenu (AL-M320DN/AL-M310DN only)

This menu allows you to print or delete print jobs that were stored in the printer's memory using the Quick Print Job feature (Re-Print Job, Verify Job) of the printer driver's Reserve Job function. For instructions on using this menu, see ["Using the Reserve Job function \(AL-M320DN/AL-M310DN\)" on page 56](#).

---

## ConfidentialJobMenu (AL-M320DN/AL-M310DN only)

This menu allows you to print or delete print jobs stored in the printer's memory using the Confidential Job feature of the printer driver's Reserve Job function. You need to enter the correct password to access this data. For instructions on using this menu, see ["Using the Reserve Job function \(AL-M320DN/AL-M310DN\)" on page 56](#).

## Getting to Know Your Printer

---

## Common Settings

### Setup Menu

**Note:**

To use EpsonNet Config with a web browser to do settings, access **Configuration > Common Settings > Setup Menu**.

| Item                                          | Explanation                                                                                                                                                                                                                                                                                                                                                                          |
|-----------------------------------------------|--------------------------------------------------------------------------------------------------------------------------------------------------------------------------------------------------------------------------------------------------------------------------------------------------------------------------------------------------------------------------------------|
| I/F Time Out                                  | Specifies the length of the time, in seconds, before a time out when interfaces are being switched automatically. The time before a time out occurs is the length of time from the point when no data is being received from an interface until the point of switching the interface. If the printer has a print job when switching the interface, the printer prints the print job. |
|                                               | Settings (default in bold):<br>0, 5 ... <b>60</b> ... 300 in increments of 1                                                                                                                                                                                                                                                                                                         |
| MP Tray Priority                              | This setting determines whether the MP tray has the highest or lowest priority when Auto is selected as the Paper Source setting in the printer driver. When <b>Normal</b> (default) is selected as the MP Tray Priority, the MP tray has the highest priority as the paper source. If you select <b>Last</b> , the MP tray has the lowest priority.                                 |
| Cassette Order (AL-M320DN/<br>AL-M310DN only) | Specifies the cassette order for feeding paper when the setting for the printer driver's Paper Source is Auto Select.                                                                                                                                                                                                                                                                |
|                                               | Settings:<br><b>Top&gt;Bottom</b> , Bottom>Top                                                                                                                                                                                                                                                                                                                                       |
| Manual Feed                                   | Allows you to select the manual feed mode for the MP tray.                                                                                                                                                                                                                                                                                                                           |
|                                               | Settings (default in bold):<br><b>Off</b> , 1st Page, EachPage                                                                                                                                                                                                                                                                                                                       |
| Copies                                        | Designates the number of copies to be printed, from 1 through 999.                                                                                                                                                                                                                                                                                                                   |
| Duplex                                        | Turns duplex printing on or off. This allows you to print on both sides of a page. For the paper sizes for which duplex printing is available, see <a href="#">"Available Paper and Capacities" on page 39</a> .                                                                                                                                                                     |
|                                               | Settings (default in bold):<br>Off, <b>On</b>                                                                                                                                                                                                                                                                                                                                        |
| Binding                                       | Specifies the binding direction of the printout. For the paper sizes for which duplex printing is available, see <a href="#">"Available Paper and Capacities" on page 39</a> .                                                                                                                                                                                                       |
|                                               | Settings (default in bold):<br><b>Long Edge</b> , Short Edge                                                                                                                                                                                                                                                                                                                         |

## Getting to Know Your Printer

| Item            | Explanation                                                                                                                                                                                                                                                                                                                                                                                                                                                                                                                                                                                                                                                                                                                                                                                                                                                                                                                              |
|-----------------|------------------------------------------------------------------------------------------------------------------------------------------------------------------------------------------------------------------------------------------------------------------------------------------------------------------------------------------------------------------------------------------------------------------------------------------------------------------------------------------------------------------------------------------------------------------------------------------------------------------------------------------------------------------------------------------------------------------------------------------------------------------------------------------------------------------------------------------------------------------------------------------------------------------------------------------|
| Start Page      | <p>Specifies whether duplex printing starts from the front or back of the page.</p> <p>For the paper sizes for which duplex printing is available, see <a href="#">“Available Paper and Capacities” on page 39</a>.</p>                                                                                                                                                                                                                                                                                                                                                                                                                                                                                                                                                                                                                                                                                                                  |
|                 | <p>Settings (default in bold):</p> <p><b>Front</b>, Back</p>                                                                                                                                                                                                                                                                                                                                                                                                                                                                                                                                                                                                                                                                                                                                                                                                                                                                             |
| Skip Blank Page | <p>Enables you to skip blank pages when printing.</p> <p>This function is available only for ESCP2, FX, or I239X mode.</p>                                                                                                                                                                                                                                                                                                                                                                                                                                                                                                                                                                                                                                                                                                                                                                                                               |
|                 | <p>Settings (default in bold):</p> <p><b>Off</b>, On</p>                                                                                                                                                                                                                                                                                                                                                                                                                                                                                                                                                                                                                                                                                                                                                                                                                                                                                 |
| Auto Eject Page | <p>Specifies whether or not to eject paper when the limit specified in the I/F Time Out setting is reached. The default is <b>Off</b>, which means paper is not ejected when the time-out limit is reached.</p> <p>This function is not available in PS3 and PCL.</p>                                                                                                                                                                                                                                                                                                                                                                                                                                                                                                                                                                                                                                                                    |
|                 | <p>Settings (default in bold):</p> <p><b>Off</b>, On</p>                                                                                                                                                                                                                                                                                                                                                                                                                                                                                                                                                                                                                                                                                                                                                                                                                                                                                 |
| Size Ignore     | <p>If you want to ignore a paper size error, select <b>On</b>. When you turn this item on, the printer keeps printing even if the image size exceeds the printable area for the specified paper size. This may cause smudges because of the toner that is not transferred onto the paper properly. When this item is turned off, the printer stops printing if a paper size error occurs.</p>                                                                                                                                                                                                                                                                                                                                                                                                                                                                                                                                            |
|                 | <p>Settings (default in bold):</p> <p><b>Off</b>, On</p>                                                                                                                                                                                                                                                                                                                                                                                                                                                                                                                                                                                                                                                                                                                                                                                                                                                                                 |
| Auto Cont       | <p>When you turn this setting on, the printer automatically continues printing after a certain period of time when one of the following errors occurs: <b>Set Paper</b>, <b>Print Overrun</b>, or <b>Memory Overflow</b>. When this option is off, you must press the <b>OK</b> button to resume printing.</p>                                                                                                                                                                                                                                                                                                                                                                                                                                                                                                                                                                                                                           |
|                 | <p>Settings (default in bold):</p> <p><b>Off</b>, On</p>                                                                                                                                                                                                                                                                                                                                                                                                                                                                                                                                                                                                                                                                                                                                                                                                                                                                                 |
| Page Protect    | <p>Allocates additional printer memory for printing data, as opposed to receiving it. You may need to turn this setting on if you are printing a very complex page. If a <b>Print Overrun</b> error message appears on the LCD panel (AL-M320DN/AL-M310DN), or on the computer screen while printing, turn this setting on and reprint your data. This reduces the amount of memory reserved for processing data so your computer may take longer to send the print job, but it will allow you to print complex jobs. <b>Page Protect</b> usually works best when <b>Auto</b> is selected.</p> <p><b>Note:</b></p> <ul style="list-style-type: none"> <li><input type="checkbox"/> <i>Changing the <b>Page Protect</b> setting reconfigures the printer's memory, which causes any downloaded fonts to be deleted.</i></li> <li><input type="checkbox"/> <i>This function is available only for ESCP2, FX, or I239X mode.</i></li> </ul> |
|                 | <p>Settings (default in bold):</p> <p><b>Auto</b>, On</p>                                                                                                                                                                                                                                                                                                                                                                                                                                                                                                                                                                                                                                                                                                                                                                                                                                                                                |

## Getting to Know Your Printer

| Item                                      | Explanation                                                                                                                                                                                                                                                                                                                                                                                                                                                                                                                                                                                                                                                                                                                                                                    |
|-------------------------------------------|--------------------------------------------------------------------------------------------------------------------------------------------------------------------------------------------------------------------------------------------------------------------------------------------------------------------------------------------------------------------------------------------------------------------------------------------------------------------------------------------------------------------------------------------------------------------------------------------------------------------------------------------------------------------------------------------------------------------------------------------------------------------------------|
| A4/LT Auto Switching                      | <p>If <b>LT-&gt;A4</b> (or <b>A4-&gt;LT</b>) is selected, if letter (or A4) size paper is selected for printing but there is no paper source set to letter (or A4), the printout is output on A4 (or Letter).</p> <p>If <b>A4&lt;-&gt;LT</b> is selected, if A4 or letter size paper is selected for printing but there is no paper source set to the selected paper size, the printout is output on the alternate paper size. (A4 for letter or letter for A4)</p> <p>Settings (default in bold):<br/> <b>LT-&gt;A4</b>, A4-&gt;LT, A4&lt;-&gt;LT, Off</p>                                                                                                                                                                                                                    |
| LCD Contrast (AL-M320DN/<br>AL-M310DN)    | <p>Adjusts the contrast of the LCD panel. Use the <b>▲ Up</b> and <b>▼ Down</b> buttons to set the contrast between <b>0</b> (lowest contrast) and <b>15</b> (highest contrast).</p> <p>Settings (default in bold):<br/> <b>0 ... 7 ... 15</b></p>                                                                                                                                                                                                                                                                                                                                                                                                                                                                                                                             |
| LCD Backlight (AL-M320DN/<br>AL-M310DN)   | <p>If <b>Auto</b> is selected, the LCD backlight lights. Also, it turns off during Deep Sleep Mode. If <b>Off</b> is selected, the LCD backlight is always off.</p> <p>Settings (default in bold):<br/> <b>Auto</b>, Off</p>                                                                                                                                                                                                                                                                                                                                                                                                                                                                                                                                                   |
| RAM Disk (AL-M320DN/<br>AL-M310DN)        | <p>Specifies the RAM disk size available for the Reserve Job function.</p> <p>After this item is changed, the setting value takes effect after a warm boot or after the power is turned on again.</p> <p>Settings (default in bold):<br/> <b>Off</b>, Normal, Maximum</p>                                                                                                                                                                                                                                                                                                                                                                                                                                                                                                      |
| Convert to Simplex                        | <p>In the duplex printing mode, specifies whether to print the last page of a job in one side printing mode. Setting <b>Odd Page</b> or <b>1 Page</b> can prevent the last page from being printed on an unexpected page when you are printing on preprinted paper or hole-punched paper.</p> <ul style="list-style-type: none"> <li><input type="checkbox"/> <b>Odd Page</b>: 1-page jobs or the last page of a job with an odd number of pages are printed in one side printing mode.</li> <li><input type="checkbox"/> <b>1 Page</b>: 1-page jobs are printed in one side printing mode.</li> <li><input type="checkbox"/> <b>Off</b>: The last page of all jobs (including 1-page jobs or jobs with an odd number of pages) is printed in duplex printing mode.</li> </ul> |
| Confirm Media Type                        | <p>Displays a message when the paper type in the tray selected for printing is different from that selected on Paper Type in the printer driver.</p> <p>Settings (default in bold):<br/> <b>No</b>, Yes</p>                                                                                                                                                                                                                                                                                                                                                                                                                                                                                                                                                                    |
| Cassette Warning<br>(AL-M320DN/AL-M310DN) | <p>Sets whether to display messages in the following situations when cassettes have been added.</p> <ul style="list-style-type: none"> <li>- No cassette other than the lowest tray is inserted</li> <li>- A cassette other than the lowest tray has run out of paper</li> </ul> <ul style="list-style-type: none"> <li><input type="checkbox"/> <b>Off</b>: Does not display</li> <li><input type="checkbox"/> <b>Warning</b>: Indicates that there is no paper</li> <li><input type="checkbox"/> <b>Warning &amp; Error</b>: First, a message indicating to check the conditions of the cassettes appears. When the print data is received, it shows that the cassette has been pulled out, and the printer stops operating.</li> </ul>                                      |

## Getting to Know Your Printer

| Item                                | Explanation                                                                                                                                                                                                                                                                                                                                                                                                                                                                                                                                                                                                                                                                                                                                                                                                                                                         |
|-------------------------------------|---------------------------------------------------------------------------------------------------------------------------------------------------------------------------------------------------------------------------------------------------------------------------------------------------------------------------------------------------------------------------------------------------------------------------------------------------------------------------------------------------------------------------------------------------------------------------------------------------------------------------------------------------------------------------------------------------------------------------------------------------------------------------------------------------------------------------------------------------------------------|
| Job Information (M320DN/<br>M310DN) | <p>Selects the pattern in which the job information is displayed on the control panel. If <b>Off</b> is selected, no job information is displayed on the control panel, even if the <b>Pause/Release</b> button is pressed to cancel or skip a job.</p> <p>If <b>Norsk</b>, <b>CATALÀ</b>, <b>РУССКИЙ</b>, <b>Türkçe</b>, <b>中文</b>, <b>繁體中文</b>, or <b>한국어</b> is selected as <b>Language</b> when the printer is turned on for the first time after you purchase it, the default value is <b>Off</b>. If other language is selected, the default value is <b>Display Pattern 1</b>.</p> <p>Do not select <b>Display Pattern 1</b> when the following languages are selected as <b>Language</b>: <b>Norsk</b>, <b>CATALÀ</b>, <b>РУССКИЙ</b>, <b>Türkçe</b>, <b>中文</b>, <b>繁體中文</b>, <b>한국어</b></p> <p>Settings:<br/>Display Pattern 1, Display Pattern 2, Off</p> |
| Local Time Diff.                    | <p>Specifies the current date and time by entering the time difference from Greenwich Mean time.</p> <p>Settings (default in bold):<br/>-14:00 ... <b>0:00</b> ... +14:00</p>                                                                                                                                                                                                                                                                                                                                                                                                                                                                                                                                                                                                                                                                                       |
| Time Setting                        | <p>Specifies the current date and time by entering them directly.</p> <p>Settings:<br/>2010/ 01/01 00:00 to 2098/12/31 23:59</p>                                                                                                                                                                                                                                                                                                                                                                                                                                                                                                                                                                                                                                                                                                                                    |
| Date Format                         | <p>Specifies the format to display the date.</p> <p>Settings (default in bold):<br/><b>DD/MM/YY</b>, MM/DD/YY, YY/MM/DD</p>                                                                                                                                                                                                                                                                                                                                                                                                                                                                                                                                                                                                                                                                                                                                         |

## USB Menu

### Note:

- After any item in the menu is changed, the setting takes effect after a warm boot or after the power is turned on again. While it is reflected in the Status Sheet, the actual change takes effect after a warm boot or after the power is turned on again.
- To use EpsonNet Config with a web browser to do settings, access **Configuration > Common Settings > USB Menu**.

| Item      | Explanation                                                                                                                                                                                                                    |
|-----------|--------------------------------------------------------------------------------------------------------------------------------------------------------------------------------------------------------------------------------|
| USB I/F   | <p>Allows you to activate or deactivate the USB interface.</p> <p>Settings (default in bold):<br/><b>On</b>, Off</p>                                                                                                           |
| USB Speed | <p>Allows you to select the operation mode of USB interface. Selecting <b>HS</b> is recommended. Select <b>FS</b> if <b>HS</b> does not work on your computer system.</p> <p>Settings (default in bold):<br/><b>HS</b>, FS</p> |



## Getting to Know Your Printer

| Item        | Explanation                                                                                                                                                                                                                                                                                                                                                                                                                                                                                                                                |
|-------------|--------------------------------------------------------------------------------------------------------------------------------------------------------------------------------------------------------------------------------------------------------------------------------------------------------------------------------------------------------------------------------------------------------------------------------------------------------------------------------------------------------------------------------------------|
| Buffer Size | <p>Determines the amount of memory to be used for receiving data and printing data.</p> <p><b>Note:</b></p> <ul style="list-style-type: none"> <li><input type="checkbox"/> To activate Buffer Size settings, you must turn off the printer for more than five seconds then turn it back on. Or, you can perform a Reset All operation, as explained in Reset Menu.</li> <li><input type="checkbox"/> Resetting the printer erases all print jobs. Make sure the <b>Ready</b> light is not flashing when you reset the printer.</li> </ul> |
|             | <p>Settings (default in bold):</p> <p><b>Normal</b>, Maximum, Minimum</p>                                                                                                                                                                                                                                                                                                                                                                                                                                                                  |

## Network Menu

See the *Network Guide* for each setting.

|                                                                                                                                                                                                                                                                                                                                                                                                                                                                                                                                                                                                                                                                                                                 |
|-----------------------------------------------------------------------------------------------------------------------------------------------------------------------------------------------------------------------------------------------------------------------------------------------------------------------------------------------------------------------------------------------------------------------------------------------------------------------------------------------------------------------------------------------------------------------------------------------------------------------------------------------------------------------------------------------------------------|
| <p><b>Note:</b></p> <ul style="list-style-type: none"> <li><input type="checkbox"/> In order to do IP address settings for AL-M220DN's first setup, you must install EpsonNet Config for Windows or for Mac OS X. Note that you cannot do IP address settings using EpsonNet Config on a web browser for the first setup. For details, see the IP Address and Password Setup Sheet, and Network Guide.</li> <li><input type="checkbox"/> After any item in the menu is changed, the setting takes effect after a warm boot or after the power is turned on again. While it is reflected in the Status Sheet, the actual change takes effect after a warm boot or after the power is turned on again.</li> </ul> |
|-----------------------------------------------------------------------------------------------------------------------------------------------------------------------------------------------------------------------------------------------------------------------------------------------------------------------------------------------------------------------------------------------------------------------------------------------------------------------------------------------------------------------------------------------------------------------------------------------------------------------------------------------------------------------------------------------------------------|

## Energy Saver Menu

|                                                                                                                                                               |
|---------------------------------------------------------------------------------------------------------------------------------------------------------------|
| <p><b>Note:</b></p> <p>To use EpsonNet Config with a web browser to do settings, access <b>Configuration &gt; Common Settings &gt; Energy Saver Menu</b>.</p> |
|---------------------------------------------------------------------------------------------------------------------------------------------------------------|

| Item                | Explanation                                                                                                                                                                                                                                                                                                                                                 |
|---------------------|-------------------------------------------------------------------------------------------------------------------------------------------------------------------------------------------------------------------------------------------------------------------------------------------------------------------------------------------------------------|
| Time to Sleep(Auto) | <p>When this setting is set to <b>Enable</b>, the printer automatically determines the time to enter the deep sleep mode, based on the operation history of the printer. Note if <b>Enable</b> is selected, the <b>Time to Sleep</b> and <b>Eco Fuser</b> settings are ignored.</p> <p>Settings (default in bold):</p> <p><b>Enable</b>, <b>Disable</b></p> |
| Time to Sleep       | <p>Specifies the length of the time until the printer enters the deep sleep mode if there are no button operations and no jobs to be printed.</p> <p>Settings (default in bold):</p> <p><b>0Min</b>*, 1Min, 3Min, 5Min, 15Min, 30Min, 60Min, 120Min</p> <p>* The default setting is 1Min for some products.</p>                                             |

## Getting to Know Your Printer

| Item                                   | Explanation                                                                                                                                                                                                                                                                                                                                                                                                                                                                                                                                                                                                                          |
|----------------------------------------|--------------------------------------------------------------------------------------------------------------------------------------------------------------------------------------------------------------------------------------------------------------------------------------------------------------------------------------------------------------------------------------------------------------------------------------------------------------------------------------------------------------------------------------------------------------------------------------------------------------------------------------|
| Power Off If Inactive (Power Off mode) | <p>When this setting is set to <b>On</b>, the printer automatically turns off at the time specified in the <b>Time to Off</b> setting. If <b>EU</b> is selected as <b>Region Settings</b> when the printer is turned on for the first time after you purchase it, the default value is <b>On</b>. If some other region is selected, the default value is set to <b>Off</b>.</p> <p><b>Note:</b><br/>The printer does not enter the power off mode if it is receiving or sending data.<br/>The printer recovers from the power off mode when the power switch is turned on.</p> <p>Settings (default in bold):<br/><b>On, Off</b></p> |
| Time to Off (Inactive)                 | <p>Specifies the length of the time until the printer enters the power off mode if there are no button operations and no jobs to be printed.</p> <p><b>Note:</b><br/>You can adjust the time before power management is applied. Any increase will affect the product's energy efficiency. Please consider the environment before making any change.</p> <p>Settings:<br/>120Min, 180Min, 240Min, 360Min, <b>480Min</b></p>                                                                                                                                                                                                          |
| Power Off If Disconnect                | <p>When these settings are enabled, the printer enters power off mode when it detects that no interfaces have been in use for over 30 minutes.</p> <p>States in which interfaces are unavailable are:</p> <ul style="list-style-type: none"> <li>- When a cable is not connected to the interface</li> <li>- When panel settings do not use interfaces</li> <li>- When the hub and connected computers are off</li> </ul> <p>Settings:<br/><b>On, Off</b></p>                                                                                                                                                                        |

## Sleep Schedule Menu

**Note:**

You need to use *EpsonNet Config* with a web browser to reset the history, because this item is not displayed on the control panel. See the *Network Guide* for the procedure to access *EpsonNet Config* with a web browser.

| Item                  | Explanation                                                                                                                                                                                                                                                                                                                                                                                                                                                                                                                                                |
|-----------------------|------------------------------------------------------------------------------------------------------------------------------------------------------------------------------------------------------------------------------------------------------------------------------------------------------------------------------------------------------------------------------------------------------------------------------------------------------------------------------------------------------------------------------------------------------------|
| Reset Operate History | Resets the printer's operation history, which is based on the <b>Time to Sleep(Auto)</b> calculation.                                                                                                                                                                                                                                                                                                                                                                                                                                                      |
| Sleep Schedule        | <p>Sets a start time and a sleep pattern for up to five time periods through the day. The <b>Sleep Pattern</b> options are as follows:</p> <ul style="list-style-type: none"> <li><input type="checkbox"/> <b>On:</b> Enters deep sleep mode according to the <b>Time to Sleep(Auto)</b> or <b>Time to Sleep</b> settings.</li> <li><input type="checkbox"/> <b>Quick:</b> Enters deep sleep mode as soon as possible.</li> </ul> <p><b>Note:</b><br/>For an image of these settings, see <a href="#">"Making a weekly sleep schedule"</a> on page 59.</p> |

## Getting to Know Your Printer

| Item         | Explanation                                                                                                                                                                                                                                                                                          |
|--------------|------------------------------------------------------------------------------------------------------------------------------------------------------------------------------------------------------------------------------------------------------------------------------------------------------|
| Excluded Day | Specifies a special date on which to apply the sleep pattern for some other day, and specifies the day for up to two days. Each specified date setting is valid once within the each coming specified date.                                                                                          |
| Sleep Status | Displays the status of the sleep settings for one week starting from the current day. For example, after <code>Time to Sleep(Auto)</code> is set to <code>Enable</code> , you can check if each time-to-sleep value, based on the operation history, has been calculated or is still being prepared. |

## Reset Menu

| Item                        | Explanation                                                                                                                                                                                                                                                                                                                                                                                                          |
|-----------------------------|----------------------------------------------------------------------------------------------------------------------------------------------------------------------------------------------------------------------------------------------------------------------------------------------------------------------------------------------------------------------------------------------------------------------|
| Clear Warning               | Clears warnings except for those that occur from consumable products or mandatory-replacement parts.                                                                                                                                                                                                                                                                                                                 |
| Clear All Warnings          | Clears all warnings that are shown on the LCD panel or by LED lights.                                                                                                                                                                                                                                                                                                                                                |
| Reset All                   | Stops printing and clears the printer memory. The print jobs received from all interfaces are erased. Also resets the life counters for maintenance units A and B.<br><br><b>Note:</b><br><i>Performing <code>Reset All</code> clears print jobs received from all interfaces. Be careful not to interrupt someone else's job.</i>                                                                                   |
| Reset Maintenance A Counter | Reset the maintenance unit life counter when you replace the maintenance unit. For instructions on replacing the maintenance unit, see the documentation supplied with the maintenance unit.<br><br><b>Note:</b><br><i>After Performing <code>Reset Maintenance Counter A</code> or <code>Reset Maintenance Counter B</code>, the printer reboots automatically. Be careful not to interrupt someone else's job.</i> |
| Reset Maintenance B Counter |                                                                                                                                                                                                                                                                                                                                                                                                                      |

---

## Printer Settings

|                                                                                                                                                                                                                                                                                                                                                                                                                               |
|-------------------------------------------------------------------------------------------------------------------------------------------------------------------------------------------------------------------------------------------------------------------------------------------------------------------------------------------------------------------------------------------------------------------------------|
| <p><b>Note:</b></p> <ul style="list-style-type: none"> <li><input type="checkbox"/> The settings in the <code>Printing Menu</code> are overridden by the settings done in the printer driver from the <code>Printing Preferences</code>.</li> <li><input type="checkbox"/> You can also set items in <code>Printing Menu</code> from <code>Printer Properties &gt; Optional Settings &gt; Printer Settings</code>.</li> </ul> |
|-------------------------------------------------------------------------------------------------------------------------------------------------------------------------------------------------------------------------------------------------------------------------------------------------------------------------------------------------------------------------------------------------------------------------------|

## Tray Menu

| Item                                        | Explanation                                                                                                                                                                                                                                                                                                                                                                 |
|---------------------------------------------|-----------------------------------------------------------------------------------------------------------------------------------------------------------------------------------------------------------------------------------------------------------------------------------------------------------------------------------------------------------------------------|
| Paper Size Warning<br>(AL-M320DN/AL-M310DN) | Specifies the trays that need a message to confirm that the paper size in the tray matches the settings on the control panel. This warning message is displayed on the control panel when you load paper in the MP tray and when you close a paper cassette.<br><br>Settings (default in bold):<br><b>Off</b> , <b>Cassette</b> , <b>Cassette &amp; MP</b> , <b>MP Tray</b> |

## Getting to Know Your Printer

| Item                                                                                                   | Explanation                                                                                                                                                                          |
|--------------------------------------------------------------------------------------------------------|--------------------------------------------------------------------------------------------------------------------------------------------------------------------------------------|
| Size Warning Timeout<br>(AL-M320DN/AL-M310DN)                                                          | Specify the length of the time until the Paper Size Warning message is turned off.                                                                                                   |
|                                                                                                        | Settings (default in bold):<br>5 sec, <b>10 sec</b>                                                                                                                                  |
| MP Tray Size                                                                                           | Specifies the paper size loaded in MP Tray.<br>For the sizes of paper that are available, refer to <a href="#">“Available Paper and Capacities” on page 39</a> .                     |
| MP Tray Type                                                                                           | Specifies the paper type loaded in the MP tray.<br>For the types of paper that are available, refer to <a href="#">“Available Paper and Capacities” on page 39</a> .                 |
| Cassette1 Size                                                                                         | Specifies the paper size loaded in the standard paper cassette.<br>For the sizes of paper that are available, refer to <a href="#">“Available Paper and Capacities” on page 39</a> . |
| Cassette1 Type                                                                                         | Specifies the paper type loaded in the standard paper cassette.<br>For the types of paper that are available, refer to <a href="#">“Available Paper and Capacities” on page 39</a> . |
| Cassette2 Size/Cassette3 Size<br>(AL-M320DN/AL-M310DN only)                                            | Specifies the paper size loaded in the optional paper cassette.<br>For the sizes of paper that are available, refer to <a href="#">“Available Paper and Capacities” on page 39</a> . |
| Cassette2 Type/Cassette3 Type<br>(AL-M320DN/AL-M310DN only)                                            | Specifies the paper type loaded in the optional paper cassette.<br>For the types of paper that are available, refer to <a href="#">“Available Paper and Capacities” on page 39</a> . |
| MP Tray AutoSel/Cassette1 AutoSel/Cassette2 AutoSel*/ Cassette3 AutoSel*<br>* AL-M320DN/AL-M310DN only | Specifies whether the tray can be selected for printing when Paper Source is selected for Auto Selection in the printer driver.                                                      |
|                                                                                                        | Settings (default in bold):<br><b>On</b> , Off                                                                                                                                       |



## Printing Menu

| Item      | Explanation                                                                                                                                                                                                                                            |
|-----------|--------------------------------------------------------------------------------------------------------------------------------------------------------------------------------------------------------------------------------------------------------|
| Page Size | Specifies the paper size.                                                                                                                                                                                                                              |
|           | Settings (default in bold):<br><b>A4</b> , A5, A6, B5, LT, HLT, LGL, GLT, GLG, EXE, F4, MON, C10, DL, C5, C6, IB5, CTM*<br>* For the sizes of paper that are available for CTM, refer to <a href="#">“Available Paper and Capacities” on page 39</a> . |
| Wide A4   | Selecting <b>On</b> decreases the left and right margins to 3.4 mm.                                                                                                                                                                                    |
|           | Settings (default in bold):<br><b>Off</b> , On                                                                                                                                                                                                         |

## Getting to Know Your Printer

| Item                 | Explanation                                                                                                                                                                                                                                                                                                                                                                           |
|----------------------|---------------------------------------------------------------------------------------------------------------------------------------------------------------------------------------------------------------------------------------------------------------------------------------------------------------------------------------------------------------------------------------|
| Media Type           | Specifies the paper type.                                                                                                                                                                                                                                                                                                                                                             |
|                      | Settings (default in bold):<br><b>Unspecified</b> , Plain, SemiThk, Preprinted, Letterhead, Recycled, Color, Transparency, Labels, Thick, ExtraThk, SuperThk, Thin, Envelope, Special                                                                                                                                                                                                 |
| Page Side            | Specifies 2-sided printing manually. Select <b>Back</b> when printing on the back side of the paper.                                                                                                                                                                                                                                                                                  |
|                      | Settings (default in bold):<br><b>Front</b> , Back                                                                                                                                                                                                                                                                                                                                    |
| Paper Source         | Specifies whether paper feeds into the printer from the MP tray, the standard paper cassette (Cassette 1), or the optional paper cassette unit (Cassette 2/3/4/5).<br>If you select <b>Auto</b> , paper feeds from the paper source containing paper that matches your <b>Paper Size</b> setting.                                                                                     |
|                      | Settings (default in bold):<br><b>Auto</b> , MP Tray, Cassette1, Cassette2*, Cassette3*<br>* For AL-M320DN/AL-M310DN only                                                                                                                                                                                                                                                             |
| Orientation          | Specifies whether the page is printed in portrait or landscape orientation.                                                                                                                                                                                                                                                                                                           |
|                      | Settings (default in bold):<br><b>Port</b> , Land                                                                                                                                                                                                                                                                                                                                     |
| Resolution           | Specifies the printing resolution.                                                                                                                                                                                                                                                                                                                                                    |
|                      | Settings (default in bold):<br>300, <b>600</b> , 1200                                                                                                                                                                                                                                                                                                                                 |
| RITech               | Turning on RITech (Resolution Improvement Technology) on produces smoother and crisper lines, text, and graphics.                                                                                                                                                                                                                                                                     |
|                      | Settings (default in bold):<br><b>On</b> , Off                                                                                                                                                                                                                                                                                                                                        |
| Toner Save           | When this setting is selected, the printer saves toner by substituting a gray shade for the black inside of characters. The characters are outlined in full black on the right and lower edges.                                                                                                                                                                                       |
|                      | Settings (default in bold):<br><b>Off</b> , On                                                                                                                                                                                                                                                                                                                                        |
| Density              | Specifies the printing density. The printout becomes darker as the value increases.                                                                                                                                                                                                                                                                                                   |
|                      | Settings (default in bold):<br>1, 2, <b>3</b> , 4, 5                                                                                                                                                                                                                                                                                                                                  |
| Emphasize Thin Lines | Adjusts the weight of thin lines so they are printed clearly. The correction results differ depending on the application software.<br><b>More:</b> Makes thin lines even easier to see (thickens them) than Emphasize, and then prints them<br><b>Emphasize:</b> Makes thin lines easier to see (thickens them), and then prints<br><b>Off:</b> Prints without emphasizing thin lines |

## Getting to Know Your Printer

| Item           | Explanation                                                                                                                                                                                                                                                                                                    |
|----------------|----------------------------------------------------------------------------------------------------------------------------------------------------------------------------------------------------------------------------------------------------------------------------------------------------------------|
| Top Offset     | Makes fine adjustments to the vertical printing position of the page.<br> <b>Important:</b><br><i>Make sure that the printed image does not extend beyond the edge of the paper. Otherwise, you may damage the printer.</i>   |
|                | Settings (default in bold):<br>-99.0 ... <b>0.0</b> ... 99.0 mm in 0.5 mm increments                                                                                                                                                                                                                           |
| Left Offset    | Makes fine adjustments to the horizontal printing position of the page.<br> <b>Important:</b><br><i>Make sure that the printed image does not extend beyond the edge of the paper. Otherwise, you may damage the printer.</i> |
|                | Settings (default in bold):<br>-99.0 ... <b>0.0</b> ... 99.0 mm in 0.5 mm increments                                                                                                                                                                                                                           |
| T Offset B     | Adjusts the vertical printing position on the back of the paper when printing on both sides. Use this if the printout on the back is not where you expected.                                                                                                                                                   |
|                | Settings (default in bold):<br>-99.0 ... <b>0.0</b> ... 99.0 mm in 0.5 mm increments                                                                                                                                                                                                                           |
| L Offset B     | Adjusts the horizontal printing position on the back of the paper when printing on both sides. Use this if the printout on the back is not where you expected.                                                                                                                                                 |
|                | Settings (default in bold):<br>-99.0 ... <b>0.0</b> ... 99.0 mm in 0.5 mm increments                                                                                                                                                                                                                           |
| Low Speed Mode | When this mode is selected, the printing speed is slow.<br>The slow printing is expected the following effects:<br><ul style="list-style-type: none"> <li>- improves the fixing failure.</li> <li>- lowers the mechanical sounds.</li> <li>- reduces feeding problems of the thick paper.</li> </ul>           |
|                | Settings (default in bold):<br><b>Off, On</b>                                                                                                                                                                                                                                                                  |

## Emulation Menu

| Item        | Explanation                                                            |
|-------------|------------------------------------------------------------------------|
| USB/Network | Specifies emulation mode for each interface.                           |
|             | Settings (default in bold):<br><b>Auto, ESCP2, FX, I239X, PS3, PCL</b> |

## Getting to Know Your Printer

## PCL Menu

| Item        | Explanation                                                                                                                                                                                                                                                                                                                                                                                                                                                                                                                                                                          |
|-------------|--------------------------------------------------------------------------------------------------------------------------------------------------------------------------------------------------------------------------------------------------------------------------------------------------------------------------------------------------------------------------------------------------------------------------------------------------------------------------------------------------------------------------------------------------------------------------------------|
| FontSource  | Sets the default font source.                                                                                                                                                                                                                                                                                                                                                                                                                                                                                                                                                        |
|             | Settings (default in bold):<br><b>Resident</b> , Download*<br>* Available only when downloaded fonts are available.                                                                                                                                                                                                                                                                                                                                                                                                                                                                  |
| Font Number | Sets the default font number for the default font source. The available number depends on the settings you made.                                                                                                                                                                                                                                                                                                                                                                                                                                                                     |
|             | Settings (default in bold):<br><b>0</b> ... 65535 (depending on your settings)                                                                                                                                                                                                                                                                                                                                                                                                                                                                                                       |
| Pitch       | Specifies the default font pitch if the font is scalable and of fixed-pitch. This item may not appear depending on the <code>FontSource</code> or <code>Font Number</code> settings.                                                                                                                                                                                                                                                                                                                                                                                                 |
|             | Settings (default in bold):<br><b>0.44</b> ... <b>10.00</b> ... 99.99 cpi in 0.01 cpi increment                                                                                                                                                                                                                                                                                                                                                                                                                                                                                      |
| Height      | Specifies the default font height if the font is scalable and proportional. This item may not appear depending on the <code>FontSource</code> or <code>Font Number</code> settings.                                                                                                                                                                                                                                                                                                                                                                                                  |
|             | Settings (default in bold):<br><b>4.00</b> ... <b>12.00</b> ... 999.75 pt in 0.25 pt increment                                                                                                                                                                                                                                                                                                                                                                                                                                                                                       |
| SymSet      | Selects the default symbol set. If the font you selected in <code>FontSource</code> and <code>Font Number</code> is not available in the new <code>SymSet</code> setting, the <code>FontSource</code> and the <code>Font Number</code> settings are automatically replaced with the default value, IBM-US.                                                                                                                                                                                                                                                                           |
|             | Settings (default in bold):<br><b>IBM-US</b> , Roman-8, Roman-9, ECM94-1, 8859-2 ISO, 8859-9 ISO, 8859-10 ISO, 8859-15 ISO, PcBlt775, IBM-DN, PcMultiling, PcE.Europe, PcTk437, PcEur858, Pc1004, WiAnsi, WiE.Europe, WiTurkish, WiBALT, DeskTop, PsText, VeInternati, VeUS, MsPublishin, Math-8, PsMath, VeMath, PiFont, Legal, UK, ANSI ASCII, Swedis2, Italian, Spanish, German, Norweg1, French2, Windows, McText, Hebrew7, 8859-8 ISO, Hebrew8, Arabic8, OCR A, OCR B, Pc866Cyr, Pc866Ukr, WinCyr, ISOCyr, Pc8Grk, Pc851Grk, WinGrk, ISOGrk, Greek8, Pc862Heb, Pc864Ara, HPWARA |
| Form        | Selects the number of lines for the selected paper size and orientation. This also causes a line spacing(VMI) change, and the new VMI value is stored in the printer. This means that later changes in the <code>Page Size</code> or <code>Orientation</code> settings cause changes in the <code>Form</code> value, based on the stored VMI.                                                                                                                                                                                                                                        |
|             | Settings (default in bold):<br><b>5</b> ... <b>64</b> ... 128Lines                                                                                                                                                                                                                                                                                                                                                                                                                                                                                                                   |
| CR Function | These functions are included for users of particular operating systems, such as UNIX.                                                                                                                                                                                                                                                                                                                                                                                                                                                                                                |
|             | Settings (default in bold):<br><b>CR</b> , CR+LF                                                                                                                                                                                                                                                                                                                                                                                                                                                                                                                                     |
| LF Function | These functions are included for users of particular operating systems, such as UNIX.                                                                                                                                                                                                                                                                                                                                                                                                                                                                                                |
|             | Settings (default in bold):<br><b>LF</b> , CR+LF                                                                                                                                                                                                                                                                                                                                                                                                                                                                                                                                     |

## Getting to Know Your Printer

| Item        | Explanation                                                                                                                                                                                                                                                                                                                    |
|-------------|--------------------------------------------------------------------------------------------------------------------------------------------------------------------------------------------------------------------------------------------------------------------------------------------------------------------------------|
| Tray Assign | Changes the assignment for the paper source select command. When 4 is selected, the commands are set as compatible with the HP LaserJet 4. When 4K is selected, the commands are set as compatible with the HP LaserJet 4000, 5000, and 8000. When 5S is selected, the commands are set as compatible with the HP LaserJet 5S. |
|             | Settings (default in bold):<br><b>4K, 5S, 4</b>                                                                                                                                                                                                                                                                                |

## PS3 Menu

| Item          | Explanation                                                                                                                                                                                                                                                                                                                                                                                                                                                                                                 |
|---------------|-------------------------------------------------------------------------------------------------------------------------------------------------------------------------------------------------------------------------------------------------------------------------------------------------------------------------------------------------------------------------------------------------------------------------------------------------------------------------------------------------------------|
| Error Sheet   | When you select <b>On</b> , the printer prints out an error sheet when an error occurs in the PS3 mode or when the PDF file you tried to print is not a supported version.                                                                                                                                                                                                                                                                                                                                  |
|               | Settings (default in bold):<br><b>Off, On</b>                                                                                                                                                                                                                                                                                                                                                                                                                                                               |
| Binary        | Specifies the data format. Select <b>On</b> for the Binary data and select <b>Off</b> for the ASCII data.<br><br><i><b>Note:</b><br/>Binary can only be used with network connection. To use the Binary data, make sure your application supports Binary data and that <b>SEND CTRL-D Before Each Job</b> and <b>SEND CTRL-D After Each Job</b> are set to <b>No</b>. When this setting is set to <b>On</b>, you cannot use TBCP (Tagged binary communication protocol) in the printer driver settings.</i> |
|               | Settings (default in bold):<br><b>Off, On</b>                                                                                                                                                                                                                                                                                                                                                                                                                                                               |
| PDF Page Size | Specifies the paper size when you send the PDF file directory from a computer or some other device. If <b>Auto</b> is selected, the paper size is determined based on the size of the first page that is printed.                                                                                                                                                                                                                                                                                           |
|               | Settings (default in bold):<br>Auto, <b>A4</b> , A5, A6, B5, LT, HLT, LGL, GLT, GLG, EXE, F4, MON, C10, DL, C5, C6, IB5                                                                                                                                                                                                                                                                                                                                                                                     |

## ESCP2 Menu

| Item  | Explanation                                                                                                                                             |
|-------|---------------------------------------------------------------------------------------------------------------------------------------------------------|
| Font  | Selects the font.                                                                                                                                       |
|       | Settings (default in bold):<br><b>Courier</b> , Prestige, Roman, Sans serif, Roman T, Orator S, Sans H, Script, OCR A, OCR B                            |
| Pitch | Selects the pitch (the horizontal spacing) of the font in fixed pitch, measured in cpi (characters per inch). You can also choose proportional spacing. |
|       | Settings (default in bold):<br><b>10cpi</b> , 12cpi, 15cpi, Prop.                                                                                       |



## Getting to Know Your Printer

| Item      | Explanation                                                                                                                                                                                                                                                                                                                                                                                                                                            |
|-----------|--------------------------------------------------------------------------------------------------------------------------------------------------------------------------------------------------------------------------------------------------------------------------------------------------------------------------------------------------------------------------------------------------------------------------------------------------------|
| Condensed | Turns condensed printing on or off.                                                                                                                                                                                                                                                                                                                                                                                                                    |
|           | Settings (default in bold):<br><b>Off</b> , On                                                                                                                                                                                                                                                                                                                                                                                                         |
| T.Margin  | Sets the distance from the top of the page to the baseline of the first printable line. The distance is measured in inches. The smaller the value, the closer the printable line is to the top.                                                                                                                                                                                                                                                        |
|           | Settings (default in bold):<br>0.40 ... <b>0.50</b> ... 1.50 inch in 0.05-inch increments                                                                                                                                                                                                                                                                                                                                                              |
| Text      | Sets the page length in lines. For this option, a line is assumed to be 1 pica (1/6 inch). If you change the <i>Orientation</i> , <i>Page Size</i> , or <i>T.Margin</i> settings, the page length setting automatically returns to the default for each paper size.                                                                                                                                                                                    |
|           | Settings (default in bold):<br>1 ... <b>66</b> Lines                                                                                                                                                                                                                                                                                                                                                                                                   |
| CGTable   | Use the character generator (CG) table option to select the graphics character table or the italics table. The graphics table contains graphic characters for printing lines, corners, shaded areas, international characters, Greek characters, and mathematical symbols. If you select <i>Italic</i> , the upper half of the character table is defined as italic characters.                                                                        |
|           | Settings (default in bold):<br><b>PcUSA</b> , Italic, PcMultilin, PcPortugue, PcCanFrenc, PcNordic, PcTurkish2, Pclcelandic, PcE.Europe, BpBRASCII, BpAbicomp, Roman-8, PcEur858, ISO Latin1, 8859-15 ISO, PcSI437, PcTurkish1, 8859-9 ISO, Mazowia, CodeMJK, PcGk437, PcGk851, PcGk869, 8859-7 ISO, PcCy855, PcCy866, PcUkr866, Pclit771, Bulgarian, Hebrew7, Hebrew8, PcHe862, PcAr864, PcAr864Ara, PcAr720, Pclit774, Estonia, ISO Latin2, Pclat866 |
| Country   | Use this option to select one of the fifteen international symbol sets. See the <i>Font Guide</i> for samples of the characters in each country's symbol set.                                                                                                                                                                                                                                                                                          |
|           | Settings (default in bold):<br><b>USA</b> , France, Germany, UK, Denmark, Sweden, Italy, Spain1, Japan, Norway, Denmark2, Spain2, LatinAmeric, Korea, Legal                                                                                                                                                                                                                                                                                            |
| Auto CR   | Specifies whether the printer performs a carriage-return/line-feed (CR-LF) operation whenever the printing position goes beyond the right margin. If you select <i>Off</i> , the printer does not print any characters beyond the right margin and does not perform any line wrapping until it receives carriage-return character. This function is handled automatically by most applications.                                                        |
|           | Settings (default in bold):<br><b>On</b> , Off                                                                                                                                                                                                                                                                                                                                                                                                         |
| Auto LF   | If you select <i>Off</i> , the printer does not send an automatic line-feed (LF) command with each carriage-return (CR). If <i>On</i> is selected, a line-feed command is sent with each carriage-return. Select <i>On</i> if your text lines overlap.                                                                                                                                                                                                 |
|           | Settings (default in bold):<br><b>Off</b> , On                                                                                                                                                                                                                                                                                                                                                                                                         |

## Getting to Know Your Printer

| Item      | Explanation                                                                                                                                                                                                                                                                                                                                          |
|-----------|------------------------------------------------------------------------------------------------------------------------------------------------------------------------------------------------------------------------------------------------------------------------------------------------------------------------------------------------------|
| Bit Image | The printer is able to emulate the graphics densities set with the printer commands. If you select <b>Dark</b> , the bit image density is high, and if you select <b>Light</b> , the bit image density is low.                                                                                                                                       |
|           | If you select <b>BarCode</b> , the printer converts bit images to bar codes by automatically filling in any vertical gaps between dots. This produces unbroken vertical lines that can be read by a bar code reader. This mode will reduce the size of the image being printed, and may also cause some distortion when printing bit image graphics. |
|           | Settings (default in bold):<br><b>Dark</b> , Light, BarCode                                                                                                                                                                                                                                                                                          |
| ZeroChar  | Specifies whether the printer prints a slashed or unslashed zero.                                                                                                                                                                                                                                                                                    |
|           | Settings (default in bold):<br><b>0</b> , (or the zero character with a slash)                                                                                                                                                                                                                                                                       |

## FX Menu

| Item      | Explanation                                                                                                                                                                                                                                                         |
|-----------|---------------------------------------------------------------------------------------------------------------------------------------------------------------------------------------------------------------------------------------------------------------------|
| Font      | Selects the font.                                                                                                                                                                                                                                                   |
|           | Settings (default in bold):<br><b>Courier</b> , Prestige, Roman, Sans serif, Script, Orator S, OCR A, OCR B                                                                                                                                                         |
| Pitch     | Selects the pitch (the horizontal spacing) of the font in fixed pitch, measured in cpi (characters per inch). You can also choose proportional spacing.                                                                                                             |
|           | Settings (default in bold):<br><b>10cpi</b> , 12cpi, 15cpi, Prop.                                                                                                                                                                                                   |
| Condensed | Turns condensed printing on or off.                                                                                                                                                                                                                                 |
|           | Settings (default in bold):<br><b>Off</b> , On                                                                                                                                                                                                                      |
| T.Margin  | Sets the distance from the top of the page to the baseline of the first printable line. The distance is measured in inches. The smaller the value, the closer the printable line is to the top.                                                                     |
|           | Settings (default in bold):<br>0.40 ... <b>0.50</b> ... 1.50 inch in 0.05-inch increments                                                                                                                                                                           |
| Text      | Sets the page length in lines. For this option, a line is assumed to be 1 pica (1/6 inch). If you change the <b>Orientation</b> , <b>Page Size</b> , or <b>T.Margin</b> settings, the page length setting automatically returns to the default for each paper size. |
|           | Settings (default in bold):<br>1 ... <b>66</b> Lines                                                                                                                                                                                                                |

## Getting to Know Your Printer

| Item      | Explanation                                                                                                                                                                                                                                                                                                                                                                                       |
|-----------|---------------------------------------------------------------------------------------------------------------------------------------------------------------------------------------------------------------------------------------------------------------------------------------------------------------------------------------------------------------------------------------------------|
| CGTable   | Use the character generator (CG) table option to select the graphics character table or the italics table. The graphics table contains graphic characters for printing lines, corners, shaded areas, international characters, Greek characters, and mathematical symbols. If you select <i>Italic</i> , the upper half of the character table is defined as italic characters.                   |
|           | Settings (default in bold):<br><b>PcUSA</b> , Italic, PcMultilin, PcPortugue, PcCanFrenc, PcNordic, PcTurkish2, Pclcelandic, PcE.Europe, BpBRASCII, BpAbicomp, Roman-8, PcEur858, ISO Latin1, 8859-15 ISO                                                                                                                                                                                         |
| Country   | Use this option to select one of the fifteen international symbol sets. See the <i>Font Guide</i> for samples of the characters in each country's symbol set.                                                                                                                                                                                                                                     |
|           | Settings (default in bold):<br><b>USA</b> , France, Germany, UK, Denmark, Sweden, Italy, Spain1, Japan, Norway, Denmark2, Spain2, LatinAmeric                                                                                                                                                                                                                                                     |
| Auto CR   | Specifies whether the printer performs a carriage-return/line-feed (CR-LF) operation whenever the printing position goes beyond the right margin. If you select <i>Off</i> , the printer does not print any characters beyond the right margin and does not perform any line wrapping until it receives a carriage-return character. This function is handled automatically by most applications. |
|           | Settings (default in bold):<br><b>On</b> , Off                                                                                                                                                                                                                                                                                                                                                    |
| Auto LF   | If you select <i>Off</i> , the printer does not send an automatic line-feed (LF) command with each carriage-return (CR). If <i>On</i> is selected, a line-feed command is sent with each carriage-return. Select <i>On</i> if your text lines overlap.                                                                                                                                            |
|           | Settings (default in bold):<br><b>Off</b> , On                                                                                                                                                                                                                                                                                                                                                    |
| Bit Image | The printer is able to emulate the graphics densities set with the printer commands. If you select <i>Dark</i> , the bit image density is high, and if you select <i>Light</i> , the bit image density is low.                                                                                                                                                                                    |
|           | If you select <i>BarCode</i> , the printer converts bit images to bar codes by automatically filling in any vertical gaps between dots. This produces unbroken vertical lines that can be read by a bar code reader. This mode will reduce the size of the image being printed, and may also cause some distortion when printing bit image graphics.                                              |
| ZeroChar  | Settings (default in bold):<br><b>Dark</b> , Light, BarCode                                                                                                                                                                                                                                                                                                                                       |
|           | Specifies whether the printer prints a slashed or unslashed zero.                                                                                                                                                                                                                                                                                                                                 |
| ZeroChar  | Settings (default in bold):<br><b>0</b> , (or the zero character with a slash)                                                                                                                                                                                                                                                                                                                    |

## I239X Menu

| Item | Explanation                                                                                             |
|------|---------------------------------------------------------------------------------------------------------|
| Font | Selects the font.                                                                                       |
|      | Settings (default in bold):<br><b>Courier</b> , Prestige, Gothic, Orator, Script, Presentor, Sans serif |

## Getting to Know Your Printer

| Item          | Explanation                                                                                                                                                                                                                                                                                                                                                                               |
|---------------|-------------------------------------------------------------------------------------------------------------------------------------------------------------------------------------------------------------------------------------------------------------------------------------------------------------------------------------------------------------------------------------------|
| Pitch         | Selects the pitch (the horizontal spacing) of the font in fixed pitch, measured in cpi (characters per inch). You can also choose proportional spacing.                                                                                                                                                                                                                                   |
|               | Settings (default in bold):<br><b>10cpi</b> , 12cpi, 15cpi, 17cpi, 20cpi, 24cpi, Prop.                                                                                                                                                                                                                                                                                                    |
| Code Page     | Selects the character tables. Character tables contain the characters and symbols used by different languages. The printer prints text based on the selected character table.                                                                                                                                                                                                             |
|               | Settings (default in bold):<br><b>437</b> , 850, 858, 860, 863, 865                                                                                                                                                                                                                                                                                                                       |
| T.Margin      | Sets the distance from the top of the page to the baseline of the first printable line. The distance is measured in inches. The smaller the value, the closer the printable line is to the top.                                                                                                                                                                                           |
|               | Settings (default in bold):<br>0.30 ... <b>0.40</b> ... 1.50 inch in 0.05-inch increments                                                                                                                                                                                                                                                                                                 |
| Text          | Sets the page length in lines. For this option, a line is assumed to be 1 pica (1/6 inch). If you change the Orientation, Page Size, or T.Margin settings, the page length setting automatically returns to the default for each paper size.                                                                                                                                              |
|               | Settings (default in bold):<br>1 ... <b>67</b> Lines                                                                                                                                                                                                                                                                                                                                      |
| Auto CR       | Specifies whether the printer performs a carriage-return/line-feed (CR-LF) operation whenever the printing position goes beyond the right margin. If you select Off, the printer does not print any characters beyond the right margin and does not perform any line wrapping until it receives a carriage-return character. This function is handled automatically by most applications. |
|               | Settings (default in bold):<br><b>Off</b> , On                                                                                                                                                                                                                                                                                                                                            |
| Auto LF       | If you select Off, the printer does not send an automatic line-feed (LF) command with each carriage-return (CR). If On is selected, a line-feed command is sent with each carriage-return. Select On if your text lines overlap.                                                                                                                                                          |
|               | Settings (default in bold):<br><b>Off</b> , On                                                                                                                                                                                                                                                                                                                                            |
| Alt. Graphics | Turns the Alternate Graphics option on or off.                                                                                                                                                                                                                                                                                                                                            |
|               | Settings (default in bold):<br><b>Off</b> , On                                                                                                                                                                                                                                                                                                                                            |
| Bit Image     | The printer is able to emulate the graphics densities set with the printer commands. If you select Dark, the bit image density is high, and if you select Light, the bit image density is low.                                                                                                                                                                                            |
|               | Settings (default in bold):<br><b>Dark</b> , Light                                                                                                                                                                                                                                                                                                                                        |

## Getting to Know Your Printer

| Item         | Explanation                                                                    |
|--------------|--------------------------------------------------------------------------------|
| ZeroChar     | Specifies whether the printer prints a slashed or unslashed zero.              |
|              | Settings (default in bold):<br><b>0</b> , (or the zero character with a slash) |
| CharacterSet | Selects character table 1 or 2.                                                |
|              | Settings (default in bold):<br><b>1, 2</b>                                     |

## Admin Settings

### Note:

- To set a password using EpsonNet Config with a web browser, access **Network Administrator > Administrator > Password**.
- Enter the administrator password to access the Admin Settings menu for AL-M320DN/AL-M310DN.
- The password is not set in default. For AL-M320DN/AL-M310DN press the **OK** button to proceed when the Admin Password is required.
- If you forget your password, contact your dealer. Note that when the password is initialized, the settings and data stored on the printer are deleted. Depending on your environment, settings, such as network connection settings, may need to be done again. We recommend making a note or backup of the necessary data and setting information.

## Password Config Menu

| Item            | Explanation                                                                                                                                                                                                                                          |
|-----------------|------------------------------------------------------------------------------------------------------------------------------------------------------------------------------------------------------------------------------------------------------|
| Change Password | Specifies an administrator password. Enter the old password first and then enter the new password twice.                                                                                                                                             |
|                 | To enter the password on the AL-M320DN/AL-M310DN LCD panel, press the <b>▲ Up</b> or <b>▼ Down</b> buttons to select the characters and press the <b>► Right</b> button to confirm. After all characters are determined, press the <b>OK</b> button. |
|                 | Settings : (up to 20 characters)<br><b>Note:</b><br>The following characters and blank spaces can be used.<br>0123456789abcdefghijklmnopqrstuvwxyzABCDEFGHIJKLMNOPQRSTUVWXYZ<br>!"#\$%&'()*+,-./:;<=>?@^_`{ }~                                       |
| Limitation      | When <b>Interface</b> is selected, you need to enter the password to change interface settings. When <b>Config</b> is selected, you need to enter the password to change the items you configured.                                                   |
|                 | <b>Note:</b><br>The settings for this item cannot be changed using EpsonNet Config with a web browser.                                                                                                                                               |
|                 | Settings (default in bold):<br><b>Disable</b> , Interface, Config, All                                                                                                                                                                               |

## Getting to Know Your Printer

### Init SelecType

| Item               | Explanation                                                                                                                                                                                                                                                                                                 |
|--------------------|-------------------------------------------------------------------------------------------------------------------------------------------------------------------------------------------------------------------------------------------------------------------------------------------------------------|
| Init All SelecType | <p>For AL-M320DN/AL-M310DN, if Yes (Unprinted data is deleted) is selected, all control panel settings are changed to their factory settings.</p> <p><b>Note:</b><br/>To do this from EpsonNet Config with a web browser, access <b>Network Administrator &gt; Administrator &gt; Default Settings</b>.</p> |

---

### Bookmark Menu (For AL-M320DN/AL-M310DN)

The bookmark menu appears by pressing the **OK** button while the LCD panel displays **Ready**.

In the bookmark menu, the bookmarked setting items are listed and you can select one of them. The following menus are bookmarked by default.

- Reset Menu
- MP Tray Size
- System Information

To replace a bookmarked menu to another menu, display the menu you want to add and press the **OK** button for more than two seconds.

**Note:**  
The maximum number of menus you can register as bookmarks is 3.

## Loading Paper

# Loading Paper

## Available Paper and Capacities

Since the quality of any particular brand or type of paper may be changed by the manufacturer at any time, Epson cannot guarantee the quality of any type of paper. Always test samples of paper stock before purchasing large quantities or printing large jobs.

| Paper type                                   | Paper size                                                                                                                                                                                                       | Loading capacity or paper height |                  |                        | Duplex (Auto) |
|----------------------------------------------|------------------------------------------------------------------------------------------------------------------------------------------------------------------------------------------------------------------|----------------------------------|------------------|------------------------|---------------|
|                                              |                                                                                                                                                                                                                  | MP tray                          | Paper cassette 1 | Paper cassette 2*1/3*1 |               |
| Plain<br>Recycled<br>Preprinted<br>Special   | A4, A5 Portrait* <sup>2</sup> , B5, Letter (LT), Half Letter (HLT)* <sup>2</sup> , Legal (LGL)* <sup>3</sup> , Government Letter (GLT), Government Lagal (GLG)* <sup>3</sup> , Executive (EXE), F4* <sup>3</sup> | 100 sheets                       | 250 sheets       | 250 sheets             | ✓             |
|                                              | A5 Landscape, A6                                                                                                                                                                                                 | 100 sheets                       | 250 sheets       | 250 sheets             | -             |
|                                              | Custom (CTM) or User Defined Size                                                                                                                                                                                |                                  |                  |                        |               |
|                                              | Width : 70 - 216 mm<br>Length* <sup>4</sup> : 148 - 365 mm                                                                                                                                                       | 16.5 mm                          | -                | -                      | -             |
|                                              | Width : 105 - 216 mm<br>Length* <sup>4</sup> : 148 - 365 mm                                                                                                                                                      | -                                | 27.5 mm          | 27.5 mm                | -             |
| Semi-thick<br>Color<br>Letterhead<br>Special | A4, A5 Portrait* <sup>2</sup> , B5, Letter (LT), Half Letter (HLT)* <sup>2</sup> , Legal (LGL), Government Letter (GLT), Government Lagal (GLG), Executive (EXE), F4                                             | 16.5 mm                          | 27.5 mm          | 27.5 mm                | ✓             |
|                                              | A5 Landscape, A6                                                                                                                                                                                                 | 16.5 mm                          | 27.5 mm          | 27.5 mm                | -             |
|                                              | Custom (CTM) or User Defined Size                                                                                                                                                                                |                                  |                  |                        |               |
|                                              | Width : 70 - 216 mm<br>Length* <sup>4</sup> : 148 - 365 mm                                                                                                                                                       | 5 sheets                         | -                | -                      | -             |
|                                              | Width : 105 - 216 mm<br>Length* <sup>4</sup> : 148 - 365 mm                                                                                                                                                      | -                                | 27.5 mm          | 27.5 mm                | -             |

## Loading Paper

| Paper type                | Paper size                                                                                                                                                           | Loading capacity or paper height |                  |                        | Duplex (Auto) |
|---------------------------|----------------------------------------------------------------------------------------------------------------------------------------------------------------------|----------------------------------|------------------|------------------------|---------------|
|                           |                                                                                                                                                                      | MP tray                          | Paper cassette 1 | Paper cassette 2*1/3*1 |               |
| Thick Extra-Thick Special | A4, A5 Portrait* <sup>2</sup> , B5, Letter (LT), Half Letter (HLT)* <sup>2</sup> , Legal (LGL), Government Letter (GLT), Government Lagal (GLG), Executive (EXE), F4 | 5 sheets                         | 5 sheets         | 5 sheets               | ✓             |
|                           | A5 Landscape, A6                                                                                                                                                     | 5 sheets                         | 5 sheets         | 5 sheets               | -             |
|                           | Custom (CTM) or User Defined Size                                                                                                                                    |                                  |                  |                        |               |
|                           | Width : 70 - 216 mm<br>Length* <sup>4</sup> : 148 - 365 mm                                                                                                           | 5 sheets                         | -                | -                      | -             |
| Super-Thick Special       | A4, A5 Portrait* <sup>2</sup> , B5, Letter (LT), Half Letter (HLT)* <sup>2</sup> , Legal (LGL), Government Letter (GLT), Government Lagal (GLG), Executive (EXE), F4 | 5 sheets                         | -                | -                      | -             |
|                           | A5 Landscape, A6                                                                                                                                                     | 5 sheets                         | -                | -                      | -             |
| Envelopes                 | C5, C6, C10, DL, Monarch (Mon)                                                                                                                                       | 5 sheets                         | -                | -                      | -             |
| Transparencies            | A4, Letter (LT)                                                                                                                                                      | 1 sheets                         | -                | -                      | -             |
| Labels                    | A4, Letter (LT)                                                                                                                                                      | 1 sheets                         | -                | -                      | -             |

\*1 AL-M320DN/AL-M310DN only

\*2 2-sided printing cannot be done if the grain of the paper is perpendicular to the direction of the paper feed.

\*3 Support the trailing edge of the paper with your hands when loading.

\*4 For paper longer than 297 mm, support the trailing edge of the paper with your hands when loading.

**Note:**

- ❑ Even paper with a thickness within range may not be able to feed due to the paper's characteristics and qualities (e.g.: direction of the grain, stiffness). It may also have an effect on the print results.
- ❑ If you select Auto Select in Paper Source in the printer driver, the printer will search for a paper source containing the paper size specified in Document Size, and prints from the paper source until there is no more paper, then it prints from the next paper source automatically. Using this auto select function, for plain paper (80 g/m<sup>2</sup>), the printer can continuously print up to 850 sheets (for AL-M320DN/AL-M310DN), or up to 350 sheets (for AL-M220DN).
- ❑ The output tray capacity for plain paper (80 g/m<sup>2</sup>) is up to 250 sheets (standard output tray)
- ❑ In continuous printing, such as when printing on paper with a smaller width than A4, the print speed may slow down when printing several pages, depending on the circumstances, due to the printer's temperature adjustments.
- ❑ When printing on damp paper in a low-temperature environment, moisture on the paper is vaporized by the heat when the toner is fixed, which may be seen as water vapor when the paper is ejected. Increasing the room temperature makes this disappear.



## Loading Paper

## Available paper types and weights

| Paper type | Paper weight               | Remarks                                                                                                                                                                                                                                                                                                                                                                                                                                                                                                                                                                                                                                                           |
|------------|----------------------------|-------------------------------------------------------------------------------------------------------------------------------------------------------------------------------------------------------------------------------------------------------------------------------------------------------------------------------------------------------------------------------------------------------------------------------------------------------------------------------------------------------------------------------------------------------------------------------------------------------------------------------------------------------------------|
| Plain      | 60 - 90 g/m <sup>2</sup>   | <ul style="list-style-type: none"> <li>❑ For the paper less than 64 g/m<sup>2</sup>, set the paper type to <b>Thin</b> on the control panel or EpsonNet Config with a web browser, and in the printer driver. See <a href="#">"Using the Control Panel"</a> on page 17 for how to access the control panel.</li> <li>❑ For paper over 65 to 74 g/m<sup>2</sup>, Set 001 Plain to 1 in the Printer Adjust Menu. For details, see <a href="#">"Printer Adjust Menu"</a> on page 104.</li> <li>❑ Use only at normal temperature (15 - 25°C) and humidity (40 - 60%). Poor quality paper may reduce print quality, or cause paper jams and other problems.</li> </ul> |
| Recycled   | 60 - 90 g/m <sup>2</sup>   |                                                                                                                                                                                                                                                                                                                                                                                                                                                                                                                                                                                                                                                                   |
| Semi-thick | 75 - 90 g/m <sup>2</sup>   | -                                                                                                                                                                                                                                                                                                                                                                                                                                                                                                                                                                                                                                                                 |
| Color      | 91 - 105 g/m <sup>2</sup>  | -                                                                                                                                                                                                                                                                                                                                                                                                                                                                                                                                                                                                                                                                 |
| Letterhead | 91 - 105 g/m <sup>2</sup>  | -                                                                                                                                                                                                                                                                                                                                                                                                                                                                                                                                                                                                                                                                 |
| Preprinted | 60 - 90 g/m <sup>2</sup>   | -                                                                                                                                                                                                                                                                                                                                                                                                                                                                                                                                                                                                                                                                 |
| Thick      | 106 - 135 g/m <sup>2</sup> | Thick                                                                                                                                                                                                                                                                                                                                                                                                                                                                                                                                                                                                                                                             |
|            | 136 - 163 g/m <sup>2</sup> | Extra-Thick                                                                                                                                                                                                                                                                                                                                                                                                                                                                                                                                                                                                                                                       |
|            | 164 - 216 g/m <sup>2</sup> | Super-Thick                                                                                                                                                                                                                                                                                                                                                                                                                                                                                                                                                                                                                                                       |
| Custom     | 60 - 216 g/m <sup>2</sup>  | MP tray only                                                                                                                                                                                                                                                                                                                                                                                                                                                                                                                                                                                                                                                      |
|            | 60 - 163 g/m <sup>2</sup>  | Paper cassette1/2/3 (for AL-M320DN/AL-M310DN)<br>Paper cassette1 (for AL-M220DN)                                                                                                                                                                                                                                                                                                                                                                                                                                                                                                                                                                                  |

## Loading Paper

**Important:**

*You cannot use the following paper in this printer. It may cause printer damage, paper jams, and poor print quality:*

- Media meant for other black-and-white laser printers, color laser printers, color copiers, black-and-white copiers, or ink jet printers*
- Previously printed paper by any other black-and-white laser printers, color laser printers, color copiers, black-and-white copiers, ink jet printers, or thermal transfer printers*
- Very thin paper (59 g/m<sup>2</sup> or less), or very thick paper (221 g/m<sup>2</sup> or more)*
- Carbon paper, carbonless paper, thermal-sensitive paper, pressure-sensitive paper, acid paper, or paper that uses high-temperature-sensitive ink (around 160°C)*
- Labels that peel easily or labels that do not cover the backing sheet completely*
- Special surface-coated paper or special surface-colored paper*
- Paper that has binder holes or is perforated*
- Paper that has glue, staples, paper clips, or tape on it*
- Paper that attracts static electricity*
- Moist or damp paper*
- Paper of uneven thickness*
- Overly thick or thin paper*
- Paper that is too smooth or too rough*
- Paper that is different on the front and back*
- Paper that is folded, curled, wavy, or torn*
- Paper of irregular shape, or paper that does not have right angle corners*
- Paper for which the grain is perpendicular to the direction of the paper feed*

## Loading Paper

# Loading Paper

## Paper cassette

Perform the same procedure to load paper into the optional paper cassette.

**Note:**

For AL-M320DN/AL-M310DN, a warning message appears if the cassette that is higher than the cassette from which the printer is fed (if feeding from C3, then C2 and C1) is not inserted. You can print.

If you do not want this message to appear, set the operation panel's **Common Settings > Setup Menu > Cassette Warning to Off**.

["Setup Menu" on page 21](#)

- 1** Pull out the paper cassette.

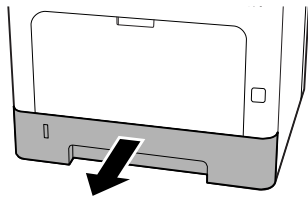

- 2** If the paper lifting plate inside the cassette is raised, press down on the center of the paper lifting plate until the locking tab is locked.

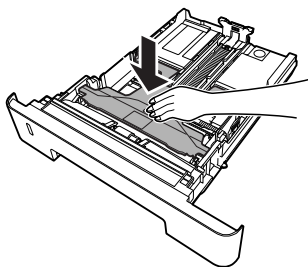

- 3** Pinch the knobs and slide the paper guides to accommodate the paper you are loading.

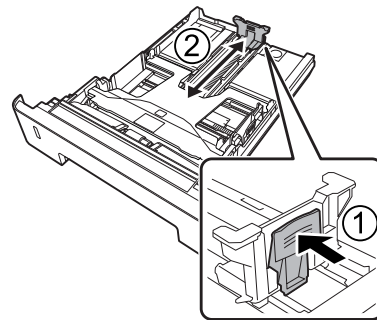

**Note:**

For paper larger than A4, press down the button on the bottom edge of the cassette, pull out the cassette, and then load the paper.

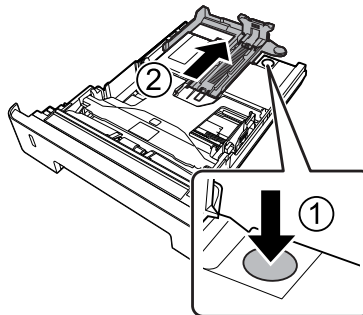

- 4** Grip the paper guides and pull them out sideways to align them with the appropriate position for the paper you are loading.

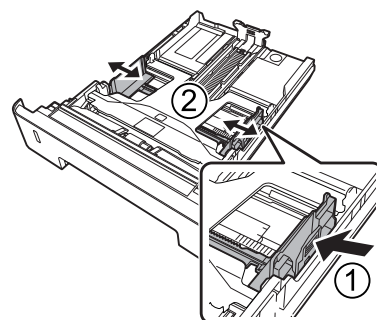

**Note:**

Be sure to adjust the paper guides according to the size of the paper you loaded, to prevent paper feed failures, paper jams or other errors.

## Loading Paper

- 5** Load a stack of the desired paper on the center of the paper cassette with the printable surface facing down.

**Note:**

- ❑ Make sure that you do not load paper beyond the limit mark. See [“Available Paper and Capacities” on page 39](#).
- ❑ Do not move the paper guide after the paper is loaded; if you do, the paper may not be able to feed correctly.

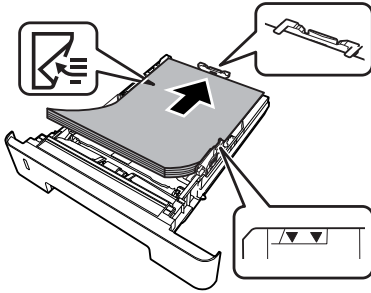

- 6** Push the paper cassette into the printer.

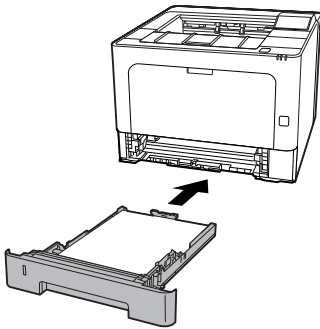

- 7** Extend the paper support according to the size of the paper to prevent the paper from slipping off the printer.

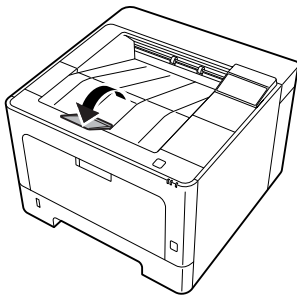

- 8** Set the paper size on the paper size setting dial (or Cassette Size on the control panel) and Cassette Type settings to match the loaded paper size and paper type on the control panel. For details, see [“Tray Menu” on page 27](#).

## MP tray

**Note:**

To load envelopes, see [“Envelopes” on page 45](#).

- 1** Open the MP tray.

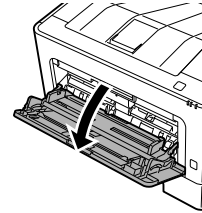

- 2** Extend the paper support of the MP tray.

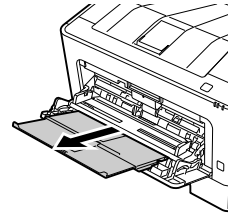

- 3** Slide the paper guides to accommodate the paper you are loading.

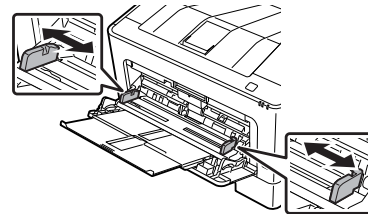

**Note:**

Be sure to adjust the paper guides according to the size of the paper you loaded to prevent paper feed failures, paper jams or any other errors.

- 4** Load a stack of the desired paper with the printable surface facing up.

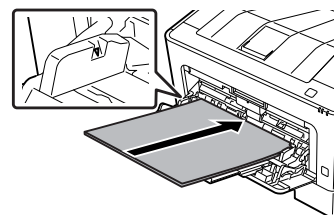

Loading Paper

**Note:**  
Make sure that you do not load paper beyond the maximum limit guide. See “Available Paper and Capacities” on page 39.

- 5 Extend the paper support according to the size of the paper to prevent the paper from slipping off the printer.

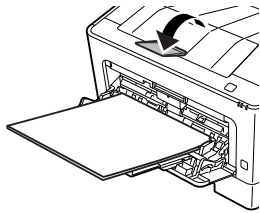

**Note:**  
To eject paper to the optional face-up tray, see “Paper Output Settings” on page 45.

- 6 Set the MP Type setting on the control panel to match the type of paper loaded. For details, see “Tray Menu” on page 27.

## Paper Output Settings

### Orientation to eject paper

If the paper is A5, the printer can print on it in either orientation (landscape or portrait).

- 1 Set the paper size (portrait or landscape) using the Tray Menu according to the table below.

| 1) Paper in the tray | 2) Tray Menu |
|----------------------|--------------|
| A5 portrait          | A5 Portrait  |
| A5 landscape*        | A5 Landscape |

\* Standard orientation

- 2 Access the printer driver’s Main tab, click Paper Output Settings, and select a radiobutton for the output orientation.

## Selecting and Using Print Media

You can use special media, such as envelopes, thick paper, labels, and transparencies.

When loading special media, you should make paper settings. You can also do these settings in the Tray Menu in the control panel (for AL-M320DN/AL-M310DN), in EpsonNet Config on your web browser, or in Printer Settings in the printer driver (for AL-M220DN). See “Tray Menu” on page 27 and “How to access the control panel menus (AL-M320DN/AL-M310DN)” on page 17.

**Note:**  
Since the quality of any particular brand or type of media may be changed by the manufacturer at any time, Epson cannot guarantee the quality of any type of media. Always test samples of media stock before purchasing large quantities or printing large jobs.

## Envelopes

### Available envelopes

- Envelopes that have no glue or no tape

**! Important:**  
Do not use window envelopes. The plastic on most window envelopes will melt.

### Available paper source

- MP tray

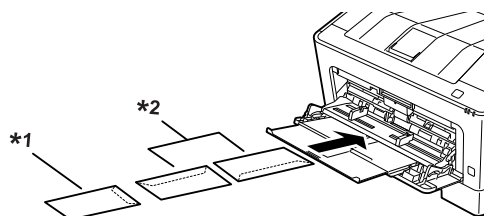

\*1 C5, IB5

\*2 MON, C10, DL, C6

## Loading Paper

### Printer driver settings

Make the following settings according to the envelopes you loaded on the printer.

|              | Printer driver settings                                               |
|--------------|-----------------------------------------------------------------------|
| Paper Size   | Refer to <a href="#">“Available Paper and Capacities” on page 39.</a> |
| Paper Source | MP Tray                                                               |
| Paper Type   | Envelope                                                              |

**Note:**

- Depending on the quality of envelopes, the printing environment, or the printing procedure, envelopes might be wrinkled. Make a trial print run before you print on a lot of envelopes.
- Duplex printing is not available for envelopes.
- If you do not load envelopes in the MP tray right after they have been removed from the packaging, they may bulge. To avoid jams, flatten them as shown below before loading them in the MP tray.

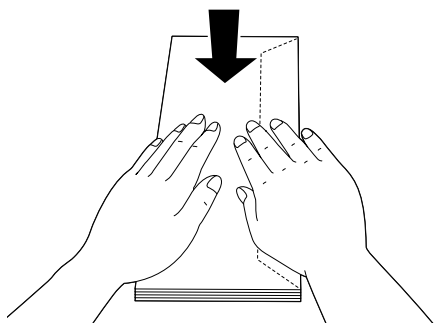

- If envelopes do not feed well, reducing the number of envelopes that are loaded may solve the problem.

### Other paper

You can use super-thick paper, labels, and transparencies. See [“Available Paper and Capacities” on page 39.](#)

### Available paper source

- MP tray  
For loading paper, see [“MP tray” on page 44.](#)

### Printer driver settings

Make the following settings according to the paper you loaded on the printer. See [“Available Paper and Capacities” on page 39.](#)

|              | Printer driver settings                                               |
|--------------|-----------------------------------------------------------------------|
| Paper Size   | Refer to <a href="#">“Available Paper and Capacities” on page 39.</a> |
| Paper Source | MP Tray                                                               |
| Paper Type   | Refer to <a href="#">“Available Paper and Capacities” on page 39.</a> |

### Available labels

- Labels designed for laser printers or plain-paper copiers
- Labels that completely cover the backing sheet, with no gaps between the individual labels

**Note:**

- Depending on the quality of labels, the printing environment, or the printing procedure, labels might be wrinkled. Make a trial print run before you print on a lot of labels.
- Duplex printing is not available for labels.
- Press a sheet of paper on top of each sheet of labels. If the paper sticks, do not use those labels in your printer.

## Custom paper size

### Available paper source

- MP tray
- Paper cassettes

### Printer driver settings

Make the following settings according to the envelopes you loaded on the printer.

|            | Printer driver settings                                                                                            |
|------------|--------------------------------------------------------------------------------------------------------------------|
| Paper Size | User Defined Size*<br>* For available sizes, refer to <a href="#">“Available Paper and Capacities” on page 39.</a> |

## Loading Paper

| Printer driver settings |                                                                                       |
|-------------------------|---------------------------------------------------------------------------------------|
| Paper Source            | MP Tray, Cassette 1, Cassette 2*,<br>Cassette 3*<br><br>*For AL-M320DN/AL-M310DN only |
| Paper Type              | Refer to <a href="#">"Available Paper and Capacities"</a> on page 39.                 |

### Note:

- ❑ Depending on the quality of the non-standard size paper, the printing environment, or the printing procedure, the paper might skew. Make a trial print run before you print on a lot of non-standard size paper.
- ❑ For Windows, access the printer driver, then select **User Defined Size** from the Document Size list on the Main tab. In the User Defined Paper Size dialog box, adjust the Paper Width, Paper Height, and Unit settings to match your custom paper. Then click **OK** and your custom paper size will be saved.
- ❑ When sharing the printer on a network, you cannot create User Defined Size at the client.
- ❑ If you cannot use the printer driver as explained above, access the control panel (for AL-M320DN/AL-M310DN), or EpsonNet Config from your web browser, select Printer Settings > Printing Menu, and set Page Size to CTM (custom).

# Printing Tasks

## Basics of Printing

This section describes the basics of printing using the Windows printer driver (**ESC/Page** language) as an example. Printing can also be done by similar procedures using other supported operating systems or emulation languages.

- 1 Load a stack of paper.  
For available paper, see [“Available Paper and Capacities” on page 39](#).  
For how to load paper in the paper source, see [“Loading Paper” on page 43](#).
- 2 Make the appropriate settings in the control panel (for AL-M320DN/AL-M310DN), in Printer Settings in the printer driver (for AL-M220DN), or in **EpsonNet Config** on your web browser.  
  
The items to be set are different depending on the paper you use.  
See [“Using the Control Panel” on page 17](#).  
See [“Selecting and Using Print Media” on page 45](#).

- 3 Click **Print** from the File menu on the application you are using.
- 4 Select your printer.
- 5 Click **Properties** or **Printing Preferences**. The printer driver’s Main screen appears.

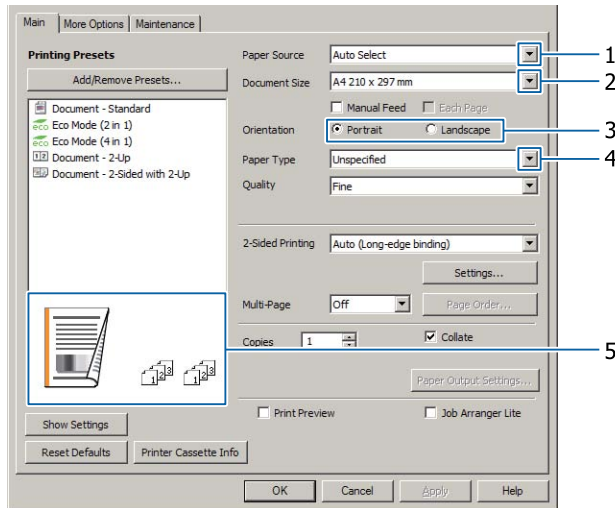

- 6 Make the settings in the table below:

| Item | Explanation                                                                          |
|------|--------------------------------------------------------------------------------------|
| 1    | Paper Source<br>Selects the paper source in which the paper to be printed is loaded. |
| 2    | Document Size<br>Selects the size of paper you set in applications.                  |
| 3    | Orientation<br>Selects the orientation you set in applications.                      |



## Printing Tasks

| Item |                  | Explanation                                                 |
|------|------------------|-------------------------------------------------------------|
| 4    | Paper Type       | Selects the type of print media loaded in the paper source. |
| 5    | (printout image) | Displays an image of the printout.                          |

**Note:**

- To show the help for each item, right-click the item and click **Help** on the printer driver.
- In the Main screen, you can also make settings for 2-sided printing and collating.
- In the More Options screen, you can make settings for reducing/enlarging the document or watermark feature. See “Setting Advanced Features” on page 53.

**7** Click **OK** to close the printer driver screen.

**8** Click **Print** to start printing.

## Setting the Main Screen

This screen enables basic settings for printing such as paper source or paper size, and also enables the settings for the basic functions such as multi-page printing or 2-sided printing.

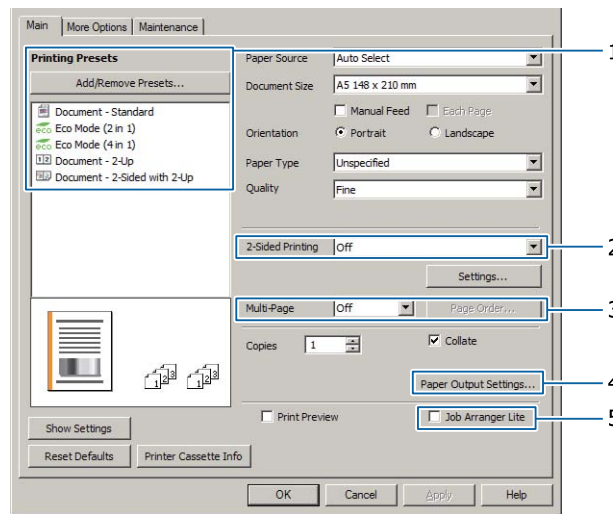

**Note:**

The printer driver’s online help provides explanations on printer driver settings.

| Item |                  | Explanation                                                                                                                           |
|------|------------------|---------------------------------------------------------------------------------------------------------------------------------------|
| 1    | Printing Presets | The settings, such as Document - 2-Up, or Document - 2-Sided, are preset. You can register the print settings you desire to the list. |

## Printing Tasks

| Item |                       | Explanation                                                                                                                                                                                                                                                                                                                                                                                                                                                                             |
|------|-----------------------|-----------------------------------------------------------------------------------------------------------------------------------------------------------------------------------------------------------------------------------------------------------------------------------------------------------------------------------------------------------------------------------------------------------------------------------------------------------------------------------------|
| 2    | 2-Sided Printing      | Prints on the front and back of the sheet. Combined with the Reduce/Enlarge function, a 2 page A3 document can be printed on one A4 size sheet.<br><br>Click <b>Settings</b> to make Binding Edge, Binding Margin and folded booklet settings. See <a href="#">"Printing a booklet" on page 53</a> .                                                                                                                                                                                    |
| 3    | Multi-Page            | <input type="checkbox"/> Multi-Page:<br>Enables 2 pages or 4 pages per sheet printing on the same paper size as the original document. 2-Sided Printing can be combined with this function.<br><br><input type="checkbox"/> Poster:<br>For example, you can make large, about A2 size, printouts by printing data for A4 size on four A4 sheets and stick them together.<br>See <a href="#">"Printing data for a single page across multiple sheets (poster printing)" on page 54</a> . |
| 4    | Paper Output Settings | Selects the paper output orientation for the paper sizes which are supported to be fed in both portrait and landscape orientations. See <a href="#">"Paper Output Settings" on page 45</a> .                                                                                                                                                                                                                                                                                            |
| 5    | Job Arranger Lite     | Allows you to print several documents created by different applications at one time by arrange settings. See <a href="#">"Printing multiple print jobs at one time" on page 53</a> .                                                                                                                                                                                                                                                                                                    |

## Setting the More Options Screen

This screen enables settings, such as for secure printing, reduced, enlarged, or printing with an overlay.

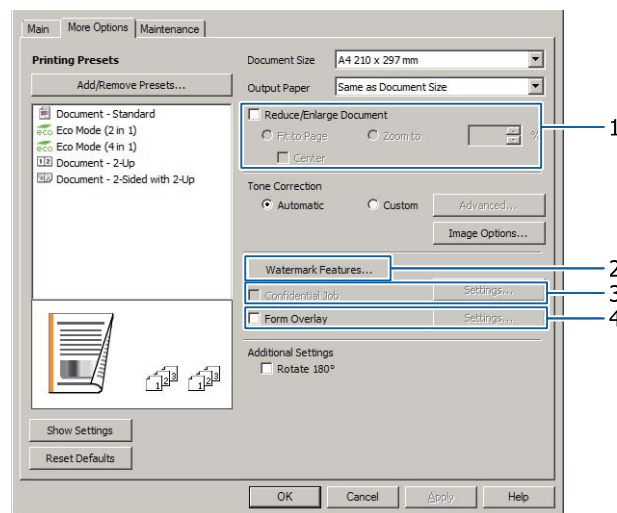

| Item |                         | Explanation                                                                                                                 |
|------|-------------------------|-----------------------------------------------------------------------------------------------------------------------------|
| 1    | Reduce/Enlarge Document | This function allows you to reduce or enlarge the image to be printed. 2-Sided Printing can be combined with this function. |

## Printing Tasks

| Item |                                             | Explanation                                                                                                                                                                                                                                                                                                                                                                                                                                                                                                                                                                                                                                                                                                                                                                                                                                                                                                                                                                                                                                                                                                                                                                                                                                                                                                                                                                                                                         |
|------|---------------------------------------------|-------------------------------------------------------------------------------------------------------------------------------------------------------------------------------------------------------------------------------------------------------------------------------------------------------------------------------------------------------------------------------------------------------------------------------------------------------------------------------------------------------------------------------------------------------------------------------------------------------------------------------------------------------------------------------------------------------------------------------------------------------------------------------------------------------------------------------------------------------------------------------------------------------------------------------------------------------------------------------------------------------------------------------------------------------------------------------------------------------------------------------------------------------------------------------------------------------------------------------------------------------------------------------------------------------------------------------------------------------------------------------------------------------------------------------------|
| 2    | Watermark Features                          | <p>Anti-Copy Pattern</p> <p>This function allows you to print a document as a copy-protected document. When you try to copy a copy-protected document, "Copy" is printed several times on the document. This function is useful to prevent unauthorized copying. Any text string can be registered.</p> <p><b>Note:</b></p> <ul style="list-style-type: none"> <li><input type="checkbox"/> <i>Epson does not guarantee protection from information leakage or any other damages caused by using this function. Hidden letters may appear in some cases.</i></li> <li><input type="checkbox"/> <i>Screen-tone may be too dark, hidden letters may not be printed on the entire image, or hidden letters may not appear when photocopied. This depends on the models, settings, and combinations of photocopiers, fax machine, input devices such as digital cameras and scanners, output devices such as printers; printer driver settings of this product; condition of consumables, such as toner and output paper type.</i></li> </ul> <p>Watermark</p> <p>This function allows you to print a text-based or image-based watermark on your document.</p> <p><b>Note:</b></p> <p><i>You can register up to 10 original watermarks.</i></p> <p>Header/Footer</p> <p>This function allows you to print user name, computer name, date, time, document name, or collate number, at the top or bottom of each page in a document.</p> |
| 3    | Confidential Job (AL-M320DN/AL-M310DN only) | <p>This function allows you to apply a password to the print job. You can print the job by entering the password on the printer's control panel. See the <a href="#">"Using the Reserve Job function (AL-M320DN/AL-M310DN)"</a> on page 56.</p>                                                                                                                                                                                                                                                                                                                                                                                                                                                                                                                                                                                                                                                                                                                                                                                                                                                                                                                                                                                                                                                                                                                                                                                     |
| 4    | Form Overlay                                | <p>This function allows you to print a standard form or letterhead onto original documents. See <a href="#">"Printing with an overlay"</a> on page 57.</p>                                                                                                                                                                                                                                                                                                                                                                                                                                                                                                                                                                                                                                                                                                                                                                                                                                                                                                                                                                                                                                                                                                                                                                                                                                                                          |

## Printing Tasks

---

### Setting the Maintenance Screen

This screen enables you to start Job Arranger Lite, enables settings, such as Notice Settings for EPSON Status Monitor. For details, see the help for each item.

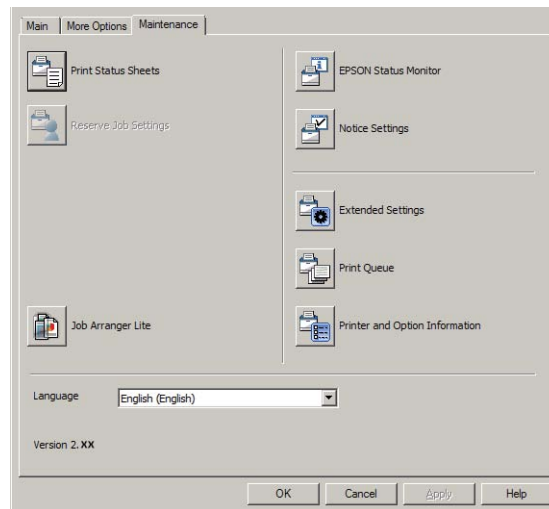

#### For AL-M220DN users

You can do Printer Adjust Menu settings on the printer's control panel from this screen. See ["Printer Adjust Menu" on page 104](#) for how to access the menu.

## Printing Tasks

# Setting Advanced Features

The printer driver has useful functions such as 2-sided printing or multi-page printing to save paper and toner, or adding an anti-copy pattern to prevent unauthorized copying.

The explanations in this section use the standard ESC/Page printer driver on Windows as an example.

**Note:**

- There are features that are not supported by the printer driver on other emulation language or operating systems.*
- These features may not be applied with other settings (such as paper type).*

## Printing multiple print jobs at one time

This function allows you to print several documents created by different applications at one time by arranging settings, such as the printing order, duplexing, and the print layout.

- 1 Click the **Main** tab.
- 2 Select the **Job Arranger Lite** check box.
- 3 Click **OK**.

The Print Job Arranger screen appears when a print job is executed. Make appropriate settings. For details, see the Print Job Arranger help.

## Printing a booklet

This function allows you to arrange pages to be a booklet. Two pages are printed on both sides of the paper that is the same size as the print data.

Combined with Reduce/Enlarge Document printing, the output paper size can be changed.

Set paper that is suitable for 2-sided printing (duplex printing). See [“Available Paper and Capacities”](#) on page 39.

## Printing to fold a batch of pages in half

This function prints a booklet ready for center binding. Fold the entire document in half, and then bind it at the center of the printout. This setting is suitable for documents that have only a few pages.

For example, eight pages of an A4 size document are printed on two sheets. Folding the pages in half by overlapping all the sheets makes an A5 size booklet of eight pages.

- 1 Select **Auto (Long-edge binding)** or **Auto (Short-edge binding)** in the 2-sided Printing list box and click **Settings**.

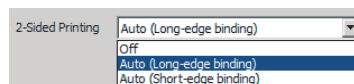

- 2 Select the **Booklet** check box and select **Center Binding**.
- 3 Click **OK** to close setting dialog box.
- 4 Print the document, fold all sheets in half, and then bind them.

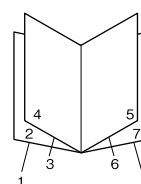

## Printing to fold each page in half

This function prints a booklet ready for side binding, fold each sheet individually in half, and then bind at the side of the printout. This setting is suitable for documents that have many pages.

For example, 40 pages of an A4 size document are printed, then each sheet is folded in half and stacking them all makes an A5 size booklet of 40 pages.

**Printing Tasks**

- 1 Select **Auto (Long-edge binding)** or **Auto (Short-edge binding)** in the 2-sided Printing list box and click **Settings**.

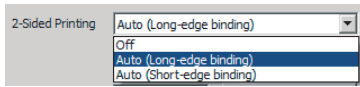

- 2 Select the **Booklet** check box and select **Side Binding**.

- 3 Click **OK** to close setting dialog box.

- 4 Print the document, fold in half 5 sheets by 5 sheets, overlap all sheets, and then bind them.

**Printing data for a single page across multiple sheets (poster printing)**

Print data for a single page across multiple sheets. Pasting the paper together after it has been printed creates a large, poster-like printout. Example: Printing the data for A4 size paper in 4 parts on A4 paper (2 × 2 poster) and pasting them together makes a poster that is about A2 size.

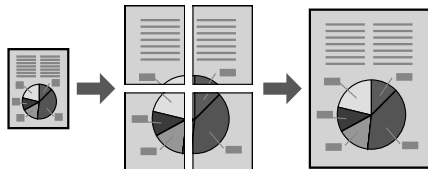

**Print by dividing a page of data into multiple sheets (poster printing)**

- 1 Turn 2-Sided Printing Off in Main.
- 2 On Multi-Page, select how to divide the data.
  - 2x1Poster: Divided into 2 parts (prints on 2 pages)
  - 2x2Poster: Divided into 4 parts (prints on 4 pages)
  - 3x3Poster: Divided into 9 parts (prints on 9 pages)
  - 4x4Poster: Divided into 16 parts (prints on 16 pages)
 Preview the printout by clicking Settings.

- 3 If you want to print alignment marks, select Settings - Print Cutting Guides, select either one, and then click **OK**.

Overlapping Alignment Marks: Print guides (refer to “How to Stick Papers Together” on page 54)

Trim Lines: Only print lines

- 4 Select the paper source and the size of the paper on which to print and other settings.

Do any other necessary settings.

- 5 Click **OK**, and then click **Print**.

**How to Stick Papers Together**

This section explains how to stick papers together an example of a 2x2Poster with Overlapping Alignment Marks as an example. Stick the papers together using the following steps.

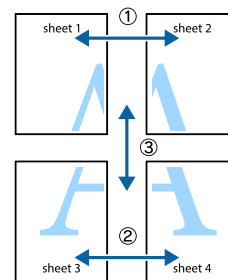

- 1 Cut along the line joining the top and bottom of Sheet 1 - the vertical line (blue) intersecting the × marks.

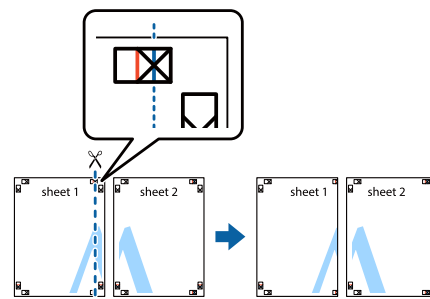

**Printing Tasks**

- 2** Lay Sheet 1 on Sheet 2 so that the × marks align. Place tape on the back to hold it temporarily.

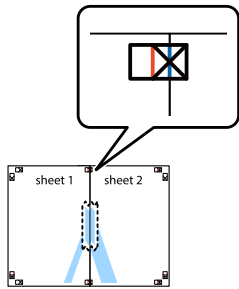

- 3** Cut along the vertical line (red) joining the left sides of the × marks.

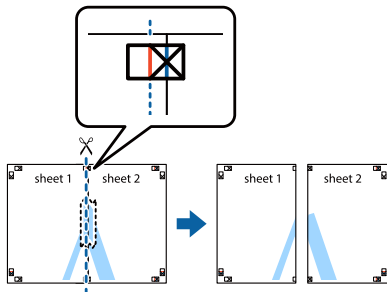

- 4** Stick the paper together by placing tape on the back.

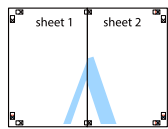

- 5** Stick Sheet 3 and Sheet 4 together.
- Repeat steps 1 and 4.

- 6** Cut along the horizontal line (blue) that intersects the × marks on Sheet 1 and Sheet 2.

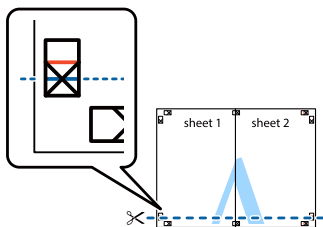

- 7** Lay Sheet 1 and Sheet 2 on Sheet 3 and Sheet 4 so that the × marks align. Place tape on the back to hold it temporarily.

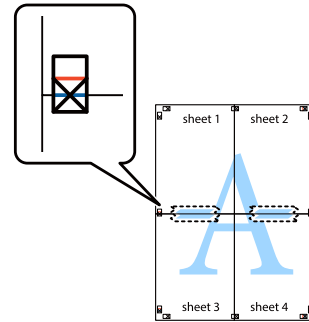

- 8** Cut along the horizontal line (red) joining the top sides of the × marks.

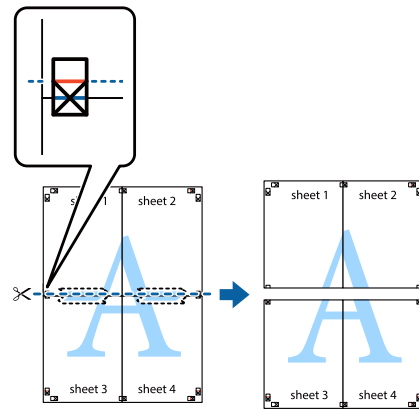

- 9** Stick the paper together by placing tape on the back.

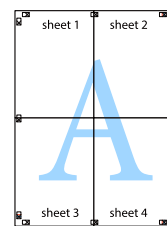

## Printing Tasks

- 10** Cut off the margins along the outer alignment marks.

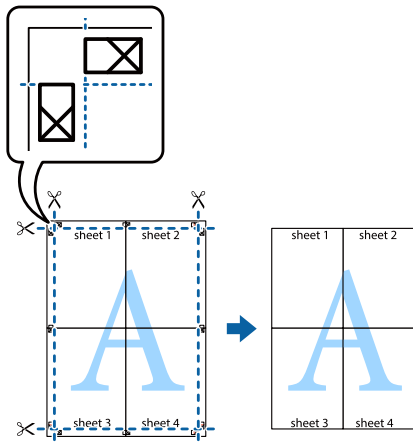

## Using the Reserve Job function (AL-M320DN/AL-M310DN)

This function allows you to store print jobs on the printer's memory and to print them later directly from the printer's control panel. You can prevent the printed document from being looked at by other people by applying a password to the print job.

This function uses the following memory.

| Printer's Storage | Description                                                                                             |
|-------------------|---------------------------------------------------------------------------------------------------------|
| RAM Disk          | To enable the RAM disk, you have to set the RAM Disk setting on the control panel to Normal or Maximum. |

The table below gives an overview of the options.

| Option           | Description                                                                                                                                                                          |
|------------------|--------------------------------------------------------------------------------------------------------------------------------------------------------------------------------------|
| Re-Print Job     | Lets you print the job now and store it on the printer's memory. You can print the same job several times.                                                                           |
| Verify Job       | Lets you print one copy now to verify the content. You can print multiple copies later.                                                                                              |
| Confidential Job | Lets you apply a password to the print job. You can print the job by entering the password on the printer's control panel. See <a href="#">"Using Confidential Job" on page 56</a> . |

## Using Re-Print Job/Verify Job (Quick Print Job feature)

### Sending the print job

- 1 Click the **Maintenance** tab, then click **Reserve Jobs Settings**. The Reserve Jobs Settings dialog box appears.
- 2 Select the **Reserve Jobs** check box, then select **Re-Print Job** or **Verify Job**.
- 3 Enter a user name and job name in the corresponding text boxes.
- 4 Click **OK**.

### Printing using the Quick Print Job Menu

- 1 Make sure the LCD panel displays **Ready**, then press the **▶ Right** button to access the control panel menus.
- 2 Press the **▼ Down** button repeatedly until **Quick Print Job Menu** appears on the LCD panel, then press the **▶ Right** button.
- 3 Use the **▼ Down** or **▲ Up** button to scroll to the appropriate user name, then press the **▶ Right** button.
- 4 Use the **▼ Down** or **▲ Up** button to scroll to the appropriate job name, then press the **▶ Right** button.
- 5 Press the **▶ Right** button, then use the **▼ Down** and **▲ Up** buttons to select the number of copies.  
  
To delete the print job without printing any copies, press the **▼ Down** button to display **Delete** on the LCD panel.
- 6 Press the **▶ Right** button to start printing or to delete the data.

## Using Confidential Job

### Sending the print job

- 1 Click the **More Options** tab, then click **Confidential Job**. The Confidential Job Settings dialog box appears.



## Printing Tasks

**2** Enter a four-digit number for Password.

**3** Enter a user name and job name if necessary.

**Note:**

The **OK** button becomes available after the password has been entered.

**4** Click **OK**.

### Printing using the Confidential Job Menu

**1** Make sure the LCD panel displays **Ready**, then press the **▶ Right** button to access the control panel menus.

**2** Press the **▼ Down** button repeatedly until **ConfidentialJobMenu** appears on the LCD panel, then press the **▶ Right** button.

**3** Use the **▼ Down** or **▲ Up** button to scroll to the appropriate user name, then press the **▶ Right** button.

**4** Enter your four-digit password.

To enter the password, press the **▼ Down** or **▲ Up** button to select the character and press the **▶ Right** button to determine the character. After all characters are determined, press the **▶ Right** button.

**Note:**

If no print jobs have been saved with the password you entered, **Wrong Password** appears briefly on the LCD panel then the printer exits the control panel menus. Confirm the password and try again.

**5** Use the **▼ Down** or **▲ Up** button to scroll to the appropriate job name, then press the **▶ Right** button.

**6** Use the **▼ Down** or **▲ Up** button to display **Print**.

To delete the print job, press the **▼ Down** or **▲ Up** button to display **Delete** on the LCD panel.

**7** Press the **▶ Right** button to start printing or to delete the data.

## Printing with an overlay

This function allows you to print documents onto form templates, which you register on your printer in advance.

**Note:**

- This function is for Windows only.
- The application featured in these instructions is Microsoft WordPad. The actual procedure may differ slightly when printing from other applications.

## Creating an overlay

**Note:**

You first need to install EPSON FormOverlayUTL utility to create overlay or underlay data. See [“Installing Software” on page 62](#) for details.

Follow the steps below to create the form data.

**1** Open the data to be an overlay data using an application.

**2** Select **Print** from the File menu, select **EPSON FormOverlayUTL**, then click **Preferences**.

**3** In the Basic Settings tab — Form Overlay — Create Overlay Data, click **More Settings**. The Create Form dialog box appears.

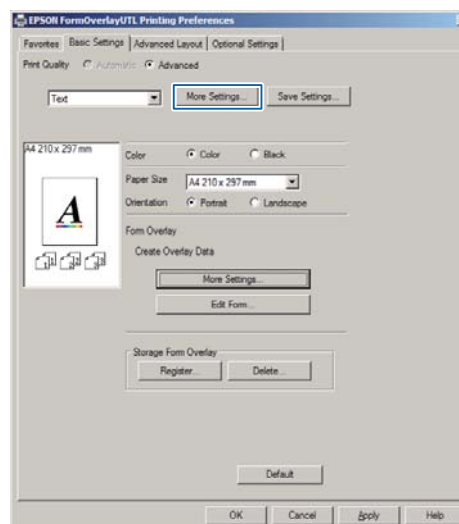

## Printing Tasks

- 4 Type the form name in the Form data box and its description in the Description box.

**Note:**

The following 9 characters cannot be used for form names: \ / : \* ? " < > |.

- 5 Select **Foreground Document** or **Background Document** to specify whether the overlay will be printed as foreground or background of the document, then click **OK**.

- 6 Make the appropriate settings for other settings such as paper size, print quality or orientation.

- 7 Click **OK**.

- 8 Click **Print** to create the form data.

**Note:**

To change the settings of the overlay form data you created, after doing steps 1 and 2 and the settings in the Basic Settings tab — Form Overlay — Create Overlay Data, click the **Edit Form**.

### Printing an overlaid document

- 1 Open the document on which you want to overlay the form data.
- 2 Select **Print** from the File menu, select your printer name, then click **Preferences**.
- 3 In the More Options tab, check the **Form Overlay** check box, and click **Settings**. The Form Selection dialog box appears.
- 4 Select one form data in the Form data box, select **Overlay** or **Underlay** in the Layering list, then click **OK**.
- 5 Click **OK**.
- 6 Click **Print** to print the document with the form data.

## Improving the clarity of color documents

### Printing text clearly in black

When you print a color document, the quality of text can be made more legible by printing it in black.

- 1 Click the **More Options** tab, and click **Image Options**.
- 2 Select **Print Text in Black** from the Visibility drop-down list.
- 3 Click **OK**.

For more information, see the printer driver help.

## Making Printer Settings (AL-M220DN only)

You can check and set printer items that are frequently used such as Cassette1 Size, Cassette1 Type, Time Setting, and Time to Sleep, from the Printer Settings menu in the printer driver.

On how to access this menu and what items you can set, see [“How to access the control panel menus \(AL-M320DN/AL-M310DN\)”](#) on page 17.

**Note:**

A warning appears if the time is not set after purchasing the printer. Use Printer Settings to set the time.

## Using Deep Sleep Mode to Save Energy

Your printer can enter deep sleep mode to save energy.

You can know whether the printer is in deep sleep mode.

**For AL-M320DN/AL-M310DN:**

The **Wakeup/Sleep** button is lit or blinked.

## Printing Tasks

For AL-M220DN:  
The **Ready** light flashes.

**Note:**

To wake up the printer from deep sleep mode, do one of the following operations:

- Press the Wakeup/Sleep button (For AL-M320DN/AL-M310DN)
- Press any button (for AL-M220DN)
- Turn the printer off and then back on
- Send a print job to the printer

## Entering the deep sleep mode manually (For AL-M320DN/AL-M310DN)

To immediately enter the deep sleep mode, press the Wakeup/Sleep button.

## Entering the deep sleep mode automatically

### Setting the time-to-sleep time

Selecting a value from the time-to-sleep options in the Energy Saver Menu.

| Item                | Value                                                                                                    |
|---------------------|----------------------------------------------------------------------------------------------------------|
| Time to Sleep(Auto) | <b>Disable</b> (default)                                                                                 |
| Time to Sleep       | 0 or 1 minute by default, or you can select a value. For the values, see "Energy Saver Menu" on page 25. |

To make a weekly sleep schedule, see "Making a weekly sleep schedule" on page 59.

Selecting the value (time) which is calculated from the printer's operation history

| Item                | Value  |
|---------------------|--------|
| Time to Sleep(Auto) | Enable |
| Time to Sleep       | -      |

To make a weekly sleep schedule, see "Making a weekly sleep schedule" on page 59.

## Making a weekly sleep schedule

This section shows an image of a weekly sleep schedule.

See "Sleep Schedule Menu" on page 26 for the setting items.

Use EpsonNet Config with a web browser for these settings. See the *Network Guide* for the procedure to access EpsonNet Config with a web browser.

**Note:**

Changing the settings for Time to Sleep (Auto), Time to Sleep, and Sleep Schedule may affect printer power consumption, the service life of the fuser unit (the maintenance unit for AL-M320DN/AL-M310DN), or the printer (for AL-M220DN).

### Example of one day sleep schedule:

The printer is set to immediately enter the deep sleep mode during the time in shaded areas.

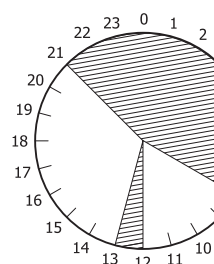

### Example of one week sleep schedule:

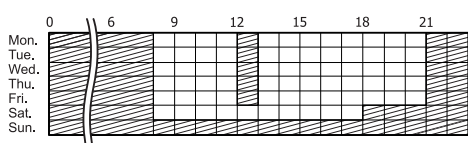

## Changing the Printer Driver's Default Settings (for Administrators)

**Note:**

- The explanations below use Windows 7 as an example.
- Power User or higher privileges are required to change the printer driver's default settings.

## Printing Tasks

### Changing the default settings

Access the printer driver's properties from Start - Devices and Printers. The settings you change becomes the new default values for printing from all applications.

However, if you access the properties from an application, the changed settings are only temporarily available in that application.

### Locking the default settings

The settings for functions, such as Watermark and Header/Footer, can be locked to prevent users from changing the printer driver settings.

- 1 Access the printer driver's properties from Start - Devices and Printers.
- 2 Access the Optional Settings tab, click the Driver Settings button, and select the functions you want to lock.
- 3 Click OK.

## Using EPSON Status Monitor

### Accessing EPSON Status Monitor

EPSON Status Monitor is a utility program on your computer that monitors your printer and gives you information about its current status such as printer errors, the remaining service lives of the replacement parts, or progress of printing.

To install the utility, see ["Installing Software"](#) on page 62.

With this utility installed, Simple Status appears on the computer screen when an error occurs. Clicking the **Details** button displays the Detailed Status.

#### Simple Status:

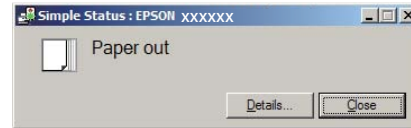

#### Detailed Status:

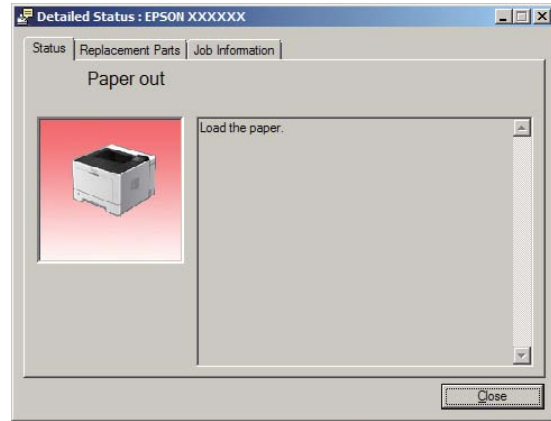

When you want to know the current status of the printer, click the EPSON Status Monitor tray icon on the taskbar, then select the printer name and menu you want to access.

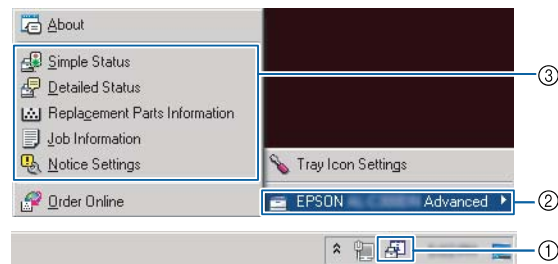

When you want to know the remaining service lives of the replacement parts, click **Replacement Parts Information**.

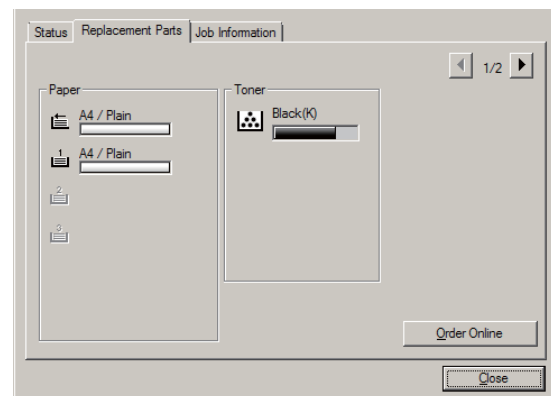

## Printing Tasks

### Notice Settings

This setting decides what states of the printer the utility sends you a notice.

#### Accessing from the taskbar:

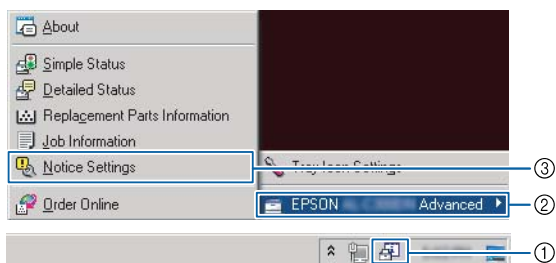

#### Accessing from the printer driver:

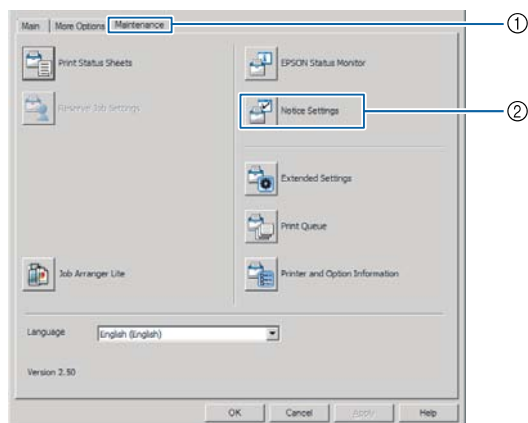

### Tray Icon Settings

This setting decides the screen to be opened when you double-click the EPSON Status Monitor tray icon on the taskbar.

- 1 Right-click the tray icon on the taskbar and click **Tray Icon Settings**.
- 2 Set the printer name and information to display in the Tray Icon Settings.

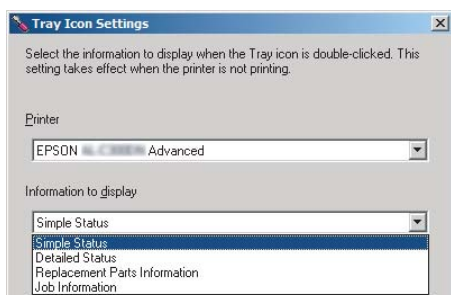

### Cancelling a Print Job

This section describes how to delete and cancel a print job in the computer or in a printer.

#### From the printer

##### For AL-M320DN/AL-M310DN

Follow the steps below to cancel a job.

- 1 Press the **Pause/Release** button.
- 2 Press the **Down** or **Up** button to select the job that you want to cancel, then press the **OK** button.
- 3 Press the **Down** or **Up** button to select **Cancel Job**, then press the **OK** button. Printing is canceled.

**Note:**

Select **Cancel All Jobs** in step 3 to cancel all print jobs in the printer's memory.

##### For AL-M220DN

To cancel a job, press the **Job Cancel** button on the printer's control panel.

#### From the computer

##### For Windows

- 1 Click the **Maintenance** tab on the printer driver, then click **Print Queue**.
- 2 Right-click the job you want to cancel, and select **Cancel**.

## Uninstalling and Installing Software

# Uninstalling and Installing Software

## Uninstalling Software

You must uninstall the software before you can upgrade it or reinstall it.

**Note:**

- Uninstalling the printer software may require administrator privileges.
- Restart the computer before you reinstall the software you uninstalled.

To uninstall the printer software, close all applications first, and then uninstall the printer software from the following menu on the Control Panel.

- Uninstall a Program** (for Windows 10, Windows 8.1, Windows 8, Windows Server 2012/R2, Windows Server 2016)
- Program and Features** (for Windows 7, Windows Vista, Windows Server 2008/R2)
- Change or Remove Programs** (for Windows XP or Windows Server 2003)

Select the printer software that you want to uninstall, and then click the item below.

- Uninstall/Change** (for Windows 10, Windows 8.1, Windows 8, Windows 7, Windows Vista, Windows Server 2008/R2, Windows Server 2016)
- Change/Remove** (for Windows XP or Windows Server 2003)

**Note:**

If you uninstall the printer driver, EPSON Status Monitor is also uninstalled.

**Note for Mac OS users:**

- To uninstall all drivers for Epson page printer at once, use the uninstaller. Download the uninstaller from the Epson website.  
<http://www.epson.eu/Support> (Europe)  
<http://support.epson.net/> (outside Europe)
- To use the uninstaller, double-click the uninstaller icon, from the list displayed select the check box for the printer software you want to uninstall, then click **Uninstall**.

## Installing Software

If you want to install or reinstall software you did not install in the setup, you can choose the software and install it.

**Note:**

- Uninstalling the printer software may require administrator privileges.
- Restart the computer before you reinstall the software you uninstalled.

- 1** Close all applications.
- 2** To install the printer driver via a USB interface, disconnect the USB cable from the printer and do not connect it until instructed to do so.
- 3** Go to the following Epson web site to download and install the printer software.  
<http://www.epson.eu/Support> (Europe)  
<http://support.epson.net/> (outside Europe)

**Note:**

- For Windows users, if the computer has a disc drive, you can install the printer driver from the Software Disc that came with your printer.
- The following Epson websites are available for Windows users who want to install the ESC/Page printer driver.  
<http://epson.sn/>

## Uninstalling and Installing Software

### Installing the PostScript printer driver with Windows

To print in the PostScript mode, you will have to install the printer driver. See the appropriate sections below for installation instructions according to the interface that you are using to print.

### Installing the PostScript printer driver for the USB interface

**Note:**

- Installing the printer software for Windows may require administrator privileges. If you have problems, ask your administrator for more information.*
- Turn off all virus protection programs before installing the printer software.*

- 1** Make sure that the printer is turned off. Insert the printer Software Disc into your disc drive.

**Note:**

*If your computer does not have a disc drive, download the driver from the Epson website. <http://www.epson.eu/Support> (Europe)*

- 2** Connect your computer to the printer with a USB cable, then turn on the printer.

**Note for Windows Vista users:**

*Without the Windows driver or the PostScript driver, the display shows "Found New Hardware." In this case, click **Ask me again later**.*

- 3** Select **Devices and Printers**, and click the **Add a printer** button.

For Windows 10 and Windows Server 2016, right-click the start button or press and hold it, select **Control Panel**, click **View devices and printers**, then click **Add a printer** button.

For Windows 8.1 or Windows 8, right-click the bottom left corner of the screen in the desktop style, select **Control Panel**, click **View devices and printers**, then click **Add a printer** button.

For Windows Vista, Windows XP, or Windows Server 2008/R2, click **Start**, point to **Printer and Faxes**, then click **Add a printer** in the Printer Tasks menu.

For Windows Server 2003, click **Start**, point to **Settings**, and click **Printers**. Then double-click the **Add Printer** icon.

The Add Printer Wizard appears.

- 4** Select **Add a local printer**.

For Windows XP or Windows Server 2003, click **Next** to proceed the next screen, select **Local printer**, then click **Next**.

**Note:**

*Do not select the **Automatically detect and install my Plug and Play printer** check box.*

- 5** Select **USB** as the port the printer is connected to, then click **Next**.

- 6** Click **Have Disk** and specify the following path for the Software Disc. If your disc drive is D:, the path will be D:\Driver\PostScript\epsnt.inf. Then click **OK**.

**Note:**

*Change the drive letter as needed for your system.*

- 7** Select the printer, then click **Next**.

- 8** Follow the on-screen instructions for the rest of the installation.

- 9** When installation is done, click **Finish**.

### Installing the PostScript printer driver for the network interface

**Note:**

- Set the network settings before installing the printer driver. Refer to the Network Guide for your printer for details.*
- Turn off all virus protection programs before installing the printer software.*

## Uninstalling and Installing Software

- 1 Make sure that the printer is turned on. Insert the printer Software Disc into your disc drive.

**Note:**

If your computer does not have a disc drive, download the driver from the Epson website.  
<http://www.epson.eu/Support> (Europe)

- 2 Select **Devices and Printers**, and click the **Add a printer** button.

For Windows 10 and Windows Server 2016, right-click the start button or press and hold it, select **Control Panel**, click **View devices and printers**, then click **Add a printer** button.

For Windows 8.1 or Windows 8, right-click the bottom left corner of the screen in the desktop style, select **Control Panel**, click **View devices and printers**, then click **Add a printer** button.

For Windows Vista, Windows XP, or Windows Server 2008/R2, click **Start**, point to **Printer and Faxes**, then click **Add a printer** in the Printer Tasks menu.

For Windows Server 2003, click **Start**, point to **Settings**, and click **Printers**. Then double-click the **Add Printer** icon.

The Add Printer Wizard appears.

- 3 Select **Add a local printer**.

For Windows XP or Windows Server 2003, click **Next** to proceed the next screen, select **Local printer**, then click **Next**.

**Note:**

Do not select the **Automatically detect and install my Plug and Play printer** check box.

- 4 Select the **Create a new port** check box and select **Standard TCP/IP Port** from the drop-down list. Click **Next**.

- 5 (For Windows XP or Windows Server 2003 users only) Click **Next**.

- 6 Specify the IP address and port name, then click **Next**.

- 7 Click **Finish**.

- 8 Click **Have Disk** in the Add Printer Wizard and specify the following path for the Software Disc. If your disc drive is D:, the path will be D:\Driver\PostScript\eppsnt.inf. Then click **OK**.

**Note:**

Change the drive letter as needed for your system.

- 9 Select the printer and click **Next**.

- 10 Follow the on-screen instructions for the rest of the installation.

- 11 When installation is done, click **Finish**.

## Installing the PostScript printer driver with Mac OS

### Installing the PostScript printer driver

Go to the following Epson support website to download and install the driver.

<http://www.epson.eu/Support> (Europe)

### Selecting the printer

After installing the PostScript printer driver, you need to select the printer.

#### In a network environment

**Note:**

- You need to make the settings for your installed options manually when the printer is connected using USB, IP printing, or Bonjour.
- Make sure to specify ASCII as the data format in the application.

- 1 Open the System Preferences, and then double-click the Print & Fax ("Print & Scan" for Mac OS X 10.7 or later) icon. The Print & Fax ("Print & Scan" for Mac OS X 10.7 or later) window appears.



## Uninstalling and Installing Software

- 2 Click  in the Printers window.
- 3 Select the printer name that you are using from the printer name box.

**Note:**

*If your printer is not listed, check that it is correctly connected to the computer and that the printer is on.*

- 4 Click **Add**.
- 5 Confirm that your printer's name is added to the Printers list. Then quit **Print & Fax** ("**Print & Scan**" for Mac OS X 10.7 or later).

---

## Installing the PCL printer driver (For Windows only)

Epson Universal Print Driver is the universal PCL6 compatible print driver that has the following features:

- It supports the basic print functions needed for business situations.
- It supports multiple Epson business printers besides this printer.
- It supports most languages among the print drivers for this printer.

**Note:**

*It also supports printing in ESC/Page mode.*

- 1 Download the driver's executable file from the Epson support website.  
<http://www.epson.eu/Support> (Europe)  
<http://support.epson.net/> (outside Europe)

**Note:**

*We recommend downloading the latest driver from the website. However you can also find it on the software disc that came with the printer. Access "Driver\Universal".*

- 2 Double-click the executable file that you downloaded from the website or that is on the software disc.

- 3 Follow the on-screen instructions for the rest of the installation.
- 4 After the installation is done, access your printer's **Properties** and **Printing Preferences** to customize the printer driver settings.

## Maintaining the Printer

# Maintaining the Printer

## Replacing Consumable Products/Maintenance Parts

### Precautions during replacement

Always observe the following handling precautions when replacing consumable products/maintenance parts.

For details about the replacements, see the instructions that come with the consumable products.



**Caution:**

- Be careful not to touch the fuser, which is marked with a caution label, or the surrounding areas. If the printer has been in use, the fuser and surrounding areas may be very hot.
- Do not dispose of used consumable products/maintenance parts in fire, as they may explode and cause injury. Dispose of them according to local regulations.

- Provide enough space for the replacement procedure. You will have to open some parts (such as the printer cover) of the printer when you are replacing consumable products/maintenance parts.
- Do not install used consumable products that reach end of service life into the printer.

For details about the handling precautions, see [“Handling the consumable products and maintenance parts” on page 9](#).



If a consumable product reaches the end of its service life, the printer displays the following message on the LCD panel or the window of EPSON Status Monitor.

## Replacement Messages/Lights











### For AL-M320DN/AL-M310DN

| LCD Panel Message |                            |
|-------------------|----------------------------|
|                   | Replace Toner Cartridge    |
|                   | Replace Maintenance Unit A |
|                   | Replace Maintenance Unit B |

### For AL-M220DN

|                                                                                     |                                                  |
|-------------------------------------------------------------------------------------|--------------------------------------------------|
|  | light on                                         |
|  | Light off                                        |
| —                                                                                   | Status-specific (either lit, blinking, or unlit) |

### Maintaining the Printer

|  |  |  |  |  | Data | <b>Statuses and handling methods (status monitor messages in bold)</b>                                                                                                                                                             |
|-----------------------------------------------------------------------------------|-----------------------------------------------------------------------------------|-----------------------------------------------------------------------------------|-----------------------------------------------------------------------------------|-----------------------------------------------------------------------------------|------|------------------------------------------------------------------------------------------------------------------------------------------------------------------------------------------------------------------------------------|
|  |  |  |  |  | —    | <p><b>Replace Toner cartridge</b></p> <p>The toner cartridge has reached the end of their service life and need to be replaced.</p> <p>For details about replacement, see the instructions that come with the toner cartridge.</p> |

## Maintaining the Printer

### Cleaning the Printer

The printer needs only minimal cleaning to keep it in good condition.

If the printer's outer case is dirty or dusty, turn off the printer and clean it with a soft, clean cloth moistened with a mild detergent.



**Important:**

*Never use alcohol or paint thinner to clean the printer cover. These chemicals can damage the components and the case. Be careful not to get water onto the printer mechanism or any electrical components.*

### Cleaning the inner roller

**1** Turn the printer off, wait until the operation panel is unlit, and then unplug the power plug from the outlet.

**2** Press the button on the top, then open covers F1 and F2.

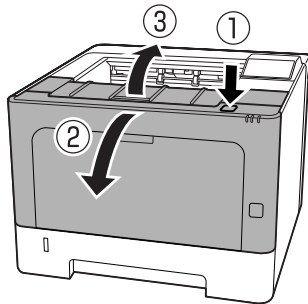

**Important:**

*Do not touch the inner rollers and gears. Doing so may cause malfunctions or a deterioration in print quality.*

**3** Press lever A on left side.

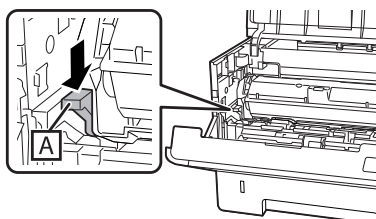

**4** Remove the maintenance unit A.

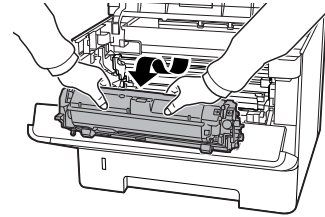

**5** Place maintenance unit A horizontally in a clean location.

Do not stand it on end.

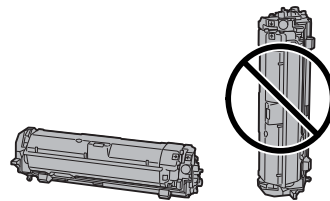

**6** Remove the maintenance unit B while holding section B.

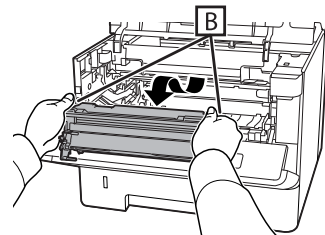

**7** Place maintenance unit B horizontally in a clean location.

Do not stand it on end.

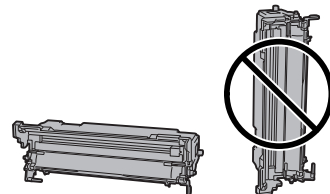

### Maintaining the Printer

- 8** Gently wipe the metallic roller inside with a soft and dry cloth to remove the grime and paper particles.

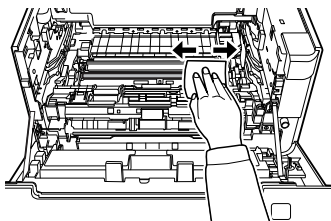

- 9** Lift up the rail guard on the top part of maintenance unit B.

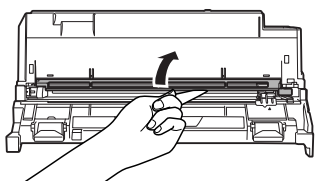

- 10** Hold the grip of the cleaner on the top part of maintenance unit B and move it back and forth, 2 or 3 times.

The first time you do this work, remove the tape stuck securing grip, and then move it.

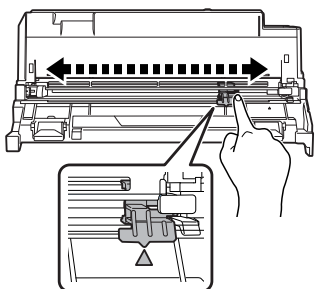

- 11** Return the grip to its original position (▲ mark).

Make sure to return the grip to the ▲ mark position. If it is not in this position, you will not be able to remove Maintenance Unit B the next time.

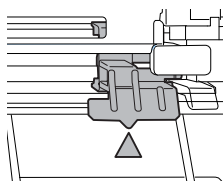

- 12** Insert the maintenance unit B.

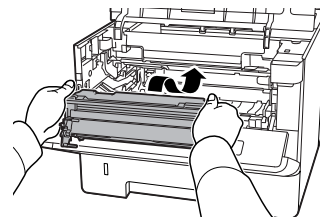

- 13** Insert the maintenance unit A.

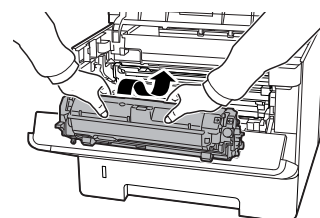

- 14** Close covers F1 and F2.

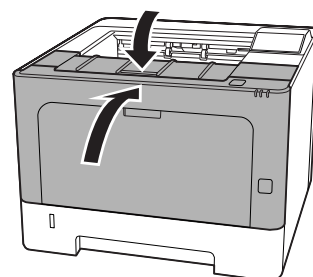

## Troubleshooting

# Troubleshooting

## Status and Error Messages on the Control Panel (for AL-M320DN/AL-M310DN)

This section describes the messages and the meaning of the messages that appear on the LCD panel.

When the **◆** mark is displayed at the right of the warning message, multiple warnings have occurred. Pressing the **▲ Up** or **▼ Down** buttons displays the warnings.

### Note:

- ❑ If **◀ Press for help** is displayed on the LCD panel, press the **◀ Left** button to show the help. Then press the **▼ Down** button for next step, the **▲ Up** button for previous step, or **◀ Left** button to close the help.
- ❑ To clear a warning message, select **Reset Menu** in **Common Settings** from the control panel, then select **Clear Warning**. See [“How to access the control panel menus \(AL-M320DN/AL-M310DN\)” on page 17](#) for instructions.

### Adjusting Printer

Wait a few minutes. Do not open or close the covers, or turn off the printer until this message disappears.

### Bookmark Failed

The selected menu cannot be registered as a bookmark. Some menus cannot be registered as bookmarks.

### Bookmark Registered

The selected menu is registered as a bookmark.

### Canceling All Job

The printer is canceling all print jobs in the printer memory, including jobs the printer is currently receiving or printing. This message appears when **Cancel All Jobs** is selected on the control panel.

### Canceling Job

The printer is canceling the specified print job and the current print job. This message appears when **Cancel Job** is selected after you specify the file to be canceled on the control panel.

### Can't Print

The print data is deleted because it is incorrect.

Make sure the appropriate paper size and printer driver are used.

### Can't Print Duplex

The printer has encountered problems during duplex printing. Make sure you are using an appropriate type and size of paper for the duplex printing. The problem could also be a result of incorrect settings for the paper source you are using. Pressing the **OK** button will print the rest of the print job on only one side of the paper. To cancel the print job, see [“Canceling a Print Job” on page 61](#).

### Can't Use Bookmark

The registered menu cannot be used because the menu is disabled by changing any settings after registered the menu in bookmark.

### Check Cassette xx (AL-M320DN/AL-M310DN only)

This is the message that appears when warnings are set for no cassettes and no paper.

The cassette that is indicated by an "x" either has no paper or the cassette is missing. Correctly load the paper and cassette, and then press the **OK** button.

### Check Media Type

The paper loaded in the printer does not match the paper type setting in the printer driver. Paper that matches only the paper size setting will be used for printing.

To clear this warning message, select **Clear Warning** from the control panel's **Reset Menu**.

### Check Paper Size

The paper size setting is different from the size of paper loaded in the printer. Check to see if the correct size of paper is loaded in the specified paper source.

## Troubleshooting

To clear this warning message, select **Clear Warning** from the control panel's **Reset Menu**.

### Clear Paper Jam **www**

The location where the paper jam occurred is displayed at **www**. **www** indicates the location of the error.

If a paper jam occurs at two or more locations simultaneously, the corresponding multiple locations are displayed.

For details about clearing paper jams, see [“Clearing Jammed Paper” on page 82](#).

### Close Cover **www**

The specified cover (**www**) does not close securely. Open the cover once, and then close.

### Collate Disabled

Printing by specifying the number of copies is no longer possible due to a lack of memory (RAM). If this warning message appears, print only one copy at a time.

To clear this warning message, select **Clear Warning** from the control panel's **Reset Menu**.

### Correct Time using Time Setting

The time and date are at their default values. Set the time and date.

To clear this warning message, select **Clear Warning** from the control panel's **Reset Menu**.

### Duplex Memory Overflow

There is not enough memory for duplex printing. The printer prints only on the front and ejects the paper. To clear this error, follow the instructions below.

If **Off** is selected as the **Auto Cont** setting on the control panel's **Setup Menu**, press the **OK** button to print on the back of the next sheet, or cancel the print job. To cancel the print job, see [“Cancelling a Print Job” on page 61](#).

If **On** is selected as the **Auto Cont** setting on the control panel's **Setup Menu**, printing continues automatically after a certain period of time.

### F/W Update

Firmware is being updated. Do not turn off the power until the update is complete.

### F/W Update: Error

The firmware update failed. Turn the power off and on, and then try to update again.

### Feed Roller C1 Needed Soon, Feed Roller C2 Needed Soon (AL-M320DN only), Feed Roller C3 (AL-M320DN only)

This warning message indicates that the indicated feed roller is near the end of its service life. You can continue printing until a message to replace the indicated feed roller appears.

### Filling Toner **mm min**

Wait **mm** minutes for the toner to fill.

### Form Feed

The printer is ejecting paper due to a user request. This message appears when pressing the **Pause/Release** button once, then holding down the **OK** button for more than 2 seconds because the printer has not received a form feed command.

### Fuser Needed Soon (AL-M320DN only)

This message indicates that the fuser unit is near the end of its service life. You can continue to print until the **Replace Fuser** message appears.

### Image Optimum

There is insufficient memory to print the page at the specified print quality. The printer automatically lowers the print quality so that it can continue printing. If the quality of the printout is not acceptable, try simplifying the page by limiting the number of graphics or reducing the number and size of fonts.

To clear this warning message, select **Clear Warning** from the control panel's **Reset Menu**.

### Install Toner Cartridge

The toner cartridge is not installed in the printer.

Install the toner cartridge. See the instructions that come with the toner cartridge.

### Invalid Data

## Troubleshooting

The spool file on the driver is deleted while printing or the data is abnormal. Press the **OK** button to clear the error.

### Invalid PS3

There are errors in the ROM module. Turn off the printer and contact your dealer.

### Maintenance Unit A Needed Soon, Maintenance Unit B Needed Soon

The indicated maintenance unit is near the end of its service life. You can continue to print until the `Replace Maintenance Unit A` or `Replace Maintenance Unit B` message appears. To clear this warning message and continue printing, select `Clear All Warnings` from the control panel's `Reset Menu`.

### Manual Feed ssss

The manual feed mode is specified for the current print job. Make sure the paper size indicated by `ssss` is loaded, then press the **OK** button.

### Memory Overflow

The printer has insufficient memory to execute the current task. Press the **OK** button on the control panel to resume printing, or cancel the print job. To cancel the print job, see [“Cancelling a Print Job” on page 61](#).

### Need Memory

The printer has insufficient memory to complete the current print job.

To clear this warning message, select `Clear Warning` from the control panel's `Reset Menu`.

To prevent this problem from recurring, reduce the resolution of the image to be printed.

### No trays available (AL-M320DN/AL-M310DN only)

No trays are selected in `Printer Settings > Tray Menu`

```
-MP Tray AutoSel
-Cassette1 AutoSel
-Cassette2 AutoSel
-Cassette3 AutoSel
```

Press **Pause/Release** button and cancel the print job.

### Non-Genuine Toner Cartridge

The installed toner cartridge is not a genuine Epson toner cartridge. Installing a genuine toner cartridge is recommended.

The printout and remaining service life of the toner cartridge displayed on the control panel may be different from those when using genuine Epson toner cartridges. Epson shall not be liable for any damages or problems arising from the use of consumable products not manufactured or approved by Epson.

Press the **OK** button on the control panel to resume printing.

### Paper Out XX

This appears in the following situations.

- Paper is not loaded in paper source "xxxxx" from which the printer tried to feed.  
Loading size "yyyy" paper into paper source "xxxxx" clears the error and printing starts.
- There is no paper loaded in any paper source.  
Loading paper into any paper source clears the error and printing starts.
- Paper cassette is not inserted correctly.  
Slowly push the cassette all the way in, and then confirm that it is securely inserted.
- A4 or LT size is not loaded in paper source "xxxxx" when the setting for A4/LT Auto Switching is something other than Off.

To print, load A4 or LT size paper into paper source "xxxxx", and then press the **OK** button.

To cancel printing, press the **WakeUp/Sleep** button, and then cancel by selecting a job operation.

### Paper Out tttt sssss

There is no paper in the specified paper source (tttt). Load paper of the size (sssss) into the paper source.

### Paused

A state in which print data is created and data is received, but the print operation does not start. Pressing the **Pause/Release** button returns the printer to a printable state.

Printing restarts if the printer is left paused for about a minute.

### Please Wait



## Troubleshooting

Printing cannot start because the previous job is being processed. Try again after a few seconds.

### Print Overrun

The required time to process the print data exceeded the print engine speed because the current page is too complex. Press the **OK** button to resume printing, or cancel the print job. To cancel the print job, see [“Cancelling a Print Job” on page 61](#). If this message appears again, select **On** as the **Page Protect** setting in the control panel's **Setup Menu**.

If you continue to receive this message when printing a particular page, try simplifying the page by limiting the number of graphics or reducing the number and size of fonts.

### RAM CHECK

The printer is checking the RAM.

### Ready

The printer is ready to receive data and print.

### Reboot to apply settings

You selected **No** when **Do you want to reboot to apply the settings?** was displayed. To clear this warning message, select **Clear Warnings** from the control panel's **Reset Menu**.

### Recovery Mode

Because the firmware update failed, the printer started in recovery mode. Use the steps below to try to update the firmware again.

1. Connect the computer and the printer with a USB cable (network connections cannot be done for updates during recovery mode).
2. Download the newest firmware from the Epson web site, and then update.

### Replace Feed Roller C1, Replace Feed Roller C2, Replace Feed Roller C3 (AL-M320DN only)

The indicated feed roller has reached the end of its service life and needs to be replaced. Press the **OK** button to clear this error.

### Replace Fuser (AL-M320DN only)

The fuser has reached the end of its service life and needs to be replaced. If this error occurs, consult your dealer.

### Replace Maintenance Unit A, Replace Maintenance Unit B

The indicated maintenance unit has reached the end of its service life and needs to be replaced. Press the **OK** button to clear this error.

### Replace Toner Cartridge

The toner cartridge has reached the end of their service life and needs to be replaced.

For details about replacement, see the instructions that come with the toner cartridge.

### Reserve Job Canceled

The printer cannot store the data of your print job using the **Reserve Job** function. The maximum number of print jobs stored on the printer's memory has been reached, or the memory has no more memory available to store a new job. To store a new print job, delete a previously stored job. Also, if you have any **Confidential Job** stored, printing those jobs will make more memory available.

You may also increase the available memory space by changing the **RAM Disk** setting to **Normal** or **Maximum**. For details, see [“Setup Menu” on page 21](#).

To clear this warning message, select **Clear Warnings** from the control panel's **Reset Menu**.

### Reset All

All printer's interface has been reset and the buffer has been cleared. The printer reboots automatically.

### Reset to Save

A control panel menu setting was changed while the printer was printing. Press the **OK** button to clear this message. The setting will become effective after printing has finished.

Alternatively you can clear this message by performing **Reset All** on the control panel. However, the print data will be deleted.

### ROM CHECK

The printer is checking the ROM.

## Troubleshooting

### Wrong Password (AL-M320DN/AL-M310DN only)

This appears if you change your password in Password Config on the operation panel.

### SELF TEST

The printer is currently performing a self test and initialization.

### Service Req Cffff/ Service Req Exxx

A controller error or a print engine error has been detected. Turn off the printer. Wait at least a few seconds, then turn it back on. If the error message still appears, write down the error number listed on the LCD panel (Cffff/Exxx), turn off the printer, unplug the power cord, then contact a qualified service representative.

### Set Paper tttt pppp

The paper loaded in the specified paper source (tttt) does not match the required paper type (FFFF). Replace the loaded paper with the correct paper type and press the **OK** button to resume printing, or cancel the print job. To cancel the print job, see [“Cancelling a Print Job” on page 61](#).

If you press the **OK** button without replacing the paper, the printer will print on the loaded paper even though it does not match the required paper type.

### Set Paper tttt ssss

The paper loaded in the specified paper source (tttt) does not match the required paper size (sssss). Replace the loaded paper with the correct size paper and press the **OK** button to resume printing, or cancel the print job. To cancel the print job, see [“Cancelling a Print Job” on page 61](#).

If you press the **OK** button without replacing the paper, the printer will print on the loaded paper even though it does not match the required size.

### Set Paper tttt ssss1 or ssss2

This message appears in the following situations if A4/LT Auto Switching in Setup Menu is set to A4->LT, LT->A4 or A4<->LT:

- When printing a job specified as A4 with the printer driver, there is no paper source that is set as A4 or as LT (alternate size for A4) in the Tray Menu.

- When printing a job specified as letter size with the printer driver, there is no paper source that is set as LT or as A4 (alternate size for LT) in the Tray Menu.

To clear this warning message, make sure that A4 or LT is set to the specified paper source (tttt) in the Tray Menu, load A4 or Letter size paper (ssss1 or ssss2) in the specified paper source (tttt) and click the **OK** button, or cancel the print job. To cancel the print job see [“Cancelling a Print Job” on page 61](#).

**Sleep** (while the **Wakeup/Sleep** button is lighting or blinking)

The printer is currently in the power-save mode. This mode is canceled when the printer receives print data.

### Toner Cartridge Error

There is a problem with the toner cartridge.

Remove the toner cartridge and reinsert it. If that fails to clear the error, replace the toner cartridge with a new one. For details about replacement, see the instructions that come with the toner cartridge.

### Toner Low

The toner cartridge is near the end of its service life. Prepare a new toner cartridge.

**Turn Paper MP Tray, Turn Paper Cassette1, Turn Paper Cassette2** (AL-M320DN/AL-M310DN only), **Turn Paper Cassette3** (AL-M320DN/AL-M310DN only)

The orientation (portrait or landscape) of the paper that is set in the indicated paper source is not correct. Change the orientation of the paper in the paper source.

### Unable Clear Error

The printer cannot clear an error message because the error status still remains. Try solving the problem again.

### Warming Up

The printer is warming up the fuser to be ready to print.

### Wrong Toner Cartridge

An inappropriate toner cartridge is installed.

## Troubleshooting

Install only the toner cartridge listed in [“Consumable Products and Options”](#) on page 107.

## Troubleshooting

# Status and Error Lights (for AL-M220DN)

You can check the printer status from combinations and patterns of the lights on the control panel.

**Note:**

You can check the printer status and error easily on the Windows computer by using EPSON Status Monitor. See [“Using EPSON Status Monitor”](#) on page 60 for more information.



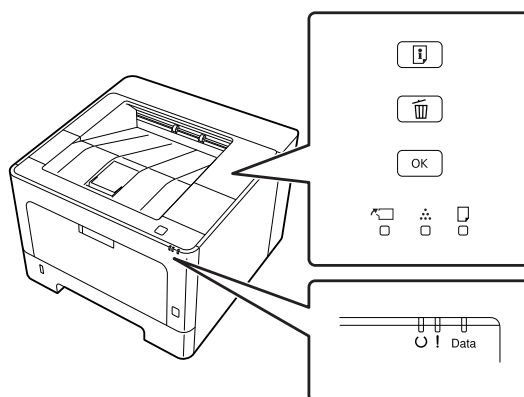





































The status of the lights are illustrated below.











|   |                                                      |
|---|------------------------------------------------------|
|   | light on                                             |
|   | blink1: turn on for 0.3 seconds, off for 0.3 seconds |
|   | blink2: turn on for 0.6 seconds, off for 0.6 seconds |
|   | blink3: turn on for 0.6 seconds, off for 2.4 seconds |
|   | blink4: turn on for 1.2 seconds, off for 1.2 seconds |
|   | Light off                                            |
| — | Status-specific (either lit, blinking, or unlit)     |

|  |   |   |   |  | Data | <b>Statuses and handling methods (status monitor messages in bold)</b>                                                                                                                                       |
|--|---|---|---|--|------|--------------------------------------------------------------------------------------------------------------------------------------------------------------------------------------------------------------|
|  | — | — | — |  | —    | <p><b>Correct time using Time Setting</b></p> <p>Time is not set in the printer. Set time using Time Setting.</p> <p>See <a href="#">“How to access the control panel menus (AL-M220DN)”</a> on page 17.</p> |























































## Troubleshooting

|    |    |    |    |    | Data | <b>Statuses and handling methods (status monitor messages in bold)</b>                                                                                                                                                                                                                                                                                                                                                                                                                                                                                                                                                                                                       |
|-------------------------------------------------------------------------------------|-------------------------------------------------------------------------------------|-------------------------------------------------------------------------------------|-------------------------------------------------------------------------------------|-------------------------------------------------------------------------------------|------|------------------------------------------------------------------------------------------------------------------------------------------------------------------------------------------------------------------------------------------------------------------------------------------------------------------------------------------------------------------------------------------------------------------------------------------------------------------------------------------------------------------------------------------------------------------------------------------------------------------------------------------------------------------------------|
|    |    |    |    |    | —    | <p><b>Install Toner Cartridge</b><br/>The toner cartridge is not installed in the printer. Install the toner cartridge.</p> <p><b>Wrong Toner Cartridge</b><br/>An inappropriate toner cartridge is installed. Install only the toner cartridge listed in <a href="#">"Consumable Products and Options"</a> on page 107.</p> <p><b>Toner Cartridge Error</b><br/>There is a problem with the toner cartridge. Remove the toner cartridge and reinsert it. If that fails to clear the error, replace the toner cartridge with a new one.</p> <p><b>Replace Toner cartridge</b><br/>The toner cartridge has reached the end of their service life and need to be replaced.</p> |
|    |    |    |    |    | —    | <p><b>Non-Genuine Toner Cartridge</b><br/>The installed toner cartridge is not a genuine Epson toner cartridge. Installing a genuine toner cartridge is recommended.</p> <p>The printout and remaining service life of the toner cartridge displayed on the control panel may be different from those when using genuine Epson toner cartridges. Epson shall not be liable for any damages or problems arising from the use of consumable products not manufactured or approved by Epson.</p> <p>Press the <b>OK</b> button on the control panel to resume printing.</p>                                                                                                     |
| —                                                                                   |  | —                                                                                   |  |  | —    | <p><b>Toner Low</b><br/>The toner cartridge is near the end of its service life. Prepare a new toner cartridge.</p>                                                                                                                                                                                                                                                                                                                                                                                                                                                                                                                                                          |
| —                                                                                   |  | —                                                                                   |  |  | —    | <p><b>Non-Genuine Toner Cartridge</b><br/>The installed toner cartridge is not a genuine Epson toner cartridge.</p>                                                                                                                                                                                                                                                                                                                                                                                                                                                                                                                                                          |
|  |  |  |  |  | —    | <p><b>Close Cover</b><br/>A cover is open or not closed securely. Open the cover once, and then close it.</p>                                                                                                                                                                                                                                                                                                                                                                                                                                                                                                                                                                |
|  |  |  |  |  | —    | <p><b>Check Paper Size</b><br/>The paper loaded in the specified paper source does not match the required paper size. Replace the loaded paper with the correct size paper and press the <b>OK</b> button to resume printing, or press the <b>Job Cancel</b> button to cancel the print job.</p>                                                                                                                                                                                                                                                                                                                                                                             |
|  |  |  |  |  | —    | <p><b>Clear Paper Jam</b><br/>A paper jam occurs. Clear the paper jam. See <a href="#">"Clearing Jammed Paper"</a> on page 82 for instructions.</p>                                                                                                                                                                                                                                                                                                                                                                                                                                                                                                                          |
|  |  |  |  |  | —    | <p><b>Manual Feed</b><br/>The Manual Feed setting is selected in the printer driver. Make sure that the desired paper is displayed in the printer driver and loaded in the manual feed slot on the MP tray. You have to press the <b>OK</b> button once when you want to print in manual feed mode. If you want to print from the MP tray or the optional 250-sheet Paper Cassette Unit after printing in the manual mode, be sure to clear the Manual Feed setting in the printer driver settings.</p> <p><b>Note:</b><br/><i>Before printing in the manual feed mode, take out the paper from other paper sources.</i></p>                                                 |

## Troubleshooting

|  |  |    |  |  | Data | <b>Statuses and handling methods (status monitor messages in bold)</b>                                                                                                                                                                                                                                                                                                                                                                                                                                                                                                                                                                                                                                                                                                                                                                                                                                                                                                                                                                                                                                                                                                                                                                                                                                                                                                                                                                                                                                                                                                              |
|-----------------------------------------------------------------------------------|-----------------------------------------------------------------------------------|-------------------------------------------------------------------------------------|-----------------------------------------------------------------------------------|-----------------------------------------------------------------------------------|------|-------------------------------------------------------------------------------------------------------------------------------------------------------------------------------------------------------------------------------------------------------------------------------------------------------------------------------------------------------------------------------------------------------------------------------------------------------------------------------------------------------------------------------------------------------------------------------------------------------------------------------------------------------------------------------------------------------------------------------------------------------------------------------------------------------------------------------------------------------------------------------------------------------------------------------------------------------------------------------------------------------------------------------------------------------------------------------------------------------------------------------------------------------------------------------------------------------------------------------------------------------------------------------------------------------------------------------------------------------------------------------------------------------------------------------------------------------------------------------------------------------------------------------------------------------------------------------------|
| <input type="checkbox"/>                                                          | <input type="checkbox"/>                                                          | <input checked="" type="checkbox"/>                                                 | <input type="checkbox"/>                                                          |  | —    | <p><b>Turn Paper MP Tray, Turn Paper Cassette1</b></p> <p>The orientation (portrait or landscape) of the paper that is set in the indicated paper source is not correct. Change the orientation of the paper in the paper source.</p>                                                                                                                                                                                                                                                                                                                                                                                                                                                                                                                                                                                                                                                                                                                                                                                                                                                                                                                                                                                                                                                                                                                                                                                                                                                                                                                                               |
| <input type="checkbox"/>                                                          | <input type="checkbox"/>                                                          | <input checked="" type="checkbox"/>                                                 | <input type="checkbox"/>                                                          |  | —    | <p><b>Can't Print Duplex</b></p> <p>The printer has encountered problems during duplex printing. The problem could also be a result of incorrect settings for the paper source you are using. Pressing the <b>OK</b> button will print the rest of the print job on only one side of the paper. To cancel the print job, see <a href="#">"Cancelling a Print Job" on page 61</a>.</p> <p><b>Set Paper</b></p> <p>The paper loaded in the specified paper source does not match the required paper size or type. Replace the loaded paper with the correct size paper or paper type, and press the <b>OK</b> button to resume printing. Pressing the <b>OK</b> button will print the rest of the print job on only one side of the paper. To cancel the print job, see <a href="#">"Cancelling a Print Job" on page 61</a>. To clear this warning, make sure that A4 or LT is set to the specified paper source in the Tray Menu, load A4 or Letter size paper in the specified paper source and click the <b>OK</b>.</p> <p><b>Note:</b><br/>If A4/LT Auto Switching in Setup Menu is set to A4-&gt;LT, LT-&gt;A4 or A4&lt;-&gt;LT:</p> <ul style="list-style-type: none"> <li><input type="checkbox"/> When printing a job specified as A4 with the printer driver, there is no paper source that is set as A4 or as LT (alternate size for A4) in the Tray Menu.</li> <li><input type="checkbox"/> When printing a job specified as letter size with the printer driver, there is no paper source that is set as LT or as A4 (alternate size for LT) in the Tray Menu.</li> </ul> |
| <input type="checkbox"/>                                                          | <input type="checkbox"/>                                                          | <input checked="" type="checkbox"/>                                                 | <input type="checkbox"/>                                                          | <input checked="" type="checkbox"/>                                               | —    | <p><b>Paper Out</b></p> <ul style="list-style-type: none"> <li><input type="checkbox"/> Paper is not loaded in the paper source from which the printer tried to feed. Loading paper clears the error and printing starts.</li> <li><input type="checkbox"/> There is no paper loaded in any paper source. Loading paper into any paper source clears the error and printing starts.</li> <li><input type="checkbox"/> Paper cassette is not inserted correctly. Push the cassette all the way in to securely insert it.</li> </ul>                                                                                                                                                                                                                                                                                                                                                                                                                                                                                                                                                                                                                                                                                                                                                                                                                                                                                                                                                                                                                                                  |
| —                                                                                 | —                                                                                 |  | —                                                                                 | <input type="checkbox"/>                                                          | —    | <p><b>Check Paper Size</b></p> <p>The paper size setting is different from the size of paper loaded in the printer. Check to see if the correct size of paper is loaded in the specified paper source.</p> <p><b>Check Media Type</b></p> <p>The paper loaded in the printer does not match the paper type setting in the printer driver. Paper that matches only the paper size setting will be used for printing.</p>                                                                                                                                                                                                                                                                                                                                                                                                                                                                                                                                                                                                                                                                                                                                                                                                                                                                                                                                                                                                                                                                                                                                                             |

## Troubleshooting

|    |    |    |    |    | Data                                                                                | <b>Statuses and handling methods (status monitor messages in bold)</b>                                                                                                                                                                                                                                                                                                                                                                                                                                                                                                                                                                                                                                                                                                                                                                                                                                                                                                                                                                                                                                                                                                                                                                                                                                                                                    |
|-------------------------------------------------------------------------------------|-------------------------------------------------------------------------------------|-------------------------------------------------------------------------------------|-------------------------------------------------------------------------------------|-------------------------------------------------------------------------------------|-------------------------------------------------------------------------------------|-----------------------------------------------------------------------------------------------------------------------------------------------------------------------------------------------------------------------------------------------------------------------------------------------------------------------------------------------------------------------------------------------------------------------------------------------------------------------------------------------------------------------------------------------------------------------------------------------------------------------------------------------------------------------------------------------------------------------------------------------------------------------------------------------------------------------------------------------------------------------------------------------------------------------------------------------------------------------------------------------------------------------------------------------------------------------------------------------------------------------------------------------------------------------------------------------------------------------------------------------------------------------------------------------------------------------------------------------------------|
|    |    |    |    |    | —                                                                                   | <p>There is not enough memory in the printer.</p> <p><b>Print Overrun</b></p> <p>The required time to process the print data exceeded the print engine speed because the current page is too complex. Press the <b>OK</b> button to resume printing, or cancel the print job. To cancel the print job, see <a href="#">“Cancelling a Print Job” on page 61</a>.</p> <p><b>Memory Overflow</b></p> <p>The printer has insufficient memory to execute the current task. Press the <b>OK</b> button on the control panel to resume printing, or cancel the print job. To cancel the print job, see <a href="#">“Cancelling a Print Job” on page 61</a>.</p> <p><b>Duplex Memory Overflow</b></p> <p>There is not enough memory for duplex printing. The printer prints only on the front and ejects the paper. Press the <b>OK</b> button to print on the back of the next sheet, or cancel the print job. To cancel the print job, see <a href="#">“Cancelling a Print Job” on page 61</a>.</p> <p><b>Invalid Data</b></p> <p>The spool file on the driver is deleted while printing or the data is abnormal. Press the <b>OK</b> button to clear the error and skip the page on which the error occurred. If there is a printable page, restart printing from there. To cancel the print job, see <a href="#">“Cancelling a Print Job” on page 61</a>.</p> |
|  |  |  |  |  |  | <p><b>Unable Clear Error</b></p> <p>The printer cannot clear an error message because the error status still remains. Try solving the problem again.</p>                                                                                                                                                                                                                                                                                                                                                                                                                                                                                                                                                                                                                                                                                                                                                                                                                                                                                                                                                                                                                                                                                                                                                                                                  |
|  |  |  |  |  |  | <p><b>FORMATTING</b></p> <p>Formatting (initializing). Please wait.</p>                                                                                                                                                                                                                                                                                                                                                                                                                                                                                                                                                                                                                                                                                                                                                                                                                                                                                                                                                                                                                                                                                                                                                                                                                                                                                   |
|  |  |  |  |  |  | <p><b>ROM CHECK</b></p> <p>The printer is checking the ROM. Please wait.</p>                                                                                                                                                                                                                                                                                                                                                                                                                                                                                                                                                                                                                                                                                                                                                                                                                                                                                                                                                                                                                                                                                                                                                                                                                                                                              |
|  |  |  |  |  |  | <p><b>RAM CHECK</b></p> <p>The printer is checking the RAM. Please wait.</p>                                                                                                                                                                                                                                                                                                                                                                                                                                                                                                                                                                                                                                                                                                                                                                                                                                                                                                                                                                                                                                                                                                                                                                                                                                                                              |
|  |  |  |  |  |  | <p><b>SELF TEST</b></p> <p>The printer is currently performing a self test and initialization. Please wait.</p>                                                                                                                                                                                                                                                                                                                                                                                                                                                                                                                                                                                                                                                                                                                                                                                                                                                                                                                                                                                                                                                                                                                                                                                                                                           |
|  |  |  |  |  |  | <p><b>Reset All</b></p> <p>All printer's interface has been reset and the buffer has been cleared. The printer reboots automatically. Please wait.</p>                                                                                                                                                                                                                                                                                                                                                                                                                                                                                                                                                                                                                                                                                                                                                                                                                                                                                                                                                                                                                                                                                                                                                                                                    |
|  |  |  |  | —                                                                                   | —                                                                                   | <p><b>Cancelling All Job</b></p> <p>The printer is canceling all print jobs in the printer memory, including jobs the printer is currently receiving or printing. Please wait.</p>                                                                                                                                                                                                                                                                                                                                                                                                                                                                                                                                                                                                                                                                                                                                                                                                                                                                                                                                                                                                                                                                                                                                                                        |
|  |  |  |  | —                                                                                   | —                                                                                   | <p><b>Cancelling Job</b></p> <p>The printer is canceling the specified print job and the current print job. Please wait.</p>                                                                                                                                                                                                                                                                                                                                                                                                                                                                                                                                                                                                                                                                                                                                                                                                                                                                                                                                                                                                                                                                                                                                                                                                                              |
| —                                                                                   | —                                                                                   | —                                                                                   |  | —                                                                                   | —                                                                                   | <p><b>Please wait</b></p> <p>Please wait. Do not turn off the power to the printer or open and close the cover.</p>                                                                                                                                                                                                                                                                                                                                                                                                                                                                                                                                                                                                                                                                                                                                                                                                                                                                                                                                                                                                                                                                                                                                                                                                                                       |

**Troubleshooting**

|   |   |   |   |   |                                                                                                                                                                                                                                                                                                                                                                                                                                                                                                                                                                                                                 | <b>Statuses and handling methods (status monitor messages in bold)</b>                                                                                                      |
|---|---|---|---|---|-----------------------------------------------------------------------------------------------------------------------------------------------------------------------------------------------------------------------------------------------------------------------------------------------------------------------------------------------------------------------------------------------------------------------------------------------------------------------------------------------------------------------------------------------------------------------------------------------------------------|-----------------------------------------------------------------------------------------------------------------------------------------------------------------------------|
|   |   |   |   |   |                                                                                                                                                                                                                                                                                                                                                                                                                                                                                                                                                                                                                 | <p><b>F/W Update</b><br/>Firmware is being updated. Do not turn off the power until the update is complete.</p> <p><b>Filling Toner</b><br/>Wait for the toner to fill.</p> |
| — | — | — | — |   | <p><b>Form Feed</b><br/>The printer is ejecting paper due to a user request.</p> <p><b>Printing Configuration Status Sheet</b><br/><b>Printing Supplies Status Sheet</b><br/><b>Printing Usage History Status Sheet</b><br/><b>ESC/Page Font Sample</b><br/><b>PCL Font Sample</b><br/><b>ESC/P2 Font Sample</b><br/><b>FX Font Sample</b><br/><b>I239 Font Sample</b><br/><b>PS3 Font List</b><br/>The corresponding sheet is printed.</p> <p><b>Screen25</b><br/><b>Screen50</b><br/><b>Screen100</b><br/>A pattern is printed to check for uneven printing at the specified density (25%, 50%, or 100%).</p> |                                                                                                                                                                             |
| — | — | — |   | — | <p><b>Warming Up</b><br/>The printer is warming up the fuser to be ready to print.</p> <p><b>Adjusting Printer</b><br/>Wait a few minutes. Do not open or close the covers, or turn off the printer until this message disappears.</p> <p><b>Canceling Job</b><br/>The printer is canceling the specified print job and the current print job. Please wait.</p>                                                                                                                                                                                                                                                 |                                                                                                                                                                             |
|   |   |   |   |   | <p><b>Sleep</b><br/>The printer is currently in the power-save mode. This mode is canceled when the printer receives print data or any key on the control panel is pressed.</p>                                                                                                                                                                                                                                                                                                                                                                                                                                 |                                                                                                                                                                             |
| — | — | — |   | — | <p><b>Cooling Down</b><br/>The printer is cooling down. This is not an error message, and will clear itself.</p>                                                                                                                                                                                                                                                                                                                                                                                                                                                                                                |                                                                                                                                                                             |
| — | — | — |   |   | <p><b>Ready</b><br/>The printer is ready to receive data and print.</p>                                                                                                                                                                                                                                                                                                                                                                                                                                                                                                                                         |                                                                                                                                                                             |



### Troubleshooting

|                                                                                                                                                                                        |   |   |   |  | Data | <b>Statuses and handling methods (status monitor messages in bold)</b>                                                                                                                                                                                                                                                                                            |
|----------------------------------------------------------------------------------------------------------------------------------------------------------------------------------------|---|---|---|--|------|-------------------------------------------------------------------------------------------------------------------------------------------------------------------------------------------------------------------------------------------------------------------------------------------------------------------------------------------------------------------|
|                                                                                                                                                                                        | — | — | — |  | —    | <b>Reboot to apply settings</b><br>A setting item that is not enabled unless the printer is restarted has been changed. Turn the printer on and off, or do a reset all.                                                                                                                                                                                           |
|                                                                                                                                                                                        |   |   |   |  |      | <b>Can't Print</b><br>The print data is deleted because it is incorrect. Make sure the appropriate paper size and printer driver are used.                                                                                                                                                                                                                        |
|                                                                                                                                                                                        |   |   |   |  |      | <b>Collate Disabled</b><br>The print data is deleted because it is incorrect. Make sure the appropriate paper size and printer driver are used.                                                                                                                                                                                                                   |
|                                                                                                                                                                                        |   |   |   |  |      | Printing by specifying the number of copies is no longer possible due to a lack of memory (RAM). If this warning appears, print only one copy at a time.                                                                                                                                                                                                          |
|                                                                                                                                                                                        |   |   |   |  |      | <b>Image Optimum</b><br>There is insufficient memory to print the page at the specified print quality. The printer automatically lowers the print quality so that it can continue printing. If the quality of the printout is not acceptable, try simplifying the page by limiting the number of graphics or reducing the number and size of fonts.               |
| <b>Need Memory</b><br>The printer has insufficient memory to complete the current print job. To prevent this problem from recurring, reduce the resolution of the image to be printed. |   |   |   |  |      |                                                                                                                                                                                                                                                                                                                                                                   |
|                                                                                                                                                                                        |   |   |   |  |      | <b>Service Req</b><br>A controller error or a print engine error has been detected. Turn off the printer. Wait at least a few seconds, then turn it back on. If the error still appears, write down the error number listed on the status monitor (Cffff/Exxx), turn off the printer, unplug the power plug, and then contact a qualified service representative. |
|                                                                                                                                                                                        |   |   |   |  |      |                                                                                                                                                                                                                                                                                                                                                                   |
|                                                                                                                                                                                        |   |   |   |  | —    | <b>F/W Update: Error</b><br>The firmware update failed. Turn the power off and on, and then try to update again.                                                                                                                                                                                                                                                  |
|                                                                                                                                                                                        |   |   |   |  |      | <b>Recovery Mode</b><br>Because the firmware update failed, the printer started in recovery mode. Use the steps below to try to update the firmware again.                                                                                                                                                                                                        |

## Troubleshooting

### Printing a Status Sheet

To confirm the current status and settings of the printer are suitable for your purpose, print the appropriate status sheet. The following table describes the major status sheets that can be printed from the control panel of your printer.

**Note:**

There are other printable sheets besides the sheets listed in the table below. See **System Report** menu in “[System Information](#)” on page 19 for more information.

|                                   |                                                                                                               |
|-----------------------------------|---------------------------------------------------------------------------------------------------------------|
| Print Configuration Status Sheet* | Prints the configuration of the hardware and the settings of the control panel menus.                         |
| Print Supplies Status Sheet*      | Prints the remaining service life of replacement parts and the remaining level of consumables in the printer. |
| Print Usage History Sheet*        | Prints various statistics about the numbers of printouts, such as Paper Size or Paper Path.                   |
| Network Status Sheet              | Prints the status of the network interface configuration.                                                     |

\* The printer driver can also print status sheets. Access the printer driver's **Maintenance** tab, and click the **Print Status Sheets** icon.

### Printing from the control panel (For AL-M320DN/310DN)

Follow the steps below to print and confirm the **Configuration Status Sheet** from the control panel, as an example.

- 1 Turn on the printer. The LCD panel shows **Ready**.
- 2 Press the **▶ Right** button to access the control panel menus.

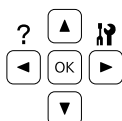

- 3 Use the **▼ Down** button to select **System Information**, then press the **▶ Right** button.

- 4 Use the **▼ Down** button to select **System Report**, then press the **▶ Right** button.
- 5 Use the **▼ Down** button to select **Print Configuration Status Sheet**, then press the **▶ Right** button.
- 6 Confirm that the information about the installed options is correct. If the options are installed correctly, they appear under **Hardware Configuration**. If the options are not listed, try reinstalling them.

### Printing from the control panel (For AL-M220DN)

See “[Control Panel for AL-M220DN](#)” on page 15.

**Note:**

- If the configuration status sheet does not list your installed options correctly, make sure that they are securely connected to the printer.
- If you are unable to get the printer to print a correct configuration status sheet, contact your dealer.
- Print the configuration status sheet on A4 size paper.

### Clearing Jammed Paper

If paper becomes jammed in the printer, the printer's LCD panel (AL-M320DN/AL-M310DN), LED lights (AL-M220DN), and EPSON Status Monitor provide alert messages. Paper jams may occur in more than one location simultaneously. For example, for AL-M320DN/AL-M310DN and when the LCD panel displays a message, such as **Clear Paper Jam C1 DM**, clear the jams in the order they are displayed.

Be sure to observe the following points when you clear jammed paper.

- Do not remove jammed paper by force. Torn paper can be difficult to remove and might cause other paper jams. Pull the paper gently and steadily with both hands to avoid tearing it, falling down, and injuring yourself.

## Troubleshooting

- ❑ If jammed paper is torn and remains in the printer, or if paper is jammed in a place not mentioned in this section, contact your dealer.
- ❑ Make sure that the paper type that is loaded is the same as the Paper Type setting in the printer driver.
- ❑ If paper jams occur repeatedly, check that the printer's setup is correct, and that the settings on the printer are correct. See [“Paper Does Not Feed Properly”](#) on page 88 for more information.

**⚠ Caution:**

- ❑ When you open the printer's covers F1, F2, or E while doing these operations, do not touch the areas indicated by the warning labels. High temperatures may cause burns.

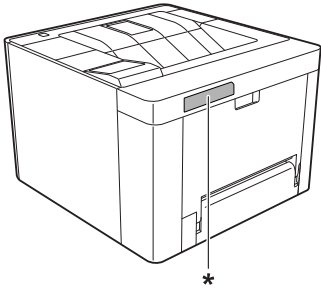

\* caution label

**⚠ Caution:**

- ❑ Be careful of the covers opening and closing quickly. There is a risk of pinching your fingers and being injured.

Inside

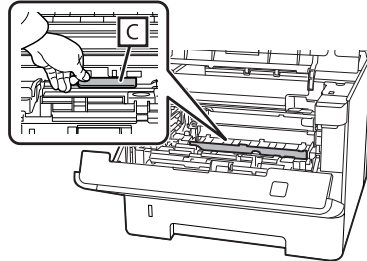

Inside the front

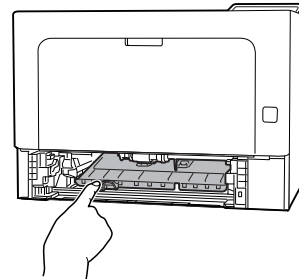

Back

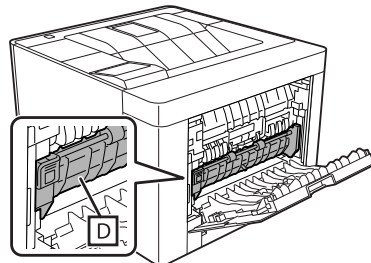

## F (Cover F)

- 1 Remove all paper from the MP tray and close it.

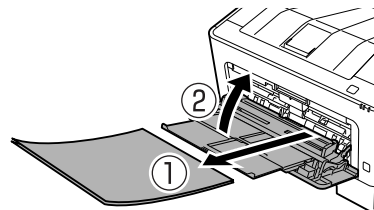

## Troubleshooting

- 2** Press the button on the top, then open covers F1 and F2.

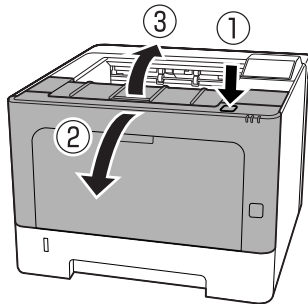

- 3** Press lever A on left side.

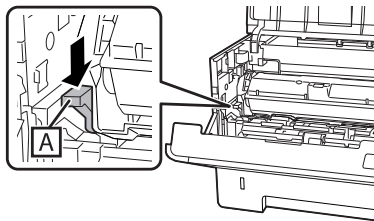

- 4** Remove the maintenance unit A.

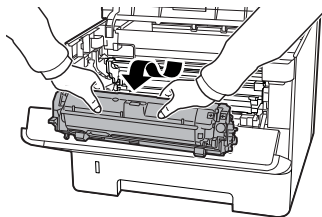

- 5** Remove the maintenance unit B while holding section B.

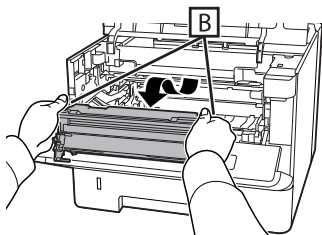

**!** **Important:**

- ❑ Do not expose maintenance unit B to light for a long period of time.
- ❑ To avoid damaging it, do not touch the photoconductor (drum) in maintenance unit B.

- 6** While holding up inside cover C, remove any sheets of paper.

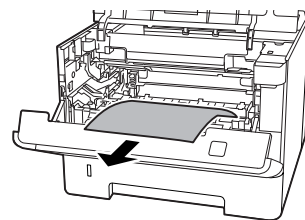
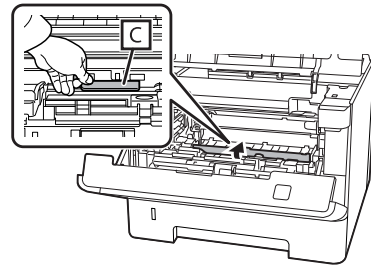

- 7** Insert the maintenance unit B.

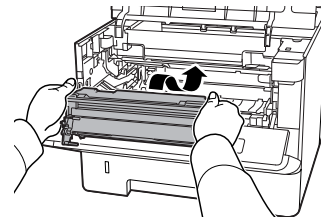

- 8** Insert the maintenance unit A.

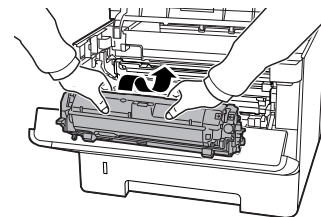

- 9** Close covers F1 and F2.

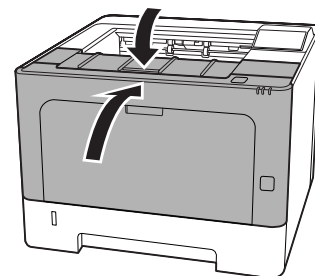

**Troubleshooting**

**E (Cover E)**

- 1** Open cover E at the back.

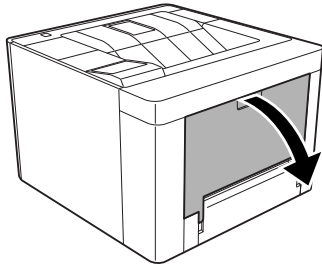

- 2** Remove any sheet of paper.

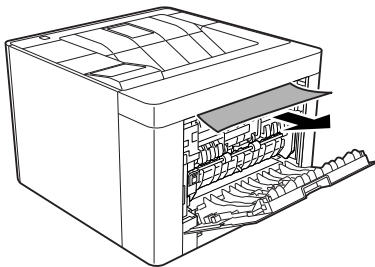

If you cannot pull the paper out from the upper part, go to step 3.

- 3** While opening section D, remove any sheets of paper.

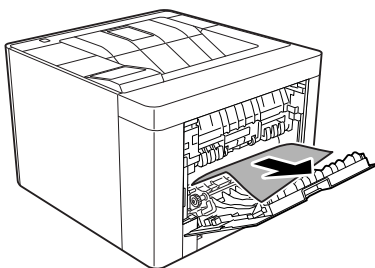
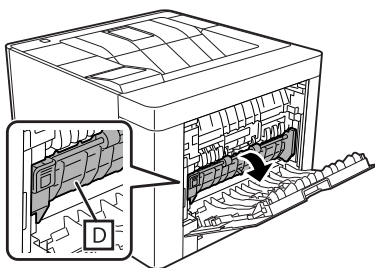

- 4** Close cover E at the back.

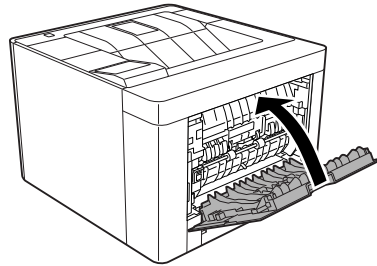

- 5** Press the button on the top, open and close cover F1, then close cover F2.

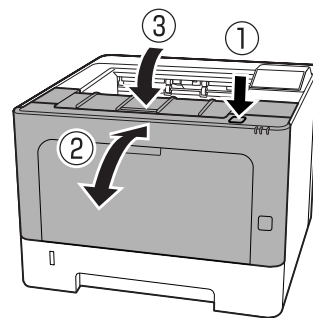

**Troubleshooting**

**C1 DM (Cassette1/DM knob)**

**1** Remove the paper cassette.

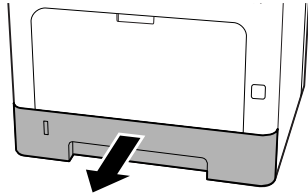

**2** Lower the inside cover with your finger on the blue knob.

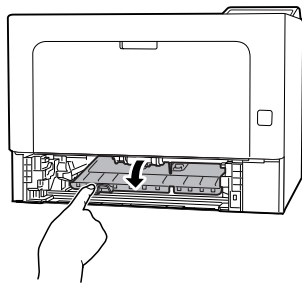

**3** Remove any sheets of paper.

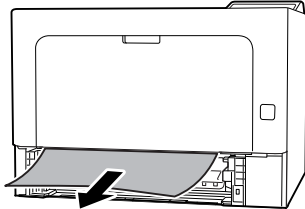

**4** Place your finger on the blue knob and firmly raise the inside cover.

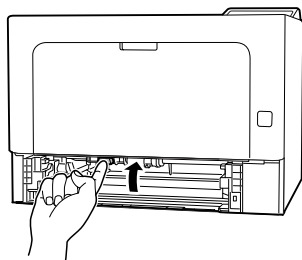

**5** Insert the paper cassette.

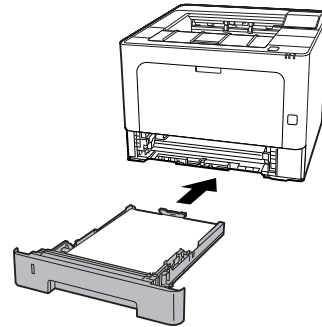

**6** Press the button on the top, open and close cover F1, then close cover F2.

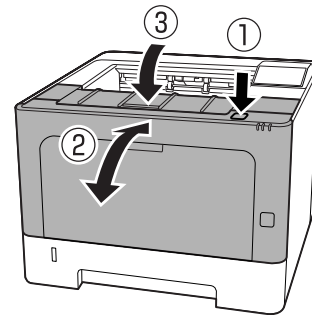

**MP (MP tray)**

**1** Remove any sheets of paper.

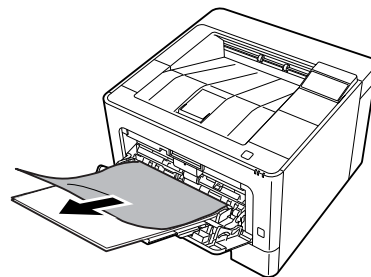

**2** Remove all paper from MP tray and reload.

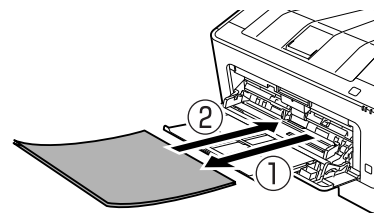

## Troubleshooting

- 3 Confirm that the paper size and the orientation match the settings in the control panel (for AL-M320DN/AL-M310DN), in **EpsonNet Config** on your web browser, or in Printer Settings in the printer driver (for AL-M220DN).

### C1 - C3 (Cassette 1 - 3)

For AL-M320DN/AL-M310DN, these instructions use the standard paper cassette (C1) as an example. Use the same procedure for optional paper cassettes C2 and C3.

- 1 Remove the paper cassette.

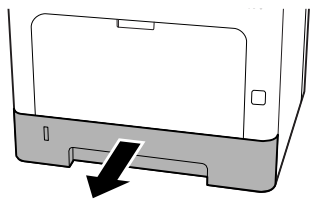

- 2 Remove any sheets of paper.

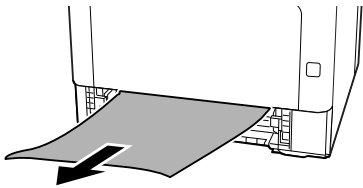

- 3 Insert the paper cassette.

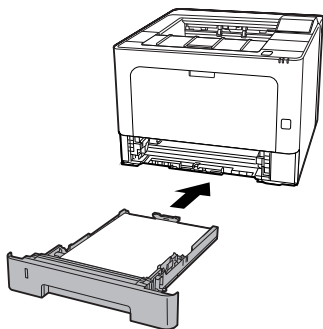

- 4 Press the button on the top, open and close cover F1, then close cover F2.

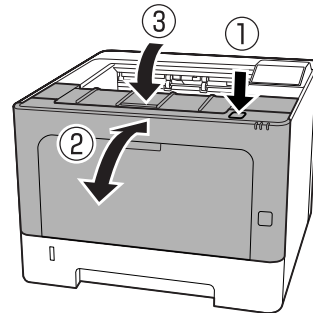

- 5 Confirm that the paper size and the orientation match the settings in the control panel (for AL-M320DN/AL-M310DN), in **EpsonNet Config** on your web browser, or in Printer Settings in the printer driver (for AL-M220DN).

## Troubleshooting

### Paper Does Not Feed Properly

| Cause                                                                                                                                                   | What to do                                                                                                                                                                                                                                                                                                                                                                                                                                                  |
|---------------------------------------------------------------------------------------------------------------------------------------------------------|-------------------------------------------------------------------------------------------------------------------------------------------------------------------------------------------------------------------------------------------------------------------------------------------------------------------------------------------------------------------------------------------------------------------------------------------------------------|
| The paper guides are not set correctly.                                                                                                                 | Make sure that the paper guides in all the paper cassettes and the MP tray are set to the correct paper size positions.<br>Do not move the paper guide after the paper is loaded.                                                                                                                                                                                                                                                                           |
| The paper source setting may not be correct.                                                                                                            | Make sure that you have selected the correct paper source in your application.                                                                                                                                                                                                                                                                                                                                                                              |
| There may be no paper in the paper source.                                                                                                              | Load paper into the selected paper source.                                                                                                                                                                                                                                                                                                                                                                                                                  |
| The size of loaded paper differs from the control panel or printer driver settings.                                                                     | Make sure that the correct paper size and paper source are set in the control panel or printer driver.                                                                                                                                                                                                                                                                                                                                                      |
| The printer may have loaded more than one sheet at a time.                                                                                              | Remove the paper stack and fan it. Tap it on a flat surface to even the edges, then reload the paper.                                                                                                                                                                                                                                                                                                                                                       |
| Too many sheets may be loaded in the MP tray or paper cassettes.                                                                                        | Make sure that you have not tried to load too many sheets of paper. For the maximum paper capacity for each paper source, see <a href="#">"Available Paper and Capacities"</a> on page 39.                                                                                                                                                                                                                                                                  |
| If paper does not feed from the optional paper cassette unit, the unit may not be installed properly.                                                   | For instructions on installing the unit, see <a href="#">"Optional paper cassette unit"</a> on page 99.                                                                                                                                                                                                                                                                                                                                                     |
| If paper does not feed from the optional paper cassette unit, it may be because the printer driver does not recognize the optional paper cassette unit. | Access the <b>Optional Settings</b> tab in the printer driver and do one of the following: <ul style="list-style-type: none"> <li><input type="checkbox"/> Select the <b>Acquire from Printer</b> check box and click <b>Get</b> to automatically update the installed option information.</li> <li><input type="checkbox"/> Select the <b>Manual Settings</b> check box and click <b>Settings</b> to do the settings for each installed option.</li> </ul> |

### Power and Control Panel Problems

#### The ready light does not turn on

| Cause                                                                  | What to do                                                                                                                           |
|------------------------------------------------------------------------|--------------------------------------------------------------------------------------------------------------------------------------|
| The power cord may not be properly plugged into the electrical outlet. | Turn off the printer, check the power cord connections between the printer and the electrical outlet, then turn the printer back on. |



## Troubleshooting

| Cause                                                                                                                                     | What to do                                                                                                                                                                                                                                                                                                                                                                                                                                                                                                                                                                                                                                                                                                         |
|-------------------------------------------------------------------------------------------------------------------------------------------|--------------------------------------------------------------------------------------------------------------------------------------------------------------------------------------------------------------------------------------------------------------------------------------------------------------------------------------------------------------------------------------------------------------------------------------------------------------------------------------------------------------------------------------------------------------------------------------------------------------------------------------------------------------------------------------------------------------------|
| The printer is in the deep sleep mode.                                                                                                    | <p>Check if your printer is in deep sleep mode. See <a href="#">“Using Deep Sleep Mode to Save Energy” on page 58</a>.</p> <p>The printer recovers from the deep sleep mode in the following cases:</p> <ul style="list-style-type: none"> <li>- When the printer receives a print job</li> <li>- For AL-M320DN/AL-M310DN, when the <b>Wakeup/Sleep</b> button is pressed</li> <li>- For AL-M220DN, when any button on the control panel is pressed</li> </ul> <p><b>Note:</b><br/> <i>With AL-M320DN and AL-M310DN, the sleep status can also be shown by a flashing Ready light. This makes the status easier to notice.</i></p> <p>See 17 ShowSleepByRdyLamp in <a href="#">“Support Menu” on page 103</a>.</p> |
| The printer is in the power off mode (the <b>Wakeup/Sleep</b> button blinks for AL-M320DN/AL-M310DN or all lights are off for AL-M220DN). | <p>Turn on the printer by pressing the power switch. For AL-M320DN/AL-M310DN, pressing the <b>Wakeup/Sleep</b> button also makes the printer available for printing.</p> <p>To not enter the power off mode, access Energy Saver Menu, and set both Power Off if Inactive and Power Off If Disconnected to Off.</p>                                                                                                                                                                                                                                                                                                                                                                                                |

---

## The printer turns off automatically

| Cause                                                                                                                                     | What to do                                                                                                                          |
|-------------------------------------------------------------------------------------------------------------------------------------------|-------------------------------------------------------------------------------------------------------------------------------------|
| The printer is in the power off mode (the <b>Wakeup/Sleep</b> button lights for AL-M320DN/AL-M310DN or all lights are off for AL-M220DN). | To not enter the power off mode, access Energy Saver Menu, and set both Power Off if Inactive and Power Off If Disconnected to Off. |

---

## The Printer does not turn off

| Cause                                                                                                                                     | What to do                                                                                                                                                                                                                                                                                                                       |
|-------------------------------------------------------------------------------------------------------------------------------------------|----------------------------------------------------------------------------------------------------------------------------------------------------------------------------------------------------------------------------------------------------------------------------------------------------------------------------------|
| The printer is in the power off mode (the <b>Wakeup/Sleep</b> button lights for AL-M320DN/AL-M310DN or all lights are off for AL-M220DN). | Wait for a while. The printer turns off in approximately ten seconds.                                                                                                                                                                                                                                                            |
| The power switch is pressed while the printer is in deep sleep mode.                                                                      | <p>Wait for a while. The printer turns off in approximately ten seconds.</p> <p><b>Note:</b><br/> <i>With AL-M320DN and AL-M310DN, the sleep status can also be shown by a flashing Ready light. This makes the status easier to notice.</i></p> <p>See 17 ShowSleepByRdyLamp in <a href="#">“Support Menu” on page 103</a>.</p> |

## Troubleshooting

# The Printer Does Not Print

## Ready light is off

| Cause                                                                  | What to do                                                                                                                                                                                                                                                                                                                                                         |
|------------------------------------------------------------------------|--------------------------------------------------------------------------------------------------------------------------------------------------------------------------------------------------------------------------------------------------------------------------------------------------------------------------------------------------------------------|
| The printer is offline.                                                | Press the <b>Pause/Release</b> button (for AL-M320DN/AL-M220DN), or press the <b>OK</b> button (for AL-M220DN), once to switch the printer to a ready status. Make sure that the Ready light turns on.                                                                                                                                                             |
| Some error may have occurred.                                          | For AL-M320DN/AL-M310DN, if an error message appears, see <a href="#">“Status and Error Messages on the Control Panel (for AL-M320DN/AL-M310DN)”</a> on page 70.<br>For AL-M310DN, if an error light is on or flashing, see <a href="#">“Status and Error Lights (for AL-M220DN)”</a> on page 76.                                                                  |
| The power cord may not be properly plugged into the electrical outlet. | Turn off the printer, check the power cord connections between the printer and the electrical outlet, then turn the printer back on.                                                                                                                                                                                                                               |
| The printer is in the power off mode (All lights go out).              | Turn on the printer by pressing the power switch. For AL-M320DN/AL-M310DN, pressing the <b>WakeUp/Sleep</b> button also makes the printer available for printing.<br><br>To not enter the power off mode, access <code>Energy Saver Menu</code> , and set both <code>Power Off if Inactive</code> and <code>Power Off If Disconnected</code> to <code>Off</code> . |

## The ready light is on

| Cause                                                                                     | What to do                                                                                                                                                                                                                                                                                                                                                                                    |
|-------------------------------------------------------------------------------------------|-----------------------------------------------------------------------------------------------------------------------------------------------------------------------------------------------------------------------------------------------------------------------------------------------------------------------------------------------------------------------------------------------|
| The printer is paused or offline (Windows)                                                | If you stop printing or the printer stops printing because of some error, the printer or status of the print manager changes to Pause Printing. You cannot print in this status.<br><br>1. Click Start - Devices and Printers.<br><br>2. Select the icon for the printer and open the Printer menu from the Print Jobs display. Clear the checks from Pause Printing and Use Printer Offline. |
| The interface cable may not be plugged in securely.                                       | Check both ends of the interface cable between the printer and the computer.                                                                                                                                                                                                                                                                                                                  |
| You may not be using the correct interface cable.                                         | Use a cable that matches the specifications of the printer. Confirm that there are not breaks in the cable.<br><br>If you are using the USB interface, use a cable that is compatible with Hi-Speed USB.                                                                                                                                                                                      |
| Your application software is not properly set up for your printer.                        | Make sure that the printer is selected in your application software.                                                                                                                                                                                                                                                                                                                          |
| Your computer system's memory is too small to handle the volume of data in your document. | Try reducing the image resolution of your document in the application software, or install more memory in your computer if you can.                                                                                                                                                                                                                                                           |

## Troubleshooting

# Printout Problems

## Print quality is poor

Refer to the table below if your printouts are light, faint, uneven, dark, or dirty or if some areas are not printed.

| Cause                                                                                                                                                                              | What to do                                                                                                                                                                                                                                                                        |
|------------------------------------------------------------------------------------------------------------------------------------------------------------------------------------|-----------------------------------------------------------------------------------------------------------------------------------------------------------------------------------------------------------------------------------------------------------------------------------|
| You may not be using the correct type of paper for your printer.                                                                                                                   | Smooth, high-quality copier paper is recommended for best results. See <a href="#">"Available Paper and Capacities" on page 39</a> for information on choosing paper.                                                                                                             |
| Your paper may be moist or damp.                                                                                                                                                   | Do not store your paper in a humid or damp environment.                                                                                                                                                                                                                           |
| The paper type setting may not be appropriate for the loaded paper.                                                                                                                | Set the appropriate paper type in the printer driver.                                                                                                                                                                                                                             |
| The Toner Save mode may be on.                                                                                                                                                     | Turn off the toner save mode using the printer driver, the printer's control panel or EpsonNet Config on your web browser. For Windows users, on the More Options tab in the printer driver, click Image Options and select the Toner Save check box.                             |
| The paper path inside the printer may be dusty.                                                                                                                                    | Clean internal printer components by printing three pages with only one character per page.<br>If the printouts get dirty, clean the paper feed roller. See <a href="#">"Cleaning the inner roller" on page 68</a> .                                                              |
| The voltage for the main charger is not correct.<br>(AL-M320DN/AL-M310DN)                                                                                                          | Changing the voltage for the main charger also changes the print density. You can change the voltage from Main Charger in the Printer Adjust Menu.                                                                                                                                |
| The Highland setting may not be set correctly for printing in a location at a high altitude.                                                                                       | Select the appropriate value in Highland of the Printer Adjust Menu. See <a href="#">"Printer Adjust Menu" on page 104</a> .                                                                                                                                                      |
| There may be a problem with the toner cartridge, or the toner cartridge has come to near the end of its service life.                                                              | Print several pages to check if the quality of the printouts has improved. If it has not improved, replace the toner cartridge with new one.<br>For information about replacing parts, see the instructions that come with each replacement parts.                                |
| Condensation may occur.                                                                                                                                                            | Wait at least one hour before using the printer after moving it from a cool to a warm environment. Try refreshing the drum. See <a href="#">"Printer Adjust Menu" on page 104</a> .                                                                                               |
| The printer cannot print in the required quality level because of insufficient memory, and the printer lowers the quality automatically so that the printer can continue printing. | Check to see if the printout is acceptable. If not, lower print quality temporarily in the printer driver.<br>For AL-M320DN/AL-M310DN, if RAM Disk is set to Maximum or Normal on the control panel, you can increase the available memory space by changing this setting to Off. |

## Cannot Read Barcode

| Cause                                                               | What to do                                                                                      |
|---------------------------------------------------------------------|-------------------------------------------------------------------------------------------------|
| The Quality setting in the printer driver is set to Fast (300 dpi). | Click Fine (600 dpi) or More Settings, increase the priority level for quality, and then print. |

## Troubleshooting

| Cause                                                                                   | What to do                                                                          |
|-----------------------------------------------------------------------------------------|-------------------------------------------------------------------------------------|
| The Emphasize Text setting in the printer driver is set to Emphasize or Emphasize More. | Set Emphasize Text to Off in Image Options on the More Options tab, and then print. |

**Note:**

Turn the Barcode mode to Mode 1 or Mode 2 in Extended Settings on the Maintenance tab, and then try printing. This setting prints sharply defined barcodes. For the fastest barcode printing, use Mode 1. For the best barcode quality, use Mode 2.

Set the mode to Off when you have finished printing barcodes.

## The printout is not what you expected

### Some part of the graphics or text looks different from what you see on the computer screen

| Cause                                                               | What to do                                                                                                                                                                                          |
|---------------------------------------------------------------------|-----------------------------------------------------------------------------------------------------------------------------------------------------------------------------------------------------|
| The printer emulation setting in your application may be incorrect. | Make sure that your application is set for the printer emulation you are using. For example, if you are using the ESC/Page mode, make sure that your application is set to use an ESC/Page printer. |

### The printout position is not correct

| Cause                                                                   | What to do                                                                                                                                                                      |
|-------------------------------------------------------------------------|---------------------------------------------------------------------------------------------------------------------------------------------------------------------------------|
| The page length and margins may be set incorrectly in your application. | Make sure that you are using the correct page length and margin settings in your application.                                                                                   |
| The paper size setting may be incorrect.                                | Make sure the correct paper size is set in the Tray Menu using the printer's control panel, EpsonNet Config on your web browser, or the Printer Settings in the printer driver. |
| The offset values may be changed in the Printer Adjust Menu.            | Confirm and adjust the offset values such as Feed Offset or Scan Offset. See "Printer Adjust Menu" on page 104 for details.                                                     |
| The paper guide was touched after the paper was loaded.                 | Touching the paper guide after the paper is loaded may cause the guide to become misaligned. Refer to "Loading Paper" on page 43 for how to load the paper.                     |

### Cannot print all copies

| Cause                                                              | What to do                                                                                                                                                                                                                                                      |
|--------------------------------------------------------------------|-----------------------------------------------------------------------------------------------------------------------------------------------------------------------------------------------------------------------------------------------------------------|
| The printer does not have sufficient memory to collate print jobs. | Reduce the contents of print jobs, or increase the available memory on your printer.<br><br>For AL-M320DN/AL-M310DN, if RAM Disk is set to Maximum or Normal on the control panel, you can increase the available memory space by changing this setting to Off. |

## Troubleshooting

### The last page of a two-sided printout is printed on the wrong side of the paper

| Cause                                            | What to do                                                                                                                                                                                                                           |
|--------------------------------------------------|--------------------------------------------------------------------------------------------------------------------------------------------------------------------------------------------------------------------------------------|
| Convert to Simplex is set to Odd Page or 1 Page. | For jobs with three or more pages, set Convert to Simplex to Off or 1 Page to do duplex printing.<br>For jobs with just one page, set Convert to Simplex to Off to do duplex printing. See <a href="#">"Setup Menu" on page 21</a> . |

### Printout is garbled

| Cause                                                  | What to do                                                                                                                                                                                                                                                     |
|--------------------------------------------------------|----------------------------------------------------------------------------------------------------------------------------------------------------------------------------------------------------------------------------------------------------------------|
| The interface cable may not be plugged in securely.    | Make sure that both ends of the interface cable are plugged in securely.                                                                                                                                                                                       |
| You may not be using the correct interface cable.      | Use a cable that matches the specifications of the printer. Confirm that there are not breaks in the cable.<br><br>If you are using the USB interface, use a cable that is compatible with Hi-Speed USB.                                                       |
| The emulation setting for the port may not be correct. | Specify the emulation mode by make sure the correct paper size is set in the Tray Menu using the printer's control panel EpsonNet Config on your web browser, or the Printer Settings in the printer driver. See <a href="#">"Emulation Menu" on page 30</a> . |

**Note:**

*If a configuration status sheet does not print correctly, your printer may be damaged. Contact your dealer or a qualified service representative.*

### The font cannot be printed

| Cause                                                                                      | What to do                                                                                                                                                                   |
|--------------------------------------------------------------------------------------------|------------------------------------------------------------------------------------------------------------------------------------------------------------------------------|
| For Windows users, you may use the printer fonts substituted for specified TrueType fonts. | In the printer driver, choose the <b>Print TrueType fonts as bitmap</b> check box in the Extended Settings dialog box.                                                       |
| The selected font is not supported by your printer.                                        | Make sure that you have installed the correct font. See the <i>Font Guide</i> for more information.                                                                          |
| The Mode is in Low Speed Mode. The Barcode Mode is in Mode 2.                              | This mode is for printing at low speed.<br>Do the following in Extended Settings on the Maintenance tab.<br>- Clear the check from Low Speed Mode<br>- Turn Barcode Mode Off |

## Printing in the PS3 Mode Problems

The problems listed in this section are those that you may encounter when printing with the PostScript driver. All procedural instructions refer to the PostScript printer driver.

## Troubleshooting

### The printer does not print correctly in the PostScript mode

| Cause                                                                                   | What to do                                                                                                                                                                                                                                                                                                                                                                                                                                                                                                |
|-----------------------------------------------------------------------------------------|-----------------------------------------------------------------------------------------------------------------------------------------------------------------------------------------------------------------------------------------------------------------------------------------------------------------------------------------------------------------------------------------------------------------------------------------------------------------------------------------------------------|
| The printer's emulation mode setting is incorrect.                                      | The printer is set to the <code>Auto</code> mode by default, so that it can automatically determine the encoding used in the received print job data and select the appropriate emulation mode. However, there are situations where the printer cannot select the correct emulation mode. In this case, it must be set manually to <code>PS3</code> .<br><br>Set the emulation mode through the <code>SelectType Emulation Menu</code> on the printer. See " <a href="#">Emulation Menu</a> " on page 30. |
| The printer's emulation mode setting for the interface that you are using is incorrect. | The emulation mode can be set individually for each interface which receives print job data. Set the emulation mode for the interface you are using to <code>PS3</code> .<br><br>Set the emulation mode through the <code>SelectType Emulation Menu</code> on the printer. See " <a href="#">Emulation Menu</a> " on page 30.                                                                                                                                                                             |

### The printer does not print

| Cause                                                                                                                                                                  | What to do                                                                            |
|------------------------------------------------------------------------------------------------------------------------------------------------------------------------|---------------------------------------------------------------------------------------|
| An incorrect printer driver is selected.                                                                                                                               | Make sure that the PostScript printer driver that you are using to print is selected. |
| The <code>Emulation Menu</code> in the printer's Control Panel is set to a mode other than <code>Auto</code> or <code>PS3</code> for the interface that you are using. | Change the mode setting to either <code>Auto</code> or <code>PS3</code> .             |

### The printer or its driver does not appear in utilities in the printer configuration (Mac OS only)

| Cause                              | What to do                                                                           |
|------------------------------------|--------------------------------------------------------------------------------------|
| The printer name has been changed. | Ask the network administrator for details, then select the appropriate printer name. |

### The font on the printout is different from that on the screen

| Cause                                                                                                                                                              | What to do                                                                                                                                                                         |
|--------------------------------------------------------------------------------------------------------------------------------------------------------------------|------------------------------------------------------------------------------------------------------------------------------------------------------------------------------------|
| The PostScript screen fonts are not installed.                                                                                                                     | The PostScript screen fonts must be installed on the computer that you are using. Otherwise, the font that you select is substituted by some other font for display on the screen. |
| <b>For Windows users only</b><br>The appropriate substitution fonts are not correctly specified on the Device Settings tab of the printer's Properties dialog box. | Specify the appropriate substitution fonts using the Font Substitution Table.                                                                                                      |

## Troubleshooting

### The edges of texts and/or images are not smooth

| Cause                                     | What to do                                        |
|-------------------------------------------|---------------------------------------------------|
| The Print Quality is set to <b>Fast</b> . | Change the Print Quality setting to <b>Fine</b> . |

### The printer does not print normally via the USB interface

| Cause                                                                                                                                      | What to do                                                                                                                                                                                                                                                                                                                                                                                                                                                                                                                 |
|--------------------------------------------------------------------------------------------------------------------------------------------|----------------------------------------------------------------------------------------------------------------------------------------------------------------------------------------------------------------------------------------------------------------------------------------------------------------------------------------------------------------------------------------------------------------------------------------------------------------------------------------------------------------------------|
| <p><b>For Windows users only</b></p> <p>The Data Format setting in the printer's Properties is not set to <b>ASCII</b> or <b>TBCP</b>.</p> | <p>The printer cannot print binary data when it is connected to the computer via the USB interface. Make sure that the Data Format setting, which is accessed by clicking <b>Advanced</b> on the PostScript sheet of the printer's Properties, is set to <b>ASCII</b> or <b>TBCP</b>.</p> <p>If your computer is running Windows Vista, Vista x64, XP, XP x64, click the <b>Device Settings</b> tab in the printer's Properties, then click the <b>Output Protocol</b> setting and select <b>ASCII</b> or <b>TBCP</b>.</p> |
| <p><b>For Mac OS users only</b></p> <p>The print setting in the application is set to binary encoding.</p>                                 | <p>The printer cannot print binary data when it is connected to the computer via the USB interface. Make sure that the print setting in the application is set to ASCII encoding.</p>                                                                                                                                                                                                                                                                                                                                      |

### The printer does not print normally via the network interface

| Cause                                                                                                                                       | What to do                                                                                                                                                                                                                                                                                                                                                                       |
|---------------------------------------------------------------------------------------------------------------------------------------------|----------------------------------------------------------------------------------------------------------------------------------------------------------------------------------------------------------------------------------------------------------------------------------------------------------------------------------------------------------------------------------|
| <p><b>For Windows users only</b></p> <p>The Data Format setting is different from the data format setting specified in the application.</p> | <p>If the file is created in an application that allows you to change the data format or encoding, such as Photoshop, make sure that the setting in the application matches that in the printer driver.</p>                                                                                                                                                                      |
| <p><b>For Windows users only</b></p> <p>The print data is too large.</p>                                                                    | <p>Click <b>Advanced</b> on the PostScript sheet of the printer's Properties, then change the Data Format setting from <b>ASCII</b> data (default) to <b>TBCP</b> (Tagged binary communications protocol).</p> <p>When the <b>Binary</b> setting is set to <b>On</b>, TBCP is not available. Use the Binary protocol. See "<a href="#">PS3 Menu</a>" on page 32 for details.</p> |
| <p><b>For Windows users only</b></p> <p>Printing cannot be performed using the network interface.</p>                                       | <p>Click <b>Advanced</b> on the PostScript sheet of the printer's Properties, then change the Data Format setting from <b>ASCII</b> data (default) to <b>TBCP</b> (Tagged binary communications protocol).</p> <p>When the <b>Binary</b> setting is set to <b>On</b>, TBCP is not available. Use the Binary protocol. See "<a href="#">PS3 Menu</a>" on page 32 for details.</p> |

### An undefined error occurs (Mac OS only)

| Cause                                                        | What to do                                                                                           |
|--------------------------------------------------------------|------------------------------------------------------------------------------------------------------|
| The version of the Mac OS that you are using is unsupported. | This printer's driver can only be used on Mac OS computers running Mac OS X version 10.6.8 or later. |

## Troubleshooting

# Other Problems

## The optional product is not available

| Cause                                                    | What to do                                                                                                                                                                                                                                                                                                                                                                                                                                                         |
|----------------------------------------------------------|--------------------------------------------------------------------------------------------------------------------------------------------------------------------------------------------------------------------------------------------------------------------------------------------------------------------------------------------------------------------------------------------------------------------------------------------------------------------|
| The printer does not recognize the optional product.     | Print a configuration status sheet to see if the printer recognizes the optional product. If not, reinstall the optional product.                                                                                                                                                                                                                                                                                                                                  |
| The setting for recognizing options may be set manually. | <p>Access the <b>Optional Settings</b> tab in the printer driver and do one of the following:</p> <ul style="list-style-type: none"> <li><input type="checkbox"/> Select the <b>Acquire from Printer</b> check box and click <b>Get</b> to automatically update the installed option information.</li> <li><input type="checkbox"/> Select the <b>Manual Settings</b> check box and click <b>Settings</b> to do the settings for each installed option.</li> </ul> |

## Correcting USB problems

| Cause                                                                                                                  | What to do                                                                                                                                                                                               |
|------------------------------------------------------------------------------------------------------------------------|----------------------------------------------------------------------------------------------------------------------------------------------------------------------------------------------------------|
| The printer is connected through one or more USB hubs.                                                                 | For best results, you should connect the printer directly to the computer's USB port. If you must use multiple USB hubs, we recommend that you connect the printer to the first tier of a certified hub. |
| Microsoft's universal driver is installed.<br>To check if the universal driver has been installed, see the note below. | Reinstall the printer software as described in the <i>Setup Guide</i> .                                                                                                                                  |

**Note:**

To check if the Universal driver has been installed, follow the steps below.

- 1 Open **Devices and Printers**. Then right-click the icon for your printer.
- 2 Click **Printing Preferences** on the menu that appears, then right-click anywhere in the driver.
- 3 If **About** is displayed, click it.
- 4 If a message box with the words "Unidrv Printer Driver" appears, the software has not been installed correctly. Note that if **About** is not displayed, the printer software has been installed correctly.

For Windows Vista, Windows XP, or Windows Server 2003, if the software installation dialog box appears during the installation process, click **Continue Anyway**. If you click **STOP Installation**, you will have to install the printer software again.



## Troubleshooting

### Cannot access the shared printer

| Cause                                                                                                                            | What to do                                           |
|----------------------------------------------------------------------------------------------------------------------------------|------------------------------------------------------|
| Inappropriate texts are used for the Share name of the shared printer.                                                           | Do not use spaces or hyphens for the Share name.     |
| An additional driver cannot be installed on the client computer, although the print server's OS and the client OS are different. | Install the printer drivers from the Software Disc.  |
| Your network system causes this problem.                                                                                         | Ask the administrator of the network for assistance. |

**Note:**

For the additional driver to be installed, please see the table below.

| Server OS                                                                                                                                                                                                     | Client OS                                                                                               | Additional Driver                      |
|---------------------------------------------------------------------------------------------------------------------------------------------------------------------------------------------------------------|---------------------------------------------------------------------------------------------------------|----------------------------------------|
| Windows XP*                                                                                                                                                                                                   | Windows XP clients                                                                                      | Intel Windows 2000 or XP               |
|                                                                                                                                                                                                               | Windows XP x64 clients                                                                                  | x64 Windows XP                         |
| Windows XP x64, Windows Server 2003, or Windows Server 2003 x64*                                                                                                                                              | Windows XP clients                                                                                      | Windows XP and Windows Server 2003     |
|                                                                                                                                                                                                               | Windows XP x64 clients                                                                                  | x64 Windows XP and Windows Server 2003 |
| Windows 10, Windows 8.1, Windows 8.1 x64, Windows 8, Windows 8 x64, Windows 7, Windows 7 x64, Windows Vista, Windows Vista x64, Windows Server 2016, Windows Server 2012/R2, Windows Server 2008, 2008 x64/R2 | Windows 10, Windows 8.1, Windows 8, Windows 7, Windows Vista, or Windows XP clients                     | x86 Type 3 - User Mode                 |
|                                                                                                                                                                                                               | Windows 10, Windows 8.1 x64, Windows 8 x64, Windows 7 x64, Windows Vista x64, or Windows XP x64 clients | x64 Type 3 - User Mode                 |

\* The additional driver for Windows XP x64 and Server 2003 x64 can be used on Windows XP Service Pack 3, Windows 2003 Service Pack 2, or later.

## Troubleshooting

# Transporting the Printer

## For short distances

Before you move the printer, prepare the location where you are going to place it. See the following sections.

- ❑ “Setting up the printer” on page 7
- ❑ “Finding the place for the printer” on page 8

**1** Make sure the printer is turned off and the operation panel is unlit, and then unplug the power plug from the outlet.

**2** Remove the following items from the printer.

- ❑ Power cord
- ❑ Interface cables
- ❑ Loaded paper
- ❑ Installed options (For AL-M320DN/AL-M310DN)

**3** Be sure to lift the printer by the correct positions as shown below.

Do not touch the projections on the bottom of the printer that are for connecting an optional paper cassette.

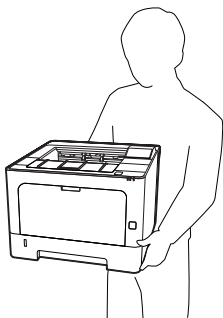

**!** **Important:**  
When moving the printer, always keep it horizontal.

## For long distances

Before you move the printer, prepare the location where you are going to place it. See the following sections.

- ❑ “Setting up the printer” on page 7
- ❑ “Finding the place for the printer” on page 8

## Repacking the printer

If you need to transport your printer for long distances, carefully repack it using the original box and packing materials.

**1** Make sure the printer is turned off and the operation panel is unlit, and then unplug the power plug from the outlet.

**2** Remove the following items from the printer.

- ❑ Power cord
- ❑ Interface cables
- ❑ Loaded paper
- ❑ Installed options (For AL-M320DN/AL-M310DN)

**3** Press the button on the top to open covers F1 and F2.

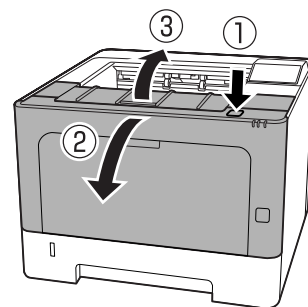

**!** **Important:**  
Do not touch the inner rollers and gears. Doing so may cause malfunctions or deterioration in print quality.

## Troubleshooting

- 4** Press down on lever A on the left side.

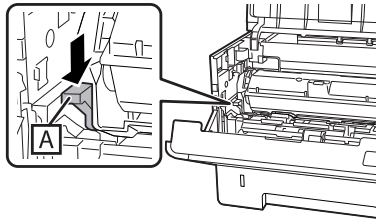

- 5** Remove maintenance unit A.

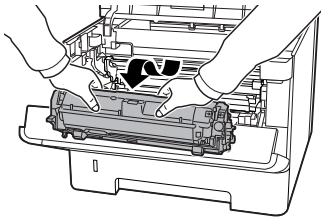

Put maintenance unit A in a plastic bag or wrap it in something like a thick cloth and put it in a packing carton.

**!** **Important:**

- Do not remove maintenance unit B.
- If you do not remove maintenance unit A before you move the printer, the toner may spill inside the printer.

- 6** Close covers F1 and F2.

- 7** Attach the protective materials onto the printer, then repack the printer in its original box.

**!** **Important:**

When moving the printer, always keep it horizontal.

## Installing Options (AL-M320DN/ AL-M310DN)

### Optional paper cassette unit

For details about the paper types and sizes that you can use with the optional paper cassette unit, see [“Available Paper and Capacities”](#) on page 39.

The available optional paper cassette units are as follows:

250-Sheet Paper Cassette Unit × 2

### Handling precautions

Always pay attention to the following handling precautions before installing the option:

Be sure to lift the printer from the positions shown below.

Do not touch the projections on the bottom of the printer that are for connecting an optional paper cassette.

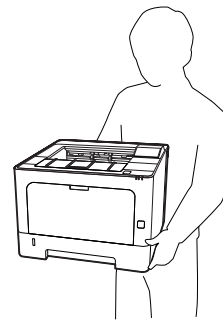

**!** **Caution:**

If you lift the printer incorrectly, you could drop it and cause injury.

## Troubleshooting

### Installing the optional paper cassette unit

- 1 Turn the printer off and unplug the power cord and interface cable.



**Important:**

*Be sure to unplug the power cord from the printer to prevent getting an electric shock.*

- 2 Carefully take the optional paper cassette unit out from its carton and place it where you intend to set up the printer.
- 3 Place another optional paper cassette unit or the printer onto the first optional paper cassette unit. Align each corner of the other optional paper cassette unit or printer with those of the first optional paper cassette unit. Then lower the other optional paper cassette unit or printer until it rests securely on the optional paper cassette unit.

#### Optional paper cassette unit

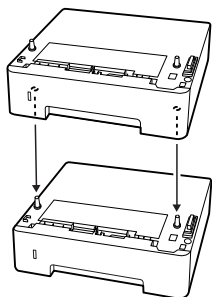

#### Printer

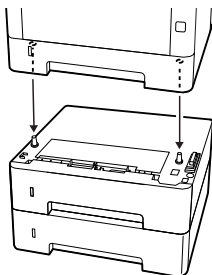

- 4 Reconnect the interface cable and power cord, and then turn the printer on.

To confirm that the option is installed correctly, print a configuration status sheet. See [“Printing a Status Sheet” on page 82](#).

### Removing the optional paper cassette unit

Perform the installation procedure in reverse.

## Appendix

# Appendix

## Technical Specifications

### General

| Item                                                     |           | AL-M320DN                                                                                                                                                                                                                                                                                | AL-M310DN | AL-M220DN |
|----------------------------------------------------------|-----------|------------------------------------------------------------------------------------------------------------------------------------------------------------------------------------------------------------------------------------------------------------------------------------------|-----------|-----------|
| Printing method                                          |           | Laser beam scanning and dry electrophotographic process                                                                                                                                                                                                                                  |           |           |
| Resolution                                               |           | 600 × 600 dpi, 1200 × 1200 dpi                                                                                                                                                                                                                                                           |           |           |
| Continuous printing speed on A4 size paper* <sup>1</sup> |           | 40 ppm                                                                                                                                                                                                                                                                                   | 35 ppm    | 30 ppm    |
| Paper feed                                               |           | Automatic or manual feed                                                                                                                                                                                                                                                                 |           |           |
| Paper feed alignment                                     |           | Center alignment for all sizes                                                                                                                                                                                                                                                           |           |           |
| Automatic 2-sided printing function                      |           | Standard                                                                                                                                                                                                                                                                                 |           |           |
| Printer language                                         |           | ESC/PageS Printing system, ESC/Page<br>ESC/P 2 24-pin printer emulation (ESC/P 2 mode)<br>ESC/P 9-pin printer emulation (FX mode)<br>IBM Proprinter emulation (I239X mode)<br>PostScript compatible with PostScript Level 3 (PS3 mode)<br>PCL6/PCL5 emulation (PCL mode)<br>PDF 1.7      |           |           |
| Memory                                                   | RAM       | 1024MB                                                                                                                                                                                                                                                                                   | 512MB     | 512MB     |
| Interfaces                                               | USB       | Hi-Speed USB                                                                                                                                                                                                                                                                             |           |           |
|                                                          | Ethernet: | 1000BASE-T/100BASE-TX/10BASE-Te                                                                                                                                                                                                                                                          |           |           |
| Supported protocols                                      |           | TCP/IP (IPv4, IPv6), LPR, Port9100, WSD, Bonjour, IPP/IPPS, HTTP/HTTPS, SNMP, SMTP, LLTD, IPSec, 802.1X                                                                                                                                                                                  |           |           |
| Resident fonts                                           |           | 84 scalable fonts, and 7 bitmap fonts for ESC/Page<br>95 scalable fonts, and 5 bitmap for PCL5<br>80 scalable fonts, and 1 bitmap for PCL6<br>80 scalable fonts for PostScript3 compatible with PostScript Level 3<br>10 typeface for ESC/P2<br>8 typeface for FX<br>8 typeface for I239 |           |           |

## Appendix

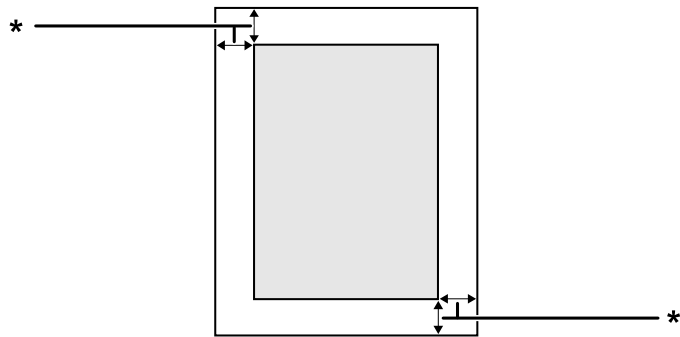
| Item                                |                                                           | AL-M320DN                                                                                        | AL-M310DN                                                  | AL-M220DN |
|-------------------------------------|-----------------------------------------------------------|--------------------------------------------------------------------------------------------------|------------------------------------------------------------|-----------|
| Printable area                      |                                                           | The assured printable area is an area 4 mm from all sides.                                       |                                                            |           |
|                                     |                                                           |  <p>* 4 mm</p> |                                                            |           |
|                                     |                                                           | <b>Note:</b><br>The printable area may be smaller depending on the application.                  |                                                            |           |
| Dimensions (Width × Depth × Height) | Printer <sup>*2*</sup> <sup>*3*</sup> <sup>*4</sup>       | 375 (W) × 393 (D) × 285 (H) mm<br>(14.8 × 15.5 × 11.2 in.)                                       | 375 (W) × 393 (D) × 265 (H) mm<br>(14.8 × 15.5 × 10.4 in.) |           |
|                                     | Optional paper cassette unit <sup>*2*</sup> <sup>*4</sup> | 375 (W) × 393 (D) × 100 (H) mm<br>(14.8 × 15.5 × 11.2 in.)                                       | -                                                          |           |
| Weight                              | Printer <sup>*5</sup>                                     | Approx. 14 kg (about 30.9 lb)                                                                    |                                                            |           |
|                                     | Optional paper cassette unit                              | Approx. 2.9 kg (about 6.4 lb)                                                                    |                                                            |           |
| Operating environment               | Temperature                                               | 10 to 32.5°C (50 to 89.6°F)                                                                      |                                                            |           |
|                                     | Humidity                                                  | 15 to 80 %RH                                                                                     |                                                            |           |
|                                     | Altitude (Air pressure) <sup>*6</sup>                     | 0 to 3,500 meters                                                                                |                                                            |           |
| Storage environment                 | Temperature                                               | 0 to 35°C (32 to 95°F),                                                                          |                                                            |           |
|                                     | Humidity                                                  | 15 to 85 %RH                                                                                     |                                                            |           |
|                                     | Altitude (Air pressure)                                   | 0 to 3,500 meters (0 to 15,000 in transport)                                                     |                                                            |           |

<sup>\*1</sup> Depending on the paper type or size, such as printing on paper smaller than A4, the print speed may become slower. The abbreviation "ppm" means "pages per minute".

<sup>\*2</sup> Figures in mm are rounded off to the nearest whole number.

<sup>\*3</sup> MP tray closed.

<sup>\*4</sup> Excluding protrusions.

<sup>\*5</sup> Excluding consumable products and options.

<sup>\*6</sup> For high altitude locations, the printer's Highland setting in the Printer Adjust Menu must be adjusted according to the altitude at which the printer is located. See "Printer Adjust Menu" on page 104 for details.

## Appendix

### Electrical

|                   |                    |         | AL-M320DN   |             | AL-M310DN   |             | AL-M220DN   |
|-------------------|--------------------|---------|-------------|-------------|-------------|-------------|-------------|
| Rated voltage     |                    |         | 110 V       | 220-240 V   | 110 V       | 220-240 V   | 110 V       |
| Rated frequency   |                    |         | 50 Hz/60 Hz | 50 Hz/60 Hz | 50 Hz/60 Hz | 50 Hz/60 Hz | 50 Hz/60 Hz |
| Rated current     |                    |         | 8.8 A       | 4.2 A       | 8.8 A       | 4.2 A       | 8.8 A       |
| Power consumption | During printing    | MAX     | 930 W       | 870 W       | 940 W       | 880 W       | 940 W       |
|                   |                    | Average | 624 W       | 609 W       | 569 W       | 594 W       | 517 W       |
|                   | In deep sleep mode |         | 0.87 W      | 0.87 W      | 0.86 W      | 0.87 W      | 0.92 W      |
|                   | In ready mode      |         | 7 W         | 7 W         | 7 W         | 7 W         | 7 W         |
|                   | In power off mode  |         | 0.05 W      | 0.05 W      | 0.05 W      | 0.05 W      | 0.05 W      |
|                   | Power off          |         | 0.05 W      | 0.05 W      | 0.05 W      | 0.05 W      | 0.05 W      |

**Note for users in Europe:**

See the following Website for details on power consumption.

<http://www.epson.eu/energy-consumption/>

**Note for users in Taiwan:**

Rated voltage of this printer in Taiwan is 110 V.

### Supported operating systems

Windows 10 (32-bit, 64-bit)/Windows 8.1 (32-bit, 64-bit)/Windows 8 (32-bit, 64-bit)/Windows 7 (32-bit, 64-bit)/Windows Vista (32-bit, 64-bit)/Windows XP SP3 or higher (32-bit), Windows XP Professional x64 Edition SP2 or higher/Windows Server 2016/Windows Server 2012 R2/Windows Server 2012/Windows Server 2008 R2/Windows Server 2008/Windows Server 2003 R2/Windows Server 2003 SP2 or higher

Mac OS X v10.6.8 - v10.11.x, macOS 10.12

### Support Mode Settings using the control panel



**Important:**

Remove interface cables before you enter the SUPPORT MODE.

### Support Menu

You can make special settings by using the control panel. Normally you do not need to change the settings.

## Appendix

### For AL-M320DN/AL-M310DN:

Pressing the **▼ Down** button while turning the printer on, opens the SUPPORT MODE. Press the **► Right** button, select **Common Settings** by pressing the **▲ Up** or **▼ Down** button, then select the **Support Menu**.

### For AL-M220DN:

While pressing Alt, Ctrl and Z at the same time, click the **Extended Settings** button. The Support Menu appears.

| Item                                                                                   | Explanation                                                                                                                                                                                                                                                                                                                                     |
|----------------------------------------------------------------------------------------|-------------------------------------------------------------------------------------------------------------------------------------------------------------------------------------------------------------------------------------------------------------------------------------------------------------------------------------------------|
| 1 Support StatusSheet                                                                  | Prints a sheet showing information about settings of Support Menu and Printer Adjust Menu.                                                                                                                                                                                                                                                      |
| 7 Extend Print Area*                                                                   | On enlarges the maximum print area according to the printed data.                                                                                                                                                                                                                                                                               |
| 9 Printer MIBv1 Mode                                                                   | On uses MIBv1 as a policy rule definition reporting the printer information to the SNMP manager.                                                                                                                                                                                                                                                |
| 10 USB ID                                                                              | Printers of the same model that are set to <b>Common</b> are recognized as the same device on the computer because they are using a common USB device ID. The plug and play screen is not displayed even if you switch the printer for a different printer that is the same model.<br><br>Settings (default in bold):<br><b>Unique</b> , Common |
| 11 MP Size Setting<br>12 C1 Size Setting<br>13 C2 Size Setting*<br>14 C3 Size Setting* | Prints on the paper size specified in the Tray Menu. Paper sizes that were specified for the print job from the printer driver are ignored.                                                                                                                                                                                                     |
| 17 ShowSleepByRdyLamp*                                                                 | The Ready light flashes when in deep sleep mode.<br>Turning this to <b>On</b> is useful when the printer is installed in a place where it is difficult to see that the deep sleep mode light is lit.                                                                                                                                            |

\* AL-M320DN/AL-M310DN only

## Printer Adjust Menu

You can make special settings by using the control panel. Normally you do not need to change the settings.

### For AL-M320DN/AL-M310DN:

Pressing the **▼ Down** button while turning the printer on, opens the SUPPORT MODE. Press the **► Right** button, select **Common Settings** by pressing the **▲ Up** or **▼ Down** button, then select the **Printer Adjust Menu**.

### For AL-M220DN:

While pressing Alt, Ctrl and Z at the same time, click the **Extended Settings** button. The Printer Adjust Menu appears.

**Note:**

*The settings in this menu may affect the remaining service lives of consumable products.*



## Appendix

| Item             | Explanation                                                                                                                                                                                                                                                                                                                                                                                                                                                                                                                                                                                                                                                                                                                        |
|------------------|------------------------------------------------------------------------------------------------------------------------------------------------------------------------------------------------------------------------------------------------------------------------------------------------------------------------------------------------------------------------------------------------------------------------------------------------------------------------------------------------------------------------------------------------------------------------------------------------------------------------------------------------------------------------------------------------------------------------------------|
| 001 Plain        | <p>Adjusts the print quality for plain paper according to paper type.</p> <p>Settings (default in bold):</p> <p>1: Plain paper<br/> <b>2: Semi-thick paper</b></p> <p>For users of AL-M310DN and AL-M220DN in Taiwan:<br/> The default setting is 1: Plain paper.</p>                                                                                                                                                                                                                                                                                                                                                                                                                                                              |
| 020 Special      | <p>Adjusts the print quality for special paper according to the paper type.</p> <p>Settings (default in bold):</p> <p>0: Thin paper<br/> 1: Plain paper<br/> <b>2: Semi-thick paper</b><br/> 3: Letterhead<br/> 4: Thick paper<br/> 5: Extra-thick paper<br/> 6: Super-thick paper<br/> 7: When printing graph patterns, etc., on paper that is damp or paper that has been left out for a long time<br/> 8: When printing graph patterns, etc., on paper that is even damper or paper that has been left out for an even longer time than in 7<br/> 9: When you want to reduce the effects that hole punches have on images<br/> 10: When you want to reduce the effects that hole punches have on images even more than in 9</p> |
| 051 Feed Offset  | <p>Do this adjustment after you have eliminated the variation between the paper sources by 055/059/063/067/071/075</p> <p>This function adjusts the vertical position at which to start printing. The position moves lower on the sheet of paper as the value increases. This setting is used when doing single-sided printing or printing on the back side of the sheet of paper for duplex printing.</p> <p>Settings (default in bold):</p> <p>-3.5 ... <b>0.0</b> ... 3.5 mm in 0.5 mm increments</p>                                                                                                                                                                                                                           |
| 052 Scan Offset  | <p>Do this adjustment after you have eliminated the variation between the paper sources by 056/060/064/068/072/076.</p> <p>This function adjusts the horizontal position at which to start printing. The position moves to the right of the sheet of paper as the value increases. This setting is used when doing single-sided printing or printing on the back side of the sheet of paper for duplex printing.</p> <p>Settings (default in bold):</p> <p>-3.5 ... <b>0.0</b> ... 3.5 mm in 0.5 mm increments</p>                                                                                                                                                                                                                 |
| 053 Feed Offset2 | <p>Do this adjustment after you have eliminated the variation between the paper sources by 057/061/065/069/073/077.</p> <p>This function adjusts the vertical position at which to start printing. The position moves lower on the sheet of paper as the value increases. This setting is used when printing on the front side of the sheet of paper for duplex printing.</p> <p>Settings (default in bold):</p> <p>-3.5 ... <b>0.0</b> ... 3.5 mm in 0.5 mm increments</p>                                                                                                                                                                                                                                                        |

## Appendix

| Item                                                                                                            | Explanation                                                                                                                                                                                                                                                                                                                                                                                                                                                                       |
|-----------------------------------------------------------------------------------------------------------------|-----------------------------------------------------------------------------------------------------------------------------------------------------------------------------------------------------------------------------------------------------------------------------------------------------------------------------------------------------------------------------------------------------------------------------------------------------------------------------------|
| 054 Scan Offset2                                                                                                | <p>Do this adjustment after you have eliminated the variation between the paper sources by 058/062/066/070/074/078.</p> <p>This function adjusts the horizontal position at which to start printing. The position moves to the right of the sheet of paper as the value increases. This setting is used when printing on the front side of the sheet of paper for duplex printing.</p> <p>Settings (default in bold):<br/>-3.5 ... <b>0.0</b> ... 3.5 mm in 0.5 mm increments</p> |
| 055 Feed Reg1 MP<br>059 Feed Reg1 C1<br>063 Feed Reg1 C2*<br>067 Feed Reg1 C3*<br><br>*AL-M320DN/AL-M310DN only | <p>Adjusts the vertical position at which to start printing and eliminate the variation between the paper sources. The position moves lower on the sheet of paper as the value increases. This setting is used when feeding paper for single-sided printing or printing on the back side of the sheet of paper for duplex printing.</p> <p>Settings (default in bold):<br/>-3.5 ... <b>0.0</b> ... 3.5 mm in 0.5 mm increments</p>                                                |
| 056 Scan Reg1 MP<br>060 Scan Reg1 C1<br>064 Scan Reg1 C2*<br>068 Scan Reg1 C3*<br><br>*AL-M320DN/AL-M310DN only | <p>Adjusts the horizontal position at which to start printing and eliminate the variation between the paper sources. The position moves to the right of the sheet of paper as the value increases. This setting is used when feeding paper for single-sided printing or printing the back side of the sheet of paper for duplex printing.</p> <p>Settings (default in bold):<br/>-3.5 ... <b>0.0</b> ... 3.5 mm in 0.5 mm increments</p>                                          |
| 057 Feed Reg2 MP<br>061 Feed Reg2 C1<br>065 Feed Reg2 C2*<br>069 Feed Reg2 C3*<br><br>*AL-M320DN/AL-M310DN only | <p>Adjusts the vertical position at which to start printing and eliminate the variation between the paper sources. The position moves lower on the sheet of paper as the value increases. This setting is used when feeding paper for printing on the front side of the sheet of paper for duplex printing.</p> <p>Settings (default in bold):<br/>-3.5 ... <b>0.0</b> ... 3.5 mm in 0.5 mm increments</p>                                                                        |
| 058 Scan Reg2 MP<br>062 Scan Reg2 C1<br>066 Scan Reg2 C2*<br>070 Scan Reg2 C3*<br><br>*AL-M320DN/AL-M310DN only | <p>Adjusts the horizontal position at which to start printing and eliminate the variation between the paper sources. The position moves to the right of the sheet of paper as the value increases. This setting is used when feeding paper for printing on the front side of the sheet of paper for duplex printing.</p> <p>Settings (default in bold):<br/>-3.5 ... <b>0.0</b> ... 3.5 mm in 0.5 mm increments</p>                                                               |
| 201 Highland                                                                                                    | <p>Adjust this setting if black dots appear on the printed page when using the printer in locations at high altitudes. Increasing the value makes the printer more suited for higher altitudes. For the altitudes at which this printer can be operated, see <a href="#">"General" on page 101</a>.</p> <p>Settings (default in bold):<br/><b>0</b> ... 3 (step 1)</p>                                                                                                            |
| 202 Main Charger                                                                                                | <p>Adjusts the print density by correcting for the voltage of the main charger. The printout becomes lighter as the value increases.</p> <p>Settings (default in bold):<br/>0 ... <b>4</b> ... 7 (step 1)</p>                                                                                                                                                                                                                                                                     |
| 203 Drum Refresh                                                                                                | <p>Refreshes the drum. It may alleviate smears on the printouts. Note that before refreshing the drum, make sure no paper is loaded in the MP tray.</p>                                                                                                                                                                                                                                                                                                                           |

## Appendix

| Item                                             | Explanation                                                                                                                                                                                                                                                                                                                                 |
|--------------------------------------------------|---------------------------------------------------------------------------------------------------------------------------------------------------------------------------------------------------------------------------------------------------------------------------------------------------------------------------------------------|
| 207 Toner Install                                | Mixes toner in the developer to spread it evenly, this prevents the printouts from being too light. Do not turn off the printer until the LCD panel displays Ready.                                                                                                                                                                         |
| 209 Fuser Control                                | Select <b>1</b> if the fluorescent light flickers when printing.<br><br>Settings (default in bold):<br><b>0</b> : Normal mode<br><b>1</b> : Reducing flicker mode                                                                                                                                                                           |
| 301 Noise Level                                  | Adjusts the image gradation. As the value increases, the image gradation gets better, but the image granularity gets worse.<br><br>Settings (default in bold):<br><b>0</b> ... <b>3</b> ... 7 (step 1)                                                                                                                                      |
| 303 Screen 25<br>304 Screen 50<br>305 Screen 100 | Prints halftone or full pattern which allows you to check the unevenness of the density or pitch of the printout.<br><br><del>303</del> Screen 25 prints the pattern in a 25% density halftone.<br><del>304</del> Screen 50 prints the pattern in a 50 % density halftone.<br><del>305</del> Screen 100 prints the pattern at 100% density. |

## Consumable Products and Options

### Consumable products

| Product name                                   | Part number | Remark                                                                                                                                                                                                                                                                          |
|------------------------------------------------|-------------|---------------------------------------------------------------------------------------------------------------------------------------------------------------------------------------------------------------------------------------------------------------------------------|
| Standard Capacity Toner Cartridge              | 10080       | <input type="checkbox"/> Storage temperature:<br>10 to 32.5°C (50 to 90.5°F)<br><br><input type="checkbox"/> Storage humidity:<br>15 to 80% RH<br><br><input type="checkbox"/> These products comply with CE marking requirements in accordance with EMC Directive 2004/108/EC. |
| High Capacity Toner Cartridge                  | 10079       |                                                                                                                                                                                                                                                                                 |
| Extra Capacity Toner Cartridge (for AL-M320DN) | 10078       |                                                                                                                                                                                                                                                                                 |
| Maintenance Unit A (for AL-M320DN/AL-M310DN)   | 10081       |                                                                                                                                                                                                                                                                                 |
| Maintenance Unit B (for AL-M320DN/AL-M310DN)   | 10082       |                                                                                                                                                                                                                                                                                 |

### Options

| Product name                                            | Part number | Remark                                                                                           |
|---------------------------------------------------------|-------------|--------------------------------------------------------------------------------------------------|
| 250-Sheet Paper Cassette Unit (for AL-M320DN/AL-M310DN) | C12C932811  | This product complies with CE marking requirements in accordance with EMC Directive 2004/108/EC. |

## Appendix

# Copyrights, Trademarks, and Licenses

EPSON, EPSON EXCEED YOUR VISION, EXCEED YOUR VISION, EPSON ESC Page, EPSON ESC/P and their logos are registered trademarks and Epson ESC/P2 are trademarks of Seiko Epson Corporation.

Microsoft®, Windows®, Windows Server®, Windows Vista®, and Wingdings® are registered trademarks of Microsoft Corporation.

Apple®, Mac®, OS X®, Bonjour®, ColorSync®, FireWire®, Safari®, and TrueType® are registered trademarks of Apple, Inc.

HP and HP LaserJet are registered trademarks of the Hewlett-Packard Company.

PCL is the registered trademark of Hewlett-Packard Company.

Adobe, the Adobe logo, Acrobat, PostScript®3™, and Reader are either registered trademarks or trademarks of Adobe Systems Incorporated in the United States and/or other countries.

*General Notice: Other product names used herein are for identification purposes only and may be trademarks of their respective owners. Epson disclaims any and all rights in those marks.*

© 2017 Seiko Epson Corporation

---

## SOFTWARE LICENSE

1) This product includes open source software programs according to the license terms of each open source software program.

2) We provide the source code of some of such open source softwares until five (5) years after the discontinuation of same model of this printer product. If you desire to receive the source code above, please contact the customer support of your region. You shall comply with the license terms of each open source software program.

3) The open source software programs are WITHOUT ANY WARRANTY; without even the implied warranty of MERCHANTABILITY AND FITNESS FOR A PARTICULAR PURPOSE. See the license agreements of each open source software program for more details, which are described on \Manual\LICENSE.pdf.

4) The license terms of each open source software program are described on \Manual\LICENSE\_D.pdf.

## Standard and Approvals

European model:

|                                  |                                                              |
|----------------------------------|--------------------------------------------------------------|
| Low Voltage Directive 2014/35/EU | EN 60950-1<br>EN 60825-1                                     |
| EMC Directive 2014/30/EU         | EN 55032 Class B<br>EN 55024<br>EN 61000-3-2<br>EN 61000-3-3 |

---

## German Blue Angel

See the following website to check whether or not this printer meets the standards for the German Blue Angel.

<http://www.epson.de/blauerengel>

---

## Energy Star

ENERGY STAR® qualification applies only within the Japanese, American, and Canadian markets.

---

# Where To Get Help

---

## Technical Support Web Site

If you need further help, visit the Epson support website shown below. Select your country or region and go to the support section of your local Epson website. The latest drivers, FAQs, manuals, or other downloadables are also available from the site.

<http://support.epson.net/>

<http://www.epson.eu/Support> (Europe)

If your Epson product is not operating properly and you cannot solve the problem, contact Epson support services for assistance.

## Contacting Epson Support

---

### Before Contacting Epson

If your Epson product is not operating properly and you cannot solve the problem using the troubleshooting information in your product manuals, contact Epson support services for assistance.

The following Epson support list is based on the country of sale. Some products may not be sold in your current location, so be sure to contact Epson support for the area in which you purchased your product.

If Epson support for your area is not listed below, contact the dealer where you purchased your product.

Epson support will be able to help you much more quickly if you give them the following information:

- Product serial number  
(The serial number label is on the front of the printer and can be viewed when you open the paper tray.)
- Product model
- Product software version  
(Click **About**, **Version Info**, or similar button in the product software.)
- Brand and model of your computer
- Your computer operating system name and version
- Names and versions of the software applications you normally use with your product

**Note:**

*Depending on the product, network settings may be stored in the product's memory. Due to breakdown or repair of a product, settings may be lost. Epson shall not be responsible for the loss of any data, for backing up or recovering settings even during a warranty period. We recommend that you make your own backup data or take notes.*

## Where To Get Help

---

### Help for Users in Europe

Check your **Pan-European Warranty Document** for information on how to contact Epson support.

---

### Help for Users in Taiwan

Contacts for information, support, and services are:

#### World Wide Web

<http://www.epson.com.tw>

Information on product specifications, drivers for download, and products enquiry are available.

#### Epson HelpDesk

Phone: +886-2-2165-3138

Our HelpDesk team can help you with the following over the phone:

- Sales enquiries and product information
- Product usage questions or problems
- Enquiries on repair service and warranty

#### Repair service center:

<http://www.tekcare.com.tw/branchMap.page>

TekCare corporation is an authorized service center for Epson Taiwan Technology & Trading Ltd.

---

### Help for Users in Singapore

Sources of information, support, and services available from Epson Singapore are:

#### World Wide Web

<http://www.epson.com.sg>

Information on product specifications, drivers for download, Frequently Asked Questions (FAQ), Sales Enquiries, and Technical Support via e-mail are available.

#### Epson Helpdesk

Toll Free: 800-120-5564

Our HelpDesk team can help you with the following over the phone:

- Sales enquiries and product information

## Where To Get Help

- Product usage questions or problem troubleshooting
- Enquiries on repair service and warranty

---

## Help for Users in Thailand

Contacts for information, support, and services are:

### World Wide Web

<http://www.epson.co.th>

Information on product specifications, drivers for download, Frequently Asked Questions (FAQ), and e-mail are available.

### Epson Call Center

Phone: 66-2685-9899

Email: [support@eth.epson.co.th](mailto:support@eth.epson.co.th)

Our Hotline team can help you with the following over the phone:

- Sales enquiries and product information
- Product usage questions or problems
- Enquiries on repair service and warranty

---

## Help for Users in Vietnam

Contacts for information, support, and services are:

### Epson Service Center

65 Truong Dinh Street, District 1, Hochiminh City, Vietnam

Phone (Ho Chi Minh City): 84-8-3823-9239, 84-8-3825-6234

29 Tue Tinh, Quan Hai Ba Trung, Hanoi City, Vietnam

Phone (Hanoi City): 84-4-3978-4785, 84-4-3978-4775

---

## Help for Users in Indonesia

Contacts for information, support, and services are:

### World Wide Web

<http://www.epson.co.id>

## Where To Get Help

- Information on product specifications, drivers for download
- Frequently Asked Questions (FAQ), Sales Enquiries, questions through e-mail

## Epson Hotline

Phone: +62-1500-766

Fax: +62-21-808-66-799

Our Hotline team can help you with the following over the phone or fax:

- Sales enquiries and product information
- Technical support

## Epson Service Center

| Province | Company Name                                 | Address                                                                         | Phone<br>E-mail                                                                                         |
|----------|----------------------------------------------|---------------------------------------------------------------------------------|---------------------------------------------------------------------------------------------------------|
| JAKARTA  | Epson Sales and Service Jakarta (SUDIRMAN)   | Wisma Keiai Lt. 1 Jl. Jenderal Sudirman Kav.3 Jakarta Pusat - DKI JAKARTA 10220 | 021-5724335<br>ess@epson-indonesia.co.id;<br>ess.support@epson-indonesia.co.id                          |
| SERPONG  | Epson Sales and Service Serpong              | Ruko Melati Mas Square Blok A2 No. 17 Serpong-Banten                            | 082120090084 /<br>082120090085<br>esstag@epson-indonesia.co.id;<br>esstag.support@epson-indonesia.co.id |
| SEMARANG | Epson Sales and Service Semarang             | Komplek Ruko Metro Plaza Block C20 Jl. MT Haryono No. 970 Semarang -JAWA TENGAH | 024 8313807 / 024 8417935<br>esssmg@epson-indonesia.co.id;<br>esssmg.support@epson-indonesia.co.id      |
| JAKARTA  | Epson Sales and Service Jakarta (MANGGA DUA) | Ruko Mall Mangga Dua No. 48 Jl. Arteri Mangga Dua, Jakarta Utara - DKI JAKARTA  | 021 623 01104<br>jkt-technical1@epson-indonesia.co.id<br>jkt-admin@epson-indonesia.co.id                |
| BANDUNG  | Epson Sales and Service Bandung              | Jl. Cihampelas No. 48 A Bandung Jawa Barat 40116                                | 022 420 7033<br>bdg-technical@epson-indonesia.co.id<br>bdg-admin@epson-indonesia.co.id                  |
| MAKASSAR | Epson Sales and Service Makassar             | Jl. Cendrawasih NO. 3A, kunjung mae,mariso, MAKASSAR - SULSEL 90125             | 0411- 8911071<br>mksr-technical@epson-indonesia.co.id<br>mksr-admin@epson-indonesia.co.id               |



### Where To Get Help

| Province   | Company Name                           | Address                                                                                                  | Phone<br>E-mail                                                                                             |
|------------|----------------------------------------|----------------------------------------------------------------------------------------------------------|-------------------------------------------------------------------------------------------------------------|
| MEDAN      | Epson Service Center Medan             | Jl. Bambu 2 Komplek Graha Niaga Nomor A-4, Medan - SUMUT                                                 | 061- 42066090 / 42066091<br>mdn-technical@epson-indonesia.co.id<br>mdn-adm@epson-indonesia.co.id            |
| PALEMBANG  | Epson Service Center Palembang         | Jl. H.M Rasyid Nawawi No. 249 Kelurahan 9 Ilir Palembang Sumatera Selatan                                | 0711 311 330<br>escplg@epson-indonesia.co.id;<br>escplg.support@epson-indonesia.co.id                       |
| PEKANBARU  | Epson Service Center Pekanbaru         | Jl. Tuanku Tambusai No. 459 A Kel. Tangkerang barat Kec Marpoyan damai Pekanbaru - Riau 28282            | 0761- 8524695<br>pkb-technical@epson-indonesia.co.id<br>pkb-admin@epson-indonesia.co.id                     |
| PONTIANAK  | Epson Service Center Pontianak         | Komp. A yani Sentra Bisnis G33, Jl. Ahmad Yani - Pontianak Kalimantan Barat                              | 0561- 735507 / 767049<br>pontianak-technical@epson-indonesia.co.id<br>pontianak-admin@epson-indonesia.co.id |
| SAMARINDA  | Epson Service Center Samarinda         | Jl. KH. Wahid Hasyim (M. Yamin) Kelurahan Sempaja Selatan Kecamatan Samarinda UTARA - SAMARINDA - KALTIM | 0541 7272 904<br>escsmd@epson-indonesia.co.id;<br>escsmd.support@epson-indonesia.co.id                      |
| SURABAYA   | Epson Sales & Service Surabaya (barat) | Jl. Haji Abdul Wahab Saimin, Ruko Villa Bukit Mas RM-11, Kec. Dukuh Pakis, Surabaya - 60225              | 031- 5120994<br>sby-technical@epson-indonesia.co.id<br>sby-admin@epson-indonesia.co.id                      |
| YOGYAKARTA | Epson Service Center Yogyakarta        | YAP Square, Block A No. 6 Jl. C Simanjutak Yogyakarta - DIY                                              | 0274 581 065<br>ygy-technical@epson-indonesia.co.id<br>ygy-admin@epson-indonesia.co.id                      |
| JEMBER     | Epson Service Center Jember            | JL. Panglima Besar Sudirman Ruko no. 1D Jember-Jawa Timur (Depan Balai Penelitian & Pengolahan Kakao)    | 0331- 488373 / 486468<br>jmr-admin@epson-indonesia.co.id;<br>jmr-technical@epson-indonesia.co.id            |
| MANADO     | EPSON SALES AND SERVICE Manado         | Jl. Piere Tendean Blok D No 4 Kawasan Mega Mas Boulevard - Manado 95111                                  | 0431- 8805896<br>MND-ADMIN@EPSON-INDONESIA.CO.ID<br>MND-TECHNICAL@EPSON-INDONESIA.CO.ID                     |

### Where To Get Help

| Province    | Company Name                       | Address                                                               | Phone<br>E-mail                                                                                                     |
|-------------|------------------------------------|-----------------------------------------------------------------------|---------------------------------------------------------------------------------------------------------------------|
| CIREBON     | EPSON SERVICE CENTER Cirebon       | Jl. Tuparev No. 04 (Depan Hotel Apita) Cirebon, JAWA BARAT            | 0231- 8800846<br>cbn-technical@epson-indonesia.co.id                                                                |
| CIKARANG    | EPSON SALES AND SERVICE CIKARANG   | Ruko Metro Boulevard B1 Jababeka cikarang - Jawa Barat,               | 021- 89844301 / 29082424<br>ckg-admin@epson-indonesia.co.id<br>ckg-technical@epson-indonesia.co.id                  |
| MADIUN      | EPSON SERVICE CENTER MADIUN        | Jl. Diponegoro No.56, MADIUN - JAWA TIMUR                             | 0351- 4770248<br>mun-admin@epson-indonesia.co.id<br>mun-technical@epson-indonesia.co.id                             |
| PURWOKERTO  | EPSON SALES AND SERVICE Purwokerto | Jl. Jendral Sudirman No. 4 Kranji Purwokerto - JAWA TENGAH            | 0281- 6512213<br>pwt-admin@epson-indonesia.co.id<br>pwt-technical@epson-indonesia.co.id                             |
| BOGOR       | EPSON SALES AND SERVICE Bogor      | Jl.Pajajaran No 15B Kel Bantarjati Kec Bogor Utara - JAWA BARAT 16153 | 0251- 8310026<br>bgr-admin@epson-indonesia.co.id<br>bgr-technical@epson-indonesia.co.id                             |
| SERANG      | EPSON SERVICE CENTER Serang        | Jl. Ahmad Yani No.45C, SERANG - BANTEN                                | 0254- 7912503<br>srg-admin@epson-indonesia.co.id<br>srg-technical@epson-indonesia.co.id                             |
| PALU        | EPSON SALES AND SERVICE Palu       | Jl. Juanda No. 58, Palu - Sulteng                                     | 0451- 4012 881<br>plw-admin@epson-indonesia.co.id<br>plw-technical@epson-indonesia.co.id                            |
| BANJARMASIN | EPSON SERVICE CENTER BANJARMASIN   | Jl. Gatot Soebroto NO. 153 BANJARMASIN - KALSEL 70235                 | 0511- 6744135 (TEKNISI) / 3266321(ADMIN)<br>bdj-admin@epson-indonesia.co.id;<br>bdj-technical@epson-indonesia.co.id |
| DENPASAR    | EPSON SALES AND SERVICE Denpasar   | JL. MAHENDRADATA NO. 18, DENPASAR - BALI                              | 0361- 3446699 / 9348428<br>dps-admin@epson-indonesia.co.id<br>dps-technical@epson-indonesia.co.id                   |

## Where To Get Help

| Province | Company Name                              | Address                                                                                                  | Phone<br>E-mail                                                                                                                                                                     |
|----------|-------------------------------------------|----------------------------------------------------------------------------------------------------------|-------------------------------------------------------------------------------------------------------------------------------------------------------------------------------------|
| JAKARTA  | EPSON SALES AND SERVICE CILANDAK          | CIBIS Business Park Tower 9 LT. MEZZANINE, Jalan TB Simatupang No.2, Jakarta Selatan - DKI JAKARTA 12560 | 021- 80866777<br>esscibis.support1@epson-indonesia.co.id<br>esscibis.support2@epson-indonesia.co.id<br>esscibis.admin@epson-indonesia.co.id<br>esscibis.sales@epson-indonesia.co.id |
| SURABAYA | EPSON SALES AND SERVICE SURABAYA (GUBENG) | JL. RAYA GUBENG NO. 62, SURABAYA - JAWA TIMUR                                                            | 031- 99444940 / 99446299 / 99446377<br>esssby@epson-indonesia.co.id;<br>esssby.support@epson-indonesia.co.id                                                                        |
| AMBON    | EPSON SERVICE CENTER AMBON                | Jl. Diponegoro No.37 (Samping Bank Mandiri Syariah) Kel.Ahusen, Kec.Sirimau - Ambon 97127                | -                                                                                                                                                                                   |

For other cities not listed here, call the Hot Line: 08071137766.

---

## Help for Users in Hong Kong

To obtain technical support as well as other after-sales services, users are welcome to contact Epson Hong Kong Limited.

### Internet Home Page

<http://www.epson.com.hk>

Epson Hong Kong has established a local home page in both Chinese and English on the Internet to provide users with the following information:

- Product information
- Answers to Frequently Asked Questions (FAQs)
- Latest versions of Epson product drivers

### Technical Support Hotline

You can also contact our technical staff at the following telephone and fax numbers:

Phone: 852-2827-8911

Fax: 852-2827-4383

## Where To Get Help

---

### Help for Users in Malaysia

Contacts for information, support, and services are:

#### World Wide Web

<http://www.epson.com.my>

- Information on product specifications, drivers for download
- Frequently Asked Questions (FAQ), Sales Enquiries, questions through e-mail

#### Epson Call Center

Phone: 1800-81-7349 (Toll Free)

Email: [websupport@emsb.epson.com.my](mailto:websupport@emsb.epson.com.my)

- Sales enquiries and product information
- Product usage questions or problems
- Enquiries on repair services & warranty

#### Head Office

Phone: 603-56288288

Fax: 603-5628 8388/603-5621 2088

---

### Help for Users in the Philippines

To obtain technical support as well as other after sales services, users are welcome to contact the Epson Philippines Corporation at the telephone and fax numbers and e-mail address below:

#### World Wide Web

<https://www.epson.com.ph/>

Information on product specifications, drivers for download, Frequently Asked Questions (FAQ), and E-mail Enquiries are available.

#### Epson Philippines Customer Care

Toll Free (PLDT): 1-800-1069-37766

Toll Free (Digital): 1-800-3-0037766

Metro Manila: (632) 8441 9030

Web Site: <https://www.epson.com.ph/contact>

## Where To Get Help

E-mail: [customercare@epc.epson.com.ph](mailto:customercare@epc.epson.com.ph)

Accessible 9am to 6pm, Monday through Saturday (Except public holidays)

Our Customer Care team can help you with the following over the phone:

- Sales enquiries and product information
- Product usage questions or problems
- Enquiries on repair service and warranty

## Epson Philippines Corporation

Trunk Line: +632-706-2609

Fax: +632-706-2663