

EPSON

ES-C380W

User's Guide

Product Features

Scanner Basics

Placing Originals

Scanning

Maintenance

Solving Problems

Contents

About This Manual

Introduction to the Manuals.	7
Marks and Symbols.	7
Descriptions Used in this Manual.	7
Operating System References.	7
Copyright.	8
Trademarks.	8

Important Instructions

Safety Instructions.	11
Restrictions on Copying.	12
Advisories and Warnings for Using the Touchscreen.	12
Advisories and Warnings for Connecting to the Internet.	13
Protecting Your Personal Information.	13
Notes on the Administrator Password.	13
Initial Administrator Password.	13
Operations that Require the Administrator Password.	13
Changing the Administrator Password.	14
Resetting the Administrator Password.	14

Product Features

Scanning Passports or Booklets.	16
Sending Scanned Images Simply by Operating the Touch Screen (Scan to Features).	16
Supports Epson Smart Panel, an App for Smart Devices.	18
Notification of Dirt on the Glass Surface.	18
Useful Image Quality Adjustment Features.	19

Scanner Basics

Part Names and Functions.	23
Inserting and Removing a USB Drive.	26
Inserting a USB Drive.	26
Removing a USB Drive.	26
Position of Scanner.	27
Control Panel.	28
Buttons and Lights.	28
Guide to the LCD Screen.	29
Registering Presets.	32
Information on Applications.	34

Application for Scanning from a Computer (Epson ScanSmart).	35
Application for Scanning from Smart Devices (Epson Smart Panel).	35
Application for Updating Software and Firmware (EPSON Software Updater).	35
Application for Configuring Scanner Operations (Web Config).	36
Application for Setting up the Device on a Network (EpsonNet Config).	38
Software for Managing Devices on the Network (Epson Device Admin).	39
Application for Creating Driver Packages (EpsonNet SetupManager).	39
Application for Scanning Business Cards (Presto! BizCard).	39
Option Items and Consumables Information.	40
Carrier Sheet Codes.	40
Roller Assembly Kit Codes.	41
Cleaning Kit Codes.	41

Placing Originals

Specifications for Originals that can be Scanned.	43
General Specifications for Originals Being Scanned.	43
Scannable Standard Size Originals.	43
Scannable Large Originals.	45
Scannable Long Paper.	45
Scannable Receipts.	47
Scannable Plastic Cards.	48
Scannable Laminated Cards.	48
Scannable Booklets.	49
Passports.	49
Specifications for Originals Using the Carrier Sheet.	50
Scannable Envelopes.	51
Types of Originals that Require Attention.	52
Types of Originals that Must Not be Scanned.	52
Placing Originals in the Scanner.	53
Combinations of Originals and Scanner Position.	53
Placing Standard Size Originals.	55
Placing Large Size Originals.	60
Placing Long Paper.	63
Placing Plastic Cards.	67
Placing Laminated Cards.	71
Placing a Booklet.	74
Placing a Passport.	77

Placing Important Originals or Photos.	82
Placing an Envelope.	86
Placing Irregular Shaped Originals.	90
Loading Batches of Originals with Different Paper Types and Sizes.	93

Scanning

Preparing to Scan from the Control Panel (the Scan to Features).	99
To Send by Email.	99
Scan to Computer Feature Work Flow.	100
Scan to USB Drive Feature Work Flow.	100
Scan to Cloud Feature Work Flow.	100
Scan to Email Feature Work Flow.	102
Scan to Network Folder/FTP Feature Work Flow.	102
Scan to WSD Work Flow.	104
Scanning from the Control Panel (the Scan to Features).	104
Saving to a Computer.	104
Saving to a USB Drive.	105
Sending to the Cloud.	109
Scanning Originals to an Email.	113
Saving to a Network Folder.	117
Scanning Using WSD.	122
Combination of Features and Settings.	123
Scanning Using the Registered Contents in Presets	125
Scanning from a Computer.	126
Scanning Using Epson ScanSmart.	126
Software Image Quality Adjustment Features.	130
Scanning in Automatic Feeding Mode.	130
Using AirPrint.	133
Scanning Using Chromebook.	133
Scanning from a Smart Device.	134
Scanning Using Epson Smart Panel.	134
Scanning Using Mopria Scan.	134

Required Settings for Scanning

Connecting the Scanner to the Network.	137
Connecting to the Wireless LAN (Wi-Fi).	137
Setting Up Scanning from the Control Panel (the Scan to Features).	139
Creating a Network Folder.	140
Registering an Email Server.	146
Checking an Email Server Connection.	148
Registering Destinations to Contacts.	149
Function Comparison by Registration Tool.	150
Registering a Destination to Contacts.	150

Registering Destinations as a Group Using Web Config.	154
Backing Up and Importing Contacts.	155
Export and Bulk Registration of Contacts Using Tool.	156
Setting Up AirPrint.	158

Menu Options for Settings

Start-up Screen.	160
Basic Settings.	160
LCD Brightness.	160
Sounds.	160
Sleep Timer.	160
Power Off Settings.	160
Date/Time Settings.	161
Language.	161
Keyboard.	161
Operation Time Out.	161
PC Connection via USB.	161
Direct power on.	161
Scanner Settings.	161
User Settings.	162
Network Settings.	163
Wi-Fi Setup.	163
Network Status.	163
Advanced.	163
Web Service Settings.	164
Contacts Manager.	164
System Administration.	164
Contacts Manager.	164
Admin Settings.	165
Password Encryption.	165
Program Verification on Start Up:.	165
Customer Research.	165
WSD Settings.	165
Restore Default Settings.	165
Firmware Update:.	165
Device Information.	166
Scanner Maintenance.	166
Roller Replacement Alert Setting.	167
Regular Cleaning Alert Settings.	167

Useful Features

Setting the Glass Surface Stain Detection Feature.	169
Setting the Document Protection Feature.	170
Setting the Operation when a Double-feed is Detected.	171

Maintenance

Cleaning Outside the Scanner.	174
Cleaning Inside the Scanner.	174
Resetting the Number of Scans After Cleaning Inside the Scanner.	182
Replacing the Roller Assembly Kit.	182
Resetting the Number of Scans After Replacing the Rollers.	190
Energy Saving.	190
Moving the Scanner.	191
Transporting the Scanner.	191
How to Carry the Scanner.	192
Updating Applications and Firmware.	192
Updating the Scanner's Firmware using the Control Panel.	193
Updating Firmware Using Web Config.	193
Updating Firmware without Connecting to the Internet.	194

Solving Problems

Problems with the Scanner.	196
Checking Error Messages on the Control Panel.	196
The Scanner Does Not Turn On.	197
Forgot Your Administrator's Password.	197
Problems when Preparing Network Scanning.	198
Hints to Solving Problems.	198
Problems Starting Scanning.	200
Cannot Start Scanning from Computer.	200
Cannot Start Scanning from Smart Device.	204
Cannot Save Scanned Images to the Shared Folder.	207
Cannot Send Scanned Images to the Cloud.	208
Cannot Send Scanned Images to an Email.	208
Paper Feeding Problems.	209
Multiple Originals Are Fed (Double Feed).	209
Removing Jammed Originals from the Scanner.	210
Paper Jams, Paper Feed Errors, and Document Protection Issues Occur Frequently.	216
Paper Protection Does not Work Correctly.	217
The Originals Get Dirty.	217
Scanning Speed Slows Down when Scanning Continuously.	217
Scanning Takes a Long Time.	218
Scanned Image Problems.	218
Lines (Streaks) Appear when Scanning from ADF.	218
Alert About Stains Inside the Scanner Still Appears.	219

Colors Are Uneven in the Scanned Image.	219
Expanding or Contracting the Scanned Image.	219
An Image on the Back of Your Original Appears in Your Scanned Image.	220
Scanned Text or Images are Missing or Blurred.	220
Moiré Patterns (Web-Like Shadows) Appear.	221
The Edge of the Original is Not Scanned when Automatically Detecting the Size of the Original.	221
Character is not Recognized Correctly.	222
Cannot Solve Problems in the Scanned Image.	222
Uninstalling and Installing Applications.	223
Uninstalling Your Applications.	223
Installing Your Applications.	224

Adding or Replacing the Computer or Devices

Connecting to a Scanner that has been Connected to the Network.	227
Using a Network Scanner from a Second Computer.	227
Using a Network Scanner from a Smart Device.	228
Connecting a Smart Device and Scanner Directly (Wi-Fi Direct).	228
About Wi-Fi Direct.	228
Connecting to a Smart Device using Wi-Fi Direct.	229
Disconnecting Wi-Fi Direct (Simple AP) Connection.	229
Changing the Wi-Fi Direct (Simple AP) Settings Such as the SSID.	229
Re-setting the Network Connection.	230
When Replacing the Wireless Router.	230
When Changing the Computer.	231
Changing the Connection Method to the Computer.	231
Making Wi-Fi Settings from the Control Panel.	232
Checking the Network Connection Status.	232
Checking the Network Connection Status from the Control Panel.	232
Checking the Network of the Computer (Windows only).	234

Administrator Information

Connecting the Scanner to the Network.	236
Before Making Network Connection.	236
Assigning the IP Address.	238
Setting up the IEEE802.11k/v or IEEE802.11r Features.	239

Introduction of Product Security Features.	240
Administrator Settings.	240
Configuring the Administrator Password.	240
Using Lock Setting for the Control Panel.	242
Logging on to the Scanner from a Computer.	244
Disabling the External Interface.	245
Disabling Network Scanning from your Computer	245
Disabling WSD Scan.	246
Monitoring a Remote Scanner.	246
Checking Information for a Remote Scanner.	246
Receiving Email Notifications When Events Occur.	247
Backing Up the Settings.	248
Export the settings.	248
Import the settings.	248
Advanced Security Settings.	249
Security Settings and Prevention of Danger.	249
Controlling Using Protocols.	250
Using a Digital Certificate.	253
SSL/TLS Communication with the Scanner.	258
Encrypted Communication Using IPsec/IP Filtering.	259
Connecting the Scanner to an IEEE802.1X Network.	270
Solving Problems for Advanced Security.	271

Technical Specifications

General Scanner Specifications.	280
Network Specifications.	281
Wi-Fi Specifications.	281
Network Features and IPv4/IPv6 Support.	282
Security Protocol.	282
Supported Third Party Services.	282
USB Drive Specifications.	283
Using Port for the Scanner.	283
Dimensions and Weight Specifications.	284
Electrical Specifications.	285
Scanner Electrical Specifications.	285
AC Adapter Electrical Specifications.	286
Environmental Specifications.	286
System Requirements.	286

Standards and Approvals

Standards and Approvals for European Models.	288
Standards and Approvals for Australian Models.	288
Standards and Approvals for U.S. Models.	288

Where to Get Help

Technical Support Web Site.	291
Contacting Epson Support.	291
Before Contacting Epson.	291
Help for Users in Europe.	291
Help for Users in Taiwan.	291
Help for Users in Australia.	292
Help for Users in Singapore.	292
Help for Users in Thailand.	293
Help for Users in Vietnam.	293
Help for Users in Indonesia.	294
Help for Users in Hong Kong.	294
Help for Users in Malaysia.	294
Help for Users in India.	295
Help for Users in the Philippines.	295

About This Manual

Introduction to the Manuals.	7
Marks and Symbols.	7
Descriptions Used in this Manual.	7
Operating System References.	7
Copyright.	8
Trademarks.	8

Introduction to the Manuals

The latest versions of the following manuals are available from the Epson support website.

<http://www.epson.eu/support> (Europe)

<http://support.epson.net/> (outside Europe)

Start Here (paper manual)

Provides you with information on setting up the product and installing the application.

User's Guide (digital manual)

Provides instructions on using the product, maintenance, and solving problems.

As well as the manuals above, see the help included in the various Epson applications.

Marks and Symbols



Caution:

Instructions that must be followed carefully to avoid bodily injury.



Important:

Instructions that must be observed to avoid damage to your equipment.

Note:

Provides complementary and reference information.

Related Information

➔ Links to related sections.

Descriptions Used in this Manual

Screenshots for the applications are from Windows 10 or macOS High Sierra. The content displayed on the screens varies depending on the model and situation.

Illustrations used in this manual are for reference only. Although they may differ slightly from the actual product, the operating methods are the same.

Operating System References

Windows

In this manual, terms such as "Windows 11", "Windows 10", "Windows 8.1", "Windows 8", and "Windows 7" refer to the following operating systems. Additionally, "Windows" is used to refer to all versions.

Microsoft® Windows® 11 operating system

- Microsoft® Windows® 10 operating system
- Microsoft® Windows® 8.1 operating system
- Microsoft® Windows® 8 operating system
- Microsoft® Windows® 7 operating system

Mac OS

In this manual, "macOS 12.x", "macOS 11.x", "macOS 10.15.x", "macOS 10.14.x", "macOS 10.13.x", "macOS 10.12.x", and "OS X 10.11.x" are collectively referred to as "Mac OS".

Copyright

No part of this publication may be reproduced, stored in a retrieval system, or transmitted in any form or by any means, electronic, mechanical, photocopying, recording, or otherwise, without the prior written permission of Seiko Epson Corporation. No patent liability is assumed with respect to the use of the information contained herein. Neither is any liability assumed for damages resulting from the use of the information herein. The information contained herein is designed only for use with this Epson product. Epson is not responsible for any use of this information as applied to other products.

Neither Seiko Epson Corporation nor its affiliates shall be liable to the purchaser of this product or third parties for damages, losses, costs, or expenses incurred by the purchaser or third parties as a result of accident, misuse, or abuse of this product or unauthorized modifications, repairs, or alterations to this product, or (excluding the U.S.) failure to strictly comply with Seiko Epson Corporation's operating and maintenance instructions.

Seiko Epson Corporation and its affiliates shall not be liable for any damages or problems arising from the use of any options or any consumable products other than those designated as Original Epson Products or Epson Approved Products by Seiko Epson Corporation.

Seiko Epson Corporation shall not be held liable for any damage resulting from electromagnetic interference that occurs from the use of any interface cables other than those designated as Epson Approved Products by Seiko Epson Corporation.

© 2023 Seiko Epson Corporation

The contents of this manual and the specifications of this product are subject to change without notice.

Trademarks

- EPSON, EPSON EXCEED YOUR VISION, EXCEED YOUR VISION and their logos are registered trademarks or trademarks of Seiko Epson.
- Microsoft® and Windows® are registered trademarks of Microsoft Corporation.
- Apple, Mac, macOS, OS X, Bonjour, Safari, and AirPrint are trademarks of Apple Inc., registered in the U.S. and other countries.
- Use of the Works with Apple badge means that an accessory has been designed to work specifically with the technology identified in the badge and has been certified by the developer to meet Apple performance standards.
- Chrome, Chromebook, Google Play and Android are trademarks of Google LLC.
- Mopria® and the Mopria® Logo are registered and/or unregistered trademarks and service marks of Mopria Alliance, Inc. in the United States and other countries. Unauthorized use is strictly prohibited.
- Firefox is a trademark of the Mozilla Foundation in the U.S. and other countries.

- ❑ General Notice: Other product names used herein are for identification purposes only and may be trademarks of their respective owners. Epson disclaims any and all rights in those marks.

Important Instructions

Safety Instructions.	11
Restrictions on Copying.	12
Advisories and Warnings for Using the Touchscreen.	12
Advisories and Warnings for Connecting to the Internet.	13
Protecting Your Personal Information.	13
Notes on the Administrator Password.	13

Safety Instructions

Read and follow these instructions to ensure safe use of this product and options. Make sure you keep this manual for future reference. Also, be sure to follow all warnings and instructions marked on the product and options.

- ❑ Some of the symbols used on your product and options are to ensure safety and proper use of the product. Visit the following Web site to learn the meaning of the symbols.

<http://support.epson.net/symbols>

- ❑ Place the product and options on a flat, stable surface that extends beyond the base of the product and options in all directions. If you place the product and options by the wall, leave more than 10 cm between the back of the product and options and the wall.
- ❑ Place the product and options close enough to the computer for the interface cable to reach it easily. Do not place or store the product and options or the AC adapter outdoors, near excessive dirt or dust, water, heat sources, or in locations subject to shocks, vibrations, high temperature or humidity, direct sunlight, strong light sources, or rapid changes in temperature or humidity.
- ❑ Do not use with wet hands.
- ❑ Place the product and options near an electrical outlet where the adapter can be easily unplugged.
- ❑ The AC adapter cord should be placed to avoid abrasions, cuts, fraying, crimping, and kinking. Do not place objects on top of the cord and do not allow the AC adapter or the cord to be stepped on or run over. Be particularly careful to keep the cord straight at the end.
- ❑ Use only the power cord supplied with the product and do not use the cord with any other equipment. Use of other cords with this product or the use of the supplied power cord with other equipment may result in fire or electric shock.
- ❑ Use only the AC adapter that comes with your product. Using any other adapter could cause fire, electrical shock, or injury.
- ❑ The AC adapter is designed for use with the product with which it was included. Do not attempt to use it with other electronic devices unless specified.
- ❑ Use only the type of power source indicated on the AC adapter's label, and always supply power directly from a standard domestic electrical outlet with the AC adapter that meets the relevant local safety standards.
- ❑ When connecting this product and options to a computer or other device with a cable, ensure the correct orientation of the connectors. Each connector has only one correct orientation. Inserting a connector in the wrong orientation may damage both devices connected by the cable.
- ❑ Avoid using outlets on the same circuit as photocopiers or air control systems that regularly switch on and off.
- ❑ If you use an extension cord with the product, make sure the total ampere rating of the devices plugged into the extension cord does not exceed the cord's ampere rating. Also, make sure the total ampere rating of all devices plugged into the wall outlet does not exceed the wall outlet's ampere rating.
- ❑ Never disassemble, modify, or attempt to repair the AC adapter, product, or product options by yourself except as specifically explained in the product's guides.
- ❑ Do not insert objects into any opening as they may touch dangerous voltage points or short out parts. Beware of electrical shock hazards.
- ❑ If damage occurs to the plug, replace the cord set or consult a qualified electrician. If there are fuses in the plug, make sure you replace them with fuses of the correct size and rating.
- ❑ Unplug the product, options, and the AC adapter, and refer servicing to qualified service personnel under the following conditions: The AC adapter or plug is damaged; liquid has entered the product, options, or the AC adapter; the product or the AC adapter has been dropped or the case has been damaged; the product, options, or the AC adapter does not operate normally or exhibits a distinct change in performance. (Do not adjust controls that are not covered by the operating instructions.)

- Unplug the product and the AC adapter before cleaning. Clean with a damp cloth only. Do not use liquid or aerosol cleaners except as specifically explained in the product's guides.
- If you are not going to use the product for a long period, be sure to unplug the AC adapter from the electrical outlet.
- After replacing consumable parts, dispose of them correctly following the rules of your local authority. Do not disassemble them.
- Keep this product at least 22 cm away from cardiac pacemakers. Radio waves from this product may adversely affect the operation of cardiac pacemakers.
- Do not use this product inside medical facilities or near medical equipment. Radio waves from this product may adversely affect the operation of electrical medical equipment.
- Do not use this product near automatically controlled devices such as automatic doors or fire alarms. Radio waves from this product may adversely affect these devices, and could lead to accidents due to malfunction.
- If the LCD screen is damaged, contact your dealer. If the liquid crystal solution gets on your hands, wash them thoroughly with soap and water. If the liquid crystal solution gets into your eyes, flush them immediately with water. If discomfort or vision problems remain after a thorough flushing, see a doctor immediately.

Restrictions on Copying

Observe the following restrictions to ensure the responsible and legal use of your product.

Copying of the following items is prohibited by law:

- Bank bills, coins, government-issued marketable securities, government bond securities, and municipal securities
- Unused postage stamps, pre-stamped postcards, and other official postal items bearing valid postage
- Government-issued revenue stamps, and securities issued according to legal procedure

Exercise caution when copying the following items:

- Private marketable securities (stock certificates, negotiable notes, checks, etc.), monthly passes, concession tickets, etc.
- Passports, driver's licenses, warrants of fitness, road passes, food stamps, tickets, etc.

Note:

Copying these items may also be prohibited by law.

Responsible use of copyrighted materials:

Products can be misused by improperly copying copyrighted materials. Unless acting on the advice of a knowledgeable attorney, be responsible and respectful by obtaining the permission of the copyright holder before copying published material.

Advisories and Warnings for Using the Touchscreen

- The LCD screen may contain a few small bright or dark spots, and because of its features it may have an uneven brightness. These are normal and do not indicate that it is damaged in any way.
- Only use a dry, soft cloth for cleaning. Do not use liquid or chemical cleaners.

- The exterior cover of the touchscreen could break if it receives a heavy impact. Contact your dealer if the panel surface chips or cracks, and do not touch or attempt to remove the broken pieces.
- Press the touchscreen gently with your finger. Do not press force or operate with your nails.
- Do not use sharp objects such as ball point pens or sharp pencils to perform operations.
- Condensation inside the touchscreen due to abrupt changes in temperature or humidity may cause performance to deteriorate.

Advisories and Warnings for Connecting to the Internet

Do not connect this product to the Internet directly. Connect it in a network protected by a router or firewall.

Protecting Your Personal Information

When you give the scanner to someone else or dispose of it, erase all the personal information stored in the scanner's memory by selecting the menus on the control panel as described below.

Settings > System Administration > Restore Default Settings > All Settings

Notes on the Administrator Password

This device allows you to set an administrator password to prevent unauthorized third parties from accessing or changing the device settings or the network settings stored in the device when it is connected to a network.

If you set an administrator password, you need to enter the password when changing settings in configuration software such as Web Config.

The initial administrator password is set on the scanner, but you can change it to any password.

Initial Administrator Password

The initial administrator password varies depending on the label attached to the product. If there is a "PASSWORD" label attached to the back, enter the 8-digit number shown on the label. If there is no "PASSWORD" label attached, enter the serial number on the label attached to the base of the product for the initial administrator password.

We recommend changing the initial administrator password from the default setting.

Note:

No user name is set as default.

Operations that Require the Administrator Password

If you are prompted to enter the administrator password during the following operations, enter the administrator password set on the product.

- When logging on to the advanced settings for Web Config

- When operating a menu on the control panel that has been locked by the administrator
- When changing the device settings in the application
- When updating the firmware for the device
- When changing or resetting the administrator password

Changing the Administrator Password

You can change from the product's control panel or in Web Config.

When changing the password, the new password must be 8 to 20 characters long and only contain single-byte alphanumeric characters and symbols.

Related Information

➔ [“Configuring the Administrator Password” on page 240](#)

Resetting the Administrator Password

You can reset the administrator password to the initial setting from the product's control panel or in Web Config. If you have forgotten the password and cannot reset it to the default settings, the product needs to be repaired. Contact your local dealer.

Note:

Resetting the administrator password also resets the user name.

Product Features

Scanning Passports or Booklets.	16
Sending Scanned Images Simply by Operating the Touch Screen (Scan to Features). .	16
Supports Epson Smart Panel, an App for Smart Devices.	18
Notification of Dirt on the Glass Surface.	18
Useful Image Quality Adjustment Features.	19

Scanning Passports or Booklets

You can scan originals such as passports or booklets by changing to the straight path position.

Scanning software allows you to save only the identification pages of your passport. (for Windows only)

See the scanner driver (Epson Scan 2) help for more details.

Note:

Epson Smart Panel only supports passport scanning.



Related Information

- ➔ [“Position of Scanner” on page 27](#)
- ➔ [“Passports” on page 49](#)
- ➔ [“Scannable Booklets” on page 49](#)



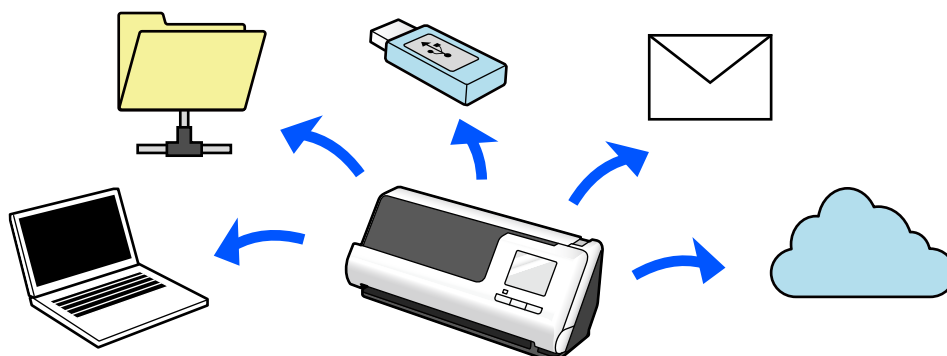

Sending Scanned Images Simply by Operating the Touch Screen (Scan to Features)

You can scan by simply operating the touch screen on the product without having to use a computer.

You can send the scanned image to a selected destination (such as a network folder, email, cloud service, or USB drive) by using the Scan to features.

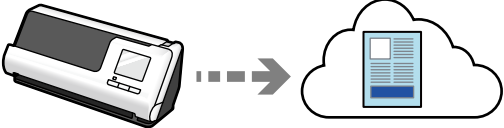

The feature you use depends on the destination of the scanned image.

Destination of Scanned Images	Feature to Use
<p>If you want to save images to a connected computer</p> 	<p>Scan to Computer Feature</p> <p>Scan by starting the software (Epson ScanSmart) installed on your computer from the control panel.</p> <p>“Scan to Computer Feature Work Flow” on page 100</p>
<p>If you want to save images to a USB drive connected to the scanner</p> 	<p>Scan to USB Drive Feature</p> <p>“Scan to USB Drive Feature Work Flow” on page 100</p>
<p>If you want to send images directly from the scanner to a cloud service</p> 	<p>Scan to Cloud Feature</p> <p>Using Epson's cloud service, <i>Epson Connect</i>, you can send scanned images to an email address and another company's cloud service.</p> <p>You can send images to cloud services such as Evernote, Google Drive, and Dropbox, as well as to an email address.</p> <p>“Scan to Cloud Feature Work Flow” on page 100</p> <p>Note: <i>Available services are subject to change without notice.</i></p>
<p>If you want to send images by email directly from the scanner</p> 	<p>There are two features that allow you to send scanned images as email attachments. See the following for more details.</p> <p>“To Send by Email” on page 99</p>
<p>If you want to save images to a folder on the network</p> 	<p>Scan to Network Folder/FTP Feature</p> <p>You need to create a shared folder on the same network as the scanner.</p> <p>As well as Network Folder (SMB), you can also set FTP/FTPS and WebDAV (HTTPS/HTTP) as the destination for scanned images.</p> <p>“Scan to Network Folder/FTP Feature Work Flow” on page 102</p>
<p>If you want to save images to a computer connected to the scanner using the WSD feature</p>	<p>Scan to WSD</p> <p>“Scan to WSD Work Flow” on page 104</p>

Related Information

➔ [“Preparing to Scan from the Control Panel \(the Scan to Features\)” on page 99](#)

Supports Epson Smart Panel, an App for Smart Devices

Epson Smart Panel, for Intuitive Operations



You can perform the following operations.

- You can scan from your smart device and save scanned results to your smart device.
- You can easily upload scanned data to a cloud service.
- You can easily make Wi-Fi settings by following the guidance provided.
- You can check the causes and solutions to errors from your smart device.

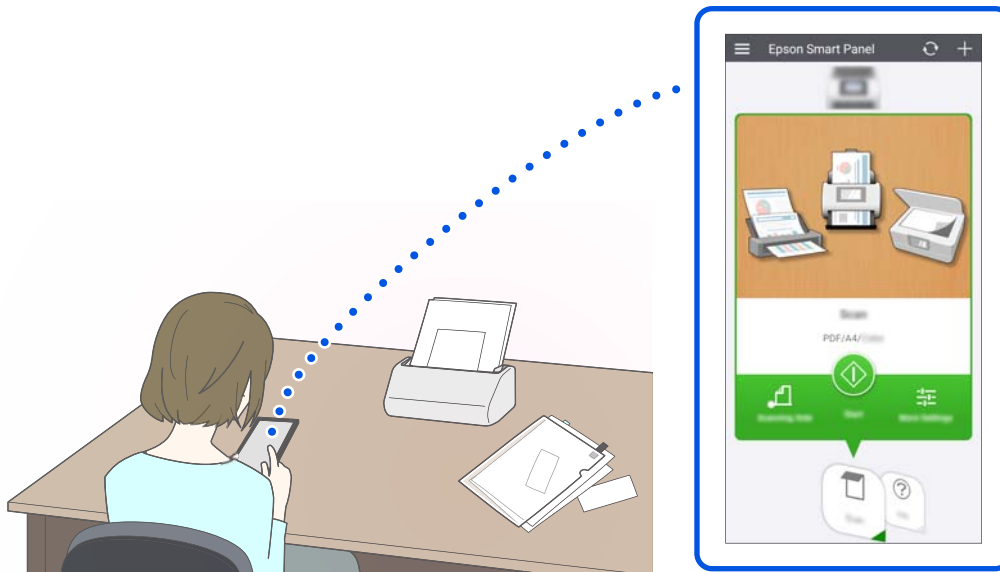

Related Information

➔ [“Application for Scanning from Smart Devices \(Epson Smart Panel\)” on page 35](#)

Notification of Dirt on the Glass Surface

This scanner can detect dirt on the glass surface, and notify you that you need to clean the glass surface before dirt can cause lines (streaks) in the scanned images.

You can easily keep the glass surface clean, and avoid a decline in image quality.

This feature is off by default.

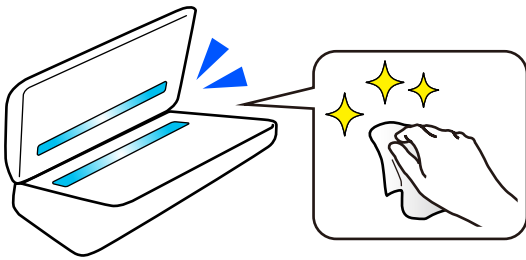

Related Information

- ➔ “Setting the Glass Surface Stain Detection Feature” on page 169
- ➔ “Cleaning Inside the Scanner” on page 174

Useful Image Quality Adjustment Features

Automatically Scan at the Optimum color

You can automatically detect the color of the original and then scan it. Even when color and black-and-white originals are mixed, they can be automatically scanned at the optimum color (Image Type).

Color original: Scan using Color.

Black-and-white originals with gradation (gray areas): Scan using Gray.

Black-and-white originals without gradation (no gray areas): Scan using B&W.

<p>Example of original</p>			
<p>Image Type to be identified</p>	<p>Color</p>	<p>Gray</p>	<p>B&W</p>

Select **Auto** as the **Image Type** in the scanner driver (Epson Scan 2).

When scanning from the control panel, select **Color/Grayscale/B&W**, **Color/Black & White**, or **Color/Grayscale** as the **Image Type**. The Image Type that can be selected differs depending on the feature used and the file format to be saved.

Note:

When using Epson Smart Panel, setting **Image Type** to **Auto** scans the image in Color or Gray.

Text Enhancement Feature

You can clearly scan text that is difficult to read due to backgrounds and other factors. You can emphasize text and remove dotted patterns in the background of the original according to the original.

You can set this on the **Advanced Settings** tab > **Text Enhancement** > **Settings** in the scanner driver (Epson Scan 2).

When scanning in Color or Gray

The following features are available.

Note:

When scanning from the control panel, you can only use the **Computer** feature.

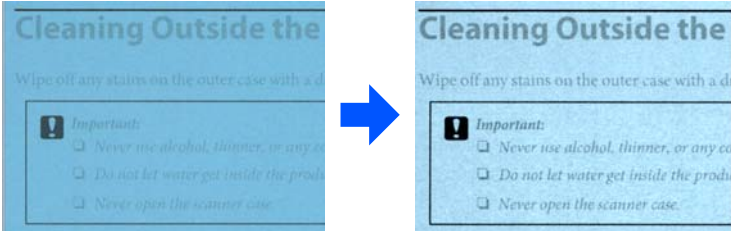
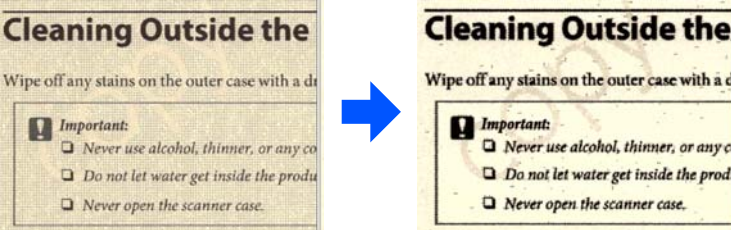
Features	Explanations
<p>Emphasize light letters for OCR</p>	<p>You can emphasize light letters so that they can be more easily recognized by OCR. You can adjust the level of the effect.</p> 
<p>Remove halftone dots</p>	<p>When scanning in Color or Gray, turn this on to remove dotted patterns in the background of the original.</p> 

When scanning in B&W

The following features are available.

Note:

You can also use these when scanning from the control panel.

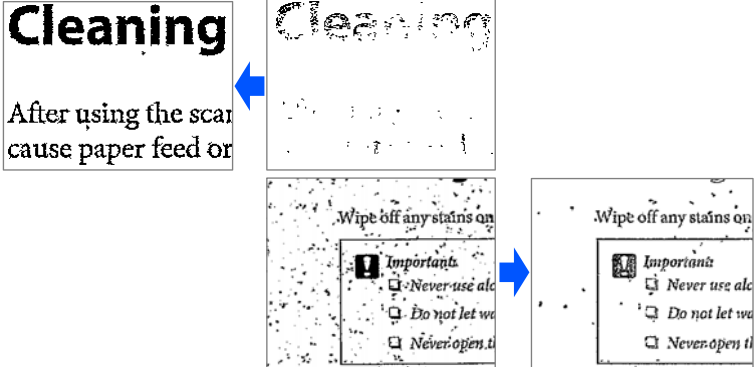
Features	Explanations
<p>Emphasize light letters / Remove background</p>	<p>You can set the level of text and background correction to enhance light text, remove background colors, patterns, wrinkles, and offset.</p> 

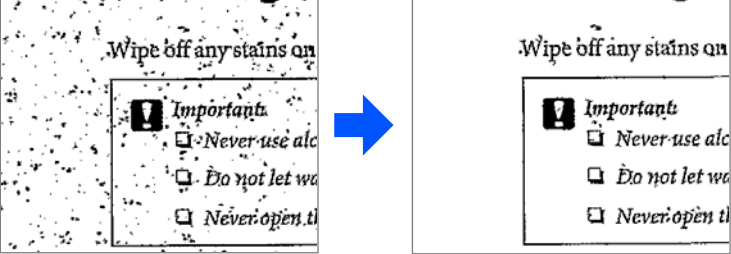
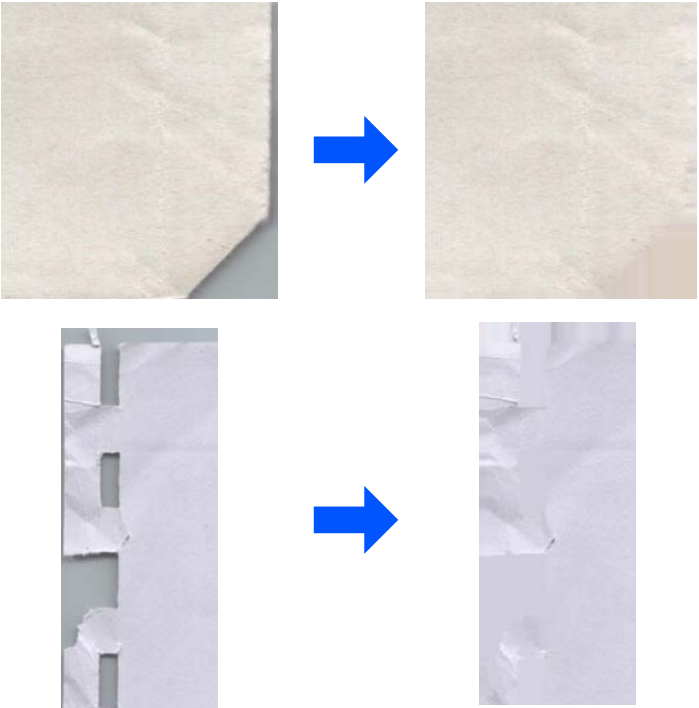
Features	Explanations
<p>Remove spot noise</p>	<p>You can remove black dots in the background of the original that cannot be removed by lightening the background. You can adjust the level of the effect.</p> 
<p>Correct folds or tears</p>	<p>You can correct scanned images when the corners or the edges of the original are folded or torn, or when a shadow appears around the scanned image. The missing edges or corners of the scanned image will be filled with the color of the original document.</p> 

Related Information

➔ [“Software Image Quality Adjustment Features” on page 130](#)

Scanner Basics

Part Names and Functions.	23
Inserting and Removing a USB Drive.	26
Position of Scanner.	27
Control Panel.	28
Information on Applications.	34
Option Items and Consumables Information.	40

Part Names and Functions

Front

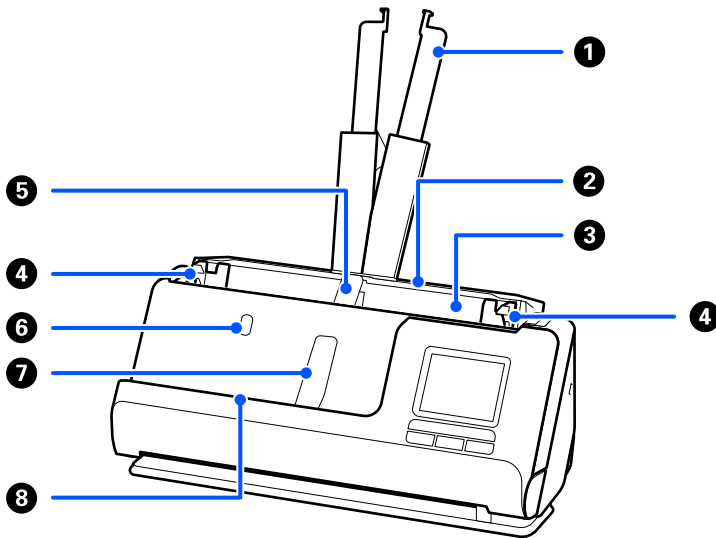

1	Input tray extension	Pull this out if the original extends beyond the edges of the tray. This prevents paper from curling and causing paper jams.
2	Input tray	Loads originals.
3	ADF (Automatic Document Feeder)	Feeds loaded originals automatically.
4	Edge guides	Use guides to supports the original in the input tray to facilitate a smooth feeding operation. Slide to the edges of the originals.
5	Input tray paper support	Supports the ejected original on the input tray side so that it is ejected correctly.
6	Input tray paper support button	Press this button to raise the input tray paper support. Store the paper support manually.
7	Output tray paper support	Supports the ejected original on the output tray side so that it is ejected correctly.
8	Output tray paper support button	Press this button to raise the output tray paper support. Store the paper support manually.

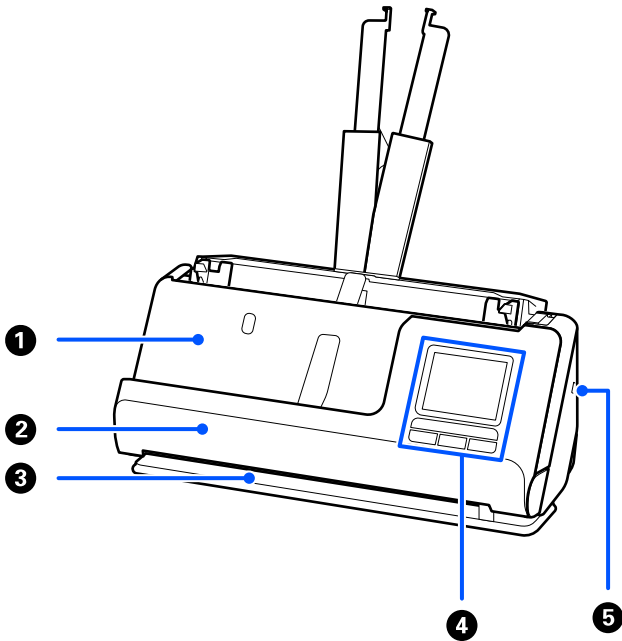

1	Output tray	Originals scanned in the vertical path position are ejected from here.
2	Vertical path cover	Open when cleaning the inside of the scanner, or when an original is jammed while scanning in the vertical path position.
3	Output slot	Originals scanned in the straight path position are ejected from here.
4	Control panel	Displays the scanner's status and performs scanner operations.
5	Security slot	Insert a security lock for theft prevention.

Side / Rear

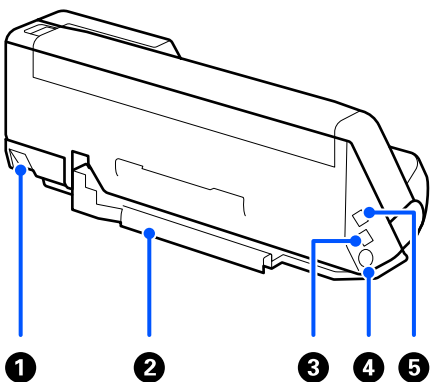

1	Scanner position selector	Used to change the scanner position between vertical path position and straight path position.
---	---------------------------	--

<p>2</p>	<p>Cable holder</p>	<p>Secures the cables neatly to the scanner at the bottom.</p> <p>! Important: Do not secure the AC adapter cord and USB cable to the cable holder in the following situations.</p> <ul style="list-style-type: none"> <input type="checkbox"/> If the scanner or other objects are placed on top of the cord and cable <input type="checkbox"/> If the cords and cables are twisted, extremely bent, or otherwise placed under stress <input type="checkbox"/> If the cords and cables are tangled
<p>3</p>	<p>USB port</p>	<p>Connects a USB cable for connecting to a computer.</p>
<p>4</p>	<p>DC inlet</p>	<p>Connects the AC adapter.</p>
<p>5</p>	<p>External interface USB port</p>	<p>Connects a USB drive.</p>

Inside

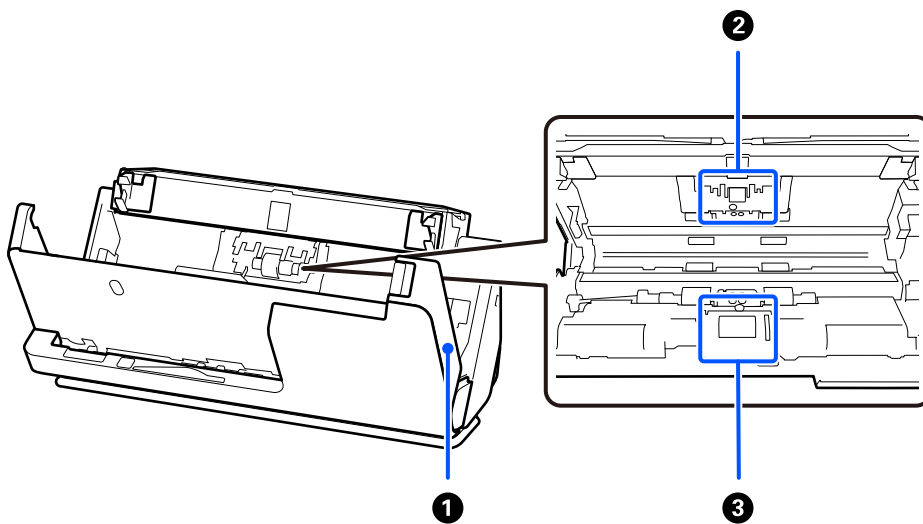

<p>1</p>	<p>Scanner cover</p>	<p>Pull the lever and open the scanner cover when cleaning inside the scanner and removing jammed paper.</p>
<p>2</p>	<p>Separation roller</p>	<p>Feeds originals separately one by one. This needs to be replaced when the number of scans exceeds the service number of papers.</p>
<p>3</p>	<p>Pickup roller</p>	<p>Feeds originals. Roller needs to be replaced when the number of scans exceeds the service number of papers.</p>

Related Information

- ➔ [“Cleaning Inside the Scanner” on page 174](#)
- ➔ [“Replacing the Roller Assembly Kit” on page 182](#)

Inserting and Removing a USB Drive

Inserting a USB Drive

Insert a USB drive into the external interface USB port.

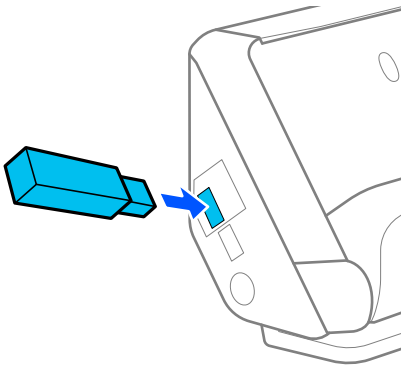

Related Information

➔ [“Scan to USB Drive Feature Work Flow” on page 100](#)

Removing a USB Drive

Remove a USB drive.

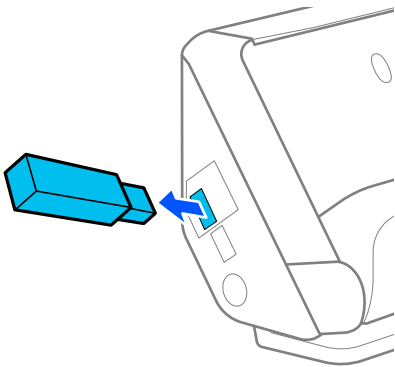

Important:

- If you remove the USB drive device while transferring data to the scanner, the data on the USB drive may be lost.
- While transferring data, a message is displayed on the control panel.

Also, backup the data in external storage device to another media as necessary.

The data may be lost or corrupted in the following situations:

- When affected by static electricity or electrical noise
- When used incorrectly

- When broken or repaired
- When damaged by natural disaster

Position of Scanner

You can change the position of the scanner according to the usage.



Caution:

Be careful not to pinch your fingers or any cables when you change the position of the scanner. Injury or damage may occur.

See the Related Information page for more information on the combinations of scanner positions and originals.

Vertical path position

When scanning multiple sheets of standard-size originals, or when scanning thin paper or receipts, pull the scanner position selector to tilt the scanner forward into the vertical path position. When scanning in the vertical path position, originals loaded in the input tray are ejected to the output tray at the top of the scanner.

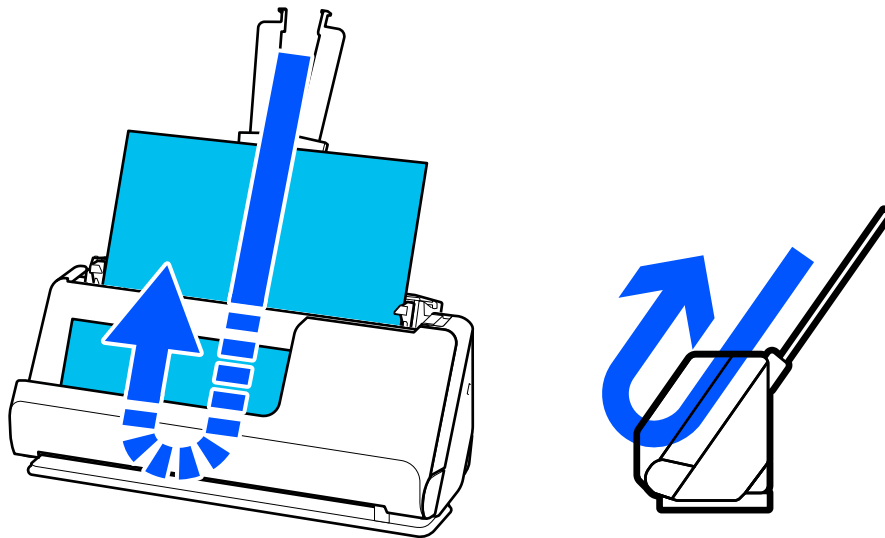

When the vertical path position is changed, the scanner position icon on the control panel changes to  .

Straight path position

When scanning thick originals such as passports, pull the scanner position selector to tilt the scanner backward to the straight path position. When scanning in the straight path position, originals loaded in the input tray are ejected to the output slot at the front of the scanner.

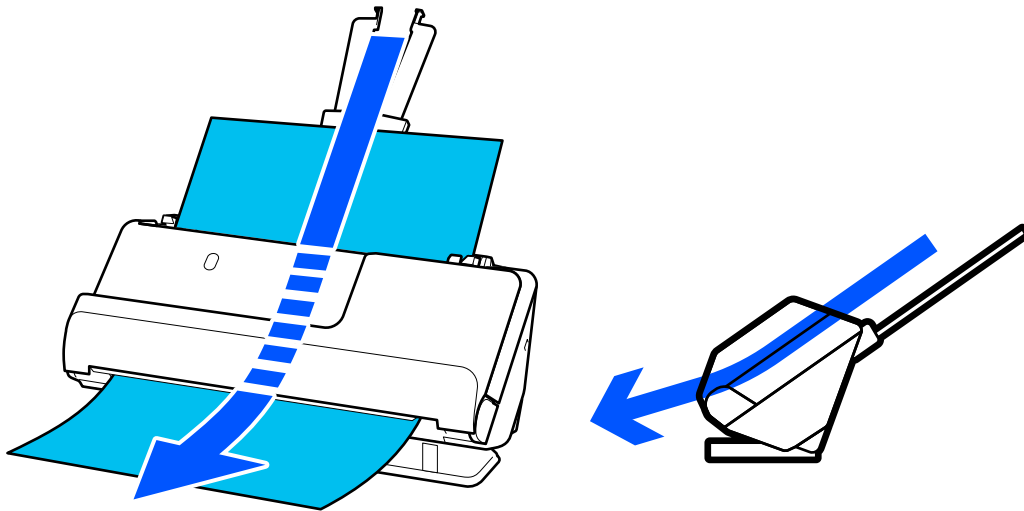

When the straight path position is changed, the scanner position icon on the control panel changes to .

Related Information

➔ [“Combinations of Originals and Scanner Position” on page 53](#)

Control Panel

Buttons and Lights

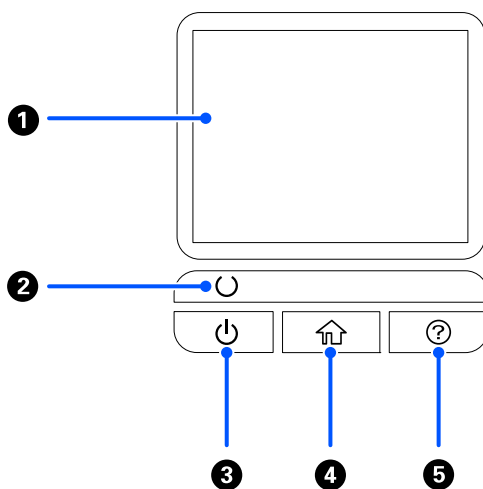

1	-	LCD Screen	Tap the screen to select menus or make settings.
---	---	------------	--

2		Ready light	Indicates the status of the scanner. Do not turn off the scanner while the light is flashing because the scanner is operating or processing a data.
3		Power button	Turns the scanner on or off.
4		Home button	Displays the home screen.
5		Help button	Displays help screen.

Guide to the LCD Screen

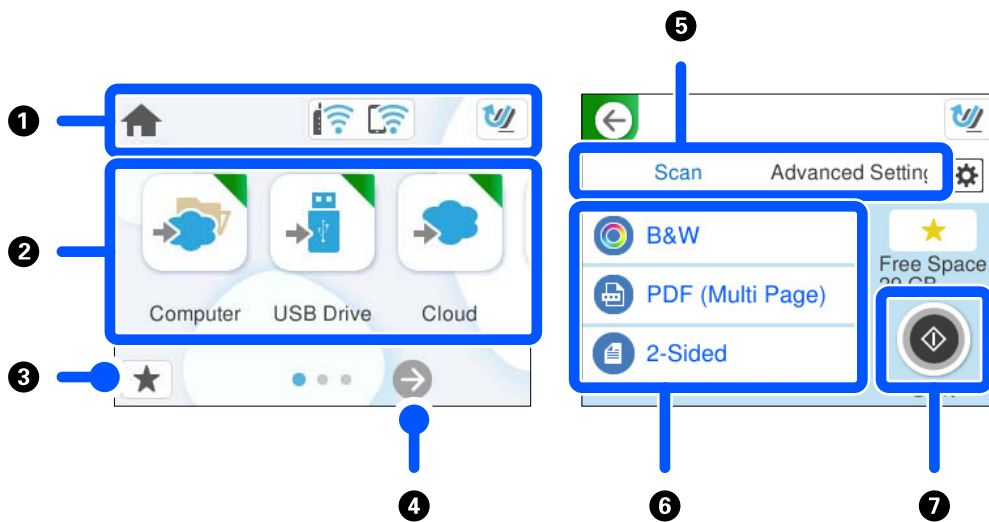























1	Indicates the scanner status as icons. Select the icon to check the current settings or access each setting menu.
2	Displays each menu.
3	Displays a list of your presets. You can load your presets and register new presets.
4	Switch screens.
5	Switch tabs.
6	Displays the list of setting items. Select an item to change the settings. Grayed out items are not available.
7	Starts scanning using current settings.

Icons Displayed on the LCD Screen

The following icons are displayed on depending on the scanner's status.

	This icon indicates that you are on the home screen.
--	--

	<p>This is displayed when a firmware update is available.</p> <p>Select it to update the firmware to improve the scanner's features. We recommend using the scanner with the latest version of the firmware.</p>										
	<p>Displays the network connection status.</p> <p>Select the icon to check and change the current settings. This is the shortcut for the following menu.</p> <p>Settings > Network Settings > Wi-Fi Setup</p> <table border="1" data-bbox="357 506 1437 943"> <tr> <td data-bbox="357 506 427 573">  </td> <td data-bbox="427 506 1437 573"> <p>The scanner is not connected to a wireless (Wi-Fi) network.</p> </td> </tr> <tr> <td data-bbox="357 573 427 663">  </td> <td data-bbox="427 573 1437 663"> <p>The scanner is searching for SSID, unset IP address, or having a problem with a wireless (Wi-Fi) network.</p> </td> </tr> <tr> <td data-bbox="357 663 427 797">  </td> <td data-bbox="427 663 1437 797"> <p>The scanner is connected to a wireless (Wi-Fi) network.</p> <p>The number of bars indicates the signal strength of the connection. The more bars there are, the stronger the connection.</p> </td> </tr> <tr> <td data-bbox="357 797 427 864">  </td> <td data-bbox="427 797 1437 864"> <p>The scanner is not connected to a wireless (Wi-Fi) network in Wi-Fi Direct (Simple AP) mode.</p> </td> </tr> <tr> <td data-bbox="357 864 427 943">  </td> <td data-bbox="427 864 1437 943"> <p>The scanner is connected to a wireless (Wi-Fi) network in Wi-Fi Direct (Simple AP) mode.</p> </td> </tr> </table>		<p>The scanner is not connected to a wireless (Wi-Fi) network.</p>		<p>The scanner is searching for SSID, unset IP address, or having a problem with a wireless (Wi-Fi) network.</p>		<p>The scanner is connected to a wireless (Wi-Fi) network.</p> <p>The number of bars indicates the signal strength of the connection. The more bars there are, the stronger the connection.</p>		<p>The scanner is not connected to a wireless (Wi-Fi) network in Wi-Fi Direct (Simple AP) mode.</p>		<p>The scanner is connected to a wireless (Wi-Fi) network in Wi-Fi Direct (Simple AP) mode.</p>
	<p>The scanner is not connected to a wireless (Wi-Fi) network.</p>										
	<p>The scanner is searching for SSID, unset IP address, or having a problem with a wireless (Wi-Fi) network.</p>										
	<p>The scanner is connected to a wireless (Wi-Fi) network.</p> <p>The number of bars indicates the signal strength of the connection. The more bars there are, the stronger the connection.</p>										
	<p>The scanner is not connected to a wireless (Wi-Fi) network in Wi-Fi Direct (Simple AP) mode.</p>										
	<p>The scanner is connected to a wireless (Wi-Fi) network in Wi-Fi Direct (Simple AP) mode.</p>										
	<p>Indicates that the scanner is in the vertical path position.</p>										
	<p>Indicates that the scanner is in the straight path position.</p>										
	<p>Returns to the previous screen.</p>										
	<p>Indicates that there is additional information. Select the icon to display the message.</p>										
	<p>Indicates a problem with the items. Select the icon to check how to solve the problem.</p> <ul style="list-style-type: none"> <input type="checkbox"/> Roller Replacement: The number of scans exceeds the life cycle of the rollers. Replace the rollers. <input type="checkbox"/> Glass Cleaning: Dirt has been detected on the glass surface inside the scanner. Clean the inside of the scanner. <input type="checkbox"/> Regular Cleaning: It is time to clean inside the scanner. 										

Touch Screen Operations

The touchscreen is compatible with the following operations.

<p>Tap</p>		<p>Press or select the items or the icons.</p>
------------	---	--

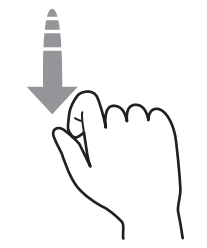
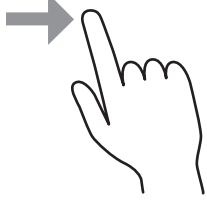
Flick		Scroll the screen swiftly.
Slide		Hold and move the items around.

Entering Characters

You can enter characters and symbols by using on-screen keyboard when you register a contact, make network settings, and so on.

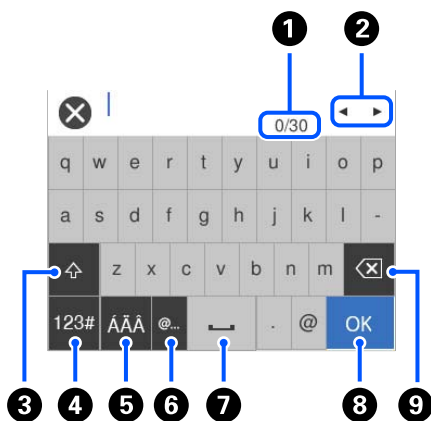

Note:

Available icons vary depending on the setting item.

1	Displays the number of characters.
2	Moves the cursor to the input position.
3	Switches between upper case and lower case or numbers and symbols.
4	Switches the character type. <div style="border: 1px solid black; padding: 2px; display: inline-block;">123#</div> : You can enter numbers and symbols. <div style="border: 1px solid black; padding: 2px; display: inline-block;">ABC</div> : You can enter letters.
5	Switches the character type. You can enter alphanumerics and special characters such as umlauts and accents.
6	Enters frequently used email domain addresses or URLs by simply selecting the item.
7	Enters a space.

8	Fixes the entered characters.
9	Deletes the entered characters.

Viewing Animations

The control panel screen allows you to view animations of how to perform operations such as placing originals and performing maintenance.

- Press the **?** button on the control panel to display the help screen. Select **How To**, and then select the items that you want to view.
- Select **How To** at the bottom of the operation screen: Displays the context-sensitive animation. Note that the animation depends on the scanner model.

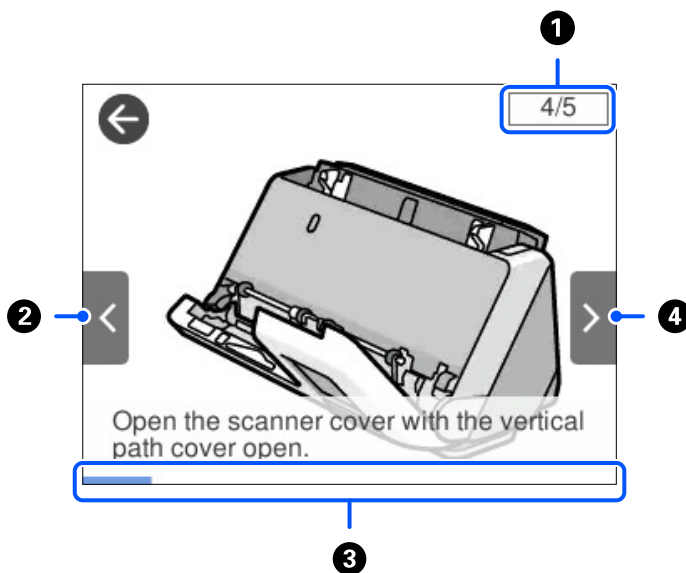

1	Indicates the total number of steps and the current step number. The example shows step 4 of 5.
2	Back to the previous step.
3	Indicates your progress through the current step. The animation repeats when the progress bar reaches the end.
4	Moves to next step.

Registering Presets

You can register frequently used scanning setting as **Presets**. You can register up to 24 presets.

Note:

- You can register the current scan settings by selecting **★** on the start scanning screen.
- You can also register **Presets** in Web Config.
Select the **Scan** tab > **Presets**.

1. Select **Presets** on the home screen on the control panel.

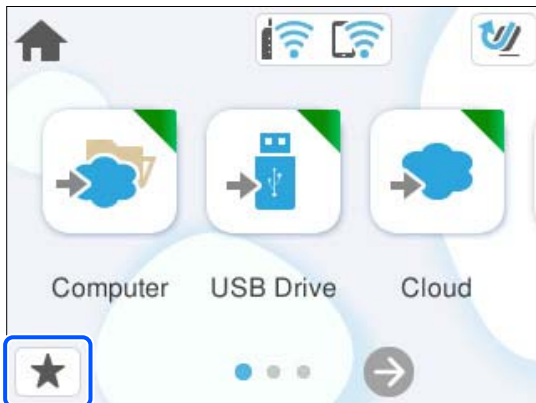

2. Select .

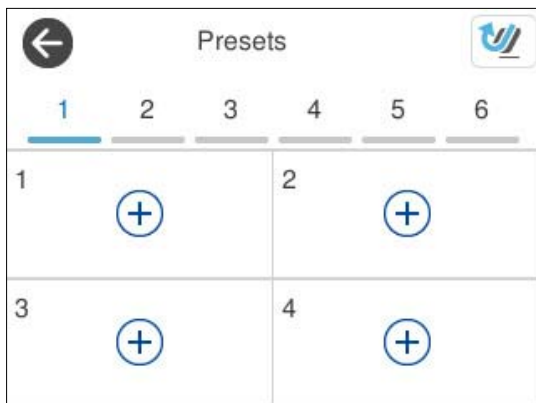

3. Select the menu you want to use to register a preset.



4. Set each item, and then select .
5. Register a preset.
 - Name:** Set the name.
 - Set Icon:** Set the image and color of the icon to display.

- Quick Send Setting:** Immediately starts scanning without confirmation when a preset is selected.
- Contents:** Check scan settings.

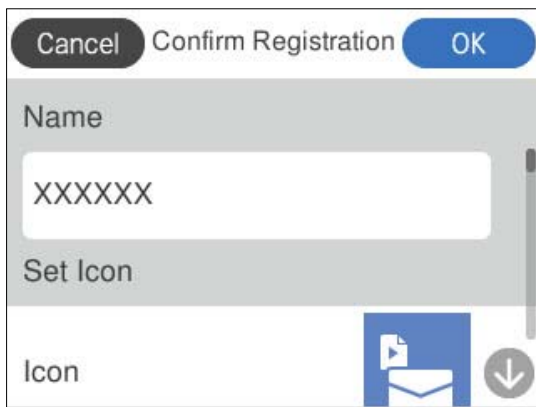

6. Select **OK**.

Descriptions of the Presets Menu

Select **>** for each preset to change the registered contents of the preset, or to display the scan settings.

Change Name:

Changes the preset name.

Change Icon:

Changes the icon image and color of the preset.

Quick Send Setting:

Immediately starts scanning without confirmation when the preset is selected.

Change Position:

Changes the display order of the presets.

Delete:

Deletes the preset.

Confirm Details:

Displays the preset scan settings. You can load the preset by selecting **Use This Setting**.

Information on Applications

This section introduces the application products available for your scanner. The latest application can be installed at the Epson Web site.

Application for Scanning from a Computer (Epson ScanSmart)

This application allows you to scan documents easily, and then save the scanned images in simple steps.

See the Epson ScanSmart help for details on using the features.

Starting on Windows

Windows 11

Click the start button, and then select **All apps > Epson Software > Epson ScanSmart**.

Windows 10

Click the start button, and then select **Epson Software > Epson ScanSmart**.

Windows 8.1/Windows 8

Enter the application name in the search charm, and then select the displayed icon.

Windows 7

Click the start button, and then select **All Programs > Epson Software > Epson ScanSmart**.

Starting on Mac OS

Select **Go > Applications > Epson Software > Epson ScanSmart**.

Application for Scanning from Smart Devices (Epson Smart Panel)

Epson Smart Panel is an application that allows you to scan documents using smart devices such as smart phones and tablet devices. You can save the scanned data in smart devices or cloud services, and send by e-mail.

Even if you do not have a wireless router, you can automatically connect Wi-Fi enabled smart devices to the scanner by using Wi-Fi Direct.

You can download and install Epson Smart Panel from the App Store or Google Play.

Application for Updating Software and Firmware (EPSON Software Updater)

EPSON Software Updater is an application that installs new software, and updates firmware and manuals over the Internet. If you want to check for update information regularly, you can set the interval for checking for updates in EPSON Software Updater's auto update settings.

Starting on Windows

Windows 11

Click the start button, and then select **All apps > Epson Software > EPSON Software Updater**.

Windows 10

Click the start button, and then select **Epson Software > EPSON Software Updater**.

Windows 8.1/Windows 8

Enter the application name in the search charm, and then select the displayed icon.

Windows 7

Click the start button, and then select **All Programs > Epson Software > EPSON Software Updater**.

Starting on Mac OS

Select **Go > Applications > Epson Software > EPSON Software Updater**.

Application for Configuring Scanner Operations (Web Config)

Web Config is an application that runs in web browsers, such as Microsoft Edge and Safari, on a computer or a smart device. You can confirm the scanner status or change the network service and scanner settings. To use Web Config, connect the scanner and the computer or device to the same network.

The following browsers are supported. Use the latest version.

Microsoft Edge, Windows Internet Explorer, Firefox, Chrome, Safari

Note:

You may be prompted to enter the administrator password while using this device. See the following for details on the administrator password.

[“Notes on the Administrator Password” on page 13](#)

Related Information

➔ [“Cannot Access Web Config” on page 198](#)

How to Run Web Config in a Web Browser

The scanner comes with built-in software called Web Config (a Web page where you can make settings). To access Web Config, simply enter the IP address of a network-connected scanner in your Web browser.

1. Check the scanner's IP address.

Select **Settings > Network Settings > Network Status** on the scanner's control panel, and then select the active connection method (**Wi-Fi Status** or **Wi-Fi Direct Status**) to confirm the scanner's IP address.

Example IP address: 192.168.100.201

2. Launch a Web browser from a computer or a smart device, and then enter the scanner's IP address in the address bar.

Format: `http://scanner's IP address/`

Example: `http://192.168.100.201/`

If a warning screen is displayed in your browser, you can safely ignore the warning and display the Web page (Web Config). Since the scanner uses a self-signed certificate when accessing HTTPS, a warning is displayed on the browser when you start Web Config; this does not indicate a problem and can be safely ignored.

Depending on your browser, you may need to click on **Advanced Settings** to view the Web page.

Example: For Microsoft Edge

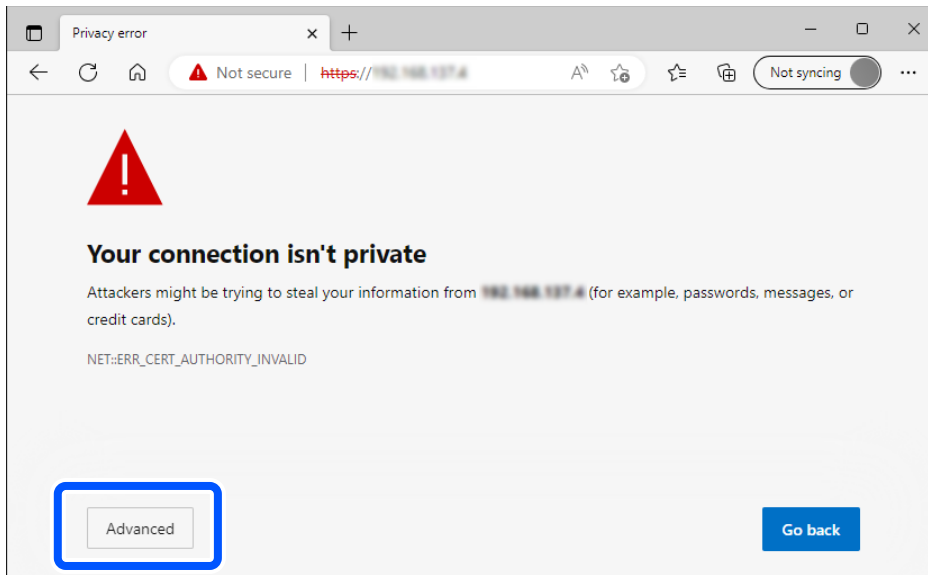

Note:

- If a warning screen is not displayed, go to the next step.
- For IPv6 addresses, use the following format.
 Format: *http://[scanner's IP address]/*
 Example: *http://[2001:db8::1000:1]/*

3. To change scanner settings, you need to log in as a Web Config administrator.

Click **Log in** at the top-right of the screen. Enter the **User Name** and **Current password**, and then click **OK**.

The following provides the initial values for the Web Config administrator information.

- User name: none (blank)
- Password: Depends on the label attached to product.

If there is a "PASSWORD" label attached to the back, enter the 8-digit number shown on the label. If there is no "PASSWORD" label attached, enter the serial number on the label attached to the base of the product for the initial administrator password.

Note:

If **Log out** is displayed at the top-right of the screen, you are already logged in as an administrator.

Related Information

- ➔ “Registering a Destination (Email)” on page 150
- ➔ “Registering a Destination (Network Folder (SMB))” on page 151
- ➔ “Registering a Destination (FTP)” on page 152
- ➔ “Registering a Destination (SharePoint(WebDAV))” on page 153

How to Run Web Config on Windows

When connecting a computer to the scanner using WSD, follow the steps below to run Web Config.

1. Open the scanner list on the computer.

Windows 11

Click the start button, and then select **Bluetooth & devices > Printers & scanners**.

Windows 10

Click on the start button, and then select **Windows System > Control Panel > View devices and printers** in **Hardware and Sound**.

Windows 8.1/Windows 8

Select **Desktop > Settings > Control Panel > View devices and printers** in **Hardware and Sound** (or **Hardware**).

Windows 7

Click the start button, and select **Control Panel > View devices and printers** in **Hardware and Sound**.

2. Right-click on your scanner and select **Properties**.

3. Select the **Web Service** tab and click the URL.

Since the scanner uses a self-signed certificate when accessing HTTPS, a warning is displayed on the browser when you start Web Config; this does not indicate a problem and can be safely ignored.

Note:

The following provides the initial values for the Web Config administrator information.

·User name: none (blank)

·Password: Depends on the label attached to product.

If there is a "PASSWORD" label attached to the back, enter the 8-digit number shown on the label. If there is no "PASSWORD" label attached, enter the serial number on the label attached to the base of the product for the initial administrator password.

*If **Log out** is displayed at the top-right of the screen, you have already logged-on as an administrator.*

Application for Setting up the Device on a Network (EpsonNet Config)

EpsonNet Config is an application that allows you to set network interface addresses and protocols. See the operations guide for EpsonNet Config or the application's help for more details.

Starting on Windows

Windows 11

Click the start button, and then select **All apps > EpsonNet > EpsonNet Config**.

Windows 10

Click the start button, and then select **EpsonNet > EpsonNet Config**.

Windows 8.1/Windows 8

Enter the application name in the search charm, and then select the displayed icon.

Windows 7/Windows Vista

Click the start button, and select **All Programs** or **Programs > EpsonNet > EpsonNet Config SE > EpsonNet Config**.

Starting on Mac OS

Go > Applications > Epson Software > EpsonNet > EpsonNet Config SE > EpsonNet Config.

Software for Managing Devices on the Network (Epson Device Admin)

Epson Device Admin is a multifunctional application software that manages the device on the network.

The following functions are available.

- Monitor or manage up to 2,000 printers or scanners over the segment
- Make a detailed report, such as for the consumable or product status
- Update the firmware of the product
- Introduce the device to the network
- Apply the unified settings to multiple devices.

You can download Epson Device Admin from Epson support website. For more information, see the documentation or help of Epson Device Admin.

Application for Creating Driver Packages (EpsonNet SetupManager)

EpsonNet SetupManager is a software to create a package for a simple scanner installation, such as installing the scanner driver and so on. This software allows the administrator to create unique software packages and distribute them among groups.

For more information, visit your regional Epson website.

<http://www.epson.com>

Application for Scanning Business Cards (Presto! BizCard)

Presto! BizCard by NewSoft provides a full range of contact management functions for adding business cards without having to type. Use the BizCard recognition system to scan business cards, edit, and synchronize the information to the most frequently used personal database management software. You can easily save and manage your contact information.

See the software's help for more information on using the software and its functions.

Starting on Windows

- Windows 11

Click the start button, and then select **All apps > NewSoft > Presto! BizCard**.

- Windows 10

Click the start button, and then select **NewSoft > Presto! BizCard**.

- Windows 8.1/Windows 8

Enter the application name in the search charm, and then select the displayed icon.

- Windows 7

Click the start button, and then select **All Programs > NewSoft > Presto! BizCard**.

Starting on Mac OS

Select **Go > Applications > Presto! BizCard**.

Option Items and Consumables Information

Carrier Sheet Codes

Using a Carrier Sheet allows you to scan irregular shaped originals or photos that can easily be scratched. You can only load one Carrier Sheet in the straight path position.

You can scan passports as is, but if you want to protect the passport while scanning, use a passport carrier sheet.

Part Name	Codes *1	Number of Times Carrier Sheet Can be Used
Carrier Sheet	B12B819051	3,000*2
Passport Carrier Sheet	B12B819651 B12B819661 (for India)	3,000*2

*1 You cannot use any Carrier Sheet or Passport Carrier Sheet except for the codes specified.

*2 This number is a guide to the replacement cycle. Do not use a Carrier Sheet or Passport Carrier Sheet that is scratched.

Note:

*You can only use the Carrier Sheet/Passport Carrier Sheet when scanning from a computer, or when scanning from the scanner's control panel using the **Computer** feature.*

You cannot use a Carrier Sheet/Passport Carrier Sheet when scanning from the scanner's control panel using the following features:

- Network Folder/FTP
- Email
- Cloud
- USB Drive

Related Information

- ➔ [“General Specifications for Originals Being Scanned” on page 43](#)
- ➔ [“Placing Large Size Originals” on page 60](#)
- ➔ [“Placing a Booklet” on page 74](#)
- ➔ [“Placing a Passport” on page 77](#)
- ➔ [“Placing Irregular Shaped Originals” on page 90](#)

Roller Assembly Kit Codes

Parts (the pickup roller and separation roller) should be replaced when the number of scans exceeds the service number. You can check the latest number of scans on the control panel or in the Epson Scan 2 Utility.

A



B

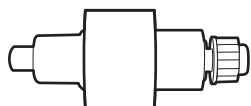

A: Pickup Roller, B: Separation roller

Part Name	Model Number	Life cycle
Roller Assembly Kit	B12B819731 B12B819741 (India only)	50,000*

* This number was reached by consecutively scanning using Epson test original papers, and is a guide to the replacement cycle. The replacement cycle may vary depending on different paper types, such as paper that generates a lot of paper dust or paper with a rough surface that may shorten the life cycle. The replacement timing also depends on the scanning and cleaning frequency.

Related Information

- ➔ [“Replacing the Roller Assembly Kit” on page 182](#)
- ➔ [“Resetting the Number of Scans After Replacing the Rollers” on page 190](#)

Cleaning Kit Codes

Use this when cleaning inside the scanner. This kit is composed of cleaning liquid and a cleaning cloth.

Part name	Codes
Cleaning Kit	B12B819291

Related Information

- ➔ [“Cleaning Inside the Scanner” on page 174](#)

Placing Originals

Specifications for Originals that can be Scanned.	43
Types of Originals that Require Attention.	52
Types of Originals that Must Not be Scanned.	52
Placing Originals in the Scanner.	53

Specifications for Originals that can be Scanned

This section explains the specifications and conditions of originals that can be loaded in the ADF.

General Specifications for Originals Being Scanned

Type of Original	Thickness	Size
Fine paper	When scanning in the vertical path position: 40 to 127 g/m ²	Max: 215.9×5,588 mm (8.5×220.0 in.) Min: 50.8×50.8 mm (2.0×2.0 in.)
Plain paper		
Recycled paper	When scanning in the straight path position: 40 to 413 g/m ²	The loadable size varies depending on the type of the originals, the scanning resolution, and the scanning method.
Post cards	When scanning A6 size or smaller originals: 40 to 209 g/m ²	
Business cards		
Envelopes		
Plastic cards complying with ISO7810 ID-1 type (with or without emboss)		
Laminated cards		
Thermal paper		

Note:

- ❑ All originals must be flat at the leading edge.
- ❑ Make sure that curls on the leading edge of the originals are kept within the following range.
 - ① must be 5 mm or less.
 - ② must be 3 mm or less.
 - ③ must be greater than or equal to ② if ② is less than 1 mm. When ② is greater than 1 mm, it should be at least 10 times the size of ②.

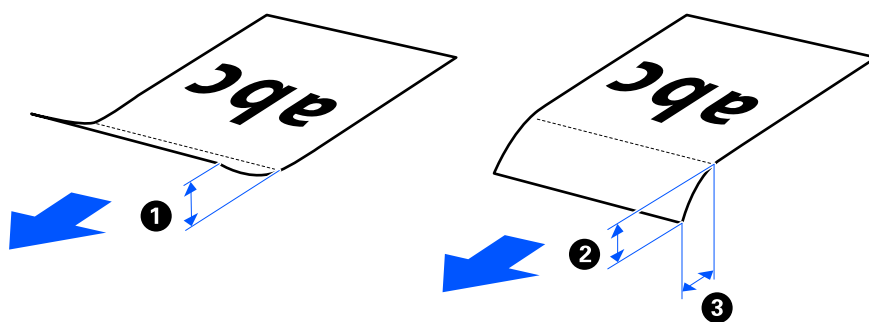

- ❑ Even when the original meets the specifications for originals that can be placed in the ADF, it may not feed from the ADF depending on the paper properties or quality. Additionally, some originals may decrease the scan quality.

Scannable Standard Size Originals

These are the specifications for standard size originals that you can scan.

Specifications	Size	Thickness	Paper type	Loading Capacity and Thickness
Legal	215.9×355.6 mm (8.5×14 in.)	<input type="checkbox"/> For the vertical path position 40 to 127 g/m ² <input type="checkbox"/> For the Straight Path Position 40 to 413 g/m ²	Plain paper Fine paper Recycled paper	<input type="checkbox"/> For the vertical path position Thickness of the stack of originals: under 2.4 mm (0.09 in.) 40 g/m ² : 20 sheets* 80 g/m ² : 20 sheets 90 g/m ² : 18 sheets 104 g/m ² : 15 sheets 127 g/m ² : 12 sheets <input type="checkbox"/> For the Straight Path Position 1 sheet The loading capacity varies depending on the paper type.
Letter	215.9×279.4 mm (8.5×11 in.)			
A4	210×297 mm (8.3×11.7 in.)			
B5	182×257 mm (7.2×10.1 in.)			
A5	148×210 mm (5.8×8.3 in.)			
B6	128×182 mm (5.0×7.2 in.)			
A6	105×148 mm (4.1×5.8 in.)			
A8	52×74 mm (2.1×2.9 in.)	<input type="checkbox"/> For the Straight Path Position 40 to 413 g/m ²		
Business cards	55×89 mm (2.1×3.4 in.)	210 g/m ²	<input type="checkbox"/> For the vertical path position Thickness of the stack of originals: under 2.4 mm (0.09 in.) 5 sheets <input type="checkbox"/> For the straight path position 1 sheet	

* When scanning thin paper originals, we recommend extending the paper output support in both places.

When Scanning Standard Size Originals (Check the Position of the Scanner)

When scanning standard size, plain paper originals, scan in the vertical path position.

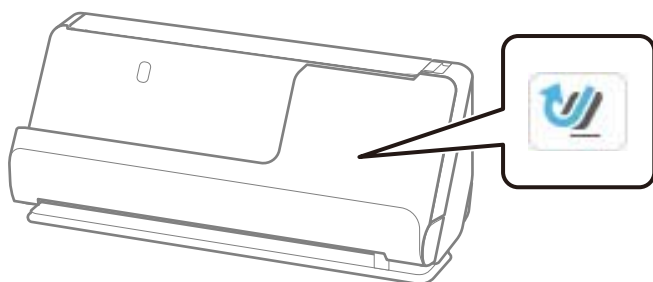

- ❑ When scanning award certificates and other thick originals (originals with a thickness 127 g/m² or more), scan in the straight path position and load only one original at a time.

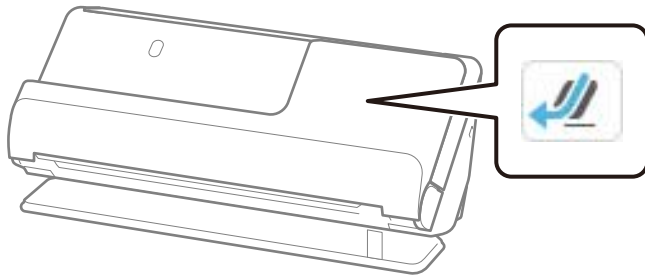

Related Information

- ➔ [“Placing Standard Size Originals” on page 55](#)
- ➔ [“Placing Large Size Originals” on page 60](#)

Scannable Large Originals

These are the specifications for large originals that you can scan.

Specifications	Size	Thickness	Paper type	Loading Capacity
A3	297×420 mm (11.7×16.5 in.)	40 to 206 g/m ²	Plain paper	1 card
B4	257×364 mm (10.1×14.3 in.)		Fine paper Recycled paper	

When Scanning Large Originals (Check the Position of the Scanner)

When scanning large originals, scan in the straight path position.

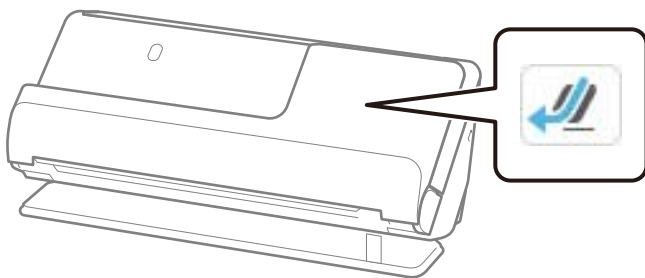

Related Information

- ➔ [“Placing Large Size Originals” on page 60](#)

Scannable Long Paper

These are the specifications for long paper that you can scan.

Note:

- When scanning long paper, scanning speed is reduced.
- You cannot scan long paper from the control panel.
- You cannot scan long paper using Epson Smart Panel.

Size	Thickness	Paper type	Loading Capacity
Maximum width: 215.9 mm (8.5 in.) Original length: 393.7 to 5,588 mm (15.5 to 220 in.)	50 to 130 g/m ²	Plain paper Fine paper Recycled paper	1 sheet

When Scanning Long Paper (Check the Position of the Scanner)

When scanning long paper, scan in the straight path position.

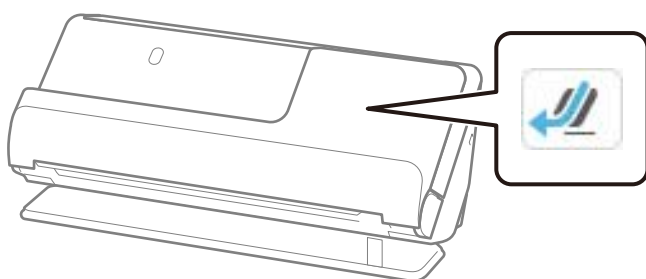

Related Information

➔ [“Placing Long Paper” on page 63](#)

Maximum Length for Long Paper

The following shows the maximum length according to the scanning resolution and the scanning method.

Scanning Method	Scanning Resolution	Maximum Length
<input type="checkbox"/> Scanning from a computer <input type="checkbox"/> Scanning from the scanner's control panel using the Computer feature	50 to 200 dpi	5,588.0 mm (220.0 in.)
	201 to 300 dpi	5,461.0 mm (215.0 in.)
	301 to 600 dpi	1,346.0 mm (53.0 in.)
Scanning from the scanner's control panel using the following features: <input type="checkbox"/> Network Folder/FTP <input type="checkbox"/> Email <input type="checkbox"/> Cloud <input type="checkbox"/> USB Drive	50 to 300 dpi	914.4 mm (36.0 in.)
	301 to 600 dpi	393.8 mm (15.5 in.)
Scanning from the scanner's control panel using the WSD feature	100 dpi 300 dpi	Long paper is not supported

Scanning Method	Scanning Resolution	Maximum Length
Scan with Epson Smart Panel	200 dpi 300 dpi 600 dpi	Long paper is not supported

Scannable Receipts

These are the specifications for receipts that you can scan.

Size	Thickness	Loading Capacity and Thickness
Width: 50.8 to 215.9 mm (2.0 to 8.5 in.) Length: 50.8 to 5,588 mm (2.0 to 220.0 in.)* ¹	53 to 77 g/m ²	<input type="checkbox"/> For the vertical path position Thickness of the stack of originals: under 2.4 mm (0.09 in.) 20 sheets * ² <input type="checkbox"/> For the straight path position 1 sheet

*1 Switch the scanner position according to the length of the receipt to be scanned.

*2 When scanning receipts in the vertical path position, we recommend extending the paper output support in both places.

When Scanning Receipts (Check the Position of the Scanner)

- When scanning receipts that are shorter than 393.7 mm (15.5 inches), scan in the vertical path position.

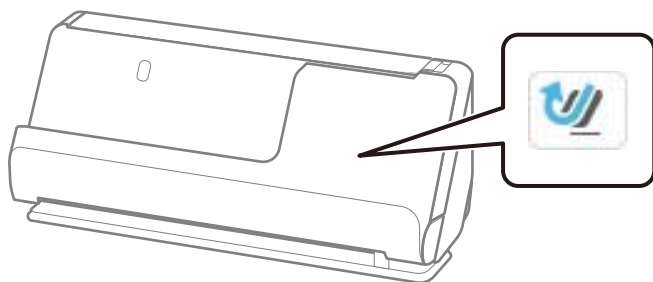

- When scanning receipts that are longer than 393.7 mm (15.5 inches), place the scanner in the straight path position and load only one original at a time.

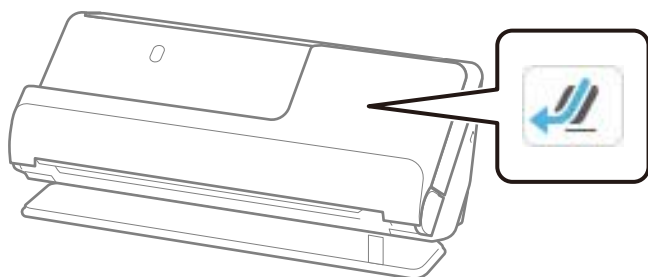

Related Information

➔ [“Placing Standard Size Originals” on page 55](#)

➔ [“Placing Long Paper” on page 63](#)

Scannable Plastic Cards

These are the specifications for plastic cards that you can scan.

Size	Embossing	Thickness	Loading Capacity	Loading Direction
ISO7810 ID-1 Type 54.0×85.6 mm (2.1×3.3 in.)	With embossing	1.24 mm (0.05 in.) or less	1 card	Horizontal (landscape)
	Without embossing	0.76 mm (0.03 in.) to 1.1 mm (0.04 in.)	1 card	
		Less than 0.76 mm (0.03 in.)	1 card	

When Scanning Plastic Cards (Check the Position of the Scanner)

When scanning plastic cards, scan in the straight path position.

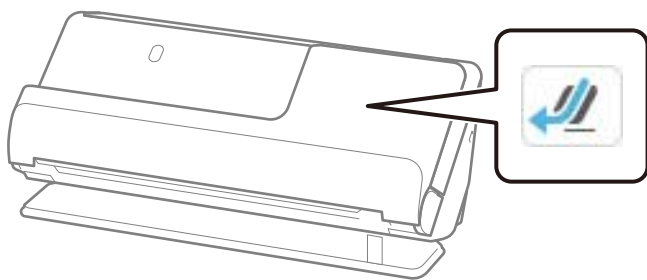

Related Information

➔ [“Placing Plastic Cards” on page 67](#)

Scannable Laminated Cards

These are the specifications for laminated cards that you can scan.

Size	Thickness	Loading Capacity
120.0×150.0 mm (4.7×5.9 in.) or less	0.8 mm (0.03 in.) or less	1 sheet

Note:

You cannot scan laminated cards using Epson Smart Panel.

When Scanning Laminated Cards (Check the Position of the Scanner)

When scanning laminated cards, scan in the straight path position.

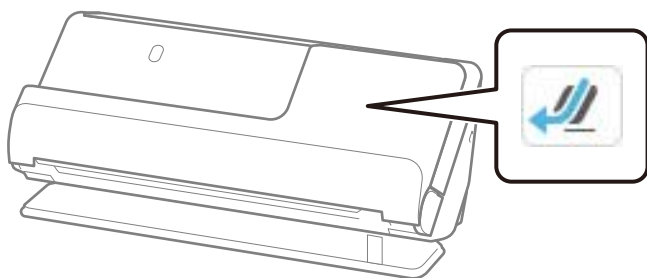

Scannable Booklets

Size	Thickness	Type	Loading Capacity
Max. size: A5 size (A4 in a two-page spread)	5 mm (0.20 in.) or less (The total thickness of the closed booklet)	Passbooks or similar documents	1 booklet

Note:

You cannot scan booklets using Epson Smart Panel.

When Scanning Booklets (Check the Position of the Scanner)

When scanning booklets, scan in the straight path position.

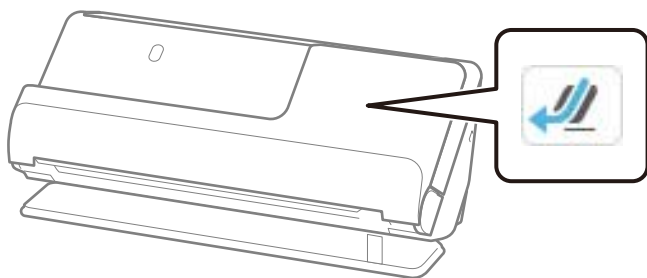

Related Information

➔ [“Placing a Booklet” on page 74](#)

Passports

Thickness	Loading Capacity
5 mm (0.20 in.) or less	1 passport

You can only load one passport at a time, even when scanning with the optional Passport Carrier Sheet.

When Scanning Passports (Check the Position of the Scanner)

When scanning passports, scan in the straight path position.

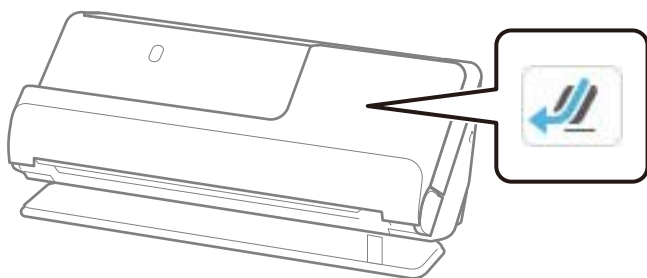

Related Information

➔ [“Placing a Passport” on page 77](#)

Specifications for Originals Using the Carrier Sheet

The optional Carrier Sheet is a sheet designed to transport originals through the scanner. You can scan originals that are larger than A4/Letter size, important documents or photos which must not be damaged, thin paper, irregular shaped originals, and so on.

The following provides a list of originals that can be scanned using the Carrier Sheet.

Type of Original	Size	Thickness	Loading Capacity of the Carrier Sheet
Originals that cannot be loaded directly into the scanner	A3* ¹ A4 B4* ¹ Letter Legal* ¹ B5 A5 B6 A6 A8 Custom size: <input type="checkbox"/> Width: up to 431.8 mm (17 in.) * ² <input type="checkbox"/> Length: up to 297 mm (11.7 in.) * ³	0.3 mm (0.01 in.) or less (Excluding the thickness of the Carrier Sheet)	1 sheet

*1 Fold in half to place.

*2 Originals that are wider than 215.9 mm (8.5 in.) need to be folded in half.

- *3 The leading edge of the original must be placed at the binding part of the Carrier Sheet when scanning an original approximately 297 mm (11.7 in.) long. Otherwise, the length of the scanned image may be longer than intended as the scanner scans to the end of the Carrier Sheet when you select **Auto Detect** as the **Document Size** setting in the application.

When Scanning Using a Carrier Sheet (Check the Position of the Scanner)

When scanning using a Carrier Sheet, scan in the straight path position.

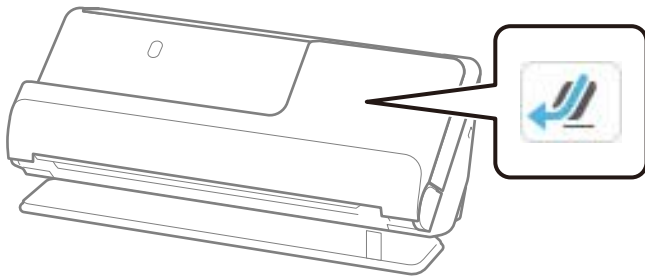

Related Information

- ➔ [“Carrier Sheet Codes” on page 40](#)
- ➔ [“Placing Irregular Shaped Originals” on page 90](#)

Scannable Envelopes

These are the specifications for envelopes that you can scan.

Specifications	Size	Thickness	Loading Capacity
C6	114×162 mm (4.49×6.38 in.) (standard size)	0.38 mm (0.015 in.) or less	1 envelope
DL	110×220 mm (4.33 x 8.66 in.) (standard size)		

When Scanning Envelopes (Check the Position of the Scanner)

When scanning envelopes, scan in the straight path position.

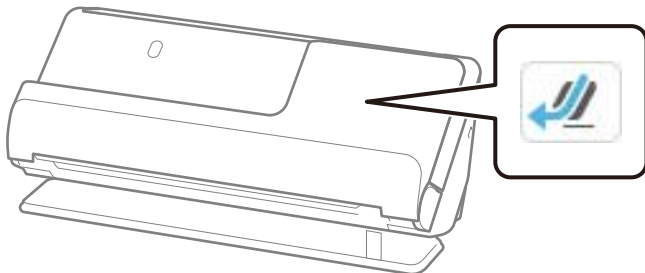

Related Information

- ➔ [“Placing an Envelope” on page 86](#)

Types of Originals that Require Attention

The following types of originals may not be successfully scanned.

- Originals with specially treated surfaces such as glossy paper, thermal paper, or coated paper.
- Originals with a large uneven surface such as letter head paper.
- Originals that have just been printed
- Originals with fold lines
- Perforated originals
- Original with labels or stickers
- Carbon paper and carbon-less paper
- Curled originals
- Originals with wrinkles or tears

 **Important:**

Carbon-less paper contains chemical substances that may damage the rollers inside the scanner. If you scan carbon-less paper, clean the pickup roller and the separation roller regularly. Also, scanning carbon-less paper may shorten the life cycle of the rollers faster than scanning plain paper.

Note:

- Wrinkled originals may scan better if you smooth out the wrinkles before scanning.*
- To scan delicate originals or originals that are easily wrinkled, use a Carrier Sheet (sold separately).*
- To scan originals that are incorrectly detected as double feeds, set the **Detect Double Feed** (Double Feed Detection Skip Function) to **Off** on the control panel before you resume scanning, or select **Off** in **Detect Double Feed** on the **Main Settings** tab in the Epson Scan 2 window.*
*When you are using Epson ScanSmart, you can open the Epson Scan 2 screen by clicking the **Settings** button > **Scanner Settings** tab > **Scan Settings**.*
- Labels or stickers must be firmly stuck to the originals with no glue protruding. When scanning an original with labels or stickers that look like they might come off easily, use a carrier sheet and scan the original with the scanner in the straight path position.*
- Try to flatten the curled originals before scanning.*
- For originals with folds, flatten the original so that the height of the fold is 5 mm (0.2 inches) or less before loading it.*
[“Placing Standard Size Originals” on page 55](#)

Related Information

- ➔ [“Scanner Basics” on page 22](#)
- ➔ [“Placing Important Originals or Photos” on page 82](#)
- ➔ [“Placing Irregular Shaped Originals” on page 90](#)
- ➔ [“Maintenance” on page 173](#)

Types of Originals that Must Not be Scanned

The following types of originals must not be scanned.

- Photos
- Booklets
- Passports that are thicker than 5 mm due to visas or supplementary visa pages being stuck inside the passport.
- Non-paper originals (such as clear files, fabric, and metal foil)
- Originals with staples or paper clips
- Originals with glue attached
- Ripped originals
- Heavily wrinkled or curled originals
- Transparent originals such as OHP film
- Originals with carbon paper on the back
- Originals with wet ink
- Originals with sticky notes attached

Note:

- Do not feed valuable photos, artwork, or important documents, which you do not want to damage or deface, into the scanner directly. Misfeeding may wrinkle or damage the original. When scanning such originals, make sure you use a Carrier Sheet (sold separately).*
- Ripped, wrinkled, or curled originals can also be scanned if you use a Carrier Sheet (sold separately).*
- For thick passports and passports with a slightly expanded binding edge, scan using the Passport Carrier Sheet (sold separately).*

Related Information

- ➔ [“Placing Important Originals or Photos” on page 82](#)
- ➔ [“Placing Irregular Shaped Originals” on page 90](#)

Placing Originals in the Scanner

Combinations of Originals and Scanner Position

This product uses two different positions for scanning, depending on the original being scanned.

This section explains the combinations of scanner positions and originals. For details on how to change the position, see the Related Information pages or the procedures for placing various types of originals.

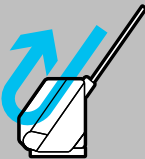
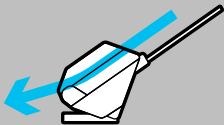
	Vertical path position	Straight path position
		
Explanations	<p>When scanning multiple sheets of standard-size originals, or when scanning thin paper or receipts, place the scanner in the vertical path position.</p> <p>Scanned originals are ejected to the output tray at the top of the scanner.</p>	<p>When scanning thick or long originals, passports, cards, and so on, place the scanner in the straight path position.</p> <p>Scanned originals are ejected to the output slot at the front of the scanner.</p>
Supported originals	<ul style="list-style-type: none"> <input type="checkbox"/> Standard size originals (up to A4) <input type="checkbox"/> Thin paper (40 g/m²) <input type="checkbox"/> Post cards <input type="checkbox"/> Receipts less than 393.7 mm (15.5 in.) in length <input type="checkbox"/> Business cards "Placing Standard Size Originals" on page 55 <input type="checkbox"/> Mixture of originals "Loading Batches of Originals with Different Paper Types and Sizes" on page 93 	<ul style="list-style-type: none"> <input type="checkbox"/> Large size originals "Placing Large Size Originals" on page 60 <input type="checkbox"/> Long paper <input type="checkbox"/> Receipts over 393.7 mm (15.5 in.) in length "Placing Long Paper" on page 63 <input type="checkbox"/> Plastic cards "Placing Plastic Cards" on page 67 <input type="checkbox"/> Laminated cards "Placing Laminated Cards" on page 71 <input type="checkbox"/> Booklets "Placing a Booklet" on page 74 <input type="checkbox"/> Passports "Placing a Passport" on page 77 <input type="checkbox"/> Photos (using a carrier sheet) <input type="checkbox"/> Important or essential originals (using a carrier sheet) "Placing Important Originals or Photos" on page 82 <input type="checkbox"/> Envelopes "Placing an Envelope" on page 86 <input type="checkbox"/> Irregular size originals (using a carrier sheet) "Placing Irregular Shaped Originals" on page 90

Related Information

➔ ["Position of Scanner" on page 27](#)

Placing Standard Size Originals

1. Make sure that the scanner position icon is  (vertical path position).

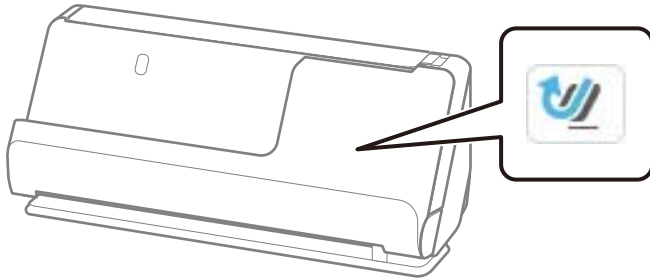

- If  (straight path position) is displayed, pull the scanner position selector to tilt the scanner forward.

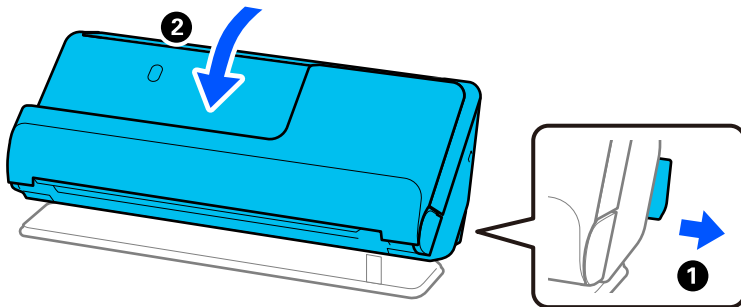

2. Open the input tray.

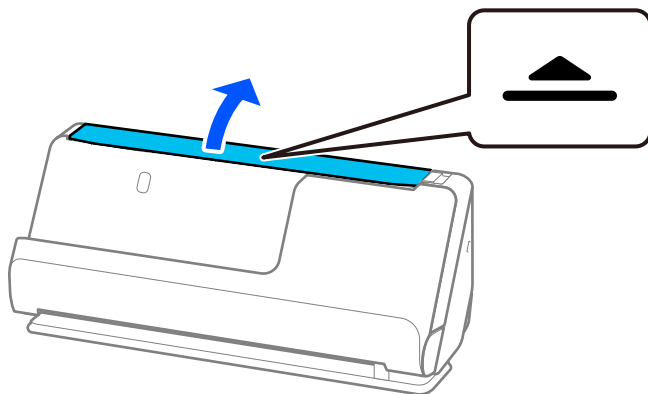

3. Raise the input tray extension.

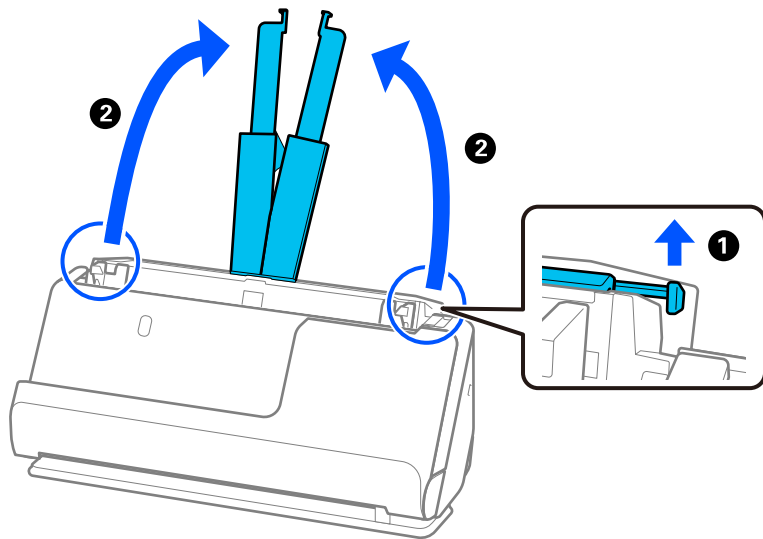

4. Move the edge guides to the edges of the input tray.

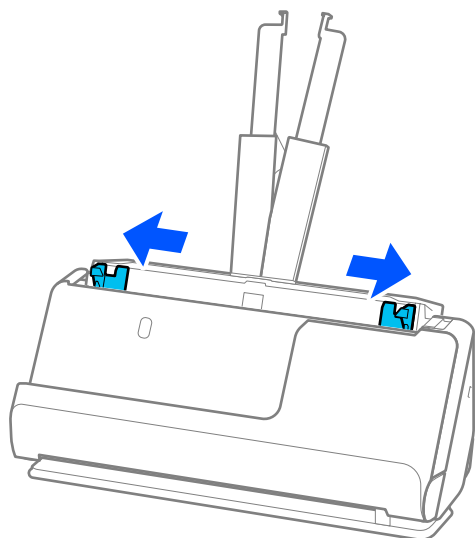

5. Fan the originals.
Hold both ends of the originals and fan them a few times.

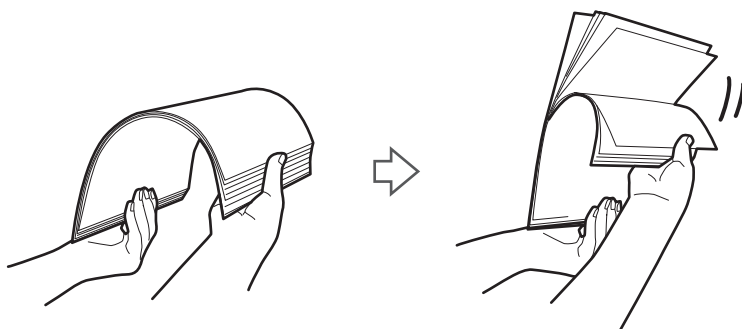

- Align the edges of the originals, and with the side to be scanned facing up, slide the leading edges into a wedge shape.

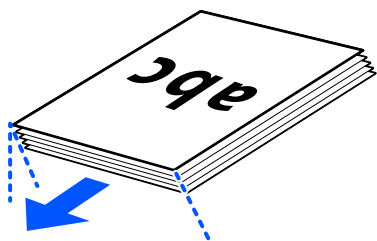

- Place the originals into the ADF input tray facing up and with the top edge facing into the ADF. Insert the paper into the ADF until it meets resistance.

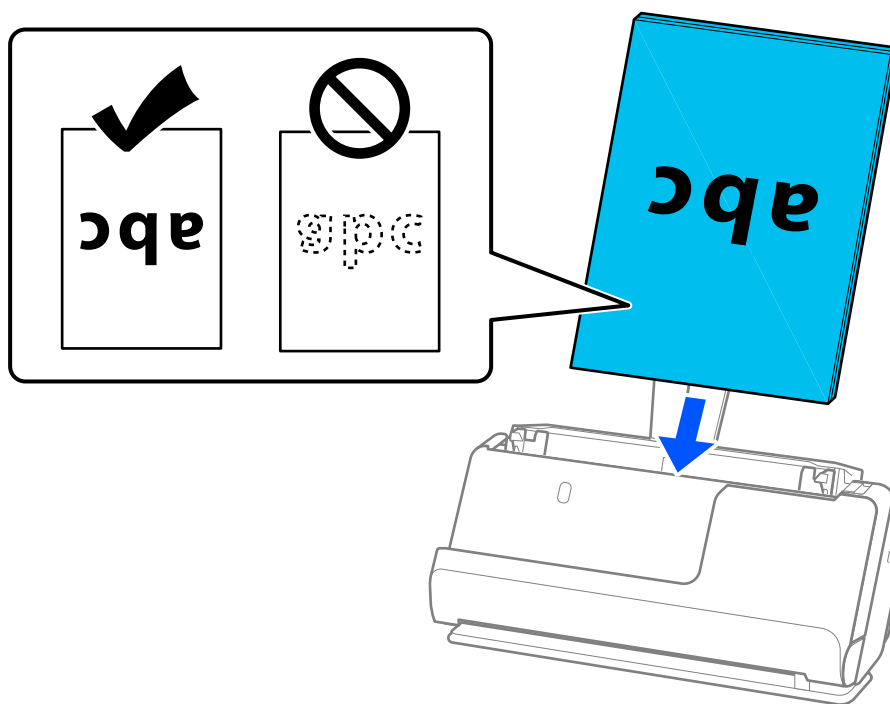

- ❑ When scanning originals with punch holes, such as loose leaf paper, load the originals with the holes facing to the left, right, or facing down. Place the originals so that there are no holes within a range of 15 mm (0.6 inches) to the left and right (30 mm (1.2 inches) in total) from the center of the originals. However, there can be holes within 30 mm (1.2 inches) from the leading edge of the originals. Make sure that the edges of the punch holes do not have burrs or curls.

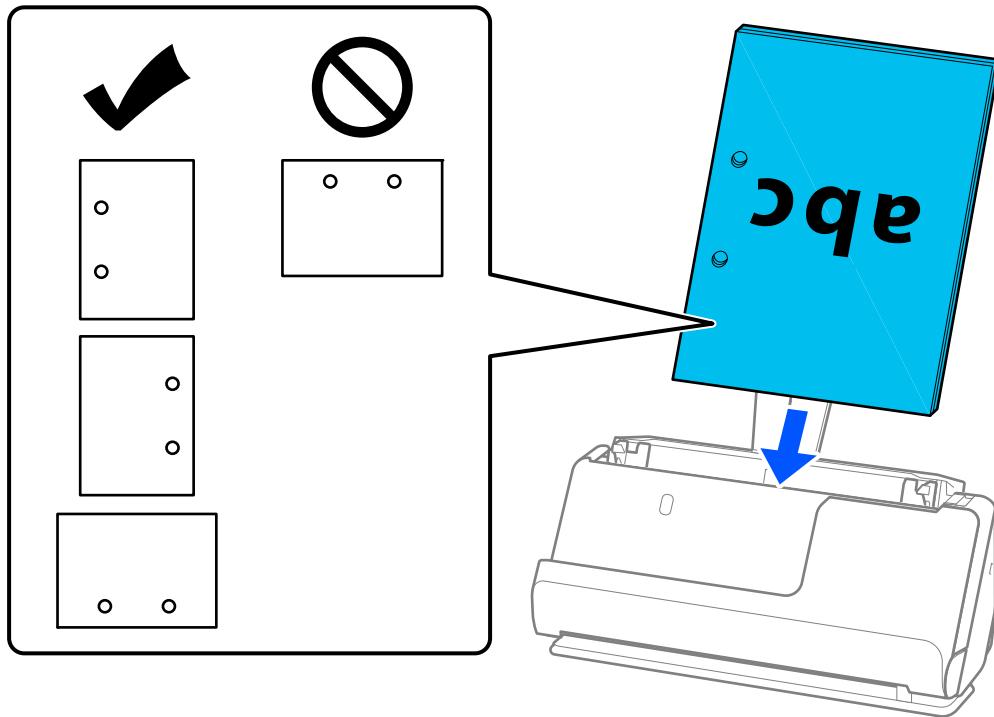

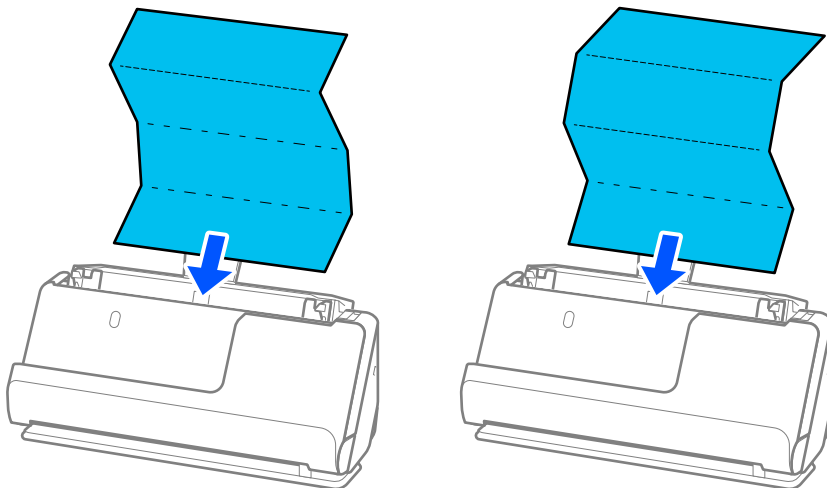

- ❑ Place folded originals so that the valley fold is at the front of the scanner and on the ADF side. You can load up to 10 sheets. Originals with a hard fold line may not be fed properly. For originals such as these, flatten them so that the height of the fold is 5 mm (0.2 inches) or less before loading it.

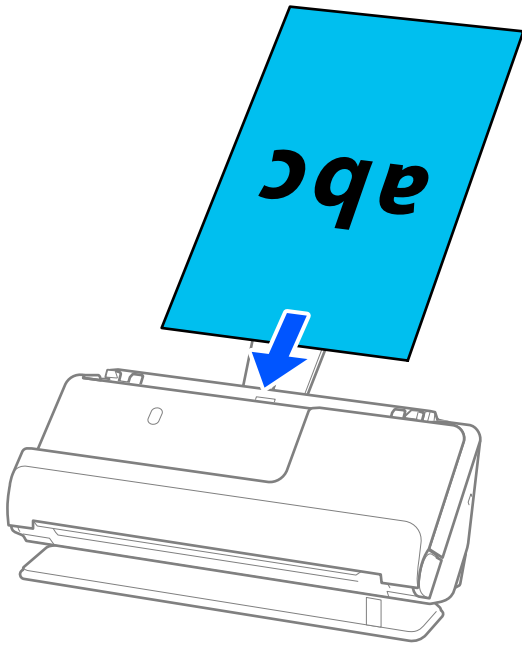

- ❑ When scanning award certificates and other thick originals (originals with a thickness of 127 g/m² or more), switch the scanner to the straight path position and load only one original at a time.



You can check the scanner position from the scanner position icon on the panel. If  is displayed, the scanner is in the straight path position. If  is displayed, pull the lever on the back to tilt the scanner back.

When scanning in the straight path position, make sure there is enough space in front of the scanner for the ejected originals.

Also, if the ejected originals hit the surface of the table on which the scanner is placed and this affects the scanned image, move the scanner to the edge of the table so that the ejected originals can drop and catch them directly.

8. Adjust the edge guides to fit the edges of the original so that there are no gaps. Otherwise, the original may be fed skewed.

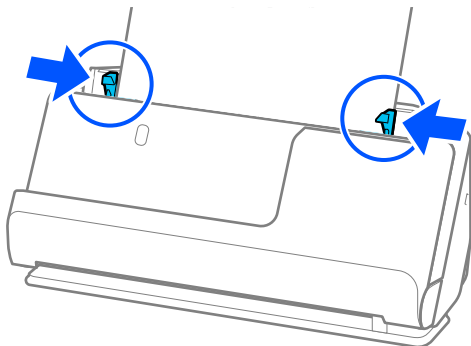

Note:

- ❑ If the document extends beyond the input tray extension, support the document with one hand to prevent it from falling from the ADF. Also, while scanning an original, support both ends of the original with your hands to prevent it from tilting.
- ❑ When scanning thin paper originals such as flyers or receipts, or when scanning originals that tend to curl after scanning, we recommend extending the paper output support in both places.
After loading the original, press the buttons (two places) to raise the paper output support.

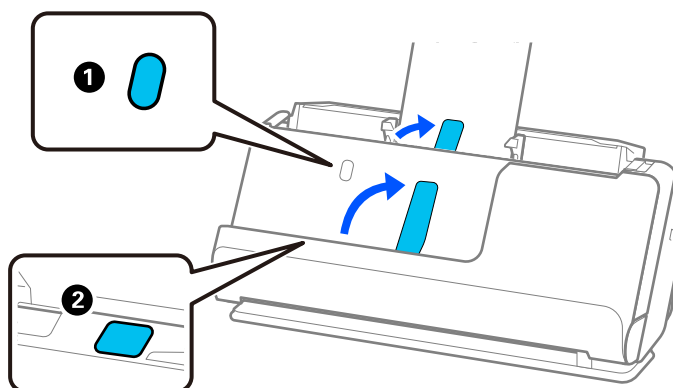

- ❑ When scanning originals such as business cards that tend to curl after scanning, we recommend scanning in the straight path position and only loading one original at a time.
- ❑ if you cancel scanning in the middle of scanning a batch of originals, the second original will be fed a little bit into the ADF and then scanning stops. Open the scanner cover to remove it, and then load the page again together with the first page and the rest of the originals.
- ❑ Depending on the type of paper and the environment in which the scanner is being used, the original may fall from the front of the scanner after scanning. In this situation, load fewer originals into the scanner than the specified number of originals that can be loaded.

Placing Large Size Originals

Note:

- ❑ Use a Carrier Sheet when scanning wrinkled, fragile, or valuable originals.
“Placing Important Originals or Photos” on page 82
- ❑ Make sure there is enough space in front of the scanner for the ejected originals.

1. Make sure that the scanner position icon is  (straight path position).

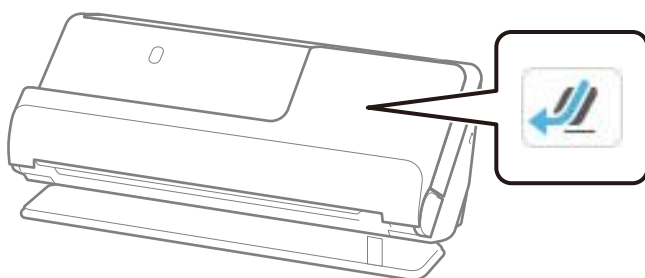

If  (vertical path position) is displayed, pull the scanner position selector to tilt the scanner back.

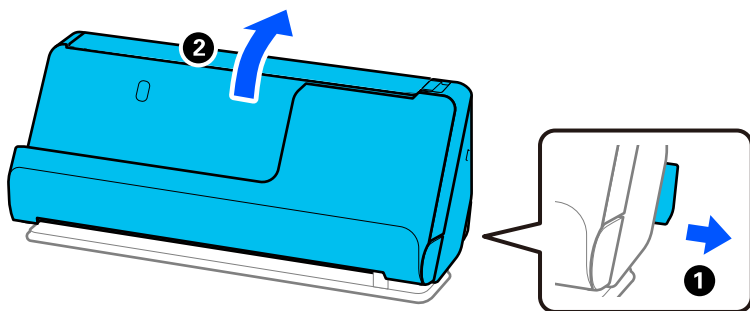

2. Open the input tray.

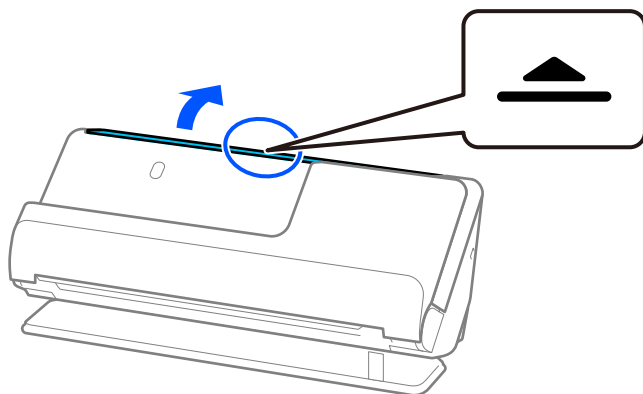

3. Raise the input tray extension.

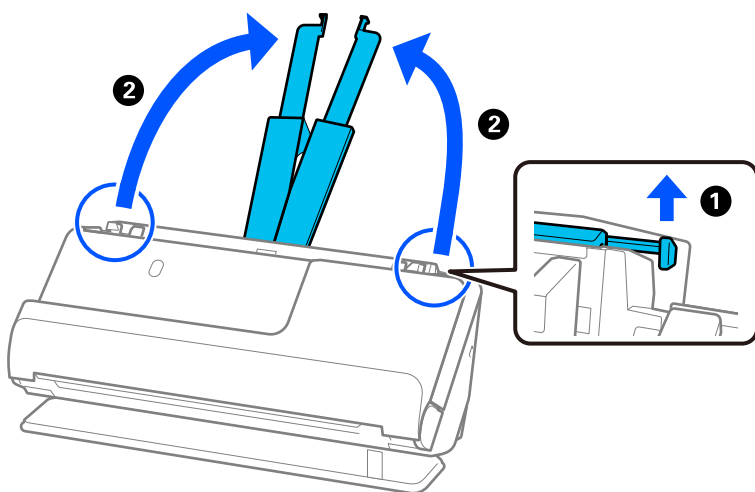

4. Move the edge guides to the edges of the input tray.

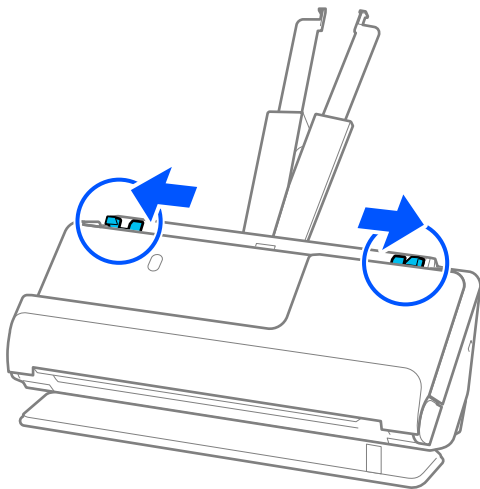

5. Fold the original in half so that the side to be scanned is facing out.

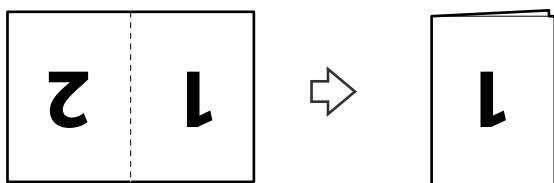

6. Place the original with side “1” facing up and the leading edge facing into the ADF. Insert the paper into the ADF until it meets resistance.

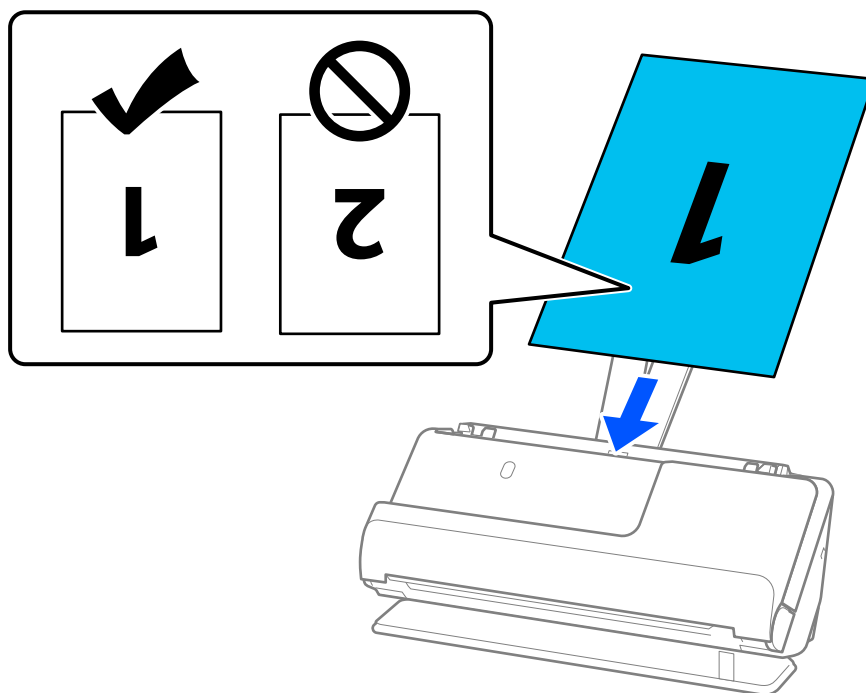

7. Adjust the edge guides to fit the edges of the original so that there are no gaps. Otherwise, the original may be fed skewed.

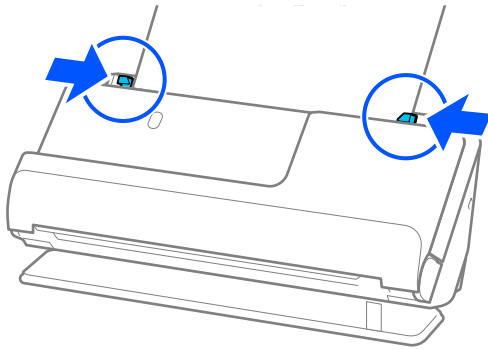

Note:

To scan both sizes and stitch them together, set the appropriate setting in the Epson Scan 2 window.

When you are using Epson ScanSmart, you can open the Epson Scan 2 screen by clicking the **Settings** button > **Scanner Settings** tab > **Scan Settings**.

Select **Double-Sided** from **Scanning Side** and select **Left & Right** from **Stitch Images** in the Epson Scan 2 window. See the Epson Scan 2 help for details.

Related Information

- ➔ [“Carrier Sheet Codes” on page 40](#)

Placing Long Paper

Note:

Make sure there is enough space in front of the scanner for the ejected originals.

1. Make sure that the scanner position icon is  (straight path position).

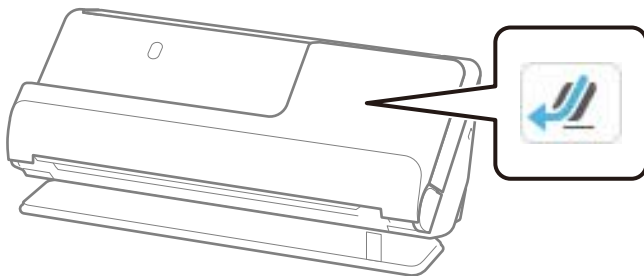

If  (vertical path position) is displayed, pull the scanner position selector to tilt the scanner back.

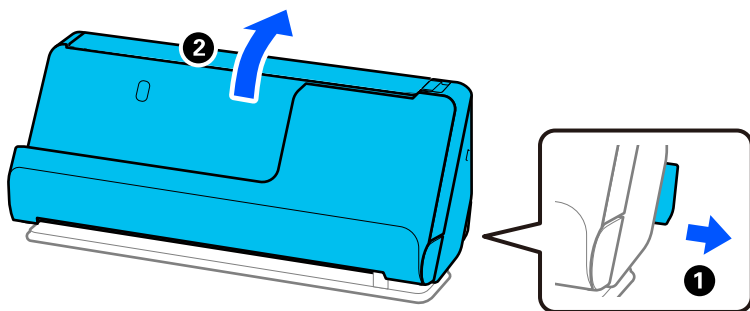

2. Open the input tray.

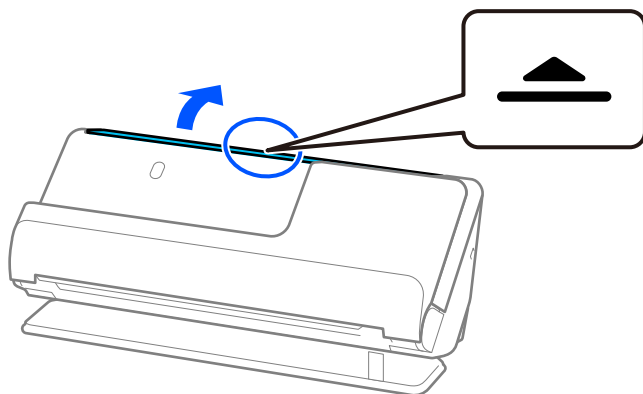

3. Raise the input tray extension.

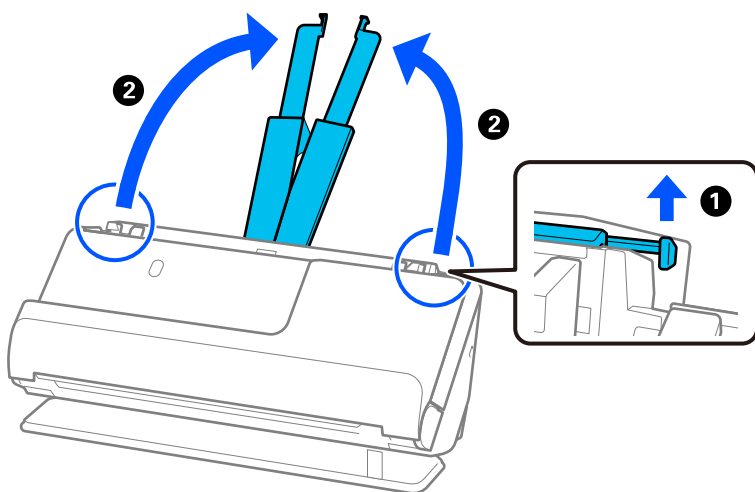

4. Move the edge guides to the edges of the input tray.

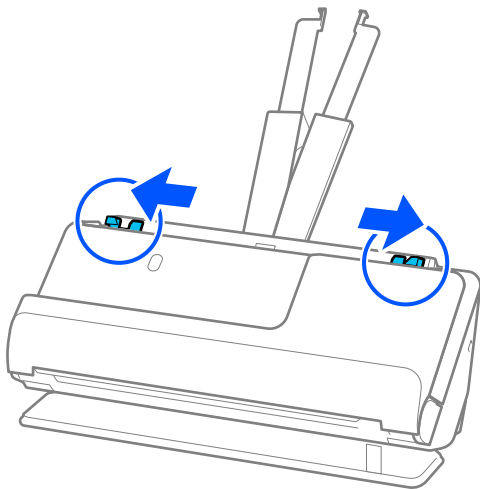

5. Load the original into the input tray straight, facing up and with the top edge facing into the ADF. Insert the paper into the ADF until it meets resistance.

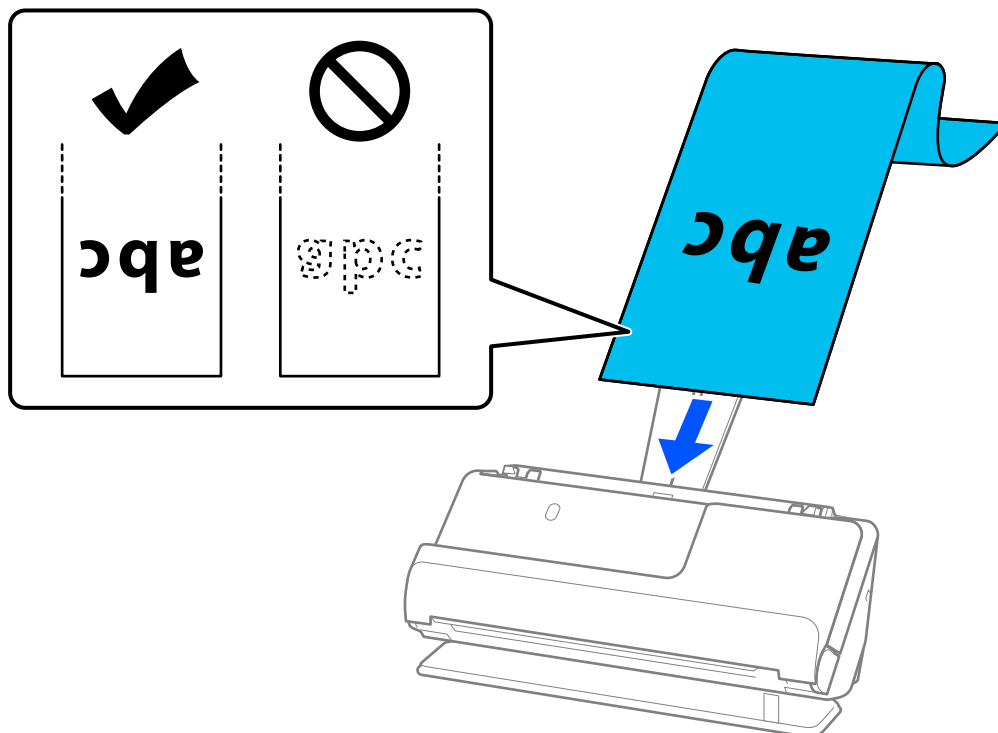

When loading long paper, support it at the input side so that it does not drop out of the ADF, and the output side so that the ejected paper does not get jammed or fall from the output tray.

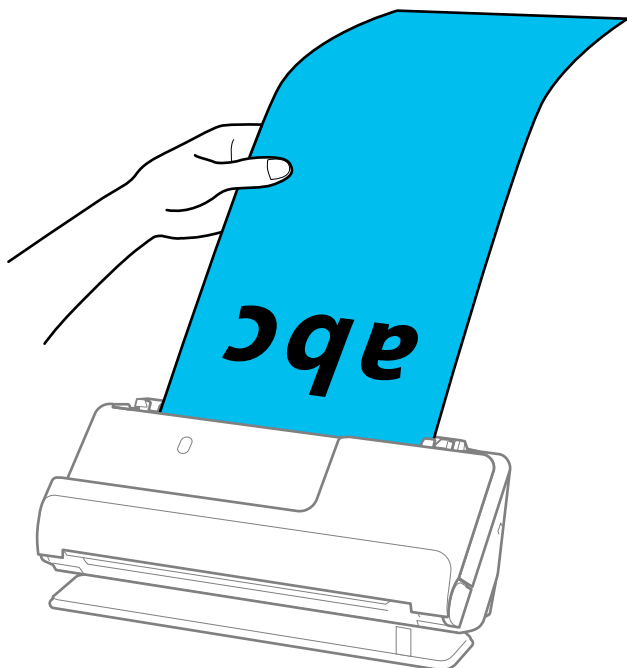

6. Adjust the edge guides to fit the edges of the original so that there are no gaps. If there are any gaps, the original may be fed skewed.

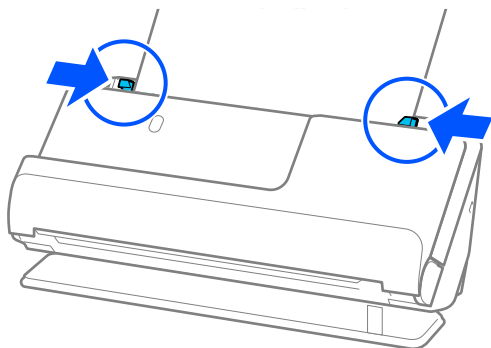

Note:

- ❑ Also, while scanning long paper, support both ends of the original with your hands to prevent it from tilting.

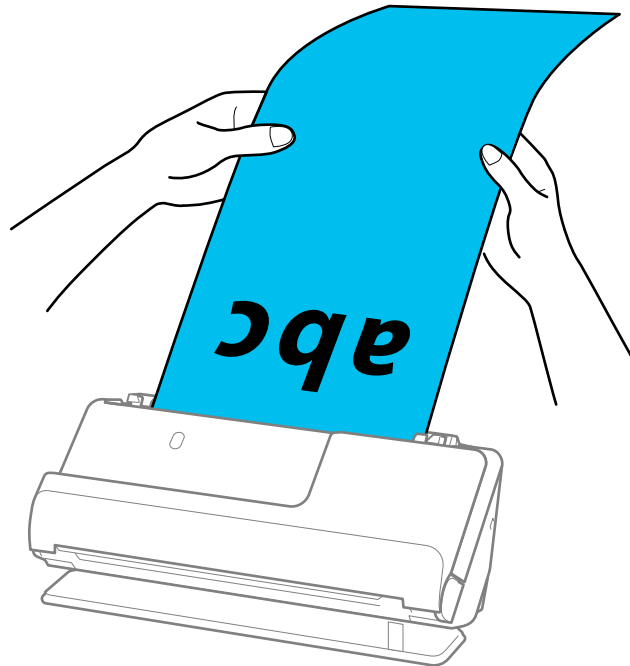

- ❑ See the following for the maximum lengths depending on the situation.

[“Maximum Length for Long Paper” on page 46](#)

- ❑ You need to specify the paper size in the Epson Scan 2 window.

When you are using Epson ScanSmart, you can open the Epson Scan 2 screen by clicking the **Settings** button > **Scanner Settings** tab > **Scan Settings**.

There are three ways to specify the paper size in the Epson Scan 2 window.

If the paper length is 3,048.0 mm (120 inches) or less, you can select **Auto Detect (Long Paper)** to detect the size automatically.

If the paper length is more than 3,048.0 mm (120 inches), you need to select **Customize** and enter the size of the paper. If the paper length is 5,461.0 mm (215 inches) or less, you can use **Detect paper length** instead of entering the paper height. If the paper is longer than 5,461.0 mm (215 inches), you need to enter the width and height of the paper.

Placing Plastic Cards

Note:

Make sure there is enough space in front of the scanner for the ejected originals.

1. Make sure that the scanner position icon is  (straight path position).

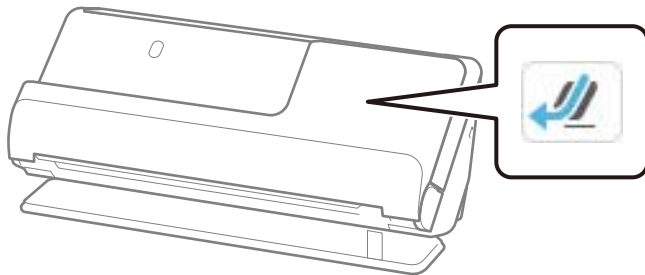

If  (vertical path position) is displayed, pull the scanner position selector to tilt the scanner back.

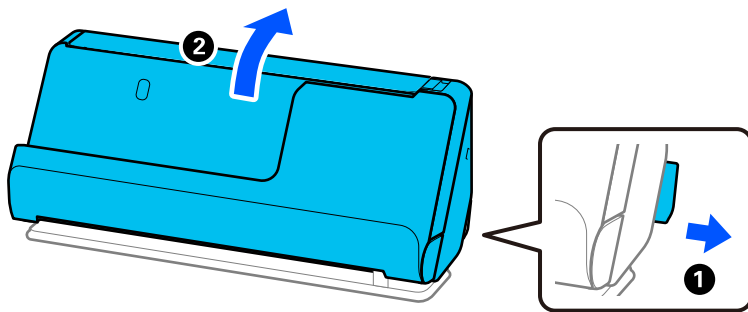

2. Open the input tray.

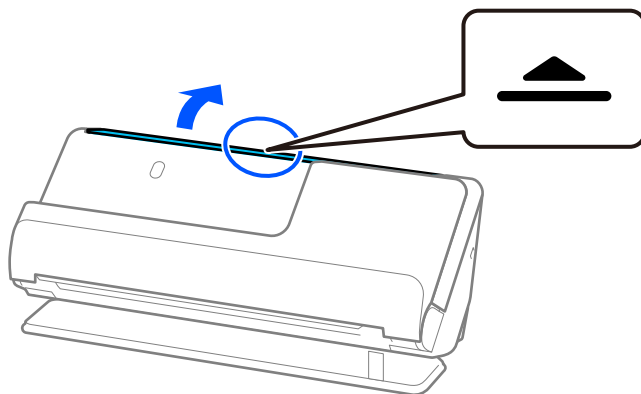

3. Raise the input tray extension.

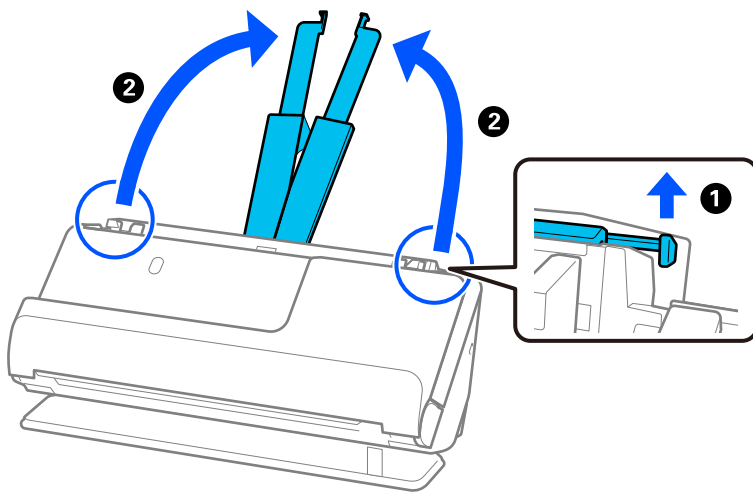

4. Move the edge guides to the edges of the input tray.

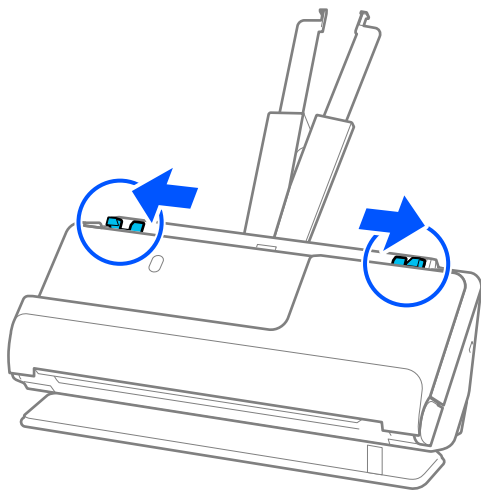

5. Load the plastic cards with the side to be scanned facing up with the top edge facing into the ADF. Insert the paper into the ADF until it meets resistance.

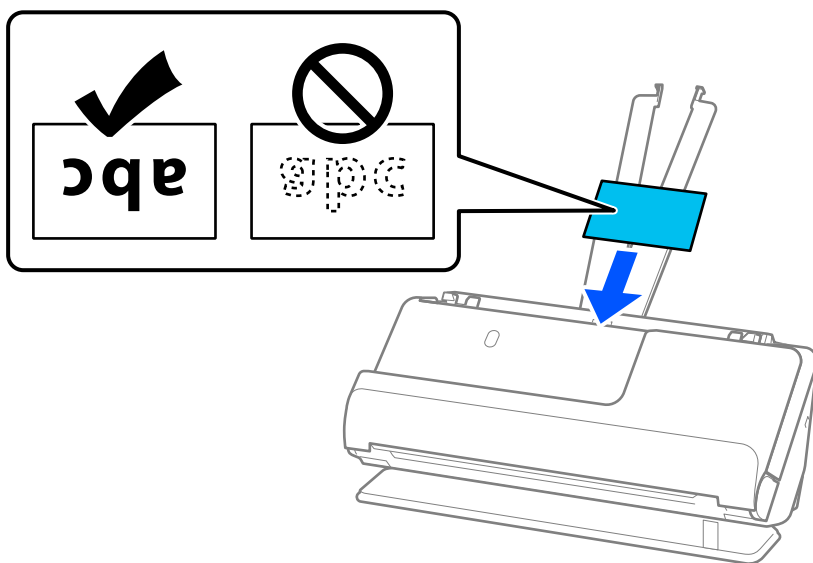

! *Important:*

Do not load plastic cards vertically.

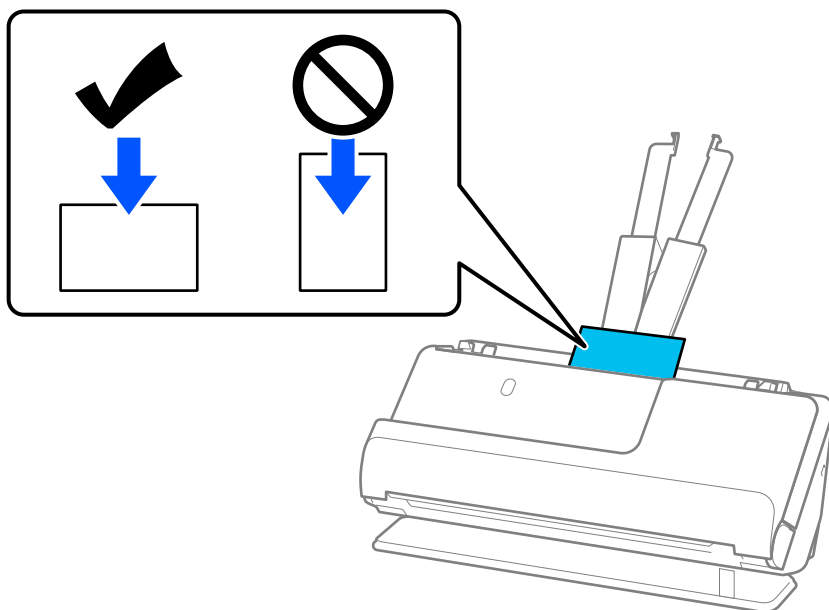

- Adjust the edge guides to fit the edges of the cards so that there are no gaps. Otherwise, the original may be fed skewed.

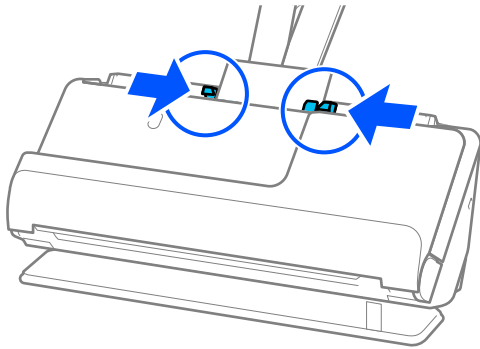

Note:

To scan plastic cards, set the appropriate setting in the Epson Scan 2 window.

When you are using Epson ScanSmart, you can open the Epson Scan 2 window by pressing the **Settings** button > **Scanner Settings** tab > **Scan Settings**.

On the **Main Settings** tab in Epson Scan 2, select **Plastic Card** in **Document Size** or select **Off** in **Detect Double Feed**. See the Epson Scan 2 help for details.

If you have not disabled **Detect Double Feed** on the Epson Scan 2 screen and a double feed error occurs, remove the cards from the ADF and reload them.

Related Information

➔ [“Placing Laminated Cards” on page 71](#)

Placing Laminated Cards

Note:

Make sure there is enough space in front of the scanner for the ejected originals.

- Make sure that the scanner position icon is  (straight path position).

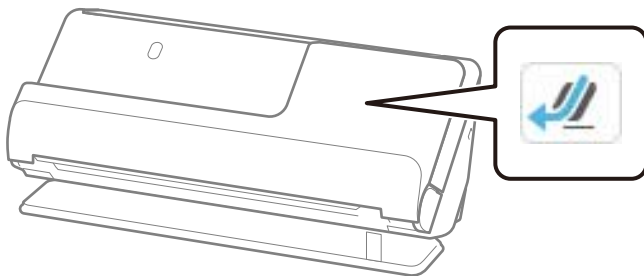

If  (vertical path position) is displayed, pull the scanner position selector to tilt the scanner back.

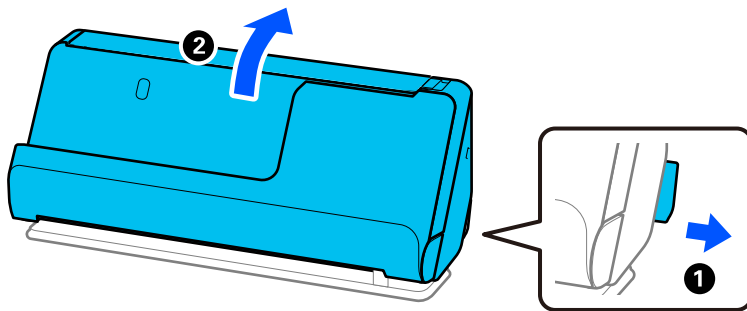

2. Open the input tray.

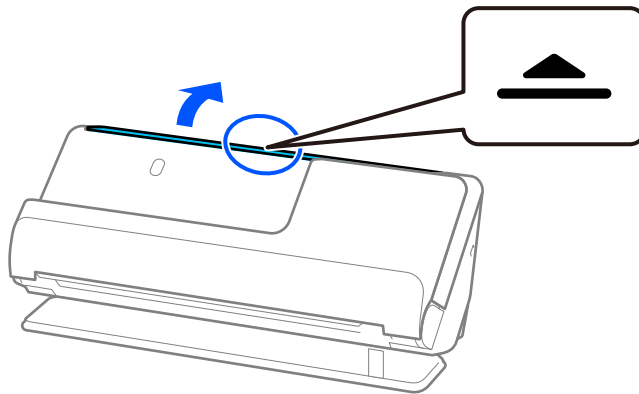

3. Raise the input tray extension.

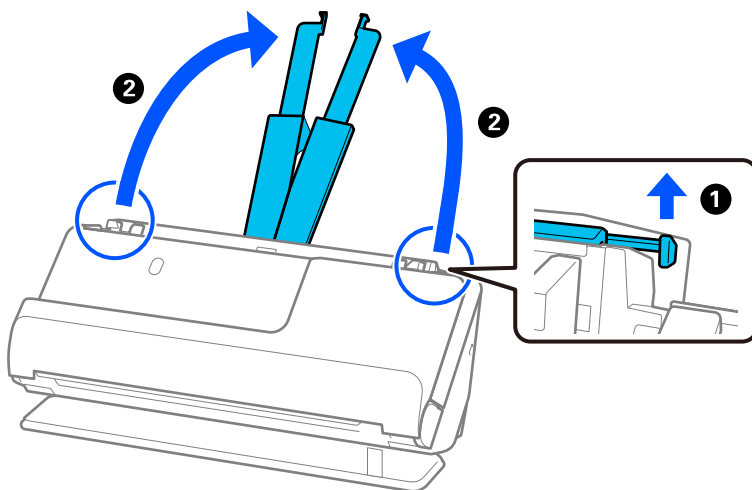

4. Move the edge guides to the edges of the input tray.

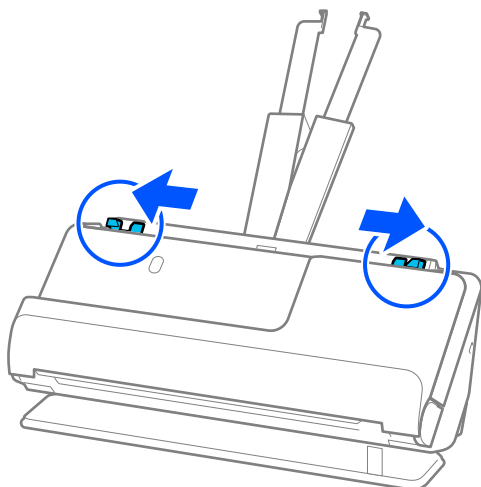

5. Load the plastic cards with the side to be scanned facing up with the top edge facing into the ADF. Insert the paper into the ADF until it meets resistance.

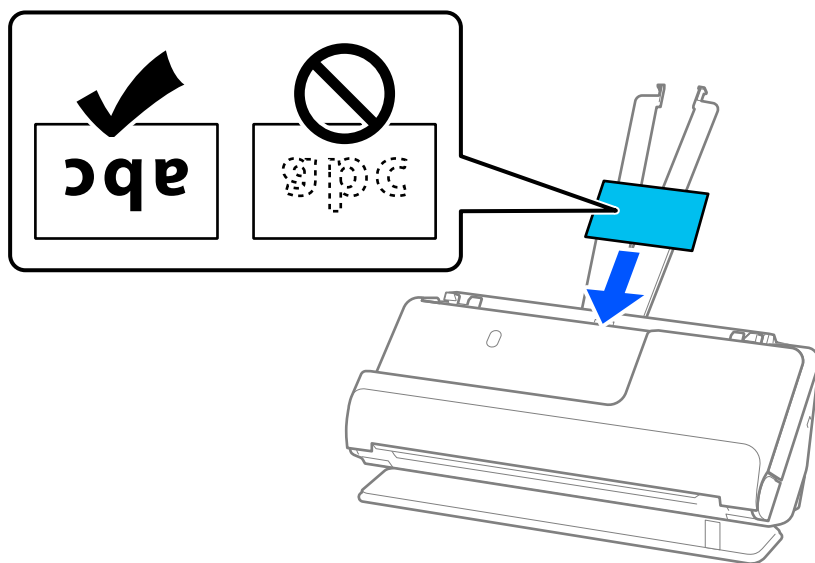

6. Adjust the edge guides to fit the edges of the cards so that there are no gaps. If there are any gaps, the original may be fed skewed.

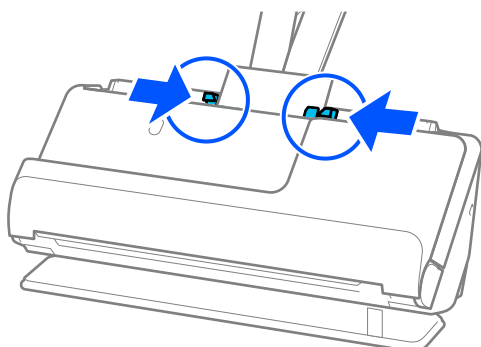

Note:

To scan laminated cards, set the appropriate setting in the Epson Scan 2 window.

When you are using Epson ScanSmart, you can open the Epson Scan 2 screen by clicking the **Settings** button > **Scanner Settings** tab > **Scan Settings**.

❑ To increase the accuracy of auto size detection, select the **Main Settings** tab > **Document Size** > **Settings** > **Scan laminated card**. See the Epson Scan 2 help for details.

❑ Select the **Main Settings** tab > **Detect Double Feed** > **Off**. See the Epson Scan 2 help for details.

If you have not disabled **Detect Double Feed** on the Epson Scan 2 screen and a double feed error occurs, remove the cards from the ADF and reload them.



Placing a Booklet

Note:

Make sure there is enough space in front of the scanner for the ejected originals.

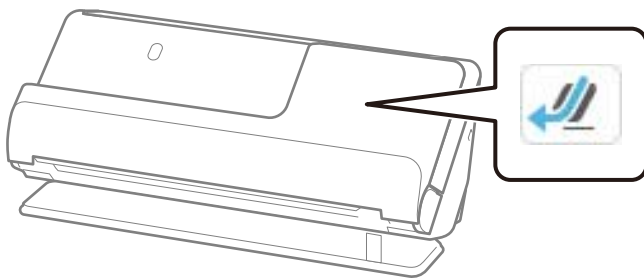
1. Make sure that the scanner position icon is  (straight path position).



 If  (vertical path position) is displayed, pull the scanner position selector to tilt the scanner back.

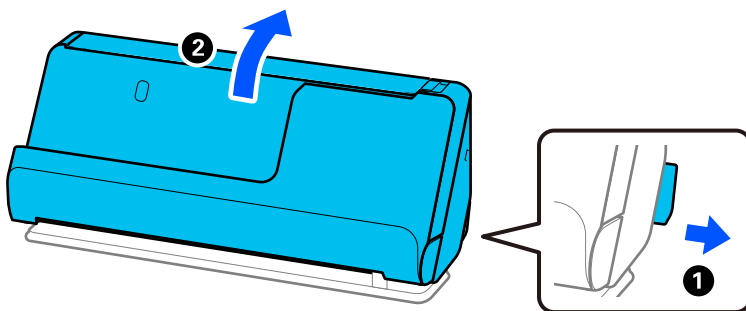

2. Open the input tray.

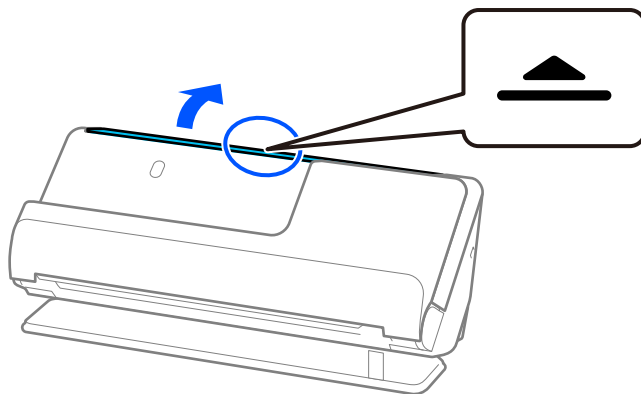

3. Raise the input tray extension.

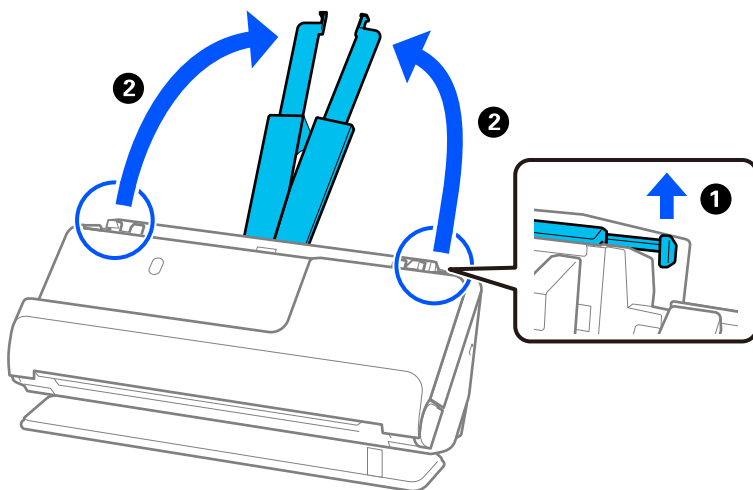

4. Move the edge guides to the edges of the input tray.

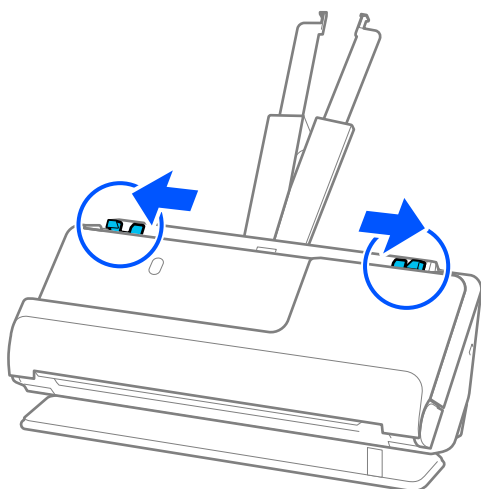

5. Place the booklet with the side to be scanned facing up and with the side with more pages facing the ADF. Insert the paper into the ADF until it meets resistance.

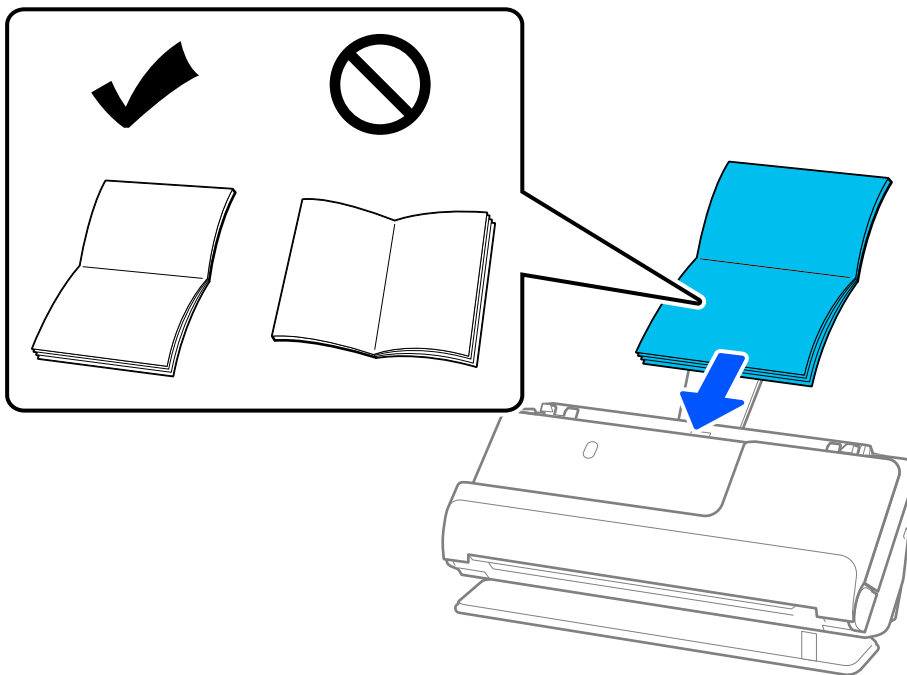

6. Adjust the edge guides to fit the edges of the booklet so that there are no gaps. If there are any gaps, the original may be fed skewed.

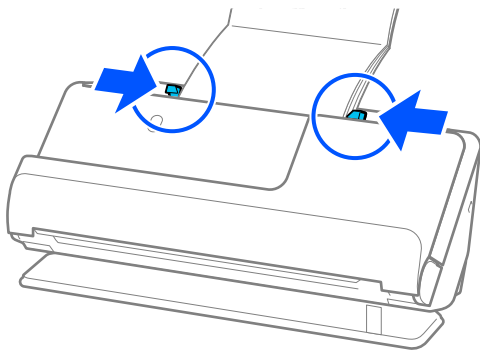

Note:

- ❑ When scanning booklets, support the top of the booklet by hand to prevent it from falling out of the ADF or closing.

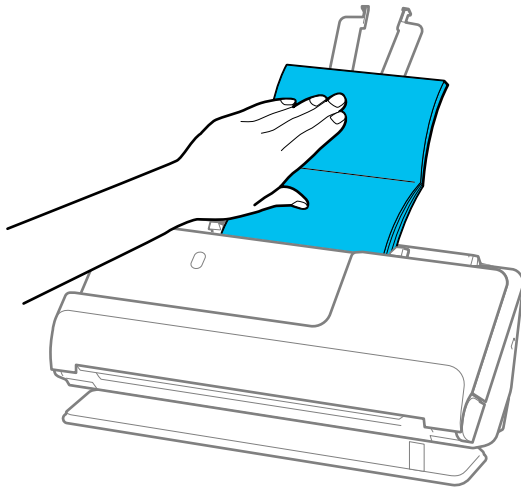

- ❑ If the ejected originals hit the surface of the table on which the scanner is placed and this affects the scanned image, move the scanner to the edge of the table so that the ejected originals can drop and catch them directly.

- ❑ When scanning booklets, make the appropriate settings on the Epson Scan 2 screen.

When you are using Epson ScanSmart, you can open the Epson Scan 2 screen by clicking the **Settings** button > **Scanner Settings** tab > **Scan Settings**.

On the Epson Scan 2 screen, use one of the following methods to turn off **Detect Double Feed**.

- Select **Booklets** in **Scan Settings**
- On the **Main Settings** tab, set **Detect Double Feed** to **Off**

See the Epson Scan 2 help for details.

Placing a Passport

Note:

Make sure there is enough space in front of the scanner for the ejected originals.

1. Make sure that the scanner position icon is  (straight path position).

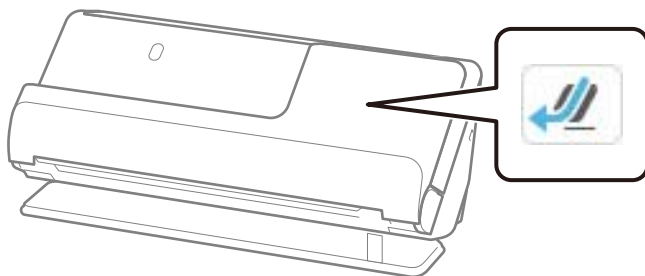

If  (vertical path position) is displayed, pull the scanner position selector to tilt the scanner back.

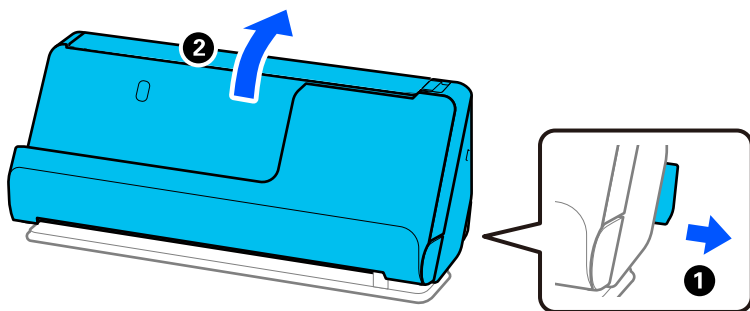

2. Open the input tray.

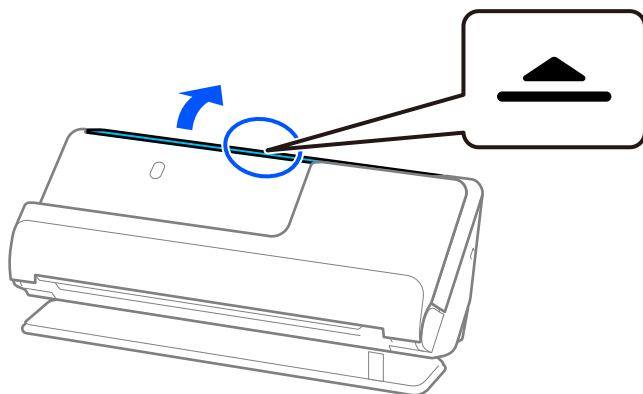

3. Raise the input tray extension.

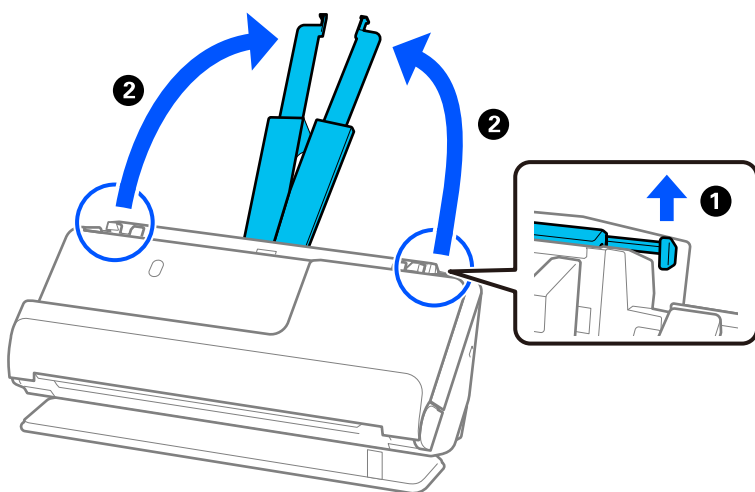

4. Move the edge guides to the edges of the input tray.

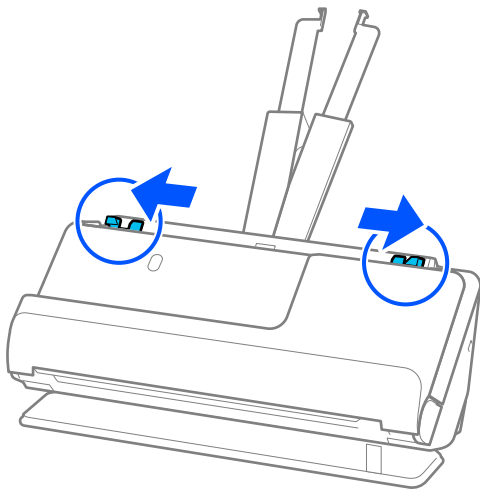

5. Place the passport with the side to be scanned facing up and with thicker side of the passport facing into the ADF.

Insert the paper into the ADF until it meets resistance.

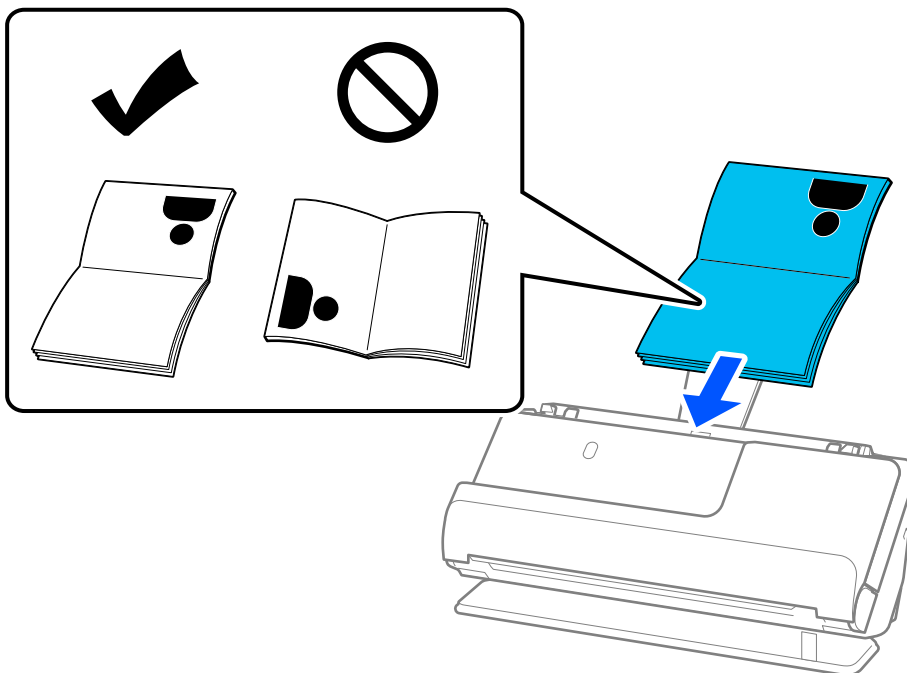

Note:

In the following cases, scan the passport using the Passport Carrier Sheet instead.

- ❑ *If you want to protect the passport while scanning*
- ❑ *If you want to scan thick passports and passports with a slightly expanded binding edge*

Place the passport in the Passport Carrier Sheet with the side to be scanned facing up and with the thicker side of the passport facing the leading edge. Next, place the Passport Carrier Sheet into the input tray with the top edge facing into the ADF.

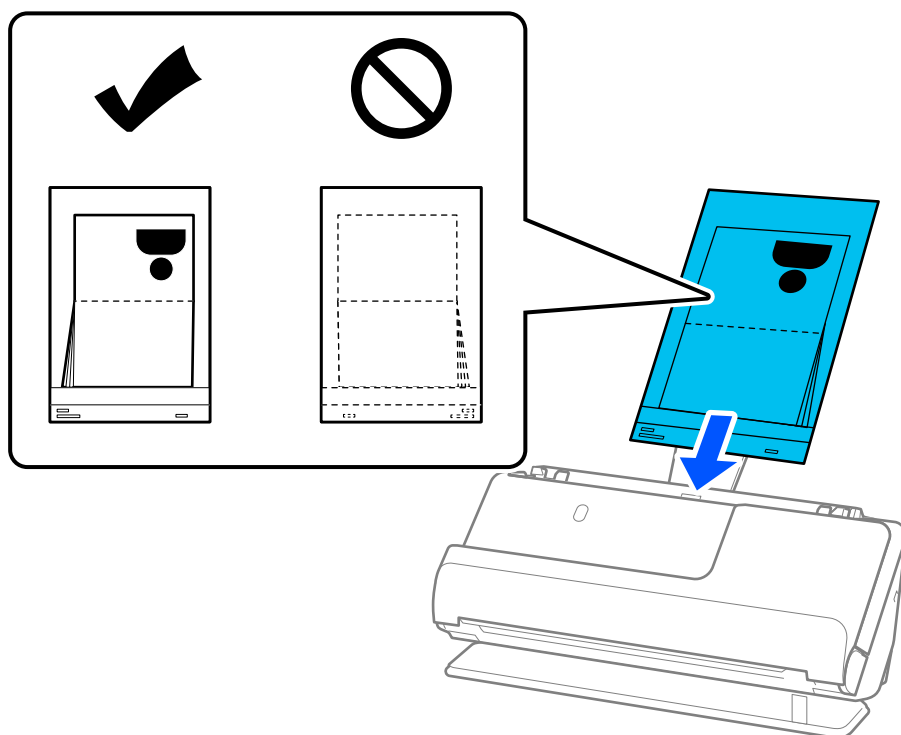

6. Adjust the edge guides to fit the edges of the original so that there are no gaps. If there are any gaps, the original may be fed skewed.

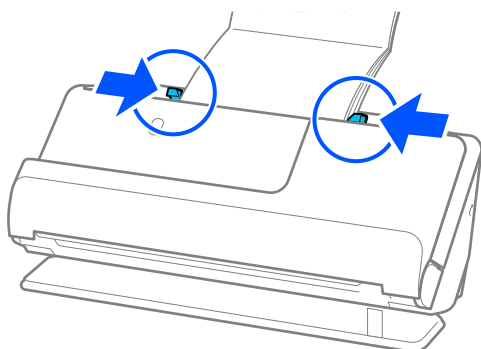

Note:

- ❑ When scanning passports, support the top of the passport by hand to prevent it from falling out of the ADF or closing.

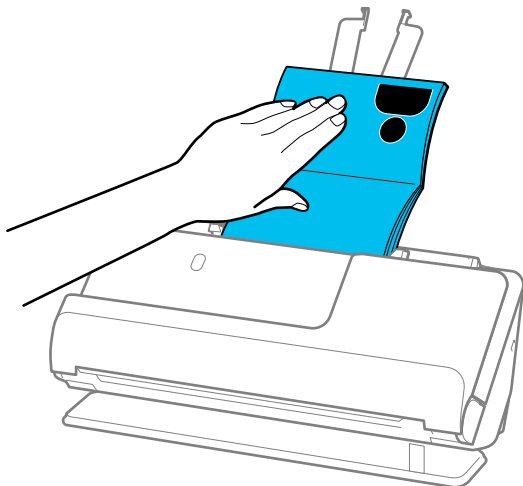

- ❑ If the ejected originals hit the surface of the table on which the scanner is placed and this affects the scanned image, move the scanner to the edge of the table so that the ejected originals can drop and catch them directly.
- ❑ When scanning a passport, make the appropriate settings on the Epson Scan 2 screen.
When you are using Epson ScanSmart, you can open the Epson Scan 2 screen by clicking the **Settings** button > **Scanner Settings** tab > **Scan Settings**.
On the Epson Scan 2 screen, use one of the following methods to turn off **Detect Double Feed**.
 - Select **Passport** in **Scan Settings**
 - On the **Main Settings** tab, set **Detect Double Feed** to **Off**See the Epson Scan 2 help for details.
- ❑ Do not use a scratched Passport Carrier Sheet or a Passport Carrier Sheet that has been scanned more than 3,000 times.
- ❑ Only use a Passport Carrier Sheet designed for your scanner. The Passport Carrier Sheet is automatically recognized by the scanner by detecting three small rectangular holes on the leading edge. Keep the holes in the Passport Carrier Sheet clean and uncovered.

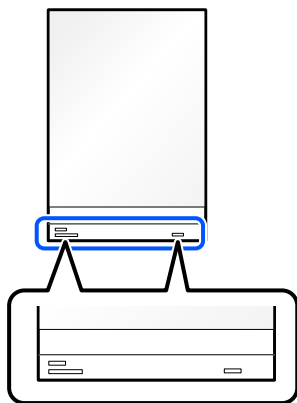

Related Information

➔ “Carrier Sheet Codes” on page 40

Placing Important Originals or Photos

Use a Carrier Sheet when scanning the following types of originals.

- Photos
- Valuable originals
- Wrinkled originals
- Fragile originals

Note:

Make sure there is enough space in front of the scanner for the ejected originals.

1. Make sure that the scanner position icon is  (straight path position).

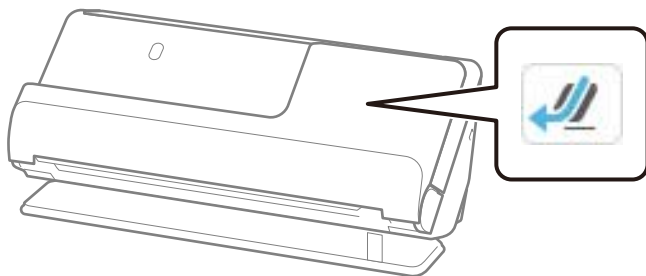

If  (vertical path position) is displayed, pull the scanner position selector to tilt the scanner back.

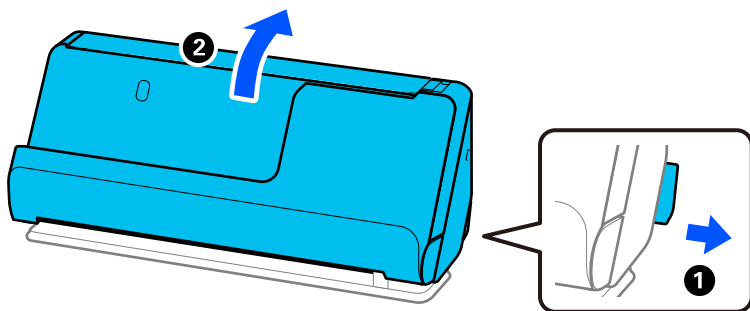

2. Open the input tray.

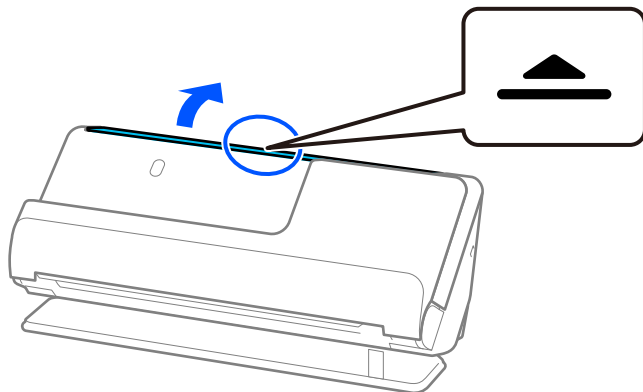

3. Raise the input tray extension.

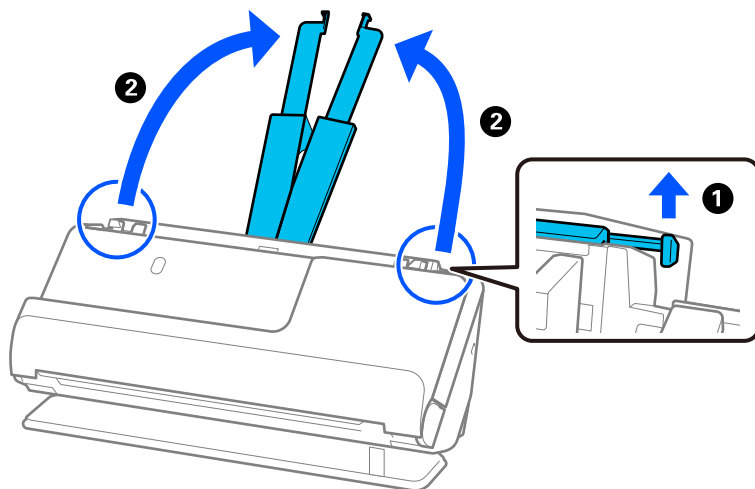

4. Move the edge guides to the edges of the input tray.

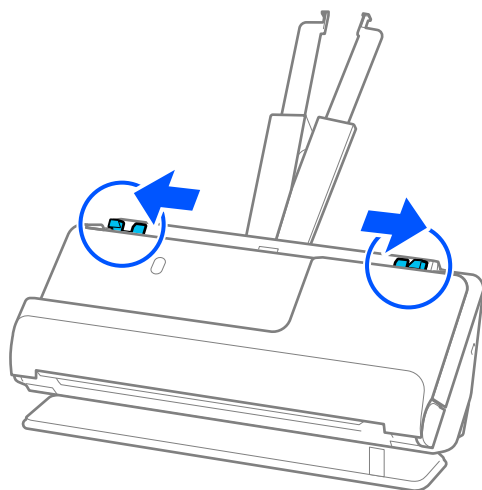

5. Place your original in the Carrier Sheet.

Place your original so that the back of the original is facing the side of the Carrier Sheet with the illustration.

- For originals

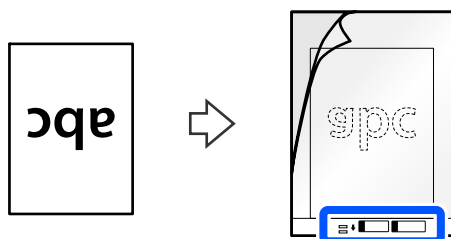

☐ For photos

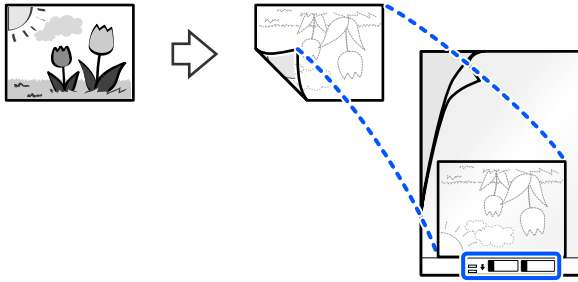

For large originals, fold them in half so that the side to be scanned is facing out, and then place the original with side "2" facing the side with the illustration and at the leading edge of the Carrier Sheet.

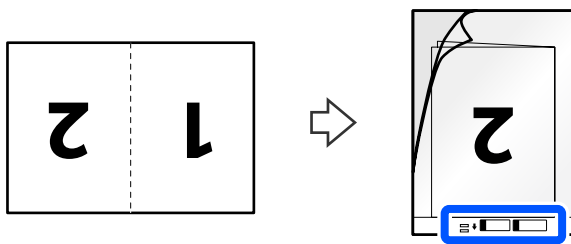

6. Turn over the Carrier Sheet.

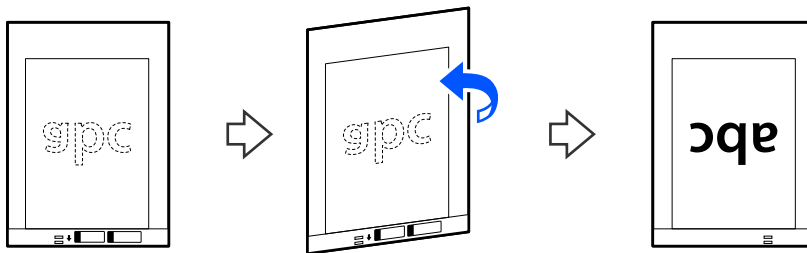

7. Load the Carrier Sheet into the input tray with the top edge facing into the ADF.
Insert the paper into the ADF until it meets resistance.

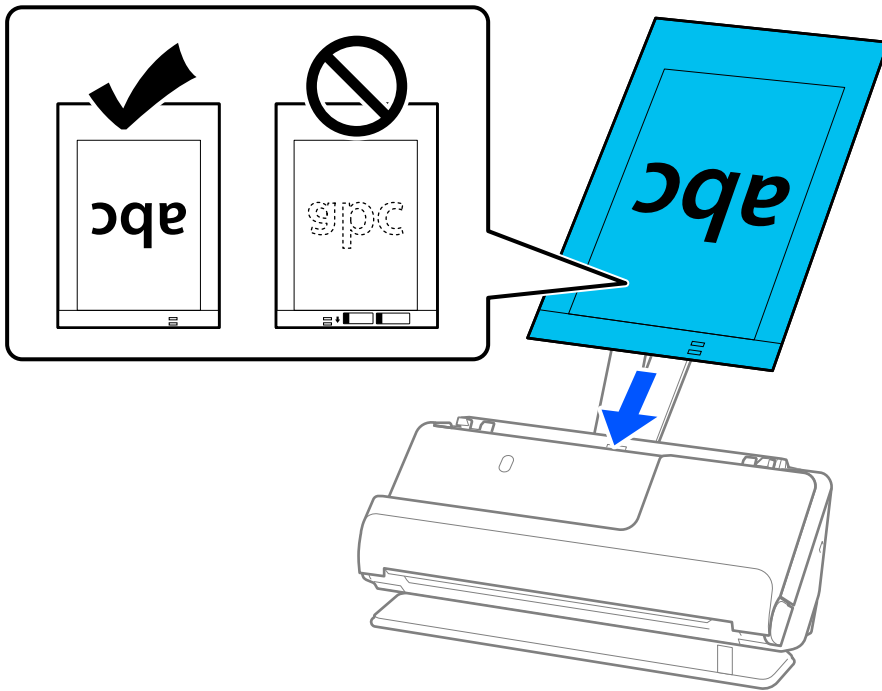

8. Align the edge guides with the Carrier Sheet so that there are no gaps. Otherwise, the Carrier Sheet may be fed skewed.

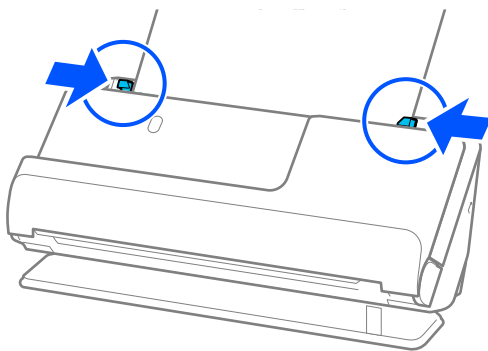

Note:

- ❑ Do not use a scratched Carrier Sheet or a Carrier Sheet that has been scanned more than 3,000 times.
- ❑ If you cannot find an appropriate size for the original you want to scan in the **Original Size** list, select **Auto Detect**.
- ❑ When scanning with a Carrier Sheet, select **Auto Detect** as the **Document Size** to automatically scan the image while applying **Paper Skew** as the **Correct Document Skew** setting.
- ❑ The leading edge of the original must be placed at the binding part of the Carrier Sheet when scanning an original approximately 297 mm (11.7 inches) long. Otherwise, the entire length of the Carrier Sheet may be scanned when **Auto Detect** is selected as the **Document Size**.
- ❑ When scanning a large original, to scan both sizes and stitch them together, make the appropriate settings on the Epson Scan 2 screen.

When you are using Epson ScanSmart, you can open the Epson Scan 2 screen by clicking the **Settings** button > **Scanner Settings** tab > **Scan Settings**.

Select **Double-Sided** from **Scanning Side** and select **Left & Right** from **Stitch Images** in the Epson Scan 2 window. See the Epson Scan 2 help for details.

- ❑ Only use a Carrier Sheet designed for your scanner. The Carrier Sheet is automatically recognized by the scanner by detecting two small rectangular holes on the leading edge. Keep the holes clean and not covered.

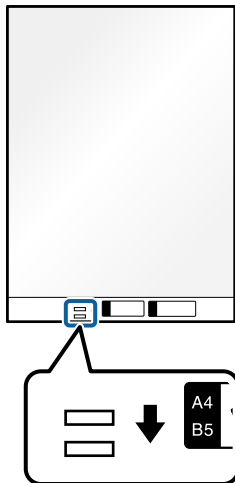

Related Information

➔ [“Carrier Sheet Codes” on page 40](#)

Placing an Envelope

Note:

Make sure there is enough space in front of the scanner for the ejected originals.

1. Make sure that the scanner position icon is  (straight path position).

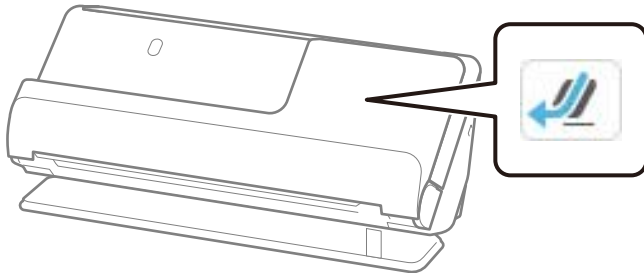

If  (vertical path position) is displayed, pull the scanner position selector to tilt the scanner back.

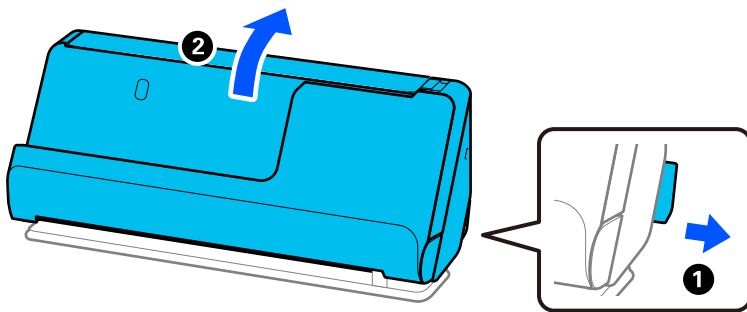

2. Open the input tray.

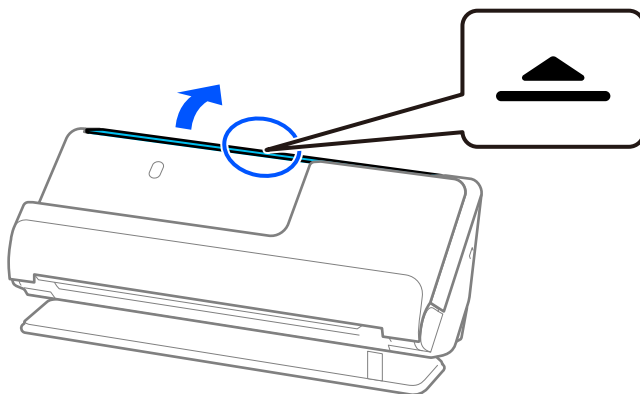

3. Raise the input tray extension.

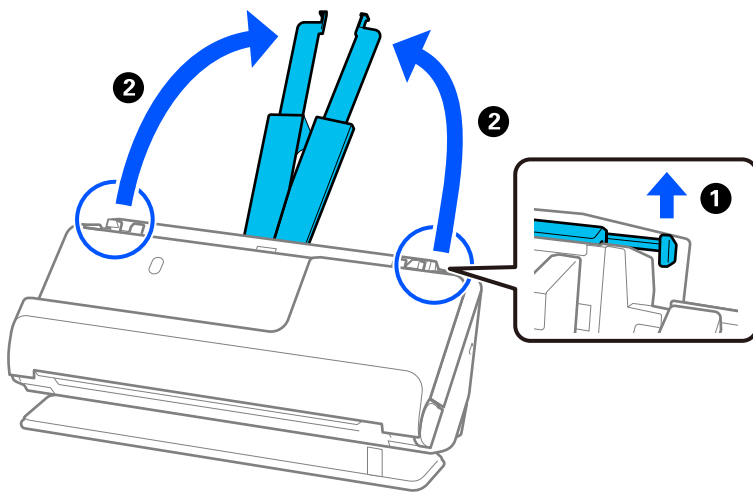

4. Move the edge guides to the edges of the input tray.

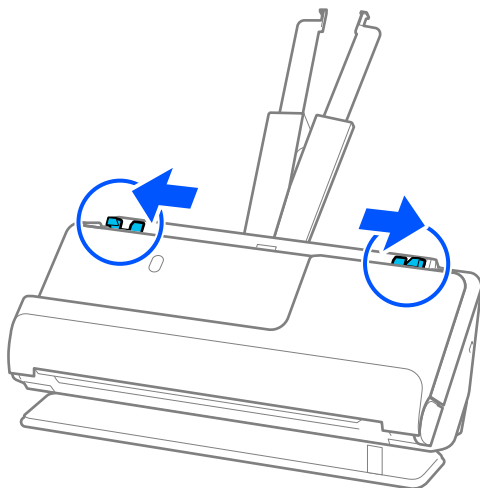

5. Load the envelope in a portrait orientation with the side to be scanned facing up. For envelopes with the opened edge (flap side) on the shorter side, you can load the envelope with the opened edge (flap side) facing up.

Insert the envelope into the ADF until it meets resistance.

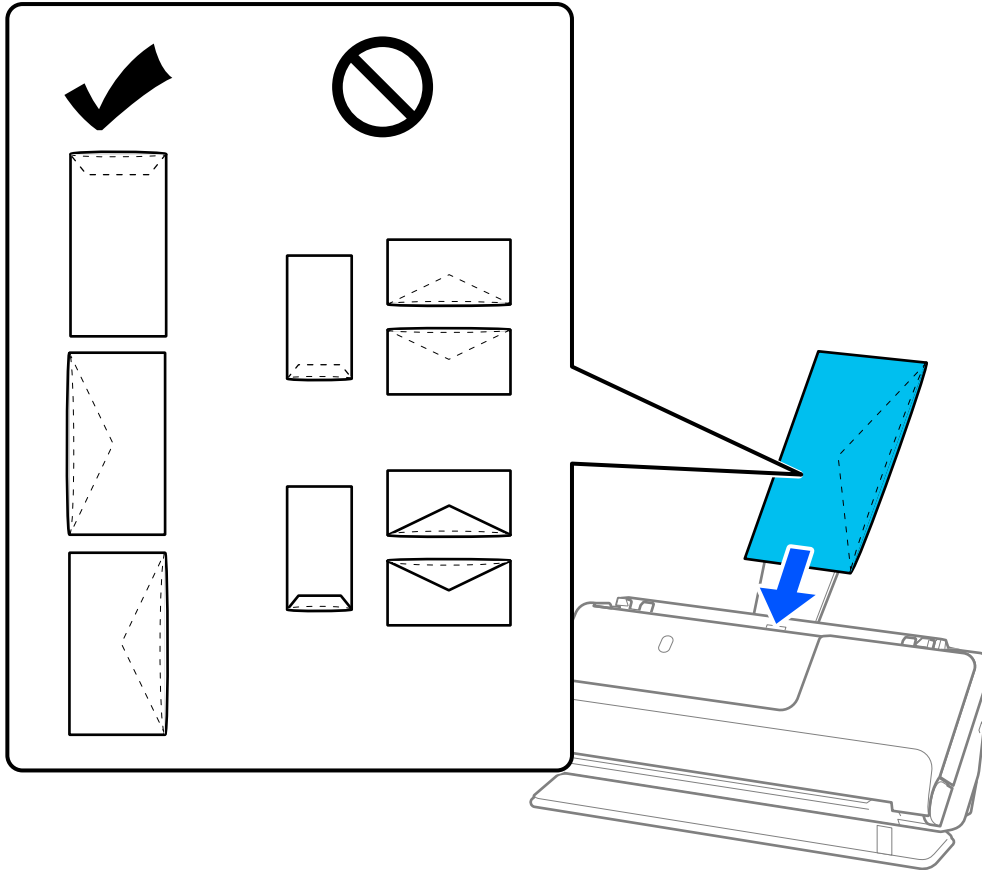

! Important:

Do not load envelopes with adhesives on them.

Note:

- Envelopes that are not cut cleanly at the flap edge when they are opened may not be scanned correctly.
- Envelopes that have not yet been sealed can be loaded with the flap open and facing up.

6. Adjust the edge guides to fit the edges of the envelope so that there are no gaps. Otherwise, the envelope may be fed skewed.

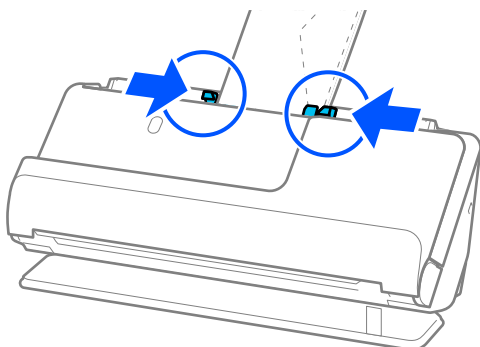

Note:

- ❑ We recommend selecting the appropriate rotation angle or **Auto** as the **Rotate** setting in the application.
- ❑ When scanning envelopes, make the appropriate settings on the Epson Scan 2 screen.

When you are using Epson ScanSmart, you can open the Epson Scan 2 screen by clicking the **Settings** button > **Scanner Settings** tab > **Scan Settings**.

Select **Main Settings** tab > **Detect Double Feed** > **Off**. See the Epson Scan 2 help for details.

If you have not disabled **Detect Double Feed** on the Epson Scan 2 screen and a double feed error occurs, remove the envelopes from the ADF and reload them.

Placing Irregular Shaped Originals

Note:

Make sure there is enough space in front of the scanner for the ejected originals.

1. Make sure that the scanner position icon is  (straight path position).

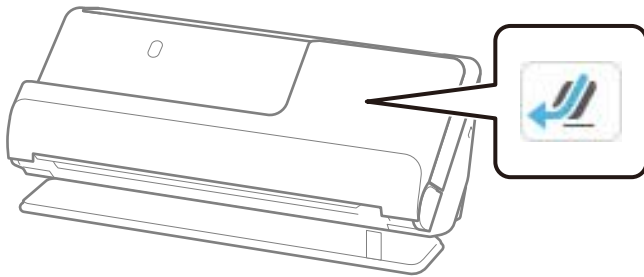

If  (vertical path position) is displayed, pull the scanner position selector to tilt the scanner back.

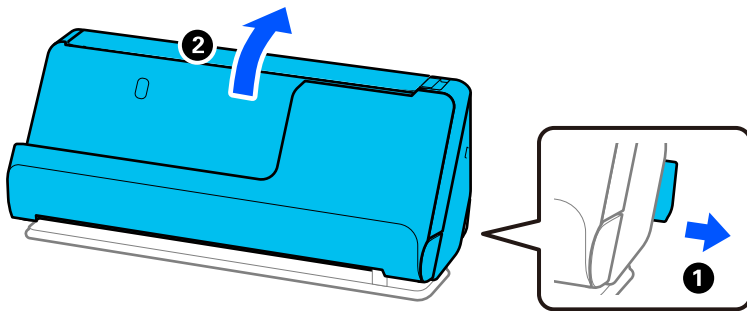

2. Open the input tray.

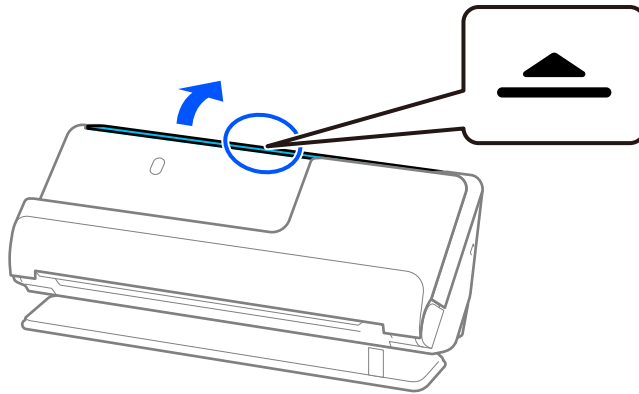

3. Raise the input tray extension.

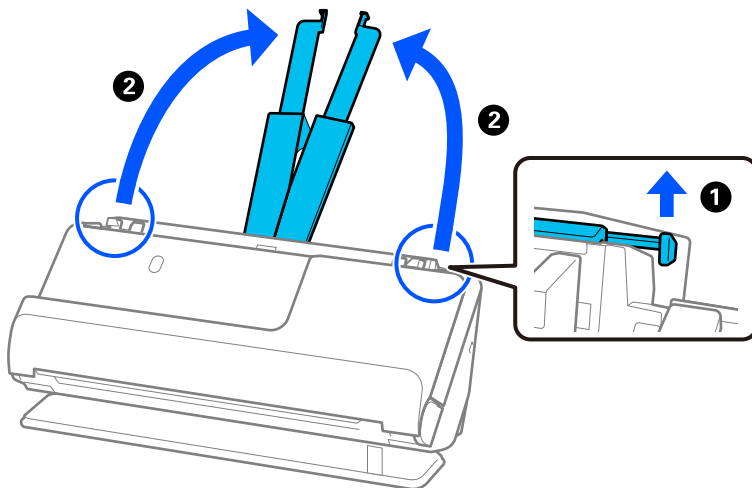

4. Move the edge guides to the edges of the input tray.

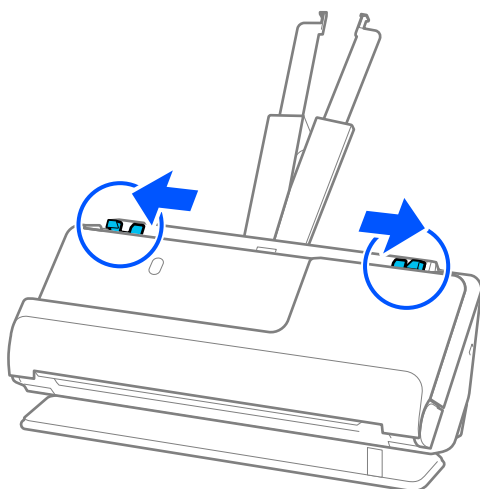

5. Place your original in the Carrier Sheet.

Place your original so that the back of the original is facing the side of the Carrier Sheet with the illustration.

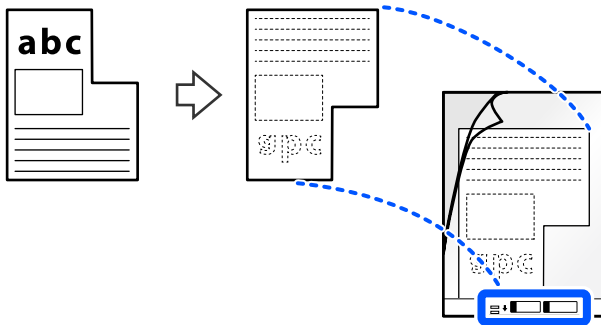

6. Turn over the Carrier Sheet.

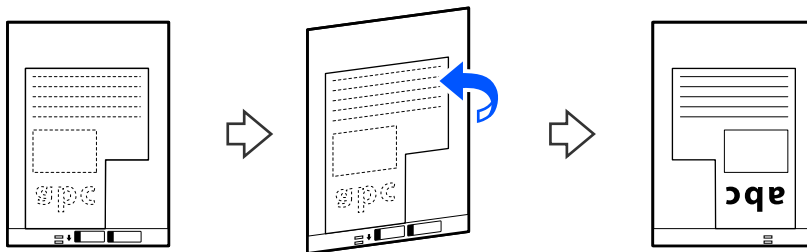

7. Load the Carrier Sheet into the input tray with the top edge facing into the ADF.

Insert the Carrier Sheet into the ADF until it meets resistance.

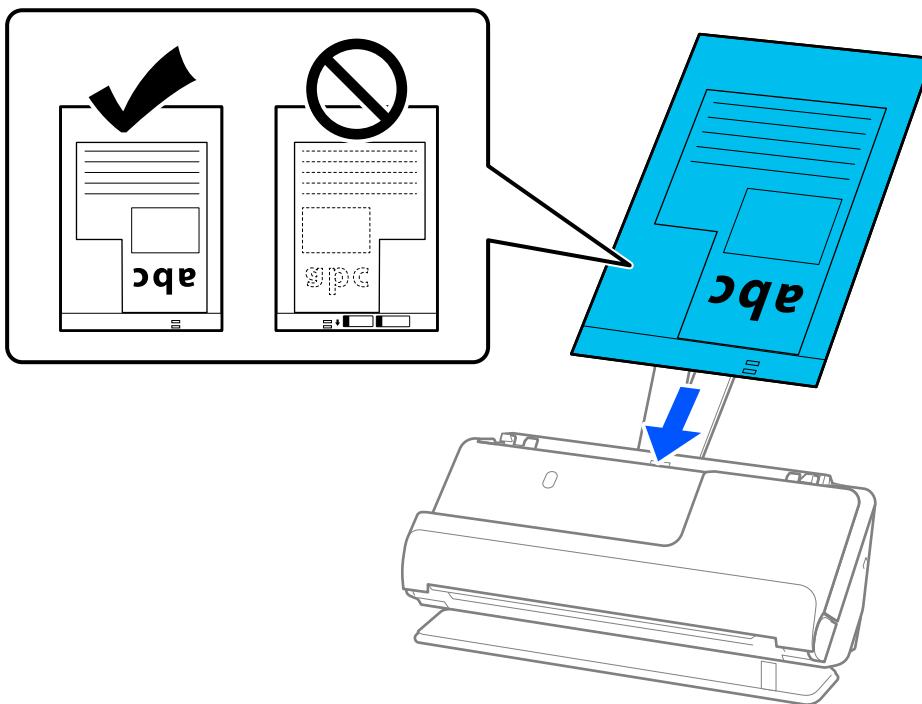

8. Align the edge guides with the Carrier Sheet so that there are no gaps. Otherwise, the Carrier Sheet may be fed skewed.

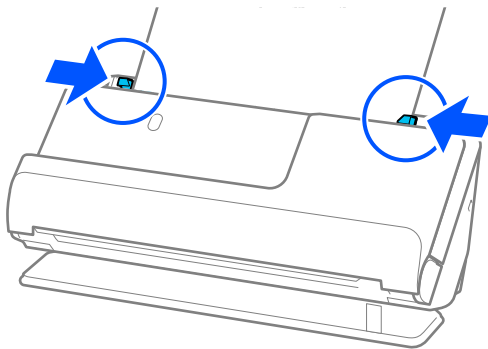

Note:

- ❑ Do not use a scratched Carrier Sheet or a Carrier Sheet that has been scanned more than 3,000 times.
- ❑ If you cannot find a **Document Size** that matches the original to be scanned, you need to make settings on the Epson Scan 2 screen.

When you are using Epson ScanSmart, you can open the Epson Scan 2 screen by clicking the **Settings** button > **Scanner Settings** tab > **Scan Settings**.

Select **Auto Detect** on the Epson Scan 2 screen, or select **Customize** to create a custom document size.

- ❑ When scanning with a Carrier Sheet, select **Auto Detect** as the **Document Size** setting in Epson Scan 2 to automatically scan the image while applying **Paper Skew** as the **Correct Document Skew** setting.
- ❑ Only use a Carrier Sheet designed for your scanner. The Carrier Sheet is automatically recognized by the scanner by detecting two small rectangular holes on the leading edge. Keep the holes in the Carrier Sheet clean and uncovered.

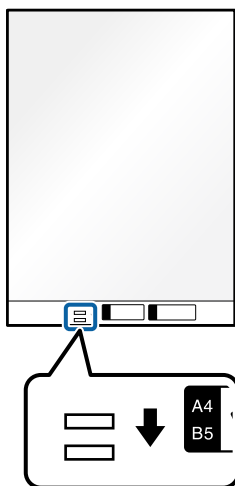

Related Information

➔ [“Carrier Sheet Codes” on page 40](#)

Loading Batches of Originals with Different Paper Types and Sizes

You can place and scan batches of different size originals (50.8×50.8 mm (2.0×2.0 inches) to A4 or letter size) up to a total thickness of 2.4 mm (0.1 inches).

 **Caution:**

- ❑ When placing and scanning originals that are a mixture of different sizes, originals may be fed askew because not all of the originals are supported by the edge guides.
- ❑ Originals may be jammed or fed askew if you set different types or very different sizes of originals, such as in the following cases.
 - Thin paper and thick paper
 - A4 size paper and card size paper
 - Combinations of long, narrow paper that extend far beyond the input tray extension (example: long receipts and so on)
 - Combinations of folded or wrinkled paper

If originals are fed askew, check the scanned images. If the image is skewed, reduce the number of originals loaded and scan again.

Note:

- ❑ Alternatively, you can scan originals of different paper types and thickness by loading them one by one using **Automatic Feeding Mode**.

To use **Automatic Feeding Mode**, make the appropriate settings on the Epson Scan 2 screen.

When you are using Epson ScanSmart, you can open the Epson Scan 2 screen by clicking the **Settings** button > **Scanner Settings** tab > **Scan Settings**.

On the Epson Scan 2 screen, use **Automatic Feeding Mode** to scan while switching the position of the scanner according to the type of document.

1. Make sure that the scanner position icon is  (vertical path position).

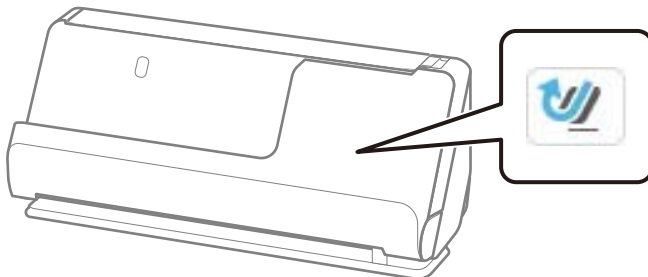

If  (straight path position) is displayed, pull the scanner position selector to tilt the scanner forward.

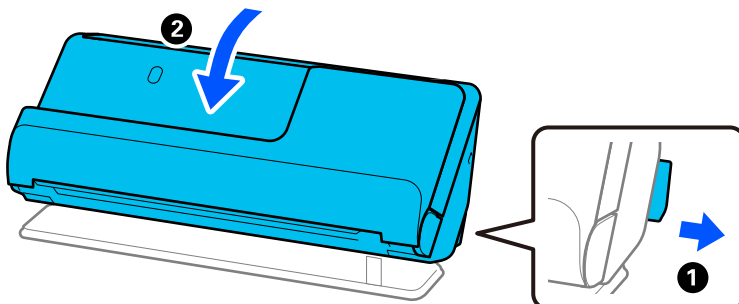

2. Open the input tray.

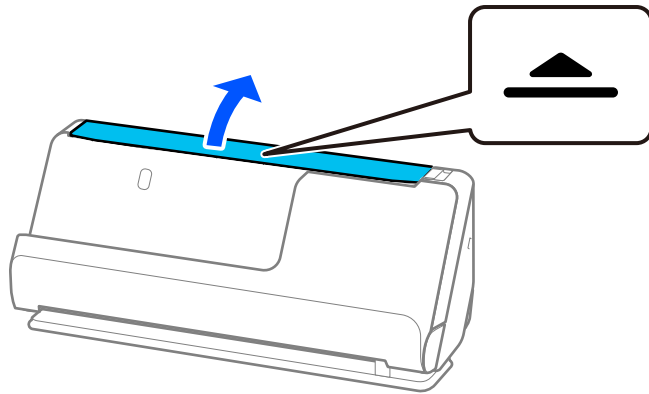

3. Raise the input tray extension.

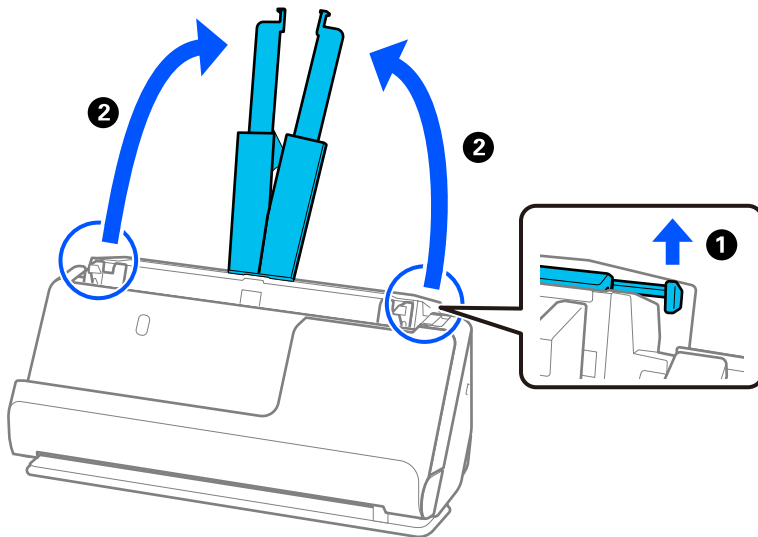

4. Move the edge guides to the edges of the input tray.

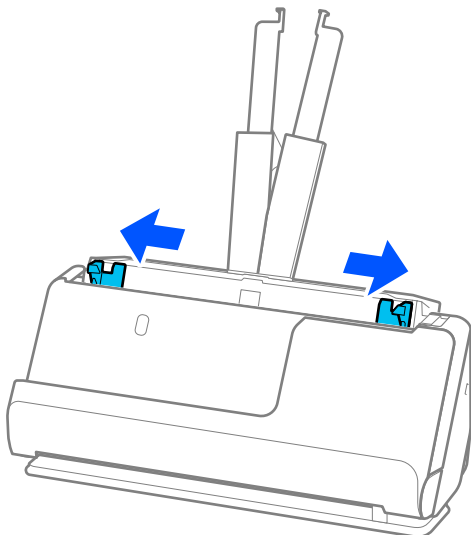

5. Load the originals with the side to be scanned facing up and in descending order of paper size with the widest at the back and the narrowest at the front of the input tray.

! **Important:**

Check the following points when setting different sizes of originals.

- Slide the originals with their leading edges aligned, until they meet resistance in the ADF.
- Set the originals at the center of the input tray. Refer to the ▲ mark on the scanner as your guide.
- Set the originals straight.

If not, originals may be fed askew or jammed.

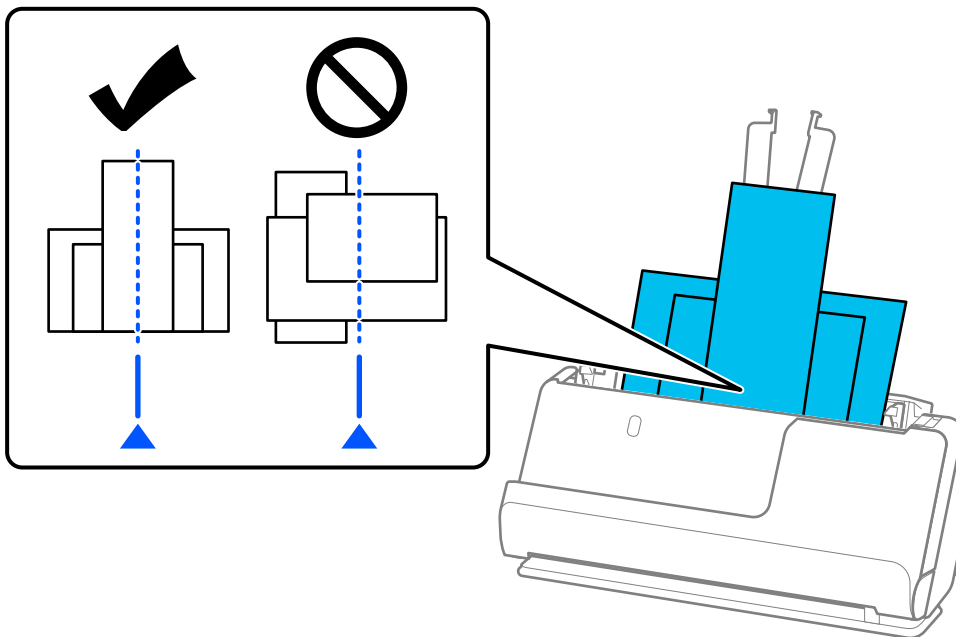

6. Align the edge guides with the widest original.

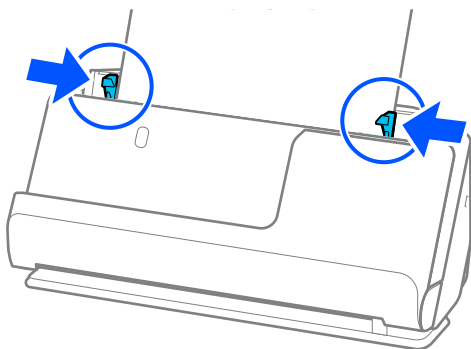

Note:

- If you cancel scanning in the middle of scanning a batch of originals, the second original will be fed a little bit into the ADF and then scanning stops. Open the scanner cover to remove it, and then load the page again together with the first page and the rest of the originals.
- Depending on the type of paper and the environment in which the scanner is being used, the original may fall from the front of the scanner after scanning. In this situation, load fewer originals into the scanner than the specified number of originals that can be loaded.

Related Information

➔ [“Scanning in Automatic Feeding Mode” on page 130](#)

Scanning

Preparing to Scan from the Control Panel (the Scan to Features).	99
Scanning from the Control Panel (the Scan to Features).	104
Scanning Using the Registered Contents in Presets.	125
Scanning from a Computer.	126
Scanning from a Smart Device.	134

Preparing to Scan from the Control Panel (the Scan to Features)

To Send by Email

Simply by operating the scanner's touch panel, you can send scanned images as email attachments without using a computer. You can use either of the following methods.

Method	Send easily using Epson's service	Send by setting up an email server
What do you want to do?	I want to send emails easily using simple settings.	<input type="checkbox"/> I want to send emails to multiple addresses at once. <input type="checkbox"/> I want to select the sender's email address.
Setup guide	"Scan to Cloud Feature Work Flow" on page 100 1. Register your scanner with <i>Epson Connect</i> [*] , an Epson service. 2. Add email addresses to the destination list.	"Scan to Email Feature Work Flow" on page 102 1. Check the email server information. 2. Register server addresses and other email server information to the scanner. 3. Register the email addresses to your Contacts (optional).

* Epson Connect is a service that allows you to use the Internet to connect to your scanners. By simply registering the scanner and user information, you can send scanned data to a specified email address or a third-party cloud service. Epson Connect services are subject to change without notice.

Differences in Available Features

Method	Send easily using Epson's service	Send by setting up an email server
Sender	Epson Connect send-only address (cannot be changed)	Set any address
Destination settings	Register in advance (Epson Connect destination list)	<input type="checkbox"/> Register in advance (Contacts on the scanner) <input type="checkbox"/> Enter the destination directly when scanning without registering in advance
Select multiple destinations	-	Available You can also register destinations as a group in Contacts.
Attachment name	-	Available (edit on the control panel)
Email subject	Available (edit by destination)	Available (edit on the control panel)
Email body	Available (edit by destination)	-
Maximum attachment size	-	Available (edit on the control panel)

Scan to Computer Feature Work Flow

This section explains how to save scanned images to a connected computer.

Necessary Operations	Operation Location	Explanations
<p>1. Install the software on your computer and connect the scanner to your computer</p> <p>(This is unnecessary if you installed the software connected during setup)</p>	Scanner and computer	<p>Perform the following operations using the installer.</p> <ul style="list-style-type: none"> <input type="checkbox"/> Install the necessary software on your computer <input type="checkbox"/> Connect the scanner to the computer <p>You can access the installer from the following website. Access the URL, and then enter the product name on the screen displayed. Go to Setup, and then start setting up.</p> <p>https://epson.sn</p>
2. Scan from the control panel	Scanner's control panel	<p>Perform scanning from the control panel.</p> <p>"Saving to a Computer" on page 104</p>

Scan to USB Drive Feature Work Flow

This section explains how to save scanned images to a USB drive connected to the scanner.

Necessary Operations	Operation Location	Explanations
1. Connect the USB drive to the scanner	Scanner	<p>Insert a USB drive into the scanner's external interface USB port.</p> <p>"Inserting a USB Drive" on page 26</p>
2. Scan from the control panel	Scanner's control panel	<p>Perform scanning from the control panel.</p> <p>"Saving to a USB Drive" on page 105</p>

Scan to Cloud Feature Work Flow

Use Epson's cloud service, *Epson Connect* to send scanned images to registered destinations.

- You can easily send scanned images by email by registering an email address as the destination.
- You can send scanned images to third-party online storage services (Evernote, Google Drive, Dropbox, and so on) by registering them as the destination. For details on how to register an account, see the website for each service. Available services are subject to change without notice.

Note:

For more details about *Epson Connect* services, visit the following portal website.

<https://www.epsonconnect.com/>

<http://www.epsonconnect.eu> (Europe only)

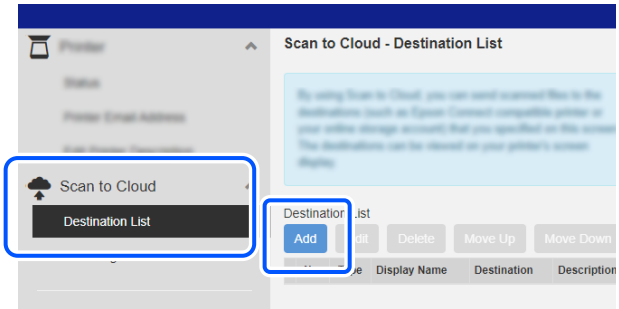
Necessary Operations	Operation Location	Explanations
<p>1. Connect the scanner to the network (This is unnecessary if you connected to the network during setup)</p>	<p>Scanner and computer</p>	<p>Connect the scanner to the network using the installer. Access the following website, and then enter the product name on the screen displayed. Go to Setup, and then start setting up.</p> <p>https://epson.sn</p> <p>When the connection method selection screen is displayed, select wireless LAN (Wi-Fi) and follow the on-screen instructions to connect to the network.</p> <p>Note:</p> <ul style="list-style-type: none"> <input type="checkbox"/> When you use the installer, the software is installed at the same time. <input type="checkbox"/> You can also set this manually. (for administrators) “Connecting the Scanner to the Network” on page 236
<p>2. Register the product with Epson Connect</p>	<p>Scanner’s control panel and computer (Epson Connect website)</p>	<p>Register your product with Epson Connect and enable the service.</p> <p>On the scanner’s control panel, select Settings > Web Service Settings > Epson Connect Services > Register, and then follow the on-screen instructions to register.</p> <p>Note: If you are prompted to enter a verification code, access the following URL and enter the code.</p> <p>https://www.epsonconnect.com/activation</p>
<p>3. Register a destination list on the Epson Connect user page</p>	<p>Computer (Epson Connect website)</p>	<p>Register the destinations you want to send to in the destination list on the Epson Connect user page.</p> <p>Access the user page from the following URL, click the Scan to Cloud > Destination List > Add*, and then follow the on-screen instructions to add a destination.</p> <p>https://www.epsonconnect.com/user</p>  <p>Note: When registering an email address, select Email Address as the destination type.</p>
<p>4. Scan from the control panel</p>	<p>Scanner’s control panel</p>	<p>Perform scanning from the control panel.</p> <p>“Sending to the Cloud” on page 109</p>

*Epson Connect services are subject to change without notice.

Scan to Email Feature Work Flow

There are two ways you can send scanned images to a specified email address; by setting up an email server or by using the Epson Connect cloud service.

[“To Send by Email” on page 99](#)

The following explains how to setup an email server to send scanned images by email.

Necessary Operations	Operation Location	Explanations
1. Connect the scanner to the network (This is unnecessary if you connected to the network during setup)	Scanner and computer	Connect the scanner to the network using the installer. Access the following website, and then enter the product name on the screen displayed. Go to Setup , and then start setting up. https://epson.sn When the connection method selection screen is displayed, select wireless LAN (Wi-Fi) and follow the on-screen instructions to connect to the network. Note: <input type="checkbox"/> When you use the installer, the software is installed at the same time. <input type="checkbox"/> You can also set this manually. (for administrators) “Connecting the Scanner to the Network” on page 236
2. Register your email server information to the scanner	Computer (Web Config) or the scanner’s control panel	The Scan to Email feature allows you to send scanned images through an email server. Register the email server information to the scanner. “Registering an Email Server” on page 146
3. Check the email server connection	Computer (Web Config) or the scanner’s control panel	Test the email server connection. “Checking an Email Server Connection” on page 148
4. Register the recipient's email address in Contacts	Computer (Web Config) or the scanner’s control panel	Register the recipient's email address in the scanner's Contacts . This allows you to select the recipient from Contacts without having to enter their email address when scanning. “Registering a Destination (Email)” on page 150
5. Scan from the control panel	Scanner’s control panel	Perform scanning from the control panel. “Scanning Originals to an Email” on page 113

Scan to Network Folder/FTP Feature Work Flow

This section uses making settings for Network Folder (SMB) as an example.

Necessary Operations	Operation Location	Explanations
<p>1. Connect the scanner to the network (This is unnecessary if you connected to the network during setup)</p>	<p>Scanner and computer</p>	<p>Connect the scanner to the network using the installer. Access the following website, and then enter the product name on the screen displayed. Go to Setup, and then start setting up.</p> <p>https://epson.sn</p> <p>When the connection method selection screen is displayed, select wireless LAN (Wi-Fi) and follow the on-screen instructions to connect to the network.</p> <p>Note:</p> <ul style="list-style-type: none"> <input type="checkbox"/> When you use the installer, the software is installed at the same time. <input type="checkbox"/> You can also set this manually. (for administrators) <i>“Connecting the Scanner to the Network” on page 236</i>
<p>2. Create a network folder</p>	<p>Computer</p>	<p>Create a folder to save the scanned image. Create a folder on a computer on your network, and then set the folder to be shared.</p> <p><i>“Creating a Network Folder” on page 140</i></p>
<p>3. Register the folder in Contacts</p>	<p>Computer (Web Config) or the scanner’s control panel</p>	<p>Register the created network folder in the scanner’s Contacts. This allows you to select the destination from Contacts without having to enter the destination folder path when scanning.</p> <p><i>“Registering a Destination (Network Folder (SMB))” on page 151</i></p> <p>Note: See the following for FTP and SharePoint (WebDAV) setting items.</p> <p><i>“Registering a Destination (FTP)” on page 152</i></p> <p><i>“Registering a Destination (SharePoint(WebDAV))” on page 153</i></p>
<p>4. Scan from the control panel</p>	<p>Scanner’s control panel</p>	<p>Perform scanning from the control panel.</p> <p><i>“Saving to a Network Folder” on page 117</i></p>

Scan to WSD Work Flow

Necessary Operations	Operation Location	Explanations
<p>1. Connect the scanner and the computer to the network</p> <p>(This is unnecessary if you connected to the network during setup)</p>	Scanner and computer	<p>Connect the scanner to the network using the installer. Access the following website, and then enter the product name on the screen displayed. Go to Setup, and then start setting up.</p> <p>https://epson.sn</p> <p>When the connection method selection screen is displayed, select wireless LAN (Wi-Fi) and follow the on-screen instructions to connect to the network.</p> <p>Note:</p> <ul style="list-style-type: none"> <input type="checkbox"/> When you use the installer, the software is installed at the same time. <input type="checkbox"/> You can also set this manually. (for administrators) <p>“Connecting the Scanner to the Network” on page 236</p>
<p>2. Scan from the control panel</p>	Scanner’s control panel	<p>Perform scanning from the control panel.</p> <p>“Scanning Using WSD” on page 122</p> <p>Note:</p> <p>If the destination computer is not displayed, follow the steps below to add a WSD scanning device.</p> <p>“Adding a WSD Scan Device” on page 122</p>

Scanning from the Control Panel (the Scan to Features)

Saving to a Computer

Saves the scanned image to a computer connected to the scanner.

You need to make settings in advance. See the following link for details on the work flow for making settings.

[“Scan to Computer Feature Work Flow” on page 100](#)

1. Place the original.
Example: For standard paper
[“Placing Standard Size Originals” on page 55](#)
2. Select **Computer** on the home screen on the control panel.
3. Select the computer to which you want to save the scanned images.
4. Select the scanning side from **1-Sided** or **2-Sided**.

5. Select , check the **Scanner Settings**, and then change them if necessary.

You can change the settings such as **Paper Protection**.

6. Tap .

Epson ScanSmart starts on your computer, and scanning starts. When scanning is complete, follow the instructions in Epson ScanSmart to save the image.

Saving to a USB Drive

You can save the scanned image to a USB drive.

1. Place the original.

Example: For standard paper

[“Placing Standard Size Originals” on page 55](#)

2. Insert a USB drive into the scanner's external interface USB port.

[“Inserting a USB Drive” on page 26](#)

3. Select **USB Drive** on the home screen on the control panel.

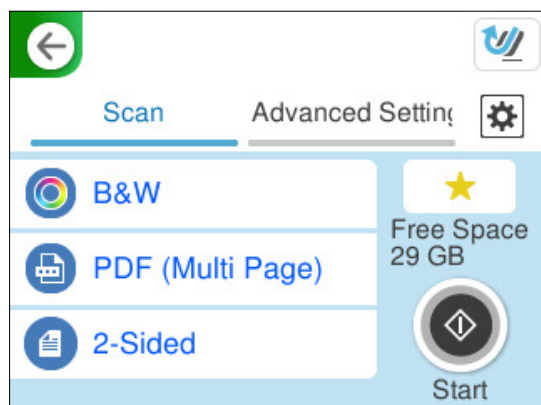

4. Set items on **Scan** tab, such as the save format.

[“Setting Items for Scanning to a USB Drive” on page 106](#)

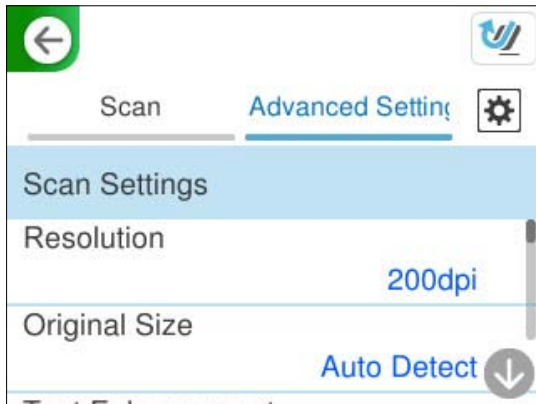

5. Select the **Advanced Settings** tab, check the settings, and then change them if necessary.
[“Advanced Menu Options for Scanning to a USB Drive” on page 107](#)



6. Select , check the **Scanner Settings**, and then change them if necessary.
You can change the settings such as **Paper Protection**.
7. Select the **Scan** tab again, and then tap .

Note:

Select  to save your settings as a preset.

Scanned images are saved in the destination USB drive.

Setting Items for Scanning to a USB Drive

Note:

Some items may not be available depending on other settings you made.

Image Type:

Select the color of the output image.

When you select the following, the scanner detects the color of the originals automatically and saves the images using the detected colors.

Color/Grayscale/B&W

Converts the scanned image into 24-bit color, 8-bit gray, or monochrome (black and white binary). When this is selected, set the sensitivity to determine whether the original is grayscale or monochrome when scanning a non-color original.

Color/Black & White:

Converts the scanned image into 24-bit color or monochrome (black and white binary).

Color/Grayscale:

Converts the scanned image into 24-bit color or 8-bit gray.

The available image types may vary depending on the File Format you selected. See the following for more details.

[“Combinations for Available File Format and Image Type” on page 123](#)

File Format:

Select the format in which to save the scanned image.

When you want to save as PDF, PDF/A, or TIFF, select whether to save all originals as one file (multi-page) or save each original separately (single page).

Compression Ratio:

Select how much to compress the scanned image.

PDF Settings:

When you have selected PDF as the save format setting, use these settings to protect PDF files.

To create a PDF file that requires a password when opening, set Document Open Password. To create a PDF file that requires a password when printing or editing, set Permissions Password.

Scanning Side:

Select the side of the original you want to scan.

Binding(Original):

Select the binding direction of the original.

Advanced Menu Options for Scanning to a USB Drive

Note:

The items may not be available depending on other settings you made.

Resolution:

Select the scanning resolution.

See the following for details on the file resolutions that can be selected.

[“Available Resolutions” on page 125](#)

Original Size:

Select the size of the original you placed.

Crop Margins for Size "Auto":

Adjust the cropping area when selecting **Auto Detect**.

Scan laminated card:

For laminated originals, transparent areas around the edges are also scanned.

Note:

The appropriate effects may not be achieved depending on the original.

Text Enhancement:

You can make blurred letters in the original clear and sharp. You can also reduce the offset or unevenness of the background.

Emphasize light letters / Remove background:

You can set the level of correction between text and background. When you move the slider closer to **Emphasize light letters**, the light letters in the scanned image are emphasized. When you move the slider closer to **Remove background**, the background color, pattern, wrinkles, or offset in the scanned image is removed.

Remove spot noise:

You can remove black dots in the background of the original that cannot be removed by lightening the background. You can adjust the level of the effect.

Note:

When you select this feature, it may also remove small dots as well as the black dots in the background.

Rotation:

Rotate the scanned image clockwise. Select the rotation angle depending on the original you want to scan.

Density:

Select the contrast of the scanned image.

Remove Background:

Remove the background color of the originals from the scanned image.

To use this feature, the background color of the originals should be the lightest color in the originals, and should be uniform. This feature is not applied correctly if there are patterns in the background, or there are text or illustrations which are a lighter color than the background.

Remove Shadow:

Remove the shadows of the original that appear in the scanned image.

Frame:

Remove the shadows at the edge of the original.

Correct Document Skew:

Correct skew in the scanned image.

This feature may not be able to correct documents that have been over skewed.

Skip Blank Pages:

Skip blank pages when scanning if there are any in the originals.

If the result is not what you expected, adjust detection level.

Note:

Some pages may be incorrectly skipped as blank pages.

This feature is not available when scanning double-sided originals that are stitched.

Automatic Feeding Mode:

Set Automatic Feeding Mode. This feature allows you to continue scanning automatically after the originals are scanned. This feature is useful when scanning different sizes or types of originals one by one.

Adjust the edge guides of the scanner before placing each original.

On (Full-Auto):

Start scanning when an original is set while the continuation confirmation message is displayed.

On (Semi-Auto):

Start scanning when the **Start Scanning** button is pressed while the continuation confirmation message is displayed.

Detect Double Feed:

Display a warning when multiple originals are fed at the same time.

Length:

Detect a double feed by the length. When the length of the second original scanned is different from the first, this is identified as a double feed. You can specify the difference in length for detection.

File Name:

Filename Prefix:

Enter a prefix for the name of the images in alphanumeric characters and symbols.

Add Date:

Add the date to the file name.

Add Time:

Add the time to the file name.

Clear All Settings

Resets the scan settings to their defaults.

Sending to the Cloud

Send scanned images to destinations registered in *Epson Connect*.

You need to make settings in advance. See the following link for details on the work flow for making settings.

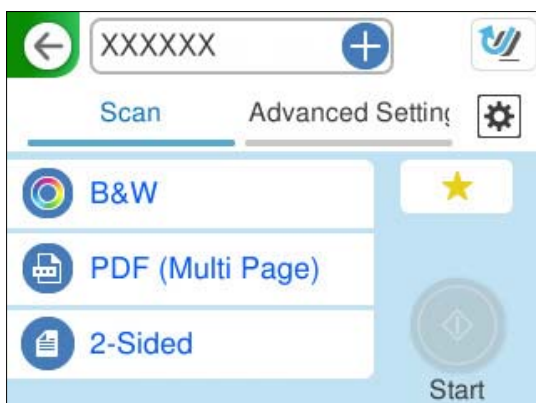

[“Scan to Cloud Feature Work Flow” on page 100](#)

1. Place the original.
Example: For standard paper
[“Placing Standard Size Originals” on page 55](#)
2. Select **Cloud** on the home screen on the control panel.
3. Select **+** on the top of the screen, and then select a destination.
4. Set items on **Scan** tab, such as the save format.
[“Cloud Storage Scan Setting Items” on page 110](#)

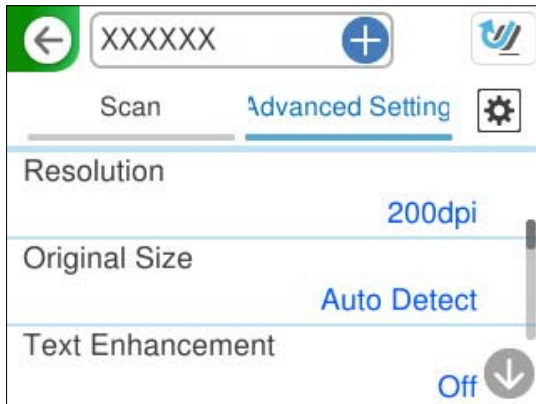

5. Select the **Advanced Settings** tab, check the settings, and then change them if necessary.
[“Advanced Menu Options for Scanning to the Cloud” on page 111](#)



6. Select , check the **Scanner Settings**, and then change them if necessary.
You can change the settings such as **Paper Protection**.
7. Select the **Scan** tab again, and then tap .

Note:

Select  to save your settings as a preset.

Scanned images are sent to the registered destination.

Cloud Storage Scan Setting Items

Image Type:

Select the color of the output image.

When you select the following, the scanner detects the color of the originals automatically and saves the images using the detected colors.

- Color/Grayscale:

Converts the scanned image into 24-bit color or 8-bit gray.

The available image types may vary depending on the File Format you selected. See the following for more details.

[“Combinations for Available File Format and Image Type” on page 123](#)

File Format:

Select the format in which to save the scanned image.

When you want to save as PDF, select whether to save all originals as one file (multi-page) or save each original separately (single page).

- Compression Ratio:

Select how much to compress the scanned image.

Scanning Side:

Select the side of the original you want to scan.

Binding(Original):

Select the binding direction of the original.

Advanced Menu Options for Scanning to the Cloud

Note:

The items may not be available depending on other settings you made.

Resolution:

Select the scanning resolution.

See the following for details on the file resolutions that can be selected.

[“Available Resolutions” on page 125](#)

Original Size:

Select the size of the original you placed.

Crop Margins for Size "Auto":

Adjust the cropping area when selecting **Auto Detect**.

Scan laminated card:

For laminated originals, transparent areas around the edges are also scanned.

Note:

The appropriate effects may not be achieved depending on the original.

Text Enhancement:

You can make blurred letters in the original clear and sharp. You can also reduce the offset or unevenness of the background.

Emphasize light letters / Remove background:

You can set the level of correction between text and background. When you move the slider closer to **Emphasize light letters**, the light letters in the scanned image are emphasized. When you move the slider closer to **Remove background**, the background color, pattern, wrinkles, or offset in the scanned image is removed.

Remove spot noise:

You can remove black dots in the background of the original that cannot be removed by lightening the background. You can adjust the level of the effect.

Note:

When you select this feature, it may also remove small dots as well as the black dots in the background.

Rotation:

Rotate the scanned image clockwise. Select the rotation angle depending on the original you want to scan.

Density:

Select the contrast of the scanned image.

Remove Background:

Remove the background color of the originals from the scanned image.

To use this feature, the background color of the originals should be the lightest color in the originals, and should be uniform. This feature is not applied correctly if there are patterns in the background, or there are text or illustrations which are a lighter color than the background.

Remove Shadow:

Remove the shadows of the original that appear in the scanned image.

Frame:

Remove the shadows at the edge of the original.

Correct Document Skew:

Correct skew in the scanned image.

This feature may not be able to correct documents that have been over skewed.

Skip Blank Pages:

Skip blank pages when scanning if there are any in the originals.

If the result is not what you expected, adjust detection level.

Note:

Some pages may be incorrectly skipped as blank pages.

This feature is not available when scanning double-sided originals that are stitched.

Automatic Feeding Mode:

Set Automatic Feeding Mode. This feature allows you to continue scanning automatically after the originals are scanned. This feature is useful when scanning different sizes or types of originals one by one.

Adjust the edge guides of the scanner before placing each original.

On (Full-Auto):

Start scanning when an original is set while the continuation confirmation message is displayed.

On (Semi-Auto):

Start scanning when the **Start Scanning** button is pressed while the continuation confirmation message is displayed.

Detect Double Feed:

Display a warning when multiple originals are fed at the same time.

Length:

Detect a double feed by the length. When the length of the second original scanned is different from the first, this is identified as a double feed. You can specify the difference in length for detection.

Clear All Settings

Resets the scan settings to their defaults.

Scanning Originals to an Email

There are two ways you can send scanned images to a specified email address. See the following for more information on the two methods.

[“To Send by Email” on page 99](#)

You need to make settings in advance to perform scanning. See the following link for details on the work flow for making settings.

[“Scan to Email Feature Work Flow” on page 102](#)

The following explains how to scan using an email server.

Note:

*Before scanning, make sure the scanner’s **Date/Time** and **Time Difference** settings are correct. The set time is displayed at the bottom-right corner of the Home screen on the control panel.*

*If you need to make changes, select **Settings** > **Basic Settings** > **Date/Time Settings** on the control panel.*

1. Place the original.
Example: For standard paper
[“Placing Standard Size Originals” on page 55](#)
2. Select **Email** on the home screen on the control panel.
3. Specify the destination on the **Recipient** tab.

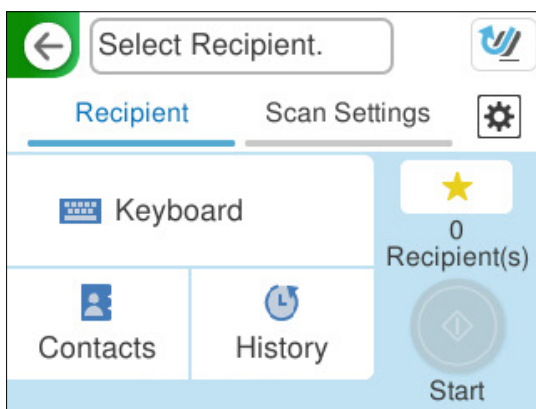

- To enter by keyboard: Select **Keyboard**, type in the destination, and then select **OK**.
- To select from the contacts list: Select **Contacts**, select a contact, and then select **Done**.
You can also search for registered addresses in the search box at the top of the Contacts screen.
- To select from the history list: Select **History**, select a contact, and then select **Done**.

Note:



- The number of recipients you selected is displayed on the right of the screen. You can send emails to up to 10 addresses and groups.*

If groups is included in recipients, you can select up to 200 individual addresses in total, taking addresses in the groups into account.

- Select the address box at the top of the screen to display the list of selected addresses.*

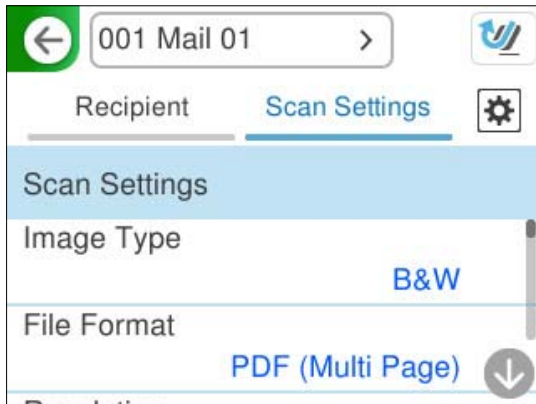
4. Select **Scan Settings**, check settings such as the save format, and then change them if necessary.
“Scan Menu Options for Scanning to an Email” on page 114



5. Select , check the **Scanner Settings**, and then change them if necessary.
You can change the settings such as **Paper Protection**.
6. Select the **Recipient** tab again, and then tap .

Note:

Select  to save your settings as a preset.

The scanned image is sent to the recipient's email address.

Scan Menu Options for Scanning to an Email

Note:

The items may not be available depending on other settings you made.

Image Type:

Select the color of the output image.

When you select the following, the scanner detects the color of the originals automatically and saves the images using the detected colors.

Color/Grayscale/B&W

Converts the scanned image into 24-bit color, 8-bit gray, or monochrome (black and white binary). When this is selected, set the sensitivity to determine whether the original is grayscale or monochrome when scanning a non-color original.

Color/Black & White:

Converts the scanned image into 24-bit color or monochrome (black and white binary).

Color/Grayscale:

Converts the scanned image into 24-bit color or 8-bit gray.

The available image types may vary depending on the File Format you selected. See the following for more details.

“Combinations for Available File Format and Image Type” on page 123

File Format:

Select the format in which to save the scanned image.

When you want to save as PDF, PDF/A, or TIFF, select whether to save all originals as one file (multi-page) or save each original separately (single page).

Compression Ratio:

Select how much to compress the scanned image.

PDF Settings:

When you have selected PDF as the save format setting, use these settings to protect PDF files.

To create a PDF file that requires a password when opening, set Document Open Password. To create a PDF file that requires a password when printing or editing, set Permissions Password.

Resolution:

Select the scanning resolution.

See the following for details on the file resolutions that can be selected.

[“Available Resolutions” on page 125](#)

Scanning Side:

Select the side of the original you want to scan.

Binding(Original):

Select the binding direction of the original.

Original Size:

Select the size of the original you placed.

Crop Margins for Size "Auto":

Adjust the cropping area when selecting **Auto Detect**.

Scan laminated card:

For laminated originals, transparent areas around the edges are also scanned.

Note:

The appropriate effects may not be achieved depending on the original.

Text Enhancement:

You can make blurred letters in the original clear and sharp. You can also reduce the offset or unevenness of the background.

Emphasize light letters / Remove background:

You can set the level of correction between text and background. When you move the slider closer to **Emphasize light letters**, the light letters in the scanned image are emphasized. When you move the slider closer to **Remove background**, the background color, pattern, wrinkles, or offset in the scanned image is removed.

Remove spot noise:

You can remove black dots in the background of the original that cannot be removed by lightening the background. You can adjust the level of the effect.

Note:

When you select this feature, it may also remove small dots as well as the black dots in the background.

Rotation:

Rotate the scanned image clockwise. Select the rotation angle depending on the original you want to scan.

Density:

Select the contrast of the scanned image.

Remove Background:

Remove the background color of the originals from the scanned image.

To use this feature, the background color of the originals should be the lightest color in the originals, and should be uniform. This feature is not applied correctly if there are patterns in the background, or there are text or illustrations which are a lighter color than the background.

Remove Shadow:

Remove the shadows of the original that appear in the scanned image.

Frame:

Remove the shadows at the edge of the original.

Correct Document Skew:

Correct skew in the scanned image.

This feature may not be able to correct documents that have been over skewed.

Skip Blank Pages:

Skip blank pages when scanning if there are any in the originals.

If the result is not what you expected, adjust detection level.

Note:

Some pages may be incorrectly skipped as blank pages.

This feature is not available when scanning double-sided originals that are stitched.

Automatic Feeding Mode:

Set Automatic Feeding Mode. This feature allows you to continue scanning automatically after the originals are scanned. This feature is useful when scanning different sizes or types of originals one by one.

Adjust the edge guides of the scanner before placing each original.

On (Full-Auto):

Start scanning when an original is set while the continuation confirmation message is displayed.

On (Semi-Auto):

Start scanning when the **Start Scanning** button is pressed while the continuation confirmation message is displayed.

Detect Double Feed:

Display a warning when multiple originals are fed at the same time.

Length:

Detect a double feed by the length. When the length of the second original scanned is different from the first, this is identified as a double feed. You can specify the difference in length for detection.

Subject:

Enter a subject for the email in alphanumeric characters and symbols.

Attached File Max Size:

Select the maximum file size that can be attached to the email.

See the following for details on the file sizes that can be saved.

[“File Sizes that can be Saved” on page 125](#)

File Name:

Filename Prefix:

Enter a prefix for the name of the images in alphanumeric characters and symbols.

Add Date:

Add the date to the file name.

Add Time:

Add the time to the file name.

Clear All Settings

Resets the scan settings to their defaults.

Saving to a Network Folder

Save the scanned image to a specified folder on a network.

You need to make settings in advance. See the following link for details on the work flow for making settings.

[“Scan to Network Folder/FTP Feature Work Flow” on page 102](#)

Note:

*Before scanning, make sure the scanner’s **Date/Time** and **Time Difference** settings are correct.*

*If you need to make changes, select **Settings** > **Basic Settings** > **Date/Time Settings** on the control panel.*

1. Place the original.

Example: For standard paper

[“Placing Standard Size Originals” on page 55](#)

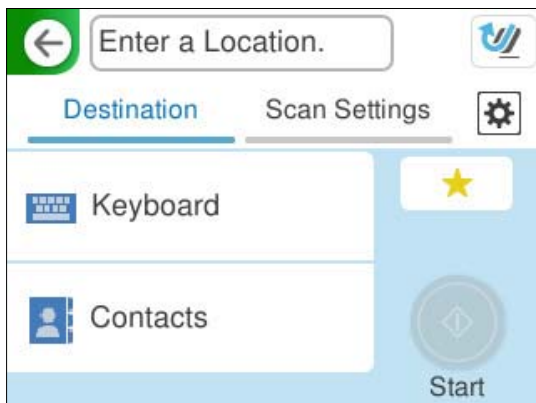

2. Select **Network Folder/FTP** on the home screen on the control panel.

3. Specify the destination on the **Destination** tab.

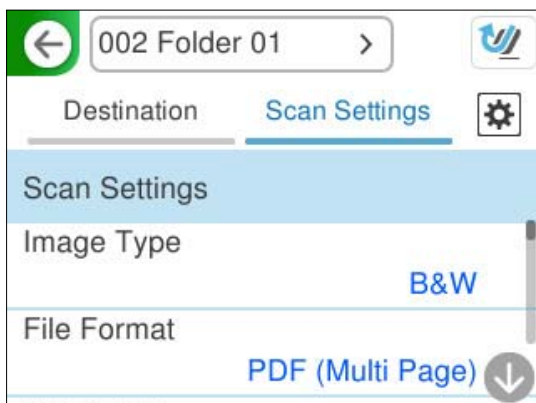

- To enter by keyboard: Select **Keyboard**. See the following for the setting items for the destination.
“Setting Items for Editing the Destination” on page 119
 - To select from the contacts list: Select **Contacts**, select a contact, and then select **Done**.
You can also search for registered folders in the search box at the top of the Contacts screen.
4. Select the **Scan Settings** tab, check settings such as the save format, and then change them if necessary.
“Scan Menu Options for Scanning to a Folder” on page 119



5. Select , check the **Scanner Settings**, and then change them if necessary.
You can change the settings such as **Paper Protection**.
6. Select the **Destination** tab again, and then tap .

Note:

Select  to save your settings as a preset.

Scanned images are saved in the destination network folder.

Setting Items for Editing the Destination

Communication Mode:

Select the communication mode for the folder.

Location (Required):

Enter the network path for the destination folder in an appropriate format for the Communication Mode selected.

- Network Folder (SMB): \\host name (computer name)\folder name
- FTP: ftp://host name (server name)/folder name
- FTPS: ftps://host name (server name)/folder name
- WebDAV (HTTPS): https://host name/folder name
- WebDAV (HTTP): http://host name/folder name

Note:

Scanning to Network Folder/FTP from the scanner's control panel does not support SharePoint Online.

User Name:

Enter the login user name for the computer on which the destination folder was created.

Password:

Enter the login password for the computer on which the destination folder was created.

Connection Mode:

Select the connection mode for the folder.

Port Number:

Enter a port number for the folder.

Proxy Server Settings:

Select whether or not to use a proxy server.

Scan Menu Options for Scanning to a Folder

Note:

The items may not be available depending on other settings you made.

Image Type:

Select the color of the output image.

When you select the following, the scanner detects the color of the originals automatically and saves the images using the detected colors.

- Color/Grayscale/B&W

Converts the scanned image into 24-bit color, 8-bit gray, or monochrome (black and white binary). When this is selected, set the sensitivity to determine whether the original is grayscale or monochrome when scanning a non-color original.

Color/Black & White:

Converts the scanned image into 24-bit color or monochrome (black and white binary).

Color/Grayscale:

Converts the scanned image into 24-bit color or 8-bit gray.

The available image types may vary depending on the File Format you selected. See the following for more details.

[“Combinations for Available File Format and Image Type” on page 123](#)

File Format:

Select the format in which to save the scanned image.

When you want to save as PDF, PDF/A, or TIFF, select whether to save all originals as one file (multi-page) or save each original separately (single page).

Compression Ratio:

Select how much to compress the scanned image.

PDF Settings:

When you have selected PDF as the save format setting, use these settings to protect PDF files.

To create a PDF file that requires a password when opening, set Document Open Password. To create a PDF file that requires a password when printing or editing, set Permissions Password.

Resolution:

Select the scanning resolution.

See the following for details on the file resolutions that can be selected.

[“Available Resolutions” on page 125](#)

Scanning Side:

Select the side of the original you want to scan.

Binding(Original):

Select the binding direction of the original.

Original Size:

Select the size of the original you placed.

Crop Margins for Size "Auto":

Adjust the cropping area when selecting **Auto Detect**.

Scan laminated card:

For laminated originals, transparent areas around the edges are also scanned.

Note:

The appropriate effects may not be achieved depending on the original.

Text Enhancement:

You can make blurred letters in the original clear and sharp. You can also reduce the offset or unevenness of the background.

Emphasize light letters / Remove background:

You can set the level of correction between text and background. When you move the slider closer to **Emphasize light letters**, the light letters in the scanned image are emphasized. When you move the slider closer to **Remove background**, the background color, pattern, wrinkles, or offset in the scanned image is removed.

Remove spot noise:

You can remove black dots in the background of the original that cannot be removed by lightening the background. You can adjust the level of the effect.

Note:

When you select this feature, it may also remove small dots as well as the black dots in the background.

Rotation:

Rotate the scanned image clockwise. Select the rotation angle depending on the original you want to scan.

Density:

Select the contrast of the scanned image.

Remove Background:

Remove the background color of the originals from the scanned image.

To use this feature, the background color of the originals should be the lightest color in the originals, and should be uniform. This feature is not applied correctly if there are patterns in the background, or there are text or illustrations which are a lighter color than the background.

Remove Shadow:

Remove the shadows of the original that appear in the scanned image.

Frame:

Remove the shadows at the edge of the original.

Correct Document Skew:

Correct skew in the scanned image.

This feature may not be able to correct documents that have been over skewed.

Skip Blank Pages:

Skip blank pages when scanning if there are any in the originals.

If the result is not what you expected, adjust detection level.

Note:

Some pages may be incorrectly skipped as blank pages.

This feature is not available when scanning double-sided originals that are stitched.

Automatic Feeding Mode:

Set Automatic Feeding Mode. This feature allows you to continue scanning automatically after the originals are scanned. This feature is useful when scanning different sizes or types of originals one by one.

Adjust the edge guides of the scanner before placing each original.

On (Full-Auto):

Start scanning when an original is set while the continuation confirmation message is displayed.

On (Semi-Auto):

Start scanning when the **Start Scanning** button is pressed while the continuation confirmation message is displayed.

Detect Double Feed:

Display a warning when multiple originals are fed at the same time.

Length:

Detect a double feed by the length. When the length of the second original scanned is different from the first, this is identified as a double feed. You can specify the difference in length for detection.

File Name:

Filename Prefix:

Enter a prefix for the name of the images in alphanumeric characters and symbols.

Add Date:

Add the date to the file name.

Add Time:

Add the time to the file name.

Clear All Settings

Resets the scan settings to their defaults.

Scanning Using WSD

Note:

This feature is only available for computers running Windows Vista or later.

If a destination computer is not displayed, follow the steps below to add a WSD scan device.

[“Adding a WSD Scan Device” on page 122](#)

1. Place the originals.
2. Select **WSD** on the home screen of the scanner’s control panel.
3. Select a destination.
4. Tap .
5. Follow the on-screen instructions when the **WSD Scan Device** screen is displayed on your computer.

Adding a WSD Scan Device

Depending on your environment, you may need to add a WSD scan device on your computer.

The following procedure is an example for Windows 10. The procedure may differ depending on your environment.

1. Display the device list.
Click the start button, and then select **Settings > Devices > Printers & scanners**.
2. Click **Add a printer or scanner**.
3. Select your scanner, and then click **Add device**.

Note:

If you do not know the device name of your scanner, you can check the name on the scanner's control panel.

*Select **Settings > Network Settings > Network Status** on the scanner's control panel, and then select the active connection method status to check the **Device Name**.*

The procedure is complete when the scanner is added to the list.

Note:

*You can change the WSD scan event. Click the scanner you added, and then click **Manage > Scanner properties > Properties > Events**.*

You can add a WSD scan device from the Windows Control Panel.

*Select **Control Panel > Hardware and Sound > View devices and printers**, and then click **Add a device**.*

Combination of Features and Settings

Combinations for Available File Format and Image Type

You can select the following image types according to the feature being used and the File Format in which they will be saved.

Scan to Computer Feature

Depends on the Epson ScanSmart settings.

Scan to USB Drive Feature, Scan to Network Folder/FTP Feature

✓ : Can be selected. - : Cannot be selected.

Image Type	File Format			
	JPEG	PDF (Single Page) PDF (Multi Page) PDF/A (Single Page) PDF/A (Multi Page)	TIFF (Single Page)	TIFF (Multi Page)
Color	✓	✓	✓	-
B&W	-	✓	✓	✓
Gray	✓	✓	✓	-
Color/ Grayscale/B&W	-	✓	✓	-
Color/Black & White	-	✓	✓	-

Image Type	File Format			
	JPEG	PDF (Single Page) PDF (Multi Page) PDF/A (Single Page) PDF/A (Multi Page)	TIFF (Single Page)	TIFF (Multi Page)
Color/Grayscale	✓	✓	✓	-

Scan to Cloud Feature

✓ : Can be selected. - : Cannot be selected.

Image Type	File Format			
	JPEG	PDF (Single Page) PDF (Multi Page)	TIFF (Single Page)	TIFF (Multi Page)
Color	✓	✓	-	-
B&W	-	✓	-	-
Gray	✓	✓	-	-
Color/ Grayscale/B&W	-	-	-	-
Color/Black & White	-	-	-	-
Color/Grayscale	✓	✓	-	-

Scan to Email Feature

✓ : Can be selected. - : Cannot be selected.

Image Type	File Format			
	JPEG	PDF (Single Page) PDF (Multi Page) PDF/A (Single Page) PDF/A (Multi Page)	TIFF (Single Page)	TIFF (Multi Page)
Color	✓	✓	-	-
B&W	-	✓	✓	✓
Gray	✓	✓	-	-
Color/ Grayscale/B&W	-	✓	-	-
Color/Black & White	-	✓	-	-
Color/Grayscale	✓	✓	-	-

File Sizes that can be Saved

The following file sizes can be saved.

Features	Maximum Capacity
Scan to Computer Feature	Depends on the amount of free space in the destination.
Scan to USB Drive Feature	Depends on the amount of free space in the destination. "USB Drive Specifications" on page 283
Scan to Cloud Feature	Depends on the amount of free storage space in the online service, or the maximum attachment file size that can be received by the email server.
Scan to Email Feature	Depends on the amount of free space in the destination server. You can set the maximum size for files attached to emails from 1 MB/2 MB/5 MB/10 MB/20 MB/30 MB.
Scan to Network Folder/FTP Feature	Depends on the amount of free space in the destination.

Available Resolutions

Depending on the feature being used, the following resolutions are available.



Scan to Computer depends on the Epson ScanSmart settings.

✓ : Can be selected. - : Cannot be selected.

Features	Available Resolutions		
	200 dpi	300 dpi	600 dpi
Scan to USB Drive Feature	✓	✓	✓
Scan to Cloud Feature	✓	✓	-
Scan to Email Feature	✓	✓	✓
Scan to Network Folder/FTP Feature	✓	✓	✓

Scanning Using the Registered Contents in Presets

Scan using the contents registered in advance to your **Presets**.

- Use one of the following methods to load the **Presets**.
 - Select  on the Home screen on the control panel, and then select the registered preset from the list.
 - Select  on the Scan menu screen, select **Load Presets**, and then select the registered preset from the list.

Note:

If you have enabled **Quick Send**, scanning starts in immediately and the rest of the steps are skipped.

2. The name of the loaded preset is displayed. Check the name, and then select **Close**.
3. Check the preset destinations and scan settings.
4. Tap .

Related Information

➔ [“Registering Presets” on page 32](#)

Scanning from a Computer

Scanning Using Epson ScanSmart

Use the scanning application Epson ScanSmart to scan.

This application allows you to scan documents easily, and then save the scanned images in simple steps. See the Epson ScanSmart help for details on how to use the application. This section explains how to scan and save to a PDF file as a basic step.

1. Place the originals on your scanner.
2. Start Epson ScanSmart.
 - Windows 11
Click the start button, and then select **All apps > Epson Software > Epson ScanSmart**.
 - Windows 10
Click the start button, and then select **Epson Software > Epson ScanSmart**.
 - Windows 8.1/Windows 8
Enter the application name in the search charm, and then select the displayed icon.
 - Windows 7
Click the start button, and then select **All Programs > Epson Software > Epson ScanSmart**.
 - Mac OS
Open the **Applications** folder and select **Epson ScanSmart**.

3. Click **Scan double-sided** or **Scan single-sided**.

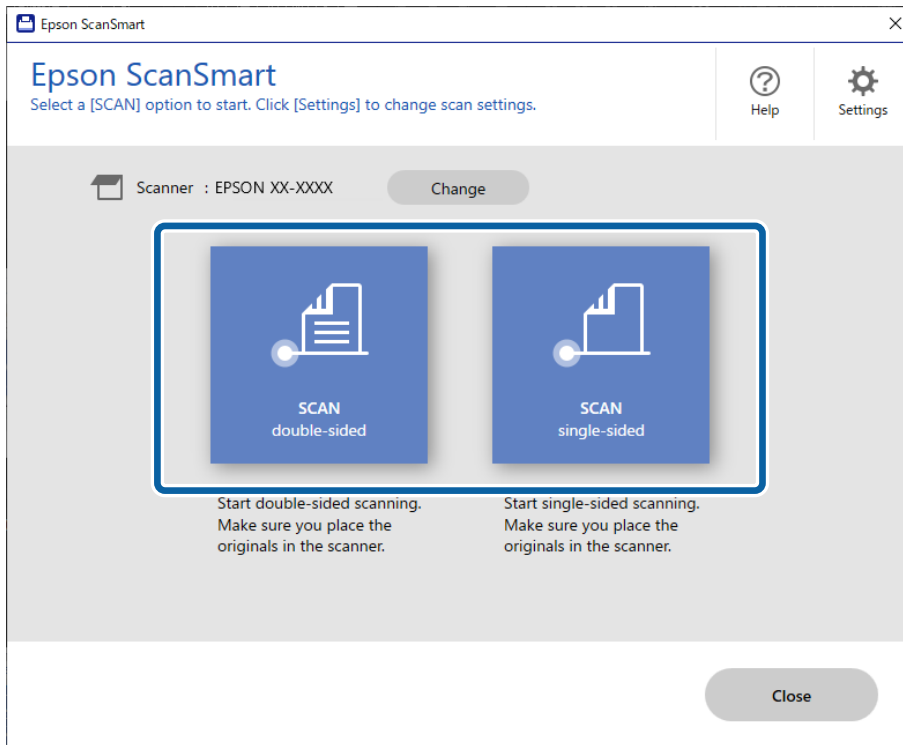

Scanning starts automatically.

4. Check the scanned images, and organize them if necessary.

- 1 You can add originals and scan them by clicking **Scan**.
- 2 You can use the buttons at the top of the screen to edit scanned images.
- 3 You can choose to keep or discard the back sides of double-sided scanned images from **Include back sides**.
- 4 If you do not want to check scanned images each time, select **Skip this screen next time**.

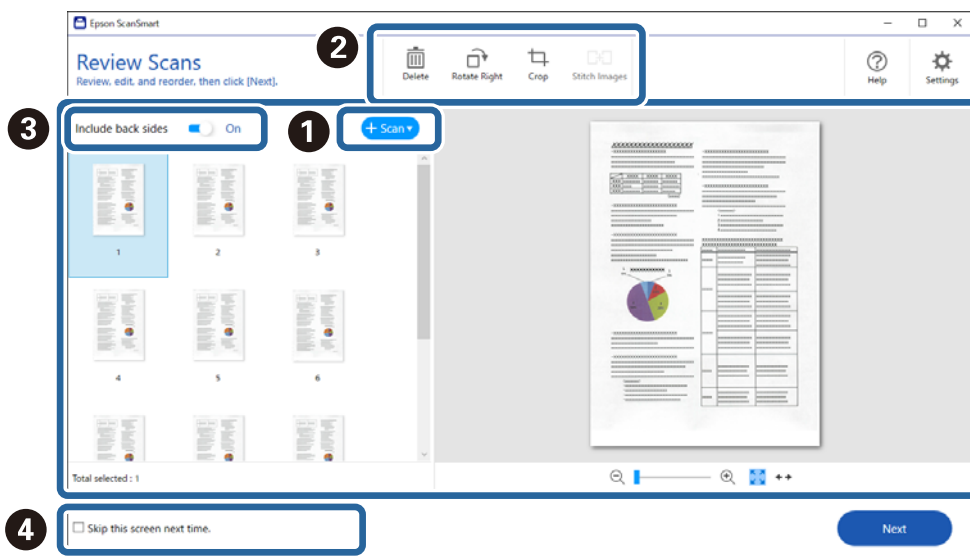

5. Click **Next**.

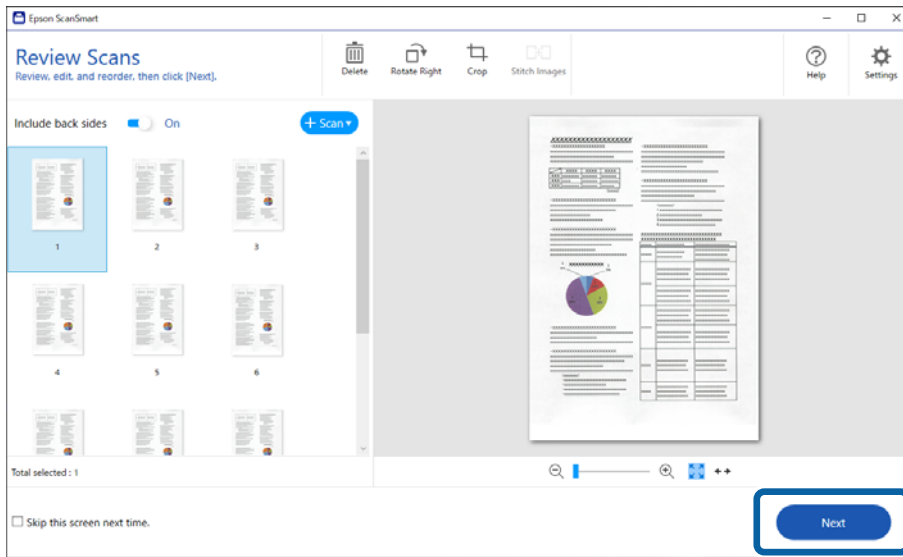

6. Click **Select Action** on the **Save** window.

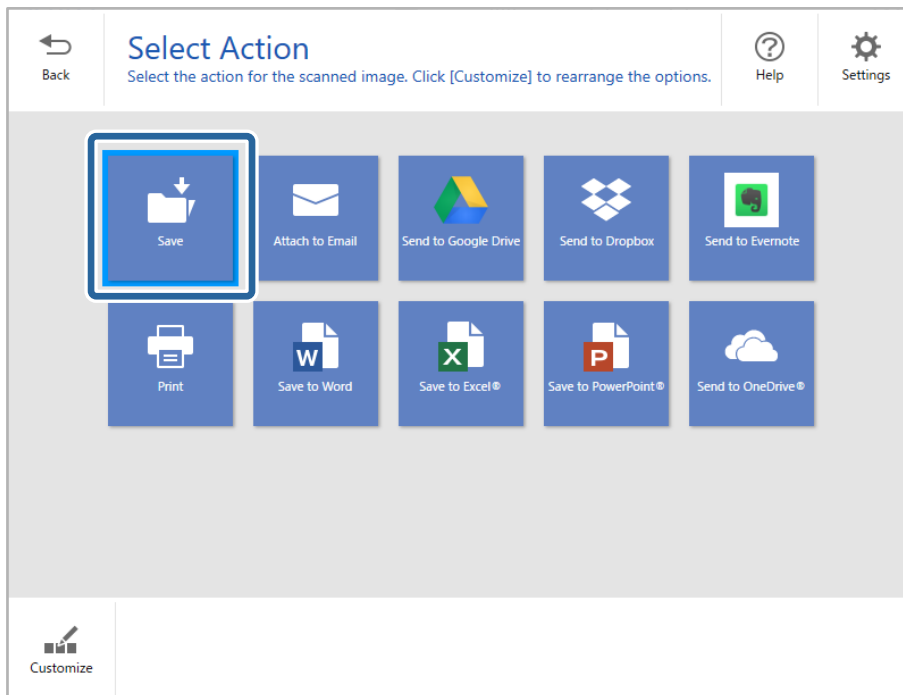

7. Check or change the save settings as necessary.

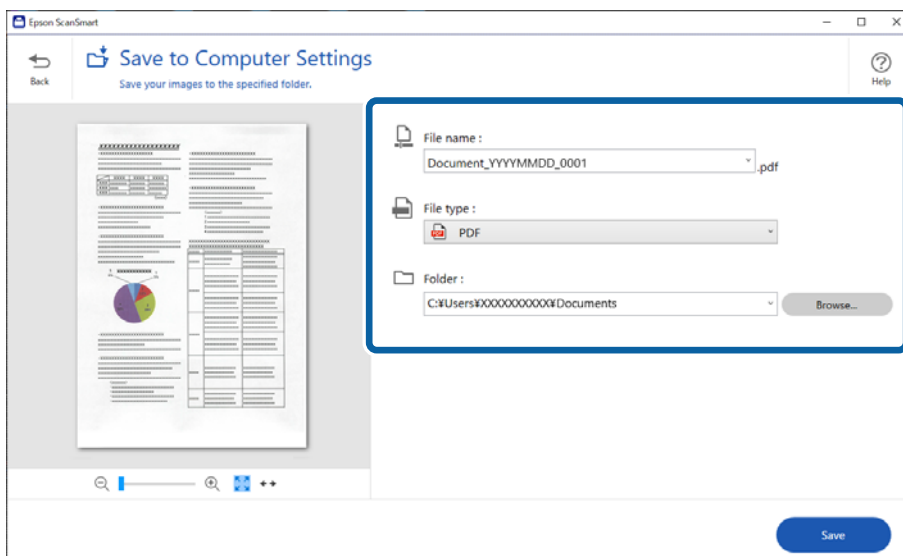

8. Click **Save**.

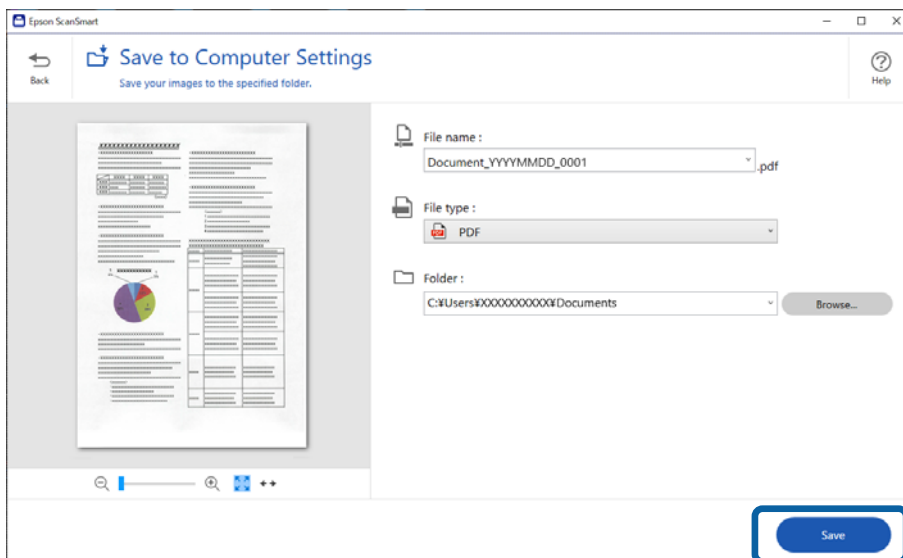

The scanned image is saved to the specified folder.

Software Settings Required for Special Originals

To scan special originals, specify the necessary settings according to the originals. Press the  **Settings** button in Epson ScanSmart, and then select the **Scanner Settings** tab > **Scan Settings** to open the Settings screen.

Type of Original	Required Settings
Envelopes	Select Off in Detect Double Feed .
Plastic cards	Select Plastic Card in the Document Size list, or select Off in Detect Double Feed .

Type of Original	Required Settings
Carrier Sheet	<ul style="list-style-type: none"> <input type="checkbox"/> If you select Auto Detect from the Document Size list, skewing of the original is automatically corrected even if you select Off in Correct Document Skew. <input type="checkbox"/> If you select any other size than Auto Detect from the Document Size list, you can only use Contents Skew when using Correct Document Skew. Selecting Paper Skew will not be applied. When you select Paper and Contents Skew, only contents skew is corrected.
Booklets	Select Booklets from Scan Settings .
Passport/Passport Carrier Sheet	Select Auto Detect from Document Size . Automatically detects and scans passports. You need to set this to save only the ID page of your passport. Select Passport in Scan Settings , and select Settings in Document Size . Select Save ID page only when scanning passports on the Document Size Settings screen.
Large size originals	If the size of the original you want to scan is not listed in Document Size , select Customize . Next, create the size manually on the window.
Long paper	If the size is not listed on the Document Size list, select Auto Detect (Long Paper) or select Customize to create a custom document size.
Laminated cards	To scan transparent areas around the document, select Settings in Document Size to open the Document Size Settings screen. Next, select Scan laminated card in the displayed window. <i>Note:</i> <i>The appropriate effects may not be achieved depending on the original. If transparent areas around the document cannot be scanned, select Customize from the Document Size list, and then create the size manually.</i>

Software Image Quality Adjustment Features

Press the  **Settings** button in Epson ScanSmart, and then select the **Scanner Settings** tab > **Scan Settings** to display the Scan Settings screen.

You can adjust the image quality of the scanned images using the features on the **Advanced Settings** tab. For more details on each feature, see the help on the screen displayed.

Note:

Some items may not be available depending on other settings you made.

Scanning in Automatic Feeding Mode

In Automatic Feeding Mode, scanning starts automatically when originals are loaded into the ADF. This is useful when scanning originals one by one.

1. Start Epson ScanSmart.
2. Click  **Settings**.

3. Click **Scan Settings** on the **Scanner Settings** tab.

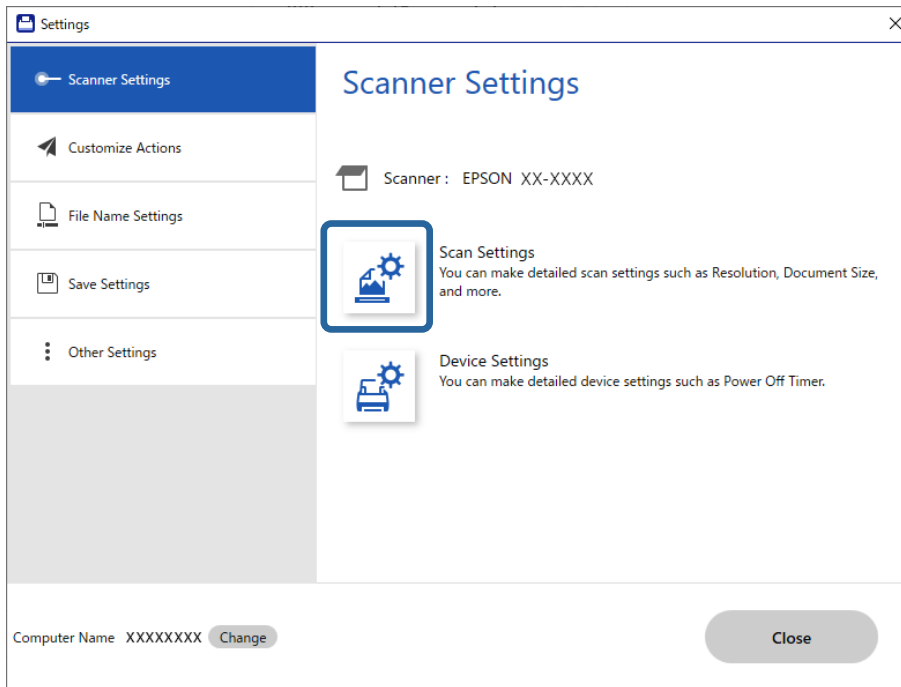

The Scan Settings screen is displayed.

4. Click the **Main Settings** tab > **Automatic Feeding Mode**.

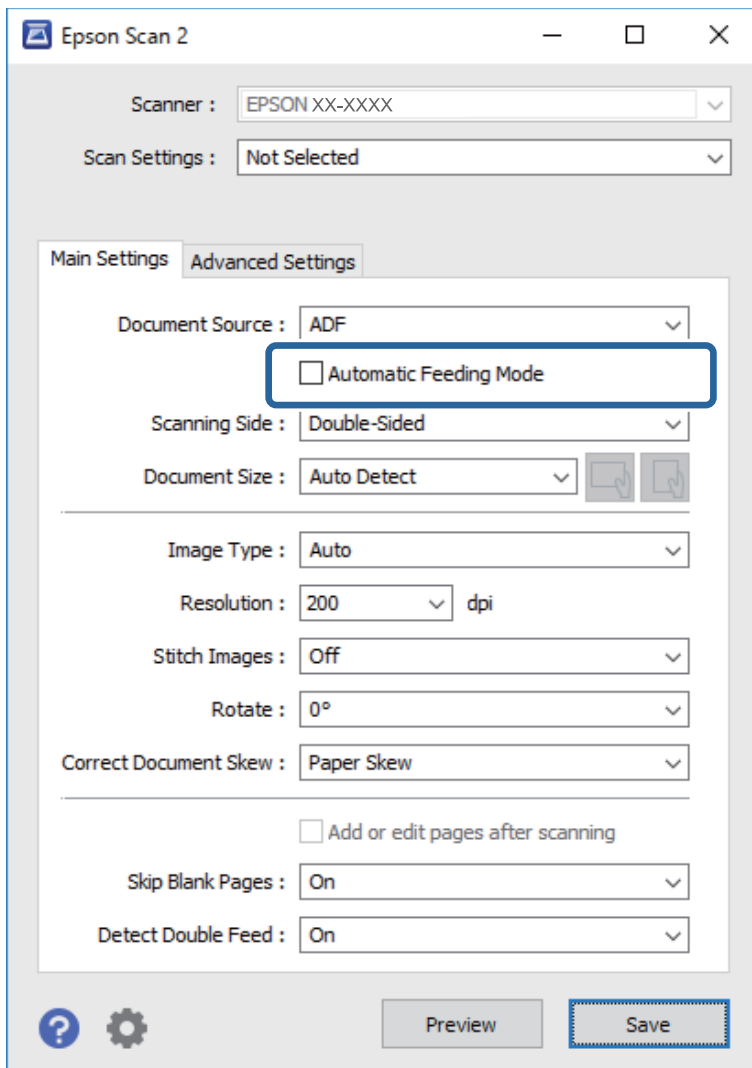

5. Specify other settings for scanning on the settings screen.

Note:

You can make timeout settings to exit **Automatic Feeding Mode**.

Select **Settings** on the **Document Source** list to open the **Document Source Settings** window. Set **Automatic Feeding Mode Timeout (seconds)** on the screen displayed.

6. Click **Save** to close the settings screen.
7. Click **Close** to close the **Settings** window.
8. Click **Scan double-sided** or **Scan single-sided**.
Automatic Feeding Mode starts.

9. Change the position of the scanner according to the type of original, adjust the edge guides, and then place the original in the ADF.

Note:

You can set **Scanner Settings** on the scanner's control panel.

- **Double Feed Stop Timing:** Set the operation to be performed when a double feed is detected.
- **Paper Protection:** Reduces damage to the originals by stopping scanning immediately when a feeding error occurs.
- **Glass Dirt Detection:** Detects dirt on the glass surface inside the scanner.

Scanning starts automatically.

10. After scanning stops, place the next original in the ADF.

Repeat this procedure until you have scanned all originals.

11. After you have scanned all originals, exit Automatic Feeding Mode.

Select **Done** on the scanner's control panel or press **Finish** on the **Automatic Feeding Mode** screen displayed on your computer.

Follow the instructions of the Epson ScanSmart to save the scanned image.

Using AirPrint

AirPrint enables instant scanning from a Mac without the need to install drivers or download software.



1. Load your originals.
2. Connect the product to the same network that your Mac is connected to, or connect the product to your Mac with a USB cable.
3. On the **System Preferences** screen on your Mac, click **Printers & Scanners**.
4. Select your scanner from the list, then click **Open Scanner**.
5. Select scan settings as needed, then start scanning.

Note:

For details, see the macOS User Guide.

Scanning Using Chromebook

You can scan using a Chromebook.

1. Place the originals.
2. Connect the scanner to the network that your Chromebook is connected to, or connect the scanner to your Chromebook using a USB cable.

3. Open the Scan app on your Chromebook.
Select the time in the bottom-right of the screen > **Settings** button > **Advanced** > **Print and scan** > **Scan**.
4. Select your scanner, and then set other items if necessary.
5. Scan from your Chromebook with your scanner.

Note:

For more details, check <https://www.google.com/chromebook/>.

Scanning from a Smart Device

Scanning Using Epson Smart Panel

To scan from your smart device, search for and install Epson Smart Panel from App Store or Google Play.

Note:

Connect the scanner to the smart device before scanning.

1. Place the original.
2. Start Epson Smart Panel.
3. Follow the on-screen instructions to scan.

Note:

If the size of your original does not appear in the list, select **Auto**.

The scanned image is saved to your smart device, send to cloud service, or send to email.

Scanning Using Mopria Scan

Mopria Scan enables instant network scanning from Android smart phones or tablets.



1. Install Mopria Scan from Google Play.
2. Place the originals.
3. Set up your scanner for network scanning. See the link below.
<https://epson.sn>
4. Connect your Android device over a wireless connection (Wi-Fi) to the same network that your scanner is using.

5. Scan from your device with your scanner.

Note:

For more details, access the Mopria Web site at <https://mopria.org>.

Required Settings for Scanning

Connecting the Scanner to the Network.	137
Setting Up Scanning from the Control Panel (the Scan to Features).	139
Creating a Network Folder.	140
Registering an Email Server.	146
Registering Destinations to Contacts.	149
Setting Up AirPrint.	158

Connecting the Scanner to the Network

If the scanner is not connected to the network, use the installer to connect the scanner to the network.

To start the installer, access the following website, and then enter the product name. Go to **Setup**, and then start setting up.

<https://epson.sn>

You can view the operating instructions in the Web Movie Manuals. Access the following URL.

<https://support.epson.net/publist/vlink.php?code=NPD7126>

Related Information

- ➔ “Checking the Network Connection Status” on page 232
- ➔ “Connecting the Scanner to the Network” on page 236

Connecting to the Wireless LAN (Wi-Fi)

You can connect the scanner to the wireless LAN (Wi-Fi) in several ways. Choose the connection method that matches the environment and conditions that you are using.

If you know the information for the wireless router such as SSID and password, you can make settings manually.

If the wireless router supports WPS, you can make settings by using push button setup.

After connecting the scanner to the network, connect to the scanner from the device that you want to use (computer, smart device, tablet, and so on.)

Making Wi-Fi Settings by Entering the SSID and Password

You can set up a Wi-Fi network by entering the information necessary to connect to a wireless router from the scanner's control panel. To set up using this method, you need the SSID and password for a wireless router.

Note:

If you are using a wireless router with its default settings, the SSID and password are on the label. If you do not know the SSID and password, contact the person who set up the wireless router, or see the documentation provided with the wireless router.

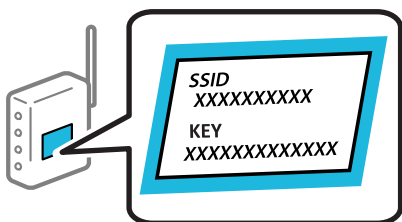

1. Tap  on the home screen.
2. Select **Wi-Fi (Recommended)**.

3. Tap **Start Setup**.

If the network connection is already set up, the connection details are displayed. Tap **Change to Wi-Fi connection**, or **Change Settings** to change the settings.

4. Select **Wi-Fi Setup Wizard**.

5. Follow the on-screen instructions to select the SSID, enter the password for the wireless router, and start setup.

If you want to check the network connection status for the scanner after setup is complete, see the related information link below for details.

Note:

- If you do not know the SSID, check if it is written on the label of the wireless router. If you are using the wireless router with its default settings, use the SSID written on the label. If you cannot find any information, see the documentation provided with the wireless router.
- The password is case-sensitive.
- If you do not know the password, check if the information is written on the label of the wireless router. On the label, the password may be written "Network Key", "Wireless Password", and so on. If you are using the wireless router with its default settings, use the password written on the label.

Related Information

➔ [“Checking the Network Connection Status” on page 232](#)

Making Wi-Fi Settings by Push Button Setup (WPS)

You can automatically set up a Wi-Fi network by pressing a button on the wireless router. If the following conditions are met, you can set up by using this method.

- The wireless router is compatible with WPS (Wi-Fi Protected Setup).
- The current Wi-Fi connection was established by pressing a button on the wireless router.

Note:

If you cannot find the button or you are setting up using the software, see the documentation provided with the wireless router.

1. Tap  on the home screen.

2. Select **Wi-Fi (Recommended)**.

3. Tap **Start Setup**.

If the network connection is already set up, the connection details are displayed. Tap **Change to Wi-Fi connection**, or **Change Settings** to change the settings.

4. Select **Push Button Setup (WPS)**.

5. Follow the on-screen instructions.

If you want to check the network connection status for the scanner after setup is complete, see the related information link below for details.

Note:

If connection fails, restart the wireless router, move it closer to the scanner, and try again.

Related Information

➔ [“Checking the Network Connection Status” on page 232](#)

Making Wi-Fi Settings by PIN Code Setup (WPS)

You can automatically connect to a wireless router by using a PIN code. You can use this method to set up if an wireless router is capable of WPS (Wi-Fi Protected Setup). Use a computer to enter a PIN code into the wireless router.

1. Tap  on the home screen.

2. Select **Wi-Fi (Recommended)**.

3. Tap **Start Setup**.

If the network connection is already set up, the connection details are displayed. Tap **Change to Wi-Fi connection**, or **Change Settings** to change the settings.

4. Select **Others > PIN Code Setup (WPS)**

5. Follow the on-screen instructions.

If you want to check the network connection status for the scanner after setup is complete, see the related information link below for details.

Note:

See the documentation provided with your wireless router for details on entering a PIN code.

Related Information

➔ [“Checking the Network Connection Status” on page 232](#)

Setting Up Scanning from the Control Panel (the Scan to Features)

You need to make several settings in advance to use the Scan to features.

See the following for the work flow to set up each feature.

[“Scan to Computer Feature Work Flow” on page 100](#)

[“Scan to USB Drive Feature Work Flow” on page 100](#)

[“Scan to Cloud Feature Work Flow” on page 100](#)

[“Scan to Email Feature Work Flow” on page 102](#)

[“Scan to Network Folder/FTP Feature Work Flow” on page 102](#)

[“Scan to WSD Work Flow” on page 104](#)

Creating a Network Folder

Create a network folder on your computer. The computer must be connected to the same network as the scanner.

The method to set the network folder varies depending on the environment. This is an example of creating a network folder on the desktop of a computer under the following environment.

- Operating system: Windows 10
- Location for creating shared folder: Desktop
- Folder path: C:\Users\xxxx\Desktop\scan_folder (create a network folder called "scan_folder" on the desktop)

1. Log in to the computer on which you want to create the network folder with a user account that has administrator authority.

Note:

If you do not know which user account has administrator authority, check with your computer administrator.

2. Make sure that the device name (computer name) does not contain double-byte characters. Click the Windows Start button, and then select  **Settings > System > About**.

Note:

If there are double-byte characters in the device name, file saving may fail.

3. Check that the string displayed in **Device Specifications > Device Name** does not contain any double-byte characters.

There should be no issues if the device name contains only single-byte characters. Close the screen.

Example: EPSPUB313

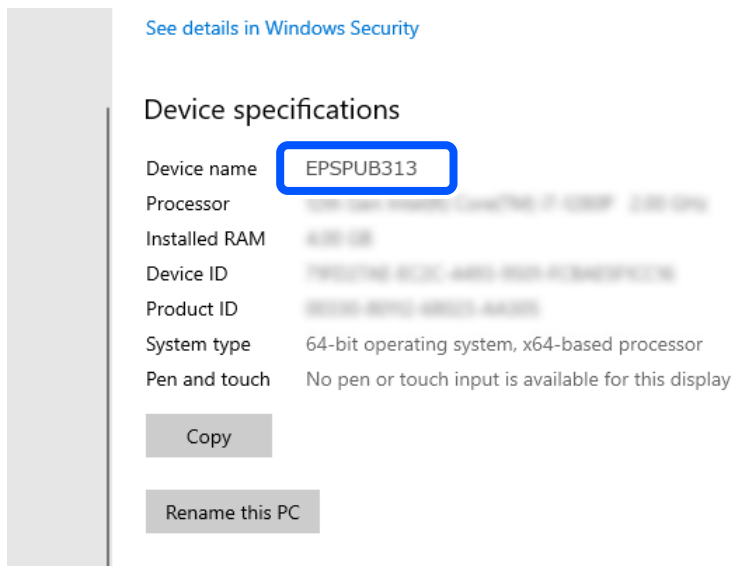

 **Important:**

If the device name contains double-byte characters, use a computer that does not use double-byte characters or rename the device.

If you need to change the device name, make sure you check with your computer administrator in advance as it may affect computer management and access to resources.

Next, check your computer settings.

4. Click the Windows start button, and then select **Windows System > Control Panel**.

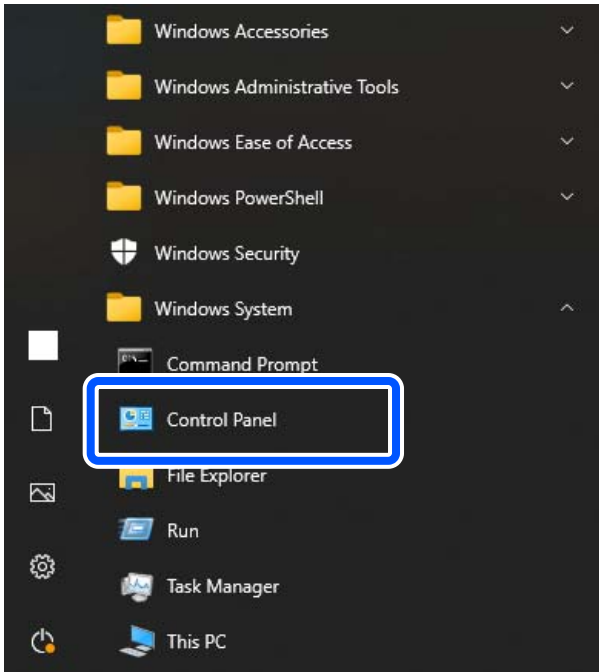

5. On the Control Panel, click **Network and Internet > Network and Sharing Center > Change advanced sharing settings**.

The network profile is displayed.

6. Make sure that **Turn on file and printer sharing** is selected under **File and Printer Sharing** for the network profile (current profile).

If already selected, click **Cancel** and close the window.

When you change the settings, click **Save Changes** and close the window.

Next, create a network folder.

7. Create and name a folder on your desktop.

For the folder name, enter within 1 to 12 alphanumeric characters. If the name exceeds 12 characters, you may not be able to access the folder depending on your environment.

Example: scan_folder

8. Right click the folder, and then select **Properties**.

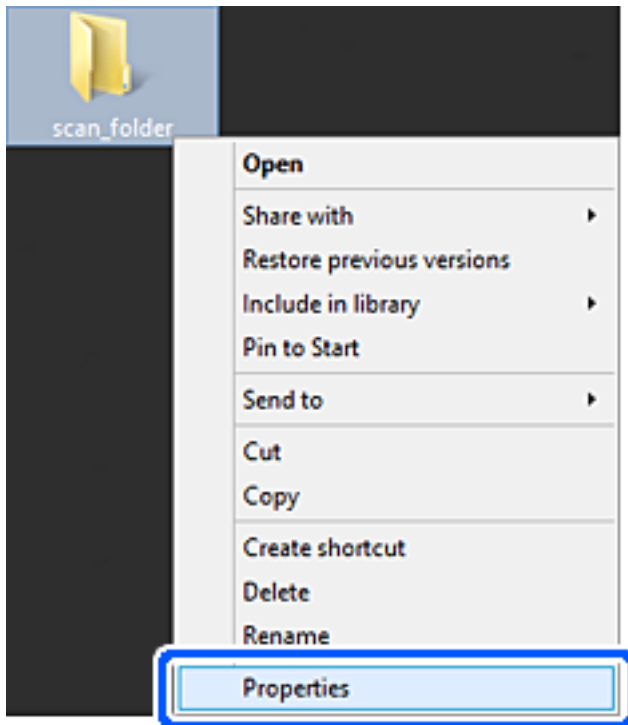

9. Click **Advanced Sharing** on the **Sharing** tab.

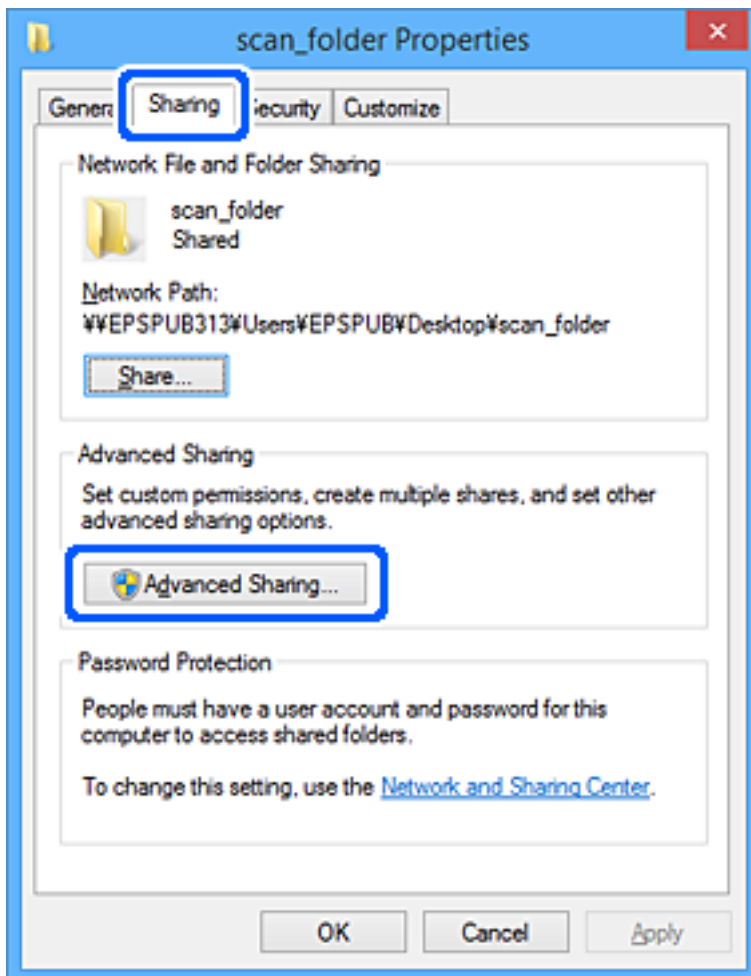

10. Select **Share this folder**, and then click **Permissions**.

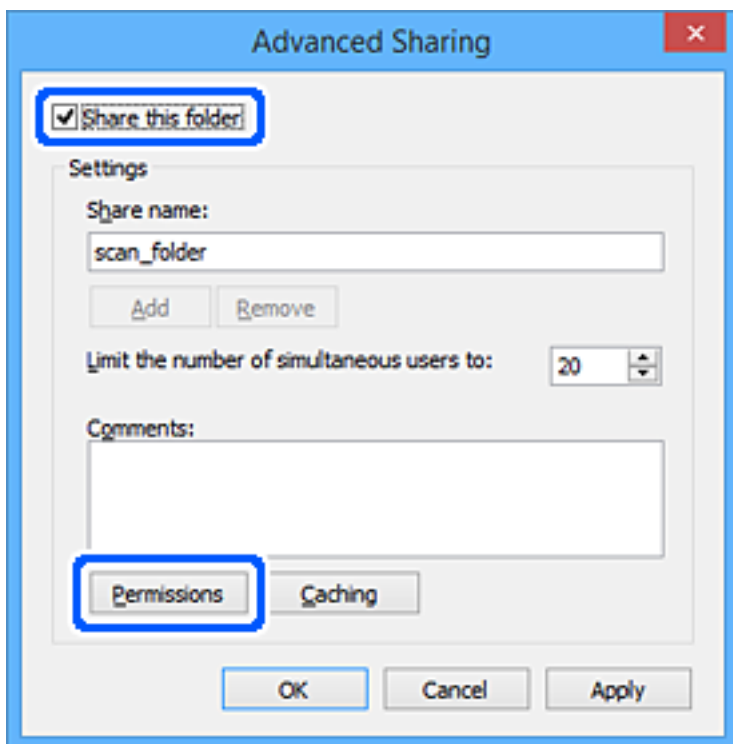

11. Select **Everyone** in **Group or user names**, select **Allow** from **Change**, and then click **OK**.

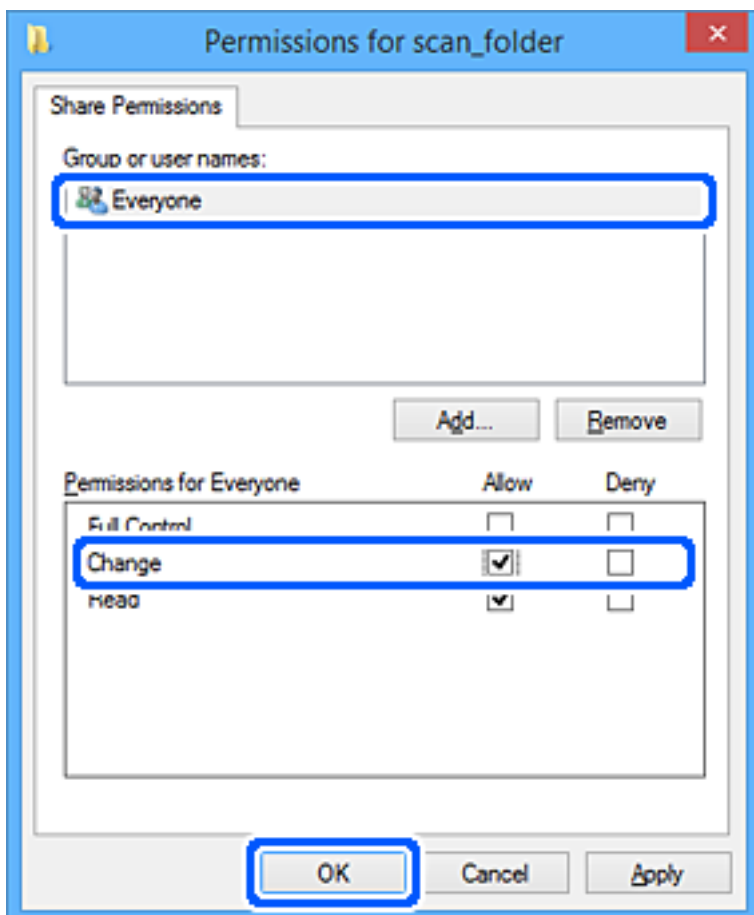

12. Click **OK** to close the screen and return to the Properties window.

Note:

You can check which groups or users have access to the network folder on the **Security** tab > **Group or user names**.

Example: When the user logged on to the computer as well as Administrators can access the network folder

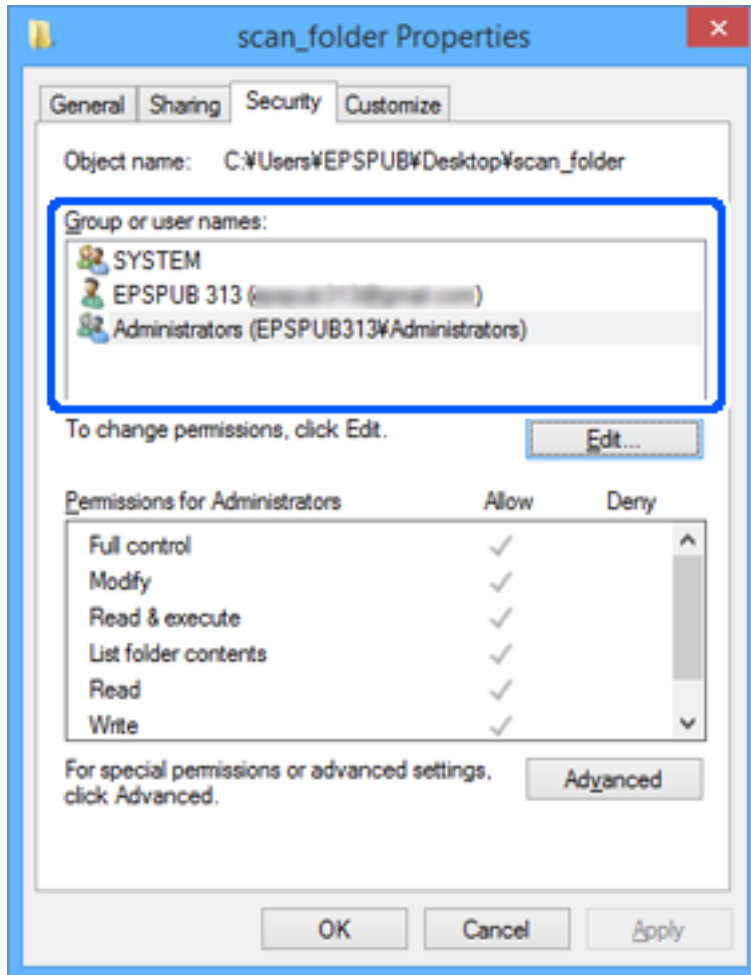

13. Select the **Sharing** tab.

The network path for the network folder is displayed. This is used when registering to your contacts for the scanner. Please write it down.

Example: \\EPSPUB313\scan_folder

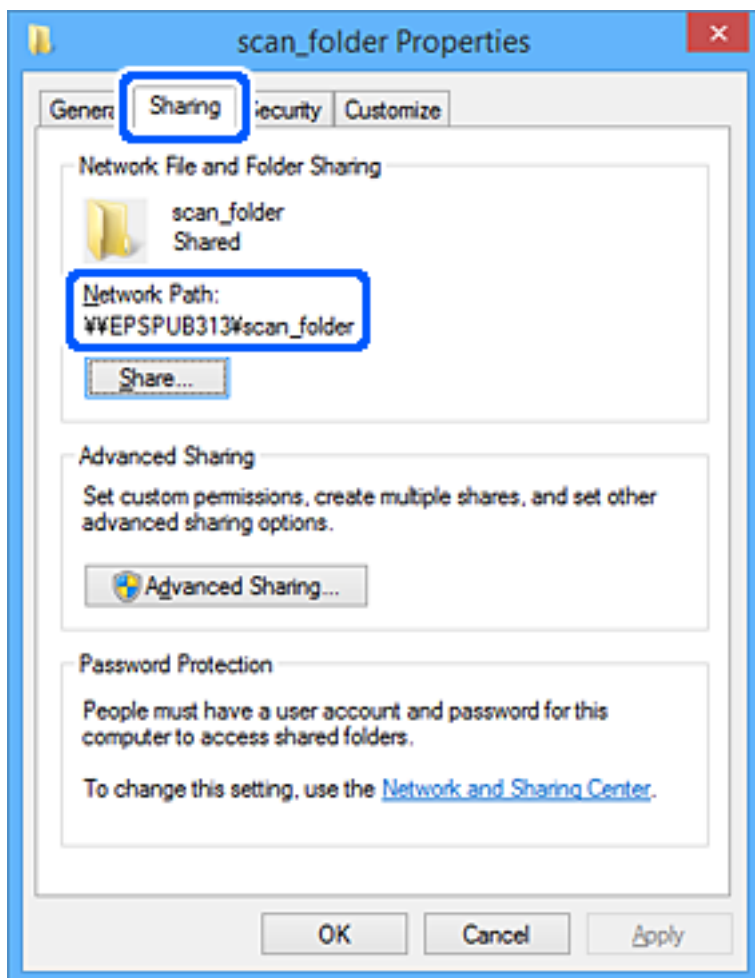

14. Click **Close** or **OK** to close the window.

This completes creating a network folder.

Click the link below for more details on using the "Scan to Network Folder/FTP" feature.

["Scan to Network Folder/FTP Feature Work Flow" on page 102](#)

Registering an Email Server

Check the following before configuring the email server.

- The scanner is connected to the network
- Setup information for email server

When you are using an Internet based email server, check the setting information from the provider or website.

Note:

You can send scanned images by email through Epson's cloud service, Epson Connect, without having to setup an email server. For more details, see the Scan to Cloud feature.

["Scan to Cloud Feature Work Flow" on page 100](#)

How to Register

Access Web Config, select the **Network** tab > **Email Server** > **Basic**.

[“How to Run Web Config in a Web Browser” on page 36](#)

You can also make settings on the scanner's control panel. Select **Settings** > **Network Settings** > **Advanced** > **Email Server** > **Server Settings**.

Email Server Setting Items

Item	Settings and Explanation	
Authentication Method	Specify the authentication method for the scanner to access the mail server.	
	Off	Authentication is disabled when communicating with a mail server.
	SMTP AUTH	The email server needs to support SMTP authentication.
	POP before SMTP	When you select this item, set a POP3 server.
Authenticated Account	If you select SMTP AUTH or POP before SMTP as the Authentication Method , enter the authenticated account name. Enter within 0 to 255 characters in ASCII (0x20 - 0x7E).	
Authenticated Password	If you select SMTP AUTH or POP before SMTP as the Authentication Method , enter the authenticated password. Enter between 0 and 20 characters in ASCII (0x20-0x7E).	
Sender's Email Address	Set the email address that will be used to send emails from the scanner. Although you can use an existing email address, we recommend that you acquire and set up a dedicated email address so that it can be distinguished from emails sent from the scanner. Enter within 0 to 255 characters in ASCII (0x20 - 0x7E) except for : () < > [] ; ¥. A period "" cannot be the first character.	
SMTP Server Address	Enter between 0 and 255 characters using A-Z a-z 0-9 . - . You can use IPv4 or FQDN format.	
SMTP Server Port Number	Enter a number between 1 and 65535.	
Secure Connection	Specify the secure connection method for the email server.	
	None	If you select POP before SMTP in Authentication Method , the connection method is set to None .
	SSL/TLS	This is available when Authentication Method is set to Off or SMTP AUTH .
	STARTTLS	This is available when Authentication Method is set to Off or SMTP AUTH .
Certificate Validation (Web Config only)	The certificate is validated when this is enabled. We recommend setting this to Enable when Secure Connection is set to anything other than None .	
POP3 Server Address	If you select POP before SMTP as the Authentication Method , enter the server address of the POP3 server. You can enter between 0 and 255 characters using A-Z a-z 0-9. You can use IPv4 or FQDN format.	
POP3 Server Port Number	Set when you select POP before SMTP in Authentication Method . Enter a number between 1 and 65535.	

Click the link below for more details on using the "Scan to Email" feature.

[“Scan to Email Feature Work Flow” on page 102](#)

Checking an Email Server Connection

1. Select the connection test menu.

When setting up from Web Config:

Select the **Network** tab > **Email Server** > **Connection Test** > **Start**.

When setting from the control panel:

Select **Settings** > **Network Settings** > **Advanced** > **Email Server** > **Connection Check**.

The connection test to the mail server is started.

2. Check the test results.

The test is successful when the message **Connection test was successful.** is displayed.

If an error is displayed, follow the instructions in the message to clear the error.

[“Mail Server Connection Test References” on page 148](#)

Click the link below for more details on using the "Scan to Email" feature.

[“Scan to Email Feature Work Flow” on page 102](#)

Mail Server Connection Test References

Message	Cause
SMTP server communication error. Check the following. - Network Settings	This message appears when <ul style="list-style-type: none"> <input type="checkbox"/> The scanner is not connected to a network <input type="checkbox"/> SMTP server is down <input type="checkbox"/> Network connection is disconnected while communicating <input type="checkbox"/> Received incomplete data
POP3 server communication error. Check the following. - Network Settings	This message appears when <ul style="list-style-type: none"> <input type="checkbox"/> The scanner is not connected to a network <input type="checkbox"/> POP3 server is down <input type="checkbox"/> Network connection is disconnected while communicating <input type="checkbox"/> Received incomplete data
An error occurred while connecting to SMTP server. Check the followings. - SMTP Server Address - DNS Server	This message appears when <ul style="list-style-type: none"> <input type="checkbox"/> Connecting to a DNS server failed <input type="checkbox"/> Name resolution for an SMTP server failed
An error occurred while connecting to POP3 server. Check the followings. - POP3 Server Address - DNS Server	This message appears when <ul style="list-style-type: none"> <input type="checkbox"/> Connecting to a DNS server failed <input type="checkbox"/> Name resolution for a POP3 server failed
SMTP server authentication error. Check the followings. - Authentication Method - Authenticated Account - Authenticated Password	This message appears when SMTP server authentication failed.

Message	Cause
POP3 server authentication error. Check the followings. - Authentication Method - Authenticated Account - Authenticated Password	This message appears when POP3 server authentication failed.
Unsupported communication method. Check the followings. - SMTP Server Address - SMTP Server Port Number	This message appears when you try to communicate with unsupported protocols.
Connection to SMTP server failed. Change Secure Connection to None.	This message appears when an SMTP mismatch occurs between a server and a client, or when the server does not support SMTP secure connection (SSL connection).
Connection to SMTP server failed. Change Secure Connection to SSL/TLS.	This message appears when an SMTP mismatch occurs between a server and a client, or when the server requests to use an SSL/TLS connection for an SMTP secure connection.
Connection to SMTP server failed. Change Secure Connection to STARTTLS.	This message appears when an SMTP mismatch occurs between a server and a client, or when the server requests to use a STARTTLS connection for an SMTP secure connection.
The connection is untrusted. Check the following. - Date and Time	This message appears when the scanner's date and time setting is incorrect or the certificate has expired.
The connection is untrusted. Check the following. - CA Certificate	This message appears when the scanner does not have a root certificate corresponding to the server or a CA Certificate has not been imported.
The connection is not secured.	This message appears when the obtained certificate is damaged.
SMTP server authentication failed. Change Authentication Method to SMTP-AUTH.	This message appears when an authentication method mismatch occurs between a server and a client. The server supports SMTP AUTH.
SMTP server authentication failed. Change Authentication Method to POP before SMTP.	This message appears when an authentication method mismatch occurs between a server and a client. The server does not support SMTP AUTH.
Sender's Email Address is incorrect. Change to the email address for your email service.	This message appears when the specified sender's Email address is wrong.
Cannot access the product until processing is complete.	This message appears when the scanner is busy.

Registering Destinations to Contacts

Registering destinations in the scanner's contacts list allows you to easily enter the destination when scanning. You can register the following types of destinations in the contacts list. You can register up to 300 entries in total.

Email	Destination for email. You need to configure the email server settings beforehand.
Network Folder	Destination for scan data. You need to prepare the network folder beforehand.

Function Comparison by Registration Tool

There are three functions available for configuring the scanner's Contacts: Web Config, Epson Device Admin, and the control panel. The differences between three tools are listed in the table below.

✓ : You can make this setting. - : You cannot make this setting.

Functions	Web Config*	Epson Device Admin	Scanner's control panel
Registering a destination	✓	✓	✓
Editing a destination	✓	✓	✓
Adding a group	✓	✓	✓
Editing a group	✓	✓	✓
Deleting a destination or groups	✓	✓	✓
Deleting all destinations	✓	✓	-
Importing a file	✓	✓	-
Exporting to a file	✓	✓	-

* Log on as an administrator to make settings.

Registering a Destination to Contacts

The setting items differ depending on the Type of destination you want to register.

Registering a Destination (Email)

How to Register

Access Web Config, and then select the **Scan** tab > **Contacts**. Select the number you want to register to your contacts, and then click **Edit**.

[“How to Run Web Config in a Web Browser” on page 36](#)

You can also make settings on the scanner's control panel. Select **Settings** > **Contacts Manager** > **Register/Delete** > **Add Entry** > **Add Contact** > **Email**.

Contacts Setting Items

Item	Settings and Explanation
Number (Registry Number)	Sets the number of the destination to be registered in your contacts.
Name	Enter the name to be displayed in Contacts within 30 characters in Unicode (UTF-16). If you do not specify this, leave it blank.
Index Word	Enter the name to be used for indexing and searching Contacts within 30 characters in Unicode (UTF-16). If you do not specify this, leave it blank.
Type (Web Config only)	Select Email .

Item	Settings and Explanation
Email Address	Enter the destination email addresses. Use half-width characters A-Z a-z 0-9 ! # \$ % & ' * + - . / = ? ^ _ { } ~ @, and enter between 1 and 255 characters.
Apply button (Web Config only)	The destination is registered using the information you entered.
OK button (control panel only)	

Click the link below for more details on using the "Scan to Email" feature.

["Scan to Email Feature Work Flow" on page 102](#)

Registering a Destination (Network Folder (SMB))

How to Register

Access Web Config, and then select the **Scan** tab > **Contacts**. Select the number you want to register to your contacts, and then click **Edit**.

["How to Run Web Config in a Web Browser" on page 36](#)

You can also make settings on the scanner's control panel. Select **Settings** > **Contacts Manager** > **Register/Delete** > **Add Entry** > **Add Contact** > **Network Folder/FTP**.

Contacts Setting Items

Item	Settings and Explanation
Number (Registry Number)	Sets the number of the destination to be registered in your contacts.
Name	Enter the name to be displayed in Contacts within 30 characters in Unicode (UTF-16). When this is entered, you can also enter an Index Word . If you do not specify this, leave it blank.
Index Word	Enter the name to be used for indexing and searching Contacts within 30 characters in Unicode (UTF-16). If you do not specify this, leave it blank. Note: <i>If this is not specified, the recipient will appear under Others in the Contacts index.</i>
Type (Web Config only)	Select Network Folder (SMB) .
Communication Mode (control panel only)	

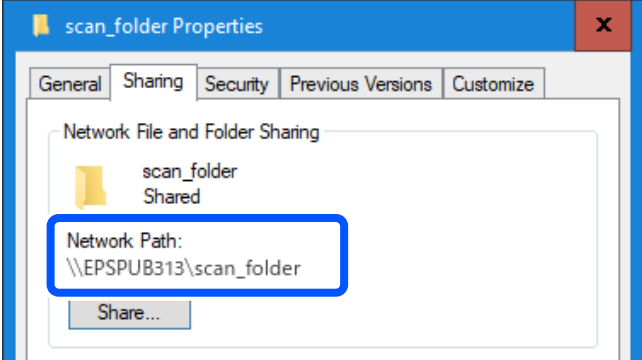
Item	Settings and Explanation
Save to	<p>Enter the path to the destination network folder within 1 to 253 characters in Unicode (UTF-16).</p> <p>The "\\" at the start of the path has already been entered.</p> <p>Note: Open the properties for the network folder and enter the network path as it appears on the Sharing tab.</p> <p>Example: \\EPSPUB313\scan_folder</p> 
User Name	<p>Enter the login user name (user account) for the computer on which the destination folder was created.</p> <p>Enter the user name within 30 characters in Unicode (UTF-16). However, avoid using control characters (0x00 to 0x1f, 0x7F).</p>
Password	<p>Enter the login password (user account password) for the computer on which the destination folder was created.</p> <p>Enter the password within 0 to 20 characters in Unicode (UTF-16). However, avoid using control characters (0x00 to 0x1f, 0x7F).</p>
Apply button (Web Config only)	The destination is registered using the information you entered.
OK button (control panel only)	

Click the link below for more details on using the "Scan to Network Folder/FTP" feature.

["Scan to Network Folder/FTP Feature Work Flow" on page 102](#)

Registering a Destination (FTP)

How to Register

Access Web Config, and then select the **Scan** tab > **Contacts**. Select the number you want to register to your contacts, and then click **Edit**.

["How to Run Web Config in a Web Browser" on page 36](#)

You can also make settings on the scanner's control panel. Select **Settings** > **Contacts Manager** > **Register/Delete** > **Add Entry** > **Add Contact** > **Network Folder/FTP**.

Contacts Setting Items

Item	Settings and Explanation
Number (Registry Number)	Sets the number of the destination to be registered in your contacts.
Name	Enter the name to be displayed in Contacts within 30 characters in Unicode (UTF-16). If you do not specify this, leave it blank.
Index Word	Enter the name to be used for indexing and searching Contacts within 30 characters in Unicode (UTF-16). If you do not specify this, leave it blank.
Type (Web Config only)	Select FTP .
Secure Connection (Web Config only)	Select FTP or FTPS according to the file transfer protocol the FTP server supports. Select FTPS to allow the scanner to communicate with security measures.
Communication Mode (control panel only)	
Save to	Enter the name of the destination server within 1 to 253 characters (excluding "ftp://" and "ftps://") in Unicode (UTF-16).
User Name	Enter a user name to access an FTP server in 30 characters or less in Unicode (UTF-16). However, avoid using control characters (0x00 to 0x1f, 0x7F). If the server allows anonymous connections, enter a user name such as Anonymous and FTP. If you do not specify this, leave it blank.
Password	Enter a password to access the FTP server within 0 to 20 characters or less in Unicode (UTF-16). However, avoid using control characters (0x00 to 0x1f, 0x7F). If you do not specify this, leave it blank.
Connection Mode	Select the connection mode from the menu. If a firewall is set between the scanner and the FTP server, select Passive Mode .
Port Number	Enter the FTP server port number between 1 and 65535.
Certificate Validation (Web Config only)	The FTP server's certificate is validated when this is enabled. This is available when FTPS is selected for Secure Connection . Before setting up, you need to import the CA Certificate to the scanner.
Apply button (Web Config only)	The destination is registered using the information you entered.
OK button (control panel only)	

Click the link below for more details on using the "Scan to Network Folder/FTP" feature.

["Scan to Network Folder/FTP Feature Work Flow" on page 102](#)

Registering a Destination (SharePoint(WebDAV))

How to Register

Access Web Config, and then select the **Scan** tab > **Contacts**. Select the number you want to register to your contacts, and then click **Edit**.

["How to Run Web Config in a Web Browser" on page 36](#)

You can also make settings on the scanner's control panel. Select **Settings** > **Contacts Manager** > **Register/Delete** > **Add Entry** > **Add Contact** > **Network Folder/FTP**.

Contacts Setting Items

Item	Settings and Explanation
Number (Registry Number)	Sets the number of the destination to be registered in your contacts.
Name	Enter the name to be displayed in Contacts within 30 characters in Unicode (UTF-16). If you do not specify this, leave it blank.
Index Word	Enter the name to be used for indexing and searching Contacts within 30 characters in Unicode (UTF-16). If you do not specify this, leave it blank.
Type (Web Config only)	Select SharePoint(WebDAV) .
Secure Connection (Web Config only)	Select the HTTPS (WebDAV (HTTPS)) or HTTP (WebDAV (HTTP)) according to the file transfer protocol the server supports. Select HTTPS to allow the scanner to communicate with security measures.
Communication Mode (control panel only)	
Save to	Enter the name of the destination server within 1 to 253 characters (excluding "http://" and "https://") in Unicode (UTF-16).
User Name	Enter a user name to access a server in 30 characters or less in Unicode (UTF-16). However, avoid using control characters (0x00 to 0x1f, 0x7F). If you do not specify this, leave it blank.
Password	Enter a password to access the server within 0 to 20 characters or less in Unicode (UTF-16). However, avoid using control characters (0x00 to 0x1f, 0x7F). If you do not specify this, leave it blank.
Certificate Validation (Web Config only)	The server's certificate is validated when this is enabled. This is available when HTTPS is selected for Secure Connection . Before setting up, you need to import the CA Certificate to the scanner.
Proxy Server Settings	Select whether or not to use a proxy server.
Apply button (Web Config only)	The destination is registered using the information you entered.
OK button (control panel only)	

Note:

Scanning to **Network Folder/FTP** from the scanner's control panel does not support SharePoint Online.

Click the link below for more details on using the "Scan to Network Folder/FTP" feature.

["Scan to Network Folder/FTP Feature Work Flow" on page 102](#)

Registering Destinations as a Group Using Web Config

If the destination type is set to **Email**, you can register the destinations as a group.

1. Access Web Config, and then select the **Scan** tab > **Contacts**.
["How to Run Web Config in a Web Browser" on page 36](#)
2. Select the number that you want to register, and then click **Edit**.
3. Select a group from **Type**.

4. Click **Select** on **Contact(s) for Group**.

The available destinations are displayed.

5. Select the destination that you want to register to the group, and then click **Select**.

Note:

Destinations can be registered to multiple groups.

6. Enter **Name** and **Index Word**.

7. Click **Apply**.

Backing Up and Importing Contacts

Using Web Config or other tools, you can back up and import contacts.

For Web Config, you can back up contacts by exporting the scanner settings that include contacts. The exported file cannot be edited because it is exported as a binary file.

When importing the scanner settings to the scanner, contacts are overwritten.

For Epson Device Admin, only contacts can be exported from the device's property screen. Also, if you do not export the security-related items, you can edit the exported contacts and import them because this can be saved as a SYLK file or CSV file.

Importing Contacts Using Web Config

If you have a scanner that allows you to backup contacts and is compatible with this scanner, you can register contacts easily by importing the backup file.

Note:

For instructions on how to back up the scanner contacts, see the manual provided with the scanner.

Follow the steps below to import the contacts to this scanner.

1. Access Web Config, select **Device Management** tab > **Export and Import Setting Value** > **Import**.
2. Select the backup file you created in **File**, enter the password, and then click **Next**.
3. Select the **Contacts** checkbox, and then click **Next**.

Backing up Contacts Using Web Config

Contacts data may be lost due to a scanner malfunction. We recommend that you make a backup of the data whenever you update the data. Epson shall not be responsible for the loss of any data, for backing up or recovering data and/or settings even during a warranty period.

Using Web Config, you can back up the contact data stored in the scanner to the computer.

1. Access Web Config, and then select the **Device Management** tab > **Export and Import Setting Value** > **Export**.
2. Select the **Contacts** checkbox under the **Scan** category.

3. Enter a password to encrypt the exported file.

You need the password to import the file. Leave this blank if you do not want to encrypt the file.

4. Click **Export**.

Export and Bulk Registration of Contacts Using Tool

If you use Epson Device Admin, you can back up just the contacts and edit the exported files, then register them all at once.

It is useful if you want to back up only the contacts or when you replace the scanner and you want to transfer the contacts from the old one to new one.

Exporting Contacts

Save the contacts information to the file.

You can edit files saved in SYLK format or csv format by using a spreadsheet application or text editor. You can register all at once after deleting or adding the information.

Information that includes security items such as password and personal information can be saved in binary format with a password. You cannot edit the file. This can be used as the backup file of the information including the security items.

1. Start Epson Device Admin.
2. Select **Devices** on the side bar task menu.
3. Select the device you want to configure from the device list.
4. Click **Device Configuration** on the **Home** tab on the ribbon menu.

When the administrator password has been set, enter the password and click **OK**.

5. Click **Common > Contacts**.
6. Select the export format from **Export > Export items**.

All Items

Export the encrypted binary file. Select when you want to include the security items such as password and personal information. You cannot edit the file. If you select it, you have to set the password. Click **Configuration** and set a password between 8 and 63 characters long in ASCII. This password is required when importing the binary file.

Items except Security Information

Export the SYLK format or csv format files. Select when you want to edit the information of the exported file.

7. Click **Export**.
8. Specify the place to save the file, select the file type, and then click **Save**.

The completion message is displayed.

9. Click **OK**.

Check that the file is saved to the specified place.

Importing Contacts

Import the contacts information from the file.

You can import the files saved in SYLK format or csv format or the backed-up binary file that includes the security items.

1. Start Epson Device Admin.
2. Select **Devices** on the side bar task menu.
3. Select the device you want to configure from the device list.
4. Click **Device Configuration** on the **Home** tab on the ribbon menu.
When the administrator password has been set, enter the password and click **OK**.
5. Click **Common > Contacts**.
6. Click **Browse** on **Import**.
7. Select the file you want to import and then click **Open**.
When you select the binary file, in **Password** enter the password you set when exporting the file.
8. Click **Import**.
The confirmation screen is displayed.
9. Click **OK**.
The validation result is displayed.
 - Edit the information read
Click when you want to edit the information individually.
 - Read more file
Click when you want to import multiple files.
10. Click **Import**, and then click **OK** on the import completion screen.
Return to the device's property screen.
11. Click **Transmit**.
12. Click **OK** on the confirmation message.
The settings are sent to the scanner.
13. On the sending completion screen, click **OK**.
The scanner's information is updated.
Open the contacts from Web Config or scanner's control panel, and then check that the contact is updated.

Setting Up AirPrint

Access Web Config, select the **Network** tab, then select **AirPrint Setup**.

Items	Explanation
Bonjour Service Name	Enter a Bonjour service name, using ASCII text (0x20-0x7E) and up to 41 characters.
Bonjour Location	Enter a description of the scanner's location, using Unicode (UTF-8) text and up to 127 bytes.
Wide-Area Bonjour	Set whether or not to use Wide-Area Bonjour. If you use it, the scanner must be registered on the DNS server in order to search for the scanner over the segment.
Enable AirPrint	Bonjour and AirPrint (Scan service) are enabled.

Menu Options for Settings

Start-up Screen.	160
Basic Settings.	160
Scanner Settings.	161
User Settings.	162
Network Settings.	163
Web Service Settings.	164
Contacts Manager.	164
System Administration.	164
Device Information.	166
Scanner Maintenance.	166
Roller Replacement Alert Setting.	167
Regular Cleaning Alert Settings.	167

Start-up Screen

Set the initial items displayed on the LCD screen when the scanner turns on or when Operation Time Out is enabled.

- Home
- Presets
- Scan to Computer
- Scan to Network Folder/FTP
- Scan to Email
- Scan to Cloud
- Scan to USB Drive

Note:

You can also set from Web Config. Select **Device Management > Control Panel > Start-up Screen**.

Basic Settings

LCD Brightness

Adjust the brightness of the LCD screen.

Sounds

- Button Press: Set the volume for tapping sounds on the control panel.
- Error Tone: Set the volume for when an error occurs.

Sleep Timer

Adjust the time period for entering sleep mode (energy saving mode) when the scanner has not performed any operations. The LCD screen turns black when the set time has passed.

Note:

You can also set from Web Config. Select **Device Management > Power Saving > Sleep Timer**.

Power Off Settings

Your product may have this feature or the **Power Off Timer** feature depending on the location of purchase.

Turn off the scanner automatically.

- Power Off If Inactive

Select this setting to turn the scanner off automatically if it is not used for a specified period of time. Any increase will affect the product's energy efficiency. Please consider the environment before making any change.

- Power Off If Disconnected

Select this setting to turn the scanner off after a specified period of time when all ports including the USB port are disconnected. This feature may not be available depending on your region.

See the following website for the specified period of time.

<https://www.epson.eu/energy-consumption>

Date/Time Settings

- Date/Time: Enter the current date and time.
- Daylight Saving Time: Select the summer time setting that applies to your area.
- Time Difference: Enter the time difference between your local time and UTC (Coordinated Universal Time).

Language

Select the country or region in which you are using your scanner.

Keyboard

Change the layout of the keyboard on the LCD screen.

Operation Time Out

When set to **On**, you are returned to the Home screen when no operations have been performed for the specified time. This setting is applied when any screen other than the Home screen is displayed.

PC Connection via USB

You can restrict the usage of the USB connection from the computer. If you want to restrict it, select **Disable**.

Direct power on

Turn on the scanner directly when the scanner is connected to the power source, without pressing the power button.

Scanner Settings

Double Feed Stop Timing

Set the operation when any double feed is detected.

- Immediately: Stops feeding immediately after any double feed is detected.
- After Eject: Scans documents for which a double feed is detected as they are, but scanning of the next document is stopped.

When you are satisfied that there are no problems in the scanned image, you can continue scanning.

Paper Protection

To reduce damage to the document, scanning stops immediately when the following conditions are detected.

- A paper feed error has occurred
- An original is fed at an angle

To enable this feature, select the level of detection you want to use. See the following table for details on each level.

Level	Explanations
On-Low	Lower the sensitivity to detect the skew of the originals.

Level	Explanations
On-Medium	Detect the skew of the stapled originals and the skew that On-Low could not detect.
On-High	Increase the sensitivity to detect the skew of the originals.



Important:

- This feature does not prevent all originals from being damaged.
- Paper feed errors may not be detected depending on the condition of the originals being fed.

Note:

This feature may not work correctly depending on the original, the paper feeding conditions, and the level set.

- If false positives occur frequently, try lowering the level.
- If the original is an irregular shape or is scanned at an angle, it may be mistakenly detected as a paper feed error.
- When loading multiple originals, make sure to align the leading edge of the originals. Originals may be misdetected as feeding errors if the edges of the originals are not aligned, even if they are scanned correctly.
- Make sure you align the edge guides with the original to avoid scanning it at an angle.

Glass Dirt Detection

Detects dirt on the glass surface inside the scanner. You can select the level of detection.

Depending on the dirt, this feature may not work correctly.

Automatic Feeding Mode Timeout

Set the timeout when using Automatic Feeding Mode.

This setting is only available when scanning from "Network Folder/FTP", "Email", "Cloud", or "USB Drive". You can set the amount of time to finish scanning automatically when "Automatic Feeding Mode" is set to "On".

Confirm Recipient

Check destination before scanning.

User Settings

You can change the initial scanning settings for the following items.

- Scan to Network Folder/FTP
- Scan to Email
- Scan to Cloud
- Scan to USB Drive



Network Settings

Wi-Fi Setup

Set up or change wireless network settings. Choose the connection method from following and then follow the instructions on the control panel.

Wi-Fi (Recommended)

- Wi-Fi Setup Wizard
- Push Button Setup (WPS)
- Others
 - PIN Code Setup (WPS)
 - Wi-Fi Auto Connect
 - Disable Wi-Fi

You may be able to resolve network problems by disabling the Wi-Fi settings or making the Wi-Fi settings again. Tap   **Wi-Fi (Recommended) > Change Settings > Others > Disable Wi-Fi > Start Setup.**

Wi-Fi Direct

Displays the information to connect to the smartphone.

Tap **Change** to change the settings.

- Change Network Name
- Change Password
- Change Frequency Range

This setting may not be displayed depending on the region.

- Disable Wi-Fi Direct
- Restore Default Settings

Network Status

Displays the current network settings for the following items.

- Wi-Fi Status
- Wi-Fi Direct Status
- Email Server Status

Advanced

Make the following detailed settings.

- Device Name
- TCP/IP
- Proxy Server

- Email Server
 - Server Settings
 - Connection Check
- IPv6 Address
- Redirect HTTP to HTTPS
- IPsec/IP filtering
- IEEE802.1X

Web Service Settings

Epson Connect Services:

Displays whether the scanner is registered and connected to Epson Connect.

You can register to the service by selecting **Register** and follow the instructions.

When you have registered, you can change the following settings.

- Suspend/Resume
- Unregister

For details, see the following web site.

<https://www.epsonconnect.com/>

<http://www.epsonconnect.eu> (Europe only)

Contacts Manager

Register/Delete:

Register and/or delete contacts for the Scan to Email and Scan to Network Folder/FTP features.

Search Options:

Change the method for searching contacts.

System Administration

Contacts Manager

Register/Delete:

Register and/or delete contacts for the Scan to Email and Scan to Network Folder/FTP features.

Search Options:

Change the method for searching contacts.

Admin Settings

- Admin Password:** Register an administrator password that allows only an administrator to change the settings. Your password must be 8 to 20 characters long.
- Lock Setting:** Lock the scanner settings to protect them from being changed by other users.

Password Encryption

Encrypt your password.

If you turn the power off while restart is in progress, data may be damaged and the scanner settings are restored to defaults. In that case, set password information again.

Program Verification on Start Up:

Verifies the scanner's program when starting up.

When this feature is turned on, the scanner may take some time to start up.

Customer Research

Select **Approve** to provide product usage information such as the number of scans to Seiko Epson Corporation.

WSD Settings

Enable or disable the WSD (Web Service for Devices) feature.

When this is disabled, the WSD icon is hidden on the Home screen.

Restore Default Settings

- Network Settings:** Restore network related settings to their initial status.
- All Except Network Settings:** Restore other settings to their initial status except for network related settings.
- All Settings:** Restore all settings to their initial status when purchased.



Important:

*If you select **All Settings**, all setting data registered to the scanner including the contacts will be deleted. You cannot restore deleted settings.*

Firmware Update:

You can acquire scanner firmware information such as your current version and information on available updates.

Update:

Check if the latest version of the firmware has been uploaded to the network server. If an update is available, you can select whether or not to start updating.

Notification:

Select **On** to receive a notification if a firmware update is available.

Device Information

Serial Number

Displays the serial number of the scanner.

Current Version

Displays the current firmware version.

Total Number of Scans

Displays the total number of scans.

Number of 1-Sided Scans

Displays the number of single-sided scans.

Number of 2-Sided Scans

Displays the number of double-sided scans.

Number of Scans of Carrier Sheet

Displays the number of scans using a Carrier Sheet.

Number of Passport Carrier Sheet

Displays the number of scans using a Passport Carrier Sheet.

Number of Scans After Replacing Pickup Roller

Displays the number of scans after replacing the roller assembly kit.

Number of Scans After Regular Cleaning

Displays the number of scans after performing regular cleaning.

Reset the Number of Scans

Resets the number of scans. Select the function you want to reset from **Number of Scans After Replacing Pickup Roller** or **Number of Scans After Regular Cleaning**, and then press **Yes**.

Scanner Maintenance

Roller Replacement

Displays how to replace the roller assembly kit. You can also reset the number after replacing the roller assembly kit.

Regular Cleaning

Displays how to perform regular cleaning of the inside of the scanner. You can also reset the number of scans after performing regular cleaning.

Glass Cleaning

Displays how to perform cleaning for the scanner glass inside the scanner.

Roller Replacement Alert Setting

Count Alert Setting

Changes the scanning number when the roller replacement notification will be displayed.

Regular Cleaning Alert Settings

Warning Alert Setting

Notifies you when to clean inside of the scanner.

Count Alert Setting

Changes the scanning number when the cleaning notification will be displayed.

Useful Features

Setting the Glass Surface Stain Detection Feature.	169
Setting the Document Protection Feature.	170
Setting the Operation when a Double-feed is Detected.	171

Setting the Glass Surface Stain Detection Feature

Vertical lines (streaks) may appear in the image due to dust or dirt on the glass surface inside the scanner.

When **Detect Glass Dirt** is set to On, the scanner detects any stains on the glass surface inside the scanner and displays a notification on your computer screen.

When this notification is displayed, clean the glass surface inside the scanner with the dedicated cleaning kit or a soft cloth.

The default setting is **Off**.

1. Start Epson Scan 2 Utility.

- ❑ Windows 11

Click the start button, and then select **All apps > EPSON > Epson Scan 2 Utility**.

- ❑ Windows 10

Click the start button, and then select **EPSON > Epson Scan 2 Utility**.

- ❑ Windows 8.1/Windows 8

Enter the application name in the search charm, and then select the displayed icon.

- ❑ Windows 7

Click the start button, and then select **All Programs (or Programs) > EPSON > Epson Scan 2 > Epson Scan 2 Utility**.

- ❑ Mac OS

Select **Go > Applications > Epson Software > Epson Scan 2 Utility**.

2. Make the following settings on the **Scanner Setting** tab.

Set **Detect Glass Dirt** to **On-Low** or **On-High**.

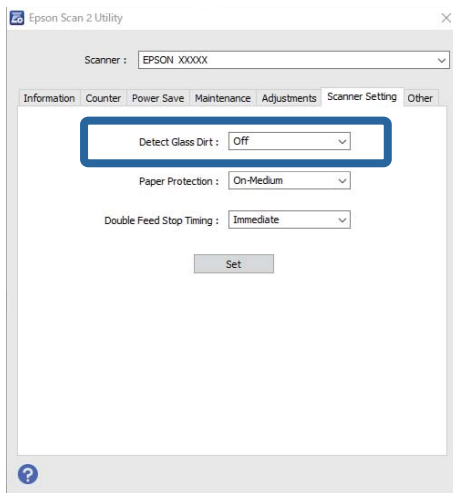

Note:

- ❑ Some stains may not be detected correctly.

- ❑ If detection does not work correctly, try changing the settings.

If no stains are detected, select **On-High**. If stains are detected incorrectly, select **On-Low** or **Off**.

3. Click **Set** to apply the settings to the scanner.

Note:

When using the control panel, tap **Settings > Scanner Settings > Glass Dirt Detection**, and then select the detection level.

Related Information

➔ [“Scanner Settings” on page 161](#)

Setting the Document Protection Feature

To reduce damage to the document, scanning stops immediately when the following conditions are detected.

- A paper feed error has occurred
- An original is fed at an angle
- The combination of the original and the scanner position does not match

The default setting is **On-Medium**.



Important:

- This feature does not prevent all originals from being damaged.
- Paper feed errors may not be detected depending on the condition of the originals being fed.

1. Start Epson Scan 2 Utility.

- Windows 11

Click the start button, and then select **All apps > EPSON > Epson Scan 2 Utility**.

- Windows 10

Click the start button, and then select **EPSON > Epson Scan 2 Utility**.

- Windows 8.1/Windows 8

Enter the application name in the search charm, and then select the displayed icon.

- Windows 7

Click the start button, and then select **All Programs (or Programs) > EPSON > Epson Scan 2 > Epson Scan 2 Utility**.

- Mac OS

Select **Go > Applications > Epson Software > Epson Scan 2 Utility**.

2. Make the following settings on the **Scanner Setting** tab.

Set **Paper Protection** to **On-Low**, **On-Medium** or **On-High**.

To enable this feature, select the level of detection you want to use. See the following table for details on each level.

Level	Explanations
On-Low	Lower the sensitivity to detect the skew of the originals.
On-Medium	Detect the skew of the stapled originals and the skew that On-Low could not detect.

Level	Explanations
On-High	Increase the sensitivity to detect the skew of the originals.

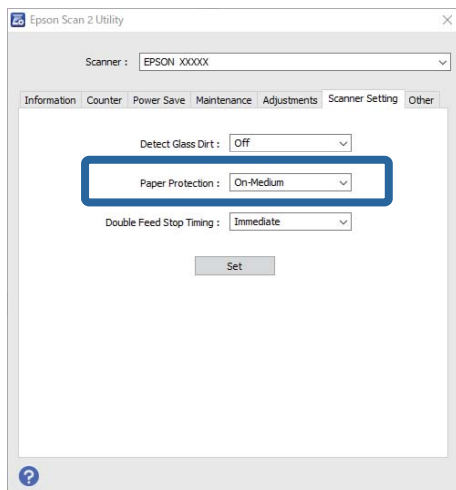

Note:

- This feature may not work correctly depending on the original, the paper feeding conditions, and the level set.
- If false positives occur frequently, try lowering the level.
- If the original is an irregular shape or is scanned at an angle, it may be mistakenly detected as a paper feed error.
- When loading multiple originals, make sure to align the leading edge of the originals. Originals may be misdetected as feeding errors if the edges of the originals are not aligned, even if they are scanned correctly.
- Make sure you align the edge guides with the original to avoid scanning it at an angle.

3. Click **Set** to apply the settings to the scanner.

Note:

When using the control panel, tap **Settings > Scanner Settings > Paper Protection**, and then select the protection level.

Related Information

➔ [“Scanner Settings” on page 161](#)

Setting the Operation when a Double-feed is Detected

Set the timing to stop operations when any double feed of originals is detected.

- Immediate:** Stops immediately after any double feed is detected.
- After Eject:** Scans documents for which a double feed is detected as they are, but scanning of the next document is stopped.

When you are satisfied that there are no problems in the scanned image, you can continue scanning.

The default setting is **Immediate**.

1. Start Epson Scan 2 Utility.

- Windows 11

Click the start button, and then select **All apps > EPSON > Epson Scan 2 Utility**.

Windows 10

Click the start button, and then select **EPSON > Epson Scan 2 Utility**.

Windows 8.1/Windows 8

Enter the application name in the search charm, and then select the displayed icon.

Windows 7

Click the start button, and then select **All Programs (or Programs) > EPSON > Epson Scan 2 > Epson Scan 2 Utility**.

Mac OS

Select **Go > Applications > Epson Software > Epson Scan 2 Utility**.

2. Make the following settings on the **Scanner Setting** tab.

Set **Double Feed Stop Timing** to **Immediate** or **After Eject**.

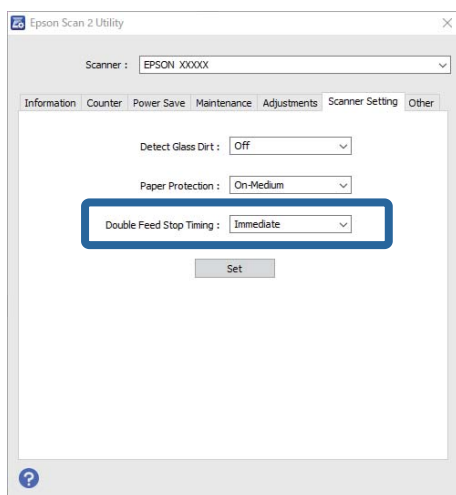

3. Click **Set** to apply the settings to the scanner.

Note:

When using the control panel, tap **Settings > Scanner Settings > Double Feed Stop Timing** to set the stop timing.

Related Information

➔ [“Scanner Settings” on page 161](#)

Maintenance

Cleaning Outside the Scanner.	174
Cleaning Inside the Scanner.	174
Replacing the Roller Assembly Kit.	182
Energy Saving.	190
Moving the Scanner.	191
Updating Applications and Firmware.	192

Cleaning Outside the Scanner

Wipe off any stains on the outer case with a dry cloth or a cloth dampened with mild detergent and water.

 **Important:**

- Never use alcohol, thinner, or any corrosive solvent to clean the scanner. Deformation or discoloration may occur.
- Do not let water get inside the product. This could cause a malfunction to occur.
- Never open the scanner case.

1. Press the  button to turn off the scanner.
2. Unplug the AC adapter from the scanner.
3. Clean the outer case with a cloth dampened with mild detergent and water.

Note:

Wipe the touchscreen by using a soft, dry cloth.

Cleaning Inside the Scanner

After using the scanner for a while, paper and room dust on the roller or the glass part inside the scanner may cause paper feed or scanned image quality problems. Clean the inside of the scanner every 5,000 scans.

You can check the latest number of scans on the control panel or in the Epson Scan 2 Utility.

If a surface is stained with a hard-to-remove material, use a genuine Epson cleaning kit to remove stains. Use a small amount of cleaner on the cleaning cloth to remove the stains.

 **Caution:**

Be careful not to get your hands or hair caught in the gears or rollers when cleaning the inside the scanner. This could cause an injury.

 **Important:**

- Never use alcohol, thinner, or any corrosive solvent to clean the scanner. Doing so could cause deformation or discoloration to occur.
- Never spray any liquid or lubricant on the scanner. Damage to equipment or circuits may cause abnormal operations.
- Never open the scanner case.

Note:

- You can set cleaning time notifications and alerts after making a certain number of scans on the control panel or in the Epson Scan 2 Utility. By default, a notification is sent after every 5,000 scans.
- Clean inside the scanner while it is turned on.

1. **Wipe off any stains on the roller.** Open the vertical path cover.

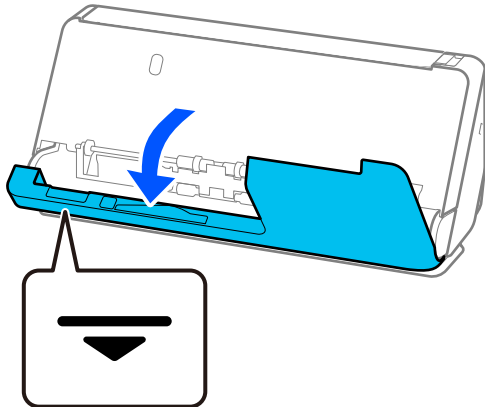

! **Important:**

When opening the vertical path cover, hold the area indicated to avoid touching the antistatic brush. If the brush becomes bent it cannot eliminate static electricity, and this may cause the output originals to stick to each other.

2. Wipe the rollers (4 locations) and the plastic rollers (4 locations). Wipe with a soft, lint-free cloth dampened with a small amount of dedicated cleaner or water.

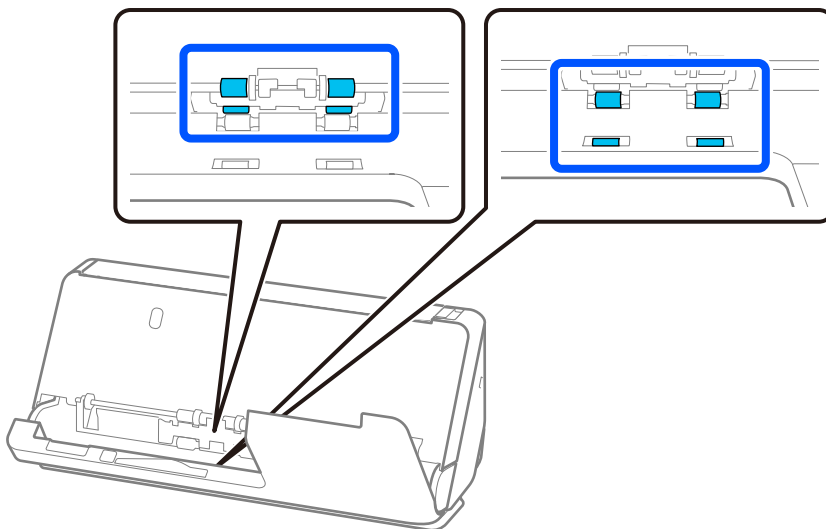

! **Important:**

Be careful not to touch the antistatic brush when wiping the rollers. If the brush becomes bent it cannot eliminate static electricity, and this may cause the output originals to stick to each other.

3. Open the input tray, and pull the lever to open the scanner cover.

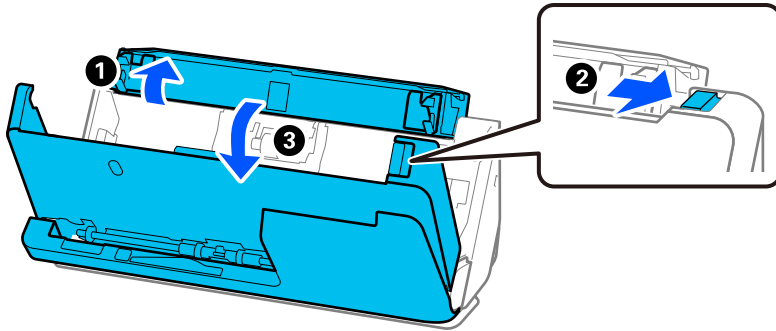

4. Wipe the rollers (8 locations). Wipe with a soft, lint-free cloth dampened with a small amount of dedicated cleaner or water.

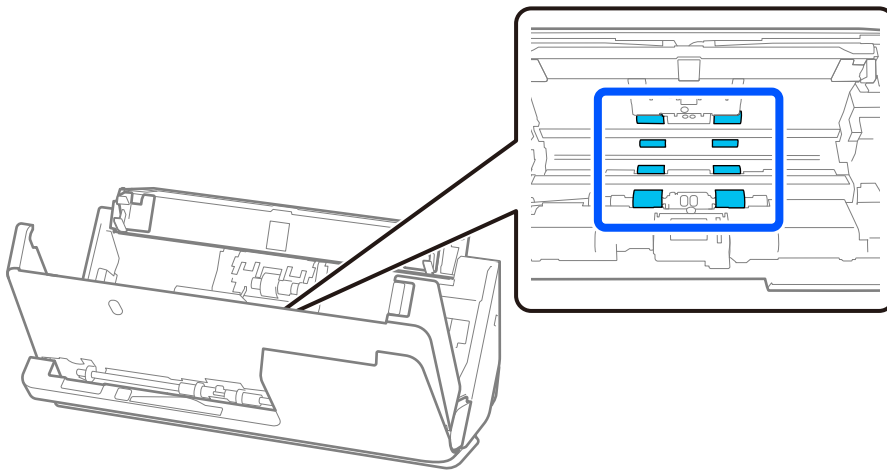

5. Close the scanner cover with both hands. Next, close the vertical path cover and then the input tray, in that order.

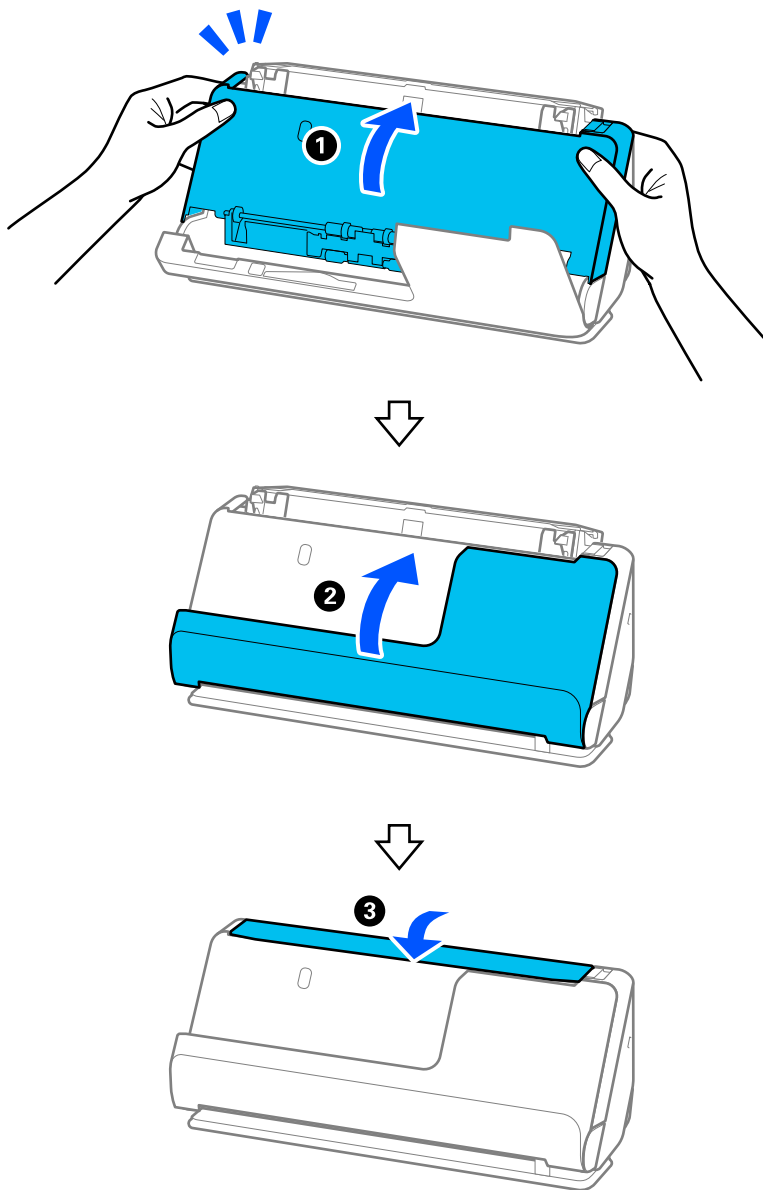

When the message **Recovering** is removed from the screen, proceed to the next step.

6. Repeat steps 1 to 5 four times.

The internal rollers rotate approximately one-quarter of a turn each time the cover is closed. Repeat this step until the entire roller is clean.

Note:

If paper dust adheres to the inside of the vertical path cover, wipe it off with a soft, lint-free cloth.

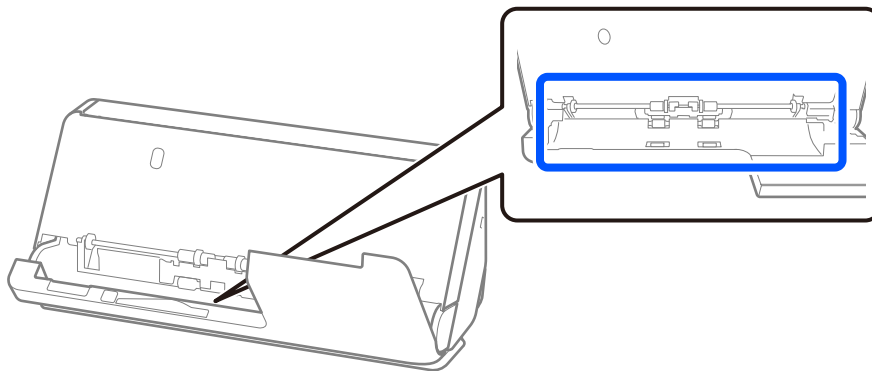

7. **Wipe off any stains inside the scanner.** Open the input tray, and pull the lever to open the scanner cover.

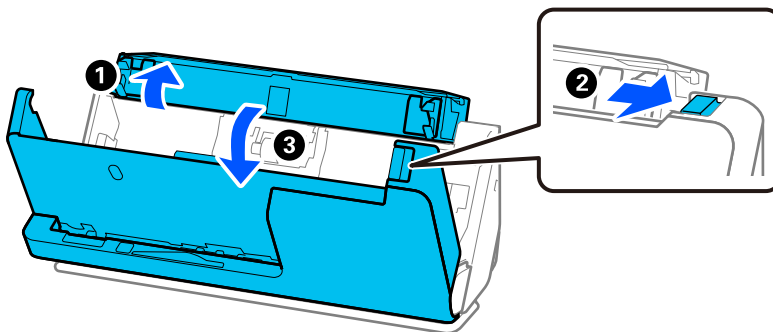

8. Wipe the glass surface inside the scanner cover. Wipe with a dedicated cleaning cloth or a soft, lint-free cloth. If the glass surface is very dirty, wipe with a soft, lint-free cloth dampened with a small amount of dedicated cleaner or water.



Important:

- ❑ Do not place too much force on the glass surface.
- ❑ Do not use a brush or a hard tool. Any scratches on the glass may affect the scan quality.
- ❑ Do not spray cleaner directly onto the glass surface.

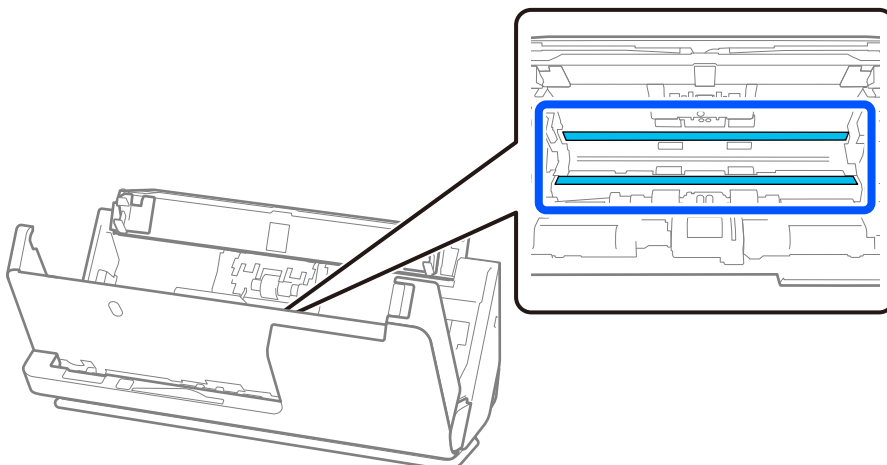

9. Wipe the sensors (4 locations) with a cotton swab.

! *Important:*

Do not use liquid such as a cleaner on a cotton swab.

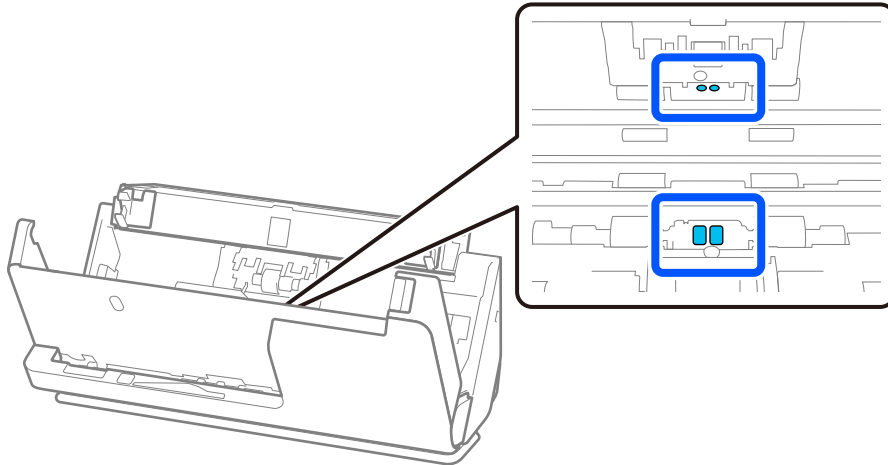

10. **Wipe off any stains on the separation roller.** Open the cover, and then remove the separation roller.

See “Replacing the Roller Assembly Kit” for more details.

[“Replacing the Roller Assembly Kit” on page 182](#)

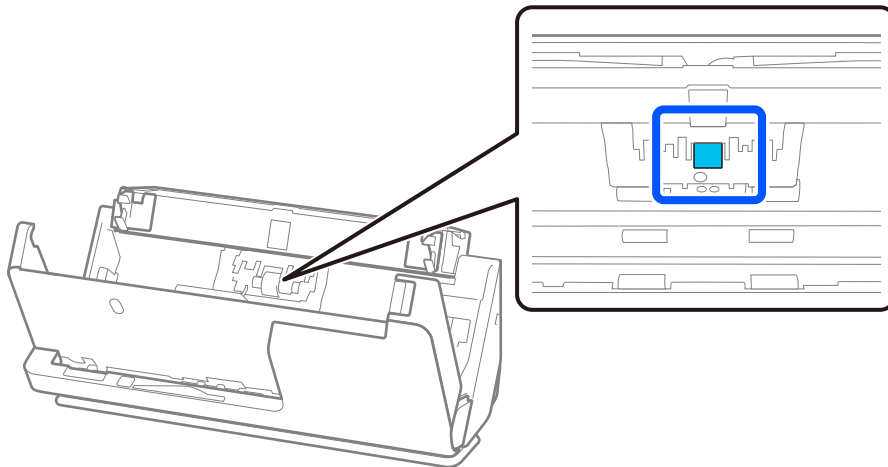

11. Wipe the separation roller. Wipe with a soft, lint-free cloth dampened with a small amount of dedicated cleaner or water.

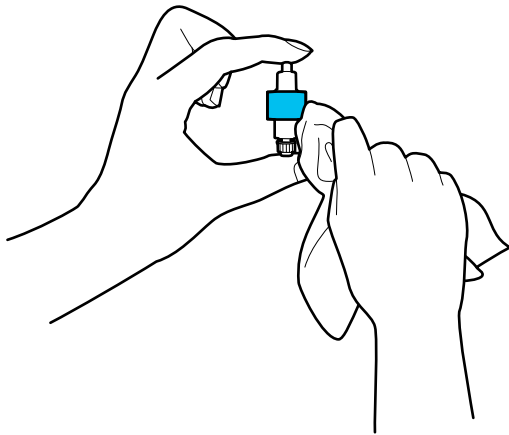

Important:

Use only a moist cloth to clean the roller. Using a dry cloth may damage the surface of the roller.

12. Install the separation roller.
See “Replacing the Roller Assembly Kit” for more details on installing.
13. **Wipe off any stains on the pickup roller.** Open the cover, and then remove the pickup roller.
See “Replacing the Roller Assembly Kit” for more details.
[“Replacing the Roller Assembly Kit” on page 182](#)

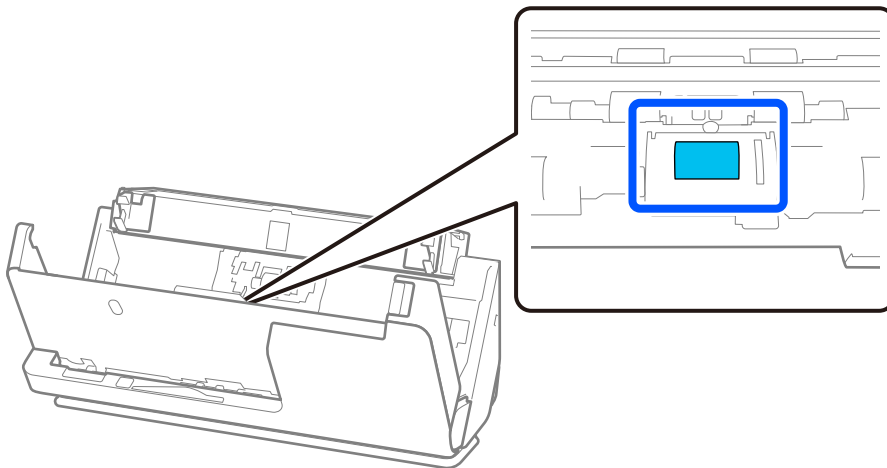

14. Wipe the pickup roller. Wipe with a soft, lint-free cloth dampened with a small amount of dedicated cleaner or water.

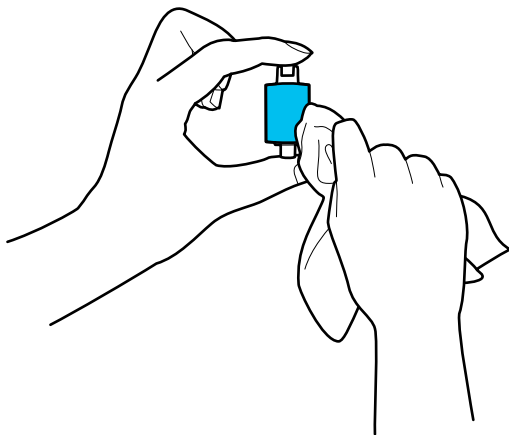

! *Important:*

Use only a moist cloth to clean the roller. Using a dry cloth may damage the surface of the roller.

15. Install the pickup roller.
See “Replacing the Roller Assembly Kit” for more details on installing.
16. Close the scanner cover with both hands. Next, close the input tray.

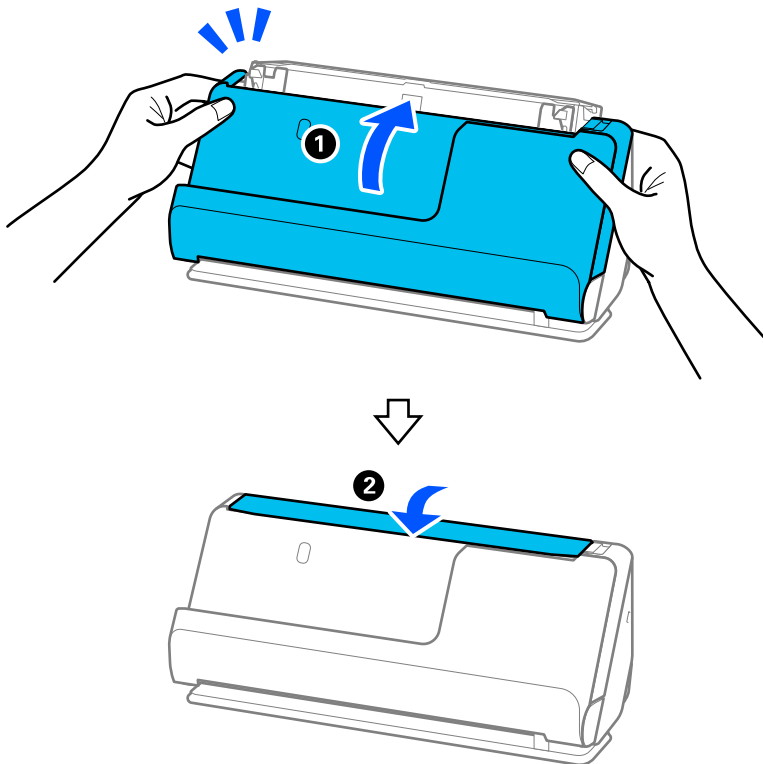

17. Reset the scan number on the control panel.

Related Information

- ➔ “Cleaning Kit Codes” on page 41
- ➔ “Replacing the Roller Assembly Kit” on page 182

Resetting the Number of Scans After Cleaning Inside the Scanner

After performing regular cleaning, reset the scan number on the control panel or by using the Epson Scan 2 Utility. This section explains how to reset using the control panel.

1. Tap **Scanner Maintenance** on the home screen.
2. Tap **Regular Cleaning**.
3. Tap **Reset the Number of Scans**.
4. Tap **Yes**.

Note:

To reset from the Epson Scan 2 Utility, start the Epson Scan 2 Utility, click the **Maintenance** tab, and then click **Reset in Regular Cleaning**. If you cannot click **Reset**, select **Regular Cleaning Alert**.

Replacing the Roller Assembly Kit

The roller assembly kit (the pickup roller and the separation roller) needs to be replaced when the number of scans exceeds the life cycle of the rollers. When a replacement message is displayed on the control panel or your computer screen, follow the steps below to replace it.

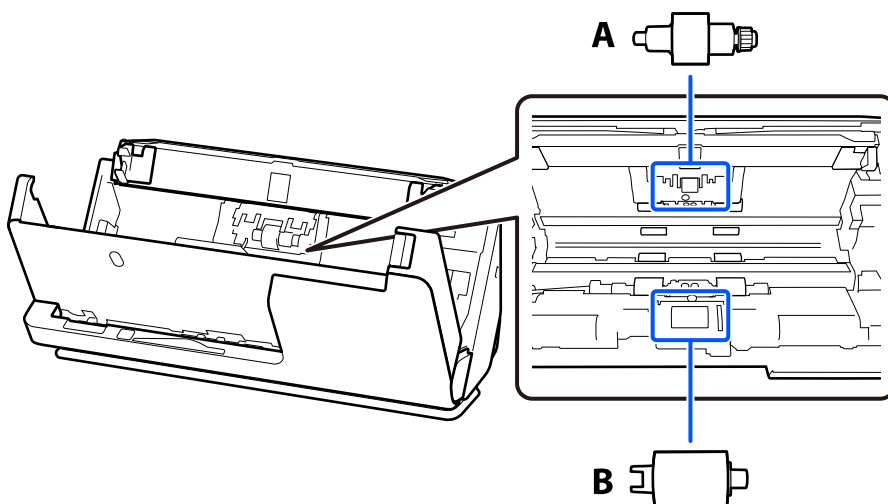

A: Separation Roller, B: Pickup roller

Note:

Replace the roller assembly kit while the scanner is turned on.

1. Open the input tray, and pull the lever to open the scanner cover.

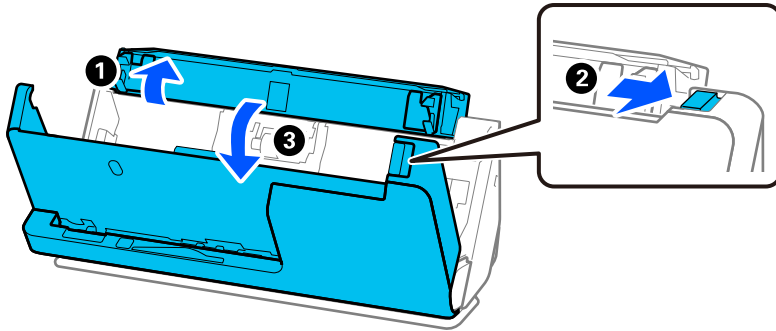

2. Remove the separation roller cover as shown.

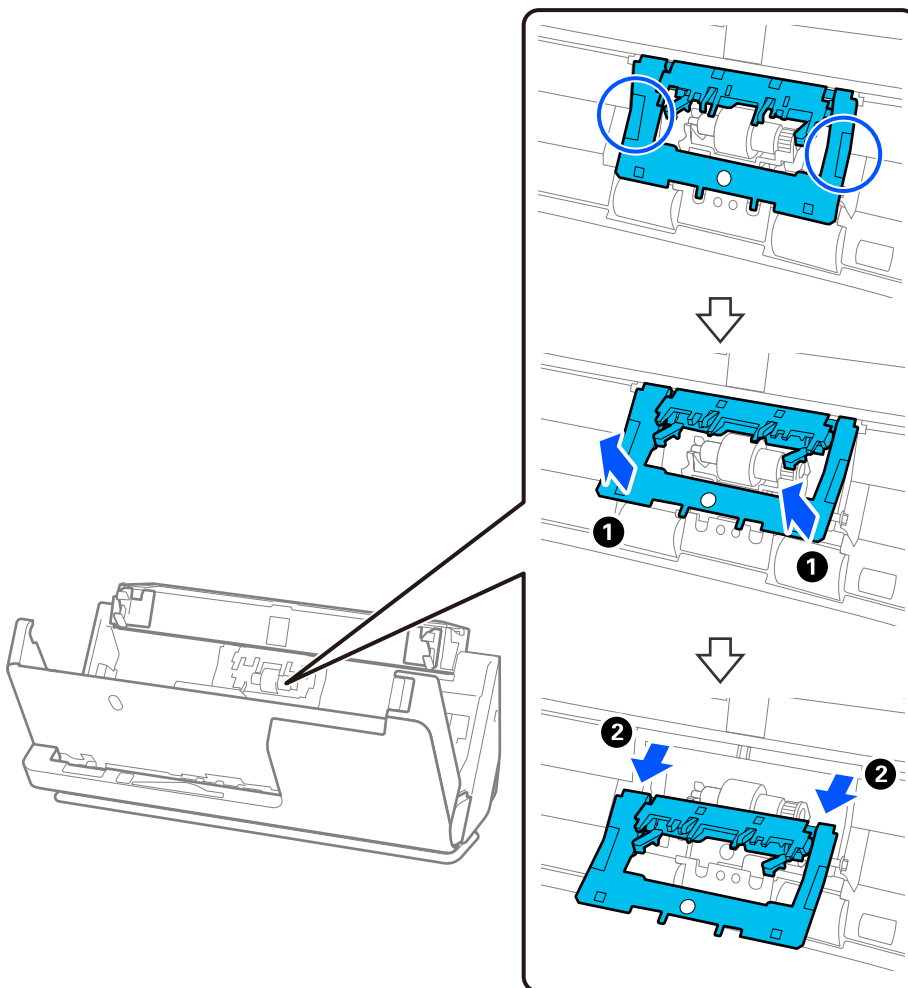

3. Remove the separation roller as shown.

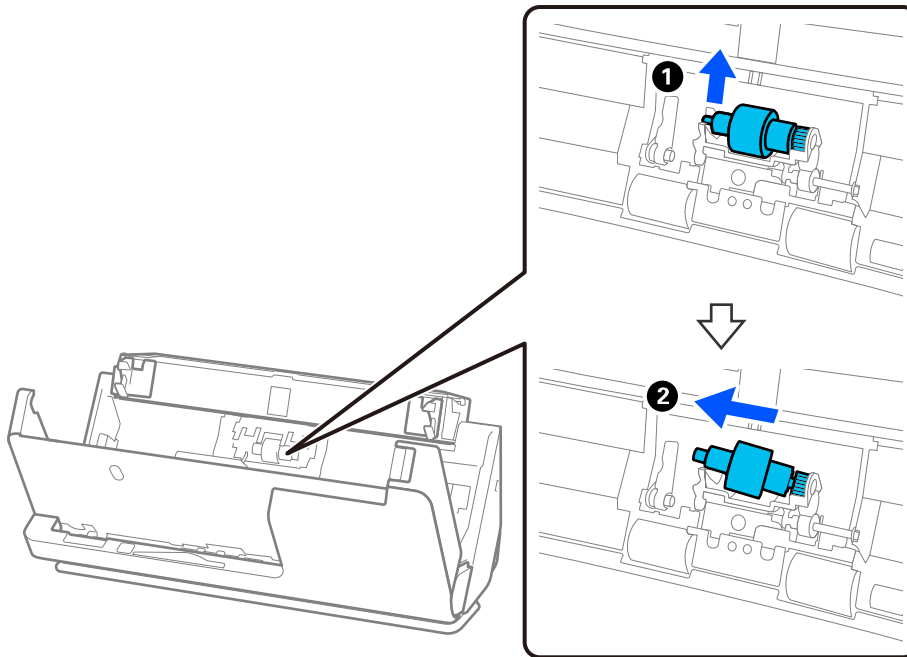

Important:

Do not pull out the separation roller forcibly. This could damage the inside of the scanner.

4. Attach the new separation roller as shown. Insert the axis of the separation roller into the hole on the right side, and then lower the separation roller.

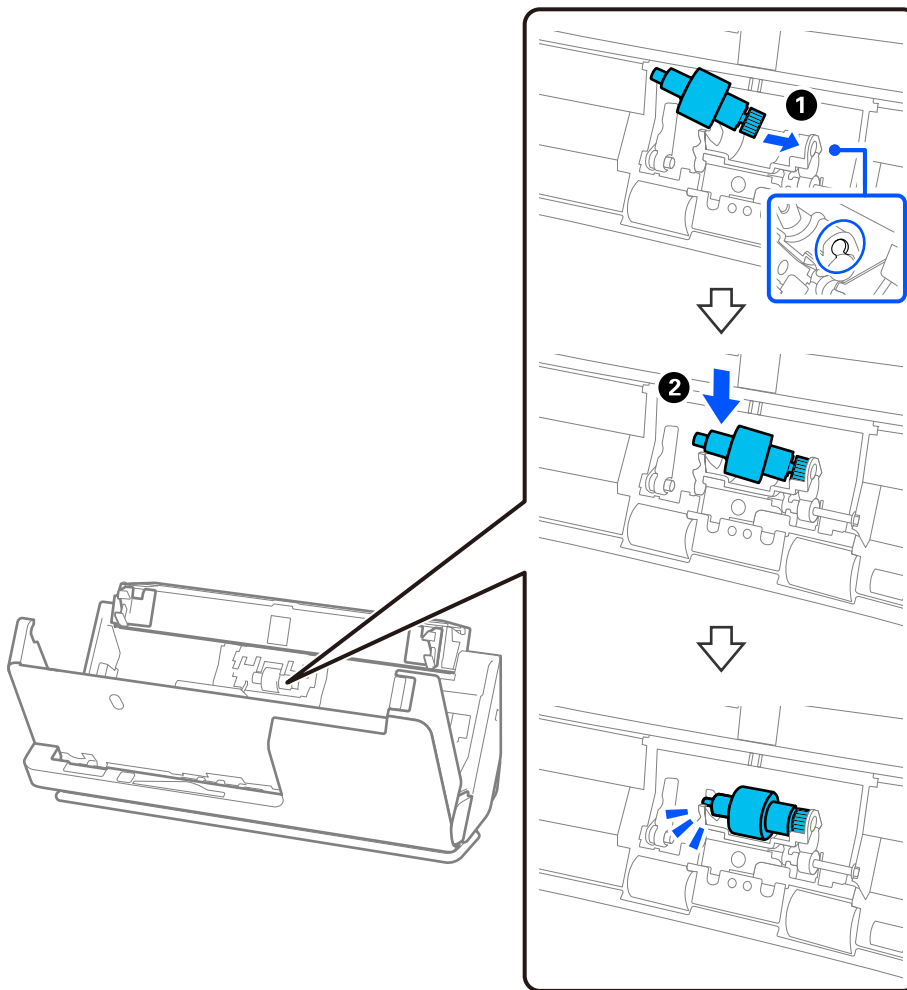

5. Attach the separation roller cover as shown. Insert the axis on the upper side of the cover into the grooves, and then close the cover firmly.

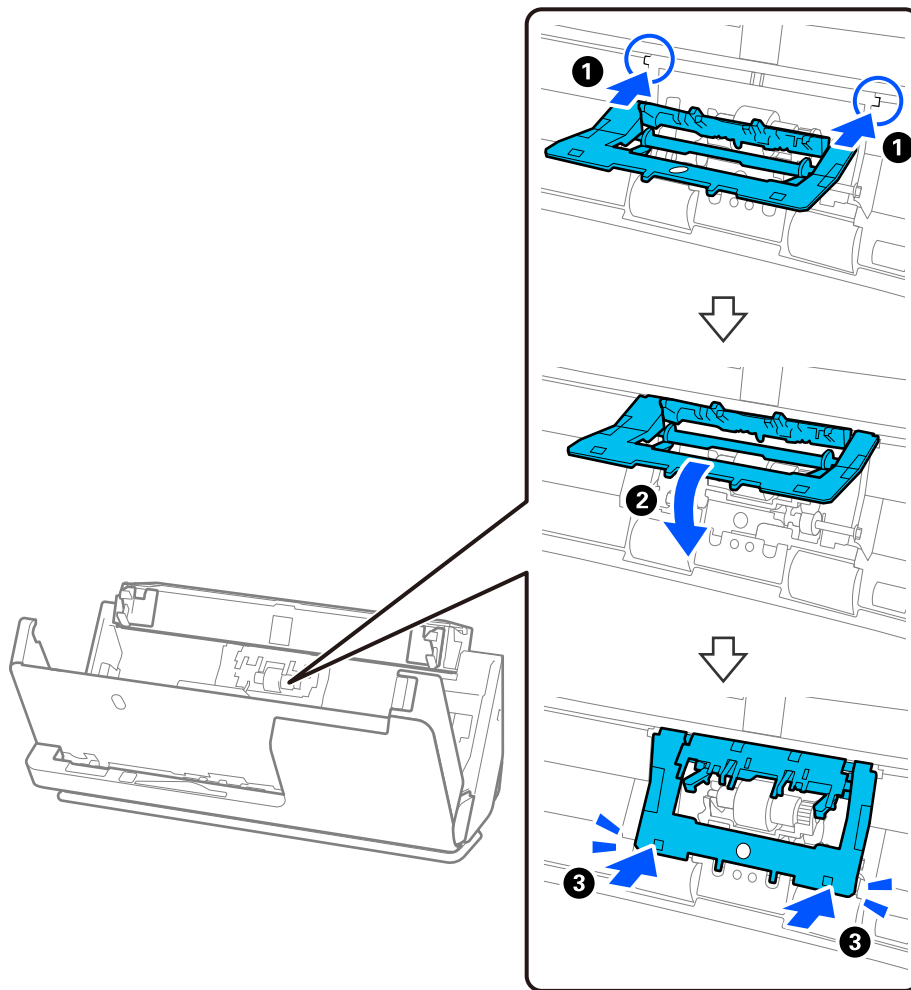

! *Important:*

- Make sure the cover is closed correctly.*
- If the cover is hard to close, make sure the separation rollers are installed correctly.*
- Do not install the cover while it is raised.*

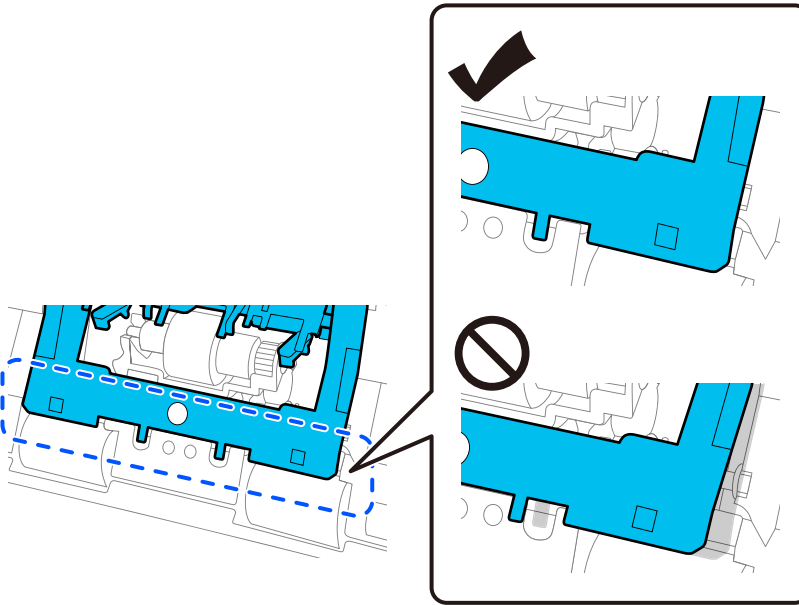

6. Open the cover of the pickup roller.

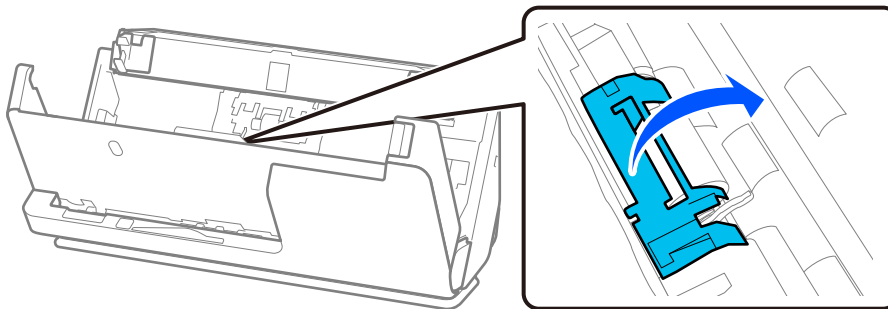

7. Remove the pickup roller as shown.

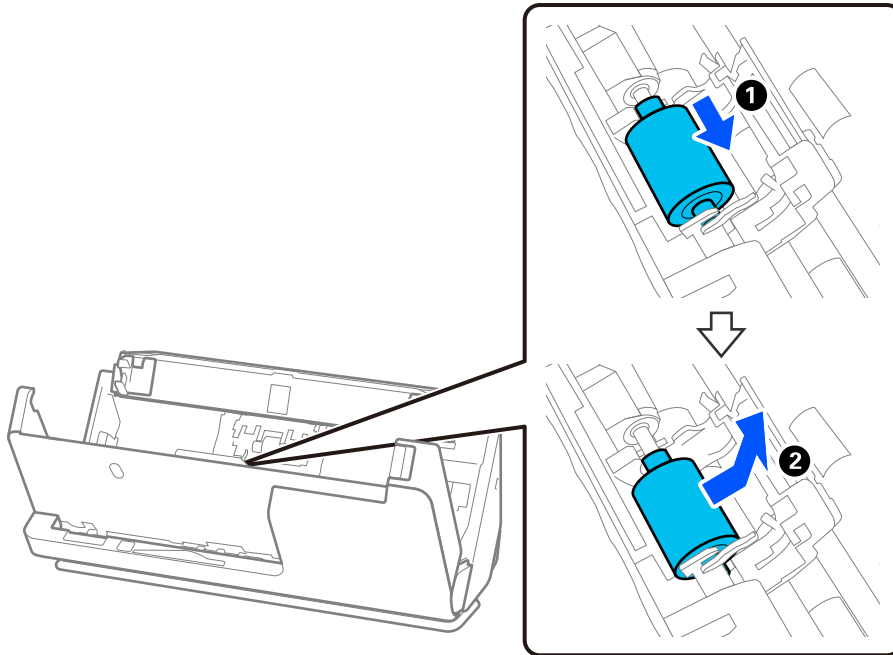

8. Attach the new pickup roller as shown. Insert the indentations at the ends of the pickup roller onto the axis on the scanner, lower the pickup roller, and then slide it to the back.

Make sure the indentations are aligned.

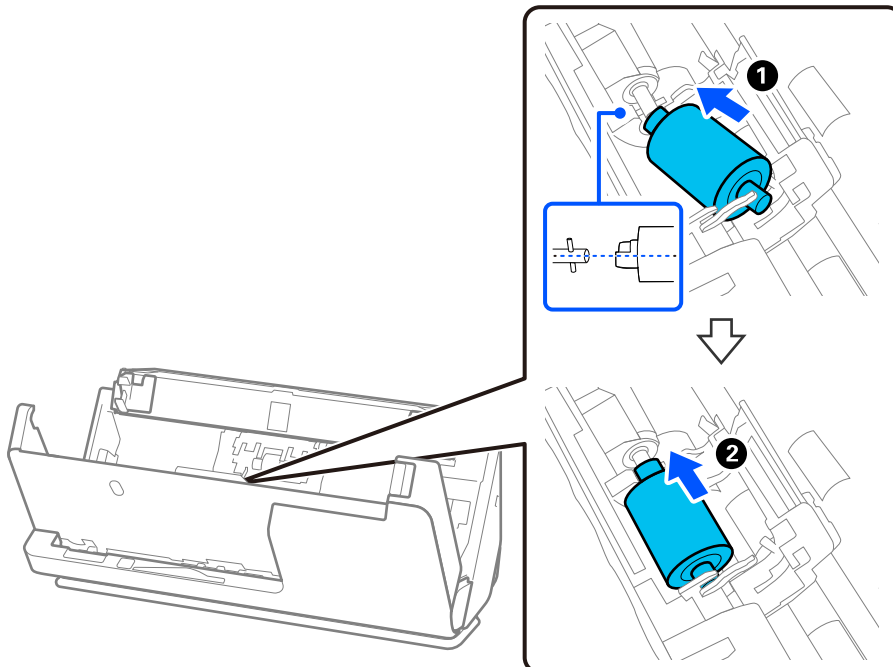

9. Close the pickup roller cover.

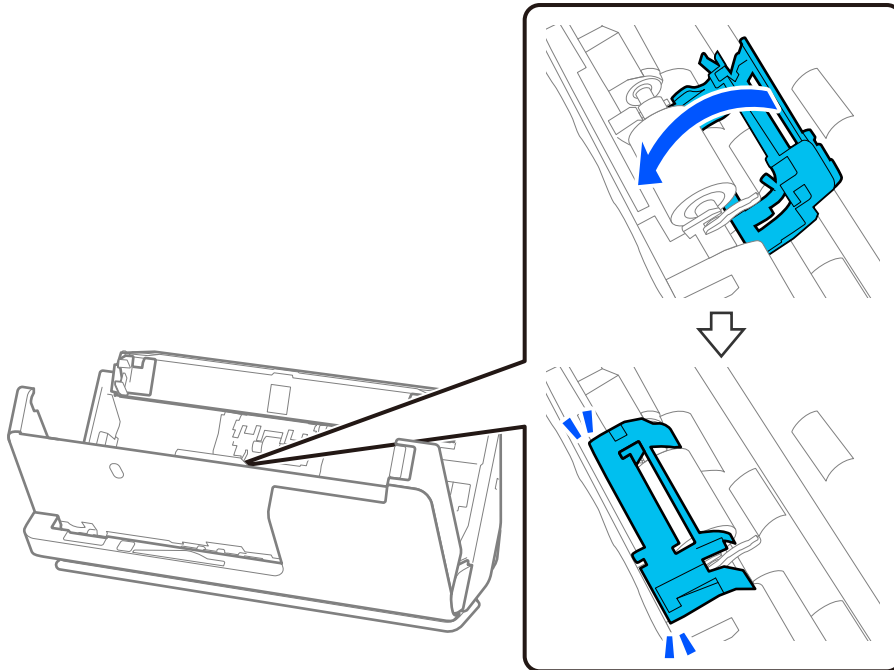

! *Important:*

If the cover is hard to close, make sure the pickup rollers are installed correctly, and that the protruding parts are aligned.

10. Close the scanner cover with both hands. Next, close the input tray.

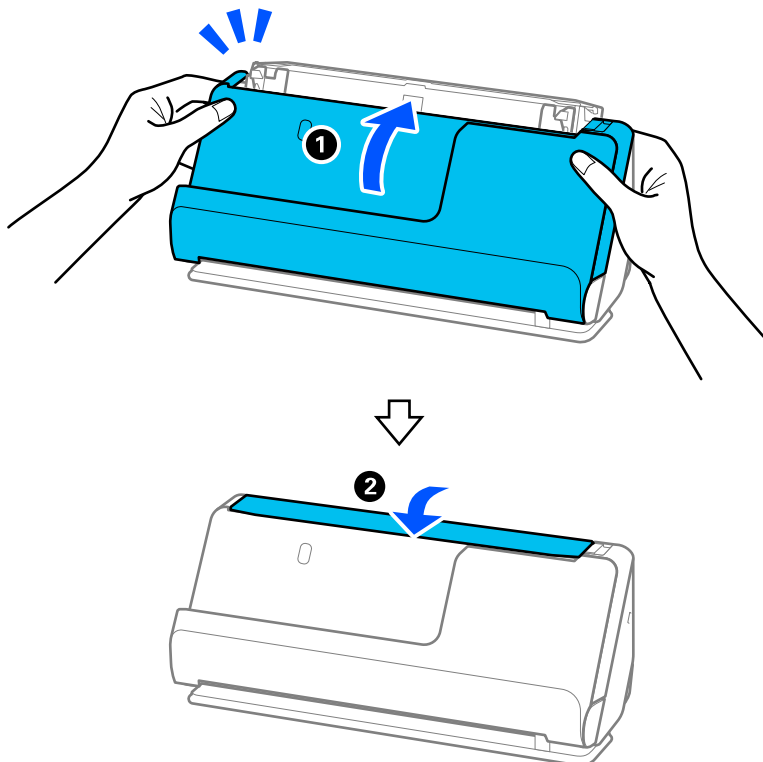

11. Reset the scan number on the control panel.

Note:

Dispose of the pickup roller and the separation roller following the rules and regulations of your local authority. Do not disassemble them.

Related Information

- ➔ [“Roller Assembly Kit Codes” on page 41](#)

Resetting the Number of Scans After Replacing the Rollers

Reset the number of scans using the control panel or Epson Scan 2 Utility after replacing the roller assembly kit.

This section explains how to reset using the control panel.

1. Tap **Scanner Maintenance** on the home screen.
2. Tap **Roller Replacement**.
3. Tap **Reset the Number of Scans**.
4. Tap **Yes**.

Note:

To reset from the Epson Scan 2 Utility, start the Epson Scan 2 Utility, click the **Counter** tab, and then click **Reset in Roller Assembly Kit**.

Related Information

- ➔ [“Replacing the Roller Assembly Kit” on page 182](#)

Energy Saving

You can save energy by using the sleep mode or auto power off mode when no operations are performed by the scanner. You can set the time period before the scanner enters sleep mode and turns off automatically. Any increase will affect the product's energy efficiency. Please consider the environment before making any changes.

1. Select **Settings** on the home screen.
2. Select **Basic Settings**.
3. Select **Sleep Timer** or **Power Off Settings**, and then make settings.

Note:

Available features may vary depending on the location of purchase.

Moving the Scanner

Transporting the Scanner

When you need to transport the scanner, follow the steps below to pack the scanner.

1. Press the  button to turn off the scanner.
2. Unplug the AC adapter.
3. Remove the cables and the devices.
4. Store the input tray extension, and close the input tray.
When the output support is extended, retract it completely.

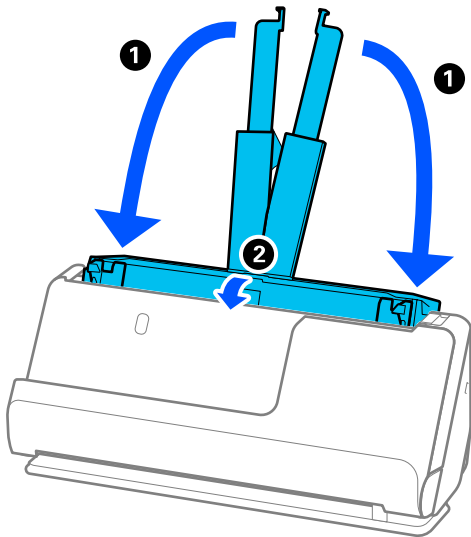

5. Set the scanner in the vertical path position.

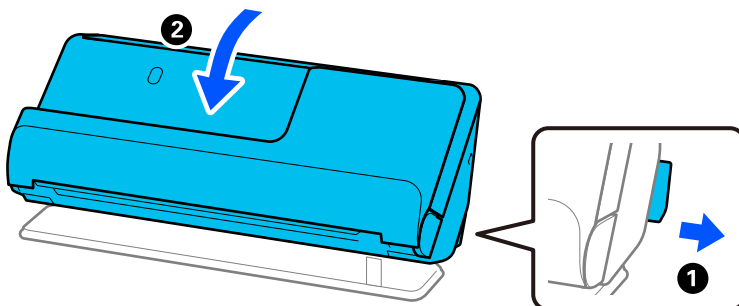

6. Attach the protective materials that came with the scanner, and then repack it in its original box or a similar sturdy box.

How to Carry the Scanner

When carrying the scanner, hold it as shown in the following figure.

When carrying with one hand

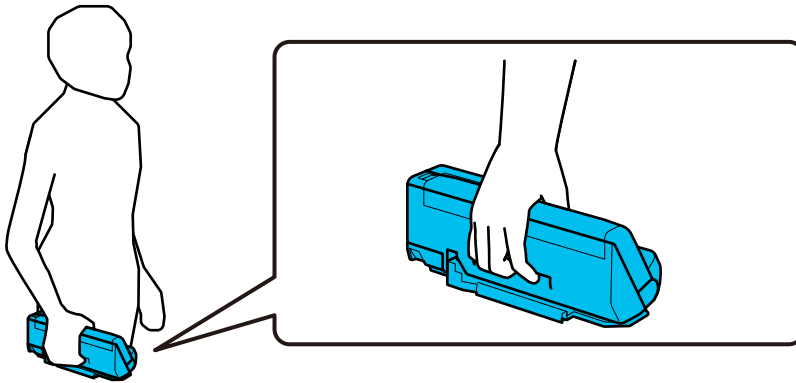

When carrying with both hands

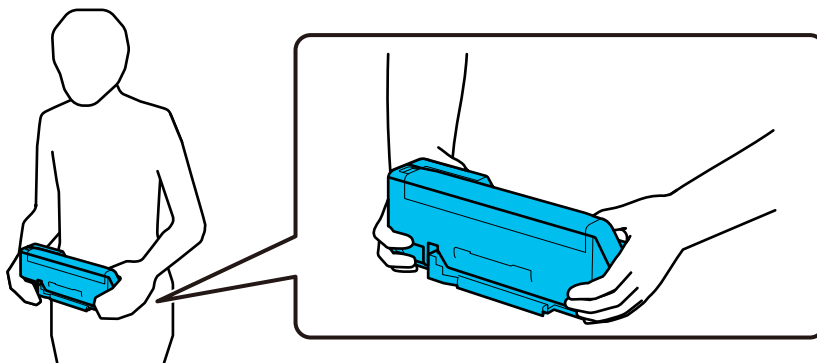

Note:

When carrying the scanner, disconnect all cables, stow the tray support, and place the scanner in the vertical path position.

[“Transporting the Scanner” on page 191](#)

Updating Applications and Firmware

You may be able to clear certain problems and improve or add functions by updating the applications and the firmware. Make sure you use the latest version of the applications and firmware.

! **Important:**

- ❑ Do not turn off the computer or the scanner while updating.

Note:

When the scanner can connect to the Internet, you can update the firmware from Web Config. Select the **Device Management** tab > **Firmware Update**, check the displayed message, and then click **Start**.

1. Make sure that the scanner and the computer are connected, and the computer is connected to the internet.

2. Start EPSON Software Updater, and update the applications or the firmware.

Windows 11

Click the start button, and then select **All apps > Epson Software > EPSON Software Updater**.

Windows 10

Click the start button, and then select **Epson Software > EPSON Software Updater**.

Windows 8.1/Windows 8

Enter the application name in the search charm, and then select the displayed icon.

Windows 7

Click the start button, and then select **All Programs or Programs > Epson Software > EPSON Software Updater**.

Mac OS

Select **Finder > Go > Applications > Epson Software > EPSON Software Updater**.

Note:

If you cannot find the application you want to update in the list, you cannot update using the EPSON Software Updater. Check for the latest versions of the applications on your local Epson website.

<http://www.epson.com>

Updating the Scanner's Firmware using the Control Panel

If the scanner can be connected to the Internet, you can update the scanner's firmware using the control panel. You can also set the scanner to regularly check for firmware updates and notify you if any are available.

1. Select **Settings** on the home screen.
2. Select **System Administration > Firmware Update > Update**.

Note:

Select **Notification > On** to set the scanner to regularly check for available firmware updates.

3. Check the message displayed on the screen and start searching for available updates.
4. If a message is displayed on the LCD screen informing you that a firmware update is available, follow the on-screen instructions to start the update.



Important:

- Do not turn off or unplug the scanner until the update is complete; otherwise, the scanner may malfunction.
- If the firmware update is not completed or is unsuccessful, the scanner does not start up normally and "Recovery Mode" is displayed on the LCD screen the next time the scanner is turned on. In this situation, you need to update the firmware again using a computer. Connect the scanner to the computer with a USB cable. While "Recovery Mode" is displayed on the scanner, you cannot update the firmware over a network connection. On the computer, access your local Epson website, and then download the latest scanner firmware. See the instructions on the website for the next steps.

Updating Firmware Using Web Config

When the scanner can connect to the Internet, you can update the firmware from Web Config.

1. Access Web Config and select the **Device Management** tab > **Firmware Update**.
2. Click **Start**, and then follow the on-screen instructions.

The firmware confirmation starts, and the firmware information is displayed if the updated firmware exists.

Note:

You can also update the firmware using Epson Device Admin. You can visually confirm the firmware information on the device list. It is useful when you want to update multiple devices' firmware. See the Epson Device Admin guide or help for more details.

Related Information

➔ [“Application for Configuring Scanner Operations \(Web Config\)” on page 36](#)

Updating Firmware without Connecting to the Internet

You can download the device's firmware from Epson website on the computer, and then connect the device and the computer by USB cable to update the firmware. If you cannot update over the network, try this method.

Note:

Before updating, make sure that the scanner driver Epson Scan 2 is installed on your computer. If Epson Scan 2 is not installed, install it again.

1. Check the Epson website for the latest firmware update releases.
<http://www.epson.com>
 - If there is the firmware for your scanner, download it and go to the next step.
 - If there is no firmware information on the website, you are already using the latest firmware.
2. Connect the computer that contains the downloaded firmware to the scanner by USB cable.
3. Double-click the downloaded .exe file.
Epson Firmware Updater starts.
4. Follow the on-screen instructions.

Solving Problems

Problems with the Scanner.	196
Problems when Preparing Network Scanning.	198
Problems Starting Scanning.	200
Paper Feeding Problems.	209
Scanned Image Problems.	218
Uninstalling and Installing Applications.	223

Problems with the Scanner

Checking Error Messages on the Control Panel

If an error message is displayed on the control panel, follow the on-screen instructions or the solutions below to solve the problem.

Note:

See the following if an error message is displayed when scanning to a network folder.

[“Messages are Displayed on the Control Panel when Scanning to a Network Folder” on page 207](#)

Error Messages	Solutions
Feeding stopped to protect originals. Open the scanner cover and remove them.	<ul style="list-style-type: none"> <input type="checkbox"/> Remove the original from inside the scanner and check the condition of the original. <input type="checkbox"/> This product uses two different positions for scanning, depending on the original being scanned. Check the link to see which position is appropriate for your original. “Combinations of Originals and Scanner Position” on page 53
The original jammed. Open the scanner cover to remove the original.	<ul style="list-style-type: none"> <input type="checkbox"/> Remove the original from inside the scanner. <input type="checkbox"/> This product uses two different positions for scanning, depending on the original being scanned. Check the link to see which position is appropriate for your original. “Combinations of Originals and Scanner Position” on page 53
Install the Epson ScanSmart software on the computer to use this feature. See your documentation for more details.	<p>Open the application list on your computer, and then check the list to find Epson ScanSmart.</p> <p>If the software is not installed on your computer, install the application by following the instructions on the website below.</p> <p>https://epson.sn</p>
Check the following if a computer is not found. - Connection between the scanner and the computer (USB or network) - Installation of the necessary software - Power supply to the computer - Firewall and security software settings - Search again See your documentation for more details.	<ul style="list-style-type: none"> <input type="checkbox"/> Make sure the scanner is connected to your computer properly. <input type="checkbox"/> Install Epson ScanSmart on your computer. <input type="checkbox"/> Install the latest version of the application. <input type="checkbox"/> Make sure the AC adapter is securely connected to the scanner and an electrical outlet. Check that the electrical outlet is working. Plug another device into the electrical outlet and check that you can turn the power on. <input type="checkbox"/> Check the firewall settings for Epson software. <input type="checkbox"/> Set the same group for the scanner and the computer. <input type="checkbox"/> Search for the computer again.

Error Messages	Solutions
Inside the scanner may have some stains. Please clean the scanner.	See the following section to clean inside the scanner. “Cleaning Inside the Scanner” on page 174
The original may be smeared or inside the scanner may have some stains. Remove smears on the original, and then clean inside the scanner.	If the problem continues to occur after you have performed cleaning, contact your local dealer.
The combination of the IP address and the subnet mask is invalid. See your documentation for more details.	Enter the correct IP address or default gateway. Contact the person who setup the network for assistance.
RECOVERY MODE	The scanner has started in recovery mode because the firmware update failed. Follow the steps below to try to update the firmware again. 1. Connect the computer and the scanner with a USB cable. (During recovery mode, you cannot update the firmware over a network connection.) 2. Visit your local Epson website for further instructions.

Related Information

- ➔ [“Updating Applications and Firmware” on page 192](#)
- ➔ [“Removing Jammed Originals from the Scanner” on page 210](#)
- ➔ [“Installing Your Applications” on page 224](#)

The Scanner Does Not Turn On

- Make sure the AC adapter is securely connected to the scanner and an electrical outlet.
- Check that the electrical outlet is working. Plug another device into the electrical outlet and check that you can turn the power on.

Forgot Your Administrator's Password

You need help from service personnel. Contact your local dealer.

Note:

The following provides the initial values for the Web Config administrator.

- User name: none (blank)
- Password: Depends on the label attached to product.

If there is a "PASSWORD" label attached to the back, enter the 8-digit number shown on the label.

If there is no "PASSWORD" label attached, enter the serial number on the label attached to the base of the product for the initial administrator password.

If you restore the administrator password, it is reset to the initial value at the time of purchase.

Problems when Preparing Network Scanning

Hints to Solving Problems

Checking the error message

When trouble has occurred, first check whether there are any messages on the scanner's control panel or driver screen. If you have the notification email set when the events occur, you can promptly learn the status.

Checking the communication status

Check the communication status of server computer or client computer by using the command such as ping and ipconfig.

Connection test

For checking the connection between the scanner to the mail server, perform the connection test from the scanner. Also, check the connection from the client computer to the server to check the communication status.

Initializing the settings

If the settings and communication status show no problem, the problems may be solved by disabling or initializing the network settings of the scanner, and then setting up again.

Related Information

- ➔ [“Registering an Email Server” on page 146](#)
- ➔ [“Checking Error Messages on the Control Panel” on page 196](#)
- ➔ [“Receiving Email Notifications When Events Occur” on page 247](#)

Cannot Access Web Config

■ The IP address is not assigned to the scanner.

Solutions

A valid IP address may not be assigned to the scanner. Configure the IP address using the scanner's control panel. You can confirm the current setting information from the scanner's control panel.

- ➔ [“Assigning the IP Address” on page 238](#)

■ Web browser does not support the Encryption Strength for SSL/TLS.

Solutions

SSL/TLS has the Encryption Strength. You can open Web Config by using a web browser that supports bulk encryptions as indicated below. Check you are using the a supported browser.

- 80bit: AES256/AES128/3DES
- 112bit: AES256/AES128/3DES
- 128bit: AES256/AES128
- 192bit: AES256
- 256bit: AES256

■ CA-signed Certificate is expired.

Solutions

If there is a problem with the expiration date of the certificate, "The certificate has expired" is displayed when connecting to Web Config with SSL/TLS communication (https). If the message appears before its expiration date, make sure that the scanner's date is configured correctly.

■ The common name of the certificate and the scanner do not match.

Solutions

If the common name of the certificate and the scanner do not match, the message "The name of the security certificate does not match..." is displayed when accessing Web Config using SSL/TLS communication (https). This happens because the following IP addresses do not match.

- The scanner's IP address entered to common name for creating a Self-signed Certificate or CSR
- IP address entered to web browser when running Web Config

For Self-signed Certificate, update the certificate.

For CA-signed Certificate, take the certificate again for the scanner.

■ The proxy server setting of local address is not set to web browser.

Solutions

When the scanner is set to use a proxy server, configure the web browser not to connect to the local address via the proxy server.

- Windows:

Select **Control Panel > Network and Internet > Internet Options > Connections > LAN settings > Proxy server**, and then configure not to use the proxy server for LAN (local addresses).

- Mac OS:

Select **System Preferences > Network > Advanced > Proxies**, and then register the local address for **Bypass proxy settings for these Hosts & Domains**.

Example:

192.168.1.*: Local address 192.168.1.XXX, subnet mask 255.255.255.0

192.168.*.*: Local address 192.168.XXX.XXX, subnet mask 255.255.0.0

■ DHCP is disabled in the computer's settings.

Solutions

If the DHCP for obtaining an IP address automatically is disabled on the computer, you may not be able to access Web Config. Enable DHCP.

Example for Windows 10:

Open the Control Panel and then click **Network and Internet > Network and Sharing Center > Change adapter settings**. Open the Properties screen of the connection you are using, and then open the properties screen for **Internet Protocol Version 4 (TCP/IPv4)** or **Internet Protocol Version 6 (TCP/IPv6)**. Check that **Obtain an IP address automatically** is selected on the displayed screen.

Problems Starting Scanning

Cannot Start Scanning from Computer

Make sure the computer and the scanner are connected correctly.

The cause and solution to the problem differ depending on whether or not they are connected.

Checking the Connection Status (Windows)

Use the Epson Scan 2 Utility to check the connection status.

Note:

Epson Scan 2 Utility is an application supplied with the scanner software.

1. Start the Epson Scan 2 Utility.
 - Windows 11
Click the start button, and then select **All apps > EPSON > Epson Scan 2 Utility**.
 - Windows 10
Click the start button, and then select **EPSON > Epson Scan 2 Utility**.
 - Windows 8.1/Windows 8
Enter the application name in the search charm, and then select the displayed icon.
 - Windows 7
Click the start button, and then select **All Programs or Programs > EPSON > Epson Scan 2 > Epson Scan 2 Utility**.
2. On the **Epson Scan 2 Utility** screen, open the **Scanner** list, and then click **Settings** to open the **Scanner Settings** screen.
If the **Scanner Settings** screen is already displayed instead of the **Epson Scan 2 Utility** screen, go to the next.
3. If the scanner is not displayed on the **Scanner Settings** screen, your scanner is not detected.
Click **Add**, and then add your scanner on the **Add Network Scanner** screen.

If you cannot search for the scanner or cannot scan even if the correct scanner is selected, see the related information.

Related Information



- ➔ [“Cannot connect to a Network” on page 201](#)
- ➔ [“The Scanner Cannot Connect by USB” on page 203](#)
- ➔ [“Cannot Scan Even Though a Connection has been Correctly Established” on page 204](#)

Checking the Connection Status (Mac OS)

Use Epson Scan 2 Utility to check the connection status.

Note:

Epson Scan 2 Utility is an application supplied with the scanner software.

1. Start the Epson Scan 2 Utility.
Select **Go > Applications > Epson Software > Epson Scan 2 Utility**.
2. On the **Epson Scan 2 Utility** screen, open the **Scanner** list, and then click **Settings** to open the **Scanner Settings** screen.
If the **Scanner Settings** screen is already displayed instead of the **Epson Scan 2 Utility** screen, go to the next
3. If the scanner is not displayed on the **Scanner Settings** screen, your scanner is not detected.
Click the  icon, and then allow the software to make changes.
4. Click the  icon, and then add your scanner on the **Add Network Scanner** screen.

If you cannot search for the scanner or cannot scan even if the correct scanner is selected, see the related information.

Related Information

- ➔ [“Cannot connect to a Network” on page 201](#)
- ➔ [“The Scanner Cannot Connect by USB” on page 203](#)
- ➔ [“Cannot Scan Even Though a Connection has been Correctly Established” on page 204](#)

Cannot connect to a Network

The problem could be one of the following issues.

■ **Something is wrong with the network devices for Wi-Fi connection.**

Solutions

Turn off the devices you want to connect to the network. Wait for about 10 seconds, and then turn on the devices in the following order; wireless router, computer or smart device, and then scanner. Move the scanner and computer or smart device closer to the wireless router to help with radio wave communication, and then try to make network settings again.

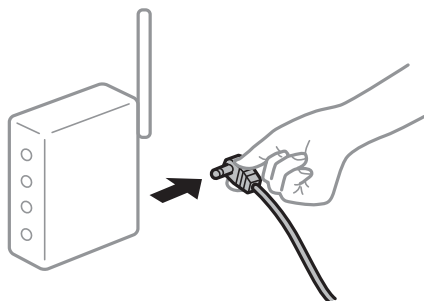

■ **Devices cannot receive signals from the wireless router because they are too far apart.**

Solutions

After moving the computer or the smart device and the scanner closer to the wireless router, turn off the wireless router, and then turn it back on.

When changing the wireless router, the settings do not match the new router.

Solutions

Make the connection settings again so that they match the new wireless router.

➔ [“When Replacing the Wireless Router” on page 230](#)

The SSIDs connected from the computer or smart device and computer are different.

Solutions

When you are using multiple wireless routers at the same time or the wireless router has multiple SSIDs and devices are connected to different SSIDs, you cannot connect to the wireless router.

Connect the computer or smart device to the same SSID as the scanner.

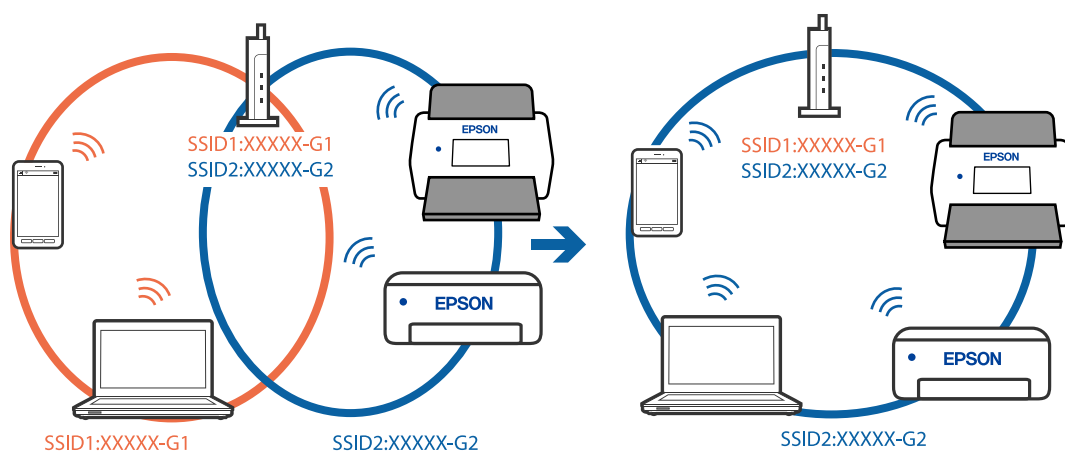

A privacy separator on the wireless router is available.

Solutions

Most wireless routers have a privacy separator feature that blocks communication between connected devices. If you cannot communicate between the scanner and the computer or smart device even if they are connected to the same network, disable the privacy separator on the wireless router. See the manual provided with the wireless router for details.

The IP address is incorrectly assigned.

Solutions

If the IP address assigned to the scanner is 169.254.XXX.XXX, and the subnet mask is 255.255.0.0, the IP address may not be assigned correctly.

Select **Settings - Network Settings - Advanced - TCP/IP** on the scanner’s control panel, and then check the IP address and the subnet mask assigned to the scanner.

Restart the wireless router or reset the network settings for the scanner.

➔ [“Re-setting the Network Connection” on page 230](#)

There is a problem with the network settings on the computer.

Solutions

Try accessing any website from your computer to make sure that your computer's network settings are correct. If you cannot access any website, there is a problem on the computer.

Check the network connection of the computer. See the documentation provided with the computer for details.

■ **The scanner is off.**

Solutions

Make sure the scanner is turned on.

Also, wait until the status light stops flashing indicating that the scanner is ready to scan.

The Scanner Cannot Connect by USB

The following causes can be considered.

■ **The USB cable is not plugged into the electrical outlet correctly.**

Solutions

Connect the USB cable securely to the scanner and the computer.

■ **There is a problem with the USB hub.**

Solutions

If you are using a USB hub, try to connect the scanner directly to the computer.

■ **There is a problem with the USB cable or the USB inlet.**

Solutions

If the USB cable cannot be recognized, change the port, or change the USB cable.

■ **The USB Cable is in the Wrong Orientation**

Solutions

Check the orientation of the USB cable. Connect the Type-A connector to the computer, and the Type-C connector to the scanner.

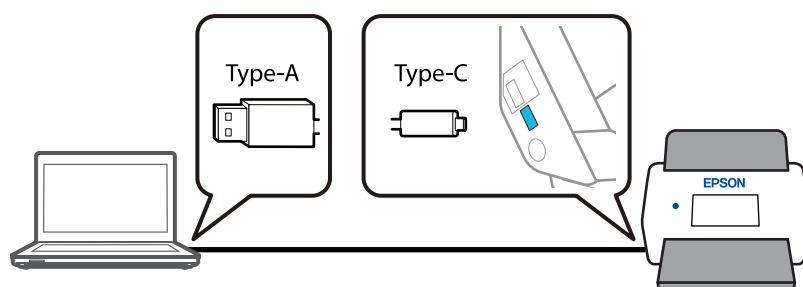

■ **The scanner is off.**

Solutions

Make sure the scanner is turned on.

Also, wait until the status light stops flashing indicating that the scanner is ready to scan.

Cannot Scan Even Though a Connection has been Correctly Established

Required applications are not installed on your computer.

Solutions

Make sure the application Epson ScanSmart is installed.

If Epson ScanSmart is not installed, install it again.

➔ [“Installing Your Applications” on page 224](#)

If you are using any TWAIN-compliant programs, the correct scanner is not selected as the source setting. (Windows)

Solutions

Make sure that you select the correct scanner from your programs list.

Network Scanning Settings are Disabled

Solutions

In Web Config, select the **Scan** tab > **Network Scan**, and then select **Enable scanning** in **EPSON Scan**.

AirPrint is disabled.

Solutions

Enable the AirPrint setting in Web Config.

Cannot Start Scanning from Smart Device

Make sure the smart device and the scanner are connected correctly.

The cause and solution to the problem differ depending on whether or not they are connected.

Checking the Connection Status (Smart Device)

You can use Epson Smart Panel to check the connection status for the smart device and the scanner.

1. Start Epson Smart Panel on your smart device.
2. Check whether or not the scanner name is displayed in Epson Smart Panel.

If the scanner name is displayed, a connection has been successfully established between the smart device and the scanner.

If a message is displayed saying that the scanner is not selected, a connection has not been established between the smart device and the scanner. Follow the instructions on the Epson Smart Panel to connect to the scanner.

If you cannot connect to the scanner over a network, check the Related Information.

Related Information

➔ [“Cannot connect to a Network” on page 205](#)

Cannot connect to a Network

The problem could be one of the following issues.

■ Something is wrong with the network devices for Wi-Fi connection.

Solutions

Turn off the devices you want to connect to the network. Wait for about 10 seconds, and then turn on the devices in the following order; wireless router, computer or smart device, and then scanner. Move the scanner and computer or smart device closer to the wireless router to help with radio wave communication, and then try to make network settings again.

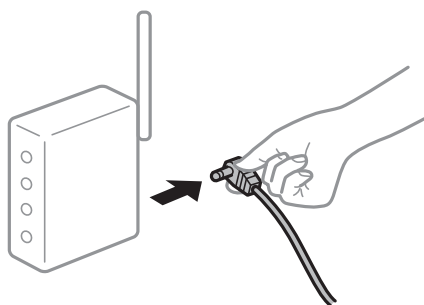

■ Devices cannot receive signals from the wireless router because they are too far apart.

Solutions

After moving the computer or the smart device and the scanner closer to the wireless router, turn off the wireless router, and then turn it back on.

■ When changing the wireless router, the settings do not match the new router.

Solutions

Make the connection settings again so that they match the new wireless router.

➔ [“When Replacing the Wireless Router” on page 230](#)

■ The SSIDs connected from the computer or smart device and computer are different.

Solutions

When you are using multiple wireless routers at the same time or the wireless router has multiple SSIDs and devices are connected to different SSIDs, you cannot connect to the wireless router.

Connect the computer or smart device to the same SSID as the scanner.

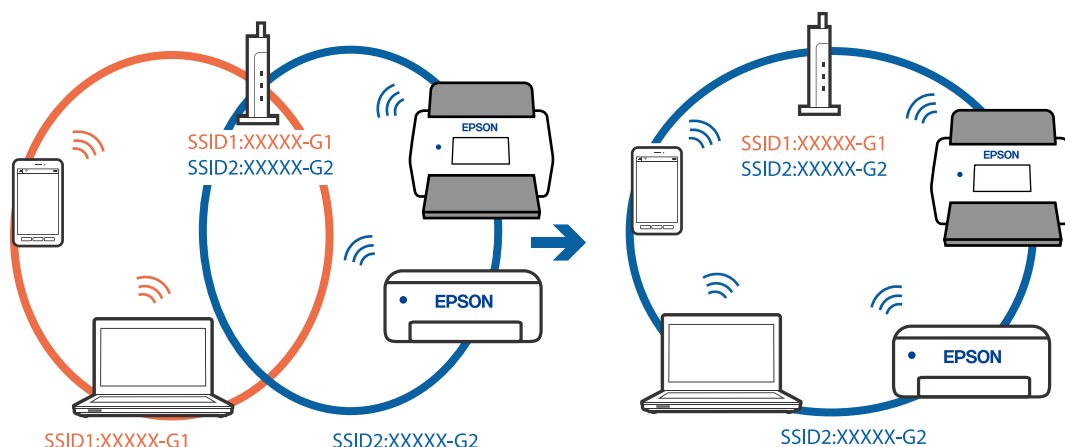

■ **A privacy separator on the wireless router is available.**

Solutions

Most wireless routers have a privacy separator feature that blocks communication between connected devices. If you cannot communicate between the scanner and the computer or smart device even if they are connected to the same network, disable the privacy separator on the wireless router. See the manual provided with the wireless router for details.

■ **The IP address is incorrectly assigned.**

Solutions

If the IP address assigned to the scanner is 169.254.XXX.XXX, and the subnet mask is 255.255.0.0, the IP address may not be assigned correctly.

Select **Settings - Network Settings - Advanced - TCP/IP** on the scanner's control panel, and then check the IP address and the subnet mask assigned to the scanner.

Restart the wireless router or reset the network settings for the scanner.

➔ [“Re-setting the Network Connection” on page 230](#)

■ **There is a problem with the network settings on the smart device.**

Solutions

Try accessing any website from your smart device to make sure that your smart device's network settings are correct. If you cannot access any website, there is a problem on the smart device.

Check the network connection of the computer. See the documentation provided with the smart device for details.

■ **The scanner is off.**

Solutions

Make sure the scanner is turned on.

Also, wait until the status light stops flashing indicating that the scanner is ready to scan.

Cannot Save Scanned Images to the Shared Folder

Messages are Displayed on the Control Panel when Scanning to a Network Folder

When error messages are displayed on the control panel, check the message itself or the following list to solve the problems.

Messages	Solutions
DNS error. Check DNS settings.	<p>Cannot connect to the computer. Check the following.</p> <ul style="list-style-type: none"> <input type="checkbox"/> Make sure that the address in the contacts list on the scanner and the address of the shared folder are the same. <input type="checkbox"/> If the IP address of the computer is static and is set manually, change the computer name in the network path to the IP address. Example: \\EPSON02\SCAN to \\192.168.xxx.xxx\SCAN <input type="checkbox"/> Make sure that the computer is turned on and does not sleep. If the computer sleeps, you cannot save scanned images to the shared folder. <input type="checkbox"/> Temporarily disable the computer's Firewall and security software. If this clears the error, check the settings in the security software. <input type="checkbox"/> If Public network is selected as the network place, you cannot save the scanned images to the shared folder. Set the forward settings for each port. <input type="checkbox"/> If you are using a laptop computer and the IP address is set as DHCP, the IP address may change when reconnecting to the network. Obtain the IP address again. <input type="checkbox"/> Make sure the DNS setting is correct. Contact your network administrator about the DNS settings. <input type="checkbox"/> The computer name and the IP address may differ when the management table of the DNS server is not updated. Contact your DNS server administrator.
Authentication error. Check the location, user name and password.	<p>Make sure the user name and the password are correct on the computer and the contacts on the scanner. Also, make sure that the password has not expired.</p>
Communication error. Check the Wi-Fi/network connection.	<p>Cannot communicate with a network folder that is registered on the contacts list. Check the following.</p> <ul style="list-style-type: none"> <input type="checkbox"/> Make sure that the address in the contacts list on the scanner and the address of the shared folder are the same. <input type="checkbox"/> Access rights for the user in the contacts list should be added on the Sharing tab and the Security tab of the shared folder's properties. Also, the permissions for the user should be set to "allowed".
The file name is already in use. Rename the file and scan again.	<p>Change the file name settings. Otherwise, move or delete the files, or change the file name on the shared folder.</p>
Scanned file(s) are too large. Only XX page(s) have been sent. Check if the destination has enough space.	<p>There is not enough disk space on the computer. Increase the free space on the computer.</p>

Checking the Point where the Error Occurred

When saving scanned images to the shared folder, saving process proceeds as following. You can then check the point where the error occurred.

Items	Operation	Error Messages
Connecting	Connect to the computer from the scanner.	DNS error. Check DNS settings.
Logging on to the computer	Log on to the computer with the user name and the password.	Authentication error. Check the location, user name and password.
Checking the folder to save	Check the network path of the shared folder.	Communication error. Check the Wi-Fi/ network connection.
Checking the file name	Check if there is a file with the same name as the file you want to save in the folder.	The file name is already in use. Rename the file and scan again.
Writing the file	Write a new file.	Scanned file(s) are too large. Only XX page(s) have been sent. Check if the destination has enough space.

Saving the Scanned Images Takes a Long Time

It takes a long time for the name resolution to correspond to the "Domain Name" and the "IP Address".

Solutions

Check the following points.

- Make sure the DNS setting is correct.
- Make sure each DNS setting is correct when checking the Web Config.
- Make sure the DNS domain name is correct.

Cannot Send Scanned Images to the Cloud

- When using the Scan to Cloud feature, see the troubleshooting page on the Epson Connect website for details.
<https://www.epsonconnect.com/> > **Learn More** on the Scan to Cloud feature > Contents pull down list > Troubleshooting for Epson Connect Services > Scan to Cloud feature
- Make sure you enter the correct information when you login.
- Make sure the service is running. The service may be down due to system maintenance. Check the accounting service website for more detailed information.

Cannot Send Scanned Images to an Email

- Make sure that the entered email address is working.
- Make sure that the email server settings are correct.
- Contact the email server administrator to make sure the server is running.

Related Information

➔ [“Checking an Email Server Connection” on page 148](#)

Paper Feeding Problems

Multiple Originals Are Fed (Double Feed)

Check the following when a double feed occurs.

- ❑ If the jammed original is inside the scanner, open the scanner cover or vertical path cover and remove the original.
- ❑ Check the scanned image, and then scan the originals again if necessary.

Make sure the scanner is in the correct scanner position for the original.

- ❑ This product uses two different positions for scanning, depending on the original being scanned. Check the link to see which position is appropriate for your original.

[“Combinations of Originals and Scanner Position” on page 53](#)

- ❑ When scanning multiple standard-size originals, scan in the vertical path position.

If the scanner is in the straight path position, pull the lever to tilt the scanner forward to place it in the vertical path position.

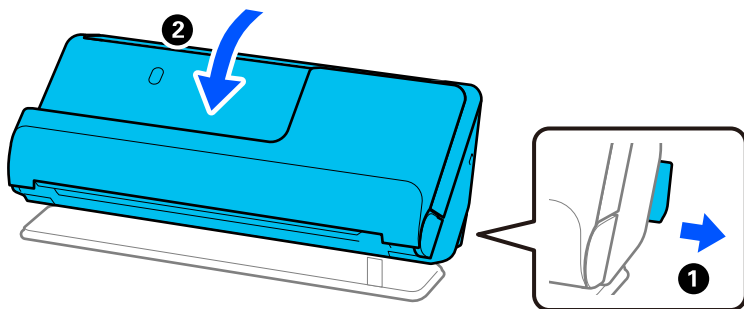

- ❑ When scanning in the straight path position, load only one original at a time.

If the scanner is in the vertical path position, pull the lever to tilt the scanner backward to the straight path position.

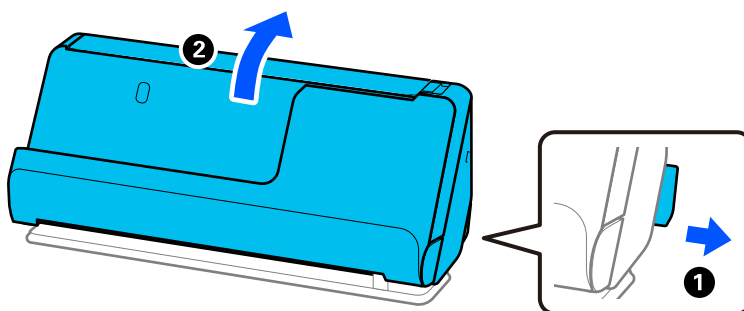

If multiple originals are fed frequently, try the following.

- ❑ If you load unsupported originals, the scanner may feed multiple originals at a time.
- ❑ Reduce the number of originals being placed at a time.
- ❑ Use **Automatic Feeding Mode**, and scan originals one by one.

When you are using Epson ScanSmart, you can open the Epson Scan 2 screen by clicking the **Settings** button > **Scanner Settings** tab > **Scan Settings**.

- ❑ Clean the rollers inside the scanner.

[“Cleaning Inside the Scanner” on page 174](#)

- ❑ Check the number of sheets scanned by the pickup roller. If the number of scans exceeds the pickup roller's service life (50,000 sheets), replace the roller assembly kit with a new one.

Even if the number of scans does not exceed the pickup roller's service life, we recommend replacing the roller assembly kit with a new one if the surface of the roller is worn out.

[“Replacing the Roller Assembly Kit” on page 182](#)

Note:

You can check the number of scans by the pickup roller on the control panel or in the Epson Scan 2 Utility.

To check from the control panel, tap **Scanner Maintenance** > **Roller Replacement** on the Home screen, and then check the number of scans displayed in **Roller Replacement**.

To check from the Epson Scan 2 Utility, start the Epson Scan 2 Utility, click the **Counter** tab, and then check the **Number of Scans** in **Roller Assembly Kit**.

Related Information

- ➔ [“Scanning in Automatic Feeding Mode” on page 130](#)
- ➔ [“Cleaning Inside the Scanner” on page 174](#)
- ➔ [“Removing Jammed Originals from the Scanner” on page 210](#)

Removing Jammed Originals from the Scanner

If an original is jammed in the scanner, clear the jam according to the procedure for the scanner position.

Note:

- ❑ *If you change the scanner position while scanning, the original will get jammed. Do not change the scanner position while scanning.*
- ❑ *You cannot scan long paper (393.7 mm or more) from the control panel.*
- ❑ *Epson Smart Panel does not support scanning for long paper (393.7 mm (15.5 in.) or more).*

Related Information

- ➔ [“Multiple Originals Are Fed \(Double Feed\)” on page 209](#)
- ➔ [“Paper Jams, Paper Feed Errors, and Document Protection Issues Occur Frequently” on page 216](#)
- ➔ [“Paper Protection Does not Work Correctly” on page 217](#)

For the Vertical Path Position

1. Remove all originals remaining in the input tray.

2. Open the vertical path cover.

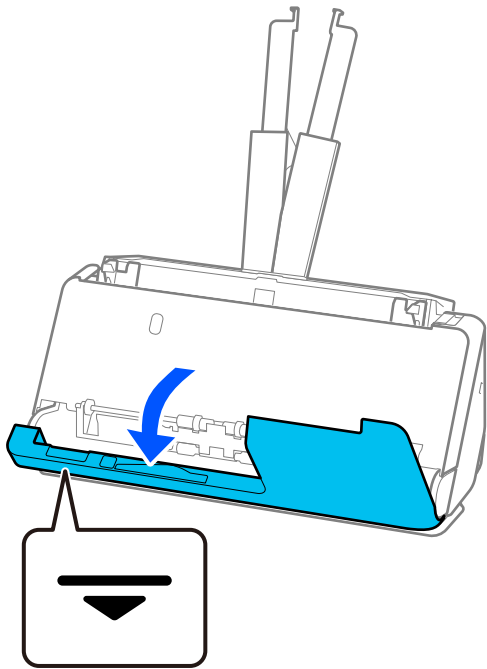

3. Pull the lever to open the scanner cover.

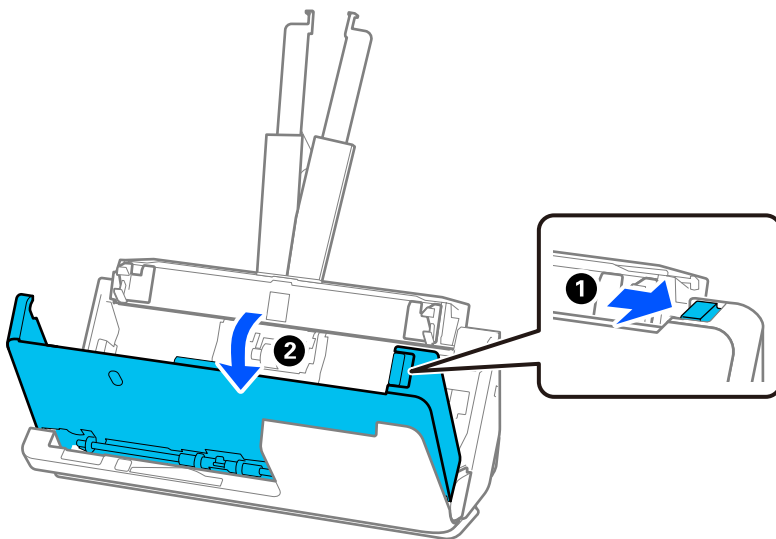

- Carefully remove any jammed originals.

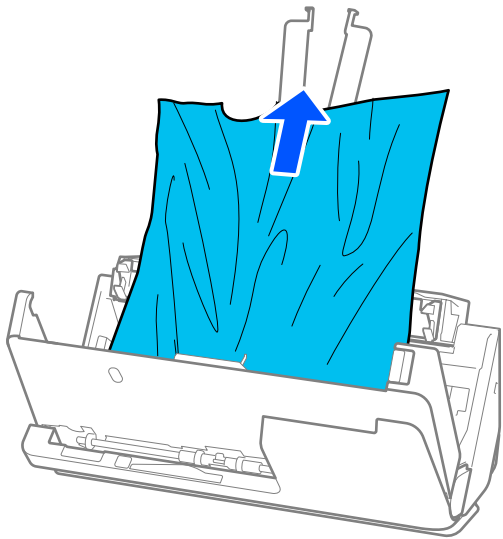

- If you cannot pull originals straight up, carefully pull out any jammed originals from the output tray in the direction of the arrow.

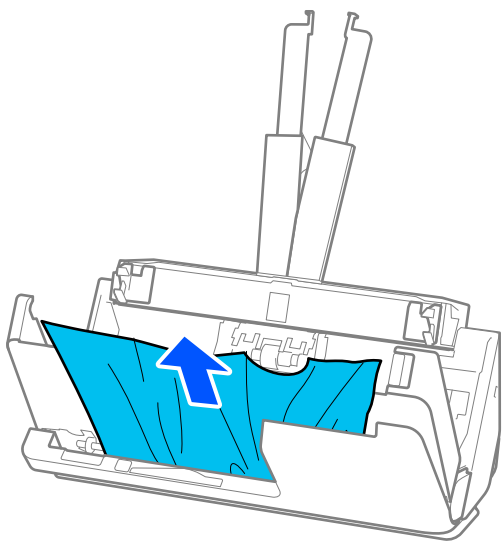

Important:

Make sure there is no paper inside the scanner.

6. Close the scanner cover with both hands. Next, close the vertical path cover.

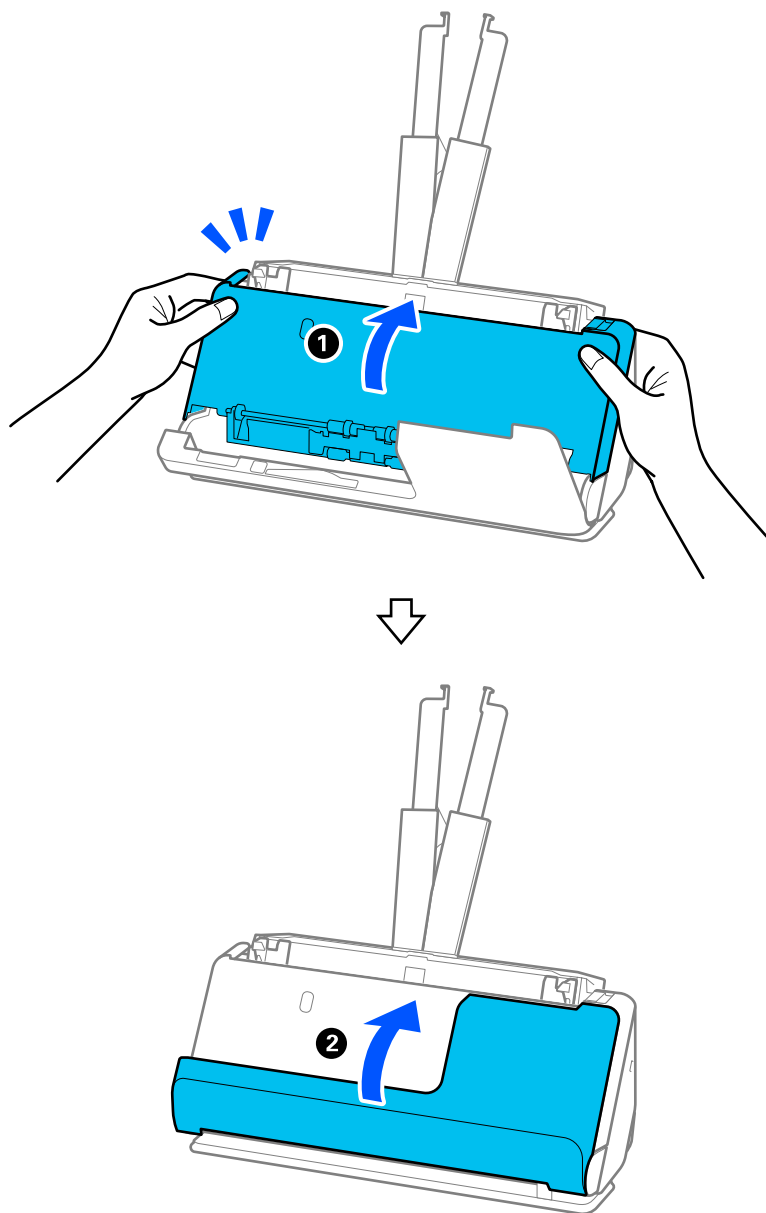

! *Important:*

Before restarting scanning, make sure that the scanner is stationary. If the scanner is not stationary, it could cause the original to jam.

For the Straight Path Position

1. Remove all originals remaining in the input tray.

2. Pull the lever to open the scanner cover.

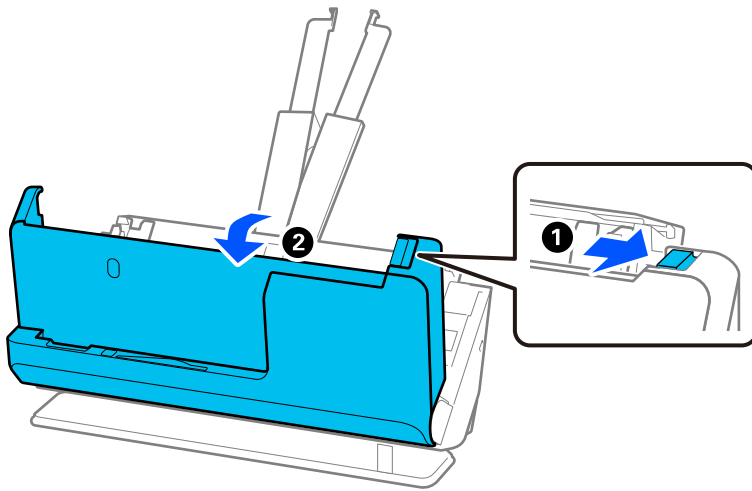

3. Carefully remove any jammed originals.

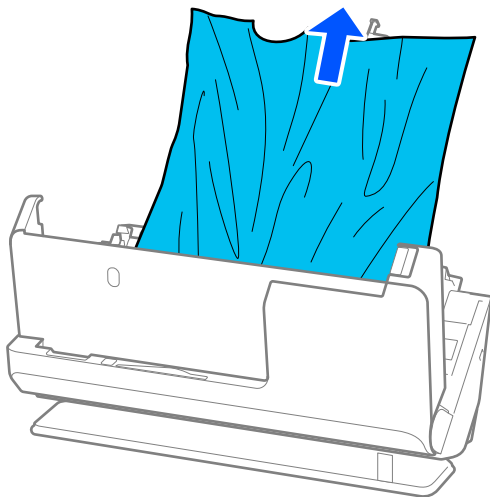

4. If you cannot pull originals straight up, carefully pull out any jammed originals from the output slot in the direction of the arrow.

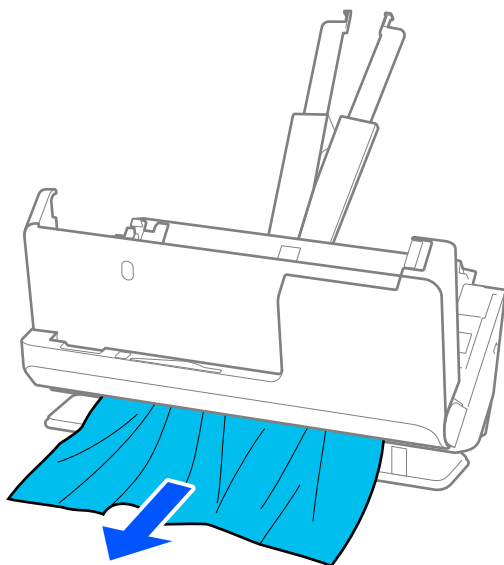

Important:

Make sure there is no paper inside the scanner.

5. Close the scanner cover with both hands.

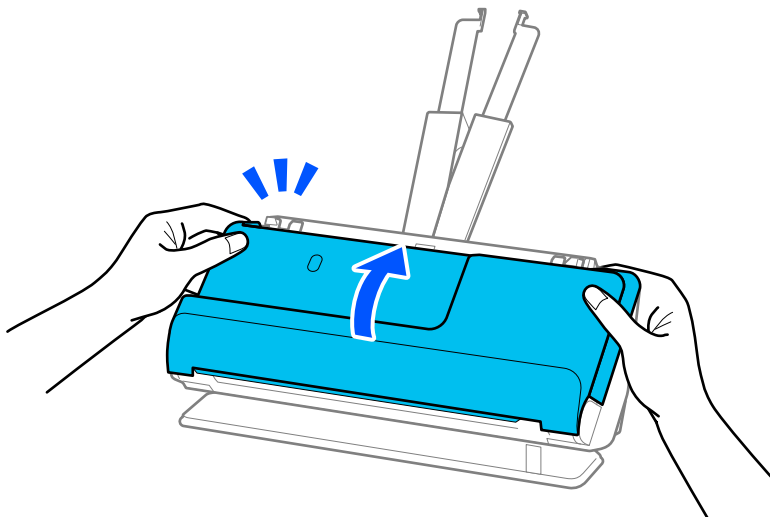

Important:

Before restarting scanning, make sure that the scanner is stationary. If the scanner is not stationary, it could cause the original to jam.

Paper Jams, Paper Feed Errors, and Document Protection Issues Occur Frequently

If the following problems occur, check the original and the status of the scanner.

- Originals jam frequently
- Paper feed errors occur frequently
- Document protection issues occur frequently

Points to check when loading originals

- For originals with folds or that are curled, flatten the original before loading.
- When loading originals with a mixture of different sizes, load the originals with the side to be scanned facing up and in descending order of paper size with the widest at the back and the narrowest at the center of the input tray. Next, slide the edge guides to align them with the widest originals.

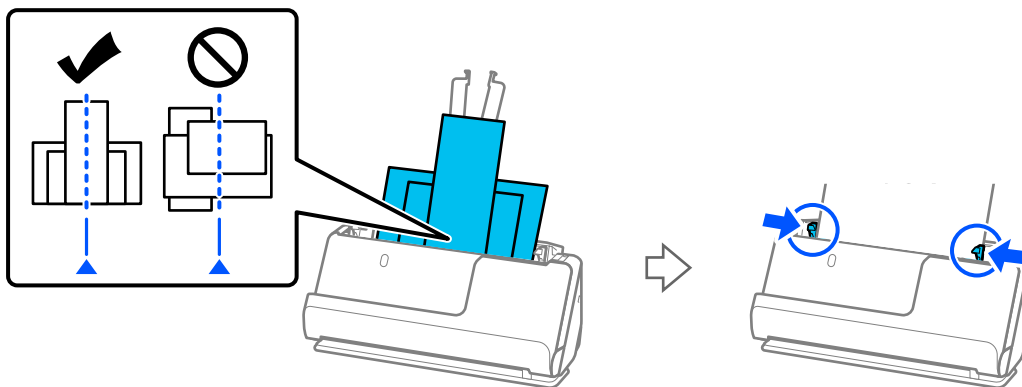

[“Loading Batches of Originals with Different Paper Types and Sizes” on page 93](#)

If the problem is not solved, try scanning the originals at each size separately, or scan the originals one by one. Align the edge guides to the width of the originals each time you load them.

Note:

You can use the following methods to scan the originals multiple times separately and then save them to one file.

- You can use scanner software.
See the *Epson ScanSmart* help for details on adding or editing the scanned pages after scanning in *Epson ScanSmart*.
- When you are using *Epson Smart Panel*, load the next original, and then tap **+Scan** after scanning the first page to display the *Edit* screen. You can rotate, move, and delete pages on the *Edit* screen.
- When you are scanning from the control panel (*Scan to Features*), set *Automatic Feeding Mode* to **On (Semi-Auto)**, and then scan the originals in the order you want to save them.
- After scanning, remove the original from the output tray or the output slot.

Points to check on the scanner

- Clean the rollers inside the scanner.
[“Cleaning Inside the Scanner” on page 174](#)

- ❑ Check the number of sheets scanned by the pickup roller. If the number of scans exceeds the pickup roller's service life (50,000 sheets), replace the roller assembly kit with a new one.

Even if the number of scans does not exceed the pickup roller's service life, we recommend replacing the roller assembly kit with a new one if the surface of the roller is worn out.

[“Replacing the Roller Assembly Kit” on page 182](#)

Note:

You can check the number of scans by the pickup roller on the control panel or in the Epson Scan 2 Utility.

To check from the control panel, tap **Scanner Maintenance** > **Roller Replacement** on the Home screen, and then check the number of scans displayed in **Roller Replacement**.

To check from the Epson Scan 2 Utility, start the Epson Scan 2 Utility, click the **Counter** tab, and then check the **Number of Scans in Roller Assembly Kit**.

Related Information

- ➔ [“Types of Originals that Require Attention” on page 52](#)
- ➔ [“Loading Batches of Originals with Different Paper Types and Sizes” on page 93](#)
- ➔ [“Preparing to Scan from the Control Panel \(the Scan to Features\)” on page 99](#)
- ➔ [“Cleaning Inside the Scanner” on page 174](#)
- ➔ [“Multiple Originals Are Fed \(Double Feed\)” on page 209](#)
- ➔ [“Paper Protection Does not Work Correctly” on page 217](#)

Paper Protection Does not Work Correctly

Depending on the original and the level you set, this feature may not work correctly.

- ❑ If false positives occur frequently, try lowering the level.
- ❑ If your original is damaged, check that this feature is enabled. If it is already enabled, increase the level of protection for the feature.

Related Information

- ➔ [“Scanner Settings” on page 161](#)
- ➔ [“Removing Jammed Originals from the Scanner” on page 210](#)

The Originals Get Dirty

Clean the inside of the scanner.

Related Information

- ➔ [“Cleaning Inside the Scanner” on page 174](#)

Scanning Speed Slows Down when Scanning Continuously

When scanning continuously using the ADF, scanning slows down to prevent the scanner mechanism from overheating and being damaged. However, you can continue scanning.

To regain normal scanning speed, leave the scanner idle for at least 30 minutes. Scanning speed does not recover even if the power is off.

Scanning Takes a Long Time

- The scanning speed may slow down depending on the scanning conditions, such as high resolution, image adjustment features, file format, communication mode, and so on.
- Computers with USB 3.0 (SuperSpeed) or USB 2.0 (Hi-Speed) ports can scan faster than those with USB 1.1 ports. If you are using a USB 3.0 or USB 2.0 port with the scanner, make sure it meets the system requirements.
- When using security software, exclude the TWAIN.log file from monitoring, or set the TWAIN.log as a read-only file. For more information on your security software's functions, see the help and so on supplied with the software. The TWAIN.log file is saved in the following locations.
C:\Users*(user name)*\AppData\Local\Temp

Related Information

- ➔ [“Registering a Destination \(FTP\)” on page 152](#)
- ➔ [“Registering a Destination \(SharePoint\(WebDAV\)\)” on page 153](#)

Scanned Image Problems

Lines (Streaks) Appear when Scanning from ADF

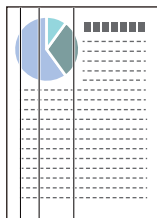

- Clean the ADF.
Straight lines (streaks) may appear in the image when debris or dirt gets into the ADF.
- Remove any debris or dirt that adheres to the original.
- Using **Glass Dirt Detection** feature, a notification is displayed when dirt is detected on the scanner glass inside the scanner.
Select **Settings** on the home screen > **Scanner Settings** > **Glass Dirt Detection**, and then select **On-Low** or **On-High**.
When an alert is displayed, clean the glass surfaces inside your scanner using a genuine Epson cleaning kit or a soft cloth.
[“Cleaning Inside the Scanner” on page 174](#)

Note:

- Some stains may not be detected correctly.*
- If the detection does not work correctly, change the setting.*
*If no stains are detected, select **On-High**. If stains are detected incorrectly, select **On-Low** or **Off**.*

Related Information

- ➔ [“Cleaning Inside the Scanner” on page 174](#)
- ➔ [“Setting the Glass Surface Stain Detection Feature” on page 169](#)

Alert About Stains Inside the Scanner Still Appears

If the alert screen appears after cleaning the inside of the scanner, glass part will be required to replace. Contact your local dealer to repair.

Related Information

- ➔ [“Cleaning Inside the Scanner” on page 174](#)

Colors Are Uneven in the Scanned Image

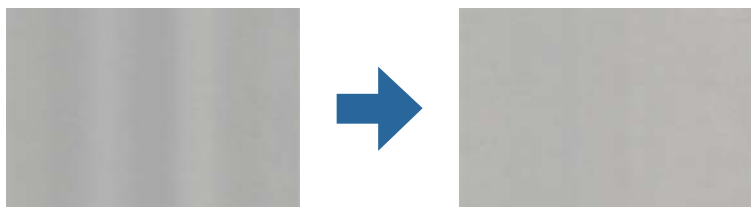

If the scanner is subject to strong light such as direct sunlight, the sensor inside the scanner misdetects the light and colors in the scanned image become uneven.

- Change the orientation of the scanner so that no strong light is falling on the front of the scanner.
- Move the scanner to a location where it will not be subjected to strong light.

Expanding or Contracting the Scanned Image

When expanding or contracting the scanned image, you can adjust the expansion ratio by using the **Adjustments** feature in Epson Scan 2 Utility. This feature is only available for Windows.

Note:

Epson Scan 2 Utility is one of the applications supplied with the scanner software.

1. Start Epson Scan 2 Utility.
 - Windows 11
Click the start button, and then select **All apps > EPSON > Epson Scan 2 Utility**.
 - Windows 10
Click the start button, and then select **EPSON > Epson Scan 2 Utility**.
 - Windows 8.1/Windows 8
Enter the application name in the search charm, and then select the displayed icon.
 - Windows 7
Click the start button, and then select **All Programs or Programs > EPSON > Epson Scan 2 > Epson Scan 2 Utility**.

2. Select the **Adjustments** tab.
3. Use **Expansion/Contraction** to adjust the expansion ratio for scanned images.
4. Click **Set** to apply the settings to the scanner.

An Image on the Back of Your Original Appears in Your Scanned Image

Images on the back of the original may appear in the scanned image.

- If **Auto**, **Color**, or **Grayscale** is selected as the **Image Type**:

- Check that **Remove Background** is selected.

Control panel: Enable **Remove background** in Scan Settings.

Epson ScanSmart: On the **Epson ScanSmart**, **Review Scans**, or **Select Action** screen, click  **Settings** > **Scanner Settings** tab > **Scan Settings** button, select the **Advanced Settings** tab on the Epson Scan 2 screen displayed, and then enable **Remove Background**.

- Check that **Text Enhancement** is selected.

Control panel: Enable **Text Enhancement** in Scan Settings.

Epson ScanSmart: On the **Epson ScanSmart**, **Review Scans**, or **Select Action** screen, click  **Settings** > **Scanner Settings** tab > **Scan Settings** button, select the **Advanced Settings** tab on the Epson Scan 2 screen displayed, and then enable **Text Enhancement**.

- When **Black & White** is selected as the **Image Type**

- Check that **Text Enhancement** is selected.

Control panel: Enable **Text Enhancement** in Scan Settings.

Epson ScanSmart: On the **Epson ScanSmart**, **Review Scans**, or **Select Action** screen, click  **Settings** > **Scanner Settings** tab > **Scan Settings** button, select the **Advanced Settings** tab on the Epson Scan 2 screen displayed, and then enable **Text Enhancement**.

Depending on the condition of your scanned image, click **Settings**, and then move the slider towards **Remove background**.

Scanned Text or Images are Missing or Blurred

You can adjust the appearance of the scanned image or text by increasing the resolution or adjusting the image quality.

- Change the resolution, and then scan again.

Set the appropriate resolution for the purpose of your scanned image.

Control panel: Select the appropriate resolution in **Resolution** from Scan Settings.

Epson ScanSmart: On the **Epson ScanSmart**, **Review Scans**, or **Select Action** screen, click  **Settings** > **Scanner Settings** tab > **Scan Settings** button, select the **Main Settings** tab on the Epson Scan 2 screen displayed, and then set the **Resolution**.

- Check that **Text Enhancement** is selected.

Control panel: Enable **Text Enhancement** in Scan Settings.

Epson ScanSmart: On the **Epson ScanSmart, Review Scans, or Select Action** screen, click  **Settings** > **Scanner Settings** tab > **Scan Settings** button, select the **Advanced Settings** tab on the Epson Scan 2 screen displayed, and then enable **Text Enhancement**.

When you select **Black & White** as the **Image Type**, depending on the condition of the scanned image, click **Settings** and adjust the slider for **Emphasize light letters / Remove background**, turn off **Remove spot noise**, or set the level to **Low**.

- If you are scanning in JPEG format, try changing the compression level.

Epson ScanSmart: On the **Epson ScanSmart, Review Scans, or Select Action** screen, click  **Settings**, and then click the **Save Settings** tab > **Options** button.

Moiré Patterns (Web-Like Shadows) Appear

If the original is a printed document, moiré patterns (web-like shadows) may appear in the scanned image.

- Check that **Descreening** is selected.

Click  **Settings** in **Epson ScanSmart, Review Scans** or on the **Select Action** window, and then click the **Scanner Settings** tab > **Scan Settings** button > **Advanced Settings** tab on the Epson Scan 2 window > **Descreening**.



- Change the resolution, and then scan again.

Click  **Settings** in **Epson ScanSmart, Review Scans** or on the **Select Action** window, and then click the **Scanner Settings** tab > **Scan Settings** button > **Main Settings** tab on the Epson Scan 2 window > **Resolution**.

The Edge of the Original is Not Scanned when Automatically Detecting the Size of the Original

Depending on the original, the edge of the original may not be scanned when automatically detecting the size of the original.

- Click  **Settings** in **Epson ScanSmart, Review Scans** or on the **Select Action** window, and then click the **Scanner Settings** tab > **Scan Settings** button.

In Epson Scan 2, select the **Main Settings** tab, and then select **Document Size** > **Settings**. On the **Document Size Settings** window, adjust **Crop Margins for Size "Auto"**.

- Depending on the original, the area of the original may not be detected correctly when using the **Auto Detect** feature. Select the appropriate size of the original from the **Document Size** list.

Click  **Settings** in **Epson ScanSmart, Review Scans** or on the **Select Action** window, and then click the **Scanner Settings** tab > **Scan Settings** button.

In Epson Scan 2, click the **Main Settings** tab, and then click **Document Size**.

Note:

If the size of the original you want to scan is not on the list, select **Customize**, and then create the size manually.

Click  **Settings** in **Epson ScanSmart, Review Scans** or on the **Select Action** window, and then click the **Scanner Settings** tab > **Scan Settings** button.

In Epson Scan 2, click the **Main Settings** tab, and then click **Customize** in **Document Size**.

Character is not Recognized Correctly

Check the following to increase the recognition rate of OCR (Optical Character Recognition).

- Check that the original is placed straight.
- Use an original with clear text. Text recognition may decline for the following types of originals.
 - Originals that have been copied many times
 - Originals received by fax (at low resolutions)
 - Originals with tightly spaced characters or line spacing
 - Originals with ruled lines or underlined text
 - Originals with hand-written text
 - Originals with creases or wrinkles
- Paper type made of thermal paper such as receipts may deteriorate due to age or friction. Scan them as soon as possible.
- When saving to Microsoft® Office or **Searchable PDF** files, check that the correct languages are selected.
Check the **Language** on the Save Settings screen.
- If you have set **Image Type** to **Color** or **Grayscale** in Epson Scan 2, try adjusting the **Text Enhancement** setting.
In Epson ScanSmart, click the **Settings** button > **Scanner Settings** tab > **Scan Settings** to open the Epson Scan 2 screen. On the Epson Scan 2 screen, click the **Advanced Settings** tab > **Text Enhancement** > **Settings**, and then select **Emphasize light letters for OCR** as the **Mode**.

Note:

You need the EPSON Scan OCR component to save as a **Searchable PDF**. This is installed automatically when you set up the scanner using the installer.

Cannot Solve Problems in the Scanned Image

If you have tried all of the solutions and have not solved the problem, initialize the scanner driver (Epson Scan 2) settings using Epson Scan 2 Utility.

Note:

Epson Scan 2 Utility is one of the applications supplied with the scanner software.

1. Start Epson Scan 2 Utility.

- Windows 11

Click the start button, and then select **All apps > EPSON > Epson Scan 2 Utility**.

- Windows 10

Click the start button, and then select **EPSON > Epson Scan 2 Utility**.

- Windows 8.1/Windows 8

Enter the application name in the search charm, and then select the displayed icon.

- Windows 7

Click the start button, and then select **All Programs or Programs > EPSON > Epson Scan 2 > Epson Scan 2 Utility**.

- Mac OS

Select **Go > Applications > Epson Software > Epson Scan 2 Utility**.

2. Select the **Other** tab.

3. Click **Reset**.

Note:

If initialization does not solve the problem, uninstall and re-install the scanner driver (Epson Scan 2).

Uninstalling and Installing Applications

Uninstalling Your Applications

You may need to uninstall and then reinstall your applications to solve certain problems or if you upgrade your operating system. Log on to your computer as an administrator. Enter the administrator password if the computer prompts you.

Uninstalling Your Applications for Windows

1. Quit all running applications.

2. Disconnect the scanner from your computer.

3. Open the Control Panel:

- Windows 11

Click the start button, and then select **All apps > Windows Tools > Control Panel**.

- Windows 10

Click the start button, and then select **Windows System > Control Panel**.

- Windows 8.1/Windows 8

Select **Desktop > Settings > Control Panel**.

- Windows 7

Click the start button, and then select **Control Panel**.

4. Select **Uninstall a program** in **Programs**.
5. Select the application you want to uninstall.
6. Click **Uninstall/Change** or **Uninstall**.

Note:

If the User Account Control window is displayed, click Continue.

7. Follow the on-screen instructions.

Note:

*A message may be displayed prompting you to restart your computer. If it is displayed, make sure **I want to restart my computer now** is selected, and then click **Finish**.*

Uninstalling Your Applications for Mac OS

Note:

Make sure you installed EPSON Software Updater.

1. Download the Uninstaller using EPSON Software Updater.
Once you have downloaded the Uninstaller, you do not need to download it again each time you uninstall the application.
2. Disconnect the scanner from your computer.
3. To uninstall the scanner driver, select **System Preferences** from the Apple menu > **Printers & Scanners** (or **Print & Scan, Print & Fax**), and then remove the scanner from the enabled scanner list.
4. Quit all running applications.
5. Select **Go > Applications > Epson Software > Uninstaller**.
6. Select the application you want to uninstall, and then click Uninstall.



Important:

The Uninstaller removes all drivers for Epson scanners on the computer. If you use multiple Epson scanners and you only want to delete some of the drivers, delete all of them first, and then install the necessary scanner drivers again.

Note:

*If you cannot find the application you want to uninstall in the application list, you cannot uninstall using the Uninstaller. In this situation, select **Go > Applications > Epson Software**, select the application you want to uninstall, and then drag it to the trash icon.*

Installing Your Applications

Follow the steps below to install the necessary applications.

Note:

- Log on to your computer as an administrator. Enter the administrator password if the computer prompts you.
- When reinstalling applications, you need to uninstall them first.

1. Quit all running applications.
2. When installing scanner driver (Epson Scan 2), disconnect the scanner and the computer temporarily.

Note:

Do not connect the scanner and the computer until you are instructed to do so.

3. Install the application by following the instructions on the Website below.

<https://epson.sn>

Adding or Replacing the Computer or Devices

Connecting to a Scanner that has been Connected to the Network.	227
Connecting a Smart Device and Scanner Directly (Wi-Fi Direct).	228
Re-setting the Network Connection.	230
Checking the Network Connection Status.	232

Connecting to a Scanner that has been Connected to the Network

When the scanner has already been connected to the network, you can connect a computer or a smart device to the scanner over the network.

Using a Network Scanner from a Second Computer

We recommend using the installer to connect the scanner to a computer.

To start the installer, access the following website, and then enter the product name. Go to **Setup**, and then start setting up.

<https://epson.sn>

You can view the operating instructions in the Web Movie Manuals. Access the following URL.

<https://support.epson.net/publist/vlink.php?code=NPD7126>

Selecting the Scanner

Follow the on-screen instructions until the following screen is displayed, select the scanner name you want to connect to, and then click **Next**.

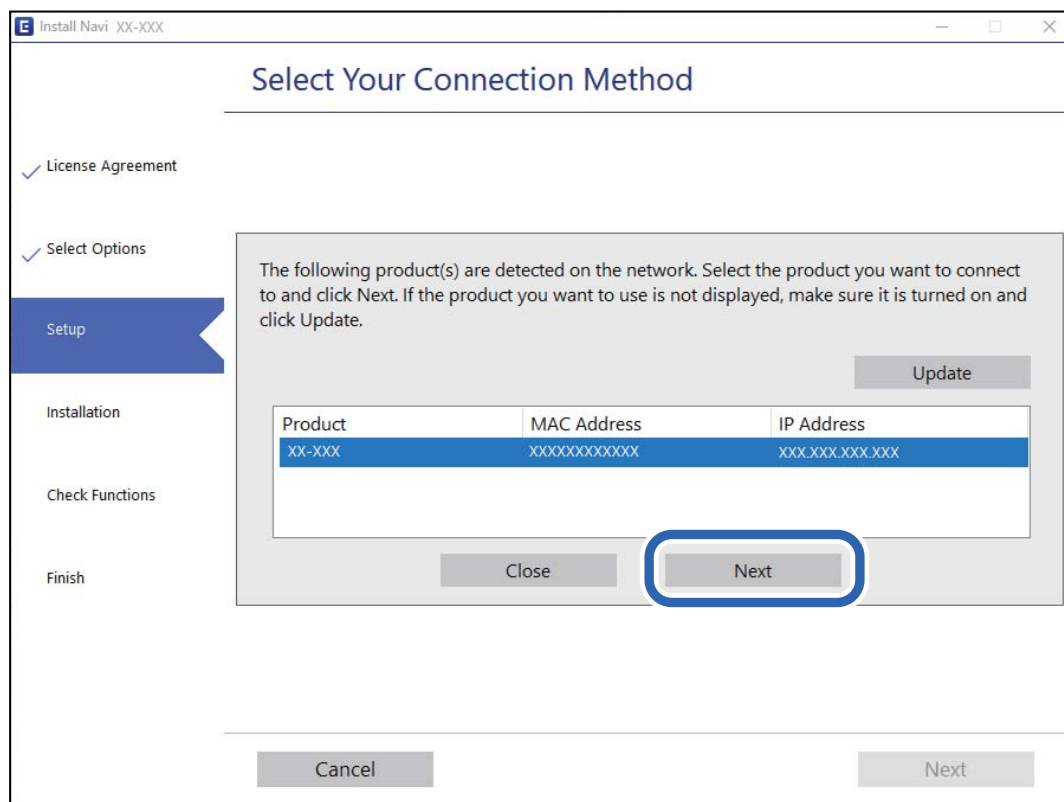

Follow the on-screen instructions.

Using a Network Scanner from a Smart Device

You can connect a smart device to the scanner using one of the following methods.

Connecting over a wireless router

Connect the smart device to the same Wi-Fi network (SSID) as the scanner.

See the following for more details.

[“Making Settings for Connecting to the Smart Device” on page 231](#)

Connecting by Wi-Fi Direct

Connect the smart device to the scanner directly without a wireless router.

See the following for more details.

[“Connecting a Smart Device and Scanner Directly \(Wi-Fi Direct\)” on page 228](#)

Connecting a Smart Device and Scanner Directly (Wi-Fi Direct)

Wi-Fi Direct (Simple AP) allows you to connect a smart device directly to the scanner without a wireless router and scan from the smart device.

About Wi-Fi Direct

Use this connection method when you are not using Wi-Fi at home or at the office, or when you want to connect the scanner and the computer or smart device directly. In this mode, the scanner acts as an wireless router and you can connect up to 8 devices to the scanner without having to use a standard wireless router. However, devices directly connected to the scanner cannot communicate with each other through the scanner.

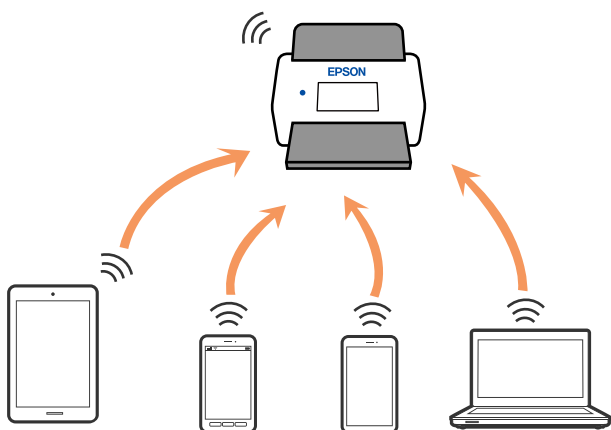

The scanner can be connected by Wi-Fi and Wi-Fi Direct (Simple AP) connection simultaneously. However, if you start a network connection in Wi-Fi Direct (Simple AP) connection when the scanner is connected by Wi-Fi, the Wi-Fi is temporarily disconnected.

Connecting to a Smart Device using Wi-Fi Direct

This method allows you to connect the scanner directly to smart devices without a wireless router.

1. Select  on the home screen.
2. Select **Wi-Fi Direct**.
3. Select **Start Setup**.
4. Start Epson Smart Panel on your smart device.
5. Follow the instructions displayed on the Epson Smart Panel to connect to your scanner.
When your smart device is connected to the scanner, go to the next step.
6. On the scanner's control panel, select **Complete**.

Disconnecting Wi-Fi Direct (Simple AP) Connection

There are two methods available to disable a Wi-Fi Direct (Simple AP) connection; you can disable all connections by using the control panel, or disable each connection from the computer or the smart device.

When you want to disable all connections, select  > **Wi-Fi Direct** > **Start Setup** >  **Disable Wi-Fi Direct**.

Important:



When Wi-Fi Direct (Simple AP) connection disabled, all computers and smart devices connected to the scanner in Wi-Fi Direct (Simple AP) connection are disconnected.

Note:

If you want to disconnect a specific device, disconnect from the device itself instead of the product. Use one of the following methods to disconnect the Wi-Fi Direct (Simple AP) connection from the device.

- Disconnect the Wi-Fi connection to the scanner's network name (SSID).*
- Connect to another network name (SSID).*

Changing the Wi-Fi Direct (Simple AP) Settings Such as the SSID

When Wi-Fi Direct (simple AP) connection is enabled, you can change the settings from  > **Wi-Fi Direct** > **Start Setup** > , and then the following menu items are displayed.

Change Network Name

Change the Wi-Fi Direct (simple AP) network name (SSID) used for connecting to the scanner to your arbitrary name. You can set the network name (SSID) in ASCII characters that is displayed on the software keyboard on the control panel. You can enter up to 22 characters.

When changing the network name (SSID), all connected devices are disconnected. Use the new network name (SSID) if you want to re-connect the device.

Change Password

Change the Wi-Fi Direct (simple AP) password for connecting to the scanner to your arbitrary value. You can set the password in ASCII characters that is displayed on the software keyboard on the control panel. You can enter 8 to 22 characters.

When changing the password, all connected devices are disconnected. Use the new password if you want to re-connect the device.

Change Frequency Range

Change the frequency range of Wi-Fi Direct used for connecting to the scanner. You can select 2.4 GHz or 5 GHz.

When changing the frequency range, all connected devices are disconnected. Re-connect the device.

Note that you cannot re-connect from devices that do not support 5 GHz frequency range when changing to 5 GHz.

This setting may not be displayed depending on your region or country.

Disable Wi-Fi Direct

Disable Wi-Fi Direct (simple AP). When this is disabled, all connected devices are disconnected.

Restore Default Settings

Restore all Wi-Fi Direct (simple AP) settings to their defaults.

The Wi-Fi Direct (simple AP) connection information of the smart device saved to the scanner is deleted.

Note:

You can also set up from the **Network** tab > **Wi-Fi Direct** on Web Config for the following settings.

Enabling or disabling Wi-Fi Direct (simple AP)

Changing network name (SSID)

Changing the Password

Changing the frequency range

This setting may not be displayed depending on your region or country.

Restoring the Wi-Fi Direct (simple AP) settings

Re-setting the Network Connection

This section explains how to make the network connection settings and change the connection method when replacing the wireless router or the computer.

When Replacing the Wireless Router

When you replace the wireless router, make settings for the connection between the computer or the smart device and the scanner.

You need to make these settings if you change your Internet service provider and so on.

Making Settings for Connecting to the Computer

We recommend using the installer to connect the scanner to a computer.

To start the installer, access the following website, and then enter the product name. Go to **Setup**, and then start setting up.

<https://epson.sn>

You can view the operating instructions in the Web Movie Manuals. Access the following URL.

<https://support.epson.net/publist/vlink.php?code=NPD7126>

Selecting a Connection Method

Follow the on-screen instructions. On the **Select Install Option** screen, select **Set up Scanner connection again (for new network router or changing USB to network, etc.)**, and then click **Next**.

Follow the on-screen instructions to finish setup.

If you cannot connect, see the following to try to solve the problem.

[“Cannot connect to a Network” on page 201](#)

Making Settings for Connecting to the Smart Device

You can use the scanner from a smart device when you connect the scanner to the same Wi-Fi network (SSID) as the smart device. To use the scanner from a smart device, access the following website, and then enter the product name. Go to **Setup**, and then start setting up.

<https://epson.sn>

Access to the website from the smart device that you want to connect to the scanner.

When Changing the Computer

When changing the computer, make connection settings between the computer and the scanner.

Making Settings for Connecting to the Computer

We recommend using the installer to connect the scanner to a computer.

To start the installer, access the following website, and then enter the product name. Go to **Setup**, and then start setting up.

<https://epson.sn>

You can view the operating instructions in the Web Movie Manuals. Access the following URL.

<https://support.epson.net/publist/vlink.php?code=NPD7126>

Follow the on-screen instructions.

Changing the Connection Method to the Computer

This section explains how to change the connection method when the computer and the scanner have been connected.

Changing from USB to a Network Connection

Using the installer and re-set up in a different connection method.

Access the following website, and then enter the product name. Go to **Setup**, and then start setting up.

<https://epson.sn>

Selecting Change the Connection Methods

Follow the instructions in each window. On the **Select Install Option** screen, select **Set up Scanner connection again (for new network router or changing USB to network, etc.)**, and then click **Next**.

Select **Connect via wireless network (Wi-Fi)**, and then click **Next**.

Follow the on-screen instructions to finish setup.

Making Wi-Fi Settings from the Control Panel

You can make network settings from the scanner's control panel in several ways. Choose the connection method that matches the environment and conditions that you are using.

If you know the information for the wireless router such as SSID and password, you can make settings manually.

If the wireless router supports WPS, you can make settings by using push button setup.

After connecting the scanner to the network, connect to the scanner from the device that you want to use (computer, smart device, tablet, and so on.)

Related Information

➔ [“Connecting the Scanner to the Network” on page 236](#)

Checking the Network Connection Status

You can check the network connection status in the following way.

Checking the Network Connection Status from the Control Panel

You can check the network connection status using the network icon or the network information on the scanner's control panel.

Checking the Network Connection Status using the Network Icon

You can check the network connection status and strength of the radio wave using the network icon on the scanner's home screen.



	<p>Displays the network connection status.</p> <p>Select the icon to check and change the current settings. This is the shortcut for the following menu.</p> <p>Settings > Network Settings > Wi-Fi Setup</p>
	<p>The scanner is not connected to a wireless (Wi-Fi) network.</p>
	<p>The scanner is searching for SSID, unset IP address, or having a problem with a wireless (Wi-Fi) network.</p>
	<p>The scanner is connected to a wireless (Wi-Fi) network.</p> <p>The number of bars indicates the signal strength of the connection. The more bars there are, the stronger the connection.</p>
	<p>The scanner is not connected to a wireless (Wi-Fi) network in Wi-Fi Direct (Simple AP) mode.</p>
	<p>The scanner is connected to a wireless (Wi-Fi) network in Wi-Fi Direct (Simple AP) mode.</p>

Displaying Detailed Network Information on the Control Panel

When your scanner is connected to the network, you can also view other network-related information by selecting the network menus you want to check.

1. Select **Settings** on the home screen.
2. Select **Network Settings > Network Status**.
3. To check the information, select the menus that you want to check.
 - Wi-Fi Status**
Displays the network information (device name, connection, signal strength, and so on) for Wi-Fi connections.
 - Wi-Fi Direct Status**
Displays whether Wi-Fi Direct is enabled or disabled, and the SSID, password and so on for Wi-Fi Direct connections.
 - Email Server Status**
Displays the network information for email server.

Checking the Network of the Computer (Windows only)

By using the command prompt, check the connection status of the computer and the connection path to the scanner. This will lead you to solve the problems.

ipconfig command

Display the connection status of the network interface that is currently used by the computer.

By comparing the setting information with actual communication, you can check whether the connection is correct. In case there are multiple DHCP servers on the same network, you can find out the actual address assigned to the computer, the referred DNS server, etc.

Format : ipconfig /all

Examples :

```

c:\>ipconfig /all

Windows IP Configuration

Host Name . . . . . : WIN2012R2
Primary Dns Suffix . . . . . : pubs.net
Node Type . . . . . : Hybrid
IP Routing Enabled. . . . . : No
WINS Proxy Enabled. . . . . : No
DNS Suffix Search List. . . . . : pubs.net

Ethernet adapter Ethernet:

Connection-specific DNS Suffix . . : Gigabit Network Connection
Description . . . . . : 
Physical Address . . . . . : XX-XX-XX-XX-XX-XX
DHCP Enabled. . . . . : No
Autoconfiguration Enabled . . . . : Yes
Link-local IPv6 Address . . . . . : fe80::38fb:7546:18a8:d20e%14(Preferred)
IPv4 Address. . . . . : 192.168.111.10(Preferred)
Subnet Mask . . . . . : 255.255.255.0
Default Gateway . . . . . : 192.168.111.1
DHCPv6 IAID . . . . . : 283142549
DHCPv6 Client DUID. . . . . : 00-01-00-01-20-40-2F-45-00-1D-73-6A-44-00
DNS Servers . . . . . : 192.168.111.2
NetBIOS over Tcpip. . . . . : Enabled

Tunnel adapter isatap.{00000000-ABCD-EFGH-IJK-LMNOPQRSTUUV}>:

Media State . . . . . : Media disconnected
Connection-specific DNS Suffix . . : 
Description . . . . . : Microsoft ISATAP Adapter #2
Physical Address. . . . . : 00-00-00-00-00-00-E0
DHCP Enabled. . . . . : No
Autoconfiguration Enabled . . . . : Yes

c:\>_
    
```

pathping command

You can confirm the list of routers passing through the destination host and the routing of communication.

Format : pathping xxx.xxx.xxx.xxx

Examples : pathping 192.0.2.222

```

c:\>pathping 192.168.111.20

Tracing route to EPSONAB12AB [192.168.111.20]
over a maximum of 30 hops:
 0  WIN2012R2.pubs.net [192.168.111.10]
 1  EPSONAB12AB [192.168.111.20]

Computing statistics for 25 seconds...
Hop  RTT      Source to Here   This Node/Link   Address
 0      0/ 100 = 0%      0/ 100 = 0%      WIN2012R2.pubs.net [192.168.111.10]
 1  38ms     0/ 100 = 0%      0/ 100 = 0%      EPSONAB12AB [192.168.111.20]

Trace complete.

c:\>_
    
```

Administrator Information

Connecting the Scanner to the Network.	236
Introduction of Product Security Features.	240
Administrator Settings.	240
Disabling the External Interface.	245
Disabling Network Scanning from your Computer.	245
Disabling WSD Scan.	246
Monitoring a Remote Scanner.	246
Backing Up the Settings.	248
Advanced Security Settings.	249

Connecting the Scanner to the Network

Connect the scanner to the network by using the scanner's control panel.

See Related Information for more details.

Note:

If your scanner and computer are in the same segment, you can also connect using the installer.

To start the installer, access the following website, and then enter the product name. Go to **Setup**, and then start setting up.

<https://epson.sn>

Related Information

➔ “Connecting to the Wireless LAN (Wi-Fi)” on page 137

Before Making Network Connection

To connect to the network, check the connection method and setting information for connection in advance.

Gathering Information on the Connection Setting

Prepare the necessary setting information to connect. Check the following information in advance.

Divisions	Items	Note
Network connection information	<input type="checkbox"/> IP address <input type="checkbox"/> Subnet mask <input type="checkbox"/> Default gateway	Decide the IP address to assign to the scanner. When you assign the IP address statically, all values are required. When you assign the IP address dynamically using the DHCP function, this information is not required because it is set automatically.
Wi-Fi connection information	<input type="checkbox"/> SSID <input type="checkbox"/> Password	These are the SSID (network name) and the password of the access point that the scanner connects to. If MAC address filtering has been set, register the MAC address of the scanner in advance to register the scanner. See the following for the supported standards. “Network Specifications” on page 281
DNS server information	<input type="checkbox"/> IP address for primary DNS <input type="checkbox"/> IP address for secondary DNS	These are required when specifying DNS servers. The secondary DNS is set when the system has a redundant configuration and there is a secondary DNS server. If you are in a small organization and do not set the DNS server, set the IP address of the router.

Divisions	Items	Note
Proxy server information	<input type="checkbox"/> Proxy server name	<p>Set this when your network environment uses the proxy server to access the internet from the intranet, and you use the function that the scanner directly accesses to the internet.</p> <p>For the following functions, the scanner directly connects to the internet .</p> <ul style="list-style-type: none"> <input type="checkbox"/> Epson Connect Services <input type="checkbox"/> Cloud services of other companies <input type="checkbox"/> Firmware updating <input type="checkbox"/> Sending scanned images to SharePoint(WebDAV)
Port number information	<input type="checkbox"/> Port number to release	<p>Check the port number used by the scanner and computer, then release the port that is blocked by a firewall, if necessary.</p> <p>See the following for the port number used by the scanner.</p> <p>"Using Port for the Scanner" on page 283</p>

IP Address Assignment

These are the following types of IP address assignment.

Static IP address:

Assign the predetermined IP address to the scanner (host) manually.

The information to connect to the network (subnet mask, default gateway, DNS server and so on) need to be set manually.

The IP address does not change even when the device is turned off, so this is useful when you want to manage devices with an environment where you cannot change the IP address or you want to manage devices using the IP address. We recommend settings to the scanner, server, etc. that many computers access. Also, when using security features such as IPsec / IP filtering, assign a fixed IP address so that the IP address does not change.

Automatic assignment by using DHCP function (dynamic IP address):

Assign the IP address automatically to the scanner (host) by using the DHCP function of the DHCP server or router.

The information to connect to the network (subnet mask, default gateway, DNS server and so on) is set automatically, so you can easily connect the device to the network.

If the device or the router is turned off, or depending on the DHCP server settings, IP address may change when re-connecting.

We recommend managing devices other than the IP address and communicating with protocols that can follow the IP address.

Note:

When you use the IP address reservation function of the DHCP, you can assign the same IP address to the devices at any time.

DNS Server and Proxy Server

The DNS server has a host name, domain name of the email address, etc. in association with the IP address information.

Communication is impossible if the other party is described by host name, domain name, etc. when the computer or the scanner performs IP communication.

Queries the DNS server for that information and gets the IP address of the other party. This process is called name resolution.

Therefore, the devices such as computers and scanners can communicate using the IP address.

Name resolution is necessary for the scanner to communicate using the email function or Internet connection function.

When you use those functions, make the DNS server settings.

When you assign the scanner's IP address by using the DHCP function of the DHCP server or router, it is automatically set.

The proxy server is placed at the gateway between the network and the Internet, and it communicates to the computer, scanner, and Internet (opposite server) on behalf of each of them. The opposite server communicates only to the proxy server. Therefore, scanner information such as the IP address and port number cannot be read and increased security is expected.

When you connect to the Internet via a proxy server, configure the proxy server on the scanner.

Assigning the IP Address

Set up the basic items such as Host Address, Subnet Mask, Default Gateway.

This section explains the procedure for setting a static IP address.

1. Turn on the scanner.
2. Select **Settings** on the home screen on the scanner's control panel.
3. Select **Network Settings** > **Advanced** > **TCP/IP**.
4. Select **Manual** for **Obtain IP Address**.

When you set the IP address automatically by using the DHCP function of router, select **Auto**. In that case, the **IP Address**, **Subnet Mask**, and **Default Gateway** on step 5 to 6 are also set automatically, so go to step 7.

5. Enter the IP address.

Focus moves to the forward segment or the back segment separated by a period if you select ◀ and ▶.

Confirm the value reflected on the previous screen.

6. Set up the **Subnet Mask** and **Default Gateway**.

Confirm the value reflected on the previous screen.



Important:

*If the combination of the IP Address, Subnet Mask and Default Gateway is incorrect, **Start Setup** is inactive and cannot proceed with the settings. Confirm that there is no error in the entry.*

7. Enter the IP address for the primary DNS server.
Confirm the value reflected on the previous screen.

Note:

When you select **Auto** for the IP address assignment settings, you can select the DNS server settings from **Manual** or **Auto**. If you cannot obtain the DNS server address automatically, select **Manual** and enter the DNS server address. Then, enter the secondary DNS server address directly. If you select **Auto**, go to step 9.

8. Enter the IP address for the secondary DNS server.
Confirm the value reflected on the previous screen.
9. Tap **Start Setup**.

Setting the Proxy Server

Set up the proxy server if both of the following are true.

- The proxy server is built for Internet connection.
- When using a function in which a scanner directly connects to the Internet, such as Epson Connect service or another company's cloud services.

1. Select **Settings** on the home screen.
When making settings after IP address setting, the **Advanced** screen is displayed. Go to step 3.
2. Select **Network Settings** > **Advanced**.
3. Select **Proxy Server**.
4. Select **Use** for **Proxy Server Settings**.
5. Enter the address for the proxy server by IPv4 or FQDN format.
Confirm the value reflected on the previous screen.
6. Enter the port number for the proxy server.
Confirm the value reflected on the previous screen.
7. Tap **Start Setup**.

Setting up the IEEE802.11k/v or IEEE802.11r Features

1. Access Web Config, and then select the **Network** tab > **Basic**.
2. Set **IEEE802.11k/v** or **IEEE802.11r** to enabled or disabled.
3. Click **Next**.
The setting confirmation screen is displayed.
4. Click **OK**.

Related Information

➔ [“How to Run Web Config in a Web Browser” on page 36](#)

Introduction of Product Security Features

This section introduces the security function of the Epson Devices.

Feature name	Feature type	What to set	What to prevent
Configuring the Administrator Password	Locks the system settings, such as connection setup for network or USB.	An administrator sets a password to the device. You can set or change from both Web Config and the scanner's control panel.	Prevent from illegally reading and changing the information stored in the device such as ID, password, network settings, and so on. Also, reduce a wide range of security risks such as leakage of information for the network environment or security policy.
Setup for external interface	Controls the interface that connects to the device.	Enable or disable USB connection with the computer.	USB connection of computer: Prevents unauthorized use of the device by prohibiting scanning without going through the network.

Administrator Settings

Configuring the Administrator Password

When you set an administrator password, you can prevent users from changing system management settings. The default values are set at the time of purchase. We recommend changing the initial administrator password from the default setting.

Note:

The following provides the default values for the administrator information.

- User name (used for Web Config only): None (blank)*
- Password: Depends on the label attached to product.*

If there is a "PASSWORD" label attached to the back, enter the 8-digit number shown on the label.

If there is no "PASSWORD" label attached, enter the serial number on the label attached to the base of the product for the initial administrator password.

You can change the administrator password using either Web Config, the scanner's control panel, or Epson Device Admin. When using Epson Device Admin, see the Epson Device Admin guide or help.

Changing the Administrator Password from the Scanner's Control Panel

You can change the administrator password from the scanner's control panel.

1. Select **Settings** on the scanner's control panel.
2. Select **System Administration > Admin Settings**.
3. Select **Admin Password > Change**.
4. Enter your current password.

Note:

The initial administrator password (default) at the time of purchase varies depending on the label attached to the product. If there is a "PASSWORD" label attached to the back, enter the 8-digit number shown on the label. If there is no "PASSWORD" label attached, enter the serial number on the label attached to the base of the product for the initial administrator password.

5. Enter your new password.

The new password must be 8 to 20 characters long and only contain single-byte alphanumeric characters and symbols.



Important:

Be sure to remember the administrator password you set. If you forget your password, you will not be able to reset it and you will need to request help from service personnel.

6. Enter the new password again for confirmation.

A completion message is displayed.

Changing the Administrator Password Using Web Config

Change the administrator password in Web Config.

1. Access Web Config and select the **Product Security** tab > **Change Administrator Password**.
2. Enter the necessary information in **Current password**, **User Name**, **New Password**, and **Confirm New Password**.

The new password must be 8 to 20 characters long and only contain single-byte alphanumeric characters and symbols.

Note:

The following provides the default values for the administrator information.

User name: none (blank)

Password: Depends on the label attached to product.

If there is a "PASSWORD" label attached to the back, enter the 8-digit number shown on the label. If there is no "PASSWORD" label attached, enter the serial number on the label attached to the base of the product for the initial administrator password.



Important:

Be sure to remember the administrator password you set. If you forget your password, you will not be able to reset it and you will need to request help from service personnel.

3. Select **OK**.

Related Information

- ➔ [“Notes on the Administrator Password” on page 13](#)
- ➔ [“How to Run Web Config in a Web Browser” on page 36](#)

Using Lock Setting for the Control Panel

You can use Lock Setting to lock the control panel to prevent users from changing items related to system settings.

Setting Lock Setting from the Control Panel

1. Select **Settings**.
2. Select **System Administration > Admin Settings**.
When Lock Setting is set, you will be prompted to enter the password.
3. Select **On** or **Off** as the **Lock Setting**.

Setting Lock Setting from Web Config

1. Select the **Device Management** tab > **Control Panel**.
2. Select **ON** or **OFF** for **Panel Lock**.
3. Click **OK**.

Related Information

- ➔ [“How to Run Web Config in a Web Browser” on page 36](#)

Lock Setting items on the Settings Menu

This is a list of items that are locked in the **Settings** menu on the control panel by Lock Setting.

✓ : To be locked. - : Not to be locked.

Settings menu	Lock Setting
Start-up Screen	✓
Basic Settings	-

Settings menu		Lock Setting
	LCD Brightness	-
	Sounds	-
	Sleep Timer	✓
	Power Off Timer	✓
	Date/Time Settings	✓
	Language	✓
	Keyboard (This feature may not be available depending on your region.)	-
	Operation Time Out	✓
	PC Connection via USB	✓
	Direct power on	✓
Scanner Settings		-
	Double Feed Stop Timing	✓
	Paper Protection	✓
	Glass Dirt Detection	✓
	Automatic Feeding Mode Timeout	✓
	Confirm Recipient	-
User Settings		✓
Network Settings		✓
Web Service Settings		✓
Contacts Manager		-
	Register/Delete	✓
	Search Options	-
System Administration		✓
Device Information		-

Settings menu		Lock Setting
	Serial Number	-
	Current Version	-
	Total Number of Scans	-
	Number of 1-Sided Scans	-
	Number of 2-Sided Scans	-
	Number of Scans of Carrier Sheet	-
	Number of Passport Carrier Sheet	-
	Number of Scans After Replacing Pickup Roller	-
	Number of Scans After Regular Cleaning	-
	 Reset the Number of Scans	-
	Number of Scans After Replacing Pickup Roller	✓
	Number of Scans After Regular Cleaning	✓
Scanner Maintenance		-
	Roller Replacement	-
	Reset the Number of Scans	✓
	Regular Cleaning	-
	Reset the Number of Scans	✓
Roller Replacement Alert Setting		✓
Regular Cleaning Alert Settings		✓

Logging on to the Scanner from a Computer

When you log in to Web Config as an administrator, you can operate items that are set in the Lock Setting.

1. Enter the scanner's IP address into a browser to run Web Config.
2. Click **Administrator Login**.
3. Enter the user name and administrator password in **User Name** and **Current password**.
4. Click **OK**.

The locked items and **Administrator Logout** are displayed when being authenticated.

Click **Administrator Logout** to log off.

Related Information

➔ [“Notes on the Administrator Password” on page 13](#)

➔ [“How to Run Web Config in a Web Browser” on page 36](#)

Disabling the External Interface

You can disable the interface that is used to connect the device to the scanner. Make the restriction settings to restrict scanning other than via network.

Note:

You can also make the restriction settings on the scanner's control panel.

PC Connection via USB : **Settings** > **Basic Settings** > **PC Connection via USB**

1. Access Web Config and select the **Product Security** tab > **External Interface**.
2. Select **Disable** on the functions you want to set.
Select **Enable** when you want to cancel controlling.
PC Connection via USB
You can restrict the usage of the USB connection from the computer. If you want to restrict it, select **Disable**.
3. Click **OK**.
4. Check that the disabled port cannot be used.
PC Connection via USB
If the driver was installed on the computer
Connect the scanner to the computer using a USB cable, and then confirm that the scanner does not scan.
If the driver was not installed on the computer
Windows:
Open the device manager and keep it, connect the scanner to the computer using a USB cable, and then confirm that the device manager's display contents stays unchanged.
Mac OS:
Connect the scanner to the computer using a USB cable, and then confirm that you cannot add the scanner from **Printers & Scanners**.

Related Information

➔ [“How to Run Web Config in a Web Browser” on page 36](#)

Disabling Network Scanning from your Computer

You can make the following settings in Web Config to disable network scanning using EPSON Scan from your computer.

1. Access Web Config, and then select the **Scan** tab > **Network Scan**.
2. In **EPSON Scan**, clear the **Enable scanning** check box.

3. Click **Next**.

The setting confirmation screen is displayed.

4. Click **OK**.

Related Information

➔ [“How to Run Web Config in a Web Browser” on page 36](#)

Disabling WSD Scan

Note:

You can also make settings on the scanner's control panel. Select **Settings** > **System Administration** > **WSD Settings**.

If you do not want your computer to configure the scanner as a WSD scanning device, follow the steps below to disable the WSD settings.

1. Access Web Config, and then select the **Network Security** tab > **Protocol**.
2. In **WSD Settings**, clear the **Enable WSD** check box.
3. Click **Next**.
The setting confirmation screen is displayed.
4. Click **OK**.

Related Information

➔ [“How to Run Web Config in a Web Browser” on page 36](#)

Monitoring a Remote Scanner

Checking Information for a Remote Scanner

You can check the following information of the operating scanner from **Status** by using Web Config.

- Product Status**
Check the status, product number, MAC address, etc.
- Network Status**
Check the information of the network connection status, IP address, DNS server, etc.
- Usage Status**
Check the first day of scanning, scanning count, and so on.
- Hardware Status**
Check the status of each function of the scanner.
- Panel Snapshot**
Displays a snapshot of the screen displayed on the scanner's control panel.

Receiving Email Notifications When Events Occur

About Email Notifications

This is the notification function that, when events such as scanning stop and scanner error occur, send the email to the specified address.

You can register up to five destinations and set the notification settings for each destination.

To use this function, you need to set up the mail server before setting up notifications.

Configuring Email Notification

Configure email notification by using Web Config.

1. Access Web Config and select the **Device Management** tab > **Email Notification**.

2. Set the subject of email notification.

Select the contents displayed on the subject from the two pull-down menus.

The selected contents are displayed next to **Subject**.

The same contents cannot be set on left and right.

When the number of characters in **Location** exceeds 32 bytes, characters exceeding 32 bytes are omitted.

3. Enter the email address for sending the notification email.

Use A-Z a-z 0-9 ! # \$ % & ' * + - . / = ? ^ _ { | } ~ @, and enter between 1 and 255 characters.

4. Select the language for the email notifications.

5. Select the check box on the event for which you want to receive a notification.

The number of **Notification Settings** is linked to the destination number of **Email Address Settings**.

Example :

If you want to send a notification to the email address set for number 1 in **Email Address Settings** when the admin password is changed, select the check box for column **1** on the line **Administrator password changed**.

6. Click **OK**.

Confirm that an email notification will be sent by causing an event.

Example : The administrator password has been changed.

Related Information

➔ [“How to Run Web Config in a Web Browser” on page 36](#)

Items for Email Notification

Items	Settings and Explanation
Administrator password changed	Notice when administrator password has been changed.

Items	Settings and Explanation
Scanner error	Notice when the scanner error has occurred.
Wi-Fi failure	Notice when the error of the wireless LAN interface has occurred.

Backing Up the Settings

You can export the setting value set from Web Config to the file. You can use it for backing up the setting values, replacing the scanner, etc.

The exported file cannot be edited because it is exported as a binary file.

Export the settings

Export the setting for the scanner.

1. Access Web Config, and then select the **Device Management** tab > **Export and Import Setting Value** > **Export**.

2. Select the settings that you want to export.

Select the settings you want to export. If you select the parent category, subcategories are also selected.

However, subcategories that cause errors by duplicating within the same network (such as IP addresses and so on) cannot be selected.

3. Enter a password to encrypt the exported file.

You need the password to import the file. Leave this blank if you do not want to encrypt the file.

4. Click **Export**.

 **Important:**

*If you want to export the scanner's network settings such as the device name and IPv6 address, select **Enable to select the individual settings of device** and select more items. Only use the selected values for the replacement scanner.*

Related Information

➔ [“How to Run Web Config in a Web Browser” on page 36](#)

Import the settings

Import the exported Web Config file to the scanner.

 **Important:**

When importing values that include individual information such as a scanner name or IP address, make sure the same IP address does not exist on the same network.

1. Access Web Config, and then select the **Device Management** tab > **Export and Import Setting Value** > **Import**.
2. Select the exported file, and then enter the encrypted password.
3. Click **Next**.
4. Select the settings that you want to import, and then click **Next**.
5. Click **OK**.

The settings are applied to the scanner.

Related Information

➔ [“How to Run Web Config in a Web Browser” on page 36](#)

Advanced Security Settings

This section explains advanced security features.

Security Settings and Prevention of Danger

When a scanner is connected to a network, you can access it from a remote location. In addition, many people can share the scanner, which is helpful in improving operational efficiency and convenience. However, risks such as illegal access, illegal use, and tampering with data are increased. If you use the scanner in an environment where you can access the Internet, the risks are even higher.

For scanners that do not have access protection from the outside, it will be possible to read the contacts that are stored in the scanner from the Internet.

In order to avoid this risk, Epson scanners have a variety of security technologies.

Set the scanner as necessary according to the environmental conditions that have been built with the customer's environment information.

Name	Feature type	What to set	What to prevent
Control of protocol	Controls the protocols and services to be used for communication between scanners and computers, and it enables and disables features.	A protocol or service that is applied to features allowed or prohibited separately.	Reducing security risks that may occur through unintended use by preventing users from using unnecessary functions.

Name	Feature type	What to set	What to prevent
SSL/TLS communications	The communication content is encrypted with SSL/TLS communications when accessing to the Epson server on the Internet from the scanner, such as communicating to the computer via web browser, using Epson Connect, and updating firmware.	Obtain a CA-signed certificate, and then import it to the scanner.	Clearing an identification of the scanner by the CA-signed certification prevents impersonation and unauthorized access. In addition, communication contents of SSL/TLS are protected, and it prevents the leakage of contents for scanning data and setup information.
IPsec/IP filtering	You can set to allow severing and cutting off of data that is from a certain client or is a particular type. Since IPsec protects the data by IP packet unit (encryption and authentication), you can safely communicate unsecured protocol.	Create a basic policy and individual policy to set the client or type of data that can access the scanner.	Protect unauthorized access, and tampering and interception of communication data to the scanner.
IEEE802.1X	Only allows authenticated users to connect to the network. Allows only a permitted user to use the scanner.	Authentication setting to the RADIUS server (authentication sever).	Protect unauthorized access and use to the scanner.

Security Feature Settings

When setting IPsec/IP filtering or IEEE802.1X, it is recommended that you access Web Config using SSL/TLS to communicate settings information in order to reduce security risks such as tampering or interception.

Make sure you configure the administrator password before setting IPsec/IP filtering or IEEE802.1X.

Controlling Using Protocols

You can scan using a variety of pathways and protocols. Also, you can use network scanning from an unspecified number of network computers.

You can lower unintended security risks by restricting scanning from specific pathways or by controlling the available functions.

Controlling protocols

Configure the protocol settings supported by the scanner.

1. Access Web Config and then select the **Network Security** tab > **Protocol**.
2. Configure each item.
3. Click **Next**.

4. Click **OK**.

The settings are applied to the scanner.

Related Information

➔ [“How to Run Web Config in a Web Browser” on page 36](#)

Protocols you can Enable or Disable

Protocol	Description
Bonjour Settings	You can specify whether to use Bonjour. Bonjour is used to search for devices, scan, and so on.
SLP Settings	You can enable or disable the SLP function. SLP is used for push scanning and network searching in EpsonNet Config.
WSD Settings	You can enable or disable the WSD function. When this is enabled, you can add WSD devices, and scan from the WSD port.
LLTD Settings	You can enable or disable the LLTD function. When this is enabled, it is displayed on the Windows network map.
LLMNR Settings	You can enable or disable the LLMNR function. When this is enabled, you can use name resolution without NetBIOS even if you cannot use DNS.
SNMPv1/v2c Settings	You can specify whether or not to enable SNMPv1/v2c. This is used to set up devices, monitoring, and so on.
SNMPv3 Settings	You can specify whether or not to enable SNMPv3. This is used to set up encrypted devices, monitoring, etc.

Protocol Setting Items

Bonjour Settings

Item	Settings and Explanation
Use Bonjour	Select this to search for or use devices through Bonjour.
Bonjour Name	Displays the Bonjour name.
Bonjour Service Name	Displays the Bonjour service name.
Location	Displays the Bonjour location name.
Wide-Area Bonjour	Set whether to use Wide-Area Bonjour.

SLP Settings

Item	Settings and Explanation
Enable SLP	Select this to enable the SLP function. This is used with network searching in EpsonNet Config.

WSD Settings

Item	Settings and Explanation
Enable WSD	Select this to enable adding devices using WSD and scan from the WSD port.
Scanning Timeout (sec)	Enter the communication timeout value for WSD scanning between 3 to 3,600 seconds.
Device Name	Displays the WSD device name.
Location	Displays the WSD location name.

LLTD Settings

Item	Settings and Explanation
Enable LLTD	Select this to enable LLTD. The scanner is displayed in the Windows network map.
Device Name	Displays the LLTD device name.

LLMNR Settings

Item	Settings and Explanation
Enable LLMNR	Select this to enable LLMNR. When this is enabled, you can use name resolution without NetBIOS even if you cannot use DNS.

SNMPv1/v2c Settings

Item	Settings and Explanation
Enable SNMPv1/v2c	Select to enable SNMPv1/v2c.
Access Authority	Set the access authority when SNMPv1/v2c is enabled. Select Read Only or Read/Write .
Community Name (Read Only)	Enter within 32 characters in ASCII (0x20-0x7E). If you do not specify this, leave it blank.
Community Name (Read/Write)	Enter within 32 characters in ASCII (0x20-0x7E). If you do not specify this, leave it blank.
Allow access from Epson tools	Set whether to allow writing from Epson tools such as Epson Device Admin.

SNMPv3 Settings

Item	Settings and Explanation
Enable SNMPv3	SNMPv3 is enabled when the box is checked.
User Name	Enter between 1 and 32 characters using 1 byte characters.
Authentication Settings	

Item		Settings and Explanation
	Algorithm	Select an algorithm for an authentication for SNMPv3.
	Password	Enter the password for an authentication for SNMPv3. Enter between 8 and 32 characters in ASCII (0x20-0x7E). If you do not specify this, leave it blank.
	Confirm Password	Enter the password you configured for confirmation.
Encryption Settings		
	Algorithm	Select an algorithm for an encryption.
	Password	Enter the password for an encryption. Enter between 8 and 32 characters in ASCII (0x20-0x7E). If you do not specify this, leave it blank.
	Confirm Password	Enter the password you configured for confirmation.
Context Name		Enter within 32 characters in Unicode (UTF-8). If you do not specify this, leave it blank. The number of characters that can be entered varies depending on the language.

Using a Digital Certificate

About Digital Certification

CA-signed Certificate

This is a certificate signed by the CA (Certificate Authority.) You can obtain it to apply to the Certificate Authority. This certificate certifies the existence of the scanner is and used for SSL/TLS communication so that you can ensure the safety of data communication.

When it is used for SSL/TLS communication, it is used as a server certificate.

When it is set to IPsec/IP Filtering or IEEE802.1x communication, it is used as a client certificate.

CA Certificate

This is a certificate that is in chain of the CA-signed Certificate, also called the intermediate CA certificate. It is used by the web browser to validate the path of the scanner's certificate when accessing the server of the other party or Web Config.

For the CA Certificate, set when to validate the path of server certificate accessing from the scanner. For the scanner, set to certify the path of the CA-signed Certificate for SSL/TLS connection.

You can obtain the CA certificate of the scanner from the Certification Authority where the CA certificate is issued.

Also, you can obtain the CA certificate used to validate the server of the other party from the Certification Authority that issued the CA-signed Certificate of the other server.

Self-signed Certificate

This is a certificate that the scanner signs and issues itself. It is also called the root certificate. Because the issuer certifies itself, it is not reliable and cannot prevent impersonation.

Use it when making the security setting and performing simple SSL/TLS communication without the CA-signed Certificate.

If you use this certificate for an SSL/TLS communication, a security alert may be displayed on a web browser because the certificate is not registered on a web browser. You can use the Self-signed Certificate only for an SSL/TLS communication.

Configuring a CA-signed Certificate

Obtaining a CA-signed Certificate

To obtain a CA-signed certificate, create a CSR (Certificate Signing Request) and apply it to certificate authority. You can create a CSR using Web Config and a computer.

Follow the steps to create a CSR and obtain a CA-signed certificate using Web Config. When creating a CSR using Web Config, a certificate is the PEM/DER format.

1. Access Web Config, and then select the **Network Security** tab. Next, select **SSL/TLS > Certificate** or **IPsec/IP Filtering > Client Certificate** or **IEEE802.1X > Client Certificate**.

Whatever you choose, you can obtain the same certificate and use it in common.

2. Click **Generate** of **CSR**.

A CSR creating page is opened.

3. Enter a value for each item.

Note:

Available key length and abbreviations vary by a certificate authority. Create a request according to rules of each certificate authority.

4. Click **OK**.

A completion message is displayed.

5. Select the **Network Security** tab. Next, select **SSL/TLS > Certificate**, or **IPsec/IP Filtering > Client Certificate** or **IEEE802.1X > Client Certificate**.

6. Click one of the download buttons of **CSR** according to a specified format by each certificate authority to download a CSR to a computer.



Important:

Do not generate a CSR again. If you do so, you may not be able to import an issued CA-signed Certificate.

7. Send the CSR to a certificate authority and obtain a CA-signed Certificate.

Follow the rules of each certificate authority on sending method and form.

8. Save the issued CA-signed Certificate to a computer connected to the scanner.

Obtaining a CA-signed Certificate is complete when you save a certificate to a destination.

Related Information

➔ [“How to Run Web Config in a Web Browser” on page 36](#)

CSR Setting Items

Items	Settings and Explanation
Key Length	Select a key length for a CSR.
Common Name	<p>You can enter between 1 and 128 characters. If this is an IP address, it should be a static IP address. You can enter 1 to 5 IPv4 addresses, IPv6 addresses, host names, FQDNs by separating them with commas.</p> <p>The first element is stored to the common name, and other elements are stored to the alias field of the certificate subject.</p> <p>Example: Scanner's IP address : 192.0.2.123, Scanner name : EPSONA1B2C3 Common Name : EPSONA1B2C3,EPSONA1B2C3.local,192.0.2.123</p>
Organization/ Organizational Unit/ Locality/ State/Province	You can enter between 0 and 64 characters in ASCII (0x20-0x7E). You can divide distinguished names with commas.
Country	Enter a country code in two-digit number specified by ISO-3166.
Sender's Email Address	You can enter the sender's email address for the mail server setting. Enter the same email address as the Sender's Email Address for the Network tab > Email Server > Basic .

Importing a CA-signed Certificate

Import the obtained CA-signed Certificate to the scanner.



Important:

- Make sure that the scanner's date and time is set correctly. Certificate may be invalid.
- If you obtain a certificate using a CSR created from Web Config, you can import a certificate one time.

1. Access Web Config and then select the **Network Security** tab. Next, select **SSL/TLS > Certificate**, or **IPsec/IP Filtering > Client Certificate** or **IEEE802.1X > Client Certificate**.
2. Click **Import**
A certificate importing page is opened.
3. Enter a value for each item. Set **CA Certificate 1** and **CA Certificate 2** when verifying the path of the certificate on the web browser that accesses the scanner.

Depending on where you create a CSR and the file format of the certificate, required settings may vary. Enter values to required items according to the following.

- A certificate of the PEM/DER format obtained from Web Config
 - Private Key:** Do not configure because the scanner contains a private key.
 - Password:** Do not configure.
 - CA Certificate 1/CA Certificate 2:** Optional

- A certificate of the PEM/DER format obtained from a computer
 - Private Key:** You need to set.
 - Password:** Do not configure.
 - CA Certificate 1/CA Certificate 2:** Optional
- A certificate of the PKCS#12 format obtained from a computer
 - Private Key:** Do not configure.
 - Password:** Optional
 - CA Certificate 1/CA Certificate 2:** Do not configure.

4. Click **OK**.

A completion message is displayed.

Note:

Click **Confirm** to verify the certificate information.

Related Information

➔ [“How to Run Web Config in a Web Browser” on page 36](#)

CA-signed Certificate Importing Setting Items

Items	Settings and Explanation
Server Certificate or Client Certificate	Select a certificate's format. For SSL/TLS connection, the Server Certificate is displayed. For IPsec/IP Filtering or IEEE802.1x, the Client Certificate is displayed.
Private Key	If you obtain a certificate of the PEM/DER format by using a CSR created from a computer, specify a private key file that is match a certificate.
Password	If the file format is Certificate with Private Key (PKCS#12) , enter the password for encrypting the private key that is set when you obtain the certificate.
CA Certificate 1	If your certificate's format is Certificate (PEM/DER) , import a certificate of a certificate authority that issues a CA-signed Certificate used as server certificate. Specify a file if you need.
CA Certificate 2	If your certificate's format is Certificate (PEM/DER) , import a certificate of a certificate authority that issues CA Certificate 1. Specify a file if you need.

Deleting a CA-signed Certificate

You can delete an imported certificate when the certificate has expired or when an encrypted connection is no longer necessary.



Important:

If you obtain a certificate using a CSR created from Web Config, you cannot import a deleted certificate again. In this case, create a CSR and obtain a certificate again.

1. Access Web Config, and then select the **Network Security** tab. Next, select **SSL/TLS > Certificate** or **IPsec/IP Filtering > Client Certificate** or **IEEE802.1X > Client Certificate**.
2. Click **Delete**.
3. Confirm that you want to delete the certificate in the message displayed.

Related Information

➔ [“How to Run Web Config in a Web Browser” on page 36](#)

Updating a Self-signed Certificate

Because the Self-signed Certificate is issued by the scanner, you can update it when it has expired or when the content described changes.

1. Access Web Config and select the **Network Security** tab > **SSL/TLS > Certificate**.
2. Click **Update**.
3. Enter **Common Name**.

You can enter up to 5 IPv4 addresses, IPv6 addresses, host names, FQDNs between 1 to 128 characters and separating them with commas. The first parameter is stored to the common name, and the others are stored to the alias field for the subject of the certificate.

Example:

Scanner's IP address : 192.0.2.123, Scanner name : EPSONA1B2C3

Common name : EPSONA1B2C3,EPSONA1B2C3.local,192.0.2.123

4. Specify a validity period for the certificate.
5. Click **Next**.

A confirmation message is displayed.

6. Click **OK**.

The scanner is updated.

Note:

You can check the certificate information from **Network Security** tab > **SSL/TLS > Certificate > Self-signed Certificate** and click **Confirm**.

Related Information

➔ [“How to Run Web Config in a Web Browser” on page 36](#)

Configuring a CA Certificate

When you set the CA Certificate, you can validate the path to the CA certificate of the server that the scanner accesses. This can prevent impersonation.

You can obtain the CA Certificate from the Certification Authority where the CA-signed Certificate is issued.

Importing a CA Certificate

Import the CA Certificate to the scanner.

1. Access Web Config and then select the **Network Security** tab > **CA Certificate**.
2. Click **Import**.
3. Specify the CA Certificate you want to import.
4. Click **OK**.

When importing is complete, you are returned to the **CA Certificate** screen, and the imported CA Certificate is displayed.

Related Information

➔ [“How to Run Web Config in a Web Browser” on page 36](#)

Deleting a CA Certificate

You can delete the imported CA Certificate.

1. Access Web Config and then select the **Network Security** tab > **CA Certificate**.
2. Click **Delete** next to the CA Certificate that you want to delete.
3. Confirm that you want to delete the certificate in the message displayed.
4. Click **Reboot Network**, and then check that the deleted CA Certificate is not listed on the updated screen.

Related Information

➔ [“How to Run Web Config in a Web Browser” on page 36](#)

SSL/TLS Communication with the Scanner

When the server certificate is set using SSL/TLS (Secure Sockets Layer/Transport Layer Security) communication to the scanner, you can encrypt the communication path between computers. Do this if you want to prevent remote and unauthorized access.

Configuring Basic SSL/TLS Settings

If the scanner supports the HTTPS server feature, you can use an SSL/TLS communication to encrypt communications. You can configure and manage the scanner using Web Config while ensuring security.

Configure encryption strength and redirect feature.

1. Access Web Config and select the **Network Security** tab > **SSL/TLS** > **Basic**.

2. Select a value for each item.
 - Encryption Strength
Select the level of encryption strength.
 - Redirect HTTP to HTTPS
Redirect to HTTPS when HTTP is accessed.
3. Click **Next**.
A confirmation message is displayed.
4. Click **OK**.
The scanner is updated.

Related Information

➔ [“How to Run Web Config in a Web Browser” on page 36](#)

Configuring a Server Certificate for the Scanner

1. Access Web Config and select the **Network Security** tab > **SSL/TLS** > **Certificate**.
2. Specify a certificate to use on **Server Certificate**.
 - Self-signed Certificate
A self-signed certificate has been generated by the scanner. If you do not obtain a CA-signed certificate, select this.
 - CA-signed Certificate
If you obtain and import a CA-signed certificate in advance, you can specify this.
3. Click **Next**.
A confirmation message is displayed.
4. Click **OK**.
The scanner is updated.

Related Information

➔ [“How to Run Web Config in a Web Browser” on page 36](#)

Encrypted Communication Using IPsec/IP Filtering

About IPsec/IP Filtering

You can filter traffic based on IP addresses, services, and port by using IPsec/IP Filtering function. By combining of the filtering, you can configure the scanner to accept or block specified clients and specified data. Additionally, you can improve security level by using an IPsec.

Note:

Computers that run Windows Vista or later or Windows Server 2008 or later support IPsec.

Configuring Default Policy

To filter traffic, configure the default policy. The default policy applies to every user or group connecting to the scanner. For more fine-grained control over users and groups of users, configure group policies.

1. Access Web Config and then select the **Network Security** tab > **IPsec/IP Filtering** > **Basic**.
2. Enter a value for each item.
3. Click **Next**.
A confirmation message is displayed.
4. Click **OK**.
The scanner is updated.

Related Information

➔ [“How to Run Web Config in a Web Browser”](#) on page 36

Default Policy Setting Items

Default Policy

Items	Settings and Explanation
IPsec/IP Filtering	You can enable or disable an IPsec/IP Filtering feature.

Access Control

Configure a control method for traffic of IP packets.

Items	Settings and Explanation
Permit Access	Select this to permit configured IP packets to pass through.
Refuse Access	Select this to refuse configured IP packets to pass through.
IPsec	Select this to permit configured IPsec packets to pass through.

IKE Version

Select **IKEv1** or **IKEv2** for **IKE Version**. Select one of them according to the device that the scanner is connected to.

IKEv1

The following items are displayed when you select **IKEv1** for **IKE Version**.

Items	Settings and Explanation
Authentication Method	To select Certificate , you need to obtain and import a CA-signed certificate in advance.
Pre-Shared Key	If you select Pre-Shared Key for Authentication Method , enter a pre-shared key between 1 and 127 characters.
Confirm Pre-Shared Key	Enter the key you configured for confirmation.

IKEv2

The following items are displayed when you select **IKEv2** for **IKE Version**.

Items	Settings and Explanation	
Local	Authentication Method	To select Certificate , you need to obtain and import a CA-signed certificate in advance.
	ID Type	If you select Pre-Shared Key for Authentication Method , select the type of ID for the scanner.
	ID	Enter the scanner's ID that matches the type of ID. You cannot use "@", "#", and "=" for the first character. Distinguished Name : Enter 1 to 255 1-byte ASCII (0x20 to 0x7E) characters. You need to include "=". IP Address : Enter IPv4 or IPv6 format. FQDN : Enter a combination of between 1 and 255 characters using A-Z, a-z, 0-9, "-", and period (.). Email Address : Enter 1 to 255 1-byte ASCII (0x20 to 0x7E) characters. You need to include "@". Key ID : Enter 1 to 255 1-byte ASCII (0x20 to 0x7E) characters.
	Pre-Shared Key	If you select Pre-Shared Key for Authentication Method , enter a pre-shared key between 1 and 127 characters.
	Confirm Pre-Shared Key	Enter the key you configured for confirmation.

Items		Settings and Explanation
Remote	Authentication Method	To select Certificate , you need to obtain and import a CA-signed certificate in advance.
	ID Type	If you select Pre-Shared Key for Authentication Method , select the type of ID for the device that you want to authenticate.
	ID	Enter the scanner's ID that matches to the type of ID. You cannot use "@", "#", and "=" for the first character. Distinguished Name : Enter 1 to 255 1-byte ASCII (0x20 to 0x7E) characters. You need to include "=". IP Address : Enter IPv4 or IPv6 format. FQDN : Enter a combination of between 1 and 255 characters using A-Z, a-z, 0-9, "-", and period (.). Email Address : Enter 1 to 255 1-byte ASCII (0x20 to 0x7E) characters. You need to include "@". Key ID : Enter 1 to 255 1-byte ASCII (0x20 to 0x7E) characters.
	Pre-Shared Key	If you select Pre-Shared Key for Authentication Method , enter a pre-shared key between 1 and 127 characters.
	Confirm Pre-Shared Key	Enter the key you configured for confirmation.

Encapsulation

If you select **IPsec** for **Access Control**, you need to configure an encapsulation mode.

Items	Settings and Explanation
Transport Mode	If you only use the scanner on the same LAN, select this. IP packets of layer 4 or later are encrypted.
Tunnel Mode	If you use the scanner on the Internet-capable network such as IPsec-VPN, select this option. The header and data of the IP packets are encrypted. Remote Gateway(Tunnel Mode) : If you select Tunnel Mode for Encapsulation , enter a gateway address between 1 and 39 characters.

Security Protocol

If you select **IPsec** for **Access Control**, select an option.

Items	Settings and Explanation
ESP	Select this to ensure the integrity of an authentication and data, and encrypt data.
AH	Select this to ensure the integrity of an authentication and data. Even if encrypting data is prohibited, you can use IPsec.

Algorithm Settings

It is recommended that you select **Any** for all settings or select an item other than **Any** for each setting. If you select **Any** for some of the settings and select an item other than **Any** for the other settings, the device may not communicate depending on the other device that you want to authenticate.

Items		Settings and Explanation
IKE	Encryption	Select the encryption algorithm for IKE. The items vary depending on the version of IKE.
	Authentication	Select the authentication algorithm for IKE.
	Key Exchange	Select the key exchange algorithm for IKE. The items vary depending on the version of IKE.
ESP	Encryption	Select the encryption algorithm for ESP. This is available when ESP is selected for Security Protocol .
	Authentication	Select the authentication algorithm for ESP. This is available when ESP is selected for Security Protocol .
AH	Authentication	Select the encryption algorithm for AH. This is available when AH is selected for Security Protocol .

Configuring Group Policy

A group policy is one or more rules applied to a user or user group. The scanner controls IP packets that match with configured policies. IP packets are authenticated in the order of a group policy 1 to 10 then a default policy.

1. Access Web Config and then select the **Network Security** tab > **IPsec/IP Filtering** > **Basic**.
2. Click a numbered tab you want to configure.
3. Enter a value for each item.
4. Click **Next**.
A confirmation message is displayed.
5. Click **OK**.
The scanner is updated.

Group Policy Setting Items

Items	Settings and Explanation
Enable this Group Policy	You can enable or disable a group policy.

Access Control

Configure a control method for traffic of IP packets.

Items	Settings and Explanation
Permit Access	Select this to permit configured IP packets to pass through.
Refuse Access	Select this to refuse configured IP packets to pass through.
IPsec	Select this to permit configured IPsec packets to pass through.

Local Address (Scanner)

Select an IPv4 address or IPv6 address that matches your network environment. If an IP address is assigned automatically, you can select **Use auto-obtained IPv4 address**.

Note:

If an IPv6 address is assigned automatically, the connection may be unavailable. Configure a static IPv6 address.

Remote Address(Host)

Enter a device's IP address to control access. The IP address must be 43 characters or less. If you do not enter an IP address, all addresses are controlled.

Note:

If an IP address is assigned automatically (e.g. assigned by DHCP), the connection may be unavailable. Configure a static IP address.

Method of Choosing Port

Select a method to specify ports.

- Service Name

If you select **Service Name** for **Method of Choosing Port**, select an option.

- Transport Protocol

If you select **Port Number** for **Method of Choosing Port**, you need to configure an encapsulation mode.

Items	Settings and Explanation
Any Protocol	Select this to control all protocol types.
TCP	Select this to control data for unicast.
UDP	Select this to control data for broadcast and multicast.
ICMPv4	Select this to control ping command.

- Local Port

If you select **Port Number** for **Method of Choosing Port** and if you select **TCP** or **UDP** for **Transport Protocol**, enter port numbers to control receiving packets, separating them with commas. You can enter 10 port numbers at the maximum.

Example: 20,80,119,5220

If you do not enter a port number, all ports are controlled.

- Remote Port

If you select **Port Number** for **Method of Choosing Port** and if you select **TCP** or **UDP** for **Transport Protocol**, enter port numbers to control sending packets, separating them with commas. You can enter 10 port numbers at the maximum.

Example: 25,80,143,5220

If you do not enter a port number, all ports are controlled.

IKE Version

Select **IKEv1** or **IKEv2** for **IKE Version**. Select one of them according to the device that the scanner is connected to.

IKEv1

The following items are displayed when you select **IKEv1** for **IKE Version**.

Items	Settings and Explanation
Authentication Method	If you select IPsec for Access Control , select an option. Used certificate is common with a default policy.
Pre-Shared Key	If you select Pre-Shared Key for Authentication Method , enter a pre-shared key between 1 and 127 characters.
Confirm Pre-Shared Key	Enter the key you configured for confirmation.

❑ IKEv2

The following items are displayed when you select **IKEv2** for **IKE Version**.

Items		Settings and Explanation
Local	Authentication Method	If you select IPsec for Access Control , select an option. Used certificate is common with a default policy.
	ID Type	If you select Pre-Shared Key for Authentication Method , select the type of ID for the scanner.
	ID	Enter the scanner's ID that matches the type of ID. You cannot use "@", "#", and "=" for the first character. Distinguished Name : Enter 1 to 255 1-byte ASCII (0x20 to 0x7E) characters. You need to include "=". IP Address : Enter IPv4 or IPv6 format. FQDN : Enter a combination of between 1 and 255 characters using A-Z, a-z, 0-9, "-", and period (.). Email Address : Enter 1 to 255 1-byte ASCII (0x20 to 0x7E) characters. You need to include "@". Key ID : Enter 1 to 255 1-byte ASCII (0x20 to 0x7E) characters.
	Pre-Shared Key	If you select Pre-Shared Key for Authentication Method , enter a pre-shared key between 1 and 127 characters.
	Confirm Pre-Shared Key	Enter the key you configured for confirmation.
Remote	Authentication Method	If you select IPsec for Access Control , select an option. Used certificate is common with a default policy.
	ID Type	If you select Pre-Shared Key for Authentication Method , select the type of ID for the device that you want to authenticate.
	ID	Enter the scanner's ID that matches to the type of ID. You cannot use "@", "#", and "=" for the first character. Distinguished Name : Enter 1 to 255 1-byte ASCII (0x20 to 0x7E) characters. You need to include "=". IP Address : Enter IPv4 or IPv6 format. FQDN : Enter a combination of between 1 and 255 characters using A-Z, a-z, 0-9, "-", and period (.). Email Address : Enter 1 to 255 1-byte ASCII (0x20 to 0x7E) characters. You need to include "@". Key ID : Enter 1 to 255 1-byte ASCII (0x20 to 0x7E) characters.
	Pre-Shared Key	If you select Pre-Shared Key for Authentication Method , enter a pre-shared key between 1 and 127 characters.
	Confirm Pre-Shared Key	Enter the key you configured for confirmation.

Encapsulation

If you select **IPsec** for **Access Control**, you need to configure an encapsulation mode.

Items	Settings and Explanation
Transport Mode	If you only use the scanner on the same LAN, select this. IP packets of layer 4 or later are encrypted.
Tunnel Mode	If you use the scanner on the Internet-capable network such as IPsec-VPN, select this option. The header and data of the IP packets are encrypted. Remote Gateway(Tunnel Mode): If you select Tunnel Mode for Encapsulation , enter a gateway address between 1 and 39 characters.

Security Protocol

If you select **IPsec** for **Access Control**, select an option.

Items	Settings and Explanation
ESP	Select this to ensure the integrity of an authentication and data, and encrypt data.
AH	Select this to ensure the integrity of an authentication and data. Even if encrypting data is prohibited, you can use IPsec.

Algorithm Settings

It is recommended that you select **Any** for all settings or select an item other than **Any** for each setting. If you select **Any** for some of the settings and select an item other than **Any** for the other settings, the device may not communicate depending on the other device that you want to authenticate.

Items	Settings and Explanation
IKE	Encryption Select the encryption algorithm for IKE. The items vary depending on the version of IKE.
	Authentication Select the authentication algorithm for IKE.
	Key Exchange Select the key exchange algorithm for IKE. The items vary depending on the version of IKE.
ESP	Encryption Select the encryption algorithm for ESP. This is available when ESP is selected for Security Protocol .
	Authentication Select the authentication algorithm for ESP. This is available when ESP is selected for Security Protocol .
AH	Authentication Select the encryption algorithm for AH. This is available when AH is selected for Security Protocol .

Combination of Local Address (Scanner) and Remote Address(Host) on Group Policy

	Setting of Local Address (Scanner)		
	IPv4	IPv6* ²	Any addresses* ³

Setting of Remote Address(Host)	IPv4* ¹	✓	–	✓
	IPv6* ^{1&2}	–	✓	✓
	Blank	✓	✓	✓

*1If **IPsec** is selected for **Access Control**, you cannot specify in a prefix length.

*2If **IPsec** is selected for **Access Control**, you can select a link-local address (fe80::) but group policy will be disabled.

*3Except IPv6 link local addresses.

Related Information

➔ [“How to Run Web Config in a Web Browser” on page 36](#)

References of Service Name on Group Policy

Note:

Unavailable services are displayed but cannot be selected.

Service Name	Protocol type	Local port number	Remote port number	Features controlled
Any	–	–	–	All services
ENPC	UDP	3289	Any port	Searching for a scanner from applications such as Epson Device Admin and the a scanner driver
SNMP	UDP	161	Any port	Acquiring and configuring of MIB from applications such as Epson Device Admin and the Epson scanner driver
WSD	TCP	Any port	5357	Controlling WSD
WS-Discovery	UDP	3702	Any port	Searching for a scanner from WSD
Network Scan	TCP	1865	Any port	Forwarding scan data from Epson ScanSmart
Network Push Scan Discovery	UDP	2968	Any port	Searching for a computer from scanner
Network Push Scan	TCP	Any port	2968	Acquiring job information of push scanning from Epson ScanSmart
HTTP (Local)	TCP	80	Any port	HTTP(S) server (forwarding data of Web Config and WSD)
HTTPS (Local)	TCP	443	Any port	
HTTP (Remote)	TCP	Any port	80	HTTP(S) client (firmware updating and root certificate updating)
HTTPS (Remote)	TCP	Any port	443	

Configuration Examples of IPsec/IP Filtering

Receiving IPsec packets only

This example is to configure a default policy only.

Default Policy:

- IPsec/IP Filtering: Enable**
- Access Control: IPsec**
- Authentication Method: Pre-Shared Key**
- Pre-Shared Key:** Enter up to 127 characters.

Group Policy: Do not configure.

Receiving scanning data and scanner settings

This example allows communications of scanning data and scanner configuration from specified services.

Default Policy:

- IPsec/IP Filtering: Enable**
- Access Control: Refuse Access**

Group Policy:

- Enable this Group Policy:** Check the box.
- Access Control: Permit Access**
- Remote Address(Host):** IP address of a client
- Method of Choosing Port: Service Name**
- Service Name:** Check the box of ENPC, SNMP, HTTP (Local), HTTPS (Local) and Network Scan.

Receiving access from a specified IP address only

This example allows a specified IP address to access the scanner.

Default Policy:

- IPsec/IP Filtering: Enable**
- Access Control: Refuse Access**

Group Policy:

- Enable this Group Policy:** Check the box.
- Access Control: Permit Access**
- Remote Address(Host):** IP address of an administrator's client

Note:

Regardless of policy configuration, the client will be able to access and configure the scanner.

Configuring a Certificate for IPsec/IP Filtering

Configure the Client Certificate for IPsec/IP Filtering. When you set it, you can use the certificate as an authentication method for IPsec/IP Filtering. If you want to configure the certification authority, go to **CA Certificate**.

1. Access Web Config and then select the **Network Security** tab > **IPsec/IP Filtering** > **Client Certificate**.
2. Import the certificate in **Client Certificate**.

If you have already imported a certificate published by a Certification Authority, you can copy the certificate and use it in IPsec/IP Filtering. To copy, select the certificate from **Copy From**, and then click **Copy**.

Related Information

➔ [“How to Run Web Config in a Web Browser” on page 36](#)

Connecting the Scanner to an IEEE802.1X Network

Configuring an IEEE802.1X Network

When you set IEEE802.1X to the scanner, you can use it on the network connected to a RADIUS server, a LAN switch with authentication function, or an access point.

1. Access Web Config and then select the **Network Security** tab > **IEEE802.1X** > **Basic**.

2. Enter a value for each item.

If you want to use the scanner on a Wi-Fi network, click **Wi-Fi Setup** and select or enter an SSID.

3. Click **Next**.

A confirmation message is displayed.

4. Click **OK**.

The scanner is updated.

IEEE802.1X Network Setting Items

Items	Settings and Explanation	
IEEE802.1X (Wi-Fi)	The connection status of IEEE802.1X (Wi-Fi) is displayed.	
Connection Method	The connection method of a current network is displayed.	
EAP Type	Select an option for an authentication method between the scanner and a RADIUS server.	
	EAP-TLS	You need to obtain and import a CA-signed certificate.
	PEAP-TLS	
	PEAP/MSCHAPv2	You need to configure a password.
EAP-TTLS		

Items	Settings and Explanation	
User ID	Configure an ID to use for an authentication of a RADIUS server. Enter 1 to 128 1-byte ASCII (0x20 to 0x7E) characters.	
Password	Configure a password to authenticate the scanner. Enter 1 to 128 1-byte ASCII (0x20 to 0x7E) characters. If you are using a Windows server as a RADIUS server, you can enter up to 127 characters.	
Confirm Password	Enter the password you configured for confirmation.	
Server ID	You can configure a server ID to authenticate with a specified RADIUS server. Authenticator verifies whether a server ID is contained in the subject/subjectAltName field of a server certificate that is sent from a RADIUS server or not. Enter 0 to 128 1-byte ASCII (0x20 to 0x7E) characters.	
Certificate Validation	You can set certificate validation regardless of the authentication method. Import the certificate in CA Certificate .	
Anonymous Name	If you select PEAP-TLS or PEAP/MSCHAPv2 for EAP Type , you can configure an anonymous name instead of a user ID for a phase 1 of a PEAP authentication. Enter 0 to 128 1-byte ASCII (0x20 to 0x7E) characters.	
Encryption Strength	You can select one of the followings.	
	High	AES256/3DES
	Middle	AES256/3DES/AES128/RC4

Configuring a Certificate for IEEE802.1X

Configure the Client Certificate for IEEE802.1X. When you set it, you can use **EAP-TLS** and **PEAP-TLS** as an authentication method of IEEE802.1x. If you want to configure the certification authority certificate, go to **CA Certificate**.

1. Access Web Config and then select the **Network Security** tab > **IEEE802.1X** > **Client Certificate**.
2. Enter a certificate in the **Client Certificate**.

If you have already imported a certificate published by a Certification Authority, you can copy the certificate and use it in IEEE802.1X. To copy, select the certificate from **Copy From**, and then click **Copy**.

Solving Problems for Advanced Security

Hints to Solving Problems

- Checking the error message

When trouble has occurred, first check whether there are any messages on the scanner's control panel or driver screen. If you have the notification email set when the events occur, you can promptly learn the status.

- Checking the communication status

Check the communication status of server computer or client computer by using the command such as ping and ipconfig.

Connection test

For checking the connection between the scanner to the mail server, perform the connection test from the scanner. Also, check the connection from the client computer to the server to check the communication status.

Initializing the settings

If the settings and communication status show no problem, the problems may be solved by disabling or initializing the network settings of the scanner, and then setting up again.

Related Information

- ➔ [“Registering an Email Server” on page 146](#)
- ➔ [“Checking Error Messages on the Control Panel” on page 196](#)
- ➔ [“Receiving Email Notifications When Events Occur” on page 247](#)

Cannot Access Web Config

■ The IP address is not assigned to the scanner.

Solutions

A valid IP address may not be assigned to the scanner. Configure the IP address using the scanner's control panel. You can confirm the current setting information from the scanner's control panel.

- ➔ [“Assigning the IP Address” on page 238](#)

■ Web browser does not support the Encryption Strength for SSL/TLS.

Solutions

SSL/TLS has the Encryption Strength. You can open Web Config by using a web browser that supports bulk encryptions as indicated below. Check you are using the a supported browser.

- 80bit: AES256/AES128/3DES
- 112bit: AES256/AES128/3DES
- 128bit: AES256/AES128
- 192bit: AES256
- 256bit: AES256

■ CA-signed Certificate is expired.

Solutions

If there is a problem with the expiration date of the certificate, "The certificate has expired" is displayed when connecting to Web Config with SSL/TLS communication (https). If the message appears before its expiration date, make sure that the scanner's date is configured correctly.

■ The common name of the certificate and the scanner do not match.

Solutions

If the common name of the certificate and the scanner do not match, the message "The name of the security certificate does not match..." is displayed when accessing Web Config using SSL/TLS communication (https). This happens because the following IP addresses do not match.

- The scanner's IP address entered to common name for creating a Self-signed Certificate or CSR

- IP address entered to web browser when running Web Config

For Self-signed Certificate, update the certificate.

For CA-signed Certificate, take the certificate again for the scanner.

■ **The proxy server setting of local address is not set to web browser.**

Solutions

When the scanner is set to use a proxy server, configure the web browser not to connect to the local address via the proxy server.

- Windows :

Select **Control Panel > Network and Internet > Internet Options > Connections > LAN settings > Proxy server**, and then configure not to use the proxy server for LAN (local addresses).

- Mac OS :

Select **System Preferences > Network > Advanced > Proxies**, and then register the local address for **Bypass proxy settings for these Hosts & Domains**.

Example:

192.168.1.*: Local address 192.168.1.XXX, subnet mask 255.255.255.0

192.168.*.*: Local address 192.168.XXX.XXX, subnet mask 255.255.0.0

Restoring the Security Settings

When you establish a highly secure environment such as IPsec/IP Filtering or IEEE802.1X, you may not be able to communicate with devices because of incorrect settings or trouble with the device or server. In this case, restore the security settings in order to make settings for the device again or to allow you temporary use.

Disabling the Security Function Using Web Config

You can disable IPsec/IP Filtering using Web Config.

1. Access Web Config and select the **Network Security** tab > **IPsec/IP Filtering** > **Basic**.
2. Disable the **IPsec/IP Filtering**.

Problems Using Network Security Features

Forgot a Pre-shared Key

Re-configure a pre-shared key.

To change the key, access Web Config and select the **Network Security** tab > **IPsec/IP Filtering** > **Basic** > **Default Policy** or **Group Policy**.

When you change the pre-shared key, configure the pre-shared key for computers.

Cannot Communicate with IPsec Communication

Specify the algorithm that the scanner or the computer does not support.

The scanner supports the following algorithms. Check the settings of the computer.

Security Methods	Algorithms
IKE encryption algorithm	AES-CBC-128, AES-CBC-192, AES-CBC-256, AES-GCM-128*, AES-GCM-192*, AES-GCM-256*, 3DES
IKE authentication algorithm	SHA-1, SHA-256, SHA-384, SHA-512, MD5
IKE key exchange algorithm	DH Group1, DH Group2, DH Group5, DH Group14, DH Group15, DH Group16, DH Group17, DH Group18, DH Group19, DH Group20, DH Group21, DH Group22, DH Group23, DH Group24, DH Group25, DH Group26, DH Group27*, DH Group28*, DH Group29*, DH Group30*
ESP encryption algorithm	AES-CBC-128, AES-CBC-192, AES-CBC-256, AES-GCM-128, AES-GCM-192, AES-GCM-256, 3DES
ESP authentication algorithm	SHA-1, SHA-256, SHA-384, SHA-512, MD5
AH authentication algorithm	SHA-1, SHA-256, SHA-384, SHA-512, MD5

*available for IKEv2 only

Cannot Communicate Suddenly

There is an error in the certificate.

The scanner's date and time settings may be incorrect if power has not been supplied to the scanner for a long time.

When the scanner is connected using a client certificate for IPsec/IP filtering or IEEE802.1X, an error is indicated if a time lag occurs between the scanner's date and time and the validity period for the certificate. Because the scanner recognizes that the certificate is unavailable.

You can solve this problem by correcting the scanner's date and time settings. Connect the scanner and the computer using a USB cable, turn the scanner on, and then perform scanning over USB using Epson Scan 2. The scanner is synchronized with the computer and the date and time settings are corrected. The scanner indicates normal status.

If you cannot solve the problem, restore all network settings using the scanner's control panel. Connect the scanner and computer, make the network settings again, and then make the settings for client certification, IPsec/IP filtering, or IEEE802.1X.

The IP address of the scanner has been changed or cannot be used.

When the IP address registered to the local address on Group Policy has been changed or cannot be used, IPsec communication cannot be performed.

Disable IPsec using the scanner's control panel.

If the DHCP is out of date, rebooting or the IPv6 address is out of date or has not been obtained, then the IP address registered for the scanner's Web Config (**Network Security** tab > **IPsec/IP Filtering** > **Basic** > **Group Policy** > **Local Address (Scanner)**) may not be found.

Use a static IP address.

The IP address of the computer has been changed or cannot be used.

When the IP address registered to the remote address on Group Policy has been changed or cannot be used, IPsec communication cannot be performed.

Disable IPsec using the scanner's control panel.

If the DHCP is out of date, rebooting or the IPv6 address is out of date or has not been obtained, then the IP address registered for the scanner's Web Config (**Network Security** tab > **IPsec/IP Filtering** > **Basic** > **Group Policy** > **Remote Address(Host)**) may not be found.

Use a static IP address.

Cannot Connect After Configuring IPsec/IP Filtering

The set value may be incorrect.

Access the scanner according to its MAC address using EpsonNet Config or Epson Device Admin from another computer, such as administrator's. You can find the MAC address on the label pasted on the scanner.

If you can access, make the IPsec/IP filtering settings using EpsonNet Config or Epson Device Admin.

If you cannot access, restore all network settings using the scanner's control panel. Connect the scanner and computer, make the network settings again, and then make the IPsec/IP filtering settings.

Cannot Access the Device after Configuring IEEE802.1X

The settings of IEEE802.1X are incorrect.

Disable IEEE802.1X and Wi-Fi from the scanner's control panel. Connect the scanner and a computer, and then configure IEEE802.1X again.

Problems on Using a Digital Certificate

Cannot Import a CA-signed Certificate

CA-signed Certificate and the information on the CSR do not match.

If the CA-signed Certificate and CSR do not have the same information, the CSR cannot be imported. Check the following:

- Are you trying to import the certificate to a device that does not have the same information?
Check the information of the CSR and then import the certificate to a device that has the same information.
- Did you overwrite the CSR saved into the scanner after sending the CSR to a certificate authority?
Obtain the CA-signed certificate again with the CSR.

CA-signed Certificate is more than 5KB.

You cannot import a CA-signed Certificate that is more than 5KB.

The password for importing the certificate is incorrect.

Enter the correct password. If you forget the password, you cannot import the certificate. Re-obtain the CA-signed Certificate.

Cannot Update a Self-Signed Certificate

The Common Name has not been entered.

Common Name must be entered.

Unsupported characters have been entered to Common Name.

Enter between 1 and 128 characters of either IPv4, IPv6, host name, or FQDN format in ASCII (0x20-0x7E).

A comma or space is included in the common name.

If a comma is entered, the Common Name is divided at that point. If only a space is entered before or after a comma, an error occurs.

Cannot Create a CSR

The Common Name has not been entered.

The Common Name must be entered.

Unsupported characters have been entered to Common Name, Organization, Organizational Unit, Locality, and State/Province.

Enter characters of either IPv4, IPv6, host name, or FQDN format in ASCII (0x20-0x7E).

A comma or space is included in the Common Name.

If a comma is entered, the Common Name is divided at that point. If only a space is entered before or after a comma, an error occurs.

Warning Relating to a Digital Certificate Appears

Messages	Cause/What to do
Enter a Server Certificate.	<p>Cause: You have not selected a file to import.</p> <p>What to do: Select a file and click Import.</p>
CA Certificate 1 is not entered.	<p>Cause: CA certificate 1 is not entered and only CA certificate 2 is entered.</p> <p>What to do: Import CA certificate 1 first.</p>
Invalid value below.	<p>Cause: Unsupported characters are contained in the file path and/or password.</p> <p>What to do: Make sure that the characters are entered correctly for the item.</p>

Messages	Cause/What to do
Invalid date and time.	<p>Cause: Date and time for the scanner have not been set.</p> <p>What to do: Set date and time using Web Config or EpsonNet Config.</p>
Invalid password.	<p>Cause: The password set for CA certificate and entered password do not match.</p> <p>What to do: Enter the correct password.</p>
Invalid file.	<p>Cause: You are not importing a certificate file in X509 format.</p> <p>What to do: Make sure that you are selecting the correct certificate sent by a trusted certificate authority.</p>
	<p>Cause: The file you have imported is too large. The maximum file size is 5KB.</p> <p>What to do: If you select the correct file, the certificate might be corrupted or fabricated.</p>
	<p>Cause: The chain contained in the certificate is invalid.</p> <p>What to do: For more information on the certificate, see the website of the certificate authority.</p>
Cannot use the Server Certificates that include more than three CA certificates.	<p>Cause: The certificate file in PKCS#12 format contains more than 3 CA certificates.</p> <p>What to do: Import each certificate as converting from PKCS#12 format to PEM format, or import the certificate file in PKCS#12 format that contains up to 2 CA certificates.</p>
The certificate has expired. Check if the certificate is valid, or check the date and time on the product.	<p>Cause: The certificate is out of date.</p> <p>What to do:</p> <ul style="list-style-type: none"> <input type="checkbox"/> If the certificate is out of date, obtain and import the new certificate. <input type="checkbox"/> If the certificate is not out of date, make sure the scanner's date and time are set correctly.

Messages	Cause/What to do
Private key is required.	<p>Cause: There is no paired private key with the certificate.</p> <p>What to do:</p> <ul style="list-style-type: none"> <input type="checkbox"/> If the certificate is the PEM/DER format and it is obtained from a CSR using a computer, specify the private key file. <input type="checkbox"/> If the certificate is the PKCS#12 format and it is obtained from a CSR using a computer, create a file that contains the private key. <hr/> <p>Cause: You have re-imported the PEM/DER certificate obtained from a CSR using Web Config.</p> <p>What to do: If the certificate is the PEM/DER format and it is obtained from a CSR using Web Config, you can only import it once.</p>
Setup failed.	<p>Cause: Cannot finish the configuration because the communication between the scanner and computer failed or the file cannot be read by some errors.</p> <p>What to do: After checking the specified file and communication, import the file again.</p>

Delete a CA-signed Certificate by Mistake

There is no backup file for the CA-signed certificate.

If you have the backup file, import the certificate again.

If you obtain a certificate using a CSR created from Web Config, you cannot import a deleted certificate again. Create a CSR and obtain a new certificate.

Technical Specifications

General Scanner Specifications.	280
Network Specifications.	281
Supported Third Party Services.	282
USB Drive Specifications.	283
Using Port for the Scanner.	283
Dimensions and Weight Specifications.	284
Electrical Specifications.	285
Environmental Specifications.	286
System Requirements.	286

General Scanner Specifications

Note:

Specifications are subject to change without notice.

Scanner type	Sheet Feed, one pass duplex color scanner
Photoelectric device	CIS
Effective pixels	5,100×9,300 at 600 dpi 2,550×64,500 at 300 dpi
Light source	RGB LED
Scanning resolution	600 dpi (main scan) 600 dpi (sub scan)
Output resolution	50 to 1200 dpi (in 1 dpi increments) *1
Document Size	Max: 215.9×5,588 (8.5×220 inches) *2 Min: 50.8×50.8 mm (2×2 inches)
Paper input	Face-up loading
Paper output	Vertical path position: Face-down ejection Straight path position: Face-up ejection
Paper capacity	20 sheets of paper at 80 g/m ²
Color Depth	Color <input type="checkbox"/> 30 bits per pixel internal (10 bits per pixel per color internal) <input type="checkbox"/> 24 bits per pixel external (8 bits per pixel per color external) Grayscale <input type="checkbox"/> 10 bits per pixel internal <input type="checkbox"/> 8 bits per pixel external Black and white <input type="checkbox"/> 10 bits per pixel internal <input type="checkbox"/> 1 bit per pixel external
Interface	Hi-Speed USB

*1 This value is when scanning with a computer. Available resolutions may vary depending on the scanning method.

*2 Maximum length may vary depending on the scanning method and the resolution. See the following for more details.

[“Maximum Length for Long Paper” on page 46](#)

Network Specifications

Wi-Fi Specifications

See the following table for Wi-Fi specifications.

Countries or regions except for those listed below	Table A
Australia New Zealand	Table B

Table A

Standards	IEEE802.11b/g/n ^{*1}
Frequency Range	2400-2483.5 MHz
Maximum Radio-Frequency Power Transmitted	20 dBm (EIRP)
Channels	1/2/3/4/5/6/7/8/9/10/11/12/13
Connection Modes	Infrastructure, Wi-Fi Direct (Simple AP) ^{*2*3}
Security Protocols ^{*4}	WEP (64/128bit), WPA2-PSK (AES) ^{*5} , WPA3-SAE (AES), WPA2/WPA3-Enterprise

*1 Only available for the HT20

*2 Not supported for IEEE 802.11b

*3 Infrastructure and Wi-Fi Direct modes can be used simultaneously.

*4 Wi-Fi Direct supports WPA2-PSK (AES) only.

*5 Complies with WPA2 standards with support for WPA/WPA2 Personal.

Table B

Standards	IEEE802.11a/b/g/n ^{*1} /ac		
Frequency Ranges	IEEE802.11b/g/n: 2.4 GHz, IEEE802.11a/n/ac: 5 GHz		
Channels	Wi-Fi	2.4 GHz	1/2/3/4/5/6/7/8/9/10/11/12 ^{*2} /13 ^{*2}
		5 GHz ^{*3}	W52 (36/40/44/48), W53 (52/56/60/64), W56 (100/104/108/112/116/120/124/128/132/136/140/144), W58 (149/153/157/161/165)
	Wi-Fi Direct	2.4 GHz	1/2/3/4/5/6/7/8/9/10/11/12 ^{*2} /13 ^{*2}
		5 GHz ^{*3}	W52 (36/40/44/48) W58 (149/153/157/161/165)

Connection Modes	Infrastructure, Wi-Fi Direct (Simple AP) *4*5
Security Protocols*6	WEP (64/128bit), WPA2-PSK (AES)*7, WPA3-SAE (AES), WPA2/WPA3-Enterprise

- *1 Only available for the HT20
- *2 Not available in Taiwan
- *3 The availability of these channels and use of the product outdoors over these channels varies by location. For more information, see <http://support.epson.net/wifi5ghz/>
- *4 Not supported for IEEE 802.11b
- *5 Infrastructure and Wi-Fi Direct modes can be used simultaneously.
- *6 Wi-Fi Direct only supports WPA2-PSK (AES) .
- *7 Complies with WPA2 standards with support for WPA/WPA2 Personal.

Network Features and IPv4/IPv6 Support

Features	Supported
Epson ScanSmart	IPv4
Epson Connect (Scan to Cloud)	IPv4
AirPrint	IPv4, IPv6

Security Protocol

IEEE802.1X*	
IPsec/IP Filtering	
SSL/TLS	HTTPS Server/Client
SMTPS (STARTTLS, SSL/TLS)	
SNMPv3	

- * You need to use a connection device that complies with IEEE802.1X.

Supported Third Party Services

AirPrint	OS X Mavericks (10.9.5) or later
----------	----------------------------------

- * We recommend using the latest Mac OS.

USB Drive Specifications

Devices	Maximum Capacities
USB Memory Device	2 TB (formatted in FAT, FAT32, or exFAT.)

You cannot use the following drives:

- A drive that requires a dedicated driver
- A drive with security settings (password, encryption, and so on)

Epson cannot guarantee all operations of externally connected drives.

Using Port for the Scanner

The scanner uses the following port. These ports should be allowed to become available by the network administrator as necessary.

When the Sender (Client) is the Scanner

Usage	Target (Server)	Protocol	Port Number	
File sending (When scan to network folder is used from the scanner)	FTP/FTPS server	FTP/FTPS (TCP)	20	
			21	
	File server	SMB (TCP)	NetBIOS (UDP)	445
				137
				138
	WebDAV server	Protocol HTTP(TCP)	Protocol HTTPS(TCP)	139
80				
Email sending (When scan to mail is used from the scanner)	SMTP server	SMTP (TCP)	25	
			SMTP SSL/TLS (TCP)	465
			SMTP STARTTLS (TCP)	587
POP before SMTP connection (When scan to mail is used from the scanner)	POP server	POP3 (TCP)	110	
When Epson Connect is used	Epson Connect Server	HTTPS	443	
		XMPP	5222	
Controlling WSD	Client computer	WSD (TCP)	5357	
Search the computer when push scanning from an application	Client computer	Network Push Scan Discovery	2968	

When the Sender (Client) is the Client Computer

Usage	Target (Server)	Protocol	Port Number
Discover the scanner from an application such as EpsonNet Config and scanner driver.	Scanner	ENPC (UDP)	3289
Collect and set up the MIB information from an application such as EpsonNet Config and scanner driver.	Scanner	SNMP (UDP)	161
Searching for WSD scanners	Scanner	WS-Discovery (UDP)	3702
Forwarding the scan data from an application	Scanner	Network Scan (TCP)	1865
Collecting the job information when push scanning from an application	Scanner	Network Push Scan	2968
Web Config	Scanner	HTTP(TCP)	80
		HTTPS(TCP)	443

Dimensions and Weight Specifications

Dimensions

Vertical path position (units: mm (inches))

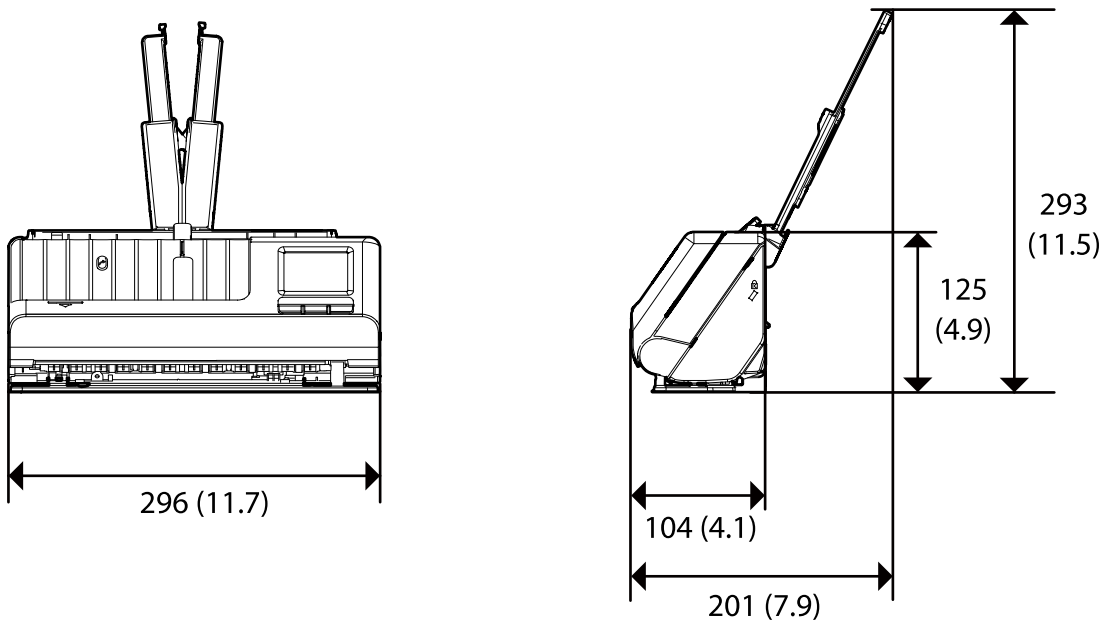

Straight path position (units: mm (inches))

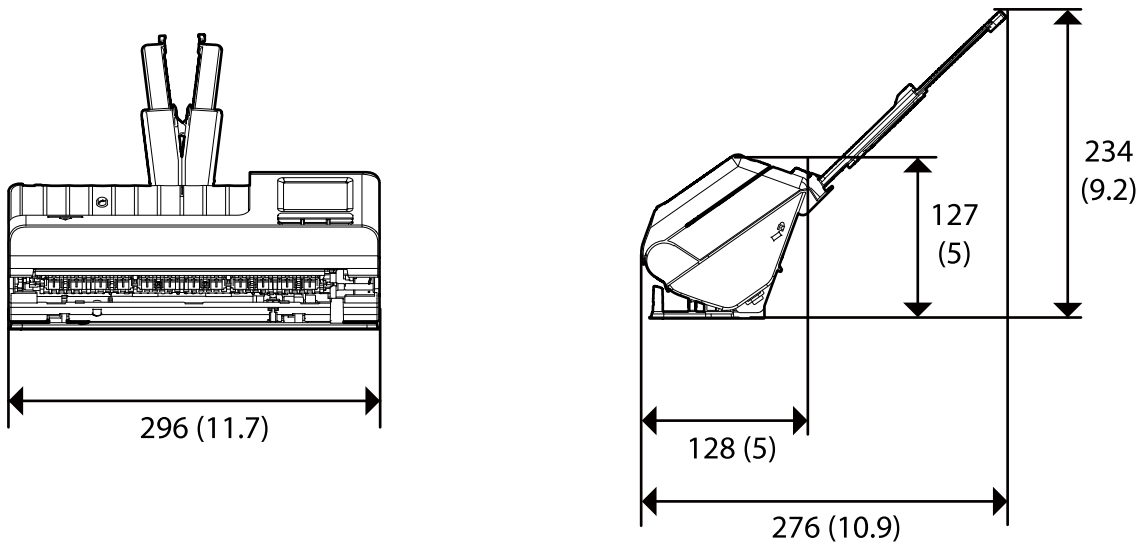

Weight

Approx. 1.9 kg (4.2 lb)

Electrical Specifications

Scanner Electrical Specifications

Rated DC Input Power Supply Voltage	DC 24 V
Rated DC Input Current	1 A
Power Consumption	<p>USB Connection</p> <ul style="list-style-type: none"> <input type="checkbox"/> Operating: Approx. 10 W <input type="checkbox"/> Ready mode: Approx. 4.0 W <input type="checkbox"/> Sleep mode : Approx. 1.0 W <input type="checkbox"/> Power off: Approx. 0.1 W <p>Wi-Fi Connection</p> <ul style="list-style-type: none"> <input type="checkbox"/> Operating: Approx. 11 W <input type="checkbox"/> Ready mode: Approx. 4.3 W <input type="checkbox"/> Sleep mode : Approx. 1.4 W <input type="checkbox"/> Power off: Approx. 0.1 W

Note:

For European users, see the following Website for details on power consumption.

<http://www.epson.eu/energy-consumption>

AC Adapter Electrical Specifications

Model	A461H (AC 100-240 V) A462E (AC 220-240 V)
Rated Input Current	1 A
Rated Frequency Range	50-60 Hz
Rated Output Power Supply Voltage	DC 24 V
Rated Output Current	1 A

Note:

For European users, see the following Website for details on power consumption.

<http://www.epson.eu/energy-consumption>

Environmental Specifications

Temperature	When operating	5 to 35 °C (41 to 95 °F)
	When stored	-25 to 60 °C (-13 to 140 °F)
Humidity	When operating	15 to 80% (without condensation)
	When stored	15 to 85% (without condensation)
Operating conditions		Ordinary office or home conditions. Avoid operating the scanner in direct sunlight, near a strong light source, or in extremely dusty conditions.

System Requirements

Supported operating systems may vary depending on the application.

Windows	Windows 11 or later Windows 10 Windows 8/8.1 Windows 7
Mac OS*1 *2	Mac OS X 10.11 or later, macOS 11 or later

*1 Fast User Switching on Mac OS or later is not supported.

*2 The UNIX File System (UFS) for Mac OS is not supported.

Standards and Approvals

Standards and Approvals for European Models.	288
Standards and Approvals for Australian Models.	288
Standards and Approvals for U.S. Models.	288

Standards and Approvals for European Models

Product and AC adapter

For European users

Hereby, Seiko Epson Corporation declares that the following radio equipment models are in compliance with Directive 2014/53/EU. The full text of the EU declaration of conformity is available at the following website.

<http://www.epson.eu/conformity>

J441D

A461H, A462E

For use only in Ireland, UK, Austria, Germany, Liechtenstein, Switzerland, France, Belgium, Luxembourg, Netherlands, Italy, Portugal, Spain, Denmark, Finland, Norway, Sweden, Iceland, Croatia, Cyprus, Greece, Slovenia, Malta, Bulgaria, Czech, Estonia, Hungary, Latvia, Lithuania, Poland, Romania, and Slovakia.

Epson cannot accept responsibility for any failure to satisfy the protection requirements resulting from a non-recommended modification of the product.



Standards and Approvals for Australian Models

Product

EMC	AS/NZS CISPR32 Class B
-----	------------------------

Epson hereby declares that the following equipment Models are in compliance with the essential requirements and other relevant provisions of AS/NZS4268:

J441C

Epson cannot accept responsibility for any failure to satisfy the protection requirements resulting from a non-recommended modification of the product.

AC adapter (A461H)

EMC	AS/NZS CISPR32 Class B
-----	------------------------

Standards and Approvals for U.S. Models

Product

EMC	FCC Part 15 Subpart B Class B CAN ICES-3 (B)/NMB-3 (B)
-----	---

This equipment contains the following wireless module.

Manufacturer: Seiko Epson Corporation

Type: J26H005

This product conforms to Part 15 of the FCC Rules and RSS-210 of the IC Rules. Epson cannot accept responsibility for any failure to satisfy the protection requirements resulting from a non-recommended modification of the product. Operation is subject to the following two conditions: (1) this device may not cause harmful interference, and (2) this device must accept any interference received, including interference that may cause undesired operation of the device.

To prevent radio interference to the licensed service, this device is intended to be operated indoors and away from windows to provide maximum shielding. Equipment (or its transmit antenna) that is installed outdoors is subject to licensing.

This equipment complies with FCC/IC radiation exposure limits set forth for an uncontrolled environment and meets the FCC radio frequency (RF) Exposure Guidelines in Supplement C to OET65 and RSS-102 of the IC radio frequency (RF) Exposure rules. This equipment should be installed and operated so that the radiator is kept at least 7.9 inches (20 cm) or more away from a person's body (excluding extremities: hands, wrists, feet and ankles).

AC adapter (A461H)

EMC	FCC Part 15 Subpart B Class B CAN ICES-3 (B)/NMB-3 (B)
-----	---

Where to Get Help

Technical Support Web Site.	291
Contacting Epson Support.	291

Technical Support Web Site

If you need further help, visit the Epson support website shown below. Select your country or region and go to the support section of your local Epson website. The latest drivers, FAQs, manuals, or other downloadables are also available from the site.

<http://support.epson.net/>

<http://www.epson.eu/support> (Europe)

If your Epson product is not operating properly and you cannot solve the problem, contact Epson support services for assistance.

Contacting Epson Support

Before Contacting Epson

If your Epson product is not operating properly and you cannot solve the problem using the troubleshooting information in your product manuals, contact Epson support services for assistance. If Epson support for your area is not listed below, contact the dealer where you purchased your product.

Epson support will be able to help you much more quickly if you give them the following information:

- Product serial number
(The serial number label is usually on the back of the product.)
- Product model
- Product software version
(Click **About**, **Version Info**, or a similar button in the product software.)
- Brand and model of your computer
- Your computer operating system name and version
- Names and versions of the software applications you normally use with your product

Note:

Depending on the product, the dial list data for fax and/or network settings may be stored in the product's memory. Due to breakdown or repair of a product, data and/or settings may be lost. Epson shall not be responsible for the loss of any data, for backing up or recovering data and/or settings even during a warranty period. We recommend that you make your own backup data or take notes.

Help for Users in Europe

Check your Pan-European Warranty Document for information on how to contact Epson support.

Help for Users in Taiwan

Contacts for information, support, and services are:

World Wide Web

<http://www.epson.com.tw>

Information on product specifications, drivers for download, and products enquiry are available.

Epson HelpDesk

Phone: +886-2-2165-3138

Our HelpDesk team can help you with the following over the phone:

- Sales enquiries and product information
- Product usage questions or problems
- Enquiries on repair service and warranty

Repair service center:

<http://www.tekcare.com.tw/branchMap.page>

TekCare corporation is an authorized service center for Epson Taiwan Technology & Trading Ltd.

Help for Users in Australia

Epson Australia wishes to provide you with a high level of customer service. In addition to your product manuals, we provide the following sources for obtaining information:

Internet URL

<http://www.epson.com.au>

Access the Epson Australia World Wide Web pages. Worth taking your modem here for the occasional surf! The site provides a download area for drivers, Epson contact points, new product information and technical support (e-mail).

Epson Helpdesk

Phone: 1300-361-054

Epson Helpdesk is provided as a final backup to make sure our clients have access to advice. Operators on the Helpdesk can aid you in installing, configuring and operating your Epson product. Our Pre-sales Helpdesk staff can provide literature on new Epson products and advise where the nearest dealer or service agent is located. Many types of queries are answered here.

We encourage you to have all the relevant information on hand when you ring. The more information you prepare, the faster we can help solve the problem. This information includes your Epson product manuals, type of computer, operating system, application programs, and any information you feel is required.

Transportation of Product

Epson recommends retaining product packaging for future transportation.

Help for Users in Singapore

Sources of information, support, and services available from Epson Singapore are:

World Wide Web

<http://www.epson.com.sg>

Information on product specifications, drivers for download, Frequently Asked Questions (FAQ), Sales Enquiries, and Technical Support via e-mail are available.

Epson HelpDesk

Toll Free: 800-120-5564

Our HelpDesk team can help you with the following over the phone:

- Sales enquiries and product information
- Product usage questions or problem troubleshooting
- Enquiries on repair service and warranty

Help for Users in Thailand

Contacts for information, support, and services are:

World Wide Web

<http://www.epson.co.th>

Information on product specifications, drivers for download, Frequently Asked Questions (FAQ), and e-mail are available.

Epson Call Centre

Phone: 66-2460-9699

Email: support@eth.epson.co.th

Our Call Centre team can help you with the following over the phone:

- Sales enquiries and product information
- Product usage questions or problems
- Enquiries on repair service and warranty

Help for Users in Vietnam

Contacts for information, support, and services are:

Epson Service Center

27 Yen Lang, Trung Liet Ward, Dong Da District, Ha Noi City. Tel: +84 24 7300 0911

38 Le Dinh Ly, Thac Gian Ward, Thanh Khe District, Da Nang. Tel: +84 23 6356 2666

194/3 Nguyen Trong Tuyen, Ward 8, Phu Nhuan Dist., HCMC. Tel: +84 28 7300 0911

31 Phan Boi Chau, Ward 14, Binh Thanh District, HCMC. Tel: +84 28 35100818

Help for Users in Indonesia

Contacts for information, support, and services are:

World Wide Web

<http://www.epson.co.id>

- Information on product specifications, drivers for download
- Frequently Asked Questions (FAQ), Sales Enquiries, questions through e-mail

Epson Hotline

Phone: 1500-766 (Indonesia Only)

Email: customer.care@ein.epson.co.id

Our Hotline team can help you with the following over the phone or email:

- Sales enquiries and product information
- Technical support

Help for Users in Hong Kong

To obtain technical support as well as other after-sales services, users are welcome to contact Epson Hong Kong Limited.

Internet Home Page

<http://www.epson.com.hk>

Epson Hong Kong has established a local home page in both Chinese and English on the Internet to provide users with the following information:

- Product information
- Answers to Frequently Asked Questions (FAQs)
- Latest versions of Epson product drivers

Technical Support Hotline

You can also contact our technical staff at the following telephone and fax numbers:

Phone: 852-2827-8911

Fax: 852-2827-4383

Help for Users in Malaysia

Contacts for information, support, and services are:

World Wide Web

<http://www.epson.com.my>

- Information on product specifications, drivers for download

Frequently Asked Questions (FAQ), Sales Enquiries, questions through e-mail

Epson Call Centre

Phone: 1800-81-7349 (Toll Free)

Email: websupport@emsb.epson.com.my

- Sales enquiries and product information
- Product usage questions or problems
- Enquiries on repair services and warranty

Epson Malaysia Sdn Bhd (Head Office)

Phone: 603-56288288

Fax: 603-5628 8388/603-5621 2088

Help for Users in India

Contacts for information, support, and services are:

World Wide Web

<http://www.epson.co.in>

Information on product specifications, drivers for download, and products enquiry are available.

Toll Free Helpline

For Service, Product information or to order consumables -

18004250011 / 186030001600 / 1800123001600 (9AM – 6PM)

Email

calllog@epson-india.in

WhatsApp

+91 96400 00333

Help for Users in the Philippines

To obtain technical support as well as other after sales services, users are welcome to contact the Epson Philippines Corporation at the telephone, fax numbers and e-mail address below:

World Wide Web

<http://www.epson.com.ph>

Information on product specifications, drivers for download, Frequently Asked Questions (FAQ), and E-mail Enquiries are available.

Epson Philippines Customer Care

Toll Free: (PLDT) 1-800-1069-37766

Toll Free: (Digitel) 1-800-3-0037766

Metro Manila: +632-8441-9030

Web Site: <https://www.epson.com.ph/contact>

E-mail: customercare@epc.epson.com.ph

Accessible 9am to 6pm, Monday through Saturday (Except public holidays)

Our Customer Care team can help you with the following over the phone:

- Sales enquiries and product information
- Product usage questions or problems
- Enquiries on repair service and warranty

Epson Philippines Corporation

Trunk Line: +632-8706-2609

Fax: +632-8706-2663 / +632-8706-2665