

EPSON[®]
***PhotoPC* 650**
MEGAPIXEL DIGITAL CAMERA

User's Guide

EPSON®
PhotoPC 650
MEGAPIXEL DIGITAL CAMERA

User's Guide

IMPORTANT NOTICE

All rights reserved. No part of this publication may be reproduced, stored in a retrieval system, or transmitted in any form or by any means, electronic, mechanical, photocopying, recording, or otherwise, without the prior written permission of SEIKO EPSON CORPORATION. No patent liability is assumed with respect to the use of the information contained herein. Neither is any liability assumed for damages resulting from the use of the information contained herein.

Neither SEIKO EPSON CORPORATION nor its affiliates shall be liable to the purchaser of this product or third parties for damages, losses, costs, or expenses incurred by the purchaser or third parties as a result of: accident, misuse, or abuse of this product or unauthorized modifications, repairs, or alterations to this product, or (excluding the U.S.) failure to strictly comply with SEIKO EPSON CORPORATION's operating and maintenance instructions.

SEIKO EPSON CORPORATION shall not be liable against any damages or problems arising from the use of any options or any consumable products other than those designated as Original EPSON Products or EPSON Approved Products by SEIKO EPSON CORPORATION.

EPSON is a registered trademark of SEIKO EPSON CORPORATION.
PhotoPC is a trademark of SEIKO EPSON CORPORATION.
Macintosh is a registered trademark of Apple Computer, Inc.
Microsoft and Windows are registered trademarks of Microsoft Corporation.

CompactFlash is a trademark of SanDisk Corporation and has been licensed to CFA (CompactFlash Association).

General Notice: Other product names used herein are for identification purposes only and may be trademarks of their respective owners. EPSON disclaims any and all rights in those marks.

Copyright©1999 by SEIKO EPSON CORPORATION, Nagano, Japan.

A NOTE CONCERNING RESPONSIBLE USE OF COPYRIGHTED MATERIALS

Like photocopiers, digital cameras can be misused by improper photographing of copyrighted material. Unless you have the advice of a knowledgeable attorney, be responsible and respectful by obtaining the permission of the copyright holder before photographing published material.

Contents

Introduction

| | |
|---|---|
| EPSON PhotoPC 650 Features | 1 |
| System Requirements | 1 |
| Safety Instructions | 1 |
| Warnings, Cautions, and Notes | 3 |

Chapter 1 Getting Started

| | |
|--|-----|
| Unpacking Your PhotoPC 650 | 1-1 |
| Installing the CompactFlash Card | 1-1 |
| Installing Batteries | 1-2 |
| Setting the Date and Time | 1-4 |
| Attaching the Strap | 1-5 |
| Removing the Protective Plastic | 1-5 |

Chapter 2 Taking Pictures

| | |
|---|-----|
| Taking Pictures with the Viewfinder | 2-1 |
| Taking Pictures with the LCD Monitor | 2-2 |
| Using the Macro Feature to Take Close-ups | 2-3 |
| Taking Pictures with the Timer | 2-3 |
| Saving Battery Power with Auto Shut-Off | 2-4 |
| Checking the Status of the Camera | 2-4 |

Chapter 3 Playing Back and Managing Your Pictures

| | |
|--|-----|
| Playing Back Pictures on the LCD Monitor | 3-1 |
| Playing Back Pictures on TV or Video | 3-1 |
| Erasing the Currently Displayed Picture | 3-2 |
| Accessing the Playback Menus | 3-3 |
| Changing the Camera Settings | 3-4 |
| Locking and Erasing Photos | 3-6 |

Chapter 4 Getting Photos Into Your Computer

| | |
|---|-----|
| Installing Your PhotoPC 650 Software | 4-1 |
| Transferring Pictures with the Serial Cable and HotShots | 4-2 |

Chapter 5 Using Camera Options

| | |
|---|-----|
| Using Optional CompactFlash Cards | 5-1 |
| Using the Optional AC Adapter | 5-3 |

Appendix

Introduction

EPSON PhotoPC 650 Features

The EPSON® PhotoPC 650™ is a complete system for capturing digital images, and includes the following features:

- Resolutions up to 1152 × 864 pixels, ideal for printing images up to 5 × 7 inches
- 24-bit color image capture
- 1.8-inch, active matrix TFT color LCD monitor for previewing and playing back pictures
- Video output for playing your pictures back on a TV or for videotaping them
- Built-in lens and filter threads (37 mm)
- Built-in flash with red-eye reduction mode

System Requirements

For PCs

- 486/66 or higher processor (Pentium® recommended)
- Microsoft® Windows 95, Windows 98, or Windows NT® 4.0 and an available serial port
- At least 16 MB RAM (32 MB recommended)
- At least 50 MB free hard disk space

- Double-speed CD-ROM drive
- VGA or SVGA monitor displaying thousands of colors
- Mouse or other pointing device

For Macintosh computers

- Macintosh with PowerPC or higher processor
- System 7.6 or higher, and an available serial port
- At least 16 MB RAM (32 MB recommended)
- At least 50 MB free hard disk space
- Double-speed CD-ROM drive
- VGA monitor displaying thousands of colors
- Mouse or other pointing device

Note:

To use your Photo PC 650 with an iMac or Power Macintosh G3, you need to install a PC card reader or USB/Serial port adapter in your Macintosh. See your dealer for details.

Safety Instructions

Read all these instructions and save them for later reference. Follow all warnings and instructions marked on the camera and options.

When using the camera

- ❑ To reduce the risk of electric shock, do not remove the cover of the camera or options and do not open any compartments except as instructed in this *User's Guide*.
- ❑ Do not insert objects into any openings.
- ❑ To prevent fire or electric shock, do not expose the camera or options to rain or moisture, and do not cover the camera with a blanket.
- ❑ To prevent fire or explosion, do not use the camera where flammable or volatile gas is stored.
- ❑ Do not use outdoors during a thunderstorm.
- ❑ If the camera or option shows unusual signs such as noise, odor, or smoke, stop usage and turn off immediately. Remove the batteries and/or disconnect the AC adapter from the camera, and unplug the AC adapter from the electrical outlet.
- ❑ To prevent possible injury, do not take flash pictures close to the subject's eyes.
- ❑ Remove the batteries and/or plug from the camera and refer servicing to qualified service personnel in the following circumstances:
The power cord or plug is damaged; liquid has entered the camera or options; the camera or options have been dropped, or the case damaged; the camera or options do not operate normally or exhibit a distinct change in performance.
- ❑ Never adjust controls that are not mentioned in the operating instructions.

- ❑ If the liquid crystal solution contained in the display panel or in the screen on the LCD monitor leaks out and gets on your hands, wash them thoroughly with soap and water. If it gets into your eyes, flush them immediately with water.

When using the strap

- ❑ Do not swing the camera about. This can damage the camera or other objects, or injure others.
- ❑ Do not pull or tighten the strap too firmly while wearing it around your hand; this can cause serious injury.
- ❑ Keep the strap away from children.

When using the batteries

- ❑ Read all relevant safety and operating instructions before using the batteries.
- ❑ Only use the batteries in EPSON Digital Cameras as specified in this manual.
- ❑ If battery acid gets into your eyes or on your skin, immediately rinse the affected area thoroughly with water and seek medical treatment. If a battery is swallowed, seek medical treatment immediately.
- ❑ Always use batteries from the same package as a set. Do not mix old and new batteries, or charged and discharged batteries.
- ❑ Do not use manganese batteries.
- ❑ Keep the batteries from making contact with metal objects such as coins or keys, which could short circuit the batteries.
- ❑ Do not drop, puncture, disassemble, mutilate, or short circuit batteries. Do not put the batteries near or into fire or water.

- ❑ Do not insert batteries into wall outlets or other power sources such as a car cigarette lighter socket.
- ❑ Do not solder lead wires or terminals directly to a battery.
- ❑ To avoid fire or electric shock, do not use batteries that are leaking or damaged in any way.
- ❑ To prevent fire or explosion, do not use the charger where flammable or volatile gas is stored.

For United Kingdom users

Use of options

EPSON (UK) LTD shall not be liable against any damages or problems arising from the use of any options or consumable products other than those designated as Original EPSON Products or EPSON Approved Products by EPSON (UK) LTD.

Safety information



Warning:

This appliance must be earthed. Refer to the rating plate for voltage and check that the appliance voltage corresponds to the supply voltage.

Important:

The wires in the mains lead fitted to this appliance are colored in accordance with the following code:

*Green and yellow — Earth
Blue — Neutral
Brown — Live*

Warnings, Cautions, and Notes



Warnings must be followed carefully to avoid bodily injury.



Cautions must be observed to avoid damage to your equipment.

Notes contain important information and useful tips on the operation of your camera and options.

Getting Started

Unpacking Your PhotoPC 650

Make sure you have all the parts shown below.



PhotoPC 650 camera

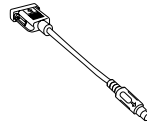

Mac adapter cable

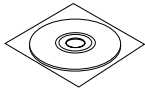

software (Media type and quantity varies by location.)



hand strap

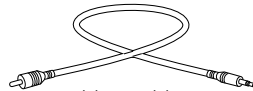

video cable

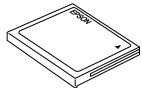

CompactFlash Card (8 MB)

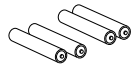

four AA alkaline batteries

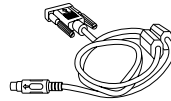

serial cable

Installing the CompactFlash Card

Before you can take pictures with your camera, you must install a CompactFlash Card. Follow these steps.

1. Make sure the camera is turned off.

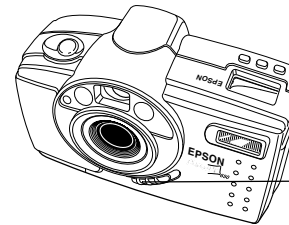

Slide lens cover switch down to turn off camera.

2. Open the camera's card and port cover, and insert the card all the way into the slot, as shown. Make sure the card's label faces the front of the camera.

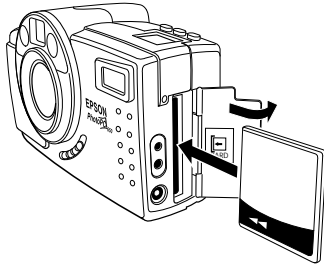

3. Close the card and port cover.

Note:

For instructions on removing CompactFlash Cards, see "Removing a CompactFlash Card" on page 5-1.

Installing Batteries

Before installing the batteries, be sure to read the safety instructions on page 2. Then follow these steps.

1. Make sure the camera is turned off. The camera is off when the lens cover switch is down.

2. Orient the camera upside down with the front of the camera facing you.
3. To open the battery cover, push it down and to the right. Then raise the cover.

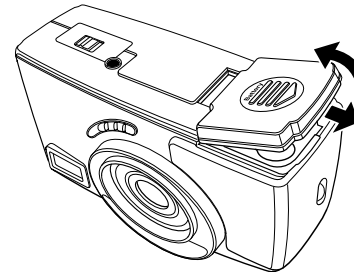

4. Insert all four batteries into the compartment, positioning the + and - ends as shown.

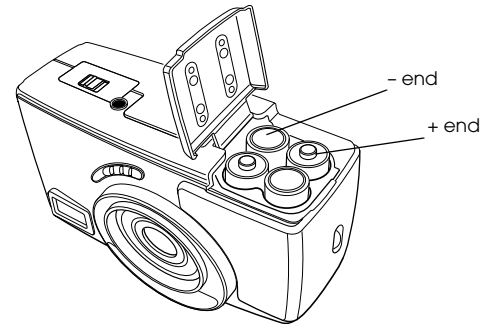

5. Lower the battery cover, then slide it to the left while pressing it down until it snaps into place.

See the next section for important information about using your batteries safely and efficiently.

Using batteries safely and efficiently

When your PhotoPC 650 batteries wear out, replace them with one of the following types of AA batteries.

- Rechargeable NiMH (recommended) or NiCad batteries
- Single-use alkaline batteries
- Single-use lithium batteries (longer life)



Warning:

To avoid the danger of fire or explosion, do not mix different types of batteries. Do not allow the battery contacts to touch metal objects such as coins or keys, which could short out the battery's circuits. Read all safety and handling instructions before using batteries.

Note the following when using batteries:

- Replace all four batteries at the same time. Do not mix old and new batteries.
- When the camera is not used for long periods of time, remove the batteries and store them at a low temperature in a dry location. Store away from the reach of children.

- Battery life varies depending on the battery type, the manufacturer, and other factors.
- Avoid using your camera in low temperatures, especially below 10 °C (50 °F); this drains your batteries faster.

Disposing of the batteries

Before disposing of batteries, make sure you discharge them completely.



Warning:

- Be sure to securely cover the + end of each battery with tape to prevent combustion or explosion when disposing.*
- Dispose of used batteries according to the manufacturer's instructions and in compliance with all applicable laws. Contact your local government agency for information about battery recycling and disposal.*

For the Netherlands users:

Do not dispose of the batteries with ordinary refuse. Instead, dispose of them as small chemical waste in accordance with local laws, and the following Dutch Government Gazette 45, KCA Marking:



Bij dit produkt zijn batterijen geleverd.
Wanneer deze leeg zijn, moet u ze niet weggooien maar inleveren als KCA.

For German users:

Do not dispose of batteries with ordinary refuse. Instead, dispose of them in a recycle box in accordance with local laws.

Setting the Date and Time

You need to set the camera's clock before using the camera for the first time, and each time after installing new batteries.

Note:

To adjust the date and time while using camera, see "Changing the Camera Settings" on page 3-4.

Make sure you have installed the CompactFlash Card in the camera, then follow these steps to set the camera's clock.

1. Slide the lens cover switch up to the ON position to open the lens cover and turn on the camera.

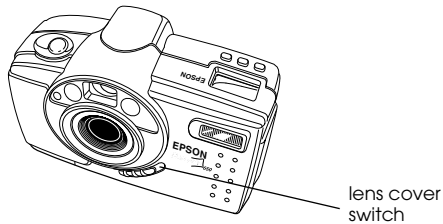

2. On the back of the camera, slide the monitor switch to PLAYBACK. A message asking you to set the clock appears on the LCD monitor.

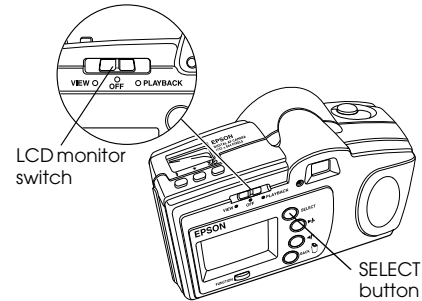

3. Press the SELECT button. The Clock Setting menu appears with the month setting highlighted in white.

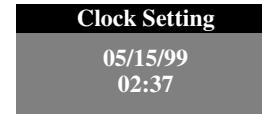

4. If necessary, press the $\blacktriangleright/\blacktriangle$ button to increase the number or the $\blacktriangleleft/\blacktriangledown$ button to decrease the number, until the month is correct.
5. Press the SELECT button. The month setting is saved and the day setting is highlighted.

6. Adjust the day, year, hour, and minute settings as described above until the date and time are correctly adjusted.
7. Press the SELECT button to exit the Clock Setting menu.
8. Slide down the lens cover switch to turn the camera off.

Attaching the Strap

Slide the loop through the holder on the camera, then pull the strap through the loop.

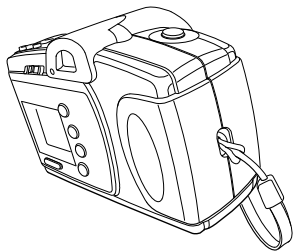

Removing the Protective Plastic

Peel off the protective plastic sheets from the camera's back panel, and from the viewfinder area on the front of the camera.

Taking Pictures

Taking Pictures with the Viewfinder

Follow these steps to take a picture with the viewfinder.

1. Make sure you are at least 0.3 meters (12 inches) away from your subject. (If you want to get closer, use the macro feature as described on page 2-3.)
2. Turn the camera on and wait until the status light beside the viewfinder turns green and stays on.

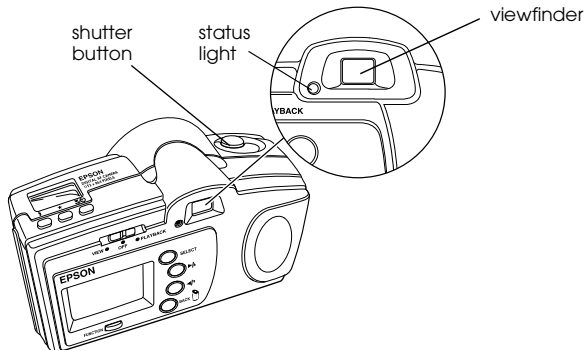

3. Look straight through the viewfinder and center your subject.
4. Press and hold the shutter button halfway down to lock the auto focus. The status light beside the viewfinder changes from green to orange. If you wish, you can now move your subject off-center without altering the focus.
5. Press the shutter button the rest of the way down to take the picture.
6. Hold the camera still until it beeps and the status light starts flashing red. This indicates that the camera has captured and is processing the image.



Caution:

If you set the camera down while the light is still flashing, make sure you handle it carefully. The camera may lose your image if you set it down too hard.

7. The quick review image appears on the camera's LCD monitor to let you see how your picture turned out, and to let you delete the picture, if necessary, before your camera saves it. This image remains on the monitor for about five seconds, and a gauge appears on the image indicating the time you have left to delete the picture. To delete the picture, hold down the FUNCTION button and press the BACK button.



quick review gauge

If you did not delete the image, the image is saved when the status light stops flashing and turns green. You can take another picture at this point.

Taking Pictures with the LCD Monitor

Follow these steps to take a picture with the LCD monitor.



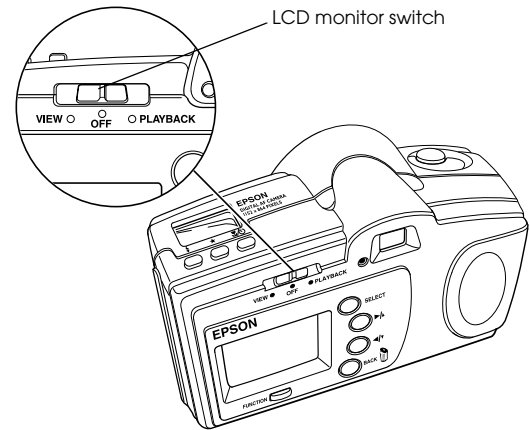

1. Turn on the camera and slide the LCD monitor switch left to the VIEW position. A preview of your picture appears on the LCD monitor.



2. Center your subject on the monitor.
3. Follow the instructions from step 4 of "Taking Pictures with the Viewfinder" on page 2-1.

Using the Macro Feature to Take Close-ups

You can use the camera's macro function to take pictures from as close as 15 centimeters (6 inches) to your subject. Follow these steps.

1. Turn the camera on and slide the monitor switch to the VIEW position. A live preview appears on the LCD monitor.
2. Press the  macro/timer button on the top of the camera until the  macro icon appears on the display panel at the top of the camera. To use the macro feature and the timer together, press the  macro/timer button until the  macro and  timer icons appear together on the display panel.
3. Center your subject on the monitor.
4. Follow the instructions from step 4 of "Taking Pictures with the Viewfinder" on page 2-1.







Note:

To take macro close-ups in low light conditions, use a tripod and the timer (see the next section), and disable the flash (as described on page 2-5). Otherwise, your pictures may appear blurry and washed-out.

Taking Pictures with the Timer

Setting the timer creates a ten-second delay between the time you press the shutter button and the actual image capture. This allows you to take a picture of yourself.

Follow these steps to take a picture with the timer.

1. Place the camera on a flat surface or on a tripod. The tripod threads are located on the bottom of your camera.
2. Turn on the camera and wait until the status light turns green.
3. Press the  macro/timer button until the  timer icon appears on the display panel at the top of the camera. To use the timer and the macro feature together, press the  macro/timer button until the  timer and  macro icons appear together on the display panel.
4. Press the shutter button. The red timer light on the front of the camera comes on, and the  timer icon on the display panel begins flashing. About two seconds before the camera takes the picture, the red timer light begins flashing.

The camera beeps when the image is captured and the status light flashes red.

5. The quick review image appears on the LCD monitor.

For more information on the quick review image, see page 2-2.

Saving Battery Power with Auto Shut-Off

To save battery power, the camera automatically turns off after a certain period of time. When the LCD monitor is on, the camera turns off when idle for 30 seconds; when the monitor is off, the camera turns off when idle for 60 seconds.

To turn the camera back on, press the SELECT or BACK button, or use the lens cover switch to turn the camera off and back on again.

Checking the Status of the Camera

The display panel shows the current camera settings and the status of your battery power.

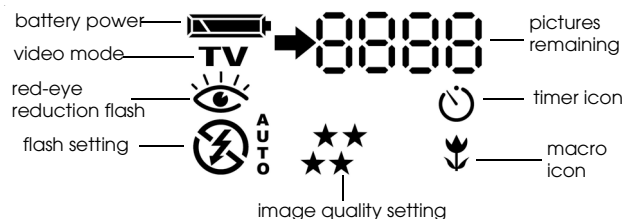

- ❑ **Battery power**
When your battery power is running low, the  low battery icon appears. This icon flashes when your battery power is completely out.
- ❑ **Picture counter**
The number in the upper right corner of the display panel shows how many pictures you can take.

Making the image quality setting

Press the ★ image quality button on top of the camera to cycle from one setting to the other. You can select from these image quality settings.

Note:

Depending on the content of your pictures, your camera may hold more or fewer pictures than listed here.

- ★ **Standard**
Produces color images at 640 × 480 pixels. The CompactFlash Card holds approximately 88 pictures, but the image size is smaller and includes less detail when enlarged.

- ★★ **Fine**
Produces color images at 1152 × 864 pixels, with moderate compression. The CompactFlash Card holds approximately 47 pictures. Fine image quality is sufficient for most purposes.

- ★
★★ **Super fine**
Produces color images at 1152 × 864 pixels with low compression. The CompactFlash Card holds approximately 30 pictures.

- ★
★★
★★ **Uncompressed**
Produces color images at 1152 × 864 pixels with lossless compression. The CompactFlash Card holds approximately four pictures in this mode.

Making the flash settings

The camera's built-in flash is effective within a range of one to three meters (3.2 to 9.8 feet). Press the  flash button to cycle through the four flash settings. Your flash setting remains in effect even after you turn off the camera.

An icon for each setting appears on the display panel.

-  **Automatic**
The flash goes off automatically whenever it is needed for adequate lighting. Use only when you are one to three meters (3.2 to 9.8 feet) from your subject.

-  **Forced flash**
The flash goes off with every picture you take.

-  **Flash off**
The flash is disabled.

-  **Red-eye reduction**
The flash blinks on and off rapidly, then flashes normally to prevent light from reflecting directly off your subject's pupils.

- 

Playing Back and Managing Your Pictures

Playing Back Pictures on the LCD Monitor

When you set the monitor switch to PLAYBACK, the last picture you took appears on the LCD monitor, along with the image quality setting and picture number information.



image quality number of current picture/number of photos taken

Press the ◀/▼ or ▶/▲ button to move backward or forward through your pictures.

Playing Back Pictures on TV or Video

Use the video cable that came with your PhotoPC 650.

Setting the video standard

Set the monitor switch to PLAYBACK and follow these steps to select a video standard.

1. Press the SELECT button to display the Playback menus.
2. Press the ▶/▲ or ◀/▼ button until the Video menu appears.



3. Press the SELECT button to select the video standard you want to use. (Select NTSC for U.S./Canada, or PAL for Europe/S. America/etc.)

4. Press the BACK button to exit the menus.

Viewing the pictures

Using the optional AC adapter is highly recommended when you play back your pictures on a TV. See Chapter 5, “Using Camera Options.”

Follow these steps to play back your pictures on TV.

1. Make sure the camera and TV (and VCR) are turned off.
2. Open the camera’s card and port cover and connect the black end of the video cable to the Video Out port.

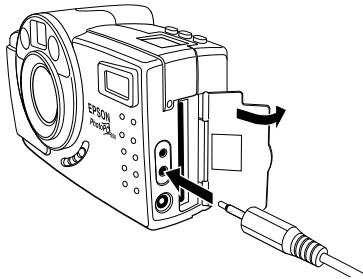

3. Connect the yellow end of the cable to the VIDEO IN port on the television or VCR.

4. Turn on the TV (and VCR), and switch to the correct video mode.
5. Turn on the camera and slide the monitor switch to PLAYBACK.
6. Press the SELECT button on the back of the camera. The last picture you took appears on the TV screen. Press the ►/▲ or ◀/▼ button to move forward or backward through your pictures.
7. When you are finished viewing pictures, press the BACK button, slide the LCD monitor switch to OFF. Then turn off the camera, and disconnect the video cable.

Erasing the Currently Displayed Picture

Make sure the LCD monitor switch is set to PLAYBACK and the image you want to erase is displayed. Then follow these steps.

1. Hold down the FUNCTION button and press the BACK button.

The following message appears on the LCD monitor.

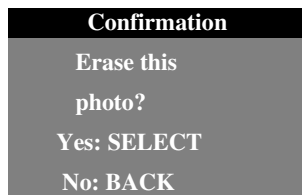

Note:

You cannot erase any pictures that are locked. To unlock pictures, see "Locking and Erasing Photos" on page 3-6.

2. Press the SELECT button to erase the picture and exit the menus.

Accessing the Playback Menu

Follow these steps to access the playback menus.

1. Turn on the camera by sliding the lens cover switch up to the ON position.

2. Slide the LCD monitor switch to PLAYBACK. The last photo you took appears on the LCD monitor.

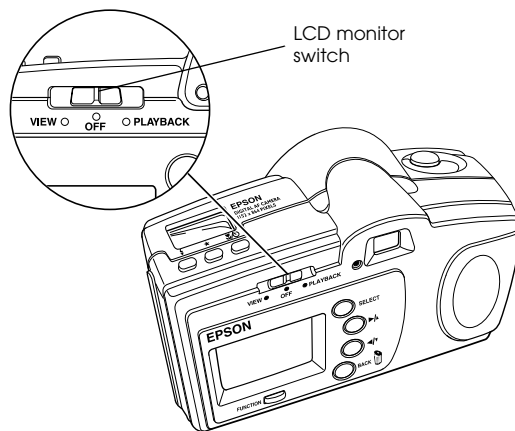

3. To access the menus, press the SELECT button. Menu icons appear at the top of the monitor with the currently selected menu icon highlighted. The corresponding menu appears below the icons, as shown.

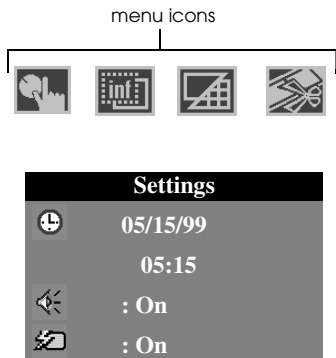

4. Press the **▶/▲** and **◀/▼** buttons to view the settings for other menus. You can choose from the following menus.



Settings (set the date, time, beep, and Quick Review, and LCD brightness). See page 3-4 for more information.



Information (turn off/on the display of information on played-back pictures).



Playback Mode (play back images one at a time or in groups of 9).



Photo Control (erase or lock your pictures, or reformat CompactFlash Cards). See page 3-6 for instructions.



Video (NTSC or PAL video output to standard TV). See page 3-1 for instructions.



Slide Show (play back pictures automatically). Press **SELECT** button to start the slide show. Press **BACK** to stop it.



Language (select from six languages for LCD display and menus.)

5. Press the **SELECT** button to select the menu options.
6. To exit the menus, press the **BACK** button until the menu icons and settings disappear.



Changing the Camera Settings



The Settings menu includes the following settings, and lets you:



Adjust the date and time



-  Turn the alert beep on and off
(When on, camera beeps when an image is captured.)
-  Turn the quick review on and off
(When on, you can review / delete the picture you just took.)
-  Adjust the LCD monitor brightness.

To change the settings above, follow the steps below.

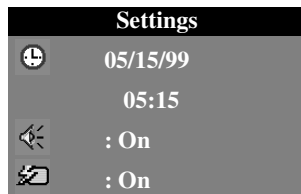
1. Display the Settings menu as described in “Accessing the Playback Menus” on page 3-3. The current settings are displayed.



2. Press the SELECT button once, then press the $\blacktriangleright/\blacktriangle$ or $\blacktriangleleft/\blacktriangledown$ button to select the icon of the setting you want to change.

- To set the date and time:**
Press SELECT to highlight the month setting. Press the $\blacktriangleright/\blacktriangle$ or $\blacktriangleleft/\blacktriangledown$ button to adjust the number, then press the SELECT button again to save your changes and highlight the next setting. Continue changing the settings this way until all the date and time settings are correct and saved.
 - To turn the alert beep on or off:**
Press $\blacktriangleright/\blacktriangle$ or $\blacktriangleleft/\blacktriangledown$ to highlight the  alert beep icon, then press the SELECT button to select On or Off.
 - To turn the quick review function on or off:**
Press $\blacktriangleright/\blacktriangle$ or $\blacktriangleleft/\blacktriangledown$ to highlight the  quick review icon, then press the SELECT button to select On or Off.
 - To change the LCD monitor brightness:**
Press $\blacktriangleright/\blacktriangle$ or $\blacktriangleleft/\blacktriangledown$ to highlight the  brightness icon, then press the SELECT button to highlight the LCD brightness slider. Press the $\blacktriangleright/\blacktriangle$ or $\blacktriangleleft/\blacktriangledown$ buttons adjust the monitor brightness.
3. When you are finished changing the settings, press the BACK button until you exit the menus.

Locking and Erasing Photos



The Photo Control menu lets you erase or lock photos to protect from the deletion and unlock them, or reformat CompactFlash Card.

To erase or lock/unlock pictures using the Photo Control menu, follow these steps:

Note:

To reformat CompactFlash Card, see “Using Optional CompactFlash Cards” on page 5-1.

1. Display the Photo Control menu as described in “Accessing the Playback Menus” on page 3-3.



2. Press the SELECT button once. Erase is highlighted. If you want to erase photos, press the SELECT button again. If you want to lock photos, press the ◀/▼ button once (LOCK is highlighted), then press the SELECT button. One of these menus appears.

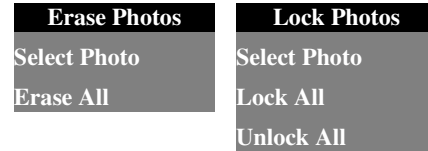

3. Press the ▶/▲ or ◀/▼ button to choose Select Photo or Erase All from Erase Photos menu, or Select Photo, Lock All or Unlock All from Lock Photos menu.
 - ❑ If you chose Erase All, Lock All or Unlock All press the SELECT button. A confirmation message appears. Follow the instructions on the LCD monitor.
 - ❑ If you chose Select Photo, press the SELECT button. The thumbnail images of your photos are displayed. Go to the next step.
4. Press the ▶/▲ or ◀/▼ button to move the white selection frame to the photo you want to erase or lock.



5. Press the SELECT button. The selection frame around the image turns yellow. If you want to erase or lock other photos at the same time, use the ►/▲ or ◀/▼ button to frame them, then press the SELECT button to select them.

Note:

To cancel the selection of a photo, press the SELECT button again. The selection box turns white.

6. When you have selected all the photos you want to erase or lock, press the BACK button. A confirmation message appears.
7. Follow the instructions on the LCD monitor.

Note:

When you lock photos, a  lock icon appears in the selected photos. When you unlock photos, the  lock icon disappears from the photos.

8. When you are finished, press the BACK button until you exit the menus.

Getting Photos Into Your Computer

Installing Your PhotoPC 650 Software

The included CD-ROM contains these applications for your Windows PC or Macintosh computer.

- ❑ PictureWorks HotShots
- ❑ EPSON PhotoPC 650 TWAIN driver (Windows) or Plug-In (Macintosh)

On a Windows PC

Follow these steps:

1. Close all open applications, then insert the PhotoPC 650 software CD-ROM shipped with your camera in the CD-ROM drive.
2. Double-click My Computer. Then double-click the PhotoPC 650 icon.
3. Double-click the Setup.exe icon. The installer opens.

4. Follow the instructions on the screen to install HotShots and EPSON PhotoPC 650 TWAIN. Be sure to select Full Install - Typical on the Setup Options screen.

On a Macintosh

Follow these steps:

1. Insert the PhotoPC 650 software CD-ROM shipped with your camera in the CD-ROM drive.
2. Double-click the PhotoPC 650 icon on your desktop to open the CD-ROM window.
3. Double-click the HotShots Installer icon to install HotShots and the EPSON PhotoPC 650 Plug-In driver. Click Continue and follow the on-screen instructions.

Transferring Pictures with the Serial Cable and HotShots

Follow the steps in these sections to transfer your pictures directly from the camera using the serial cable and HotShots.

Connecting the Camera to a Windows PC

Make sure you have the serial cable that came with your camera. Before you start, turn off the camera, LCD monitor, and your computer.

1. Locate a serial port on the back of your computer. You may have two serial ports labeled COM1 and COM2, or they may be labeled with icons. For best results, use COM1 (port 1) to connect your camera.

Note:

If you have a 25-pin serial port, you can use a 9- to 25-pin adapter, available at most computer stores.

2. Line up the serial connector on the cable with one of the serial ports on your computer, and insert the connector. Then tighten the screws.

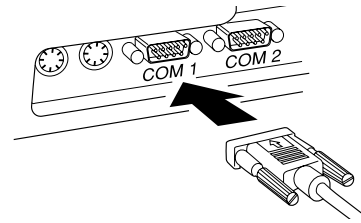

3. Open the card and port cover on the side of the camera. Then insert the other end of the cable into the camera's  serial port.

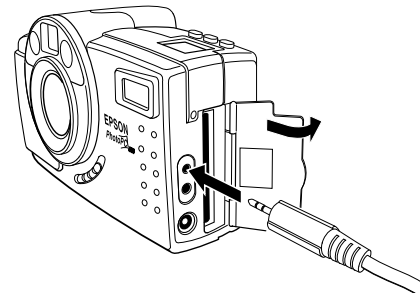



4. Turn on your computer system.

Note:

If you have problems connecting to your COM port, check your computer's COM port settings and try again. If you have a high-speed serial board, you may be able to transfer pictures at 230.4 Kbps. See page 4-5 for instructions on using EPSON PhotoPC 650 TWAIN to change your Port speed setting.

Connecting the Camera to a Macintosh

Make sure you have the long serial cable and short Macintosh adapter that came with your camera. Before you start, turn off the camera, LCD monitor, and Macintosh.

1. Connect the small Macintosh adapter cable to either the  modem port or  printer port on the back of your Macintosh.

Line up the arrow on the cable connector with the port icon on your Macintosh. Then insert the connector.

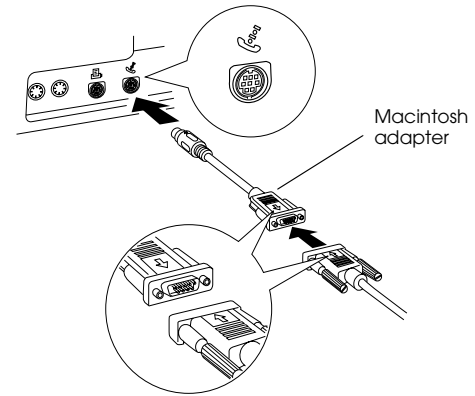

Note:

If you share a serial port with another device, make sure AppleTalk™ is turned off. Your Macintosh may not recognize the camera if AppleTalk is on. Also, if you have problems connecting to the printer port, use the modem port instead.

2. Connect the long serial cable to the short Macintosh adapter cable, then tighten the screws.

- Open the card and port cover on the side of the camera and insert the connector on the long serial cable into the camera's  serial port.

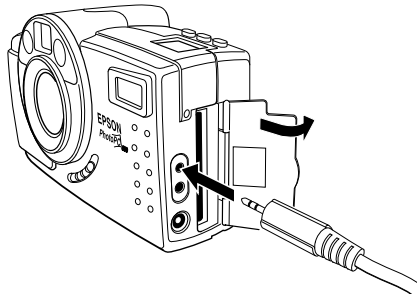

- Turn on your Macintosh system.

Opening the EPSON PhotoPC 650 TWAIN or Plug-In driver

To transfer the pictures via the serial cable, you must first open the EPSON PhotoPC 650 TWAIN (Windows) or Plug-In driver (Macintosh) from within HotShots.

- Connect the camera to your computer using the serial cable; see page 4-2 for instructions.
- Start HotShots.

In Windows, click Start, point to Programs, PhotoPC 650, and then click HotShots 1.5.

On a Macintosh, open the PhotoPC650 folder, then open the HotShots folder and double-click the HotShots icon.

- The main HotShots window with the remote control appears. Click the Get button on the remote control, then click Get from Camera.

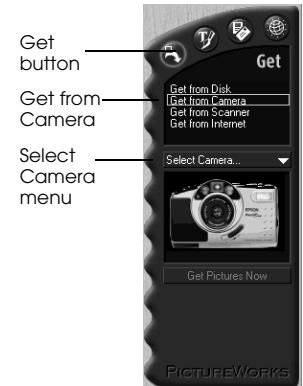

- Click the arrow in the Select Camera menu. Then click EPSON PhotoPC 650 TWAIN (Windows) or EPSON PhotoPC 650 (Macintosh).

- Click the Get Pictures Now button. The Get Pictures window appears.

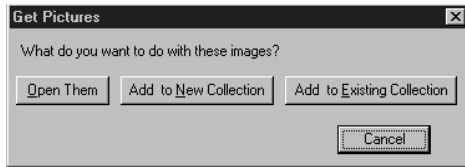

- Click the Open Them button.

Note:

- ❑ *If you select Add to New Collection or Add to Existing Collection, you may see a dialog box allowing you to change the transfer file format. It is best to keep your files in the JPEG format because of their small size and quick transfer speed. This only affects files you transfer into HotShots (see page 4-8); it does not affect files you save to your hard disk (see page 4-7).*
- ❑ *On a Macintosh, if no existing collection is open and you select Add to Existing Collection, HotShots then prompts you to select a collection file.*

The EPSON PhotoPC 650 TWAIN or Plug-In dialog box appears (the Windows version is shown below). The pictures in your camera appear in the dialog box.

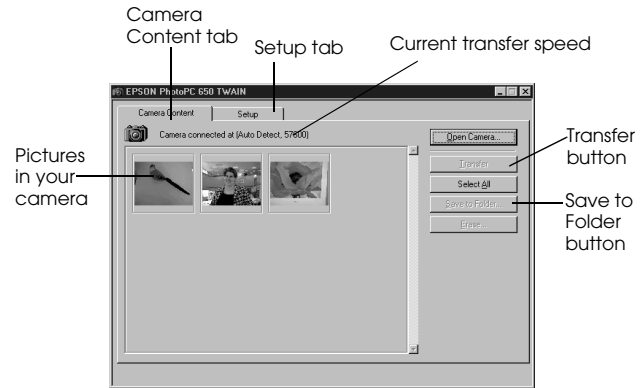

(If you do not see the pictures in your camera when you open the dialog box, click Open Camera.)

If the current transfer speed displayed on the Camera Content tab is 57600 or lower, select a faster transfer speed from the Setup menu.

When you are ready to select the pictures you want to transfer, see the next section.

Selecting pictures to transfer

There are three ways to select pictures to transfer.

- ❑ Clicking an individual picture
- ❑ Holding down the Shift or Ctrl key (Windows), or the ⌘ key (Macintosh), and clicking multiple pictures
- ❑ Clicking the Select All button to select all the pictures

Your selected pictures are outlined in red.

Note:

To permanently erase a picture from your camera, select it and click Erase, then confirm the erasure.

Once you have selected pictures, you are ready to transfer them to your camera. See the next section.

Transferring pictures from the camera to your computer

You can use the Save to Folder button or the Transfer button to transfer your pictures from your camera to your computer.

- ❑ The fastest method is using the Save to Folder on the Camera Content tab. This lets you transfer your pictures and save them directly to a selected folder on your hard disk, saving battery power and time. See the next section for instructions.
- ❑ You can also use the Transfer button on the Camera Content tab to import your pictures into HotShots. This stores the pictures in your computer's RAM (memory), not on your hard disk. See page 4-8 for instructions.

Note:

If your camera shuts off automatically while you are transferring pictures (to save battery power), click the Open Camera button on the TWAIN or Plug-In dialog box to turn it back on.

Saving pictures to a folder

1. To save your pictures to a folder on your hard disk, click the Save to Folder button. One of these dialog boxes appears:

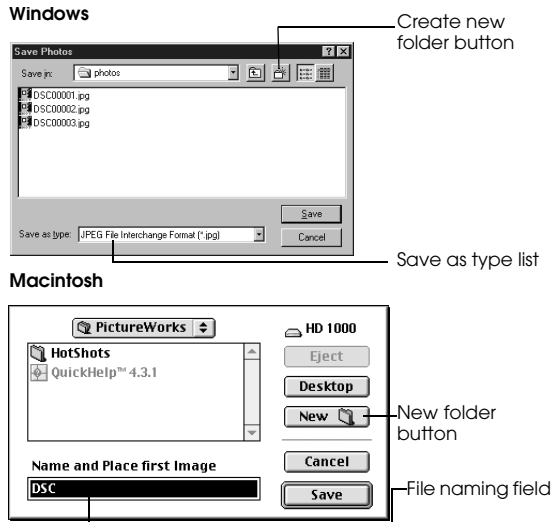

2. Select the folder you want to save your pictures to, or click the create new folder (Windows) or new folder button (Macintosh) to create a new folder.

Note:

To select a different default folder for the program to use each time you open it, click the Setup tab on the dialog box and click Browse under Default Photo Folder.

3. If you want to save your pictures in a format other than JPEG, select it from the Save as type list (Windows only). On a Macintosh, you can also type in a different file name for the image files in the file naming field.
4. When you are ready to transfer your pictures, click Save.

As the files are transferred, they are either automatically given a generic name (Windows), or given the name you selected (Macintosh), and then numbered sequentially.

To cancel a transfer in progress, click Cancel (Windows) or press the J and period (.) keys (Macintosh).

5. Close the EPSON PhotoPC 650 TWAIN or Plug-In dialog box and return to HotShots.

You need to open your pictures from disk to use them in your image editing application. To open them in HotShots, see your HotShots documentation. To import them with another application, see that application's documentation.

Transferring pictures into HotShots

1. To transfer your pictures into HotShots, click the Transfer button.
 - ❑ If you selected Open Them in step 6 on page 4-5, HotShots automatically transfers the pictures into your computer's memory, opens them in individual windows, and numbers the windows sequentially.

Note:

The pictures are not yet saved to your computer's hard disk.

- ❑ If you selected Add to New Collection, HotShots transfers your pictures into a new collection window and saves them to the HotShots collection folder.

- ❑ If you selected Add to Existing Collection, HotShots transfers them into an open collection or prompts you to open the collection you want to transfer them to. Then HotShots saves the pictures in the same folder as the collection.

Note:

If a memory error message appears while transferring pictures, close the EPSON PhotoPC 650 TWAIN or Plug-In dialog box and use the Save to Folder method to transfer your pictures instead. See page 4-7 for instructions. (You may also need to close and then reopen HotShots to free-up your computer's memory.)

To cancel a transfer in progress, click Cancel (Windows), or press the J and period (.) keys (Macintosh).

2. After your pictures are transferred, close the EPSON PhotoPC 650 TWAIN or Plug-In dialog box and return to HotShots. The picture(s) appear(s) in the HotShots window. To work with your pictures and collections in HotShots, see your HotShots documentation.

Using Camera Options

Using Optional CompactFlash Cards

Removing a CompactFlash Card



Caution:

- ❑ Never remove the card while the camera is accessing it. Data in the card may be lost or damaged.
- ❑ Avoid using or storing the card in direct sunlight or in dusty, hot, or humid places.

Note:

For instructions on installing CompactFlash Cards, see page 1-1.

1. Make sure the lens cover switch is down and the camera is off.

2. Open the card and port cover on the side of the camera. Then slide the Eject Card switch on the bottom of the camera to the left to eject the card.

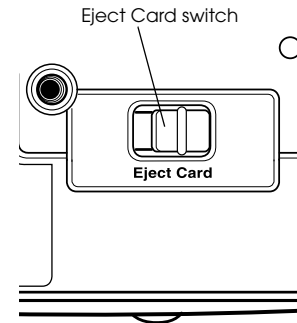

3. Remove the card, then close the card and port cover.

Formatting a CompactFlash Card

You only need to format a card if a message appears on the LCD monitor instructing you to do so. With the card installed in the camera, follow these steps.

1. Turn on the camera, slide the LCD monitor switch to PLAYBACK, then press the SELECT button. Press the ►/▲ or ◀/▼ button until the Photo Control menu appears:



2. Press the SELECT button. Erase is highlighted.
3. Press the ◀/▼ button twice to highlight Reformat, then press the SELECT button. A confirmation message appears.
4. To format the card, press the SELECT button again. The Photo Control menu appears.
5. Press BACK until you exit the menus.

Note:

If you have problems formatting or using a CompactFlash Card, contact the manufacturer for technical support.

Transferring pictures with a PCMCIA adapter

You can easily transfer pictures stored on a CompactFlash Card directly to your computer by using a PCMCIA adapter. To use this adapter, your computer must be equipped with a Type II PCMCIA card slot.

If you are using a Macintosh, see your Macintosh documentation for more information.

Follow these steps to transfer pictures with a PCMCIA adapter.

1. Remove the CompactFlash Card from your camera, as described on page 5-1.
2. Insert the card all the way into the adapter.

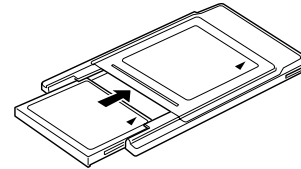

3. Insert the adapter into your computer's Type II PCMCIA slot.

- Once the adapter and card are installed in your computer's PCMCIA slot, you can transfer photos by simply copying them to your hard drive. To do so, locate the card's Photo650 folder where your photos are stored, and drag-and-drop the image files to your hard disk. See your computer documentation for more details.

Note:

Be careful not to delete the Photo650 folder on the card. If you do, you will need to reformat the card when you re-install it in the camera.

Using the Optional AC Adapter

Using the optional PhotoPC 650 AC adapter (B867**1) is highly recommended for saving battery power when you transfer your pictures via the serial cable.



Warning:

- ❑ Use only the adapter designed for the PhotoPC 650. Using any other adapter may cause fire, electrical shock, or injury.
- ❑ Do not alter the plug on the power cable, and do not use the adapter for any other purpose than powering your PhotoPC 650.
- ❑ To ensure the best performance, make sure the AC adapter is fully plugged into the camera.

Follow these steps to connect the AC adapter.

- To avoid losing any images or settings, make sure the camera is finished processing. Then turn off the camera.
- Open the connector cover on the side of the camera and plug the adapter cable into the ⬡⬢⬢ DC port.

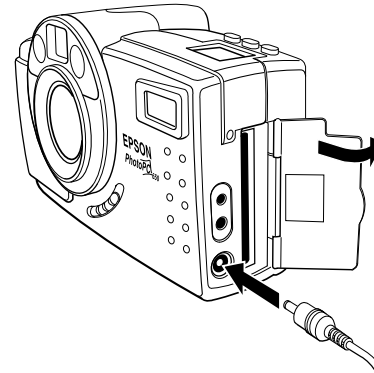

- Plug the AC adapter into an electrical outlet.

Appendix

Contacting Customer Support

If your camera is not operating properly and you cannot solve your problem using this guide, contact customer support services for assistance.

We will be able to help you more quickly if you are able to give the exact information indicated below.

Serial number of your camera

(The serial number label is on the bottom of the camera.)

Brand and model of your computer

Camera software version

(Click About on the Help menu in your application for its version number.)

Version of Windows

(for example, 95, 3.1, or NT 4.0)

Software application(s) you normally use with your camera and their version number(s)

For United Kingdom and the Republic of Ireland users

If you purchased your product in the UK or the Republic of Ireland, EPSON (UK) LTD provides a range of customer services and technical support.

Support Via the World Wide Web

- For information on the latest EPSON products, software drivers, on-line user guides and answers to frequently asked questions:

<http://www.epson.co.uk>
- To email EPSON Technical Support:

<http://www.epson.co.uk/support/email/>
- For a full list of EPSON Customer and Warranty Support services:

<http://www.epson.co.uk/support/>

Support Via Telephone

Our Customer and Warranty Support teams can be contacted by calling 0870 163 7766 in the UK or 0044 0870 163 7766 from the Republic of Ireland. They can provide the following services:

- Technical information on installing, configuring and operating your EPSON products
- Arranging for faulty EPSON products to be repaired within the warranty period

Before you call, please have the following information ready:

Product Model:

Serial number of your product:

(The serial number label is on the back of the product)

Brand and model of your computer:

Driver software version:

(Click the About button in your driver)

Operating System (for example, Windows 3.1/ 95/98, NT 3.5/4.0, Mac OS):

Software applications(s) you normally use with your product and their version numbers(s):

Pre Sales Enquiry Desk

Our Enquiry Desk team can be contacted by calling 0800 220546 in the UK or 1 800 409132 from the Republic of Ireland, by faxing 01442 227271 in the UK or 0044 1442 227271 from the Republic of Ireland, and via Email at info@epson.co.uk. They can provide the following information:

- Pre sales information and literature on new EPSON products (also available via our world wide web site at <http://www.epson.co.uk>)

- Where to purchase genuine EPSON consumables, accessories, and options

CE Marking

This product conforms to the following Directive(s) and Norm(s):

Conforms to the following Directive(s) and Norm(s):

EMC Directive 89/336/EEC:

EN 55022 Class B

EN 50082-1

IEC 801-2

IEC 801-3

IEC 801-4

Environmental

Temperature

Operating: 41 to 95 °F (5 to 35 °C)

Storage: -4 to 140 °F (-20 to 60 °C)

Humidity
(non-
condensing)

Operating: 30 to 80%

Storage: 10 to 80%

EPSON®