

EPSON®

M M PROJECTOR
ULTI EDIA

EMP-71/51

Instruction Manual

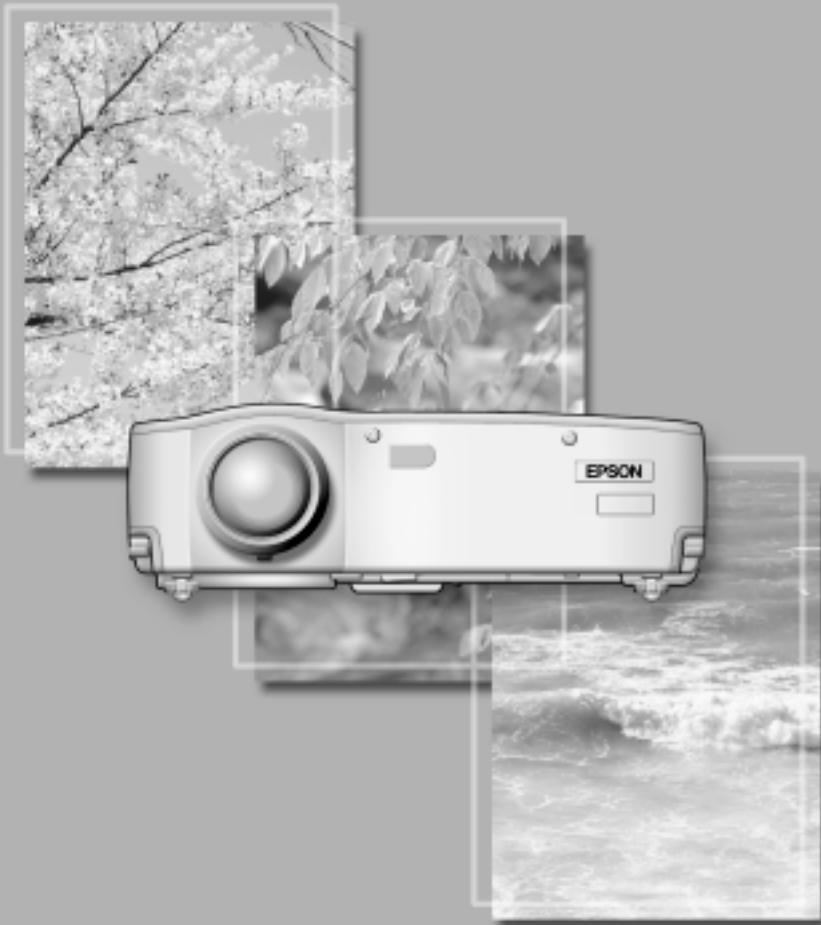

Checking Accessories

When unpacking the projector and accessories from their box, check that the following items are included.

If any of the components are missing or incorrect, please contact the place of purchase.

- Projector
- Lens cover with cord

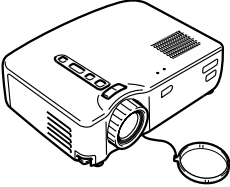

- Remote control

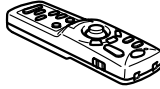

- Two manganese dry cells for the remote control



- Power cord (9.8 ft (3 m))



- Computer cable (6 ft (1.8 m))

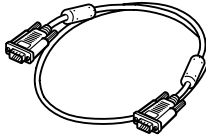

- Audio/Video (A/V) cable (red/white/yellow) (6ft (1.8 m))

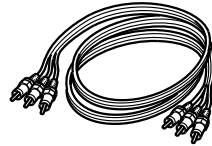

- USB mouse cable (6 ft (1.8 m))

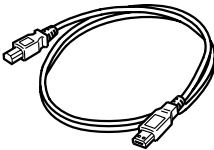

- PS/2 mouse cable (6 ft (1.8 m))

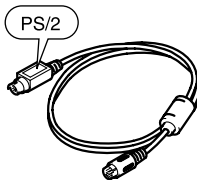

- Safety Instructions/World-Wide Warranty Terms
- Instruction Manual (this manual)
- Quick Reference Guide

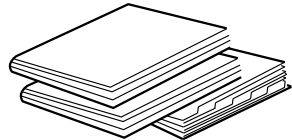

- Soft case



In This Manual

Getting Started

Name and function of each part and of the remote control operation

Setup

Special notes on setup, setup instructions, and screen size and projection distance details

Projecting Images

Connecting with different devices and projecting and adjusting images

What You Can Do

Functions to get the most out of your projector

Menu Functions (Remote Control Only)

Basic menu functions and settings

Troubleshooting

Troubleshooting projection failure, bad projection, and other problems

Maintenance

Performing lamp replacement and other routine maintenance and care

General Notes

Optional parts, glossary, index, specifications

Contents

In This Manual	1
Features.....	4
About The Manuals and Notations Used	6
Getting Started	
Part Names and Functions	8
Remote Control.....	11
Setup	
Special Notes on Setup	14
Setup Instructions	15
Screen Size and Projection Distance Details	16
Projecting Images	
Connecting to a Computer	18
Connecting to an A/V Device	21
Providing Sound Through an External Audio Device	23
Projecting Images	24
Adjusting Images	28
Ending After the Projection	31
What You Can Do	
Using the Wireless Mouse	34
Enlarging an Image.....	36
Adjusting Image Size	37
Adding Image Effects.....	38
Freezing and Deleting Images	39
Displaying Help Screens.....	40

Menu Functions (Remote Control Only)

Learning Basic Operations.....	42
Video Menu	43
Audio Menu	45
Effect Menu	46
Setting Menu	47
Advanced Menu	49
About Menu.....	50
Reset All Menu.....	51

Troubleshooting

Possible Failures	54
When Indicators Do Not Help.....	57

Maintenance

Projector Cleaning, Lens Replacement, Air Inlet Cleaning.....	64
Lamp Replacement.....	66

General Notes

Optional Accessories	70
Glossary.....	71
Specifications.....	73
External Dimensions	75
Index	76

Features

Compact and Lightweight

The compact, lightweight design of your projector (6.6 liters and roughly 3.1 kilograms (6.83 pounds)) allows easy carrying.

Clear, Sharp Images

Though compact, your projector provides clear, sharp presentations even in well-illuminated areas.

Global Video Signal Compatibility

Your unit projects virtually all of the video signal formats used world-wide, including NTSC, NTSC4.43, PAL, M-PAL, N-PAL, PAL60, and SECAM.

Improved Video Image Clarity

Projection of distinct video images from composite video and S-video input is possible.

"Keystone" Correction Function (See pages 29 and 47)

This built-in function allows easy correction of trapezoidal distortion caused by projection angle.

Wireless Mouse Remote Control for Computer Mouse Operations (See page 34)

The remote control allows wireless operation of various projector functions, including cursor/stamp, horizontal bar display, and image enlargement and reduction.

Presentation Effects Function (Remote control Effect button, See page 38)

Use of the remote control Effect button creates effective presentations.

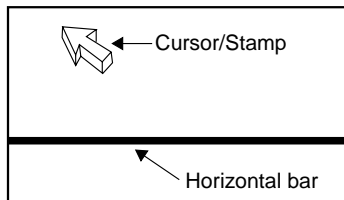

E-Zoom Function (Remote control E-Zoom button, See page 36)

Enlarges an image (from standard to 4x size vertically and horizontally).

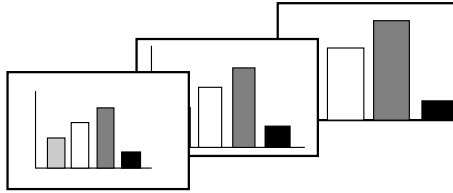

Automatic image sizing with Wide/Tele button (See page 37)

Allows image enlargement and reduction.

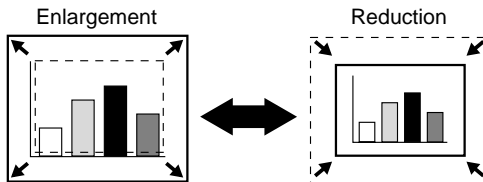

About The Manuals and Notations Used

Types of Manual

The documentation for your EPSON projector is divided into the following three manuals. The manuals cover the following topics.

- **Safety Instructions/World-Wide Warranty Terms**
This manual contains information on using the projector safely, and also includes World-Wide Warranty Terms and a Troubleshooting check sheet. Be sure to read this manual thoroughly before using the projector.
- **Instruction Manual (this manual)**
This Instruction Manual contains information on installing the projector, basic operation, using the projector menus, troubleshooting and maintenance.
- **Quick Reference Guide**
Contains an overview of the most commonly-used projector functions for easy reference. You should keep this Quick Reference Guide near the projector at all times and refer to it before starting presentations and while using the projector in order to check details of operation.

General information

Warning: Indicates procedures which may result in death or serious injury if sufficient care is not taken.

Caution: Indicates procedures which may result in damage or injury if sufficient care is not taken.

Tip: Indicates additional information and points which may be useful to know regarding a topic.

_____* Indicates that an explanation of the underlined word or words in front of this symbol appears in the Glossary of Terms.
Refer to the Glossary in the General Notes. (See page 71)

Meaning of "unit" and "this product"

When "unit" or "this product" appears in the text of this Instruction Manual, they may refer to items which are accessories or optional equipment in addition to the main projector unit itself.

Getting Started

Part Names and Functions	8
Remote Control.....	11

Part Names and Functions

Projector Unit

[Front]

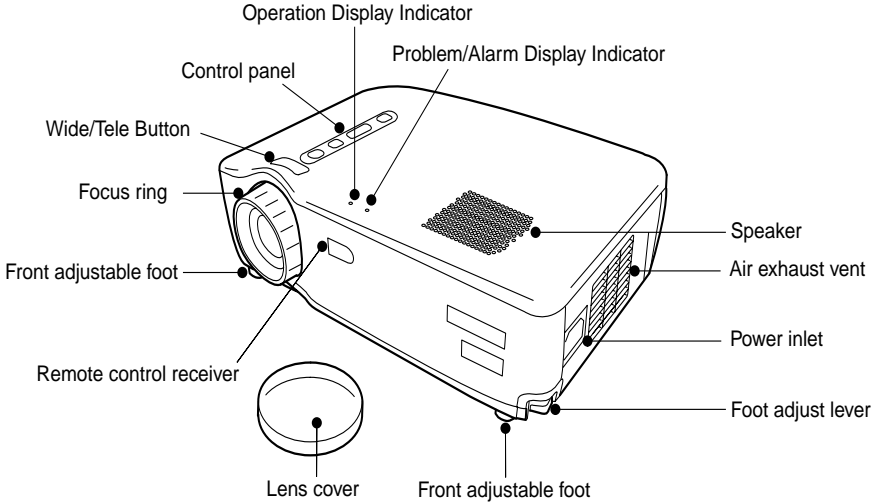

[Side]

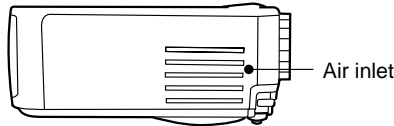

[Rear]

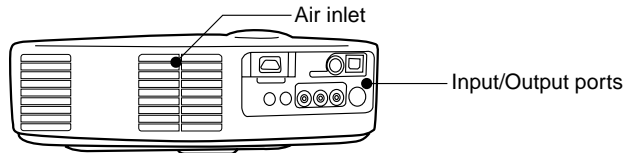

[Bottom]

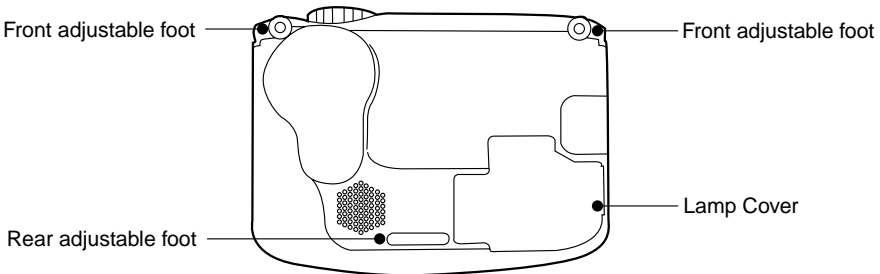

[Wide/Tele Button (See page 37)]

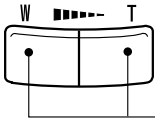

Press the T side (Tele) of the button to reduce the image size.
Press the W side (Wide) of the button to enlarge the image size.

[Control Panel]

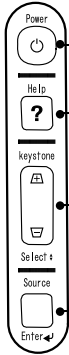

Power Button (See pages 25, 31)

Switches power on and off.
*Press twice to turn the power off.

Help Button (See page 40)

Displays help screen.

Keystone (Select) Button (See pages 29, 40)

Adjust when screen is distorted trapezoidally.

When the help menu is displayed, functions as a "Select" button for menu items.

Source (Enter) Button (See page 26, 40)

Toggles the video source between Computer, S-Video, and Composite video.
When the help menu is displayed, functions as a "Enter" button.

[Input/Output Ports]

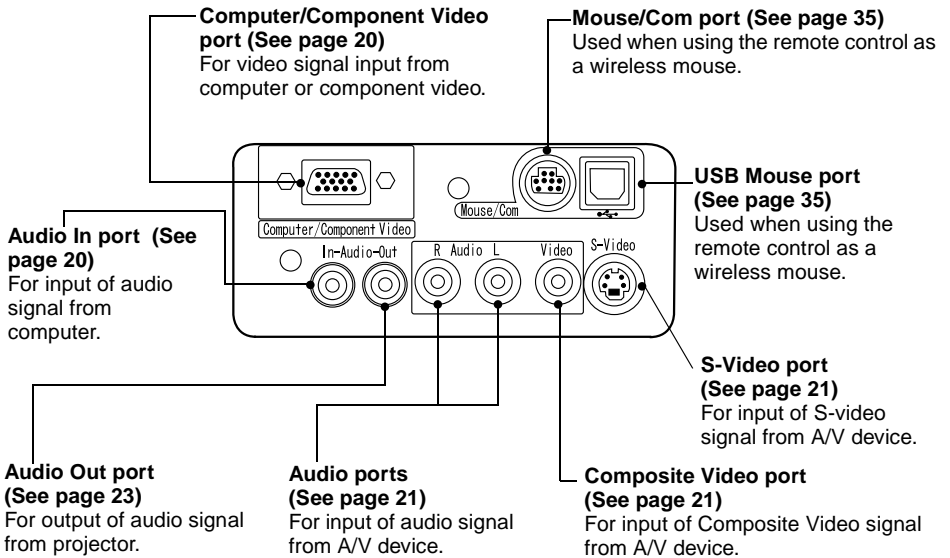

Remote Control

[Front]

Freeze Button (See page 39)

Temporarily stops a moving picture. To release the freeze, press the button again.

A/V Mute Button (See page 39)

Temporarily eliminates picture and sound. To release muting, press the button again or adjust the volume.

Effect Button (See page 38)

Executes an assigned effect function.

Esc Button (See page 34, 42)

To terminate an activated function, or right-click function when using as a wireless mouse.

Menu Button (See page 42)

Displays or cancels menus.

Auto Button (See page 30)

Optimizes computer video.

Volume Button (See page 30)

Adjusts volume.

Indicator

Lights during signal output from remote control.

Power Button (See page 25, 31)

Switches projector power on and off. *Press twice to turn the power off.

R/C switch (See pages 25, 32)

Switches remote control power on and off.

E-Zoom Button (See page 36)

Executes the E-Zoom function.

Enter Button

Used for scrolling, menu item selection, and as the left mouse button.

Help Button (See page 40)

Provides topic-specific explanation for addressing problems. Use this button when problems occur.

Computer, S-Video, Video Button (See page 26)

Switches to the selected video source.

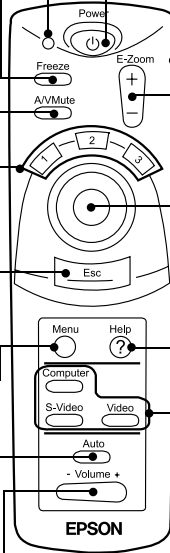

[Back]

Battery Cover

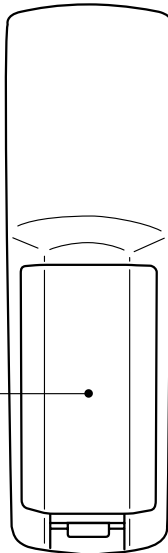

Remote Control

Operating Range

The remote control may not operate beyond certain distances and angles from the receiver on the projector. Observe the following conditions during use.

[Operating Distance : Approximately 393.70inches (10m)]

[Operating Area:]

Horizontally

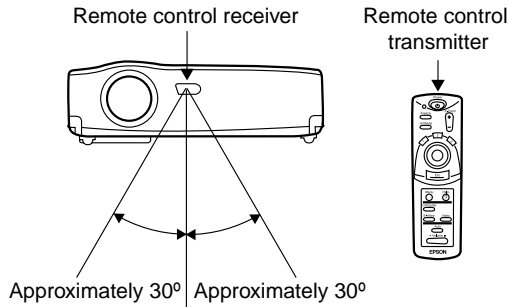

Vertically

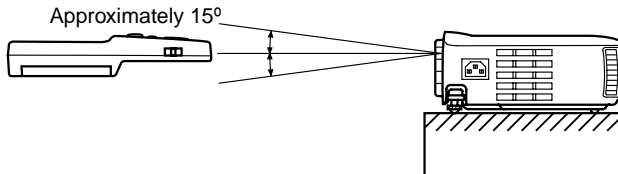

Tip:

- The remote control R/C switch must be switched to "On" to use the remote control.
- Point the remote control towards the remote control receiver on the projector unit.
- Certain screens may shorten the operating distance (approximately 393.70inches (10m)) of the remote control when the control is pointed towards the screen to reflect its signal during use.
- Situate the remote control receiver out of direct sunlight, fluorescent light, and similar light sources.
These may cause the remote control to malfunction.
- If the remote control malfunctions or stops operating, the batteries may need changing.
Replace the batteries with a fresh set.

Inserting Batteries in the Remote Control

This section describes how to insert batteries in your remote control.

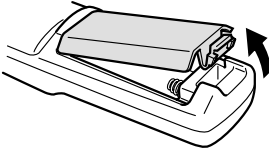

1. Remove the battery cover.
Slide the catch of the battery cover in the direction shown by the arrow.

Tip:

Be sure to use fresh batteries of the same type as the old.

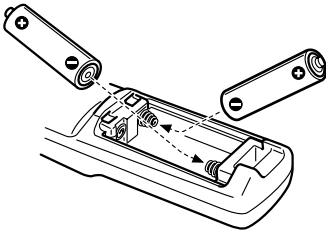

2. Insert batteries.
Be sure to match the polarity to that indicated on the remote control.

Tip:

- *Battery type*
Two manganese dry cells R6 (AA)
- *Use of 30 minutes per day will require a change of batteries approximately every 3 months.*

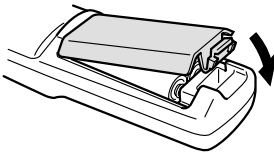

3. Replace the battery cover.
Press the battery cover into the remote control until it clicks firmly into place.

Setup

Special Notes on Setup	14
Setup Instructions	15
Screen Size and Projection Distance Details	16

Special Notes on Setup

The best picture is obtained when the projector and screen are set up facing each other directly, as shown below. Set your projector and screen up this way.

[View from right or left]

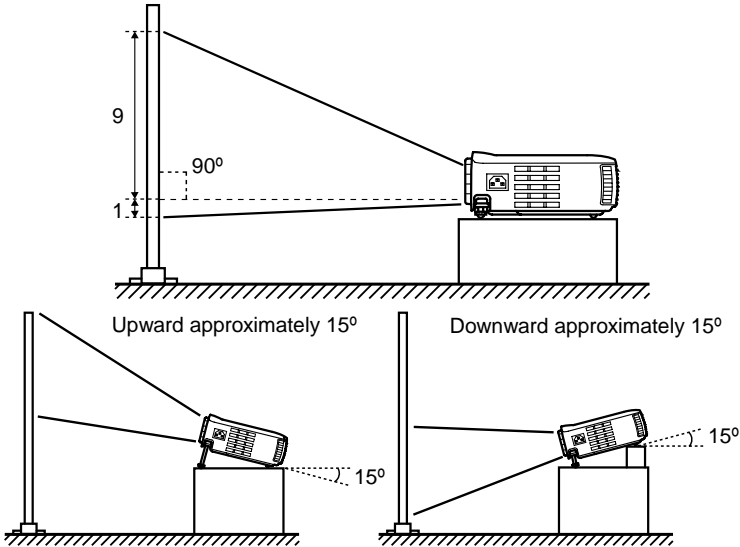

Keystone correction allows correction of trapezoidal distortion (See pages 29, 47).

[View from above or below]

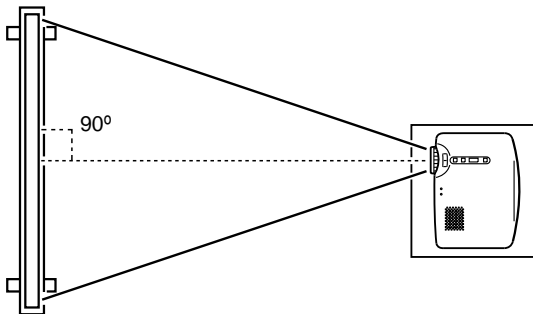

Caution:

- Do not block the air exhaust vent on the side of the projector or the air inlets on the right side and rear of the projector.
- Do not place the unit in direct contact with air conditioner, heater, or other ventilation currents.
- When setting up the projector near walls, allow at least 7.87inches (20cm) from all walls.

Setup Instructions

Your projector allows projection in the following two ways. Set up the projector as your location requires.

[Viewing from the front]

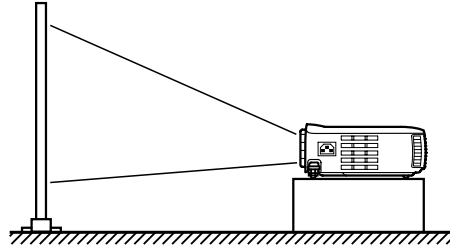
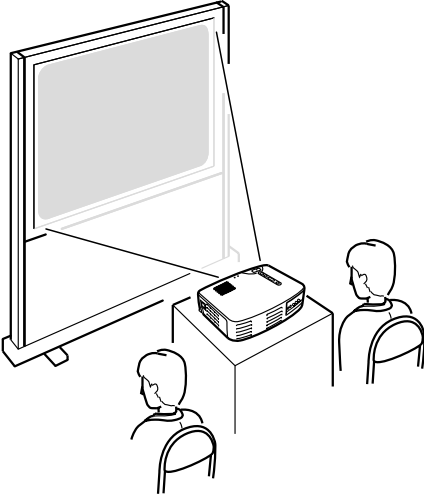

[Projection on a semi-transparent screen and viewing from the rear]

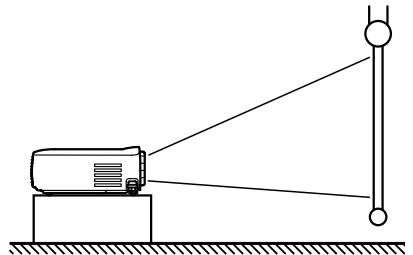
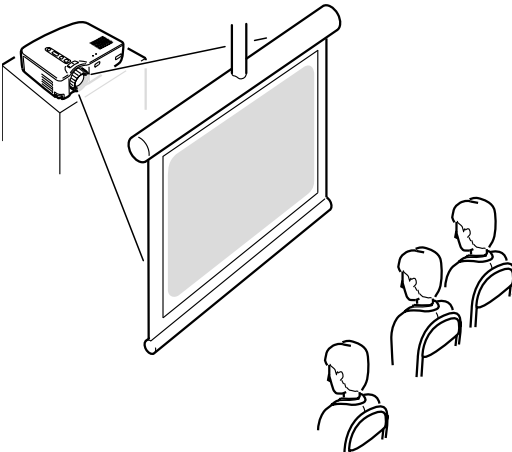

Screen Size and Projection Distance Details

Select a distance from lens to screen that provides your desired screen size. The recommended distance is 39.37inches (1.0 m)—515.75inches (13.1 m). Refer to the following table for setup.

Screen size (inch (cm))	Approximate projection distance* (inch (m))
300" (240.16x181.1 (610x460))	433.07—515.75 (11.0—13.1)
200" (161.42x118.11 (410x300))	287.4—342.52 (7.3—8.7)
150" (120.08x89.76 (305x228))	216.54—255.91 (5.5—6.5)
120" (96.06x72.05 (244x183))	173.23—208.66 (4.4—5.3)
100" (78.74x59.06 (200x150))	145.67—169.29 (3.7—4.3)
80" (62.99x47.24 (160x120))	114.17—133.86 (2.9—3.4)
60" (47.24x35.43 (120x90))	86.61—102.36 (2.2—2.6)
40" (31.89x24.02 (81x61))	59.06—66.93 (1.5—1.7)
30" (24.02x18.11 (61x46))	43.31—47.24 (1.1—1.2)
28" (22.44x16.93 (57x43))	39.37—43.31 (1.0—1.1)

* Use the "approximate projection distance" as a guide to setup. Projection conditions and other factors can affect results.

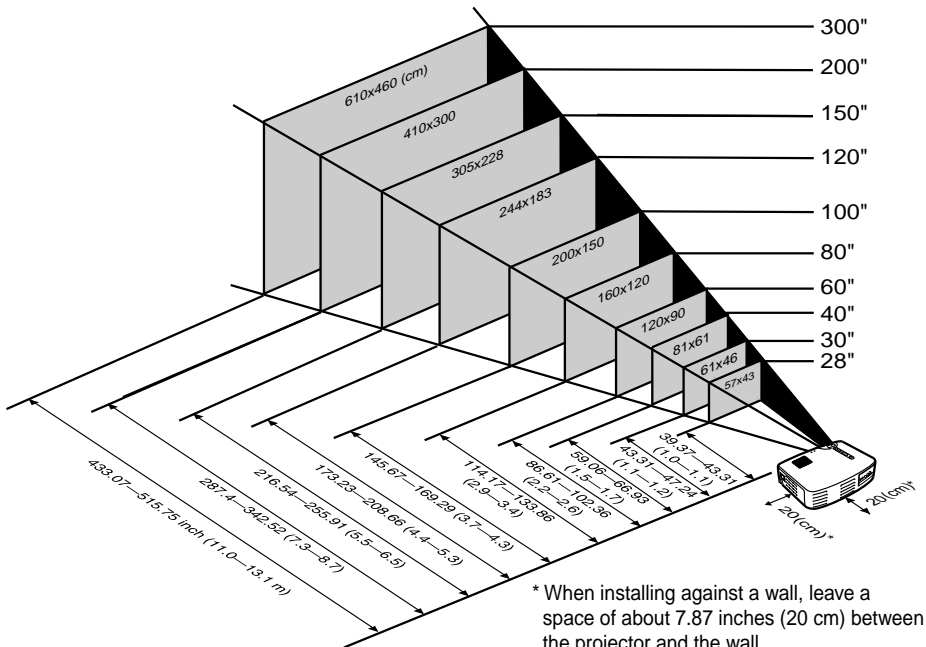

* When installing against a wall, leave a space of about 7.87 inches (20 cm) between the projector and the wall.

Tip:

A keystone correction will reduce screen size.

Projecting Images

Connecting to a Computer.....	18
Connecting to an A/V Device.....	21
Providing Sound Through an External Audio Device.....	23
Projecting Images	24
Adjusting Images.....	28
Ending After the Projection.....	31

Connecting to a Computer

Computers which can be connected

Some computer models may not allow connection, and others may allow connection but not projection.

Make sure that the specifications of the computer you are using for connection meet the following two requirements.

[The computer must have a video signal output port]

Make sure that the computer has a port that outputs a video signal.

A port that outputs a video signal is called an "RGB port", "monitor port", or "video port" or the like.

Consult the section describing "connection to an external monitor" or the like in the instruction manual for the computer that you are using, and make sure that the computer has a video signal output port.

Computers with an integrated monitor and other components as well as laptop computers may require separate purchase of an external output port.

In other cases, an external output port cannot be attached.

[The resolution and frequency of the computer must be within the range of specifications shown on the following page]

The resolution and frequency of the video signal output by your computer must be compatible with your projector in order to allow projection (some computers allow partial projection, but clear projection cannot be obtained).

Check the resolution and frequency of the video signal in the instruction manual of the computer you are using for projection.

Compatible Mode Chart for Connectable Computers

If the resolution and frequency of the video signals which are output from the computer do not correspond to any of the values in the table below, those video signals cannot be projected. (In some cases it may be possible to project such signals, but they will not produce clear images.)

Check the instruction manual for the computer for details on the resolution and frequency of the video signals.

Furthermore, some computers may let you change the output resolution. If this is the case, change the resolution to a value in the table below.

Signal (Resolution) (dots)	Signal	Refresh rate (Hz)	Frequency used for resized displays (when resizing is on) (dots)		
			EMP-71	EMP-51	
PC (RGB) compatible modes	640 x 350	VGAEGA	60	1024 x 560	800 x 437
	640 x 400	VGACGA	60	1024 x 640	800 x 500
	720 x 400	<u>VGA</u> * Text	70	1024 x 568	800 x 444
	720 x 350	VGA Text	70	1024 x 497	800 x 388
	640 x 480	VESA	60/72/75/85	1024 x 768	800 x 600
	800 x 600	<u>SVGA</u> *	56/60/72/75/85	1024 x 768	800 x 600
	1024 x 768	<u>XGA</u> *	43i/60/70/75/85	1024 x 768	800 x 600
	1152 x 864	<u>SXGA</u> *1	70/75/85	1024 x 768	-
	1280 x 960	SXGA2	60/75/85	1024 x 768	-
	1280 x 1024	SXGA3	43i/60/75/85	960 x 768	-
	640 x 480	MAC13	66	1024 x 768	800 x 600
	832 x 624	MAC16	75	1024 x 768	800 x 600
	1024 x 768	MAC19	60/75	1024 x 768	800 x 600
	1152 x 870	MAC21	75	1024 x 768	800 x 600
PC (YUV) compatible modes	-	HDTV525I	50/60	1024 x 768	800 x 600
	-	HDTV525P	50/60	1024 x 768	800 x 600
	1280 x 720	HDTV750P	50/60	1024 x 576	800 x 450
	1920 x 1080	HDTV1125I	50/60	1024 x 576	800 x 450
Video compatible modes	-	NTSC	60	1024 x 768	800 x 600
	-	PAL	50	1024 x 768	800 x 600
	-	SECAM	50	1024 x 768	800 x 600

Connecting to a Computer

Tip:

- Before connecting, switch off power to the projector and computer.
- Check that cable and port interfaces match each other.

[Projecting Computer Video]

You can make presentations on a large screen by projecting computer video from your projector.

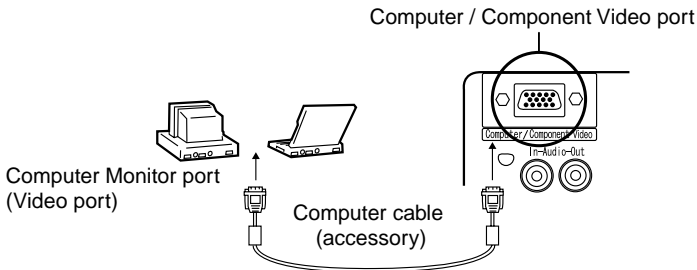

* If your computer port style is not a mini D-Sub 15-pin interface, use a connection adapter that provides this interface.

When connecting to a Macintosh, you may need to use the optional Mac adapter.

Tip:

- When connected do not bind the power cord and the computer cable together.
- Some computer models may require a connection adapter during connection. Consult your computer instruction manual or the computer vendor.

[Outputting Computer Audio From Your Projector]

You can output computer audio from the built-in speaker in your projector. Your projector allows output at a maximum 1W.

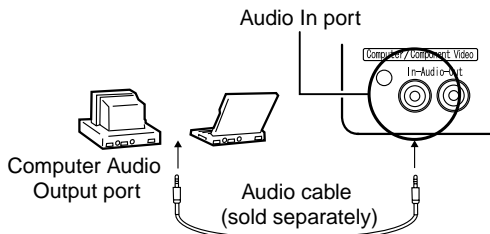

Tip:

- When computer video has been selected or when audio input is specified on the computer by menu, your projector outputs an audio signal from the computer.
- Purchase an audio cable that matches the port style of your computer's output port and the projector's Audio In port (stereo mini jack).

Connecting to an A/V Device

[Inputting a Composite Video Signal]

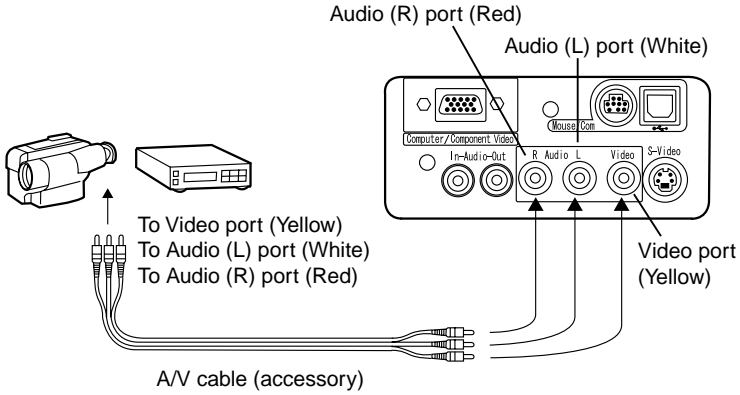

[Inputting an S-Video Signal]

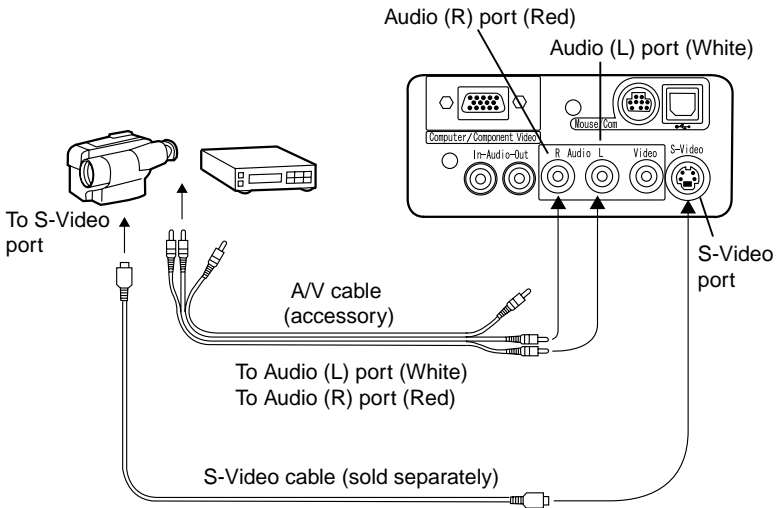

[Inputting a Component Video Image Signal]

If using a component video cable

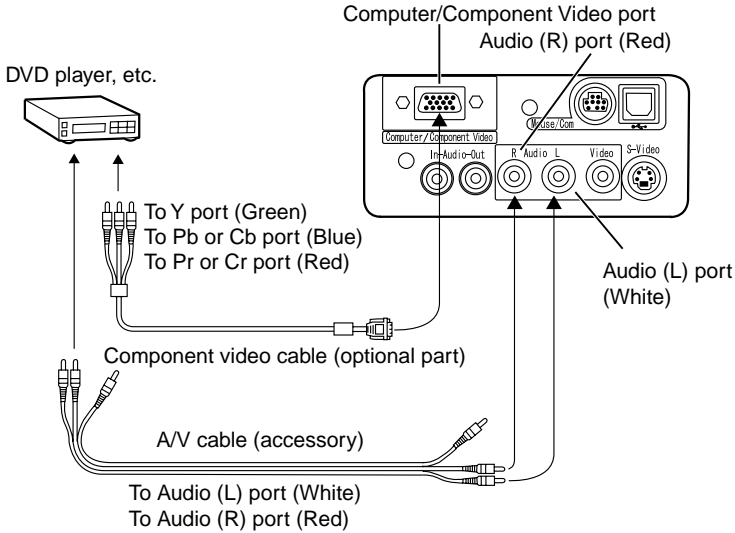

Tip:

- When projecting a component video image, select "YCbCr" or "YPbPr" in the Video > Input Signal menu.
Select "YCbCr" if using a DVD player, and select "YPbPr" if using a HDTV video source.
- To change the aspect ratio of the projected image between 4:3 and 16:9, select Video > Aspect Ratio menu.

Providing Sound Through an External Audio Device

Connecting the Audio Out port of your projector to a PA system, active speaker system, or other speakers with built-in amplifiers provides powerful, pleasing sound.

Use a separately sold audio connection cable (pin ring) connecting to a 0.14inches (3.5mm) stereo mini-jack plug.

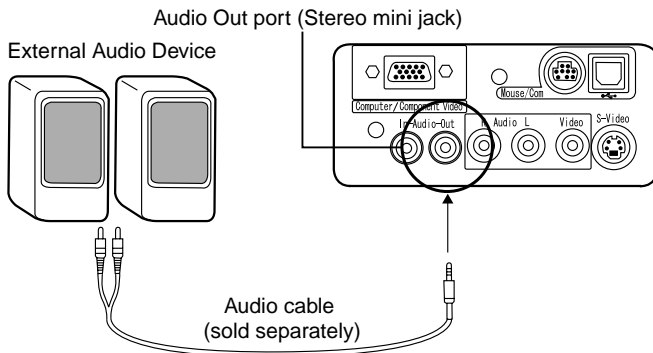

Tip:

- When a cable is connected at the Audio Out port the sound output will be switched from the built-in speaker to external sound output.
- Though the projector outputs audio for projected video images, in the case of A/V devices, the audio output corresponds to the audio devices connected to the Audio ports.
- Before purchasing an audio connection cable, thoroughly check the connection interface style of the external audio devices you are connecting.

Projecting Images

Here we begin projecting images from an A/V device.

Preparation

Warning:

- *Never look into the lens when the projector is switched on. The intense light can damage your vision.*
- *Use only the power cord supplied. Use of other cables may cause fire or electric shock.*

Caution:

Do not attempt projection with the lens cover in place. Heat may deform the lens cover.

- 1.** Check that the projector and computer or A/V device are connected.
- 2.** Remove the lens cover.
- 3.** Attach the power cord (accessory) to the projector.
Align the power cord connector with the power inlet on the projector and insert the connector firmly and completely into the inlet.
- 4.** Insert the plug end of the power cord in an outlet. The operation display indicator will light with an orange color.

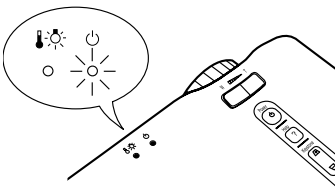
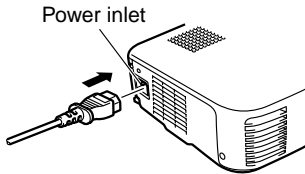

Tip:

Buttons cannot be operated while the operation display indicator is flashing orange.

Projection

When preparations are complete, you are ready for projection.

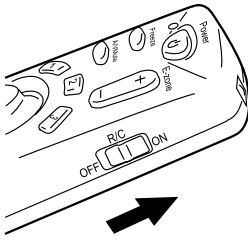

1. To use the remote control, turn the remote control R/C switch to "On".

2. Press the Power button to switch power on. The operation display indicator begins to flash green, and projection begins.

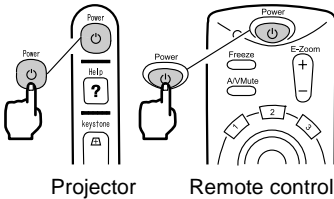

"No-Signal" is displayed.
Depending on your settings, there may be no display.
(See page 47)

After approximately 30 seconds, the operation display indicator changes from flashing green to steady green.

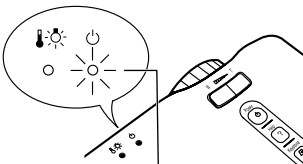

The operation display indicator lights green.

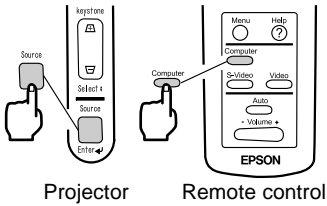

- 3.** Press the Source button on the projector or the Computer, S-Video or Video button on the remote control to select the video source you wish to project.

Each time the Source button on the projector is pressed, the video source cycles between Computer, S-Video and Video.

If there is no input at the S-Video port, the Source button switches the video source from Computer to Video.

Tip:

If projecting a component video picture, change the setting to Computer.

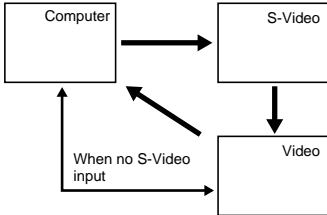

- 4.** Switch on power to the computer or A/V device to begin projection. The "No-Signal" display disappears, and a video signal from the computer or A/V device is projected.

Tip:

- *If the "No-Signal" display remains, check the connections again.*
- *If the same static image is projected for some time, the video projection may contain an afterimage.*

[Settings for laptop and integrated LCD computers (when connected)]

When a laptop or integrated LCD computer is connected to the projector, some computers require key commands or settings to change the output destination of a video signal.

Keep "Fn" depressed while pressing "F0" to change the setting.

For details, consult the instruction manual of the computer you are using.

Manufacturer	Output Switching Example
NEC	"Fn"+"F3"
Panasonic	"Fn"+"F3"
Toshiba	"Fn"+"F5"
IBM	"Fn"+"F7"
SONY	"Fn"+"F7"
Fujitsu	"Fn"+"F10"
Macintosh	After restarting, the monitoring and sound on the control panel are set to mirror the computer.

Tip:

Some computers may not be able to have images displayed on the computer screen at the same time as they are being projected. In such cases, use only external output.

Adjusting Images

This section describes how to obtain the best video performance. See "Setup" (page 13) for details on setting-up position and projection size.

Adjusting the Image Projection Angle

Adjust the projection angle of the projector.
Adjust the projector to face the screen as directly as possible.

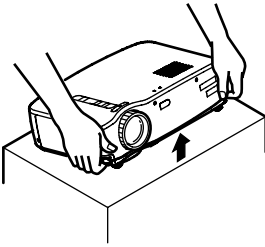

1. Lift the projector to your desired angle of projection.

Foot adjust levers

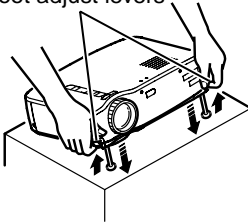

2. Use your fingers to pull up the foot adjust levers.
Front adjustable feet emerge.

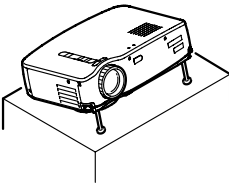

3. Release the foot adjust levers.

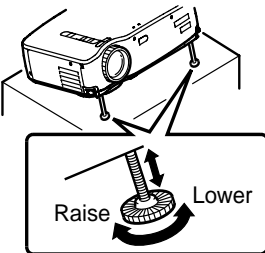

4. Make fine adjustments to the height.
Turn the lower portion of the front adjustable feet to make fine adjustments to height.

Tip:

Setting back the front adjustable feet (See page 32)

Adjusting the Focus

This section describes how to adjust the video focus.

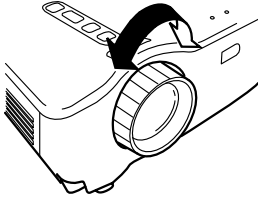

1. Turn the focus ring on the projector to adjust the focus.

Tip:

- Focus cannot be achieved if the lens is dirty or covered with condensation. Wipe off any dirt or condensation (See page 64).
- If adjustment does not succeed, make sure the setup distance is between 39.37inches (1.0m) and 515.75inches (13.1m).

Keystone Correction (Using Projector Button)

When the foot adjust levers are used to change the projection angle, the keystone correction function can be used to correct trapezoidal distortion upward or downward by roughly 15°.

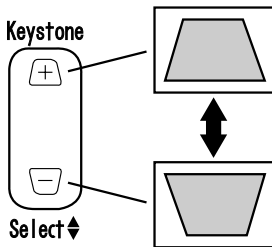

1. Press the Keystone button on the projector to minimize the trapezoidal distortion.

Tip:

- A keystone correction reduces screen size.
- The keystone correction is stored in memory. You will need to readjust the image if the projector is moved to a different location or the projection angle is changed.
- If a keystone correction makes the image noticeably uneven, reduce the video sharpness with the menu commands Video > Sharpness (See page 44).

Adjusting Images (Remote Control Only)

[Optimizing Computer Video (Using the Auto button)]

This function applies automatically optimized adjustment values to a computer input signal.

If the input is a video signal, this function does not operate.

Adjusted values set automatically are "Tracking", "Position (vertical and horizontal)", and "Sync".

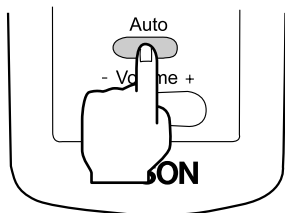

Tip:

- This function cannot optimize the adjustment for some signal types. In these cases, use the Video Menu commands to perform adjustment (See page 43).
- When functions such as E-Zoom or A/V muting are engaged, these functions being used will be canceled before automatic adjustment is carried out.

[Opening a Menu For Adjustment]

Press the Menu button and perform adjustment using the Video Menu.

For details, refer to "Menu Functions (Remote Control Only)" (See page 41).

Adjusting the Volume (Remote Control Only)

Press the Volume +, - button to adjust the volume to an easily audible listening level.

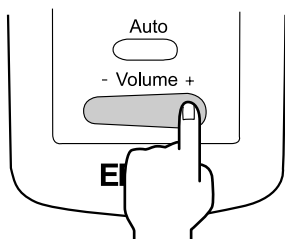

Tip:

Adjustment is not available if there is no audio signal.

Ending After the Projection

Ending

1. Press the Power button. A "Power Off" confirmation message is displayed.

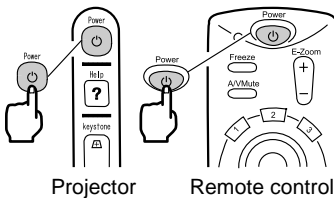
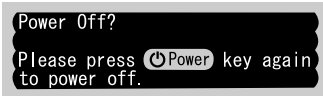

2. Press the Power button again. The projector lamp goes out, the operation display indicator flashes orange, and after cool-down* is complete, the indicator switches to steady orange.

Tip:

If you do not wish to shut the power, press another button.

Or, if no action is taken, the message disappears after 7 seconds.

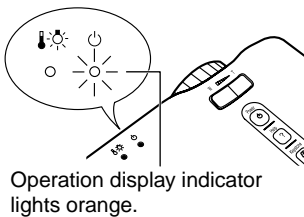

3. Check that the operation display indicator lights orange.

Tip:

- *The flashing orange operation display indicator indicates that cool-down (which takes about 2 minutes) is in progress. Buttons cannot be operated during cool-down.*
- *If the power cord plug is pulled out of the outlet, the operation display indicator will go out.*

4. Pull the power cord plug out of the outlet.

Caution:

Do not pull the power cord plug out of the outlet while the operation display indicator is flashing orange. This may cause a malfunction or shorten the projector lamp life.

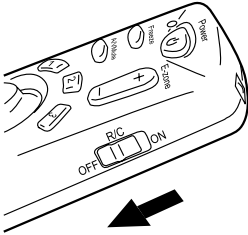

5. Set the remote control R/C switch to Off.

Tip:

Unless the remote control R/C switch is switched off, a small amount of current will be supplied to the remote control and exhaust the batteries. If the remote control will not be used for a long period or you are moving the unit, set the remote control R/C switch to Off.

Storage

When you are finished projecting, retract the front adjustable feet into the unit.

Foot adjust levers

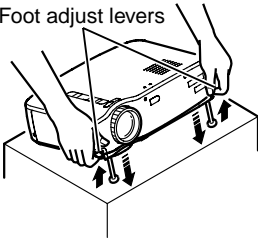

1. Support the projector unit with your hands, pull upward on the foot adjust levers with your fingers, and lower the unit slowly.

2. Attach the lens cover.

What You Can Do

Using the Wireless Mouse	34
Enlarging an Image.....	36
Adjusting Image Size.....	37
Adding Image Effects	38
Freezing and Deleting Images	39
Displaying Help Screens	40

Using the Wireless Mouse

The remote control included allows you to control a computer's mouse operations at a separate location.

The Enter button has the same action as a left mouse button, and the Esc button has the same action as a right mouse button.

Mouse operation by remote control allows you to make a presentation at the screen without assistance.

Presenter

Unassisted presentation is possible

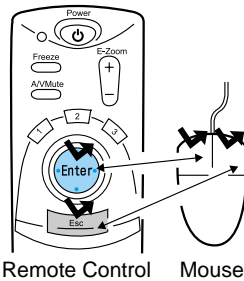
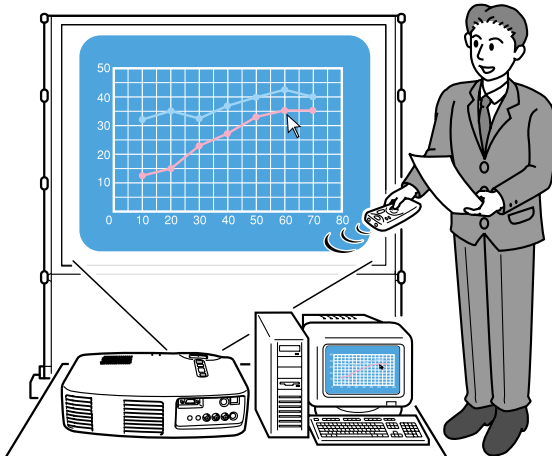

Remote Control

Mouse

Tip:

• If mouse button functions are swapped on your computer, the functions on the remote control also change as follows.

Esc Button: Left mouse button

Enter Button: Right mouse button

• This function cannot be used while an Effect Function, E-Zoom function, menu function, or Help function is in use.

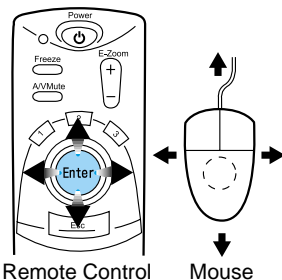

Remote Control

Mouse

Making a Connection

Before making a connection, switch off power to the projector and computer.

Caution:

- Connecting a non-USB mouse cable with the power on can cause malfunction or failure.
- Use only the mouse cable supplied. Any other cable may cause failure.

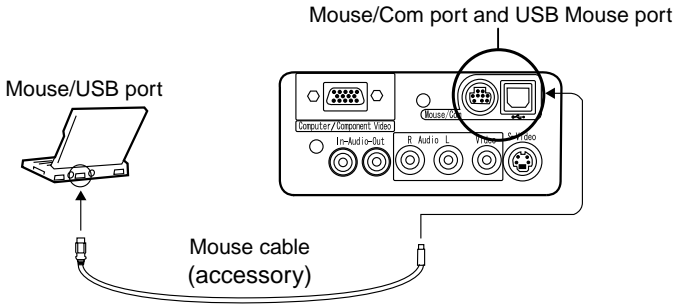

Computer	Mouse Cable	Connection Method
IBM PC/AT Compatible (DOS/V Machine)	PS/2 Mouse Cable	Connect the computer mouse port and the projector Mouse/Com port.
Computer for <u>USB</u> * Mouse	USB Mouse Cable	Connect the computer USB port and the projector USB mouse port.

When using a USB mouse, note the following.

- Windows

The only compatible models are those pre-installed with the standard USB interface configuration in Windows2000/Me and Windows98.

If the computer is running a version of Windows 98/2000/Me that has been upgraded from an earlier version of Windows, correct operation cannot be guaranteed.

- Macintosh

Compatible with OS 8.6 – 9.1.

* The USB mouse port is only compatible for a USB mouse, it is not compatible with other USB devices.

Enlarging an Image

The remote control included lets you enlarge portions of an image.

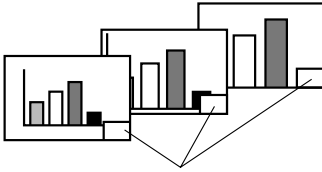
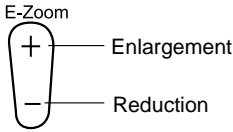

Magnification factor is displayed.

1. Press the E-Zoom button on the remote control to enlarge or reduce the display on screen.
(The Esc button releases this feature.)

Tip:

24-step partial enlargement and reduction by factors of 1x-4x is available.

2. Tilt the Enter button up, down, left or right to scroll the projected image in that direction.

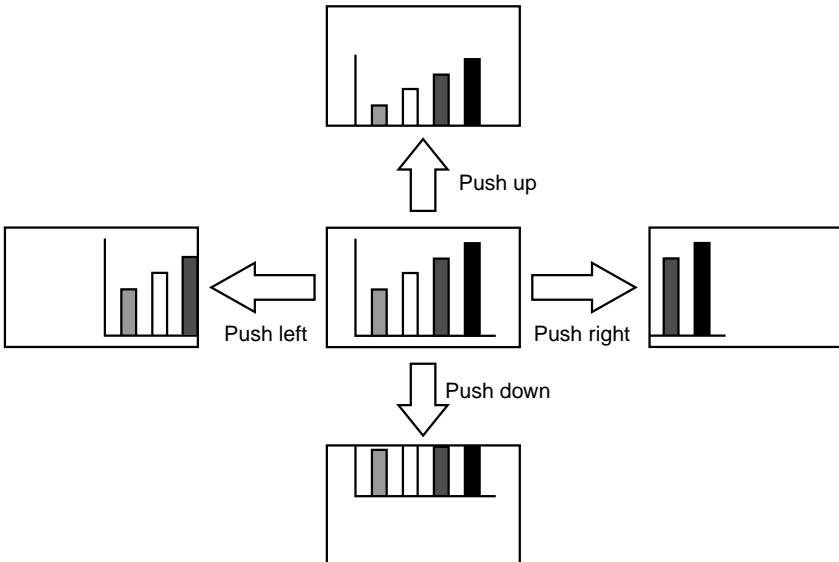

Adjusting Image Size

The Wide/Tele button on the projector allows you to adjust the size of images.

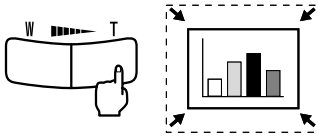

1. When you press the T (Tele) side of the button, the images are reduced.

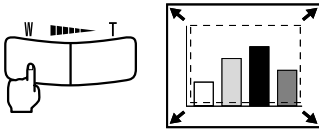

2. When you press the W (Wide) side of the button, images are enlarged.

Tip:

- The enlargement/reduction ratio for adjustment with the Wide/Tele button is 0.8 – 1.0 in 32 steps.
- This function is active until the Reset All menu is executed (See page 51).

Adding Image Effects

Using the Effect1 and Effect2 buttons, you can add effects to images during presentation (to cancel this function, press the Esc button). For effects settings, see "Effect Menu" (page 46).

Cursor/Stamp

This effect displays a cursor on the screen and freezes it at a desired location.

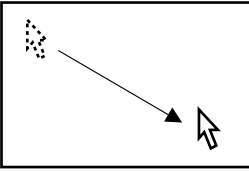

1. Press the Effect1 button to display a cursor.
2. Tilt the Enter button to move the cursor to a desired position.
3. Press the Enter button, and the cursor position is displayed as a stamp.

Tip:

- Activate the horizontal bar to remove the cursor/stamp display.
- To remove the stamp, press the Effect3 button.

Horizontal Bar

This effect displays a horizontal line on the screen and allows you to move it up or down by remote control.

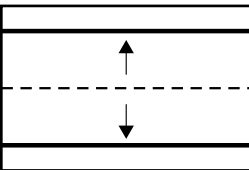

1. Press the Effect2 button to display a horizontal bar.
2. Tilt the Enter button up or down to move the horizontal bar up or down.

Tip:

- To remove the horizontal bar, activate the cursor/stamp.

Freezing and Deleting Images

Freezing a Moving Image (Remote Control Only)

You can freeze a moving image (video or other image).

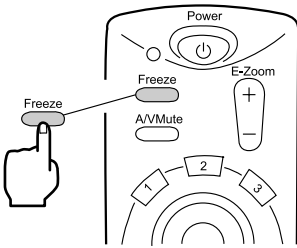

1. Press the Freeze button on the remote control.
(To release the freeze, press the Freeze button again.)

Muting Images and Sound (Remote Control Only)

You can temporarily mute images and sound and project a black or blue image.

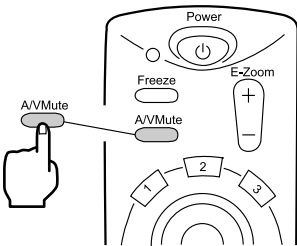

1. Press the A/V Mute button on the remote control.
(To cancel the muting feature, press the A/V Mute button or another button.)

Tip:

Using the Setting > A/V Mute menu, you can change the color (black, blue) of the image projected when audio and video have been muted (See page 48).

Displaying Help Screens

You can display topic-specific help on screen for solving problems. Use this function when problems occur.

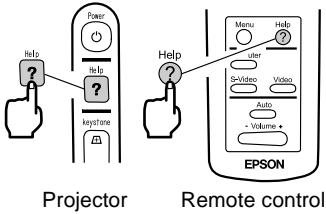

1. Press the Help button to start the help function.
(Press the Help button again to cancel this function.)

Tip:

If you cannot solve your problem using the Help function, consult the "Troubleshooting" section in this manual (See page 53).

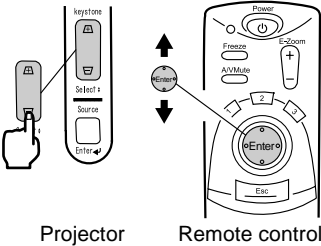

2. Tilt the Select button on the projector up or down to select a topic (on the remote control, tilt the Enter button up or down).

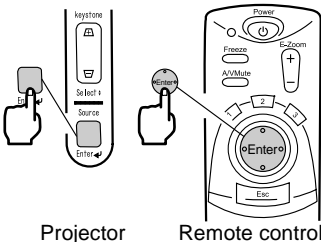
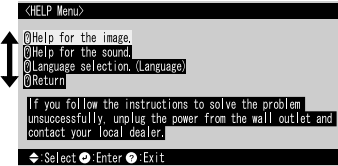

3. Press the Enter button to enter your selection.
4. Select a detailed topic as described in steps 2 and 3 and follow the instructions displayed.

Menu Functions

(Remote Control Only)

Learning Basic Operations	42
Video Menu	43
Audio Menu	45
Effect Menu	46
Setting Menu.....	47
Advanced Menu.....	49
About Menu	50
Reset All Menu	51

Learning Basic Operations

This section presents the basic functions available in menus. The menu can be controlled by the remote control.

For functions in each menu, access the guide available under each menu.

[Guide for explanation of symbols]



: Tilt the Enter button up or down.



: Tilt the Enter button left or right.



: Press the Enter button.



: Press the Esc button.

[Opening and Closing Menus]

Press the Menu button to display the top menu.

To close this menu, press the Menu button again.

To close this menu, press the Menu button. All the settings will be saved when the menu is closed.

[Menu Selection]

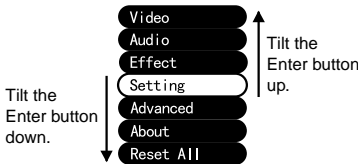

Tilt the Enter button up or down to move the pointer up or down.

[Moving in Hierarchy Structure Sub-menu selection]

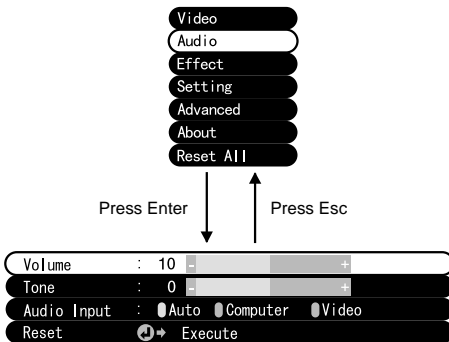

Press the Enter button to move to the sub-menus.

When pressing the Esc button, the settings will be saved and the menu returns to the top menu.

Press the Menu button to clear the menu display.

Video Menu

Displaying Menus

Press the Menu button, use the Enter button to select "Video" from the top menu displayed, and press the Enter button to move to a submenu.

Tip:

- When there is no video signal from a Computer / Component Video device, the "Video" menu is not available for settings.
- When there is no video signal from a Video device, only the "Mode" menu is available for settings.

Settings

Video menu elements to be set differ as follows when projecting computer/ component video versus video images.

Computer/Component Video Projection

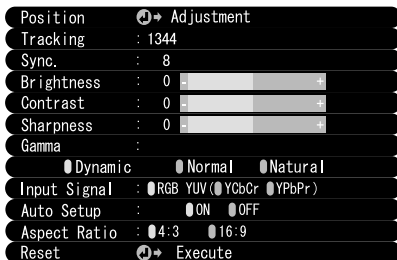

Video Projection

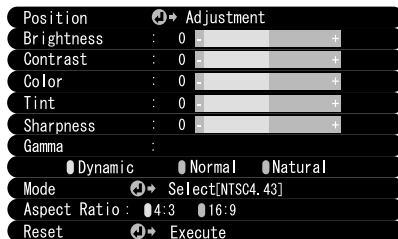

D-Sub15: Computer/Component video Video: Video image

Menu	Content	Video Projection	
		D-Sub15	Video
Position	Adjust video position vertically and horizontally. * After position is adjusted, changes in the video signal from a computer (such as changes in output mode or display color) may change the adjusted value.	○	○
Tracking*	Adjust when broad vertical streaks appear in image. (Available for setting only when input signal is RGB).	○	×
Sync.*	Adjust when flickering or blurring occurs (available for setting only when input signal is RGB). * When tracking is wrong, adjustment of sync will not correct flickering. Always adjust tracking before adjusting sync.	○	×

○: setting available ×: setting not available

Menu	Content	Video Projection	
		D-Sub15	Video
Brightness	Adjusts image brightness. +: Brightens image. - : Darkens image.	○	○
<u>Contrast</u> *	Adjusts difference in color brightness/darkness. +: Increases difference in color brightness/ darkness. - : Decreases difference in color brightness/ darkness.	○	○
Color	Adjusts color depth. +: Deepens color. - : Lightens color.	×	○
Tint	Adjusts tint. +: Strengthens red. - : Strengthens green.	×	○
Sharpness	Adjusts image sharpness. +: Strengthens sharpness and defines image. - : Weakens sharpness and softens image. * If keystone correction makes unevenness distinctive, reduce the sharpness.	○	○
<u>Gamma</u> *	Adjusts color of projected image. Dynamic : Increases contrast. (Used when projecting images containing text and graphics) Normal : Sets normal contrast. Natural : Weakens contrast to natural colors. (Used to give projected images a more natural look)	○	○
Input Signal	Select the input signal of the computer/ component video in use. RGB: Computer images <u>YUV</u> *: <u>Color difference</u> * images <u>YCbCr</u> *: DVD images <u>YPbPr</u> *: HDTV images	○	×
Auto Setup	Optimizes computer input image. (Can only be set when the input signal is RGB) ON : Auto Setup active OFF : Auto Setup not active	○	×
Mode	Select the video mode to use. * Selection of Auto provides automatic video signal identification, but for PAL (60Hz) mode, set to Manual.	×	○
Aspect Ratio	Select the <u>aspect ratio</u> *. (Can only be set when projecting a component video image (<u>YCbCr</u> *, <u>YPbPr</u> *).)	○	○
Reset	Returns Video menu settings to factory shipping values. * See page 52 for factory shipping values. To reset all menus to factory shipping values, use the "Reset All" menu.	○	○

○ : setting available × : setting not available

Audio Menu

■ Displaying Menus

Press the Menu button, use the Enter button to select "Audio" from the top menu displayed, and press the Enter button to move to a submenu.

■ Settings

Menu	Content
Volume	Adjusts the volume of sound output from the projector. + : Increases volume. - : Decreases volume.
Tone	Adjusts the tone of sound output from the projector. + : Increases treble. - : Decreases treble.
Audio Input	Select an audio input destination. (When the input signal is a component video signal, select Video.) Auto : Audio input matching that of the displayed video is selected. (Example: When computer video is displayed, computer audio input is selected). Computer : Audio input from computer is selected. Video : Audio input from an A/V device is selected.
Reset	Returns Audio menu settings to factory shipping values. * See page 52 for factory shipping values. To reset all menus to factory shipping values, use the Reset All menu.

Effect Menu

Displaying Menus

Press the Menu button, use the Enter button to select "Effect" from the top menu displayed, and press the Enter button to move to a submenu.

Settings



Menu	Content
Cursor/Stamp	Make detailed settings for the cursor/stamp function assigned to the remote control Effect1 button. Shape : Select the shape of the cursor/stamp. Zoom Rate : Select the display zoom factor for the cursor/stamp.
Horizontal Bar	Make detailed settings for the horizontal bar function assigned to the remote control Effect2 button. Color : Select the horizontal bar color. Width : Select the width of the horizontal bar from 2-20 dots (in 2-dot steps).
Cursor Speed	Set the cursor speed. L : Low M : Medium H : High
Reset	Returns Effect menu settings to their factory shipping values. * See page 52 for factory shipping values. To reset all menus to factory shipping values, use the Reset All menu.

Setting Menu

Displaying Menus

Press the Menu button, use the Enter button to select "Setting" from the top menu displayed, and press the Enter button to move to a submenu.

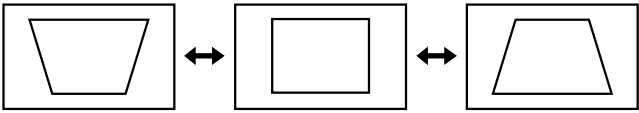
Settings

Menu	Content
Keystone	<p>If the screen is distorted in trapezoidal form, adjust it to normal display.</p> <p>-: Broadens upper screen Normal screen +: Broadens lower screen</p>  <ul style="list-style-type: none"> * • You can also adjust the screen with the Keystone button on the projector. • A keystone correction reduces screen size. • The keystone correction is stored in memory. You will need to readjust the image if the projection angle is changed. • If a keystone correction makes the image noticeably uneven, reduce the video sharpness with the menu commands Video > Sharpness.
No-signal/Msg	<p>Set the screen display when there is no video signal.</p> <p>OFF : No message is displayed. (Screen displays black.)</p> <p>Black : "No-signal" is displayed on a black background (when the language is English).</p> <p>Blue : "No-signal" is displayed on a blue background (when the language is English).</p>
Prompt	<p>Set whether the input source currently selected is displayed/not displayed on the screen.</p> <p>ON : After input source switching, the input source is displayed for approximately 3 seconds.</p>  <p>OFF : The input source is not displayed.</p>

Menu	Content
<u>A/V Mute*</u>	Temporarily eliminates video during a presentation. When the A/V button is pressed again, the video display will continue. Black : A black screen is displayed. Blue : A blue screen is displayed.
Sleep Mode	After sleep mode is activated, the projector enters standby mode when no signal is input from an external source for a continuous period of 30 minutes. ON : Sleep Mode active OFF : Sleep Mode inactive
Reset	Returns Setting menu settings to their factory shipping values. * See page 52 for factory shipping values. To reset all menus to factory shipping values, use the Reset All menu.

Advanced Menu

■ Displaying Menus

Press the Menu button, use the Enter button to select "Advanced" from the top menu displayed, and press the Enter button to move to a submenu.

■ Settings

Menu	Content
Language	Select the menu language. Select from Japanese, English, German, French, Italian, Spanish, Portuguese, Chinese and Korean.
Color Setting	Use color temperature or RGB to create settings for the colors displayed on screen. Color Temp: Adjusts the <u>color temperature</u> * of the video. Select "Color Temp" and press the Enter button to create settings. The setting unit is Kelvins (K). + : Increases color temperature (strengthens blue). - : Decreases color temperature (strengthens red). RGB: Adjusts red, green, and blue intensity. Select "RGB" and press the Enter button to create settings. + : Strengthens color. - : Weakens color.
Rear Proj.	This setting is used for projection from the rear of a screen. ON : Inverts a projected image vertically. OFF : Restores original.
Ceiling	This setting is used for projection with the projector hanging from a ceiling. ON : Inverts a projected image vertically and horizontally. OFF : Restores original.
Reset	Returns Advanced menu settings to their factory shipping values. * See page 52 for factory shipping values. To reset all menus to factory shipping values, use the Reset All menu.

About Menu

Displaying Menus

Press the Menu button, use the Enter button to select "About" from the top menu displayed, and press the Enter button to move to a submenu.

Setting and Display Information

The settings information displayed in the About menu differs as shown below during video projection from a computer/component versus a video device.

Computer/Component Video Projection

Lamp	:	0 H
Reset Lamp Timer	:	Execute
Video Source	:	Computer
Input Signal	:	RGB
Frequency	:	H 48.52 kHz
	:	V 60.1 Hz
SYNC Polarity	:	H Positive
	:	V Negative
SYNC Mode	:	Separate Sync
Resolution	:	1024 x 768
Refresh Rate	:	60.1 Hz

Video Projection

Lamp	:	0 H
Reset Lamp Timer	:	Execute
Video Source	:	Video
Video Signal	:	Auto (NTSC4.43)

D-Sub15: Computer/Component video Video: Video image

Menu	Content	Video Projection	
		D-Sub15	Video
Lamp	Displays cumulative lamp-on time.	<input type="radio"/>	<input type="radio"/>
Reset Lamp Timer	Sets cumulative lamp-on time to zero. Use this function when replacing the lamp.	<input type="radio"/>	<input type="radio"/>
Video Source	Displays the source for the video displayed on screen.	<input type="radio"/>	<input type="radio"/>
Input Signal	Displays a computer/component video input signal.	<input type="radio"/>	<input type="checkbox"/>
Frequency	Displays frequencies. H: Displays the horizontal scanning frequency. V: Displays the vertical scanning frequency.	<input type="radio"/>	<input type="checkbox"/>
SYNC Polarity	Displays sync polarity.	<input type="radio"/>	<input type="checkbox"/>
SYNC Mode	Displays sync attributes.	<input type="radio"/>	<input type="checkbox"/>
Resolution	Displays input resolution.	<input type="radio"/>	<input type="checkbox"/>
Refresh Rate	Displays refresh rate (vertical frequency).	<input type="radio"/>	<input type="checkbox"/>
Video Signal	Displays an A/V device signal mode. (When set to Auto in the menu, "Auto (NTSC)" is displayed.)	<input type="checkbox"/>	<input type="radio"/>

: Display : No display

Reset All Menu

■ Displaying Menus

Press the Menu button, and use the Enter button to select "Reset All" from the top-level menu displayed.

■ Settings

Menu	Content
Reset All	Returns all menu settings to initial settings. (Lamp and language settings excluded) * Note that rear and invert settings will also be cleared by this operation.

Initial Settings List

Initial settings at product shipment are shown below.

Main Menu Title	Submenu Title	Initial Settings
Video (Computer/ Component Video)	Position	Central value
	Tracking	Dependent on the connected signal
	Sync.	0
	Brightness	Central value
	Contrast	
	Sharpness	
	Gamma	Normal
	Input Signal	RGB
	Auto Setup	ON
Aspect Ratio	4:3	
Video (Video)	Position	Central value
	Brightness	
	Contrast	
	Color	
	Tint	
	Sharpness	
	Gamma	Normal
	Mode	Auto
Aspect Ratio	4:3	
Audio	Volume	Central value
	Tone	
	Audio Input	Auto
Effect	Cursor/Stamp	Shape:  Zoom Rate: 100%
	Horizontal Bar	Color: Magenta Width: 2
	Cursor Speed	M
Setting	Keystone	Central value
	No-Signal Msg	Blue
	Prompt	ON
	A/V Mute	Black
	Sleep Mode	OFF
Advanced	Language	
	Color Setting	Color Temp, (Computer/Component video: 7500K, Video: 6700K)
	Rear Proj.	OFF
	Ceiling	

Troubleshooting

Possible Failures	54
When Indicators Do Not Help.....	57

Possible Failures

If you think your projector may have failed, first check the indicators on the unit.

Your projector includes an "operation display indicator" and a "problem/alarm display indicator" which provide information on projector status.

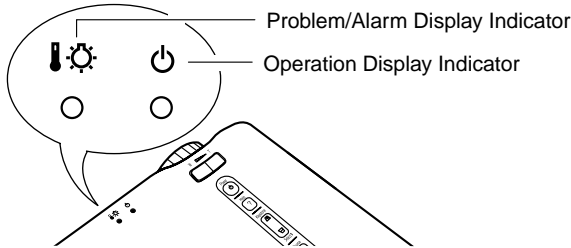

Operation Display Indicator

Indicator Status	Cause	Remedy or Status	See Page
Steady orange	Standby status	(Not abnormal) Press the Power button to begin projection.	24
Flashing orange	Cool-down in progress	(Not abnormal) Please wait. Cool-down* time takes about 2 minutes.	31
		You cannot operate the Power button during cool-down. Press the button again after cool-down ends.	
Steady green	Projection in progress	(Not abnormal)	25
Flashing green	Warm-up in progress	(Not abnormal) Please wait. Warm-up time is approximately 30 seconds. After warm-up is complete, the flashing green indicator changes to steady green.	25
Not lit	No power	If the lamp has been replaced, check that the lamp and lamp cover are attached securely.	66
		Check the power cord connections.	24
		Check power at the outlet.	24

Problem and Alarm Display Indicator

Indicator Status	Cause	Remedy or Status	See Page
Steady red	High internal temperature	<p>The lamp will turn off automatically and projection will stop. Wait for about 5 minutes without operating the projector. After 5 minutes, disconnect the power plug and connect it again.</p> <p>If the projector overheats, check the following two points.</p> <ul style="list-style-type: none"> • Is the setting-up location well ventilated? Check that the air inlet and air outlet are clear, and that the projector is not positioned against a wall. • Is the air filter blocked with dust? If the air filter is dirty, it should be cleaned. <p>After reconnecting the power plug the operating condition is restored. Press the power button to switch on the power supply. If the projector continues to overheat even after the above points have been checked, or if the indicators show a problem when the power is turned back on, stop using the projector, disconnect the power cord from the electrical outlet, and contact your dealer or the nearest address provided at "International Warranty Conditions" in "Safety Instructions/World-Wide Warranty Terms" included in the package.</p>	<p>14</p> <p>65</p>
Flashing red (1-second intervals)	Problem with lamp	<p>Disconnect the power cord from the electrical outlet, remove the lamp and check if the lamp is broken. If it is not broken, reinstall it and then press the [Power] button on either the remote control or the projector's control panel.</p> <p>If the indicators still show a problem, stop using the projector, disconnect the power cord from the electrical outlet, and contact your dealer or the nearest address provided at "Safety Instructions/World-Wide Warranty Terms" included in the package.</p>	66
		<p>If the lamp is broken, handle pieces carefully to avoid injury, and contact your dealer or the nearest address provided at "International Warranty Conditions" in "Safety Instructions/World-Wide Warranty Terms" included in the package for repair (video projection is not possible unless the lamp is replaced).</p>	-
		<p>If the lamp or lamp cover is not attached securely, follow the replacement instructions to attach it securely.</p>	66
Flashing red (2-second intervals)	Internal problem	<p>Stop using the projector, disconnect the power cord from the electrical outlet, and contact your dealer or the nearest address provided at "International Warranty Conditions" in "Safety Instructions/World-Wide Warranty Terms" included in the package.</p>	-

Indicator Status	Cause	Remedy or Status	See Page
Flashing orange	High-speed cooling in progress	Not a problem, but projection will be interrupted automatically to prevent further temperature rise.	-
		The usage temperature range of the projector is 5°C–35°C, and the projector should be used in this range.	73
		Place the projector in a well-ventilated location where air inlets and air exhaust vent are not blocked.	14
		Clean the air inlet.	65

Tip:

- *If the indicator is normal but you experience problems with video projection, refer to "When Indicators Do Not Help" on the following page.*
- *If an indicator is showing a status which does not appear in the previous tables, contact your dealer or the nearest address provided at "International Warranty Conditions" in "Safety Instructions/World-Wide Warranty Terms" included in the package.*

When Indicators Do Not Help

Video is Not Projected

[Nothing is Displayed]

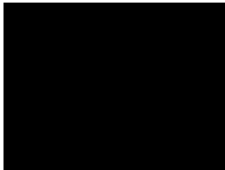

No Display

- **Is the lens cover still on?** See page 24
- **Have you turned the power off and then immediately on?** See page 31
The Power button cannot be operated immediately after the projection has been switched off. The Power button becomes operable after cool-down* is complete.
- **Is Sleep Mode on?** See page 48
If Sleep Mode is set to on and no video signal is input for 30 minutes, the projector lamp shuts off automatically.
- **Is video brightness adjusted correctly?** See page 44
- **Is "A/V Mute" mode active?** See page 48
- **Is the computer's screen saver on or is the computer in power save mode?**

[A Message Appears]

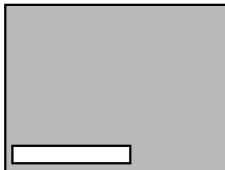

Display shows "Not Supported".

- **Is the resolution of the video signal output from your computer higher than SXGA (1280x1024)?** See page 19
- **Check that the frequency of the video signal output from your computer is a compatible mode.** See page 19

Consult your computer instruction manual for any changes to be made to the resolution or frequency of the video signal output from your computer.

- **Are the cables connected correctly?** See pages 20, 21
- **Have you correctly selected the video input port connected?** See page 26
Press the Source button on the projector (Computer, Video, or S-Video on the remote control) to switch the video source.
- **Is power provided to a connected computer or A/V device?** See page 26
- **Is a video signal output from a connected computer or A/V device?**
- **When using a laptop computer or integrated LCD-type computer, a video signal must be output to the projector.** See page 27

A video signal is normally output only to an LCD screen, not externally. Switch the video signal to external output. Some computer models do not display video on an LCD screen even when a video signal is output externally.

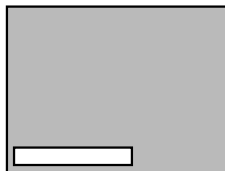

Display shows "No-Signal".

Carefully review sections such as "Providing External Output" and "Providing Output to an Externally Connected Monitor" in the instruction manual of the connected computer.

Image is Unclear

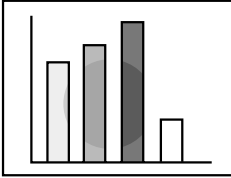

- Blurry image
- Image only partially focused
- Not focused at all

- **Is the focus adjusted correctly? See page 29**
- **Is the projection distance optimal? See page 16**
The recommended projection distance is 39.37inches (1.0m) to 515.75inches (13.1m). Set up the projector in this range.
- **Is the lens dirty? See page 64**
- **Is the projection beam facing the screen directly? See page 14**
- **Is the lens covered with condensation?**
If you carry the projector from a cold room into a warm room, the lens may become covered with condensation and the image may be blurred. After a short period, the image should return to normal.
- **Press the Auto button on the remote control. See page 30**
- **Have you adjusted Sync*, Tracking*, and Position? See page 43**
Use the menu to adjust.
- **Are the video signal mode settings correct? See page 44**
Use the Menu > Video > Mode menu items to select a video signal format. Auto detection according to video signal input is not always possible.
- **Are the computer/component video signal settings correct? See page 44**
Select the correct input signal settings by selecting Menu > Video > Input Signal.
RGB: Computer images
YUV*: Color difference images
YCbCr*: DVD images
YPbPr*: HDTV images

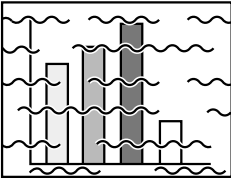

- Disturbed image
- Noisy

- **Are cables connected correctly?** See pages 20, 21
- **Is the correct resolution selected?** See page 19
Set your computer to provide a signal compatible with the projector. Consult your computer instruction manual with regard to modifying the signal.
- **Press the Auto button on the remote control.** See page 30
- **Have you adjusted Sync*, Tracking*, and Position?** See page 43
Use the "Menu" to adjust.
- **Are the video signal mode settings correct?** See page 44
Use the Menu > Video > Mode menu items to select a video signal format. Auto detection according to video signal input is not always possible.
- **Are the computer/component video signal settings correct?** See page 44
Select the correct input signal settings by selecting Menu > Video > Input Signal.
RGB: Computer images
YUV*: Color difference images
YCbCr*: DVD images
YPbPr*: HDTV images
- **Are you using an cable included or one sold separately?** See page 70
- **Are cables too long?**
A commercial video signal amplifier should be used with computer cables longer than 393.70inches (10m) .

Image Disappears or is Undersized

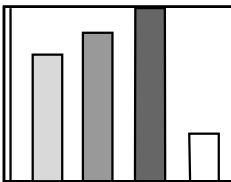

- Image Disappears
- Undersized

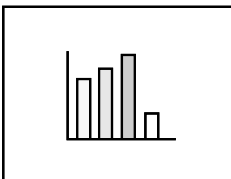

- **Have you adjusted "Position"?** See page 43
Use the Menu > Video > Position menu items to adjust.
- **Is the correct resolution selected?** See page 19
Set your computer to provide a signal compatible with the projector. Consult your computer instruction manual with regard to modifying the signal.
- **Change the resolution of your laptop or integrated LCD-type computer.** See page 27
Change the resolution to provide a full LCD display, or provide the video signal only to the external output.
- **Has the computer been set for dual display?**
If dual display has been activated in the Display Properties of the computer's Control Panel, the projector will only project about half of the image on the computer screen. To display the whole of the image on the computer screen, turn off the dual display setting. Refer to the video driver manual for the computer's monitor for further details.

Image Color is Poor

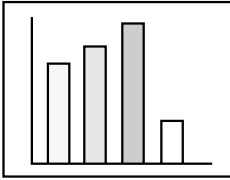

- **Is image brightness adjusted correctly?** See page 44
- **Are cables connected correctly?** See pages 20, 21
- **Is contrast* adjusted correctly?** See pages 44
- **Is color adjusted correctly?** See page 49
- **Are color depth and tint adjusted correctly?** See page 44

(Video tint and display to a computer monitor or LCD may not match, but this is not abnormal.)

- **Does the lamp need replacement?** See page 66
A nearly expired lamp can produce dark images or poor tint and should be replaced with a fresh lamp.
- **Are the computer/component video signal settings correct?** See page 44

Select the correct input signal settings by selecting Menu > Video > Input Signal.

RGB: Computer images

YUV*: Color difference images

YCbCr*: DVD images

YPbPr*: HDTV images

Images Are Dark

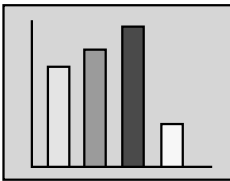

- **Does the lamp need replacement?** See page 66
A nearly expired lamp can produce dark images or poor tint and should be replaced with a fresh lamp.
- **Is image brightness adjusted correctly?** See page 44
- **Is contrast* adjusted correctly?** See pages 44

There is No Sound

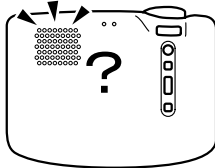

- **Are audio inputs connected correctly?** See page 20
- **Are audio outputs connected correctly?** See page 23
- **Have you selected the video whose audio you wish to output?** See page 26
- **Is volume adjusted to the minimum level?** See page 30
- **Is the A/V Mute function activated?** See page 39
The A/V Mute mode may also be active.
Press the Volume button to release the A/V Mute.
- **Is the audio input setup correct?** See page 45
Select the correct audio signal by selecting Menu > Audio > Audio Input.

The Remote Control Does Not Operate



- **Is the remote control R/C switch set to On?** See page 25
- **Are you pointing the remote control in the correct direction for operation?** See page 11
The range of operation is approximately 30° left or right and approximately 15° above or below the remote control sensor on the projector.
- **Is the remote control too far from the projector?** See page 11
The operable distance is approximately 393.70inches (10m).
- **Is the remote control receiver on the projector blocked?**
- **Is the remote control receiver in the path of direct sunlight or strong fluorescent light?**
- **Are batteries in place?** See page 12
- **Are the batteries worn?** See page 12
- **Are the batteries inserted correctly?** See page 12

Cannot Switch off (After Pressing the Power Button)

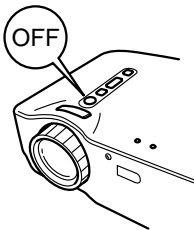

- **The operation display indicator remains a steady orange.**
The operation display indicator of the projector is designed to remain lit even after power is switched off. When the plug is pulled out of the outlet, the operation display indicator will go out.
- **The fan does not stop.**
After the Power button is pressed and power is turned off, cool-down* begins. After cool-down, the operation display indicator lights orange, and you should pull the plug out of the outlet.
* Cool-down time takes about 2 minutes.

Maintenance

Projector Cleaning, Lens Replacement, Air Inlet Cleaning	64
Lamp Replacement	66

Projector Cleaning, Lens Replacement, Air Inlet Cleaning

Clean your projector when it is dirty or image projection is poor. Clean the air inlets every 100 hours in practice.

Warning:

- *The projector cabinet should only be opened by trained service personnel. The projector contains several high voltage components which can cause electric shock. For internal checks, repairs and cleaning, contact your dealer or the nearest address provided at “International Warranty Conditions” in “Safety Instructions/World-Wide Warranty Terms” included in the package.*
- *Use care when handling the power plug and connector. Improper handling may cause fire or electric shock. When handling the plug, observe the following.*
 - *Do not insert a plug or connector into an outlet or port if it is dirty or holds foreign matter.*
 - *Insert the plug and connector firmly and completely.*
 - *Do not pull out the plug or connector with wet hands.*

Caution:

- *Never attempt to remove the lamp immediately after use.*
 - *Heat may cause burns or other injury.*
 - *Wait approximately 60 minutes after switching off power and remove the lamp after the projector has cooled completely.*
- *When performing operations, pull the power plug and connector out of the outlet and port respectively.*

Switch off power to the projector and disconnect the power cord before cleaning.

Cleaning the Projector Unit

- Wipe dirt from the projector lightly with a soft cloth.
- For heavier dirt, wipe the projector lightly with a cloth soaked in a weak solution of mild detergent and wrung out thoroughly, then dry with a separate cloth.

Do not use waxes, benzene, thinners, or other volatile substances. These may degrade the cabinet or strip the finish.

Cleaning the Lens

Clean the lens with a commercial blower or lens cleaning paper. The surface of the lens is easily scratched and should not be rubbed or struck with hard objects.

Cleaning the Air Inlets

Accumulated dust in the air inlets degrades ventilation, increases the interior temperature, and can cause malfunction.

To prevent debris from entering the air inlets, always stand the projector upright with the lens upward. Then use a vacuum cleaner or other equipment to suck dust from the inlets.

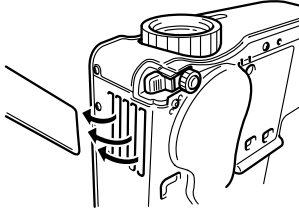

Tip:

If it is no longer possible to remove the dirt from the air inlets, it is time to replace them. Consult your vendor.

Lamp Replacement

Replace the lamp with a new lamp in the following instances.

A replacement lamp is an optional part (sold separately).

(Model No: ELPLP16)

[When the following message is displayed for 30 seconds after projection begins: "Lamp Replace. After the replacement of the lamp, reset the lamp timer under the direction in the user's manual."]

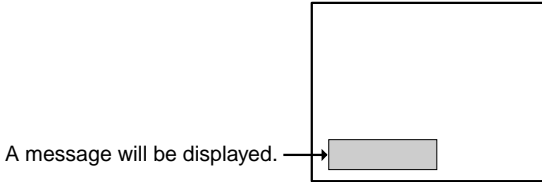

[When the problem/alarm display indicator flashes red at 1-second intervals.]

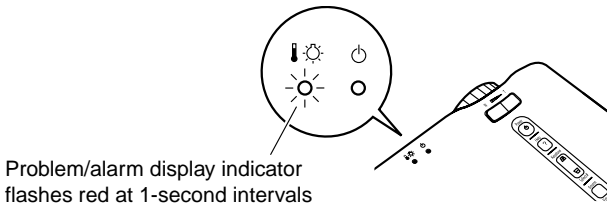

[When brightness or picture quality is inferior to its original state.]

Tip:

- If the lamp does not light, replace it even if the lamp life has not expired.
- To maintain the original brightness and picture quality, replacement messages are set for approximately 1,400 hours.

If you continue to use the lamp after this period, the possibility of the lamp breaking becomes greater. When the lamp replacement message appears, replace the lamp with a new one as soon as possible, even if it is still working.

- Though a replacement message appears at approximately 1,400 hours, individual lamp characteristics or usage conditions may cause failure before 1,400 hours, and we recommend that a replacement lamp be kept on hand.
- Contact your dealer for a spare lamp.

Replacement

Tip:

- Install the lamp securely. For safety, when the lamp cover is opened, the abnormal warning display indicator flashes red, and the projector lamp goes out. If the lamp or lamp cover is installed improperly, the lamp will not light.

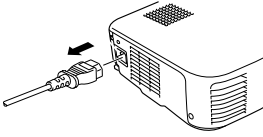

1. Switch off power to the projector and disconnect the power cord after cool-down* ends.
Cool-down time varies according to external temperature and other factors.

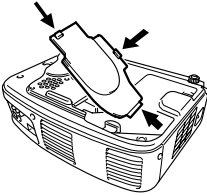

2. After the projector has cooled completely, remove the lamp cover.
 - The projector requires approximately 60 minutes to cool completely.
 - Press on the 2 catches and pull the cover out diagonally.

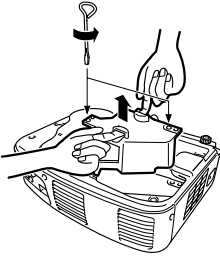

3. Pull the lamp out.
Use a screwdriver to loosen the two lamp retaining screws, then grasp the holds and pull the lamp out.

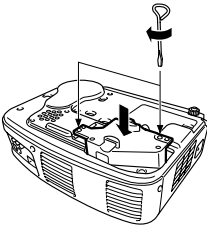

4. Install a new lamp.
Align the lamp properly, insert the lamp until it contacts the rear of the housing, and use a screwdriver to tighten the two lamp retaining screws firmly.

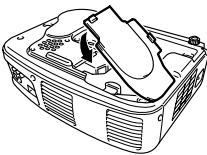

5. Install the lamp cover.
Insert the cover diagonally and press it into the projector until you hear the catches click into place.
Check that the catches are securely fastened.

Tip:

After lamp replacement, use the About menu to reset lamp time to its initial value (See page 50).

General Notes

Optional Accessories	70
Glossary	71
Specifications.....	73
External Dimensions.....	75
Index	76

Optional Accessories

The following optional accessories are available for purchase if required. Details of optional accessories listed here are current as of November 2001. Details of accessories are subject to change without notice.

Soft carrying case (type for storing a laptop computer) Use this case if you need to carry the projector by hand.	ELPKS16	Computer cable (6 ft (1.8 m) - for mini D-Sub 15-pin/mini D-Sub 15-pin) Use to connect the projector to a computer when you would like to use UXGA display resolution.	ELPKC02
Soft carrying case Use this case if you need to carry the projector by hand.	ELPKS24	Computer cable (9.8 ft (3 m) - for mini D-Sub 15-pin/mini D-Sub 15-pin)	ELPKC09
Spare lamp Use as a replacement for spent lamps.	ELPLP16	Computer cable (65.6 ft (20 m) - for mini D-Sub 15-pin/mini D-Sub 15-pin) Use this extension cable if the accessory computer cable is too short.	ELPKC10
Portable screen (50 inch) A compact screen which can be carried easily.	ELPSC06	Component video cable (9.8 ft (3 m) - for mini D-Sub 15-pin/RCA x 3) Use to connect a component video source.	ELPKC19
60 inch screen	ELPSC07	Image presentation camera Use when projecting books, OHP films and slides.	ELPDC02 ELPDC03
80 inch screen	ELPSC08		
Mac adapter set Use to connect the projector to a Macintosh computer when the accessory or optional computer cables cannot be used because the connector shapes are different.	ELPAP01		

Glossary

This glossary provides brief explanations of terms which are used in this manual but are not explained in the text or difficult to understand. For details, refer to other available publications.

Term	Description
A/V Mute	Refers to temporary stoppage of audio and video. Your projector provides this function when the A/V Mute button is pressed. When the A/V Mute button is pressed again or audio volume is adjusted, this function is released.
Aspect ratio	The ratio between an image's length and its height. HDTV images have an aspect ratio of 16:9 and appear elongated. The aspect ratio for standard images is 4:3.
Color difference signal (component)	A type of video signal output by video equipment which actually consists of three separate signals: a red + luminance signal (R-Y), a luminance signal (Y) and a blue + luminance signal (B-Y). Each signal is transmitted along a separate cable. Color difference signals generally result in a better image than composite signals (in which the red, green and blue signals and the luminance signal are all transmitted along a single cable).
Color temperature	The temperature of an object which is emitting light. If the color temperature is high, the colors tend to take on a bluish tinge. If the color temperature is lower, the colors tend to take on a reddish tinge.
Contrast	The enhancing or weakening of differences in color lightness and darkness that provides a sharper or softer view of characters and images. This adjustment is referred to as contrast adjustment.
Cool-Down	After the Power button is pressed and the lamp goes out, lamp cooling is continued. After the lamp goes out, a cooling fan spins, and operational buttons become inactive. Cool-down time takes about 2 minutes.
Gamma	During image display, the difference of display colors depending on the device used is compensated.
SVGA	Refers to a 800-pixel (Pix) horizontal x 600-pixel (Pix) vertical display signal for an IBM PC/AT-compatible (DOS/V) computer.
SXGA	Refers to a 1280-pixel (Pix) horizontal x 1024-pixel (Pix) vertical display signal for an IBM PC/AT-compatible (DOS/V) computer.
Sync (synchronization)	Signals output by a computer are output at a certain predetermined frequency. If the frequency of your projector cannot match that frequency, a clear image cannot be obtained. Matching of signal phases (peak offset) is referred to as synchronization (synch). If synchronization is not achieved, a projected image displays jitters, blurring, and horizontal noise.

Term	Description
Tracking	<p>Signals output by a computer are output at a certain predetermined frequency.</p> <p>If the frequency of your projector cannot match that frequency, a clear image cannot be obtained. Matching of signal frequencies is referred to as matching tracking. When tracking is not matched, a projected image displays broad vertical bands.</p>
USB	<p>An abbreviation for universal serial bus, an interface for connecting a personal computer with a relatively low-speed peripheral device.</p>
VGA	<p>Refers to a 640-pixel (Pix) horizontal x 480-pixel (Pix) vertical display signal for an IBM PC/AT-compatible (DOS/V) computer.</p>
XGA	<p>Refers to a 1024-pixel (Pix) horizontal x 768-pixel (Pix) vertical display signal for an IBM PC/AT-compatible (DOS/V) computer.</p>
YCbCr	<p>The carrier signal which is contained in the color bar signal used in modern TV transmissions (NTSC format). The name comes from the Y (luminance) signal and the CbCr (chroma [color]) signals.</p>
YPbPr	<p>The carrier signal which is contained in the color bar signal used in high-definition TV (HDTV) transmissions. The name comes from the Y (luminance) signal and the PbPr (color difference) signals.</p>
YUV	<p>This signal consists of three components, the luminance (Y), red minus luminance (U) and blue minus luminance (V).</p> <p>The human eye is more sensitive for changes in brightness than changes in color. By using this feature, the data volume assigned to the brightness is larger. To prevent a deterioration of the image quality, a high data compression rate is used.</p> <p>This signal format is used for digital video data.</p>

Specifications

Product Name	Multi-Media Projector EMP-71/51		
Dimensions	11.81(W) x 3.15(H) x 8.46(D)inches (300(W) x 80(H) x 220(D)mm) (not including protruding parts)		
Panel Size	0.7		
Display Format	Polysilicon TFT		
Pixel Count	<EMP-71> 786,432 (1,024 (Horizontal) x 768 (Vertical) dots) x 3 <EMP-51> 480,000 (800 (Horizontal) x 600 (Vertical) dots) x 3		
Focus Adjustment	Manual		
Zoom Adjustment	Electronic 0.8 : 1		
Lamp (Light Source)	UHE lamp, Rated 160W ELPLP16		
Maximum Audio Output	1W monaural		
Speaker	1		
Power Supply	100 – 240VAC 50/60Hz		
Power Consumption	2.9A – 1.6A		
Usage Temperature Range	41°F – 95°F (+5°C – +35°C) (No condensation)		
Storage Temperature Range	14°F – 140°F (-10°C – +60°C) (No condensation)		
Weight	Approx. 6.83lb (3.1kg)		
Connectors	Computer/Component Video port	1 system	Mini D-Sub 15-pin (female)
	Audio In port (for computer)	1 system	Stereo mini-jack
	Mouse/Com port	1 system	DIN jack, 9-pin
	Composite Video port	1 system	RCA pin jack
	S-Video port	1 system	Mini DIN, 4-pin
	Audio ports (for video)	1 system	RCA pin jack x2 (L, R)
	Audio Out port	1 system	Stereo mini-jack
	USB Mouse port	1 system	USB connector (B-type)

Specifications may change without notice.

Safety

USA

UL1950 3rd Edition

Canada

CSA C22.2 No.950-95 (cUL)

European Community

The Low Voltage Directive (73/23/EEC)

IEC60950 2nd Edition, +Amd.1, +Amd.2, +Amd.3, +Amd.4

EMC

USA

FCC 47CFR Part15B Class B (DoC)

Canada

ICES-003 Class B

European Community

The EMC Directive (89/336/EEC)

EN55022, 1998 Class B

EN55024, 1998

IEC61000-4-2, IEC61000-4-3, IEC61000-4-4, IEC61000-4-5,

IEC61000-4-6, IEC61000-4-8, IEC61000-4-11,

IEC61000-3-2, IEC61000-3-3

Australia/New Zealand

AS/NZS 3548:1995, A1:1997, A2:1997 Class B

CISPR Pub.22:1993, A1:1995, A2:1996, Class B

External Dimensions

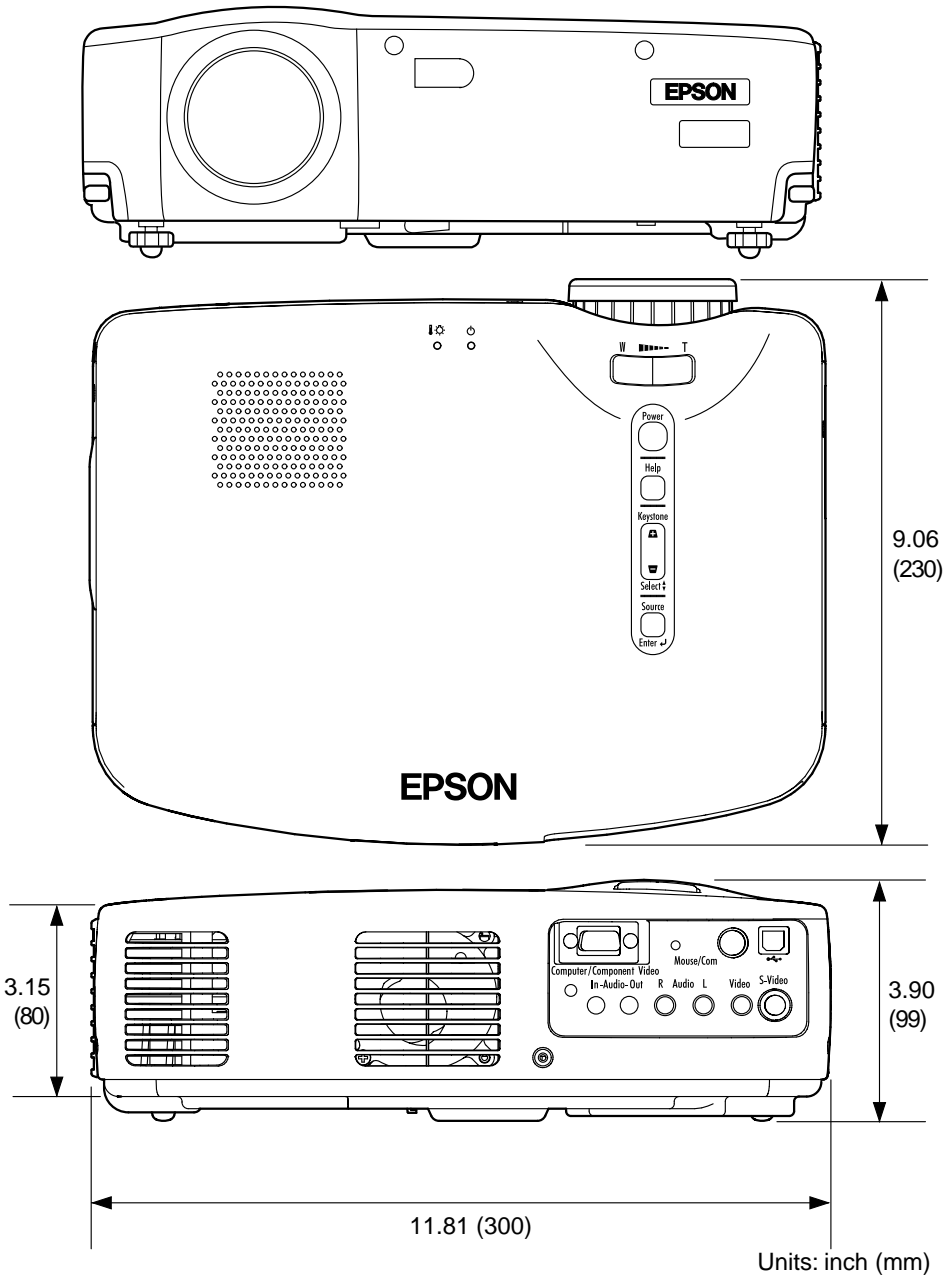

Units: inch (mm)

Index

[A]

- A/V Device 21
- A/V Mute 48
- A/V Mute Button 10, 39
- About Menu 50
- Adjusting 28, 30
- Advanced Menu 49
- Air Inlet. 8
- Aspect Ratio 44
- Audio In Port 9, 20
- Audio Input 45
- Audio Menu 45
- Audio Out Port 9, 23
- Audio Ports 9, 21
- Auto Button 10, 30
- Auto Setup 44

[B]

- Battery Cover 10, 12
- Brightness 44

[C]

- Ceiling 49
- Color 44
- Color Setting 49
- Compatible Mode 19
- Computer 18
- Computer Button 10, 26
- Computer/Component Video
Port 9, 20
- Connecting 20, 21
- Contrast 44
- Control Panel 12
- Cursor Speed 46
- Cursor/Stamp 38, 46

[E]

- Effect Button 10, 38
- Effect Menu 46
- Enter Button 10, 34, 40, 42

- Esc Button 10, 34, 42
- External Audio Device 23
- External Dimensions. 75
- E-Zoom Button 10, 36

[F]

- Focus Ring 8, 29
- Foot Adjust Lever 8
- Freeze Button 10, 39
- Frequency 50
- Front Adjustable Foot 8, 28

[G]

- Gamma 44

[H]

- Help Button 9, 10, 40
- Help Screens 40
- Horizontal Bar 38, 46

[I]

- Indicator 10
- Initial Settings 52
- Input Signal 44, 50
- Input/Output Ports 8
- Inserting Batteries 12

[K]

- Keystone 47
- Keystone (Select)
Button 9, 29, 40

[L]

- Lamp 50
- Lamp Cover 8
- Lamp Replacement 66
- Language 49
- Laptop 27
- Lens Cover 8

[M]

Macintosh	35
Menu Button	10, 42
Mode	44, 50
Mouse Cable	35
Mouse/Com Port	9, 35

[N]

No-signal	47
-----------	----

[O]

Operation Display	
Indicator	8, 24, 25, 31, 54
Optional Accessories	70

[P]

Position	43
Power Button	9, 10, 25, 31
Power Cord	24
Power Inlet	8, 24
Problem/Alarm Display	
Indicator	8, 55, 66
Projection Distance	16
Prompt	47
PS/2 Mouse Cable	35

[R]

R/C Switch	10, 25, 32
Rear Adjustable Foot	8
Rear Projection	49
Refresh Rate	50
Remote Control	10, 11
Remote Control Receiver	8
Reset	44, 45, 46, 48, 49
Reset All Menu	51
Reset Lamp Timer	50
Resolution	50

[S]

Screen Size	16
Setting Menu	47
Setup Instructions	15
Sharpness	44
Sleep Mode	48
Source (Enter) Button	9, 26, 40
Speaker	8
Special Notes on Setup	14
Specifications	73
Storage	32
S-Video Button	10, 26
S-Video Port	9, 21
SYNC Mode	50
SYNC Polarity	50
Sync.	43

[T]

Term	71
Tint	44
Tone	45
Tracking	43

[U]

USB mouse Cable	35
USB mouse Port	9, 35

[V]

Video Button	10, 26
Video Menu	43
Video Source	50
Video Port	21
Volume	45
Volume Button	10, 30

[W]

Wide/Tele Button	8, 37
Windows	35
Wireless Mouse	34

FCC Compliance Statement For United States Users

This equipment has been tested and found to comply with the limits for a Class B digital device, pursuant to Part 15 of the FCC Rules. These limits are designed to provide reasonable protection against harmful interference in a residential installation. This equipment generates, uses, and can radiate radio frequency energy and, if not installed and used in accordance with the instructions, may cause harmful interference to radio or television reception. However, there is no guarantee that interference will not occur in a particular installation. If this equipment does cause interference to radio and television reception, which can be determined by turning the equipment off and on, the user is encouraged to try to correct the interference by one or more of the following measures.

- Reorient or relocate the receiving antenna.
- Increase the separation between the equipment and receiver.
- Connect the equipment into an outlet on a circuit different from that to which the receiver is connected.
- Consult the dealer or an experienced radio/TV technician for help.

WARNING

The connection of a non-shielded equipment interface cable to this equipment will invalidate the FCC Certification or Declaration of this device and may cause interference levels which exceed the limits established by the FCC for this equipment. It is the responsibility of the user to obtain and use a shielded equipment interface cable with this device. If this equipment has more than one interface connector, do not leave cables connected to unused interfaces. Changes or modifications not expressly approved by the manufacturer could void the user's authority to operate the equipment.

Declaration of Conformity for Products Marked the FCC Logo (United States only)

For questions regarding your product, contact:

EPSON AMERICA, INC.

MS 3-13

3840 Kilroy Airport Way

Long Beach, CA 90806

Telephone: 562-290-5254

All rights reserved. No part of this publication may be reproduced, stored in a retrieval system, or transmitted in any form or by any means, electronic, mechanical, photocopying, recording, or otherwise, without the prior written permission of SEIKO EPSON CORPORATION. No patent liability is assumed with respect to the use of the information contained herein. Neither is any liability assumed for damages resulting from the use of the information contained herein.

Neither SEIKO EPSON CORPORATION nor its affiliates shall be liable to the purchaser of this product or third parties for damages, losses, costs, or expenses incurred by purchaser or third parties as a result of: accident, misuse, or abuse of this product or unauthorized modifications, repairs, or alterations to this product, or (excluding the U.S.) failure to strictly comply with SEIKO EPSON CORPORATION's operating and maintenance instructions.

SEIKO EPSON CORPORATION shall not be liable against any damages or problems arising from the use of any options or any consumable products other than those designated as Original EPSON Products or EPSON Approved Products by SEIKO EPSON CORPORATION.

EPSON is a registered trademark and PowerLite is a trademark of SEIKO EPSON CORPORATION.

General Notice: The following trademarks and registered trademarks are the property of their respective owners and are used in this publication for identification purposes only.

- EPSON/Seiko Epson Corp.
- Macintosh, PowerBook/Apple Computer Inc.
- IBM/International Business Machine Corp.
- Windows/Microsoft Corp.

Other product names used herein are also for identification purposes only and may be trademarks of their respective owners. EPSON disclaims any and all rights in those marks.

EPSON®



Printed on 100% recycled paper



Printed in Japan
402029001
(90022011)
01.12-.9A(C05)