

Quick Reference Guide

- Connections 1
- Projection Preparation and Adjustments3
- Turning the Projector off5
- Functions for Enhancing Projection 6
- List of Configuration Setting Menus10
- Troubleshooting11
- List of Supported Monitor Displays Last page

Before setting up and using this projector, be sure to read the User's Guide.

EMP-9300
EMP-8300

WARNING

Do not look directly into the projector's lens.

Connections

Be sure to turn the power for all components off before making any of the following connections.

Connecting to a computer

The [Audio] port to use is the port that is in the same box as the port being used to input the video signals.
* An accessory audio cable is not supplied with the EMP-9300. Use a commercially-available audio cable instead.

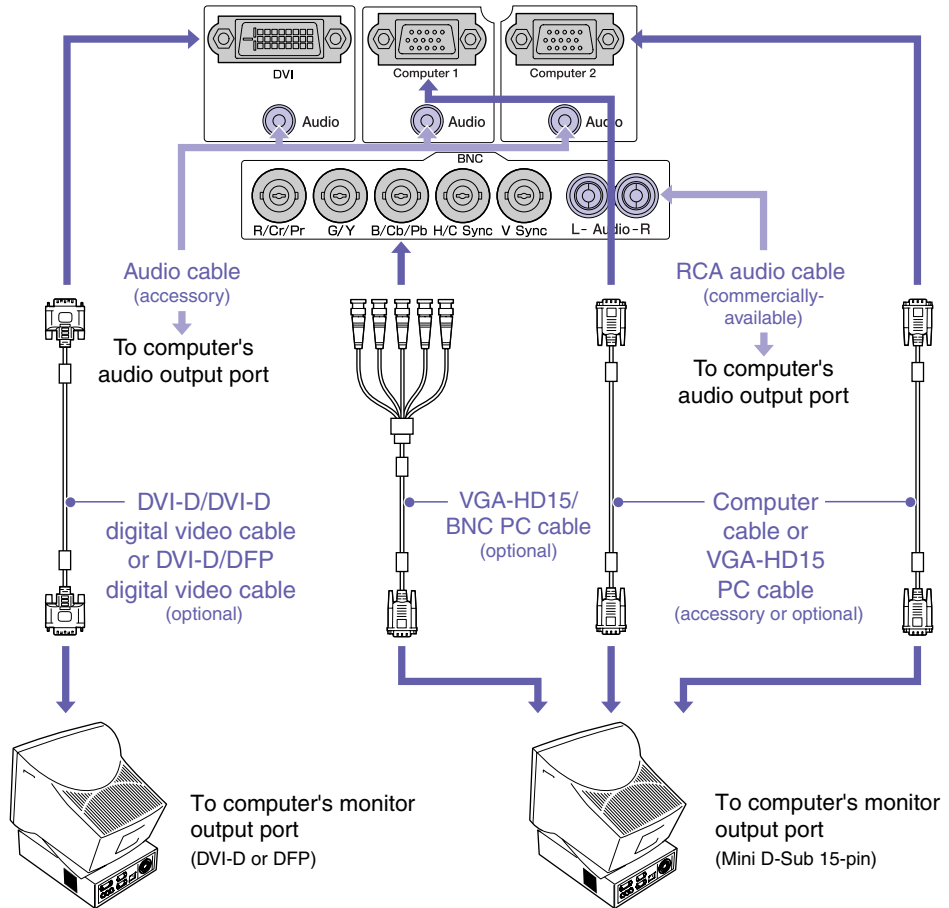

Connecting to video equipment

The [Audio] port to use is the port that is in the same box as the port being used to input the video signals.
 * An accessory audio cable is not supplied with the EMP-9300. Use a commercially-available audio cable instead.

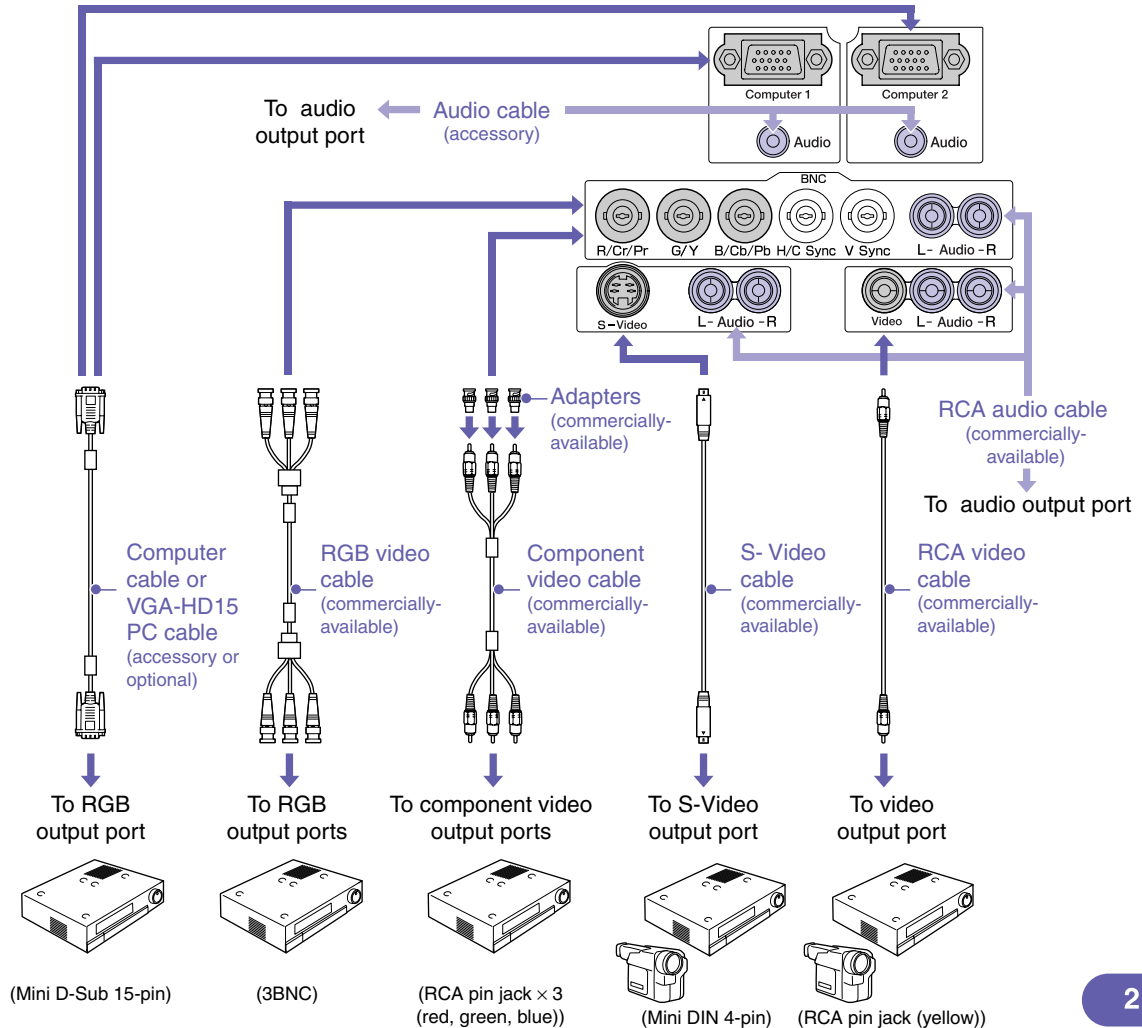

Projection Preparation and Adjustments

1 Set the [R/C] switch to "ON".

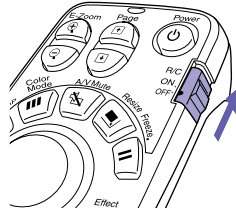

2 Turn the power on for all input equipment.



3 Press the  button.

When the power is first turned on after attaching the standard lens or wide angle zoom lens, continue with the configuration menu "Reset All".

If you do not select "Reset All", the images may appear slightly dark.

 User's Guide
"Reset All Menu"

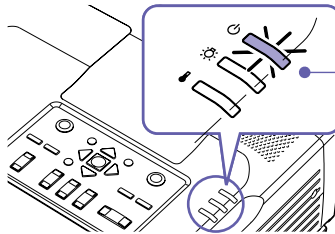

- Check that the power cable is connected to the projector and to the electrical outlet.
- With the EMP-9300, if you change the setting for the "Direct Power ON" command in the "Advanced2" menu to "ON", the projector's power will turn on and projection will start at once when you insert the power plug into the wall outlet. First turn the power on for other components that are connected to the projector.

 User's Guide "Advanced2 Menu"

For a video source, press the [Play] button.

Projection starts after a short period.

 (Operation) indicator



Flashes green (warm-up in progress/approx. 40 seconds)
→ Lights green (projection in progress)

With the EMP-9300, the Password Protect setting may cause the password entry screen to be displayed when the power is turned on. If this happens, enter the password.

 User's Guide "Preventing theft (Password Protect)"

4 Select the images to be projected.

- If only one signal source is connected, images from that source will be projected automatically.
- If more than one device is connected to the projector, use the [Source] button to select the image source to be projected.

If using the ,  or  buttons to select the source, you can change the signal setting by pressing the button repeatedly.

To select images to be projected while viewing all images being input (Preview Function)

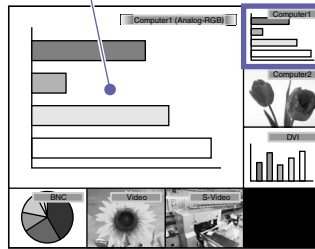

Active window



1. Press the  button.

The image can be changed directly by selecting the desired image source with the [Source] button.

2. To view the images in more detail, switch to the active window.

Tilt the  button to select an image and then press the  button.

3. Project the images in the active window.







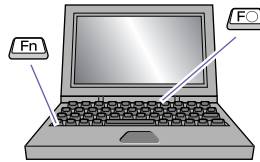





Press the  button.

User's Guide "Selecting an Image Source While Viewing Projected Images (Preview Function)"





If the source does not change to a laptop PC



Examples of changing output

NEC	 + 
Panasonic	 + 
TOSHIBA	 + 
IBM	 + 
SONY	 + 
FUJITSU	 + 
Macintosh	After startup, change the Control Panel adjustment so that mirroring is active

You may need to change the output destination using the keyboard or by changing settings.

To change, hold down the  key and press the  key (with a symbol such as  or  on it).

Once the setting is changed, projection will start after a short period.

Computer documentation

If images are still not projected after carrying out the above, see p.12.

Adjusting projected images

Moving projected images vertically (Lens shift)

LensShift

6 Up

3 Down

Making fine adjustments to the projection area size (Zoom)

Zoom

5 Increase

2 Decrease

Adjusting the focus of images (Focus)

Focus

4

1

Changing the colour mode



The colour mode changes as follows each time this button is pressed



User's Guide "Selecting the Projection Quality (Colour Mode Selection)"

Retrieving preset settings

(Adjustment is only possible when analogue RGB signals are being input)

Preset

8

The "Video" menu settings (such as input resolution and tracking) for the respective preset number are retrieved each time this button is pressed.

User's Guide "Preset Function"

Turning the Projector off

User's Guide "Turning the Projector Off"

1 Turn the power off for the equipment that is connected to the projector.

2 Press the button twice to turn the power off.

3 Set the [R/C] switch to "OFF".

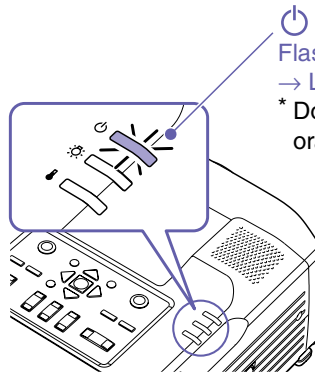

(Operation) indicator

Flashes orange* (Cool-down in progress/approx. 30 seconds)
→ Lights orange

* Do not disconnect the power cable while the indicator is still flashing orange, otherwise it may result in errors in projector operation.

If the message "The projector is overheated. Clean or replace the air filter and lower the room temperature." appears during projection of images, press the button to turn the power off and then clean or replace the air filters.

User's Guide "Cleaning the Air Filters and Air Intake Vent" "Replacing the Air Filters"

If not using for a long period, disconnect the power cable from the electrical outlet.

Functions for Enhancing Projection

Using the remote control for one-person presentations

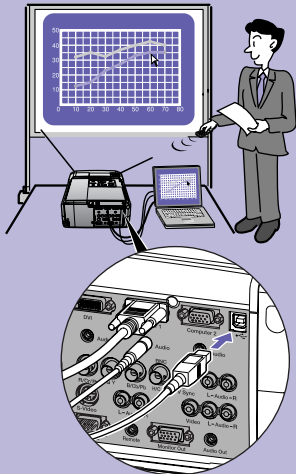

To use the wireless mouse function, you need to connect the computer using a USB cable in addition to the computer cable.

Use the accessory USB cable to connect the USB port of a computer to the projector's [USB] port.

* An accessory USB cable is not supplied with the EMP-9300. Use a commercially-available USB cable instead.

■ Wireless Mouse Function

When projecting images from a computer, the accessory projector's remote control can be used to operate the computer's mouse pointer.

Moving the mouse pointer

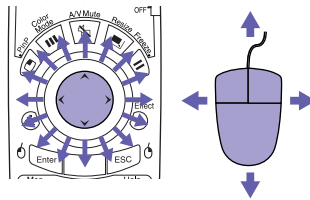

Drag and drop

1. Hold down the button for approx. 1.5 seconds.
The button lights and drag and drop mode is enabled.
2. Tilt the button to drag an item.
3. Press the button to drop the item.

You can also drag and drop in the same way using the button.

Mouse clicks

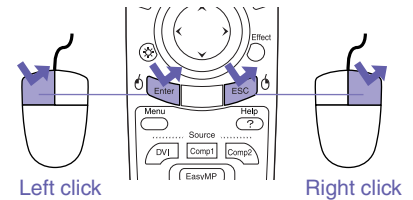

Double-click: Press twice in rapid succession.

Displaying previous or next slides in a PowerPoint slideshow

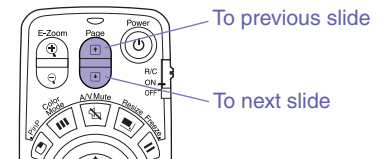

The wireless mouse function may not operate correctly depending on the computer version or function being used.

User's Guide
"Using the Remote Control to Operate the Mouse Pointer (Wireless Mouse Function)"

Enlarging parts of an image

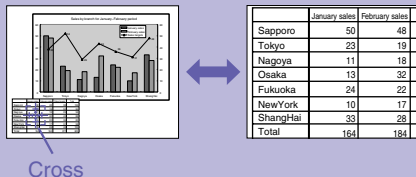

E-Zoom Function

This function lets you enlarge and reduce parts of images such as graphs and tables that you would like to view in greater detail.

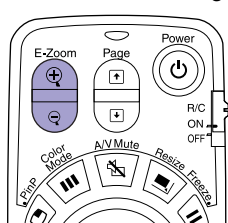

1. Press the  button.

A cursor (cross) will appear on the screen.

2. Move the cross to the area of the image that is to be enlarged.

Tilt the .

3. To enlarge: Press the .

To reduce the enlarged area size: Press the .

Press the  button to cancel.

 User's Guide "E-Zoom Function"

Momentarily turning off images and sound

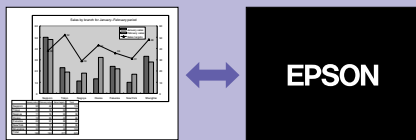

A/V Mute Function

You can use this function when you do not wish to show details of operations such as selecting different files.

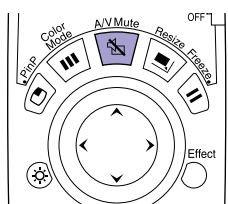

Press the  button.

The images and sound are turned off (A/V Mute active).

Press the  button once more.

The A/V Mute is cancelled.

 User's Guide "A/V Mute Function"

- If you use this function when projecting moving images, the images and sound will still continue to be played back by the source, and you cannot return to the point where the A/V Mute function was activated.
- You can use the "A/V Mute" command in the "Setting" menu to set the screen appearance when the images and sound have been paused to "Black", "Blue" or "Logo".

Emphasising parts of an image

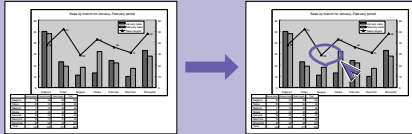

■ Effect Function

You can display a pointer icon and draw lines on the image being projected to emphasise parts of the image that you want to draw attention to.

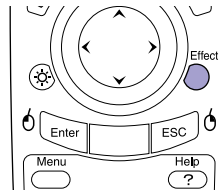

Using the pointer icon



1. Press the  button.

The pointer icon will appear.





The pointer type changes to one of three types each time the  button is pressed.

2. The pointer icon moves when the  button is tilted.

Drawing straight lines

1. Press the  button.
The pointer icon will appear.
2. Move the pointer icon to the starting point for the line.
3. Press the  button to set the starting point.
4. Move the pointer icon to the ending point for the line and press the  button to draw the line.

Drawing freehand curves

1. Press the  button.
The pointer icon will appear.
2. Move the pointer icon to the starting point for the line.
3. Press the  button for approximately 1.5 seconds so that the  button lights.
4. Tilt the  button to move the pointer icon and draw the line.
5. When the ending point is reached, press the  button.

Press the  button to clear effects. The pointer icon and lines will all be cleared.

 User's Guide "Effect Function"

The type, size and movement speed of the pointer icon and the colours and thicknesses of the lines drawn can be set using the "Effect" menu.

Other useful functions

Brightness Control

(EMP-8300 only)

This lets you set the lamp brightness to one of two settings. Select "Low" if the images being projected are too bright such as when projecting images in a dark room or onto a small screen. When used at low brightness, the life of the lamp will be extended.

 **User's Guide**
"Advanced2 Menu"

Freeze Function



The images are paused and unpaused each time this button is pressed.

 **User's Guide**
"Freeze Function"

P in P Function



This function lets you display separate images in a smaller screen (sub-screen) over the top of the images that are currently being projected (main screen).

 **User's Guide**
"P in P (Picture in Picture) Function"

Standby Monitor Out

This function lets you select the input source for projected images while viewing the image contents on an external monitor. Images can be checked on an external monitor while using the "A/V Mute" function and while the projector is not projecting images (while it is in standby mode).

 **User's Guide**
"Connecting to an External Monitor"

Projector ID/ Remote Control ID



If using more than one projector at a time, such as at a show, you can record ID numbers for the projectors and for the remote controls in order to use a remote control to simultaneously operate only projectors with the same ID number.

 **User's Guide**
"Projector ID/Remote Control ID"

Network monitoring and control

This lets you monitor multiple projectors and turn their power on and off and change the signal sources via a network. In addition, if a problem occurs with the projector, the projector can send an e-mail message to notify someone of the problem.

 **User's Guide**
"Projector Monitoring and Control using a Network"

List of Configuration Setting Menu

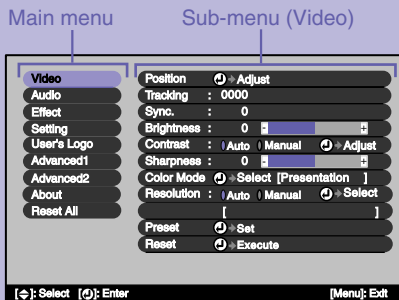

Video	During computer (analogue RGB) input	During computer (digital RGB) input	During component video (YCbCr or YPbPr) input	During S-Video or composite video input	During RGB video input
	Position Tracking Sync. Brightness Contrast Sharpness Color Mode Resolution Preset Reset	Brightness Contrast Sharpness Color Mode Reset	Position Brightness Contrast Color Tint Sharpness Color Mode Reset	Position Brightness Contrast Color Tint Sharpness Color Mode Video Signal Reset	Position Brightness Contrast Sharpness Color Mode Reset

Audio
Volume Treble Bass Reset

Effect
Pointer/Line1 Pointer/Line2 Pointer/Line3 Pointer Speed Reset

Setting
Keystone P in P No-Signal Msg. Message A/V Mute Computer1 Input Computer2 Input BNC Input Sleep Mode Reset

User's Logo
Execute

Advanced1
Startup Screen Progressive Color Adjustment Black Level White Level Rear Proj. Ceiling Standby Mode Language Reset

Advanced2
Brightness Control(EMP-8300 only) Projector ID Network COM Port Auto Setup BNC Sync Termination Direct Power ON(EMP-9300 only) Reset

About	During computer (analogue RGB, digital RGB) / component video (YCbCr, YPbPr) / RGB video input	During S-Video or composite video input
	Lamp Reset Lamp Timer Source Input Signal Frequency SYNC Polarity SYNC Mode Resolution Refresh Rate	Lamp Reset Lamp Timer Source Video Signal

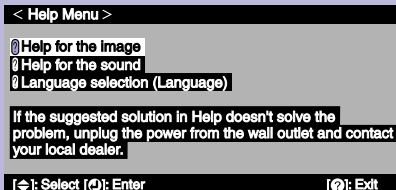

Reset All
Execute

Using the help function

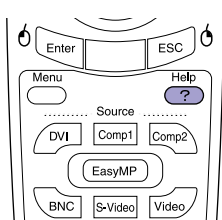

If a problem occurs with the projector, the Help function uses on-screen displays to assist you in solving the problem. It uses a series of menus in a question and answer format.



1. Press the  button.
2. Use the  button to select an item to view.
3. Press the  button to view the item.

Press the  button to return to the previous screen.

Press the  button to cancel the Help function.

Items that can be adjusted from the Help menus

If you select any of the following items that are currently occurring, a setting window will be displayed allowing you to make a direct adjustment.

■ Help for the image

The image is disturbed	Auto Setup (The entire image seems to flicker) Sync. (Vertical line noise appears on the screen) Tracking Video Signal
The image is not displayed fully on the screen	Tracking Position
The color of the image is abnormal	Color Tint
The image is too dark	Brightness Contrast Brightness Control
The image is distorted	V-Keystone Quick Corner

■ Help for the sound

There is no sound	Volume
■ Language selection (Language)	
Language	
If the message "No Signal." appears on the screen, you can also use the Help function to make the setting.	
No image appears on the screen.	Source

If you cannot select computer images or the images do not project correctly

If a problem occurs with the projected images even though the projector is set up and connected correctly, check the following points.

If the following does not solve the problem

 **User's Guide "When the Indicators Provide No Help"**

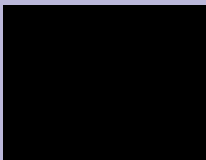

The computer cannot be selected as the image source

Were the projector and computer connected while their power was already turned on?

If the connection is made while the power is already turned on, the function [Fn] key that switches the computer's video signal to external output may not work. Turn the power for the connected computer and the projector off and then back on.

Is the computer display output set to only the computer's accessory screen?

The video signals will be output externally. Change the output setting to an external destination only or to an external destination as well as the computer's own monitor.

 **Computer documentation, under a title such as "External output" or "Connecting an external monitor"**

Do the input signal settings match the projector settings? (When connected to the [BNC] port)

Repeatedly press the  button on the remote control or use the "BNC Input" command in the "Setting" menu to select the format that matches the equipment signal.

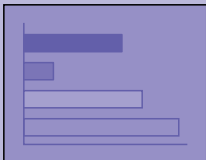

Images appear greenish or purplish

Do the input signal settings match the projector settings? (When connected to the [BNC] port)

Repeatedly press the  button on the remote control or use the "BNC Input" command in the "Setting" menu to select the format that matches the equipment signal.

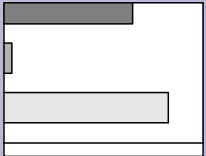

Only part of the images are displayed
Only part of the images are projected

Has the computer been set for dual display?

Cancel the dual display setting in the connected computer's Control Panel.

 **Computer documentation, under a title such as "Video driver"**

Reading the indicators



The projector is provided with indicators to notify you of the operating status of the projector.

The following tables show what the indicators mean and how to remedy the problems that they indicate.

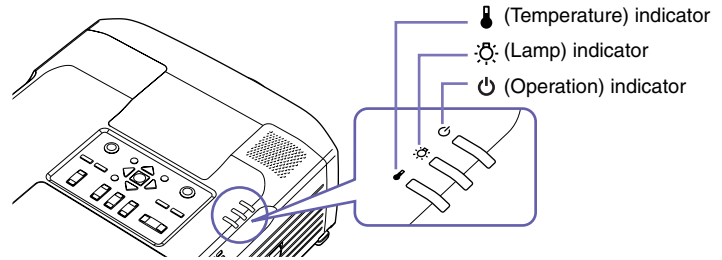
 **User's Guide**
"Reading the Indicators"



If the indicator is flashing or lit red Problem/Warning

 lit  flashing  off



		Red
		Red
		Red



Internal error

 **Disconnect the power cable from the electrical outlet. Then contact your dealer or the nearest address provided in the "International Warranty Conditions" section of the *Safety Instructions/World Wide Warranty Terms* booklet.**

		Red
		
		Red

**Fan related error/
Sensor error**

 **Check if the lamp is broken. Disconnect the power plug from the electrical outlet and wait for the lamp to cool down sufficiently (takes about one hour) before checking.**  **User's Guide "Replacing the Lamp"**

		Red
		Red
		

**Lamp cover is open error./
Lamp timer failure/Lamp out**

If the lamp is not broken

Replace the lamp and then turn the power on.

If the lamp still does not turn on, replace it with a new lamp.

If the problem is still not solved after the lamp is replaced, stop using the projector and disconnect the power cable from the electrical outlet. Then contact your dealer or the nearest address provided in the "International Warranty Conditions" section of the *Safety Instructions/World Wide Warranty Terms* booklet.

If the lamp is broken

Contact your local dealer for further advice.



Internal temperature error (overheating)



The lamp will switch off automatically and projection will stop. Wait for approximately 5 minutes. After this, check the points to the right. (With the EMP-8300, disconnect the power plug first.)

- If the projector is close to a wall, move it away from the wall.
- Clean the air filters if they are blocked.

If the problem is not fixed, stop using the projector and disconnect the power plug from the electrical outlet. Then contact your dealer or the nearest address provided in the "International Warranty Conditions" section of the *Safety Instructions/World Wide Warranty Terms* booklet.

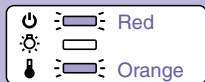



High-speed cooling in progress



If you continue using the projector and the temperature rises again, the lamp will switch off automatically. Check the points to the right.

If the  indicator is flashing orange **Warning**

 lit  flashing  off





Lamp replacement notification



The lamp is near the end of its operating life. Replace the lamp with a new one as soon as possible. If you continue to use the old lamp, the possibility that the lamp may break will increase.

 **User's Guide "Replacing the Lamp"**

 Indicator is lit or flashing green or orange **Normal**

 lit  flashing  off

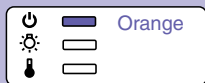

Standby condition

Power



If you press the  button, projection will start after warm-up is complete.



Warm-up in progress

Warm-up time is approximately 40 seconds. After warm-up is complete, the indicator will change to steady green and projection will start.



Projection in progress

Normal operation is in progress.

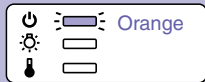

Cool-down in progress

Cool-down time is approximately 30 seconds. After cool-down is complete, the projector goes into standby mode. You cannot use the remote control or the projector's control panel during cool-down.

List of Supported Monitor Displays

Signal	Refresh rate (Hz)	Resolution (dots)	Resolutions for resized display (dots)	
			EMP-9300	EMP-8300
EGA		640 × 350	1400 × 766	1024 × 560
VGACGA		640 × 400	1400 × 875	1024 × 640
VGAEGA		640 × 350	1400 × 766	1024 × 560
VGA text		720 × 400	1400 × 778	1024 × 569
		720 × 350	1400 × 680	1024 × 498
VGA	60/72/75/85/100/120, iMac*1	640 × 480	1400 × 1050	1024 × 768
SVGA	56/60/72/75/85/100/120, iMac*1	800 × 600	1400 × 1050	1024 × 768
XGA	60/70/75/85/100, iMac*1	1024 × 768	1400 × 1050	1024 × 768
SXGA	60/70/75/85	1152 × 864*2	1400 × 1050	1024 × 768
SXGA	60/75/85	1280 × 960*2	1400 × 1050	1024 × 768
		1280 × 1024*2	1312 × 1050	960 × 768
SXGA+	60	1400 × 1050*2	1400 × 1050	1024 × 768
UXGA	60/65/70/75/80/85	1600 × 1200*2	1400 × 1050	1024 × 768
MAC13"		640 × 480	1400 × 1050	1024 × 768
MAC16"		832 × 624	1400 × 1050	1024 × 768
MAC19"		1024 × 768	1400 × 1050	1024 × 768
MAC21"		1152 × 870*2	1400 × 1050	1016 × 768
SDTV (525i,525p,625i,625p)			1400 × 1050 (4:3 aspect ratio)	1024 × 768 (4:3 aspect ratio)
			1400 × 788 (16:9 aspect ratio)	1024 × 576 (16:9 aspect ratio)
HDTV(750p)			1400 × 788	1024 × 576
HDTV(1125i,1125p)			1400 × 788	1024 × 576

*1 Connection is not possible if the equipment does not have a VGA output port.

*2 The resolution for real display is the virtual (window) display resolution.
It may be possible to project signals which are not listed in the above table.
However, not all functions may be supportable with such signals.

