

# EPSON

Color Ink Jet Printer

## EPSON STYLUS™ COLOR 680

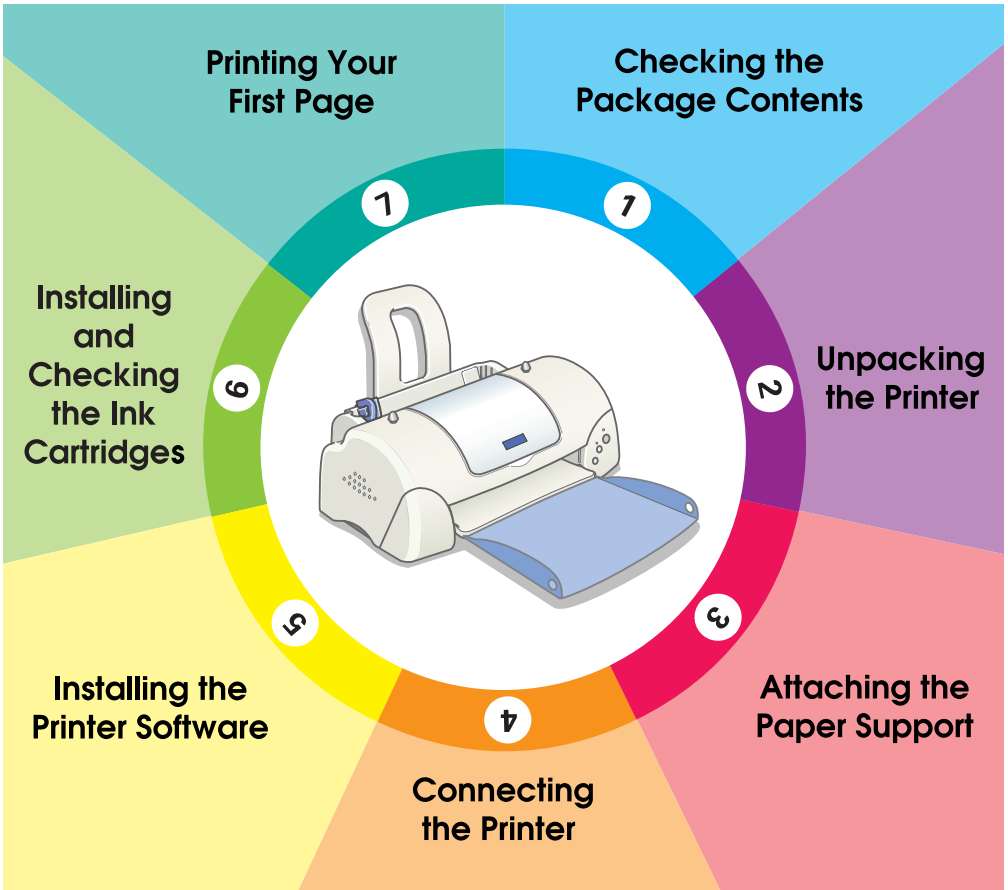

# Setup Guide

# 1

## Checking the Package Contents

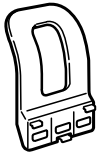

paper support



printer software &  
Reference Guide  
CD-ROM



ink cartridge package  
(contains both black and  
color ink cartridges.)

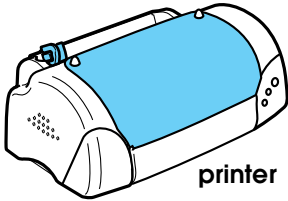

printer

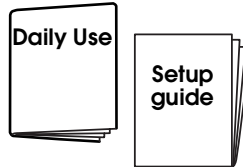

paper manuals



power cord\*

\* The power cord may come  
attached to the printer in  
certain locations.

The package contents may vary in certain locations.

Packaged with your printer are both black and color ink cartridges to start you printing straight away. In order to ensure your printer produces the highest quality printouts, some of the ink will be used in the initial setup and check process. This will not happen with your next set of cartridges.

**Please note:** the use of genuine EPSON consumables is recommended to ensure that printout quality and trouble-free operation is maintained.

# 2

## Unpacking the printer

Remove all tape and protective materials from the printer and lift the top corners of the output tray off of the knobs on the top of the printer to lower it.

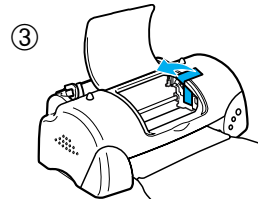
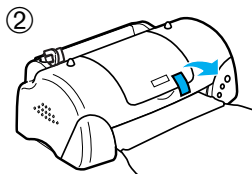
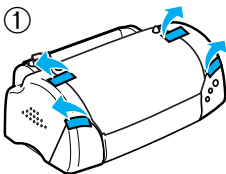

If the output tray is curled, bend both sides of the tray upwards at the seams.

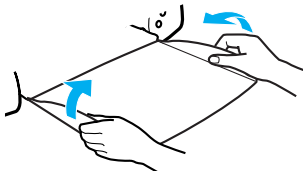

# 3

## Attaching the Paper Support

Insert the paper support into the slots at the rear of the printer and place the printer on a flat, stable surface.

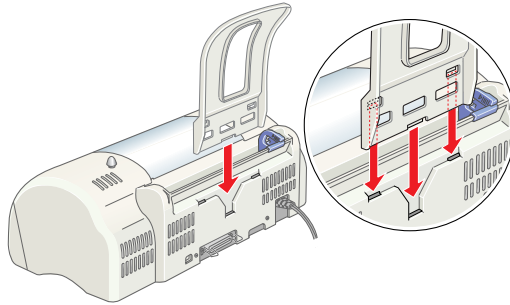

# 4

## Connecting the Printer

Your printer connects to your computer via the parallel or USB interface. Macintosh computers can only be connected via the USB interface. Depending upon your geographic location, you may need to obtain the appropriate cable. See “Options and Consumable Products” in the *Daily Use* guide for details.

### Note:

- ❑ *In order to connect your PC via the USB interface, your computer must be a Windows 98 or Windows 2000 pre-installed model that is equipped with a USB port.*
- ❑ *If you use a USB hub, we recommend that you connect the printer to the first tier of the hub, or connect the printer directly to the computer’s USB port.*

### **Using a parallel interface for Windows users**

To connect the printer to your PC, you need a shielded, twisted-pair parallel cable. Follow the directions below.

1. Make sure that both the printer and the computer are turned off.

2. Plug the cable connector securely into the printer's interface connector. Then squeeze the wire clips together until they lock in place on both sides. If your printer has a ground connector screw to the right of the interface connector, connect the ground wire to the ground connector screw.
3. Plug the other end of the cable into the computer's parallel interface. If there is a ground wire at the computer end of the cable, connect it to the ground connector at the back of the computer.

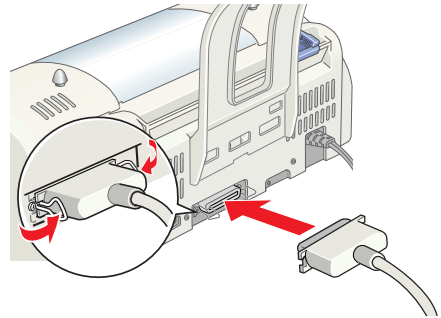

## ***Using a USB interface for Windows and Macintosh users***

To connect the printer to a USB port, you need a standard shielded USB cable. Follow these steps.

1. Make sure that both the printer and the computer are turned off.
2. Plug the appropriate end of the cable into the USB port on the back of the printer. (The end that fits the printer has a different shape from the end that fits the computer.)
3. Connect the other end of the cable to the computer's USB port.

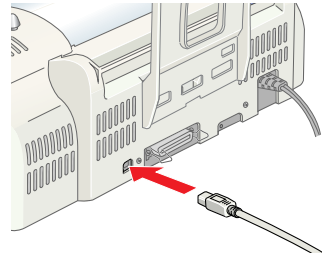

# 5

## **Installing the Printer Software**

After connecting the printer to your computer, you need to install the software included on the "Printer Software for EPSON Stylus COLOR 680" CD-ROM shipped with your printer.





Your printer software includes:

Printer driver and utilities

The printer driver runs, or “drives,” your printer; use it to make settings such as print quality, speed, media type, and paper size. The Nozzle Check, Head Cleaning, and Print Head Alignment utilities help you keep your printer in top operating condition. EPSON Status Monitor 3 (for Windows 98, 95, 2000, and NT 4.0) or EPSON StatusMonitor (for Macintosh) notifies you of printer errors and displays printer status information such as the amount of ink remaining. The Status Monitor also guides you through the ink replacement process.

Online guides

The online *Reference Guide* helps you learn more about your printer.

If you are using the floppy disk version of the software, make a backup copy of the EPSON printer software disk before you begin installation. If you wish to make a floppy disk version of the printer software on your CD-ROM, you can use the driver disk creation utility included on the CD.

Refer to the appropriate section below.

## ***Installing in Windows 98, 95, 2000, and NT 4.0***

Follow the instructions in this section to install the printer software and then, for Windows 98 and Windows 2000 USB users, to ensure that the USB driver is installed correctly.

### ***Note:***

*When using Windows 2000, you must follow the steps below to install the printer software; otherwise, Microsoft’s Universal driver may be installed instead. To check if the Universal driver has been installed, open the Printers folder and right-click the icon for your printer. To open the printer driver, click Printer Preferences on the shortcut menu that appears, then right-click anywhere in the driver. If About is displayed in the shortcut menu that appears, click it. A message box with the words “Unidrv Printer Driver” appears. You must reinstall the printer software as described below. If About is not displayed, the printer software has been installed correctly.*

*If the Digital Signature Not Found dialog box appears during the installation process, click Yes. If you click No, you will have to return to step 1 and install the printer software again.*

## ***Installing the printer software***

Follow these steps to install the printer software.

1. Make sure that your printer is turned off.

2. Turn on your computer and start Windows. If the New Hardware Found dialog box or any other Wizard appears, click Cancel.
3. Insert the printer software CD shipped with your printer in the CD-ROM drive. The Installer dialog box appears. (For floppy disk users, insert the disk in the floppy-disk drive and double-click the My Computer icon, the floppy disk drive icon, and then Setup.exe.)
4. Select Install Printer Driver/Utility, and click . Then, click OK in the dialog box that appears to start the printer software installation.

**Note:**

*It is possible to install the Reference Guide on your hard drive from the Installer dialog box, as shown above. To install the guide, click Online Guide and then . Then, click Install Reference Guide and follow the on-screen instructions. When the installation is complete, an ESC680 Guide icon appears in the EPSON folder. Double-click the icon to open the guide.*



5. Follow the on-screen instructions to turn on your printer.  
For Windows 98 users, the printer port configuration starts automatically.

For printers connected via the USB cable, the USB device driver installation starts automatically at this point. When a message appears asking you to restart your computer, do so.

6. After turning on the printer, the Setup utility opens automatically. Follow the on-screen instructions to install the ink cartridges, check the print head nozzles, and clean the print head. When a message appears informing you that the setup is complete, click OK.



**Note:**

*If the Setup utility does not start, proceed to step **6** to install the ink cartridges using the printer's control panel.*

7. When a message appears informing you that the installation is complete, click OK.

**Note:**

*If an error message appears, either the printer driver or the EPSON USB printer device driver is not installed correctly. See "Troubleshooting" in the online-Reference Guide for details.*

After the setup is complete, proceed to step **7** to print your first page.

## **Ensuring that the USB driver is installed correctly for Windows 98 and Windows 2000 users**

Follow the directions below to confirm that the USB driver is installed correctly.

**Note:**

*The illustrations used in this section show the procedure for Windows 98.*

1. Click the Start button, point to Settings, and click Printers. Make sure that the icon for your printer appears in the Printers window.

Select the icon for your printer, then click Properties on the File menu.

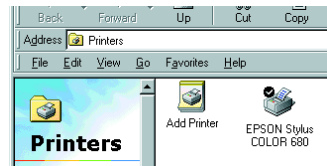

2. For Windows 98 users, click the Details tab and make sure that EPUSBX: (EPSON Stylus COLOR 680) is displayed in the Print to the following port list box. For Windows 2000 users, click the Ports tab and make sure that USBxxx, EPSON Stylus COLOR 680 is displayed in the Print to the following port(s) list box.

**Note:**

*If the correct port is not displayed, refer to the "Troubleshooting" section of the online Reference Guide.*

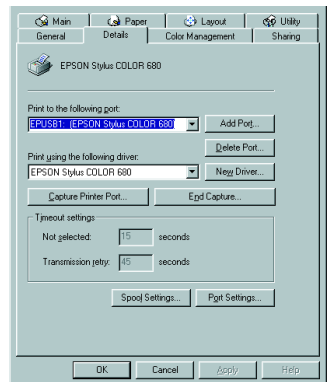

## Installing in Windows 3.1

Follow the steps below to install the printer software.

1. Make sure that Windows 3.1 is running and that the Program Manager window is open.
2. Insert the printer software CD that is shipped with your printer in the CD-ROM drive. (If you use the floppy disk version, insert it in the floppy-disk drive.)
3. Click Run on the File menu. The Run dialog box opens. In the Command Line box, type D:\SETUP and click OK. If the CD-ROM drive has a drive letter other than "D", or if you are using the floppy disk version, substitute the appropriate letter.
4. The installation program begins copying the printer software files.
5. When the installation is complete, click OK to exit the installation program.

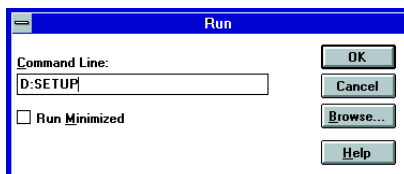

The installation program automatically selects this printer as the default printer for Windows applications.

## Installing in Macintosh

Follow the instructions in this section to install the printer software and then to select your printer in the Chooser.



### Caution:

*Turn off all virus protection programs before you install the printer software.*

## Installing the printer software

Follow these steps to install your printer software.

1. Turn on your Macintosh and insert the software CD in the CD-ROM drive. The EPSON printer software CD-ROM opens automatically.
2. If a single Installer icon appears, double-click the icon. If separate folders containing Installer icons for several languages appear, double-click the folder for your preferred language, then double-click the Installer icon inside it.







### Note:

*It is possible to install the Reference Guide on your hard drive from the printer software CD-ROM. To install the guide, click Install Reference Guide and follow the on-screen instructions. When the installation is complete, a View Reference Guide icon appears in the EPSON folder. Double-click the icon to open the guide.*

3. At the initial screen, click Continue. The Installer dialog box appears.
4. To install the printer software that is included on your printer software CD-ROM, make sure that the Install Location box displays the correct drive, then click Install.
5. When a message appears informing you that the installation is complete, click Restart to restart your computer.

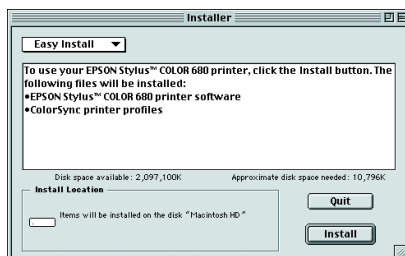

## Selecting your printer in the Chooser

After you have installed the printer software on your Macintosh, you need to open the Chooser and select your printer. You must select a printer the first time you use it or whenever you want to switch to another printer. Your Macintosh will always print using the last printer selected. Follow the steps below to select your printer in the Chooser.

1. Choose Chooser from the Apple menu. Then, select the icon for your printer and the port that your printer is connected to.
2. Select the appropriate Background Printing radio button to turn background printing on or off.

When background printing is on, you can use your Macintosh while it is preparing a document for printing. In order to use the EPSON Monitor3 utility to manage print jobs, background printing must be turned on.

3. Close the Chooser.

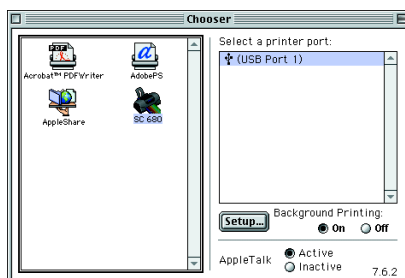

# 6

## Installing and Checking the Ink Cartridges

This printer uses ink cartridges equipped with IC chips. The IC chip accurately monitors the amount of ink used by each cartridge, so even if a cartridge is removed and inserted again, all of its ink can be used. However, some ink from both color and black ink cartridges is consumed each time a cartridge is inserted because the printer automatically checks reliability.

Be sure to use the ink cartridges packed with your printer the first time that you install ink cartridges.

Refer to the appropriate section below.

### ***Using the Setup utility for Windows 98, 95, 2000, and NT 4.0 users***

The Setup utility should open automatically when your printer software installation is complete. Follow the on-screen instructions. If you cannot access the Setup utility, refer to the next section.

### ***Using the printer's control panel***

If you are a Macintosh or Windows 3.1 user, or cannot access the Setup utility, use the printer's control panel to install the ink cartridges.

Before installing the ink cartridges, note the following.



#### ***Warning:***

*The ink cartridges are self-contained units. Under ordinary use, ink will not leak from a cartridge. If ink does get on your hands, wash them thoroughly with soap and water. If ink gets into your eyes, flush them immediately with water.*

#### ***Note:***

*Do not open the ink cartridge packages until just before you install them; otherwise, the ink may dry up.*

Follow the steps below to install the ink cartridges.

1. Lower the output tray, then open the printer cover.

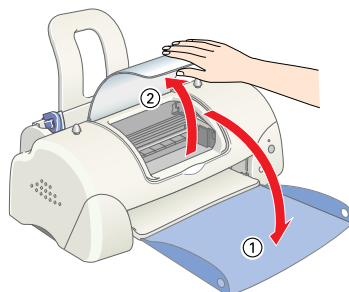

2. Turn on the printer by pressing the  power button.

The print head moves to the center, which is the ink cartridge installation position. The  power light flashes and the error light comes on.

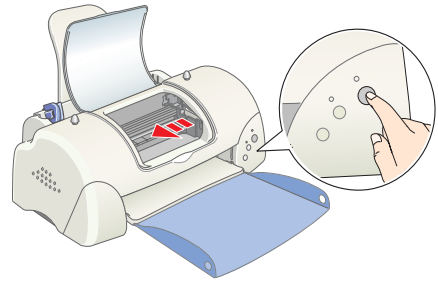

**Caution:**

*Do not move the print head by hand. Doing so may damage the printer.*

3. Push back the release tabs and lift up the ink cartridge clamps.

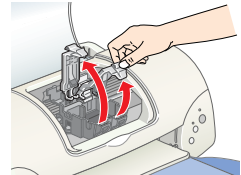

4. Open the ink cartridge packages. Next, remove only the yellow tape seals from each cartridge.

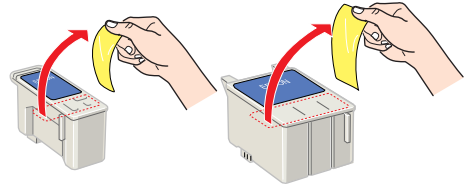

**Caution:**

- You must remove the yellow tape seals from the cartridges before installing them; otherwise, the cartridges will become unusable and you will be unable to print.*
- If you have installed an ink cartridge without removing the yellow tape seal, you must remove the cartridge and install a new one. Prepare the new cartridge by removing the yellow tape seal, then install it in the printer.*
- Do not remove the blue portion of the tape seal from the cartridges; otherwise, the cartridges may become unusable.*
- Do not remove the tape seals from the bottom of the cartridges; otherwise, ink will leak.*
- Do not touch the green IC chip on the side of the cartridge. Doing so may prevent normal operation and printing.*
- Do not remove the green IC chip from the side of the cartridge. If you install an ink cartridge without a chip, the printer may be damaged.*

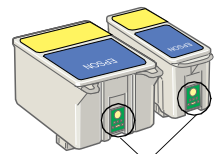

Do not touch this part.

- Align the tabs on each ink cartridge so that they are resting on the tabs protruding from the base of the opened ink cartridge clamps. Do not apply excessive force to the cartridges.

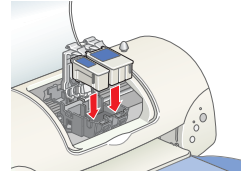



**Caution:**

*Make sure that the ink cartridge tabs are not under the tabs protruding from the base of the opened ink cartridge clamps, as this can damage the clamps.*

**Note:**

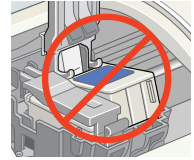
*Install both ink cartridges. If either of the cartridges is not installed, the printer will not work.*





- Lower the ink cartridge clamps until they lock into place.
- Press the  ink cartridge replacement button. The printer moves the print head and begins charging the ink delivery system. This process takes about two and a half minutes.

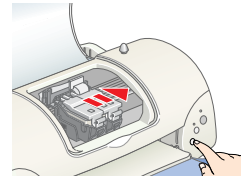

**Caution:**

*Always press the  ink cartridge replacement button to move the print head. Do not move the print head by hand. Doing so may damage the printer.*



While the ink is charging, the  power light flashes and the printer produces a variety of mechanical sounds. These sounds are normal. When the ink delivery system has been charged, the print head returns to the home (far right) position and the  power light comes on.



**Caution:**

*Never turn off the printer while the  power light is flashing.*

- Close the printer cover.

## Checking the printer

Before printing your first page, you need to make sure that the printer is working correctly by loading paper, then printing a nozzle check page and, if necessary, cleaning the print head. Refer to the appropriate section below.



## Loading paper

Follow the steps below to load plain paper in the printer.

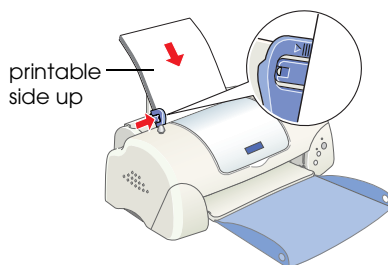

1. Lower the output tray and slide the left edge guide so that the distance between the edge guides is slightly wider than the width of your paper.
2. Fan a stack of paper, then tap it on a flat surface to even the edges.
3. Load the stack of paper in the sheet feeder with the printable side up and the right edge of the paper resting against the right edge guide. Then, slide the left edge guide against the left edge of the paper.



### Note:

- ❑ Always load paper into the sheet feeder short edge first.
- ❑ Make sure that the paper stack fits under the arrow mark inside the edge guide.

## Checking the print head nozzles

Make sure that the printer is turned off. Hold down the  maintenance button (① in the illustration) and press the  power button (② in the illustration) to turn on the printer. Then release only the power button first. When the printer starts the nozzle check, release the  maintenance button.

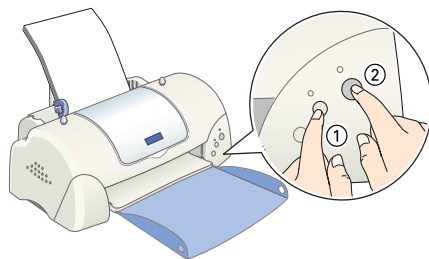

Below are sample printouts.

Good sample

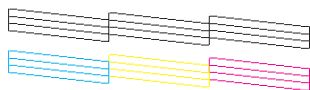

Print head needs to be cleaned

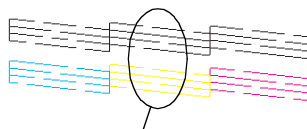

Segments are missing

If the nozzle check page does not print satisfactorily (for example, if any segment of the printed lines is missing), then you should clean the print head as explained below. If the printout is satisfactory, you are ready to print your first page. See “Printing Your First Page” for instructions.

## Cleaning the print head

Follow the steps below to clean the print head.

1. Make sure that the ⏻ power light is on and that the ⚠ error light is off.
2. Hold down the ⚠ maintenance button for three seconds.

The printer starts cleaning the print head and the ⏻ power light begins flashing. Print head cleaning takes about thirty seconds to complete.

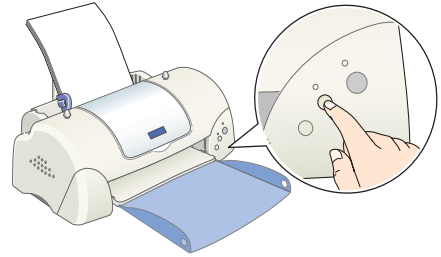

### **Caution:**

*Never turn off the printer while the ⏻ power light is flashing. Doing so may damage the printer.*

3. When the ⏻ power light stops flashing, print a nozzle check pattern to confirm that the head is clean and to reset the cleaning cycle.

If print quality hasn't improved after repeating the nozzle checking and cleaning procedures four or five times, contact your dealer.

# 7

## Printing Your First Page

After making sure that your printer is operating correctly, you are ready to print your first page. To familiarize yourself with the printer software, we recommend printing one of the sample files provided with your printer software. To print a sample file, follow the instructions for Windows or Macintosh in this section.

If you choose to print your own document instead, open the document in your application, then proceed to step 4 in the relevant section below, making changes where appropriate.

### **Note:**

- ❑ *See your software manual for details on how to use your application.*
- ❑ *Depending on the type of document you are printing and the type of paper you are using, you may have to make settings different from those described in this section.*

## For Windows users

Follow these steps to print the sample file.

### Note:

*If you encounter problems while printing, EPSON's Technical Support Web Site provides assistance. The Technical Support Web Site can be accessed through EPSON Status Monitor 3 or through the printer driver. For details, see the "Troubleshooting" section of online Reference Guide.*

1. Make sure that A4 or Letter size EPSON Photo Quality Ink Jet Paper is loaded in the printer.
2. Insert the printer driver CD in the CD-ROM drive. If the Installer dialog box appears, click  Quit.
3. Double-click the My Computer icon and then the CD-ROM icon. Then double-click the sample.bmp file to open it.
4. To change the printer driver settings, click Print on the File menu. A Print dialog box similar to the one on the right opens. (This example is from Paint).

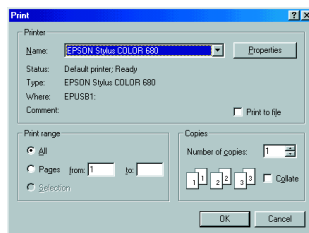

5. Make sure your printer is selected in the Name list box, then click Properties. The printer driver opens.
6. Click the Main tab, then click anywhere in the Media Type box and select Photo Quality Ink Jet Paper.
7. Select Color as the Ink setting.
8. Select Automatic as the Mode setting. When Automatic is selected, the printer software optimizes other settings according to the Media Type and Ink settings you make.
9. Click the Paper tab, then click anywhere in the Paper Size box and select the paper size that is loaded in the printer.
10. Click OK at the bottom of the printer driver window. You return to the Print dialog box (or a similar dialog box).
11. Click Close, Print, or OK to print. You may need to click a combination of these buttons.

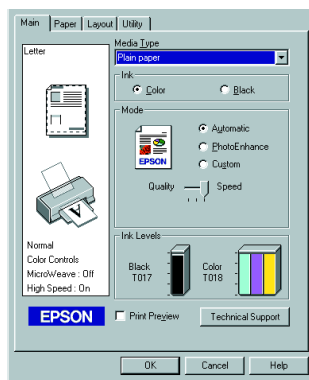

While printing, the EPSON Progress Meter (in Windows 98, 95, 2000 and NT 4.0) or the EPSON Despooler dialog box (in Windows 3.1) is displayed, showing the printing progress and the status of your printer.

## For Macintosh users

Follow these steps to print the sample file.

### Note:

It is possible to access Technical Support from the printer software CD-ROM. Insert the CD in the CD-ROM drive and double-click the Technical Support Web Site icon in the EPSON folder.

1. Make sure that A4 or Letter size paper is loaded in the printer.
2. Insert the printer software CD in the CD-ROM drive.
3. Open the EPSON folder and then double-click the README file.
4. Click Page Setup on the File menu. The following dialog box appears.

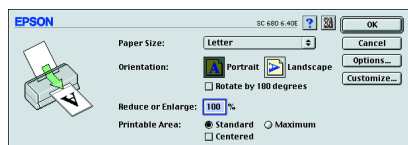

5. Select the paper size that is loaded in the printer from the Paper Size list.
6. Select  Portrait as the Orientation setting.
7. After making your settings, click OK to close the Page Setup dialog box.

### Note:

You cannot print from the Page Setup dialog box. You can only print from the Print dialog box.

8. Click Print on the File menu. The Print dialog box appears.

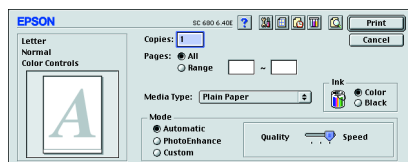

9. Select Plain Paper from the Media Type list.
10. Select Color as the Ink option.
11. Select Automatic as the Mode setting. This causes the printer software to optimize other settings according to the Media Type and Ink settings that you make.
12. Click Print to start printing.

While printing is in progress, the EPSON Progress Meter is displayed, showing the printing progress and the status of your printer.