

EPSON

Ink Jet Printer

EPSON *Stylus*™ COLOR 400

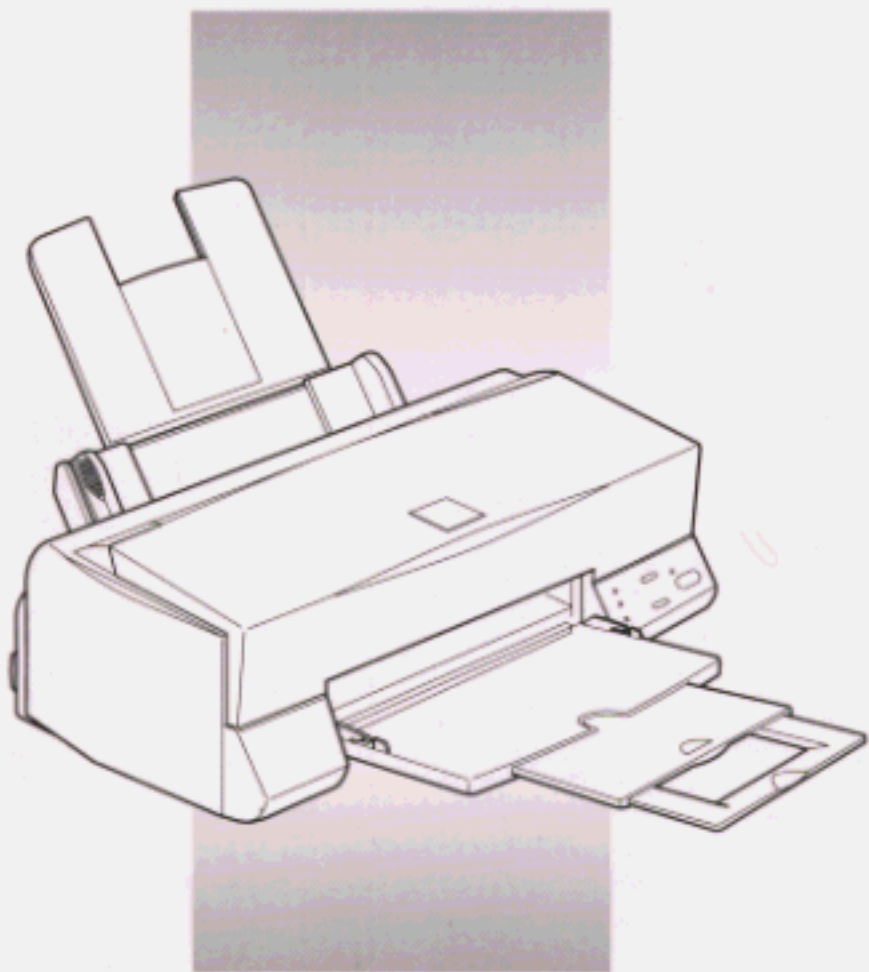

User's Guide

Where to Find Information

This User's Guide

Provides you with all the information you need to use your EPSON Stylus COLOR 400 and consumable products, from setting up to troubleshooting.

Online Help (CD-ROM)

Provides you with detailed information and instructions on the Windows printer software that controls your printer. Online help will be automatically installed when you install the printer software. See Chapter 3 for information on accessing online help.

EPSON Answers (CD-ROM)

Provides you with additional information on using your printer and printing with colors. Here's what you'll find in EPSON Answers:

- ❑ **How To** displays a step-by-step guide for using your printer, information about printer maintenance, and instructions on replacing consumable products.
- ❑ **Problem Solver** helps you fix common printing problems when you encounter them.
- ❑ **Test Print** lets you print a test page to check the results of settings you have made and provides links to other sections of EPSON Answers based on the results.
- ❑ **Color Guide** explains the ABC's of color printing and shows you how to get impressive results from your printer.

EPSON Stylus™ COLOR 400

Color Ink Jet Printer

All rights reserved. No part of this publication may be reproduced, stored in a retrieval system, or transmitted in any form or by any means, electronic, mechanical, photocopying, recording, or otherwise, without the prior written permission of SEIKO EPSON CORP. The information contained herein is designed only for use with this EPSON printer. EPSON is not responsible for any use of this information as applied to other printers.

Neither SEIKO EPSON CORP. nor its affiliates shall be liable to the purchaser of this product or third parties for damages, losses, costs, or expenses incurred by purchaser or third parties as a result of: accident, misuse, or abuse of this product or unauthorized modifications, repairs, or alterations to this product, or (excluding the U.S.) failure to strictly comply with SEIKO EPSON CORP.'s operating and maintenance instructions.

SEIKO EPSON CORP. shall not be liable for any damages or problems arising from the use of any options or any consumable products other than those designated as Original EPSON Products or EPSON Approved Products by SEIKO EPSON CORP.

EPSON and EPSON ESC/P are registered trademarks and EPSON ESC/P Raster and EPSON Stylus are trademarks of SEIKO EPSON CORP.

Microsoft and Windows are registered trademarks of Microsoft Corporation. IBM is a registered trademark of International Business Machines Corporation.

General Notice: *Other product names used herein are for identification purposes only and may be trademarks of their respective owners. EPSON disclaims any and all rights in those marks.*

Copyright © 1996 by SEIKO EPSON CORPORATION, Nagano, Japan.



Printed on Recycled Paper.

User's Guide

Declaration of Conformity

According to ISO/IEC Guide 22 and EN 45014

Manufacturer: SEIKO EPSON CORPORATION
Address: 3-5, Owa 3-chome, Suwa-shi,
Nagano-ken 392 Japan

Representative: EPSON EUROPE B.V.
Address: Prof. J. H. Bavincklaan 5 1183
AT Amstelveen
The Netherlands

Declares that the Product:

Product Name: Ink Jet Printer
Type Name: EPSON Stylus COLOR 400
Model: P950A

Conforms to the following Directive(s) and Norm(s):

Directive 89/336/EEC:

EN 55022 class B
EN 61000-3-2
EN 61000-3-3
EN 50082-1
IEC 801-2
IEC 801-3
IEC 801-4

Directive 73/23/EEC:

EN 60950

October 1996

M. Hamamoto
President of EPSON EUROPE B.V.

Contents

Safety Information

Important Safety Instructions	1
A few precautions	2
ENERGY STAR Compliance	3
For United Kingdom Users	4
Warnings, Cautions, and Notes	5

Chapter 1 Getting to Know Your Printer

Printer Parts and Control Panel Functions	1-2
System Requirements	1-4
Options and Consumable Products	1-4

Chapter 2 Getting Started

Unpacking the Printer	2-2
Choosing a Place for the Printer	2-3
Using a printer stand	2-4
Attaching the Paper Support	2-4
Plugging in the Printer	2-5
Installing the Ink Cartridges	2-6
Connecting the Printer to Your PC	2-11
Installing the Printer Software	2-12
Installing in Windows 95	2-13
Installing in Windows 95 (using plug-and-play)	2-14
Installing in Windows 3.1	2-18
Loading Paper	2-20
Starting to Print	2-22

Chapter 3 *Using the Printer Software*

Checking Your Printer Driver Settings	3-2
How to access the printer driver settings	3-3
How to check the settings	3-4
Making Changes to Printer Driver Settings	3-6
Using the Automatic setting	3-7
Using the predefined settings	3-8
Customizing the print settings	3-10
Making the Media Type setting	3-12
Using the Printer Utilities	3-14
Status Monitor	3-15
Nozzle Check	3-16
Head Cleaning	3-16
Print Head Alignment	3-16
Checking Printer Status	3-17
Understanding the EPSON Spool Manager	3-17
Understanding the Despooler	3-18
Getting Information Through Online Help	3-19
From Windows applications	3-19
From Windows 95	3-19
From Windows 3.1	3-19

Chapter 4 *Printing on Special Paper*

Loading Special Paper and Other Media	4-2
About special media cleaning sheets	4-5
Loading Envelopes	4-6
Loading Transparencies	4-7
Using EPSON Photo Paper (S041134)	4-8
Loading	4-8
Removing the perforated margins	4-10
Storing EPSON Photo Paper	4-10

Chapter 5 Maintenance and Transportation

Replacing an Ink Cartridge	5-2
Cleaning the Printer	5-7
Transporting the Printer	5-8

Chapter 6 Troubleshooting

Diagnosing the Problem	6-2
Error indicators	6-2
Status Monitor	6-4
Printer operation check	6-4
Problems and Solutions	6-7
Power supply	6-7
Operation	6-8
Paper handling	6-13
Printing quality	6-16
Increasing the Print Speed	6-23
Cleaning the Print Head	6-25
Aligning the Print Head	6-28
Ink Cartridge Problems	6-28
Contacting Customer Support	6-30
For United Kingdom and the Republic of Ireland users	6-30
For Australian users	6-33
For Hong Kong and Singapore users	6-35
For Philippines users	6-36

Appendix A Tips for Color Printing

Basics of Color	A-2
Image Resolution and Image Size	A-5
Guidelines for Using Color	A-7

Appendix B Printer Specifications

Printing	B-2
Paper	B-3
Printable area	B-5
Ink Cartridges	B-6
Mechanical	B-7
Electrical	B-8
Environmental	B-8
Safety Approvals	B-9

Glossary

Index

Safety Information

Important Safety Instructions

Read all of these instructions and save them for later reference. Follow all warnings and instructions marked on the printer.

- Do not place the printer on an unstable surface or near a radiator or heat source.
- Place the printer on a flat surface. The printer will not operate properly if it is tilted or at an angle.
- Do not block or cover the openings in the printer's cabinet. Do not insert objects through the slots.
- Use only the type of power source indicated on the printer's label.
- Connect all equipment to properly grounded power outlets. Avoid using outlets on the same circuit as photocopiers or air control systems that regularly switch on and off.
- Do not use a damaged or frayed power cord.
- If you use an extension cord with the printer, make sure the total ampere rating of the devices plugged into the extension cord does not exceed the cord's ampere rating. Also, make sure the total ampere rating of all devices plugged into the wall outlet does not exceed the wall outlet's ampere rating.
- Unplug the printer before cleaning. Clean with a damp cloth only. Do not spill liquid on the printer.
- Except as specifically explained in this guide, do not attempt to service the printer yourself.

- ❑ Unplug the printer and refer servicing to qualified service personnel under the following conditions:

If the power cord or plug is damaged; if liquid has entered the printer; if the printer has been dropped or the cabinet damaged; if the printer does not operate normally or exhibits a distinct change in performance. Adjust only those controls that are covered by the operating instructions.

- ❑ If you plan to use the printer in Germany, observe the following:

To provide adequate short-circuit protection and over-current protection for this printer, the building installation must be protected by a 16 Amp circuit breaker.

Bei Anschluß des Druckers an die Stromversorgung muß sichergestellt werden, daß die Gebäudeinstallation mit einem 16 A-Überstromschalter abgesichert ist.

A few precautions

Even if you are familiar with other types of printers, be sure to read through the following list of precautions before operating your ink jet printer.

- ❑ Do not put your hand inside the printer or touch the ink cartridges during printing.
- ❑ Under normal circumstances, ink will not come out of the cartridges. If ink gets on your skin, wash it off with soap and water. If it gets in your eyes, flush them immediately with water.
- ❑ Keep ink cartridges out of the reach of children.
- ❑ Do not dismantle the ink cartridges or try to refill them. This could result in damage to the print head.

- ❑ Once you install an ink cartridge, do not open the clamp or remove the cartridge except to replace it with a new one. The cartridge may become unusable otherwise.
- ❑ Install the ink cartridge immediately after you remove it from its package. Leaving the cartridge unpacked for a long time before use may result in reduced print quality.
- ❑ Do not use an ink cartridge beyond the date printed on the cartridge carton. For best results, use up the ink cartridges within six months of installing them.
- ❑ Do not shake an ink cartridge; this can cause leakage.
- ❑ Always turn the printer off using the ⏻ power button. The ⏻ power light flashes until the print head is capped, which means it is at rest in the far right position. Do not unplug the printer or turn off the power to the outlet until the ⏻ power light stops flashing. The printer caps the print head when no data is received for several seconds.
- ❑ Before transporting the printer, make sure the print head is capped (in the far right position) and the ink cartridges are in place.

ENERGY STAR Compliance



As an ENERGY STAR Partner, EPSON has determined that this product meets the ENERGY STAR guidelines for energy efficiency.

The International ENERGY STAR Office Equipment Program is a voluntary partnership with the computer and office equipment industry to promote the introduction of energy-efficient personal computers, monitors, printers, fax machines, and copiers in an effort to reduce air pollution caused by power generation.

For United Kingdom Users

Use of options

EPSON (UK) Limited shall not be liable against any damages or problems arising from the use of any options or consumable products other than those designated as Original EPSON Products or EPSON Approved Products by EPSON (UK) Limited.

Safety information



Warning: *This appliance must be earthed. Refer to rating plate for voltage and check that the appliance voltage corresponds to the supply voltage.*

Important: *The wires in the mains lead fitted to this appliance are coloured in accordance with the following code:*

Green and yellow — Earth

Blue — Neutral

Brown — Live

If you have to fit a plug:

As the colours of the mains lead of this appliance may not match coloured markings used to identify the terminals in a plug, please proceed as follows:

The green and yellow wire must be connected to the terminal in the plug which is marked with the letter E or the Earth symbol (\perp).

The blue wire must be connected to the terminal in the plug marked with the letter N.

The brown wire must be connected to the terminal in the plug marked with the letter L.

If damage occurs to the plug, replace the cord set or consult a qualified electrician.

Replace fuses only with a fuse of the correct size and rating.

Warnings, Cautions, and Notes



Warnings must be followed carefully to avoid bodily injury.



Cautions must be observed to avoid damage to your equipment.

Notes contain important information and useful tips on the operation of your printer.

Printer Parts and Control Panel Functions 1-2





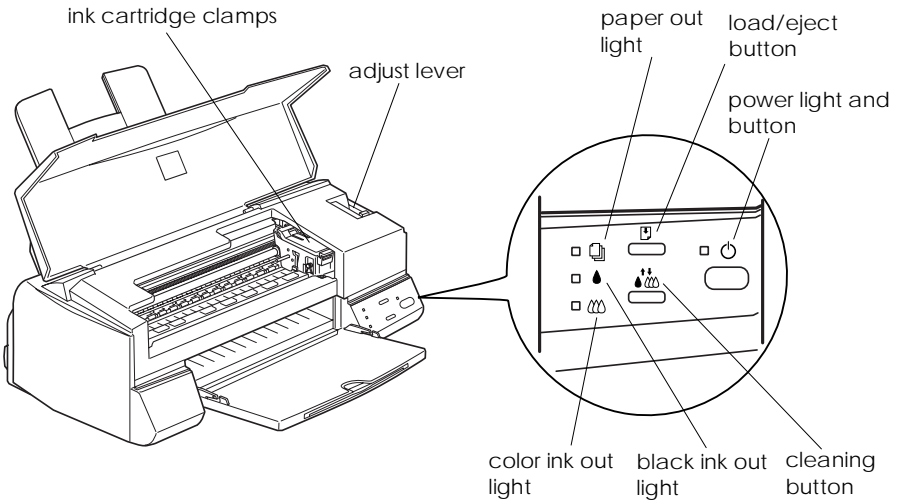
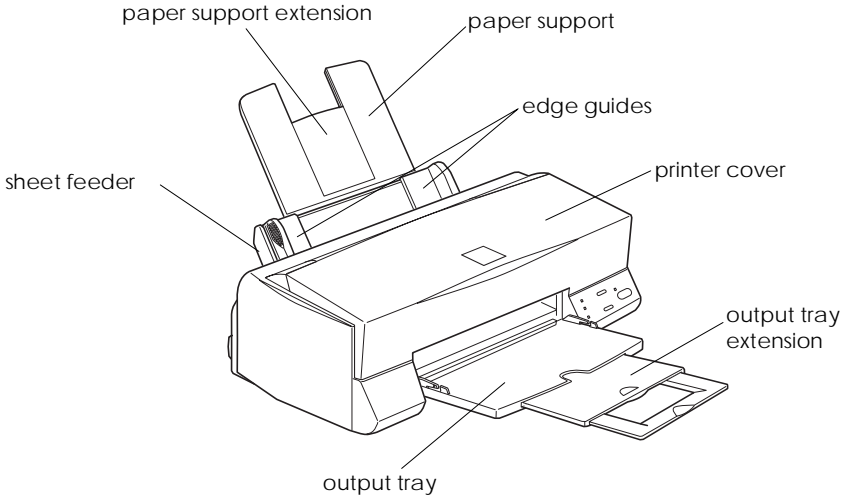

System Requirements 1-4

Options and Consumable Products 1-4

Printer Parts and Control Panel Functions







Buttons

Button	Function
 Power	Turns the printer on and off. Resets the printer if pressed twice while the power is on, which means it clears the printer's memory.
 Load/Eject	Loads or ejects paper if pressed and released within 2 seconds. Resumes printing if pressed and released after a paper out error.
 Cleaning	Moves the print head to the ink cartridge replacement position if pressed for 3 seconds while the  or  ink out light is flashing or on. Returns the print head to its home position after ink cartridge replacement. Performs print head cleaning if pressed for 3 seconds when the  or  ink out light is off.

Lights

The lights on the front of the printer indicate the printer status, such as receiving data, paper jam, or low on ink. The following table describes what the lights mean.

				Printer Status
○	-	-	-	Printer is on.
◐	-	-	-	Receiving data, replacing an ink cartridge, charging ink, or cleaning the print head.
-	○	-	-	Paper out. Load paper in the sheet feeder; then press the  load/eject button to resume printing.
-	◐	●	●	Paper jam. Take all the paper out of the feeder, and reload the paper. If the light continues to flash, turn off the printer and gently pull all the paper out of the printer.
-	-	◐	-	Ink low. The black ink cartridge is nearly empty. Obtain a black ink cartridge (S020093).
-	-	○	-	Ink out. The black ink cartridge is empty. Replace the black ink cartridge (S020093).
-	-	-	◐	Ink low. The color ink cartridge is nearly empty. Obtain a color ink cartridge (S020089).
-	-	-	○	Ink out. The color ink cartridge is empty. Replace the color ink cartridge (S020089).

○ = on, ● = off, ◐ = flashing, - = irrelevant

System Requirements

When using your printer with a PC, you need Microsoft® Windows 3.1 or Windows 95; a shielded, twisted-pair parallel cable; and the following:

Minimum system	Recommended system
80386/16 MHz processor	Pentium processor
16MB RAM	32MB RAM
20MB hard disk space	More than 50MB free hard disk space
VGA monitor	VGA or better monitor

Note:

See the minimum system requirements on the inside of the CD-ROM cover before using or installing the EPSON Answers software.

Your computer dealer can help you update your system if it does not meet these requirements.

Options and Consumable Products

Interface cables

EPSON supplies several types of interface cables. You can use any interface cable that meets the specifications listed below. See your computer manual for any additional requirements.

Parallel Interface Cable (shielded) C83602 from D-SUB 25-pin (computer) to 36-pin Amphenol 57 Series (printer)

Ink cartridges

Black ink cartridge	S020093
Color ink cartridge	S020089

EPSON special media

Most plain paper works well in your printer. In addition, paper specifically designed for ink jet printers such as EPSON's 360 dpi Ink Jet Paper will meet most high-quality printing needs.

EPSON 360 dpi Ink Jet Paper (A4)	S041025
	S041059
EPSON 360 dpi Ink Jet Paper (Letter)	S041060
EPSON Photo Quality Ink Jet Paper (A4)	S041026
	S041061
EPSON Photo Quality Ink Jet Paper (Letter)	S041062
EPSON Photo Quality Ink Jet Paper (Legal)	S041067
EPSON Photo Quality Glossy Film (A4)	S041071
EPSON Photo Quality Glossy Film (Letter)	S041072
EPSON Photo Quality Glossy Film (A6)	S041107
EPSON Photo Quality Glossy Paper (A4)	S041126
EPSON Photo Quality Glossy Paper (Letter)	S041124
EPSON Ink Jet Transparencies (A4)	S041063
EPSON Ink Jet Transparencies (Letter)	S041064
EPSON Photo Quality Ink Jet Card (A6)	S041054
EPSON Photo Quality Ink Jet Card (5 × 8")	S041121
EPSON Photo Quality Ink Jet Card (8 × 10")	S041122
EPSON Photo Quality Self Adhesive Sheet (A4)	S041106
EPSON Photo Paper (4 × 6")	S041134

Note:

- ❑ *The availability of special media varies by country.*
- ❑ *Ink jet printers are particularly sensitive to the condition of your paper. Keep unused paper in its original packaging and store it in a cool, dry place.*

Chapter 2

Getting Started

2

Unpacking the Printer	2-2
Choosing a Place for the Printer	2-3
Using a printer stand	2-4
Attaching the Paper Support	2-4
Plugging in the Printer	2-5
Installing the Ink Cartridges	2-6
Connecting the Printer to Your PC	2-11
Installing the Printer Software	2-12
Installing in Windows 95	2-13
Installing in Windows 95 (using plug-and-play)	2-14
Installing in Windows 3.1	2-18
Loading Paper	2-20
Starting to Print	2-22

Unpacking the Printer

Your printer box should include a CD-ROM, which includes the printer software that runs your printer, and the following items:

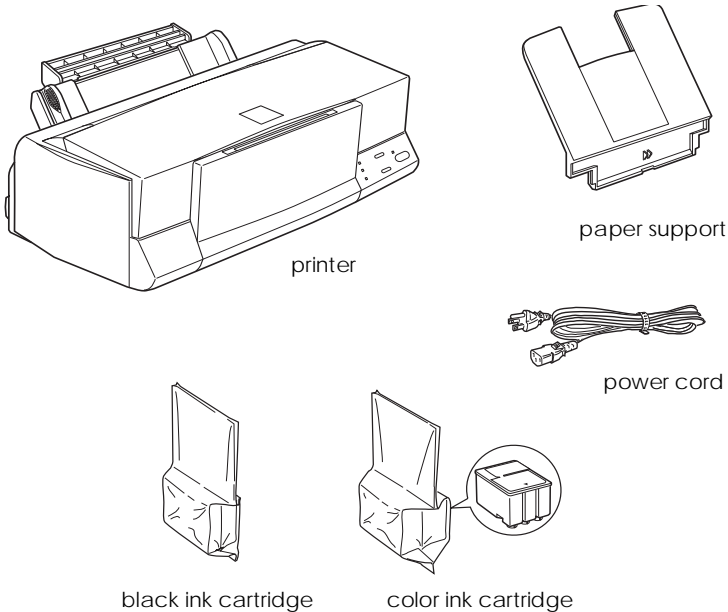

In some locations, the power cord comes attached to the printer. The shape of the AC plug varies by country; be sure the plug included is the right shape for your location.

Remove all protective materials packed with your printer before you set it up and turn on the power. Follow the instructions inserted with the printer to remove these materials. Save all packaging and protective materials in case you need to transport the printer later.

Choosing a Place for the Printer

Follow the guidelines listed below when placing your printer.

- Place the printer on a flat, stable surface. The printer will not operate properly if it is tilted or at an angle.
- Place the printer close enough to the computer for the interface cable to reach it easily.
- Leave adequate room for easy operation and maintenance.
- Leave enough room on the table at the front of the printer to lower the output tray.
- Avoid using or storing the printer in places subject to rapid changes in temperature and humidity. Also keep it away from direct sunlight, strong light, or heat sources.
- Avoid places subject to shocks and vibrations.
- Place the printer near a wall outlet where the plug can be easily unplugged.

Note for French-speaking users:

Placez l'imprimante près d'une prise de contact où la fiche peut être débranchée facilement.

- Avoid electrical outlets controlled by wall switches or automatic timers. Also, avoid outlets on the same circuit as large motors or other appliances that can cause fluctuations in line voltage.
- Keep the entire computer system away from potential sources of electromagnetic interference, such as loudspeakers or the base units of cordless telephones.
- Use a grounded power outlet; do not use an adapter plug.

Using a printer stand

When using a printer stand, note the following:

- ❑ Use a stand that can support at least 11.0 kg (24.3 lb).
- ❑ Never use a stand that tilts the printer. The printer should always be kept level.

Attaching the Paper Support

Insert the paper support into the slots at the rear of the printer as shown below.

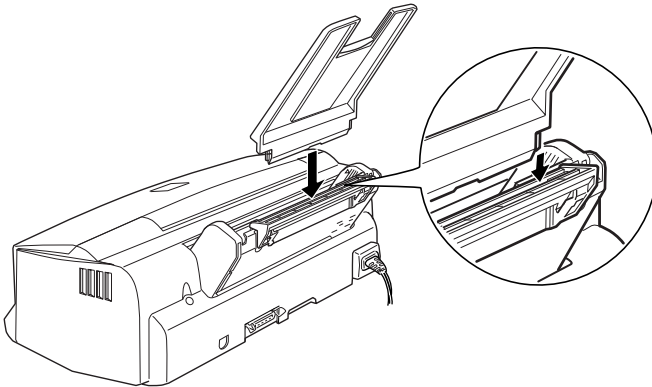

Note:

To print on transparencies, you need to reposition the paper support as described in “Loading Transparencies” in Chapter 4.

Plugging in the Printer

1. Make sure that the printer is turned off. It is off when the power button protrudes slightly from the surface of the control panel.

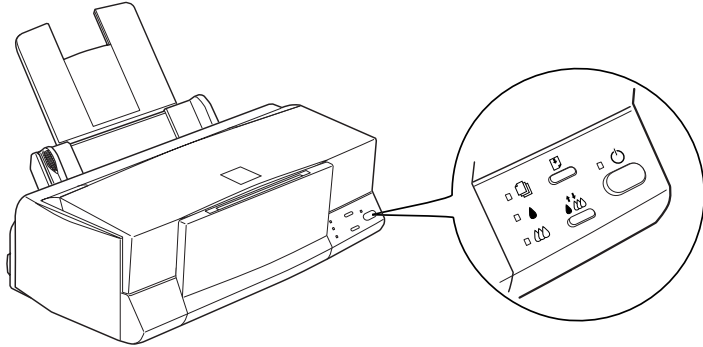

2. Check the label on the back of the printer to make sure the voltage required by the printer matches that of the electrical outlet you will be plugging it into. Also, make sure that you have the correct power cable for your power source.



Caution:

It is not possible to change the printer's voltage. If the rated voltage and your outlet voltage do not match, contact your dealer for assistance. Do not plug in the power cord.

3. If the power cord is not attached to the printer, connect it to the AC inlet on the back of the printer.
4. Plug the power cord into a properly grounded electrical outlet.

Installing the Ink Cartridges



Warning:

The ink cartridges are self-contained units. Under ordinary use, ink will not leak from a cartridge. If ink does get on your hands, wash them thoroughly with soap and water. If ink gets into your eyes, flush them immediately with water.





Install the ink cartridges as follows:

Note:

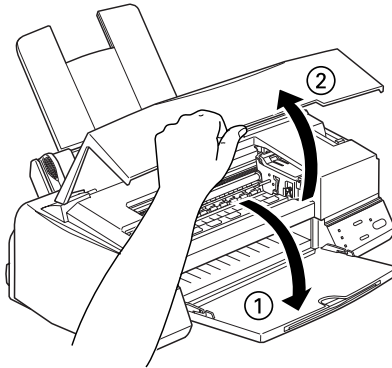
Do not open the ink cartridge packages until just before you install the cartridges, or the ink may dry up.

1. Lower the output tray at the front of the printer; then, holding the center edge of the cover, open the printer cover.



2. Turn on the printer by pressing the  power button. The print head moves slightly to the left, which is the ink cartridge install position. The  power light flashes and the  and  ink out lights come on.

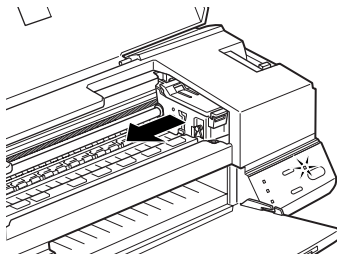
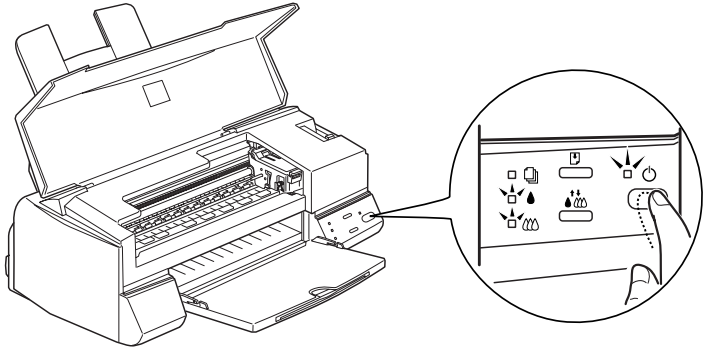

Caution:

Do not move the print head by hand. Otherwise you may damage the printer.

3. Lift up the two ink cartridge clamps.

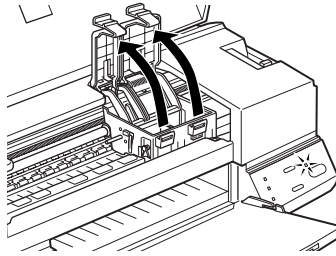

4. Open the ink cartridge packages. Next, remove only the yellow tape seals from each cartridge as shown below.



black ink cartridge
(S020093)

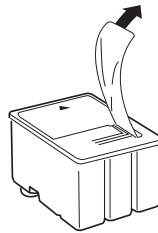

color ink cartridge
(S020089)



Caution:

- ❑ *You must remove the yellow tape seals from the cartridges. If you attempt to print using a cartridge with this tape seal still attached, the cartridge may become unusable.*
- ❑ *Do not remove the whole tape seal (especially the white portion) from the top of the cartridge. Remove only the yellow portion.*
- ❑ *Do not remove the tape seals from the bottom of the cartridges; otherwise, ink will leak.*

- Lower the cartridges into their holders with the labels face-up and the arrow marks pointing to the rear. The color ink cartridge, which is larger, goes on the right and the black ink cartridge goes on the left.

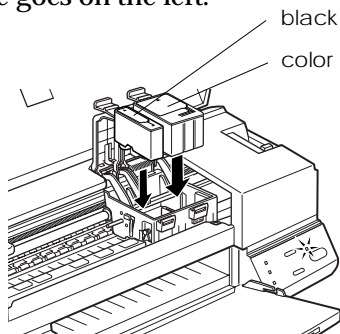



Note:

Install both ink cartridges. If either of the cartridges is not installed, the printer will not work.

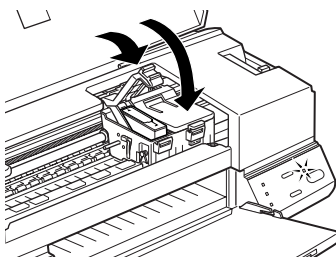
- Press the ink cartridge clamps down until they lock in place.



After installing the ink cartridges and pressing their clamps all the way down, the  and  ink out lights turn off.



Caution:

Once you install the ink cartridges, do not open their clamps again until you replace the ink cartridges. Otherwise, the cartridges may become unusable.

7. Press the  cleaning button. The printer moves the print head and begins charging the ink delivery system.

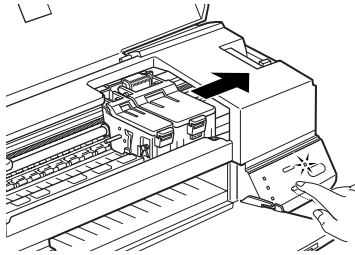

Note:



Even if you do not press the  cleaning button, the printer moves the print head and begins the ink charging process about 60 seconds after you install both ink cartridges.

The ink charging process may take about five minutes to complete, during which time the printer produces a variety of mechanical sounds. These sounds are normal. When the ink delivery system has been charged, the print head returns to its home (far right) position.

8. Close the printer cover.



Caution:

During the ink charging process, the  power light flashes. Never turn off the printer while the  power light is flashing.

The life of a cartridge depends on the amount of text and black-and-white graphics you print (for a black cartridge) and the amount and the number of colors you use in your documents (for a color cartridge).

Note:

To replace an ink cartridge, see “Replacing an Ink Cartridge” in Chapter 5.

Connecting the Printer to Your PC

To connect the printer to your computer using the built-in parallel interface, you need a shielded, twisted-pair parallel cable.

2

Follow the steps below to connect the printer to the computer:

1. Make sure both the printer and computer are turned off.
2. Plug the cable connector securely into the printer's interface connector. Then squeeze the wire clips together until they lock in place on both sides. If your cable has a ground wire, connect it to the ground connector below the interface connector.

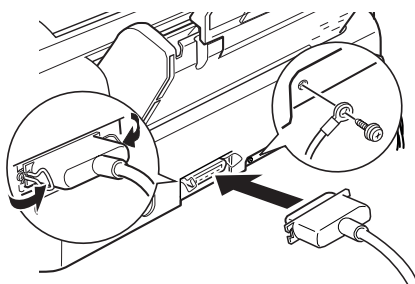

3. Plug the other end of the cable into the computer's parallel interface. If there is a ground wire at the computer end of the cable, connect it to the ground connector at the back of the computer.

See the next section for instructions on installing the printer software. You must install the printer software before using your printer.

Installing the Printer Software

After connecting the printer to your computer, install the printer software. It is included in the “Printer Software for EPSON Stylus COLOR 400” CD-ROM shipped with your printer.

Your printer software includes:

- ❑ **Printer driver**
The printer driver is software that runs, or “drives”, your printer. With it, you can make settings such as print quality and speed, media type, and paper size.
- ❑ **Utilities**
The Status Monitor utility helps you check the current status of your printer. The Nozzle Check, Head Cleaning, and Print Head Alignment utilities help you keep your printer in top operating condition.
- ❑ **EPSON folder or program group**
The EPSON folder (Windows 95) or program group (Windows 3.1) contains the EPSON stylus COLOR 400 Help, Spool Manager 4, and EPSON ReadMe files. Help gives you instant on-screen access to detailed information and instructions on how to use your printer and printer software, Spool Manager 4 provides you with extra control over the printing process, and ReadMe contains the most up-to-date information available regarding your printer and printer software.
- ❑ **EPSON Answers**
EPSON Answers provides you with additional information on using your printer and printing with colors. See the booklet packed with the CD-ROM for more information. EPSON Answers is not included in the floppy disk version.

If you are using the floppy disk version of the software, before you begin installation, make a backup copy of the EPSON printer software disk. If you wish to make a floppy disk version of the printer software on your CD-ROM, you can use the Driver disk creation utility included on the CD. See next page for Windows 95, or page 2-18 for Windows 3.1.

Installing in Windows 95

Follow the steps below to install the printer software in Windows 95.

1. Make sure Windows 95 is running and the printer is off.
2. Insert the printer software CD shipped with your printer in the CD-ROM drive. Click Install in the dialog box that appears, shown below.



If this dialog box does not appear when you insert the printer software CD, double-click the My Computer icon, then double-click the CD-ROM drive icon (or floppy disk drive icon if using the floppy disk version). If the dialog box shown above still does not appear, double-click the Setup.exe icon. You may need to use the arrows to scroll through the folder to find it.

Note:

If you wish to make a floppy disk version of the printer software included on your CD-ROM, click the Driver disk creation utility button and follow the on-screen instructions.

3. Select your printer icon in the EPSON Printer Utility Setup dialog box.

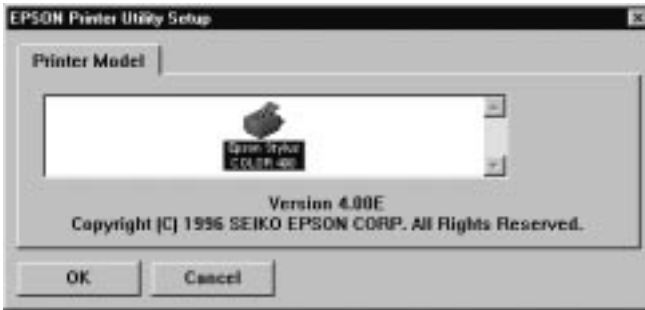

4. Make sure EPSON Stylus COLOR 400 is selected, and click OK to start the printer software installation. Follow the on-screen messages and when the installation is complete, click OK again.

Your printer software is now installed. For information on opening and using the software, see Chapter 3, “Printing With Windows.”

Installing in Windows 95 (using plug-and-play)

Follow these steps to install the printer software using Windows 95 plug-and-play capabilities.

Note:

To install the printer software using Windows 95 plug-and-play capabilities, your computer’s parallel port must be an IEEE 1284 compatible, bidirectional parallel port. See your computer documentation for more information.

1. Make sure the printer is connected to the computer's parallel port.
2. Turn off your printer and computer, if necessary.
3. Turn on the printer first; then turn on the computer. Your computer begins loading Windows 95.
4. If you defined a password, enter it at the prompt. You see the New Hardware Found screen.



Note:

If you do not see the New Hardware Found screen or if you run into any kind of problem, click Cancel and follow the installation procedure on page 2-13 instead.

5. Make sure your printer model name is displayed on the screen. Then click the Driver from disk provided by hardware manufacturer button. Do not select any of the other buttons.
6. Click OK. You see the Install From Disk screen.

7. Insert the printer software CD shipped with your printer in the CD-ROM drive. Depending on the country, the CD-ROM may contain multiple-language versions of the printer software.

First try typing `D:\Win95` and clicking **OK**. If an error message does not appear, proceed to step 8. If an error message does appear, you have the multiple-language version and you need to click **OK** to return to the **Install From Disk** screen. Type `D:\` then specify your preferred language by typing `English`, `Francais`, `German`, `Italian`, `Portugal`, or `Spanish`, followed by `\Win95`. Click **OK**. (If your CD-ROM drive uses a drive letter other than “D”, substitute the appropriate letter.)

If you use the floppy disk version, insert it in a disk drive. If the drive you are installing from is displayed on the screen, click **OK**. Otherwise, change the drive letter in the **Copy manufacturer's files from box** and click **OK**.

8. At the next screen you can type a unique name for the printer in the **Printer name** box. We recommend that you keep the model name as shown. The program will copy the files to your hard disk and add an icon to the **Printers** folder using the printer name you assign. To use this printer as the default printer for Windows 95 applications, select **Yes**. (No is the default setting.)
9. Click the **Finish** button.

The printer software that controls your printer is now installed. For information on accessing and using the software, see Chapter 3, “Printing With Windows.”

Using your printer on a Network

If you want to use your printer on a network, you need to set up your printer as a network printer. Follow these steps:

1. Double-click the My Computer icon.
2. Double-click the Printers folder.
3. Right-click the icon of your printer, and click Properties. Be sure to right-click.
4. Click the Details tab. The following window appears:



5. Click the Add Port button, then specify the network path to the printer. Click OK.
6. After you have made your settings on the Details menu, click Start, point to Programs and Epson, then click Spool Manager4. The Spool Manager window opens.

7. Select your printer, click the Queue menu, then click Setup. The Queue setup window opens.
8. Make sure the Use Print Manager for this port option is on; it is on if the box contains a check mark. Then click OK.

Now you can use your printer on a network.

Installing in Windows 3.1

Follow these steps to install the software using Windows 3.1:

1. Make sure Windows 3.1 is running and the Program Manager window is open.
2. Insert the printer software CD shipped with your printer in the CD-ROM drive. (If you use the floppy disk version, insert it in a disk drive.)
3. In the File menu, choose Run. You see the Run dialog box. In the Command Line box, type D:SETUP (or A:SETUP if you inserted the disk in drive A).

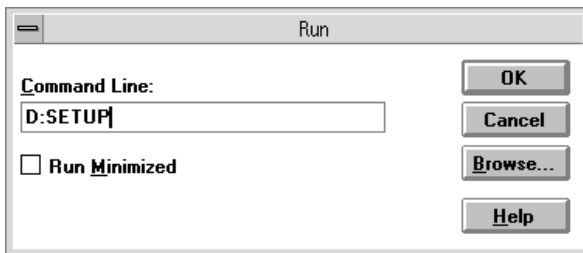

Note:

If you wish to make a floppy disk version of the printer software included on your CD-ROM, type EPSETUP instead of SETUP. In the dialog box that appears, click the Driver disk creation utility button and follow the on-screen instructions.

4. Click OK. You see the EPSON Printer Utility Setup dialog box.

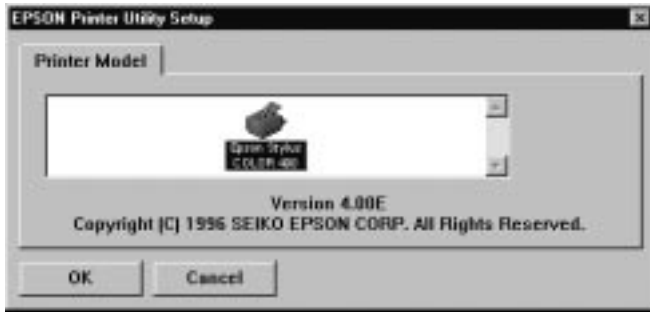

5. Select your printer icon and click OK. The installation program begins copying the printer software files.

After a few moments, the installation program creates the EPSON program group in Windows.

6. When the installation is complete, click OK to exit the installation program.

The installation program automatically selects this printer as the default printer for Windows applications.

Your printer software is now installed. For information on accessing and using the software, see Chapter 3. See also “Starting to Print” in this chapter.

Loading Paper

The following procedure describes how to load plain paper into the printer.

You can also print on ink jet paper, transparencies, photo-quality glossy film or paper, envelopes, index cards, and adhesive sheets. For details on using such media, see Chapter 4, “Printing on Special Paper.”

Note:

To print on transparencies, you need to reposition the paper support as described in “Loading Transparencies” in Chapter 4.

1. Lower the output tray at the front of the printer and slide out the extension.

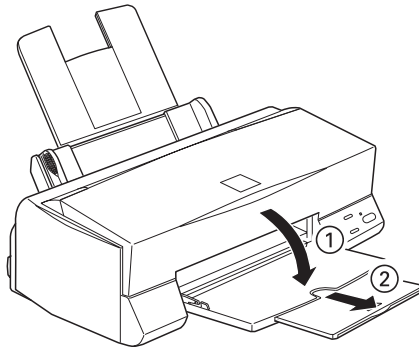

- Slide the left edge guide to the left as far as it will go. Pull up the paper support extension and pull out the output tray extension.

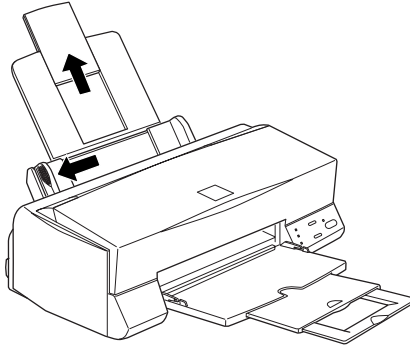

- Fan a stack of paper; then tap it on a flat surface to even the edges.
- Load the stack of paper with the printable surface up and the right edge of the paper resting against the right side of the sheet feeder.

Note:

Always load paper into the sheet feeder short edge first. Load envelopes flap edge first with the flap side down.

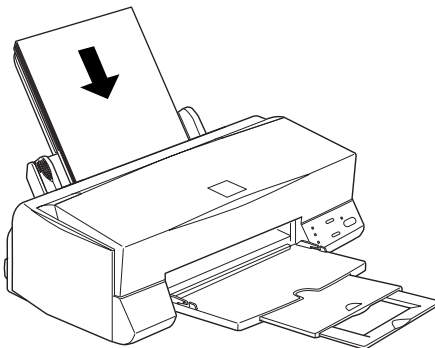

5. Slide the left edge guide against the edge of the paper. Make sure the paper stack fits under both the edge guide tab and arrow mark as shown below.

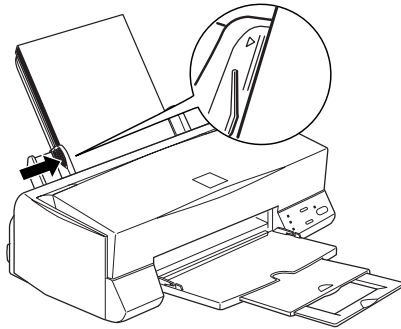

Starting to Print

To get started printing right away, follow the printing method explained below, which is typical of many Windows applications. The actual way you print may vary depending on the application you use. See your application manual for details.

For more details about the printer driver settings, see Chapter 3.

1. From your application, open the document you want to print. If necessary, use the Page Setup option on the File menu to specify the paper size.
2. Click Print on the File menu. The Print dialog box (or a similar dialog box) appears.

3. Make sure your printer is selected and then click Printer, Setup, Properties, or Options. You may need to click a combination of these buttons. The driver settings window appears.



4. Click the Main tab if necessary, and make sure the Mode option is set to Automatic.
5. Click anywhere in the Media Type box, and select the media you loaded in the printer from the list.
6. Select Color as the Ink setting if your document includes color. Select Black if you are printing black text only, a draft, or if you want colors to print as varying shades of gray.

7. Click OK at the bottom of the window. You return to the Print dialog box (or a similar dialog box).
8. Click Close, OK, or Print to print. You may need to click a combination of these buttons.

While your document is printing, the EPSON Despooler dialog box will appear, showing the printing progress and the status of your printer. If you are printing from Windows 95, this dialog box also displays the Status Monitor.

See Chapter 3 for detailed information on printer driver settings, the EPSON Despooler, and the Status Monitor.

Chapter 3

Using the Printer Software

Checking Your Printer Driver Settings	3-2
How to access the printer driver settings	3-3
How to check the settings	3-4
Making Changes to Printer Driver Settings	3-6
Using the Automatic setting	3-7
Using the predefined settings	3-8
Customizing the print settings	3-10
Making the Media Type setting	3-12
Using the Printer Utilities	3-14
Status Monitor	3-15
Nozzle Check	3-16
Head Cleaning	3-16
Print Head Alignment	3-16
Checking Printer Status	3-17
Understanding the EPSON Spool Manager	3-17
Understanding the Despooler	3-18
Getting Information Through Online Help	3-19
From Windows applications	3-19
From Windows 95	3-19
From Windows 3.1	3-19



Checking Your Printer Driver Settings

Before you start printing, you should make sure that the settings in the printer driver included with your printer software match your document requirements. While many Windows applications override the settings made with the printer driver, some do not, so you must verify the settings to get the results you expect.

Be sure to check the following driver settings:

- Mode** (Main menu) Automatic or Advanced
- Media Type** (Main menu) The type of paper loaded in the printer
- Ink** (Main menu) Black or Color
- Paper size** (Paper menu) The size of the paper loaded in the printer
- Copies** (Paper menu) The number of copies to be printed
- Orientation** (Paper menu) The direction of printing on the page

How to access the printer driver settings

The way you should access the printer driver settings depends on how you want the settings to take effect. Be aware that settings you make in your application override settings made directly in the driver, so in most cases you should access the driver from your application to make sure that the printer driver settings are appropriate for your document.

- ❑ If you want the settings to apply only to the document(s) you will print in a particular Windows application, see “Starting to Print” on page 2-22.
- ❑ If you want the settings to apply to your Windows applications, see the description below for Windows 95 or Windows 3.1.

Note:

Online help is available for details about the printer driver settings.

From Windows 95

Follow these steps to access the printer driver settings from My Computer:

1. Double-click the My Computer icon.
2. Double-click the Printers folder.
3. Right-click the icon of your printer, and click Properties. Be sure to right-click.
4. Click the Main tab. You now see the Main menu of the printer driver settings window.

See page 3-4 for information on how to check the settings.

From Windows 3.1

Follow these steps to access the printer driver settings from Program Manager:

1. Open the Main program group and double-click the Control Panel icon.
2. Double-click the Printers icon.
3. Choose your printer from the Installed Printers list.
4. Choose Setup. You see the Main menu of the printer settings window.

See the following for information on how to check the settings.

How to check the settings

Be sure to check the settings through your application before printing in case your application overrides your settings. Click Print on the File menu, and click Properties, Options, Printer, or Setup. Click the Main tab if necessary.



1. Check the Mode option. For most print jobs, leave the option set to Automatic. The printer driver automatically makes the best settings according to the data to be printed, the Media Type setting, and the Ink setting. The current settings are shown at the bottom of the menu.
2. Check the Media Type option. Select the media you loaded in the printer from the Media Type list. See page 3-12 for more information on making the Media Type setting.
3. Check the Ink option. Select Color if your document includes color. Select Black if you are printing black text, a draft, or if you want colors to print as varying shades of gray.
4. Click the Paper tab. The Paper menu appears.



5. Make sure the paper size you loaded in the printer is selected in the Paper Size list. If you don't see your paper size in the list, use the arrows to scroll through the list.

Note:

If your paper size is not included in the list, select User Defined and enter the paper size dimensions in the dialog box that appears. For information on the User Defined setting, see online help.

6. Check the Copies option. You can click the arrows or type a number in the box to make this setting.
7. Check the Orientation option. The effect of your orientation setting is shown in the display to the left.

Note:

Always load paper into the sheet feeder short edge first. Load envelopes flap edge first with the flap side down.

8. Click the OK button at the bottom of the window.

Note:

You can get more information on the printer driver settings by clicking the Help button at the bottom of the window. For more details on making the printer driver settings, see the next section.

Making Changes to Printer Driver Settings

As described in Chapter 2, the printer driver lets you choose from a wide variety of settings to get the best results from your printer.

The quickest and easiest way to start printing is to leave the Mode option set to Automatic on the Main menu. This way you only need to check the Media Type, Ink, and Paper Size settings, as described on page 2-22.

Basically, there are three levels of settings: the Automatic setting; the predefined settings, which give you more control over printer settings; and the custom settings, which you make to fit your individual needs. These settings are described in detail in the following sections.

Several printer utilities are provided to help you check the condition of the printer and perform maintenance procedures. See pages 3-14 through 3-16 for information on the Status Monitor, Nozzle Check, Head Cleaning, and Print Head Alignment utilities. For instructions on using the Status Monitor, see page 3-15, and for instructions on using any of the other utilities, see Chapter 6, “Troubleshooting.”

Using the Automatic setting

If you leave Mode set to Automatic on the Main menu, the only settings you need to check yourself are the Media Type and Ink settings. See page 3-12 for details about making the Media Type setting.

Most Windows applications feature paper size and page layout settings which override similar settings on the Paper menu, but if your application does not, you should also check the items on this menu. Click the Paper tab at the top of the menus to view the Paper Size settings.

Note:

If you choose Plain Paper as the Media Type setting while Automatic is selected, a slide bar appears in the Mode box that lets you choose Quality or Speed. For most print jobs, leave this set to Speed. Select Quality only when print quality is more important than speed.

Online help provides more information about the printer driver including the settings and menus. See page 3-19 for instructions on using online help.

Using the predefined settings

The predefined settings are provided to help you optimize the print settings for a particular kind of printout such as presentation documents or images taken by a video or digital camera. You will find the predefined settings in the list under the Advanced button on the Main menu.

To choose a predefined setting, click the Advanced button then select the most appropriate setting from the Advanced settings list under the Advanced button according to the type of document or image you will print.

When you choose a predefined setting, other settings such as Print Quality, Halftoning, and Color are set automatically. Changes are shown in the Current Settings display at the bottom of the Main menu.

Before printing, be sure to verify the Media Type and Ink settings, as they may be affected by the predefined setting you select. See page 3-12 for more information on the Media Type setting.

The printer driver provides the following predefined settings:

Photo	Good for printing scanned photos
Text/Graph	Good for printing presentation documents such as graphs and charts
PhotoEnhance	Good for printing images captured using a video, digital camera, or scanner. EPSON PhotoEnhance automatically adjusts the contrast, saturation, and brightness of the original image data to produce sharper, more vivid color printouts. PhotoEnhance does not affect your original image data.

Note:

Printing with PhotoEnhance selected may take longer depending on your computer system and the amount of data contained in your image.

Text	Good for printing text-only documents
Economy	Good for printing drafts of text
ICM	ICM means image Color Matching. This feature automatically adjusts printout colors to match colors on your screen.

Note:

- ICM is only available for Windows 95.*
- Selecting PhotoEnhance or ICM automatically sets the Ink option to Color. Also, some Media Type settings are not available depending on the selected predefined setting and on the Ink setting if a predefined setting is selected.*

Customizing the print settings

Many users will never need to manually make their own print settings. However, if you need more control over the driver, want to make the most detailed settings available, or just want to experiment, click the **Advanced** button on the **Main** menu and then click the **More Settings** button. The **More Settings** dialog box appears:

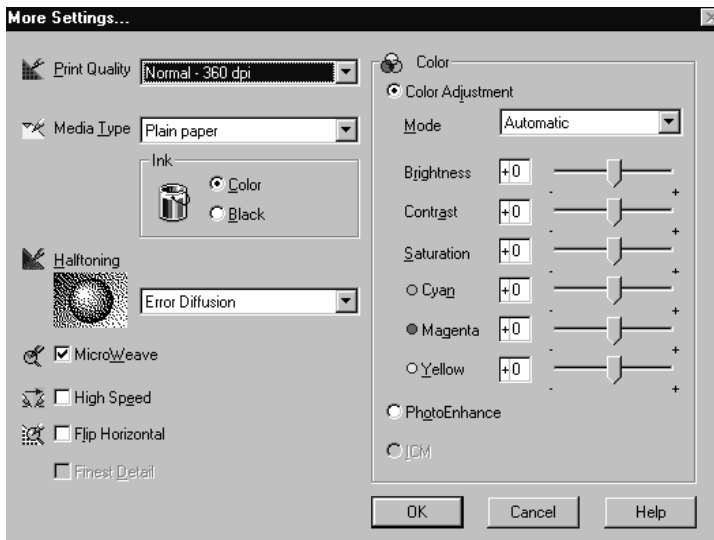

Some settings are enabled or disabled depending on the **Print Quality**, **Media Type**, and **Ink** settings you make. To save time and effort, always customize your settings in this order: **Print Quality**, **Media Type**, **Ink**, and then make other settings. See the next section for details about making the **Media Type** setting. See also online help for details about the other settings.

After making your settings, click **OK**. Your settings will be applied and you will return to the **Main** menu. To return to the **Main** menu without applying your settings, click **Cancel**.

To save your custom settings, click Save Settings on the Main menu. The Custom Settings dialog box appears:

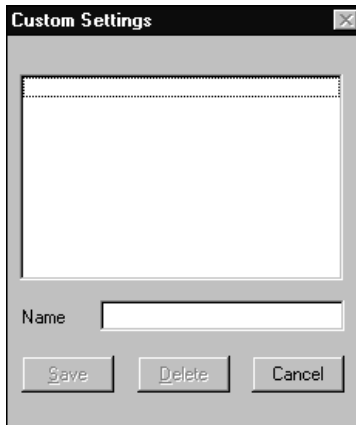

Type a unique name for your custom settings in the Name box, and click the Save button. Your settings will appear in the Advanced settings list, along with the predefined settings.

Note:

- You can not use a predefined settings name for your custom settings.*
- To delete a custom setting, click Save Settings on the Main menu, select the setting in the Custom Settings dialog box, and then click Delete.*
- You can not delete the predefined settings.*

When you select your saved settings in the Advanced settings list, be aware that making new settings, for example Media Type and Ink settings, may affect and change your custom settings. This may cause unexpected results in your printout. If this happens, reselect your saved settings and try printing again.

Making the Media Type setting

On the Main menu, select the Media Type setting that matches the paper you loaded in the printer. See the following to determine the appropriate Media Type setting (shown in bold) for your paper. First find your paper, then select a corresponding Media Type setting. For some kinds of paper, you have several Media Type settings to choose from.

Note:

- ❑ *If your EPSON brand paper name is not shown below, refer to the product number to determine the proper Media Type setting.*
- ❑ *If the corresponding Media Type setting for your paper is not shown in the Media Type list, change the Print Quality setting in the More Settings dialog box, the Mode setting, or the predefined setting selected in the Advanced settings list.*

Plain Paper

Plain paper
Envelope

360 dpi Ink Jet Paper

EPSON 360 dpi Ink Jet Paper (A4)	S041059
	S041025
EPSON 360 dpi Ink Jet Paper (Letter)	S041060

Photo Quality Ink Jet Paper

EPSON Photo Quality Ink Jet Paper (A4)	S041061
	S041026
EPSON Photo Quality Ink Jet Paper (Letter)	S041062
EPSON Photo Quality Ink Jet Paper (Legal)	S041067
	S041048
EPSON Photo Quality Self Adhesive Sheet	S041106
EPSON Photo Quality Ink Jet Card (A6)	S041054
EPSON Photo Quality Ink Jet Card (5 × 8")	S041121
EPSON Photo Quality Ink Jet Card (8 × 10")	S041122

Ink Jet Transparencies

EPSON Ink Jet Transparencies (A4)	S041063
EPSON Ink Jet Transparencies (Letter)	S041064

Photo Quality Glossy Paper

EPSON Photo Quality Glossy Paper (A4)	S041126
EPSON Photo Quality Glossy Paper (Letter)	S041124
EPSON Photo Paper (4 × 6")	S041134

Photo Quality Glossy Film

EPSON Photo Quality Glossy Film (A4)	S041071
EPSON Photo Quality Glossy Film (Letter)	S041072
EPSON Photo Quality Glossy Film (A6)	S041107

Using the Printer Utilities

EPSON printer utilities allow you to check the current printer status and do some printer maintenance from your screen. To access the utilities, click the Utility tab in the printer software window (shown below), then click the button for the utility you want to use. A brief description of the utilities is given below. For more details, see online help.

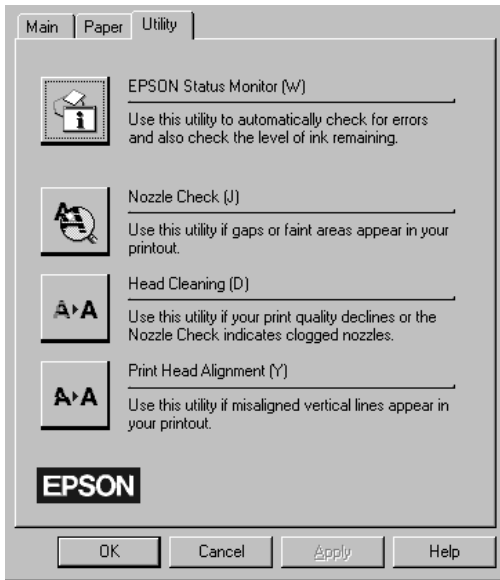

Note:

The letter in parentheses after the utility name indicates the shortcut key for that utility. Press Alt and the letter on the keyboard to open that utility.

Status Monitor

Note:

The Status Monitor is only available for Windows 95.

The Status Monitor utility helps you to keep track of the printer, and it alerts you if there are any problems. When you install the printer software for Windows 95, the Status Monitor is automatically copied to your hard disk.

The Status Monitor utility is available only when the printer is connected directly to the host computer. You cannot use this utility when printing over a network.

When you send a print job to the printer, the Status Monitor and the Despooler dialog box appear on your screen. See page 3-16 for information about the Despooler.

The Status Monitor provides information about the printer status by displaying the appropriate icon on your screen.



Checking the printer status.



An error has occurred. Your printer cannot print. Check your printer.



The printer is ready.



The printer is printing.



The ink level is low or out.

Nozzle Check

You can check the print head nozzles for clogging with this utility. Check the nozzles when you notice print quality has declined and also after cleaning to confirm that the print head nozzles have been cleared. See page 6-25 for more information.

Head Cleaning

You can clean the print head with this utility. You may need to clean the head when you notice print quality has declined. Use the Nozzle Check utility first to confirm that the head needs to be cleaned. See page 6-25.

Print Head Alignment

This utility aligns the print head. Use this utility when you notice a misalignment of vertical lines. See page 6-28.

Note:

- ❑ *Do not use the Nozzle Check, Head Cleaning, and Print Head Alignment utilities with printers connected to your computer through a network.*

- ❑ *Do not use the Nozzle Check, Head Cleaning, and Print Head Alignment utilities while printing is in progress; otherwise your printout may be marred.*

Checking Printer Status

When you send a print job to the printer, the EPSON Despooler and Status Monitor appear in the lower right portion of your screen. The Despooler shows the progress of the current print job and allows you to control the progress of the print job, as described below.

Understanding the EPSON Spool Manager

The EPSON Spool Manager is similar to Windows Print Manager. If it receives two or more print jobs at one time, it puts them in a line (with printers on a network this may be called a print queue) in the order received. When a print job reaches the top of the line, the EPSON Despooler sends the job to the printer.

The Spool Manager starts automatically when you print from your application. To access the Spool Manager from Windows 95, click the EPSON Spool Manager icon after it appears on the taskbar. To access the Spool Manager from Windows 3.1, double-click the EPSON Spool Manager icon after it appears at the bottom of your desktop. For more information, see online help.

Understanding the Despooler

When you send a print job to the printer, the EPSON Despooler dialog box appears in the lower right portion of your screen. This box shows the progress of the current print job and provides printer status information.



You can control printing from the Despooler dialog box using the stop, pause, and reprint buttons as explained below.

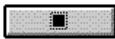

Stop Cancels printing



Pause Pauses printing until you press it again



Reprint Opens a dialog box that allows you to choose to restart printing from the current page, reprint the whole document, or hold the document for printing later

The Status Monitor at the bottom of the Despooler dialog box only appears if you are using Windows 95.

Getting Information Through Online Help

Your printer software has an extensive online help feature that includes detailed information and instructions about printer driver settings and the printer utilities. Online help will answer most of your questions about your printer software.

From Windows applications

To access online help from your application, open the File menu and choose Print or Print Setup. Then click Printer, Setup, Options, or Properties (you may need to click a combination of these buttons) depending on the software you are using. Click the Help button at the bottom of the Main, Paper, and Utility menus for help related to the items on that menu.

If you are running Windows 95, you can get specific help related to any item on a menu by right-clicking the item, then clicking the What's This? prompt.

From Windows 95

To access online help directly from Start, click the Start button, point to Programs and Epson, and then click EPSON Stylus COLOR 400 Help. You see the help contents window.

From Windows 3.1

To access online help directly from Program Manager, open the EPSON program group and click the EPSON Stylus COLOR 400 Help icon. You see the help contents window.

Chapter 4

Printing on Special Paper

Loading Special Paper and Other Media	4-2
About special media cleaning sheets	4-5
Loading Envelopes	4-6
Loading Transparencies	4-7
Using EPSON Photo Paper (S041134)	4-8
Loading	4-8
Removing the perforated margins	4-10
Storing EPSON Photo Paper	4-10



Loading Special Paper and Other Media

You can use most plain bond paper to achieve good results. However, coated papers and glossy paper/film give you better results because they reduce the amount of ink that is absorbed.

EPSON provides special media that are formulated for the ink used in EPSON ink jet printers. EPSON recommends you to use media distributed by EPSON to ensure high-quality results. For a list of EPSON special media, see page 1-6, or "Printing Supplies" in online help.

When loading special paper distributed by EPSON, read the instruction sheets packed with your special media first and keep the following in mind.

- ❑ Make sure the printable surface of the paper is face up when loading media into the sheet feeder. See the instruction sheets packed with the media to determine which side is the printable surface. Some media have cut corners to help identify the correct loading direction, as shown below.

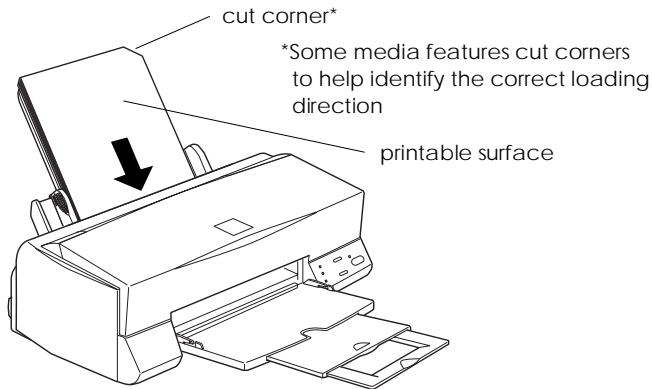

- ❑ Make sure the paper stack fits under the edge guide tab and the arrow mark, both of which are located on the inside surface of the left edge guide. Basic loading capacity for special media is explained below.

EPSON 360 dpi
Ink Jet Paper and Photo
Quality Ink Jet Paper

You can load paper up to the arrow mark. If you load legal-size ink jet paper, do not load it more than halfway to the arrow mark.

EPSON Photo Quality
Ink Jet Card

You can load up to 30 index cards. Always place the included support sheet under the cards when loading them.

EPSON Photo Quality
Glossy Paper

You can load up to 20 sheets.

EPSON Photo Quality
Glossy Film

For best results, you should load glossy film one sheet at a time. Before loading glossy film, always put a support sheet* or a sheet of plain paper under the glossy film. If you wish to print with multiple sheets, set the minimum top margin of the page to 30 mm and put a support sheet under the stack of glossy film. Be sure to remove each printout from the output tray immediately after printing. Before stacking or storing your printout, allow enough time for the ink to dry thoroughly and except for A6 size glossy film cover the printed side of every sheet with an enclosed protective sheet.

**EPSON Ink Jet
Transparencies**

You can load up to 10 transparencies. Before loading transparencies, you need to reposition the paper support as described in “Loading Transparencies” later in this chapter. Be sure to remove each printout from the output tray immediately after printing. Before stacking or storing your printout, allow enough time for the ink to dry thoroughly and cover the printed side of every sheet with an enclosed protective sheet.

**EPSON Photo Quality
Self Adhesive Sheet**

You can load one sheet at a time.

Envelopes

You can load up to 10 envelopes.

*If a support sheet is packed with Photo Quality Glossy Film or Paper, load it underneath the glossy film, but do not print on it.

- ❑ If ink smears on your documents when printing on thick special media, such as envelopes or index cards, set the adjust lever to the “+” position. To change the setting, open the printer cover and position the lever as shown below.

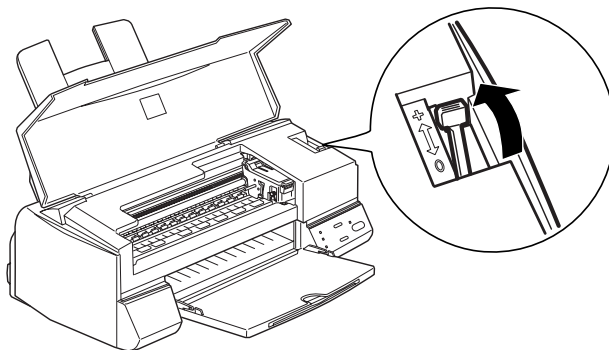

Note:

Return the adjust lever to the “0” position before printing on media of normal thickness. Leaving the lever in the “+” position may cause gaps in the printed image.

About special media cleaning sheets

Cleaning sheets packaged with EPSON special media should not be used with this printer. The cleaning function performed by these sheets is not necessary with this type of printer, and the sheets could jam in the printer.

Loading Envelopes

When printing on envelopes, please note the following:

- ❑ You can load up to 10 envelopes into the sheet feeder.
- ❑ Load envelopes flap edge first with the flap side down, as shown below.

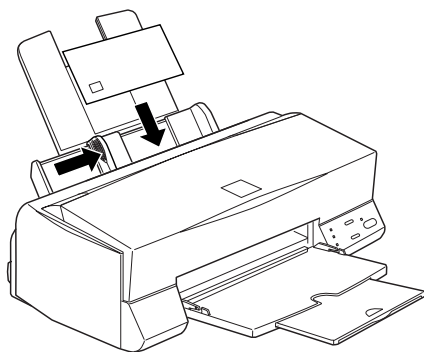

- ❑ Do not use envelopes that are curled or folded. Also avoid using envelopes that are too thin; they may curl during printing.
- ❑ Select Plain Paper as the Media Type setting on the printer driver's Main menu. For more details on making printer driver settings, see online help.
- ❑ If ink smears on your documents, set the adjust lever to the "+" position. To change the setting, open the printer cover and reposition the lever. See the illustration on page 4-6.

Note:

Return the adjust lever to the "0" position, which is the normal position, after you finish printing on envelopes. Leaving the lever in the "+" position may cause the printed image to have gaps on other media.

Loading Transparencies

When printing on transparencies, please note the following:

- ❑ Before loading transparencies, remove the paper support and reinsert it into the slots at the back of the printer as shown below.

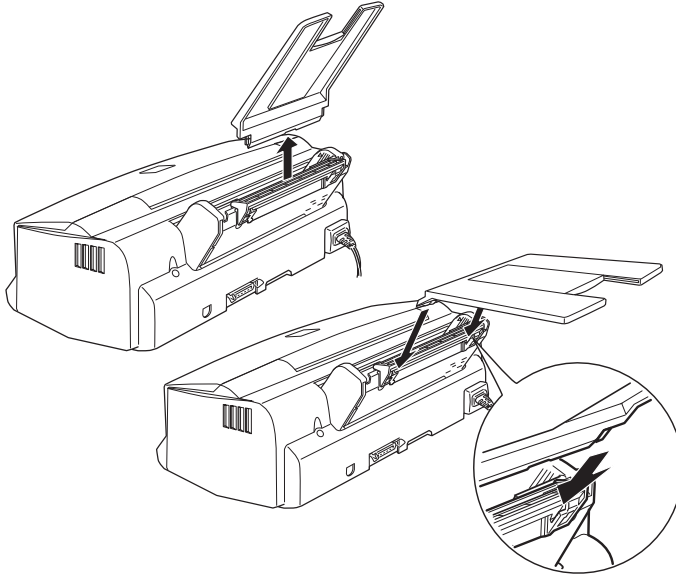

- ❑ Always put a support sheet or a sheet of plain paper under the stack of transparencies.
- ❑ You can load up to 10 transparencies.
- ❑ Make sure the printable surface of the paper is face up when loading transparencies into the sheet feeder. See the illustration on page 4-4.
- ❑ Select Ink Jet Transparencies as the Media Type setting in the printer driver. For more details on making printer driver settings, see online help for Windows, or Chapter 5 for Macintosh.

Using EPSON Photo Paper (S041134)

EPSON Photo Paper (S041134) is perforated around the margins so you can trim your printed images to look like 4 × 6 inch (102 × 152 mm) photographs. Please note the following when using this paper.

Loading

- ❑ Load the paper printable side up with the perforated margins positioned as shown below.

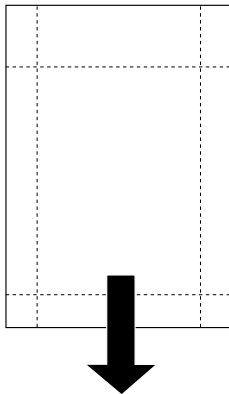

loading position

- ❑ Use flat, undamaged paper. If the paper or the support sheet is curled, flatten it before loading to avoid paper feeding problems.
- ❑ Always place the included support sheet under the stack of Photo Paper, but do not print on it.
- ❑ You can load up to 20 sheets of Photo Paper into the sheet feeder.

- ❑ To print on the coated (whiter) side of Photo Paper, select Photo Quality Glossy Paper as the Media Type setting and EPSON PhotoPaper 4X6 in as the Paper Size setting in your printer driver.

Note:

The outside edge of your image might be cut off when you remove the perforated margins.

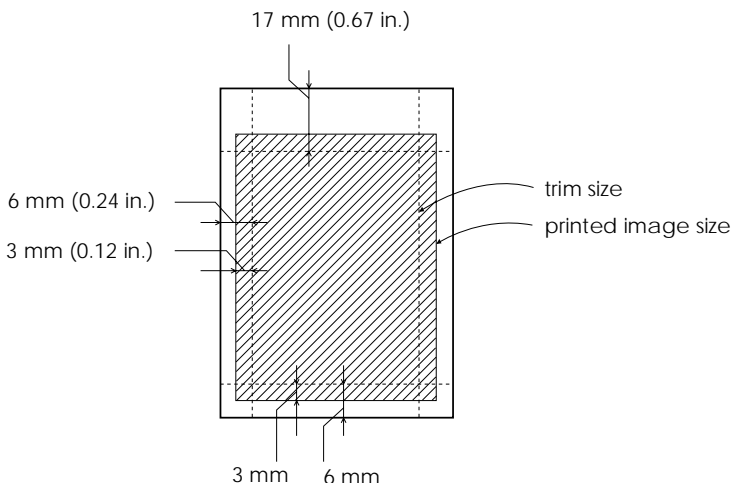

- ❑ You can also print with black ink on the non-coated side (EPSON logo side) of Photo Paper. To print on this side, select 360 dpi Ink Jet Paper as the Media Type setting and then select EPSON Photo Paper 4X6 in as the Paper Size setting.
- ❑ Cut or tear the paper at the perforation only after printing. Do not cut, tear, or fold the paper before printing.

Removing the perforated margins

- ❑ To remove the perforated margins, fold the paper back and forth a few times along the perforations, then carefully tear the margins off.

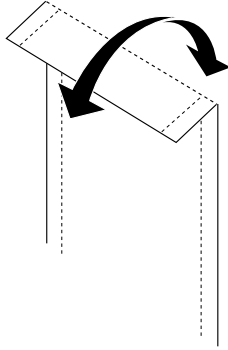

- ❑ You may also remove the margins by cutting along the perforations.

Storing EPSON Photo Paper

- ❑ Return unused paper to the original package as soon as you finish printing, and avoid storing it in places exposed to high temperature, humidity, or direct sunlight.

Chapter 5

Maintenance and Transportation

Replacing an Ink Cartridge	5-2
Cleaning the Printer	5-7
Transporting the Printer	5-8

Replacing an Ink Cartridge

The printer's indicator lights will inform you when it is time to obtain a replacement ink cartridge and when it is time to replace an empty cartridge. Also, because ink quality decreases over time, replace an ink cartridge if you haven't used up the ink within six months and print quality declines.

EPSON recommends the use of genuine EPSON ink cartridges. Other products not manufactured by EPSON may cause damage to your printer not covered by EPSON's warranties.

When the  ink out light is

- flashing obtain a replacement black ink cartridge (S020093).
- on replace the empty black ink cartridge.

When the  ink out light is

- flashing obtain a replacement color ink cartridge (S020089).
- on replace the empty color ink cartridge.

Note:



If the ink runs out, you cannot continue printing until you replace it even though the other ink cartridge still contains ink.





Caution:



Once you remove an ink cartridge, it becomes unusable and cannot be reinstalled even if ink remains.

To replace an ink cartridge, follow these steps.



1. Make sure the printer is on. Determine which cartridge needs to be replaced as indicated by the  black or  color ink out light.

Note:

If you need to replace an ink cartridge when the  and  ink out lights are off, see page 6-28.

2. Make sure the printer is paused and the output tray at the front of the printer is lowered; then open the printer cover.
3. Hold down the  cleaning button for three seconds until the print head moves left slightly to the cartridge replacement position, and the  power light flashes when the print head is in position.

Note:

- The printer automatically moves the print head back to its home (far right) position after about 60 seconds if you have not started the replacement procedure.*
- If you hold down the  cleaning button when both  and  ink out lights are off, the printer starts cleaning the print head.*



Caution:

Do not move the print head by hand. Always use the  cleaning button to move it. Otherwise you may damage the printer.

- Lift up the clamp that holds the cartridge you want to replace as far as it will go. When you do, the cartridge will rise partly out of the cartridge holder. The following illustration shows color ink replacement. For black ink replacement, lift up only the smaller clamp on the left.

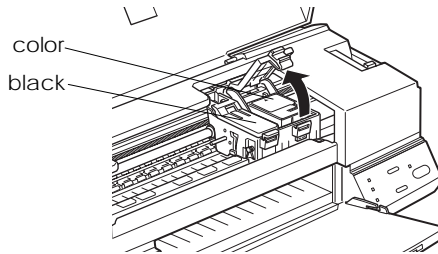

- Lift the cartridge out of the printer and dispose of it properly. Do not take the used cartridge apart or try to refill it.



Warning:

If ink gets on your hands, wash them thoroughly with soap and water. If ink gets into your eyes, flush them immediately with water.



Caution:

Leave the old cartridge installed in the printer until you are ready to replace it with a new one.

6. Remove the ink cartridge from its protective bag. Next, remove only the yellow tape seal from the cartridge as shown below.



black S020093

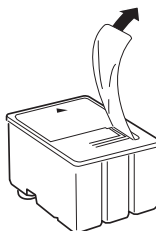

color S020089



Caution:

- You must remove the yellow tape seal from the cartridge. Leaving the tape on when you install the cartridge will permanently damage it.*
 - Do not remove the whole tape seal (especially the white portion) from the top of the cartridge. Remove only the yellow portion.*
 - Do not remove the tape seal from the bottom of the cartridge; otherwise, ink will leak.*
7. Lower the ink cartridge into the cartridge holder with the label on the cartridge face up and the arrow on the cartridge pointing to the rear of the printer. The larger (color) cartridge goes on the right, the black ink cartridge on the left.

8. Press the ink cartridge clamp down until it locks in place. The following illustration shows color ink replacement. For black ink replacement, press down the smaller clamp on the left.

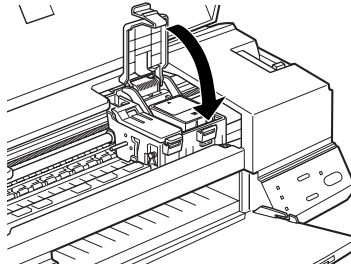

9. Press the  cleaning button. The printer moves the print head and begins charging the ink delivery system. This process may take a few minutes to complete.



Caution:

The  power light continues to flash while the printer performs the ink charging operation. Never turn off the printer while this light is flashing. Doing so can result in incomplete charging of ink.

Note:

Even if you do not press the  cleaning button, the printer moves the print head and begins the ink charging process about 60 seconds after you replace the ink cartridge.

10. When the ink charging procedure is finished, close the printer cover.
11. Send data to resume printing.

Cleaning the Printer

To keep your printer operating at its best, you should clean it thoroughly several times a year.

1. Make sure the printer is turned off and all the control panel lights are off. Then unplug the power cord.
2. Remove any paper from the sheet feeder.
3. Use a soft brush to carefully clean away all dust and dirt.
4. If the outer case or the inside of the sheet feeder is dirty, clean it with a soft, clean cloth dampened with mild detergent. Keep the printer cover closed to prevent water from getting inside.
5. If the inside of the printer accidentally gets soiled with ink, wipe it off with a damp cloth.



Warning:

Be careful not to touch the gears inside the printer.



Caution:

- Never use alcohols or thinners to clean the printer; these chemicals can damage the components as well as the case.*
- Be careful not to get water on the printer mechanism or electronic components.*
- Do not use a hard or abrasive brush.*
- Do not spray the inside of the printer with lubricants; unsuitable oils can damage the mechanism. Contact your dealer or a qualified service person if lubrication is needed.*

Transporting the Printer

If you need to transport your printer some distance, carefully repack it using the original box and packing materials as follows:

1. Open the printer cover and make sure that the print head is in the home (far right) position. If not turn on the printer and wait until the print head returns to the home position. Turn off the printer and then close the printer cover.



Caution:

Leave the ink cartridges installed when you transport the printer. Removing the cartridges during transport can damage the printer.

2. Unplug the power cord from the electrical outlet; then disconnect the interface cable from the printer.
3. Remove the paper from the sheet feeder and remove the paper support.
4. Push in the output extension tray, and then raise the output tray.
5. Attach the protective materials to the printer.
6. Repack the printer and power cord in the original box.
7. Keep the printer level during transport.

Chapter 6

Troubleshooting

Diagnosing the Problem	6-2
Error indicators	6-2
Status Monitor	6-4
Printer operation check	6-4
Problems and Solutions	6-7
Power supply	6-7
Operation	6-8
Paper handling	6-13
Printing quality	6-16
Increasing the Print Speed	6-23
Cleaning the Print Head	6-25
Aligning the Print Head	6-28
Ink Cartridge Problems	6-28
Contacting Customer Support	6-30
For United Kingdom and the Republic of Ireland users	6-30
For Australian users	6-33
For Hong Kong and Singapore users	6-35
For Philippines users	6-36









Diagnosing the Problem

Troubleshooting printer problems is best handled in two easy steps: first diagnose the problem, then apply likely solutions until the problem is fixed. The information that you need to diagnose the most common problems is provided by the printer's control panel lights and by the EPSON Status Monitor utility (Windows 95 only).

















In addition, you can determine whether a problem lies with the printer itself or with the computer by performing a printer operation check (see page 6-4). In "Problems and Solutions" later in this chapter you can find causes and solutions to specific printer problems. Use the information presented in this chapter to pinpoint the source of your problem, then apply the recommended solutions until the problem is solved.

Error indicators

You can identify many common printer problems with the lights on the control panel. If your printer stops working and the lights are on or flashing, use the following table of panel light patterns to diagnose the problem, then follow the recommended corrective measures.

Lights	Problem and Solution	
<input type="checkbox"/> 	Paper Out	
	No paper is loaded in the printer.	Load paper in the sheet feeder; then press the  load/eject button to turn this light off. The printer resumes printing.
	The paper is not loaded correctly.	Remove and reload the paper. See "Loading Paper" in Chapter 2.
<input type="checkbox"/>  <input checked="" type="checkbox"/>  <input checked="" type="checkbox"/> 	Paper Jam	
	Paper has jammed in the printer.	Take all the paper out of the feeder, and reload the paper. If the light continues to flash, turn off the printer and gently pull all the paper out of the printer. If it tears and pieces remain inside the printer, open the printer cover and remove the pieces of paper. Turn on the printer and try again.
<input type="checkbox"/> 	Ink Low (black ink cartridge)	
	The black ink cartridge is nearly empty.	Obtain a replacement black ink cartridge (S020093). See page 5-2 for details.
<input type="checkbox"/> 	Ink Out (black ink cartridge)	
	The black ink cartridge is empty.	Replace the black ink cartridge with a new one (S020093). See page 5-2 for details.
<input type="checkbox"/> 	Ink Low (color ink cartridge)	
	The color ink cartridge is nearly empty.	Obtain a replacement color ink cartridge (S020089). See page 5-2 for details.
<input type="checkbox"/> 	Ink Out (color ink cartridge)	
	The color ink cartridge is empty.	Replace the color ink cartridge with a new one (S020089). See page 5-2 for details.

= on, = off, = flashing

Lights	Problem and Solution	
<i>Carriage Error</i>		
       	Printer failed.	Press the  power button twice to reset the printer. If the error is not cleared, contact your dealer.
<i>Unknown Printer Error</i>		
       	An unknown printer error has occurred.	Turn off the printer, and contact your dealer.

□ = on, ■ = off,  = flashing

Status Monitor

If you are using Windows 95, you can check the printer's current status with the Status Monitor. See page 3-15.

Printer operation check

Performing a printer operation check can help you determine whether the problem comes from the printer or the computer.

To perform a printer operation check, follow these steps:

1. Make sure both the printer and computer are turned off.
2. Unlock the wire clips on both sides of the interface connector and remove the ground connector, if necessary. Then disconnect the cable from the printer's interface connector.

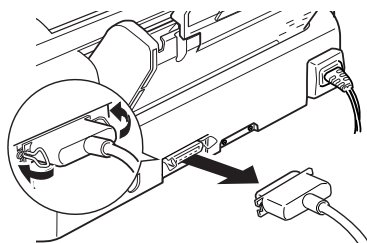



3. Make sure that paper is loaded in the sheet feeder.



Caution:

Use paper at least 182 mm (7.17 inches) wide; for example, B5 size paper loaded short edge first. Otherwise, the print head will spray ink directly onto the platen during the self test and smear any documents you print afterwards.

4. Hold down the  load/eject button and press the  power button to turn on the printer. Then release both buttons.

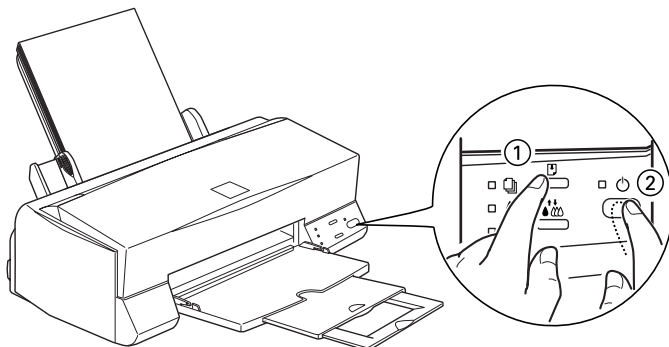

The printer prints an operation check page including the version of your printer's ROM, the ink counter code, the current code page, and a nozzle check pattern. Here is a typical printout:

The above sample is in black and white, but the actual test prints in color (CMYK).

5. Press the  power button to turn off the printer after it finishes printing the operation check page.
 - ❑ If the operation check page results appear as shown in step 4, this means that the printer itself is all right and that the problem probably lies in the printer software settings, application settings, the interface cable (be sure to use a shielded cable), or the computer itself.
 - ❑ If the operation check page does not print satisfactorily, for example, if any segment of the printed lines is missing, there is a problem with the printer. This could be a clogged ink nozzle or a misaligned print head. See "Problems and Solutions" below for possible causes and solutions to the problem, or go directly to "Cleaning the Print Head" on page 6-25.

Problems and Solutions

This section divides printer problems into five sections:

- Power supply page 6-7
- Operation page 6-8
- Paper handling page 6-13
- Printing quality page 6-16

Go to the section that most likely contains the source of the problem, and look for the description that matches the problem. The causes and solutions are listed from the most likely to the least likely, so try them in the order that they are written until the problem is solved.

Power supply

The lights come on briefly but then go off and stay off.	
---	--

Cause	What to do
The printer's voltage rating does not match the voltage of your electrical outlet.	Check the printer and outlet voltage ratings. If the voltages do not match, unplug the printer immediately and contact your dealer.



Warning:

Do not reconnect the power cord to an electrical outlet that does not have matching voltage.

The printer does not work and the control panel lights are off.

Cause	What to do
The printer is turned off.	Press the ⏻ power button. The ⏻ power light will come on.
The power cord is not properly plugged into the electrical outlet.	Turn off the printer, make sure the power cord is firmly plugged into the electrical outlet, and turn the printer back on. If the lights don't come on, press the ⏻ power button again. If they still don't come on, contact your dealer.
The electrical outlet is controlled by an outside switch or automatic timer.	Use a different outlet.
The electrical outlet is out of order.	Plug another electrical device into the outlet to determine whether the outlet is working. If it is not, use a different outlet.

Operation

The ⏻ power light is on but nothing prints.

Cause	What to do
The interface cable is not plugged in securely.	Confirm that the cable is securely fastened to the printer and the computer. If the cable is connected correctly, perform a printer operation check as described on page 6-4.
Your interface cable does not meet both the printer and computer specifications.	Use an interface cable that meets both printer and computer specifications. See page 1-4.



Your software is not properly set up for your printer. Make sure that your printer is selected in your software.

Install or reinstall the printer software as described in Chapter 2.

Nothing prints and several of the control panel lights are on or flashing.

Cause	What to do
Several common printer errors have occurred at once.	Use the table in “Error indicators” earlier in this chapter to determine what combination of errors may have occurred, and apply the recommended solutions.

The printer sounds like it is printing, but nothing prints.

Cause	What to do
The print head nozzles are clogged.	Clean the print head. See “Cleaning the Print Head” later in this chapter. If this does not work after a few trials, please contact your dealer.
One or both of the ink cartridges are older than six months or beyond the date on the packaging.	Try cleaning the print head. If that does not solve the problem, replace the ink cartridges as needed. If both  and  lights are off, see “Ink Cartridge Problems” later in this chapter.

The printer operation check page prints well, but nothing prints from an application.

Cause	What to do
Your printer is not selected in your software.	Select your printer in the printer setup section of your software.
The interface cable does not meet both the printer and computer requirements.	Use a printer cable that meets the requirements shown under "Interface cables" on page 1-4.
Your computer is not 100% IBM [®] AT compatible.	Select Use Print Manager for this port in the Queue Setup window. To access this window, double-click the EPSON Spool Manager4 icon in the EPSON folder and select Setup from the Queue menu.
Your computer system's memory is insufficient to handle the volume of data in your document.	<p>Try reducing the image resolution of your document in your image-editing software.</p> <p>Install more memory in your computer if you can.</p> <p>Select lower resolution or less colors for your display setting as described below.</p> <p>For Windows 95, choose a lower resolution setting as the Color Palette setting. To access the Color Palette, click Start, point to Settings, and choose Control Panel. Then double-click the Display icon and click the Settings tab. For detailed information on making this setting, see your Windows 95 user's guide.</p>

For Windows 3.1, double-click the Windows Setup icon on the Main menu; then click Options and choose Change System Settings. Then choose a lower resolution setting for your display from the Display pop-up list. For detailed information on making this setting, see your Windows 3.1 user's guide.

If you have a display adapter setting utility, use it to set lower resolution. For detailed information, see your display board user's guide.

Color documents print out in black and white.	
--	--

Cause	What to do
Your printer is not selected in your software.	Select your printer in your software.
Color printing is not selected in your application or in the printer driver.	Select color printing in your application and the printer driver. Try to print again. If the image still comes out in black and white, try printing from another program. If this fixes the problem, contact the manufacturer of the application you had trouble with.

Printing starts too high or too low on the page.

Cause	What to do
Margins are set incorrectly in your application.	Check that the margins are set correctly in your program. See “Printable area” in Appendix B.
The size of the paper loaded in the printer does not match the paper size setting within your application.	Load the correct size of paper, or change the paper size settings within your application to match the size of the paper you are using.



Print speed is not what you expect.

Cause	What to do
The image resolution and the amount of color used in the document may be too high.	Carefully considering your use of color and resolution can help you optimize your printing times. For more details, see “Increasing the Print Speed” later in this chapter.

Note:

High resolution printing and color printing significantly increase the amount of data to be processed. These two factors have the greatest effect on print speed.

The print head moved to the ink cartridge replacement position unexpectedly.

Cause	What to do
The  cleaning button was pressed while the  or  light was flashing or on.	One or both of the ink cartridges is low or out of ink. Replace the ink cartridges as described in Chapter 5.

The New Hardware Found screen appears even though the printer software has already been installed.

Cause	What to do
The error may occur in Windows 95 system.	Click Do not install a driver [Windows will not prompt you again], then click OK.

Paper handling

Paper does not feed properly from the sheet feeder.

Cause	What to do
Too many sheets are loaded in the sheet feeder.	Take the paper stack out of the feeder, remove some sheets, and reload the stack. Load paper only up to the arrow mark on the left edge guide.
The edge guides are not set correctly.	Adjust the guides against the stack of paper. See “Loading Paper” in Chapter 2.
Paper is jammed in the paper path.	Turn off the printer and gently pull all of the paper out of the printer. If it tears and pieces remain inside the printer, open the printer cover; then remove any remaining pieces of paper.
The paper is curled or folded.	Use flat, undamaged paper.
The paper is old or creased.	Use only new, smooth sheets of paper.
The paper’s size is not compatible with the printer.	Use paper that meets the paper requirements for this printer. See “Paper” in Appendix B.

The printer loads more than one sheet at a time.

Cause	What to do
Too many sheets are loaded in the sheet feeder.	Take the paper stack out of the feeder, remove some sheets, and reload the stack. Load paper only up to the arrow mark on the left edge guide.
The edge guides are not set correctly.	Adjust the guides against the stack of paper. See “Loading Paper” in Chapter 2.
The paper is too thin.	Make sure the paper meets the paper requirements for this printer. See “Paper” in Appendix B.

Ejected paper is wrinkled.

Cause	What to do
The paper is too thin or damp.	Do not store your paper in a damp or humid environment. Store paper in its original packaging.

Paper does not fully eject.

Cause	What to do
The paper is too long.	Press the  load/eject button to eject the paper. Use paper that meets the paper requirements for this printer. See “Paper” in Appendix B.

Paper feed or paper jam problems occur frequently.

Cause	What to do
Sheets of paper are stuck together.	Fan the stack of paper and straighten it before loading.
The edge guides are not set correctly.	Adjust the guides against the stack of paper.
The paper is too thin or rough.	Make sure the paper meets the paper requirements for this printer. See "Paper" in Appendix B.
Special media that should be loaded one sheet at a time is loaded more than one sheet at a time.	Check the paper package to confirm whether the type of media you are using may be loaded more than one sheet at a time.
Too many sheets are loaded in the sheet feeder.	Load paper only up to the arrow mark on the left edge guide.
The printable side of the paper is not correctly loaded.	Try turning the stack of paper over in the sheet feeder. Most packages of paper indicate the printable side with an arrow on the end of the package. Make sure the printable side is loaded face up.

Printing quality

The printed image has gaps or faint areas.

Cause	What to do
The print head nozzles are clogged.	Clean the print head. See “Cleaning the Print Head” later in this chapter.
The paper quality has been reduced due to age.	Use new paper.
The printer driver settings may not be correct.	Select Automatic on the printer driver’s Main menu and make sure the Media Type setting is appropriate for the type of paper loaded in the printer. See page 3-12.

The printed image is blurred.

Cause	What to do
Your paper is moist or damp.	Do not store your paper in a damp or humid environment. Store the paper in its original packaging.
The printer driver settings may not be correct.	Select Automatic on the printer driver’s Main menu and make sure the Media Type setting is appropriate for the type of paper loaded in the printer.

Printed image is smeared.

Cause	What to do
The paper you loaded is too thick.	Open the printer cover and set the adjust lever to the “+” position.
Special paper was loaded without the support sheet or a regular sheet of paper under it.	Load the support sheet or a piece of plain paper under the special paper.

Multiple sheets of EPSON Photo Quality Glossy Film are loaded.

Load glossy film one sheet at a time with the loading support sheet or a piece of plain paper under the glossy film.

If you need to load multiple sheets of glossy film, load only up to 30 sheets and set the top margin of the page to 30 mm or more.

Ink has leaked on the platen.

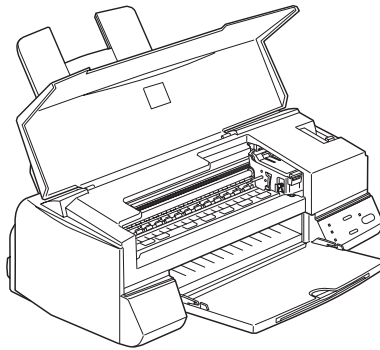

Wipe the inside of the printer as shown below with a soft, clean cloth.



Warning:

Be careful not to touch the gears inside the printer.

White horizontal lines appear in the printed image.

Cause	What to do
The print head nozzles are clogged.	Clean the print head. See “Cleaning the Print Head” later in this chapter.
One of the ink cartridges is low on ink.	Check the control panel to confirm that the  or  ink out light is flashing, and replace the appropriate ink cartridge.
The MicroWeave option in your printer driver is off.	Turn on MicroWeave in your printer driver’s More Settings dialog box.
The Media Type setting on the Main menu of the printer driver is incorrect.	Make sure the Media Type setting matches the type of paper loaded in the printer. See page 3-12.

Vertical lines do not align.

Cause	What to do
The print head is misaligned.	Align the print head with the Print Head Alignment utility. See “Aligning the Print Head” later in this chapter.
The printing position is misaligned.	Make sure the High Speed option in your printer driver’s More Settings dialog box is not selected.

Printing quality is not what you expect.

Cause	What to do
The paper loaded is not the paper selected in your application or the printer driver.	Make sure you loaded the correct paper in the printer and that you selected the same media type in your application and/or the printer driver. See page 3-12. Make sure you are using paper that meets the paper requirements for this printer. See “Paper” in Appendix B.
You are not printing on the correct side of the paper.	Check the paper packaging for the correct side for printing; then load the printable side of the paper face up in the sheet feeder.
The printer driver settings are not correct.	Check the printer driver settings to make sure they are appropriate. If these settings are correct, check the settings in your application, because some driver settings are overridden by application settings. Also, for more information on making appropriate printer driver settings, see online help.

Colors are different than you expect.

Cause	What to do
Black ink is selected in your printer driver.	Set the Ink setting to Color.
The paper is not loaded printable side up.	Make sure that the printable side of the paper is facing up.

The Media Type setting does not match the paper loaded.	Change the Media Type setting in your printer driver to match the type of media you have loaded, or load media that matches the Media Type setting. See page 3-12.
The print head nozzles for a particular color of ink are clogged.	Clean the print head. See “Cleaning the Print Head” later in this chapter.
The ICM setting in your driver is not appropriate for your document.	Select Automatic on the printer driver’s Main menu.
Your printer and monitor are not properly calibrated for color matching.	See the user’s guides of your image-editing software and your monitor for information on calibrating your system for color matching.
Since monitors and printers produce colors differently, printed colors will not always match on-screen colors perfectly.	See online help, EPSON Answers, and “Tips for Color Printing” in Appendix A.

Colors are not very vibrant.

Cause	What to do
The image was printed on the wrong side of EPSON 360 dpi Ink Jet Paper.	Make sure that you are printing on the coated side of the paper. If necessary, flip over the paper and try printing again. If printing does not improve clean the print head.
The Media Type setting does not match the loaded paper.	Make sure the Media Type setting matches the type of paper loaded in the printer, or load media that matches the Media Type setting. See page 3-12.

**Color dots are missing in printed characters or graphics.
The printed color image has gaps or faint areas.**

Cause	What to do
The color print head nozzles are clogged.	Clean the print head. See “Cleaning the Print Head” later in this chapter.

**Black dots are missing in printed characters or graphics.
The printed black image has gaps or faint areas.**

Cause	What to do
The black print head nozzles are clogged.	Clean the print head. See “Cleaning the Print Head” later in this chapter.



Photographic images look grainy or rough.

Cause	What to do
The printing position is misaligned.	Align the print head with the Print Head Alignment utility. See “Aligning the Print Head” later in this chapter.
The resolution of the original image data or the resolution setting for the image in your image-editing software may be too low.	Increase the image resolution in your image-editing software. Keep in mind that higher resolution images take longer to print.

The Status Monitor window does not appear when you are using Windows 95.

Cause	What to do
The Use Print Manager for this port option is checked in the Queue Setup window.	Make sure Use Print Manager for this port is not checked. Click the Start button, point to Programs, point to Epson, and click Spool Manager4. Then click Setup on the Queue menu in the EPSON Spool Manager window.
The Enable bi-directional support for this printer option is not selected in the Spool Settings window.	You must select Enable bi-directional support for this printer in the Spool Settings window to use the Status Monitor. To access the Spool Settings window, click the Start button, point to Settings, and click Printers. Right-click the icon for your printer and choose Properties from the drop-down menu. Click the Details tab; then click Spool Settings. Select Enable bi-directional support for this printer.

When you clean the print head using the Head Cleaning utility, the output quality does not improve.

Cause	What to do
You attempted to clean the print head while the ink cartridges were low or out of ink.	Check the  or  ink out light. When the ink cartridges are low or out, the Head Cleaning utility does not work. Replace the ink cartridges as needed.

Increasing the Print Speed

Just as printing at a high resolution requires more processing time, printing in color takes longer than printing in black because the volume of data in a color document is much greater. For this reason, it is important to be selective in your use of color if you also require a faster print speed.

Even if your document requires the highest resolution and extensive use of color, for example when printing a camera-ready composite that includes color photographs, it may still be possible to optimize the print speed by adjusting other printing conditions. Keep in mind that changing some conditions to increase the print speed may also lower print quality.

The following table shows the factors that inversely affect print speed and print quality (increasing one will decrease the other).

Print quality Print speed	Lower Faster	Higher Slower
Printer driver settings		
Print Quality	Economy*, Normal - 360 dpi	Fine - 720 dpi
High Speed	On	Off
Halftoning	No Halftoning	Error Diffusion
Data characteristics		
Image size	Small	Large
Resolution	Low	High

*The Economy and Normal - 360 dpi settings print at about the same speed. However, Economy saves ink and prints lower quality output.

The table below shows the factors related to print speed only.

	Print speed	
	Faster	Slower
Printer driver settings		
Ink	Black	Color
Collate*	Off	On
Flip Horizontal*	Off	On
Reverse Order*	Off	On
Data characteristics		
Variety of colors	Grayscale **	Full color
Hardware resources		
System speed	Fast	Slow
HDD free space	Large	Small
Memory free space	Large	Small
Software status		
Running applications	One	Many
Virtual memory	Not in use	In use

*Varies depending on the printer driver and application software you are using.



**Grayscale means using black ink only to print varying shades of gray, from pure black to pure white.

Cleaning the Print Head



If you find that the printed image is unexpectedly faint or dots in the printed image are missing, you may be able to solve these problems by cleaning the print head, which ensures that the nozzles are delivering ink properly.

You can clean the print head from your computer with the Head Cleaning utility in the printer software, or from the printer itself by using the printer's control panel buttons.



Note:

- Print head cleaning uses both color and black ink. To avoid wasting ink, clean the print head only if print quality declines.*
- Use the Nozzle Check utility to confirm that the print head needs to be cleaned. This saves ink.*
- When the  or  ink out light is flashing or on, you can not clean the print head. Replace the appropriate ink cartridge first.*
- Do not start the Head Cleaning or Nozzle Check utility while printing is in progress; otherwise your printout may be marred.*

Using the Head Cleaning utility

1. Make sure that both  and  ink out lights are off.

Note:

If the  black or  color ink out light is flashing, you can not clean the print head. Replace the appropriate ink cartridge first.

2. Access the Printer driver setting menu as described in Chapter 3.
3. Click the Utility tab, then click the Head Cleaning button.

4. Follow the messages on your screen.

While the printer is cleaning the head, the  power light flashes and any paper loaded in the printer is automatically ejected.





Caution:



This operation takes about two minutes to complete. Never turn off the printer while the  power light is flashing.

5. When the  power light stops flashing, click Print nozzle check pattern in the Head Cleaning dialog box, or print a few lines from a document, to confirm that the head is clean and to reset the cleaning cycle.

Using the control panel buttons

1. Make sure that the  power light is on and the both  and  ink out lights are off.

Note:

If the  or  ink out light is flashing or on, you can not clean the head, and this operation will start the ink cartridge replacement procedure. If you do not want to replace an ink cartridge at this moment, press the  cleaning button to return the print head to its home position.

2. Hold down the  cleaning button for three seconds.

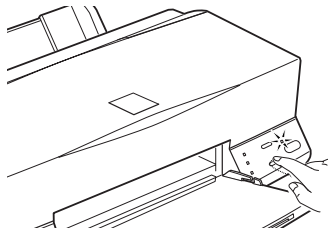

The printer starts cleaning the print head and the  power light begins flashing.



Caution:

This operation takes about two minutes to complete. Never turn off the printer while the  power light is flashing.

3. When the  power light stops flashing, print a few lines from a document, to confirm that the head is clean and to reset the cleaning cycle.

Aligning the Print Head

If you notice a misalignment of vertical lines, you may be able to solve this problem from your computer using the Print Head Alignment utility in your printer software.

Note:

Do not start the Print Head Alignment utility while printing is in progress; otherwise your printout may be marred.

1. Make sure the paper is loaded in the sheet feeder.





Caution:

Use paper at least 210 mm (8.27 inches) wide; for example, A4 size paper loaded short edge first. Otherwise, the print head will spray ink directly onto the platen.

2. Access the printer driver setting menu as described in Chapter 3.
3. Click the Utility tab, then click the Print Head Alignment button.
4. Follow the messages on your screen to align the print head.

Ink Cartridge Problems



If output quality does not improve even after cleaning and aligning the print head, you may need to replace one or both of the ink cartridges.

To replace an ink cartridge before the  or  ink out light flashes, follow the steps below.

If the  or  ink out light is flashing or is on, replace the empty ink cartridge as described in “Replacing an Ink Cartridge” on page x-xx.

**Caution:**

Once you remove an ink cartridge, it becomes unusable and cannot be reinstalled even if ink remains.



1. Make sure the printer is on, then open the printer cover.
2. Hold down the  load/eject button for three seconds, the print head moves to the replace position. The  power light begins flashing.
3. Lift the appropriate ink cartridge clamp. Dispose of the empty ink cartridge properly.
4. Remove the yellow tape seal from the new cartridge and lower the cartridge into the cartridge holder.
5. Press the ink cartridge clamp down until it locks in place.

**Caution:**

Once you install the cartridges, do not open their clamps again until you replace the ink cartridges. Otherwise, the cartridges may become unusable.

6. Press the  load/eject button again. The printer moves the print head back to its home position and charges ink in the system.

**Caution:**

The  power light continues to flash while the printer performs the ink charging operation. Never turn off the printer while the  power light is flashing. Doing so can result in incomplete charging of ink.

Note:

Even if you do not press the  load/eject button, the printer moves the print head back to its home position about 60 seconds after you replace the cartridge.

Contacting Customer Support

If your printer is not operating properly and you cannot solve your problem with the troubleshooting information in this guide, in online help, or in EPSON Answers, contact EPSON customer support for assistance.

We will be able to help you much more quickly if you are able to give the exact information indicated below.

Serial number of your printer:

(The serial number label is on the back of the printer.)

Printer model:

Brand and model of your computer:

Printer software version:

(Click About on the printer driver's Main menu.)

Version of Windows (95, 3.1, etc.) you are using now:

Names and version numbers of programs you normally use with your printer:

For United Kingdom and the Republic of Ireland users

If you purchased your printer in the UK or the Republic of Ireland, Epson (UK) Limited provides a range of customer services and technical support.

Note:

For customers in the Republic of Ireland, please use the correct dialling codes when dialling the UK telephone numbers listed in the following section. For example, the Enquiry Desk fax number, 01442 227271 should be dialled as 0044 1442 227271 from the Republic of Ireland.

Enquiry Desk

The enquiry desk team can be contacted by calling 0800 220546 in the UK, 1 800 409132 from the Republic of Ireland, by faxing 01442 227271, or via the Internet at info@epson.co.uk. They can provide the following information:

- ❑ Information and literature on new Epson products (also available from Faxon Epson)
- ❑ Where to purchase genuine Epson consumables, accessories and options

Customer Support

Our customer support team can provide the following services:

- ❑ Technical information on installing, configuring and operating your Epson products
- ❑ Arranging for faulty Epson products to be repaired within the warranty period

For information on contacting our Customer Support team, please see the Service and Support Information booklet that came with your Epson product.

If this booklet is not available, details can be found on Faxon Epson faxback service, EPtec Bulletin Board Service or on Epson's World Wide Web site. See below for details.

Faxon Epson

Contact Faxon Epson Faxback Service for:

- ❑ Literature and Specifications on the latest Epson products
- ❑ Support information including troubleshooting tips, switch settings and driver information

To use Faxon Epson, call 01442 227332 using a touch-tone phone. You will be asked to follow a simple routine to register your document request and once you have entered your telephone and fax numbers, Faxon Epson will fax a copy of the document catalogue to your fax machine.

When you have found the documents that you need in the catalogue, call Faxon Epson again and enter the document ID numbers. The documents will be faxed to you automatically.

EPtec - Bulletin Board Service for latest drivers and utilities

You can call the Epson Bulletin Board Service on 01442 227479. No membership is required. Make sure that your communications software is set to 8 data bits, 1 stop bit, no parity bit, ANSI terminal mode emulation and a modem speed of up to 28.8 Kbps. Downloading protocols supported include Xmodem, Ymodem and Zmodem. See the documentation that came with your communications software and modem for more information.

When you first connect to the Bulletin Board Service, you will be asked for your name, company name, phone number and a password (which you can invent yourself).

World Wide Web

If you can connect to the Internet and have a Web Browser, you can access Epson's World Wide Web site at <http://www.epson.com>. Here you will find information on the latest Epson Products, software drivers and answers to frequently asked questions.

For Australian users

EPSON Australia wishes to provide you with a high level of Customer Service. As well as this *User's Guide*, we provide the following sources for obtaining information:

EPSON FAXBACK

EPSON FAXBACK will fax you the latest specifications and pricing for most EPSON products offered in Australia. There is also Technical Information including details of the latest software and drivers available. Phone (02) 9903 9075 and the system will guide you through a number of choices before faxing the information to your fax machine.

EPSON Bulletin Board System

This is where you can download the latest software and drivers. Visit the BBS to check out the latest versions. If you have a modem, phone (02) 9417 5090.

Internet URL <http://www.epson.com.au>

Access the Epson Australia World Wide Web pages. Worth taking your modem here for the occasional surf! You can get the same information as offered on the EPSON FAXBACK and the EPSON Bulletin Board plus more.

Your Dealer

Don't forget that your dealer can often help identify and resolve problems. The dealer should always be the first call for advice on problems. They can often solve problems quickly and easily as well as give you advice on the next step to take.

EPSON Helpdesk

EPSON Helpdesk is provided as a final backup to make sure our clients have access to advice. Operators on the Helpdesk can aid you in diagnosing hardware and software problems. They can also advise you on the latest EPSON products and where the nearest dealer or service agent is located. Many types of queries are answered here.

Access to the Helpdesk is at no charge to purchasers of new products for the first 12 months of that product's life. After that period, a different phone number is used and charges are debited to your telephone account. The current charge rates are specified when you ring the chargeable support number. You are asked to signify your acceptance before any charges are incurred.

The Helpdesk numbers are:

first 12 months	(02) 9903 9040
after 12 months	1 902 263 192
fax number	(02) 9903 9189

We encourage you to have all the relevant information on hand when you ring. The more information you prepare, the faster we can help solve the problem. This information includes the user's guide for your EPSON product, type of computer, operating system, application programs, and any other information you feel is required.

For Hong Kong and Singapore users

Contact the phone or fax number shown below for your area:

Hong Kong

Phone: 2585 4300
Fax: 2827 7083

Singapore

Phone: 3377911
Fax: 3341185

Internet home page

EPSON Hong Kong has established a local home page in both Chinese and English on the Internet to provide users with the following information:

- Product information
- Answers to Frequently Asked Questions (FAQs)
- Latest versions of EPSON printer drivers

Users can access our World Wide Web home page at:
<http://www.epson.com.hk>.

Electronic bulletin board system

An electronic bulletin board system (BBS) is also available to obtain printer information and the latest versions of printer drivers. You can log on to the following number for the BBS service:

BBS: (852) 2827-4244

Technical Support Hotline

You can also contact our technical staff at the following telephone and fax numbers:

Phone: (852) 2585-4399
Fax: (852) 2827-4383

For Philippines users

To obtain technical support as well as other after sales services, users are welcome to contact the EPSON Philippines Representative Office at the telephone and fax numbers below:

Phone: (632) 813-6552
Fax: (632) 813-6545
BBS: (632) 814-0595



Basics of Color A-2
Image Resolution and Image Size A-5
Guidelines for Using Color A-7

Basics of Color

This section describes the basic properties of color, the relationships between colors, and how to use color to improve the quality of your printed documents.

Properties of color

Color is composed of three properties: hue, saturation, and brightness.

Hue	The name of the color, such as red, blue, or violet. The circle that represents the relationship between all hues is called the hue circle.
Saturation	The vividness of the color. This represents the amount of gray in proportion to the hue.
Brightness	The relative lightness or darkness of the color.

The method for representing these properties is called the Munsell renotation color system. The hue circle and the Munsell renotation color system are useful to understand the properties of color. See also the *Color Guide*.

Synchronizing monitor colors and printer colors

Your printer produces images by printing tiny patterns of ink dots on paper. It uses the colors cyan (C), magenta (M), yellow (Y), and black (K) to create a blending effect that makes you think you are seeing millions of colors. This type of color, produced by pigments that absorb some colors of light and reflect others, is called subtractive.

Note:

In theory, pure cyan, magenta, and yellow should produce black, but actually they produce a muddy brown and must be combined with black ink to produce a true black (K).

Your monitor produces images by illuminating color phosphors on the screen with an electron gun. (A phosphor is a substance that gives off light when irradiated.) Each screen point (pixel) has three colored phosphors: red (R), green (G), and blue (B).

Since the printer and monitor produce color images differently, and also the available range of color produced by the monitor and printer are different, the image on the screen does not exactly match your printed output all of the time. If you want to adjust, or calibrate, the printed color to more closely match the on-screen color, you may have to experiment with the printer driver settings.

Additionally, color management software is available from a variety of software and monitor companies to help you match colors produced by your monitor and printer. See your image-editing software user's guide for information on color matching.

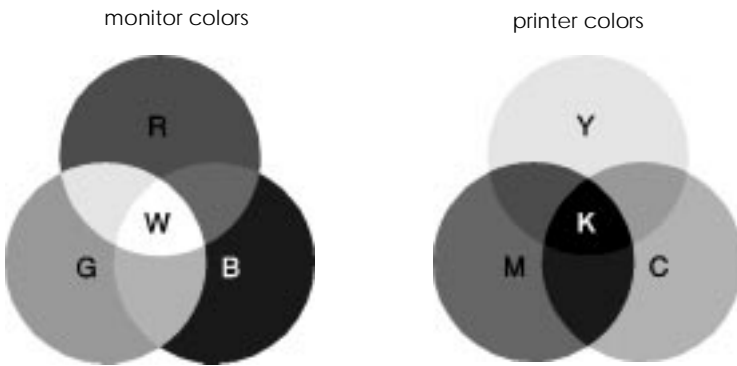

The range of colors that can be displayed:

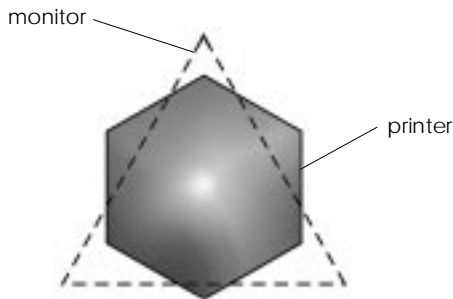

Note:

When printing a scanned image, you may find it more difficult to match colors. Because scanners create the original image data using CMYK, the data format of your image will be changed twice.

Process of color printing

A printer produces color images by printing tiny patterns of ink dots using CMYK colors as mentioned in the previous section. Because most ink jet printers are not able to print different gradations of the three primary colors, they must use a halftoning method in order to represent millions of colors or the gradation of colors as follows:



Dithering and error diffusion are the most commonly used halftoning methods.

Dithering

Dithering uniformly aligns individual dots of different colored inks to create the appearance of natural colors. This method is suitable for printing documents that contain large areas of solid color, such as bar charts and graphs.

Error diffusion

Error diffusion blends individual colored dots with the colors of the surrounding dots to create the appearance of natural colors. By blending colored dots, the printer can achieve excellent colors and subtle color gradation. This method is best suited for printing documents that contain finely detailed graphics or photographic images.

Image Resolution and Image Size

The resolution of your original image affects the quality of your printouts. Generally, the higher the resolution, the better the print quality. However, keep in mind that the higher the resolution, the longer the wait for processing and printing a document.

Generally, the printed image size is in inverse proportion to the image resolution, as shown below. The larger the image size, the lower the image resolution. Conversely, the smaller the image size, the higher the image resolution.

Note:

Some applications have a function that can correct this relationship.

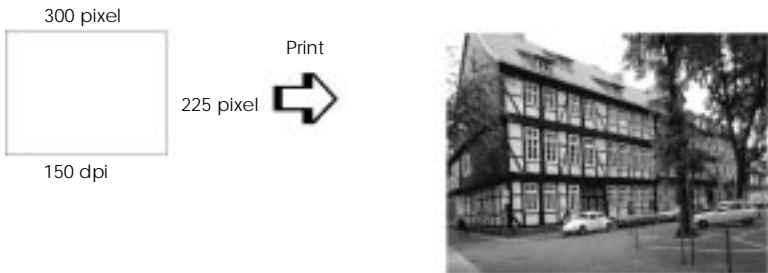
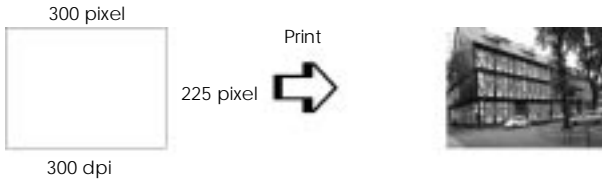

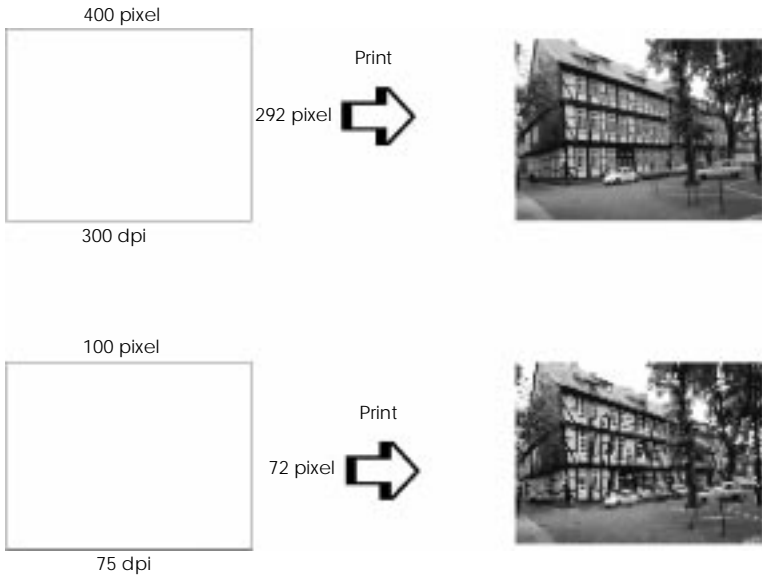

Since increasing the image size means decreasing the image resolution, you must take care that print quality or color tone is not degraded when working with images pasted into documents created with word processing software. To avoid print quality and color tone problems, change the size and the resolution of the image in your graphics application before pasting it into your document.

Guidelines for Using Color

To help you use color to maximize your document's impact on its readers, determine the who, what, when, where, why, and how of color printing.

Know WHO your readers are and WHAT your purpose is

Your documents are intended to communicate information, opinions, or feelings to one or more people and also to get results. Therefore, first you need to think about who is going to see your work: customer, co-worker, or other; and what your purpose is: to advise, sell, propose, and so on.

For example:

A marketing proposal with generous quantities of bright, fluorescent colors might fail to impress a conservative accounting firm, yet win over a music video company.

Know WHEN to use color

While color can enhance any document, you need to decide when color helps expand understanding of your message and when it distracts the reader. Sometimes a serious business message is best delivered without additional colors. (Remember that white and black are colors, too.)

For example:

A job offer letter to a prospective employee works best in black and white, while a list of safety rules benefits from attention-getting color.

Decide WHERE color will most benefit your document

If you use color on every page or all over a page, you may lose not only the impact of color, but also the clarity and readability of your work. When used consistently and strategically, color breaks up the monotony of black-and-white text reading.

Note:

- Avoid placing too many color pictures, tables, or icons on a page.*
- Size your color images so that they do not overpower text or graphics.*
- Avoid using too much colored text. It is more difficult to read than black-on-white or white-on-black text.*

Know WHY you are using color

Color adds interest and clarity, and makes documents appear easier to understand. Just as you use fonts and graphics to create appeal and capture attention, color provides an additional visual interpretation of a document that influences the reader.

For example:

An overhead presentation of sales results by territory is far more interesting and memorable if you show the figures with colored charts and graphs.

Know HOW to select colors

- Use just one hue in the hue circle to make your document unified. Modify saturation or brightness to add interest.

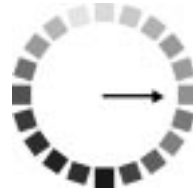

- Use contrasting hues to make your work more eye-catching.

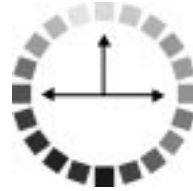

- Use of complementary colors in documents is generally not recommended.

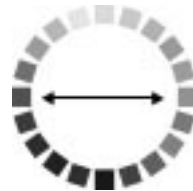

- Determine a rule for using color throughout the document.

Note:

See the Color Guide for the hue circle.

Appendix B

Printer Specifications



Printing	B-2
Paper	B-3
Printable area	B-5
Ink Cartridges	B-6
Mechanical	B-7
Electrical	B-8
Environmental	B-8
Safety Approvals	B-9



Printing

Printing method: On-demand ink jet
Nozzle configuration: Monochrome (black) 64 nozzles
Color (cyan, magenta, yellow) 63 nozzles
(21 (each color) × 3)

Printable columns and printing speeds:

Character Pitch (characters per inch)	Printing Column	LQ Printing Speed (characters per second)
10	80*	200

*Printing column varies depending on the driver settings.

Resolution: Maximum 720 dpi × 720 dpi
Print direction: Bidirectional with logic seeking
Control code: ESC/P Raster
Input buffer: 10KB
Character tables: The characters for PC437 (US, Standard Europe) and PC850 (Multilingual) can be selected using control panel buttons.
While holding down the  cleaning button, press the  power button. Then release both buttons.

Paper

Note:

Since the quality of any particular brand or type of paper may be changed by the manufacturer at any time, EPSON can not attest to the quality of any non-EPSON brand or type of paper. Always test samples of paper stock before purchasing large quantities or printing large jobs.

B**Single sheets:**

Size	A4 (210 mm × 297 mm) A5 (148 mm × 210 mm) B5 (182 mm × 257 mm) Letter (216 mm × 279 mm) Half letter (139.7 mm × 215.9 mm) Legal (216 mm × 356 mm) Executive (184.2 mm × 266.7 mm)
Paper types	Plain bond paper, special papers distributed by EPSON
Thickness	0.08 mm to 0.11 mm (0.003 to 0.004 inch)
Weight	64 g/m ² (17 lb) to 90 g/m ² (24 lb)

Envelopes:

Size	No. 10 (104 mm × 240 mm) DL (110 mm × 220 mm) C6 (114 mm × 162 mm)
Paper types	Plain bond paper, air mail
Thickness	0.16 mm to 0.43 mm (0.006 to 0.017 inch)
Weight	45 g/m ² (12 lb) to 75 g/m ² (20 lb)

Index cards:

Size	A6 (105 mm × 148 mm) 5 × 8" (127 mm × 203 mm) 8 × 10" (203 mm × 254 mm)
Paper types	Coated papers distributed by EPSON

Transparencies, glossy film, glossy paper:

Size A4 (210 mm × 297 mm)
 Letter (216 mm × 279 mm)
 A6 (105 mm × 148 mm)*

* Glossy film only

Paper types Special papers distributed by EPSON

Self adhesive sheets:

Size A4 (210 mm x 297 mm)

Paper types Special papers distributed by EPSON

Photo paper:

Size 4 × 6 inch (102 mm × 152 mm)

Paper types Special papers distributed by EPSON

Note:

Poor quality paper may reduce print quality and cause paper jams or other problems. If you encounter problems, switch to a higher grade of paper.

Do not load curled or folded paper.

Ink jet paper, envelopes, glossy film, glossy paper, and transparencies are only usable under normal conditions:

 Temperature 15 to 25°C (59 to 77°F)
 Humidity 40 to 60% RH

EPSON Photo Quality Glossy Film and Self Adhesive Sheets should be stored under the following conditions:

 Temperature 15 to 30°C (59 to 86°F)
 Humidity 20 to 60% RH

Printable area

Single sheets/index cards/adhesive sheets/transparencies

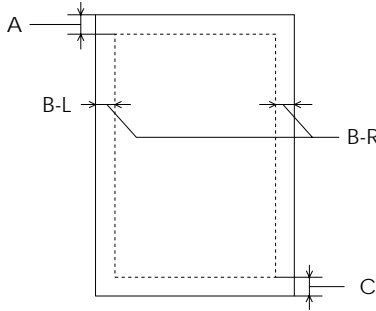

Envelopes

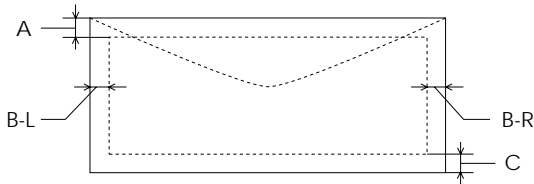

A: The minimum top margin is 3.0 mm (0.12 inch).

When loading multiple sheets of EPSON Photo Quality Glossy Film, the minimum top margin is 30 mm (1.2 inches).

B: The minimum left margin is 3.0 mm (0.12 inch).

The minimum right margin for single sheet paper is 3.0 mm (0.12 inch) except for letter and legal size paper. The minimum right margin for letter and legal size paper is 9.0 mm (0.35 inch).

The minimum right margin for envelopes is as follows:

7 mm (0.28 inch) for DL envelopes.

28 mm (1.10 inches) for No. 10 envelopes.

3 mm (0.12 inches) for C6 envelopes.

C: The minimum bottom margin is 14.0 mm (0.54 inch).

Note:

Always load paper into the sheet feeder short edge first. Load envelopes flap edge first with the flap side down.

Ink Cartridges

Black ink cartridge (S020093)

Color	Black
Print capacity*	540 pages (A4, text at 360 dpi)
Cartridge life	2 years from production date (within 6 months after opening package, at 25°C (77°F))
Temperature	Storage: -20 to 40°C (-4 to 104°F) 1 month at 40°C (104°F) Transit: -30 to 60°C (-22 to 140°F) 1 month at 40°C (104°F) 120 hours at 60°C (140°F) Freezing:** -16°C (3.2°F)
Dimensions	19.8 mm (W) × 52.7 mm (D) × 38.5 mm (H)

Color ink cartridge (S020089)

Colors	Cyan, Magenta, and Yellow
Print capacity*	300 pages (A4, 360 dpi, 5% each color)
Cartridge life	2 years from production date (within 6 months of opening the package at 25°C (77°F))
Temperature	Storage: -20 to 40°C (-4 to 104°F) 1 month at 40°C (104°F) Transit: -30 to 60°C (-22 to 140°F) 1 month at 40°C (104°F) 120 hours at 60°C (140°F) Freezing:** -18°C (-0.4°F)
Dimensions	42.9 mm (W) × 52.7 mm (D) × 38.5 mm (H)

* The print capacity may vary, depending on how often you use the print head cleaning function and how often you use the printer.

** It thaws and is usable after approximately 3 hours at 25°C (77°F).

**Caution:**

- EPSON recommends the use of original EPSON ink cartridges only. Other products not manufactured by EPSON may cause damage to your printer not covered by EPSON's warranties.
- Do not use an ink cartridge if the date on the package has expired.

Mechanical

Paper feed method:	Friction
Paper path:	Sheet feeder, rear entry
Sheet feeder capacity:	About 100 sheets at 64 g/m ² (17 lb) paper
Dimensions:	Storage Width: 429 mm (16.8 inches) Depth: 275 mm (10.8 inches) Height: 168 mm (6.6 inches) Printing Width: 429 mm (16.8 inches) Depth: 613 mm (24.1 inches) *695 mm (27.4 inches) Height: 309 mm (12.2 inches) *196 mm (7.7 inches) *For loading transparencies
Weight:	5.2 kg (11.4 pounds) without the ink cartridges

Electrical

	120V Model	220–240V Model
Input voltage range	103.5 to 132V	198 to 264V
Rated frequency range	50 to 60 Hz	
Input frequency range	49.5 to 60.5 Hz	
Rated current	0.4A	0.2A
Power consumption	Approx. 15W (ISO10561 Letter Pattern)	

This product is also designed for IT power system with phase to phase voltage 220-240V.

Note:

Check the label on the back of the printer for the voltage of your printer.

Environmental

Temperature:

Operation: 10 to 35°C (50 to 95°F)

Storage: ^{*}-20 to 60°C (-4 to 140°F)

1 month at 40°C (104°F)

120 hours at 60°C (140°F)

Humidity:

Operation: 20 to 80% RH

Storage: ^{**} 5 to 85% RH

* Stored in shipping container

**Without condensation

Safety Approvals

Safety standards:

U.S. model

UL 1950 with D3, CSA 22.2 950 with D3

European model

EN60950 (VDE and NEMKO)

EMC:

U.S. model

FCC part 15 subpart B class B

European model

EN 55022 (CISPR Pub. 22) class B

EN 50082-1

EN 61000-3-2

EN 61000-3-3

Australian model

AS/NZS 3548 class B

B

Glossary

The following definitions apply specifically to printers.

application

A software program that helps you carry out a particular task, such as word processing or financial planning.

ASCII

American Standard Code for Information Interchange. A standardized coding system for assigning numerical codes to letters and symbols.

banding

The horizontal lines that sometimes appear when printing graphics. This occurs when the print head carriage return is misaligned. See also *MicroWeave*.

bit

A binary digit (0 or 1), which is the smallest unit of information used by a printer or computer.

brightness

The lightness or darkness of an image.

buffer

The portion of the printer's memory used to store data before printing it.

byte

A unit of information consisting of eight bits.

characters per inch (cpi)

A measure of the size of text characters, sometimes referred to as pitch.

CMYK

Cyan (blue-green), magenta, yellow, and black. These colored inks are used to create the subtractive system array of printed colors.

cpi

See *characters per inch*.

default

A value or setting that takes effect when the equipment is turned on, reset, or initialized.

dithering

A halftoning method in which dots are arranged in an orderly pattern. Dithering works best for printing images with solid colors, such as charts and graphs. See also *halftoning*.

dot matrix

A method of printing in which each letter or symbol is formed by a pattern (matrix) of individual dots.

dpi

Dots per inch. The dpi measures the resolution. See also *resolution*.

driver

A software program that sends instructions to a computer peripheral to tell it what to do. For example, your printer driver accepts print data from your word processor application and sends instructions to the printer on how to print this data.

economy printing

Printing in which images are printed with fewer dots to save ink.

error diffusion

This halftoning setting smoothes out edges by randomly placing dots of varying colors. This has the opposite effect of the Finest detail setting.

ESC/P Raster

A command language that gives you control of your printer from your computer. Commands in this language produce laser-like features, such as enhanced graphics printing. (ESC/P is an abbreviation for Epson Standard Code for Printers.)

Finest detail

This printer driver setting feature automatically makes your printed images sharper and clearer. This has the opposite effect of the Error Diffusion setting. Be aware that this may increase the time required for printing.

font

A style of type designated by a family name.

grayscale

A scale of shades of gray from black to white. Grayscale is used to represent colors when printing with black ink only.

halftones

Patterns of black or colored dots used to reproduce an image.

halftoning

Method of using dot patterns to represent an image. Halftoning makes it possible to produce varying shades of gray using only black dots, or a nearly infinite array of colors using only a few colors of dots. See also *halftones*.

high speed printing

Printing in which images are printed in both directions. This provides faster printing.

initialization

Returns the printer to its defaults (fixed set of conditions). This happens every time you turn on the printer or reset the printer.

ink jet

A method of printing in which each letter or symbol is formed by precisely spraying ink onto paper.

interface

The connection between the computer and the printer. A parallel interface transmits data one character or code at a time.

loading position

The position to which the paper is automatically loaded.

media

Materials upon which data is printed, such as envelopes, plain paper, special paper, and transparency film.

MicroWeave

Printing in which images are printed in finer increments to reduce the possibility of banding and to produce laser-like images. See also *banding*.

monochrome

This means printing with only one color of ink, which is generally black ink.

operation check

A method for checking the operation of the printer. When you perform a printer operation check, the printer prints the ROM version, code page, ink counter code, and a nozzle check pattern.

parallel interface

See *interface*.

printable area

The area of a page on which the printer can print. It is smaller than the physical size of the page due to margins.

printer driver

A software program that sends commands for using the features of a particular printer. Often shortened to “driver”.

printing mode

The number of dots per inch used to represent an image. Your printer has three printing mode settings: Fine (720 dpi), Normal (360 dpi), and Economy.

print queue

If your printer is connected to a network, print jobs that are sent to the printer while it is busy are stored in a waiting line, or print queue, until they can be printed.

RAM

Random Access Memory. The portion of the printer’s memory used as a buffer and for storing user-defined characters. All data stored in RAM is lost when the printer is turned off.

reset

To return a printer to its defaults by turning the printer off and then back on.

resolution

The number of dots per inch used to represent an image.

ROM

Read Only Memory. A portion of memory that can only be read and cannot be used for data storage. ROM retains its contents when you turn off the printer.

RGB

Red, green, and blue. These colors, in phosphors irradiated by the computer monitor's electron gun, are used to create the additive array of screen colors.

spool

The first step in printing. The printer driver converts the print data into codes that your printer understands. This data is then sent to the printer directly or to the print server.

spool manager

The software program that converts print data into codes that your printer understands. See also *spool*.

status monitor

The software program that allows you to check the amount of ink remaining before printing. This is available for Windows 95 only.

subtractive colors

Colors produced by pigments that absorb some colors of light and reflect others. See also *CMYK*.

Index

A

- Adjust lever, 1-2, 4-6
- Advanced
 - Mode (button), 3-8, 3-10
 - settings list, 3-8, 3-11
 - See also* Main menu, Predefined settings, Printer driver settings
- Alignment, print head, 6-28. *See also* Utilities
- Automatic Mode (button), 2-23, 3-5, 3-7. *See also* Main menu

B

- Bidirectional printing. *See* High Speed setting
- Buttons
 - cleaning, 1-2-3, 5-3-6, B-2
 - load/eject, 1-2-3, 6-5, 6-29-30
 - power, 1-2-3, 6-5-6, B-2
 - See also* Printer driver settings, Online help

C

- Cables. *See* interface cables
- Calibration. *See* Print head alignment
- Cartridges. *See* Ink cartridges
- Character tables, B-2. *See also* Printer operation check
- Cleaning
 - button, 1-2-3, 5-3-6, B-2
 - sheets, 4-4

- Code page, 6-5. *See also* Character tables
- Collate option. *See* Online help
- Color
 - Adjustment settings. *See* Online help
 - basics of, A-2
 - matching, A-2-3
 - tips on using, Appendix A, EPSON Answers CD-ROM, Color Guide
- Computer requirements, 1-4
- Consumable products, 1-4-5
- Control
 - codes, B-2
 - panel, 1-2-3, 6-3
- Copies option. *See* Online help
- Current Settings display, 3-8. *See also* Online help
- Customer support, 6-30-36
- Custom Settings
 - dialog box, 3-11
 - See also* Advanced settings list

D

- Despooler, 2-24, 3-16-17. *See also* online help
- Dithering, A-4
 - Coarse (setting). *See* Online help
 - Fine (setting). *See* Online help
- Driver. *See* Printer driver

E

- Economy setting. *See* Predefined settings, Online help
- Edge guides, 1-2, 2-21–22
- Envelopes,
 - loading, 4-5, 4-7
 - printable area, B-5
 - specification, B-3
- EPSON
 - Answers CD-ROM. *See* Printer software, CD-ROM booklet
 - code language, B-2
 - special media, 1-5, 4-2, 4-4–6. *See also* Media Type option
- ESC/P Raster, B-2
- Error Diffusion, A-4. *See also* Online help
- Error indicators, 6-2

F

- Finest Detail setting, 6-24. *See also* Online help
- Flip Horizontal setting, 6-24. *See also* Online help

H

- Halftoning. *See* Online help
- Head
 - alignment, 3-16, 6-28
 - cleaning, 3-16, 6-25–27. *See also* Nozzle Check
- Help, 3-19
- High Speed setting, 6-23. *See also* Online help

I

- ICM
 - Advanced settings list, 3-9. *See also* Predefined settings, Online help
 - Color Adjustment setting. *See* Online help
- Index cards, 4-3, 4-5
 - specifications, B-3
- Ink cartridge, 1-4
 - clamps, 1-2
 - installing an, 2-6
 - problems, 6-29–30
 - replacing an, 5-2–6, 6-29–30
 - specifications, B-6
- Ink option, 2-23, 3-7, 3-10
- Interface cables, 1-4
 - connecting, 2-11

L

- Labels. *See* Self adhesive sheets
- Lights
 - ink out, 1-2–3, 5-2–3, 6-3, 6-25, 6-29
 - paper out, 1-2–3, 6-3
 - power, 1-2–3, 6-3, 6-26, 6-29–30
- Load/eject button, 1-3, 6-5, 6-29–30
- Loading paper. *See* Paper

M

- Main menu, 2-23, 3-2, 3-4
- Maintenance, Chapter 5
- Matching, color, A-2–3
- Media Type option, 2-23, 3-12–13.
 - See also* Online help
- MicroWeave. *See* Online help
- Mode, 3-2
- More Settings (dialog box), 3-10. *See also* Online help
- Moving the printer, 5-8

N

- Network, using with Windows 95, 2-16
- Nozzle Check
 - pattern, 6-5
 - utility, 3-16

O

- Online help, 3-19
- Operation check page, 6-4-6
- Options, 1-4-5
- Orientation option, 3-6. *See also* Online help
- Output tray, 1-2, 2-19

P

- Paper
 - choosing, 4-2-3
 - envelopes, 4-7, B-3, B-5
 - EPSON special, 1-5, Chapter 4
 - loading, 2-20-22
 - menu, 3-2, 3-5
 - Size option. *See* Online help
 - specifications, B-3-5
 - support, 1-2, 2-4
- Photo setting. *See* Online help
- Power button, 1-2-3, 6-5-6, B-2
- Precautions, 2-3
- Predefined settings, 3-8-9. *See also* Online help
- Print
 - direction, B-2. *See also* High Speed setting
 - head
 - alignment, 3-16, 6-28
 - cleaning, 3-16, 6-25-27. *See also* Nozzle Check
 - speed, 6-23-24
 - Quality option, 3-10, 3-12. *See also* Online help

Printable area, B-5

Printer

- cleaning, 5-7
 - control panel, 1-2-3, 6-3
 - network, 2-16
 - operation check, 6-4-6
 - parts, 1-2
 - problems, Chapter 6
 - resetting, 1-3
 - software installation, 2-12-18
 - specifications, B-7-8
 - speed, 6-23-24
 - stand, 2-4
 - status, 3-17. *See also* Status Monitor
 - transporting, 5-8
- Printer driver settings
- accessing, 2-22, 3-3-4
 - checking, 2-23, 3-4-6
 - customizing, 3-10
 - making, 3-7-13
- Printing for the first time, 2-22-24
- Problems, Chapter 6

Q

- Queue. *See* Online help
- Quality vs. Speed slide bar, 3-7

R

- Replacing an ink cartridge. *See* ink cartridge
- Resolution, 6-23, A-5-6, B-2. *See also* Online help, Color Guide
- Required system, 1-4
- Reverse Order setting. *See* online help

S

- Safety
 - approvals, B-8
 - instructions, 1–3
- Scroll bars. *See* Online help
- Self adhesive sheets, 4-3, 4-5
- specifications, B-4
- Self test. *See* Printer operation check, EPSON Answers
- Settings
 - adjust lever, 1-2, 4-6
 - printer driver. *See* Online help
- Sliders. *See* Online help
- Special media, 1-5, 4-2
 - cleaning sheets, 4-4
 - loading, 4-4–6
- Specifications, B-2–8
- Speed, 6-23–24
- Spool Manager, 3-16. *See* Online help
- Starting to print, 2-22–24
- Status Monitor, 2-24, 3-14–15. *See also* Online help
- System requirements, 1-4

T

- Text/Graph setting. *See* Predefined settings, Online help
- Thick paper, 1-2, 4-6
- Transparencies, 4-3, 4-5, 4-8, B-4
- Transporting the printer, 5-8
- Troubleshooting, Chapter 6

U

- User Defined Paper Size dialog box.
See Online help
- Utilities, 2-12, 3-14–18, 6-25–28
- Utility menu, 3-14

V

- Video/Digital Camera setting. *See* Predefined settings, Online help

W

- Windows
 - for Windows 3.1, 2-12, 2-17–18
 - for Windows 95, 2-12–17. *See also* Status Monitor

EPSON OVERSEAS MARKETING LOCATIONS

EPSON AMERICA, INC.

20770 Madrona Ave.
P.O. Box 2842
Torrance, CA 90509-2842
Phone: (800) 922-8911
Fax: (310) 782-5220

EPSON UK LTD.

Campus 100, Maylands Avenue,
Hemel Hempstead, Herts,
HP2 7TJ, U.K.
Phone: (+44) 01442 61144
Fax: (+44) 01442 227227

EPSON DEUTSCHLAND GmbH

Zülpicher Straße 6,
40549 Düsseldorf Germany
Phone: (0211) 56030
Telex: 8584786

EPSON FRANCE S.A.

68 bis, rue Marjolin
92300, Levallois-Perret, France
Phone: 33.1.40.87.37.37
Telex: 610657

EPSON AUSTRALIA PTY. LTD.

70 GIBBES STREET, CHATSWOOD 2067 NSW.
Phone: 2-9903-9000
Fax: 2-9903-9177

EPSON SINGAPORE PTE. LTD.

No. 1 Temasek Avenue #36-00
Millenia Tower, Singapore 039192
Phone: (065) 33 77 911
Fax: (065) 33 41 185

EPSON HONG KONG LTD.

Rooms 4706-10, 47/F,
China Resources Bldg.,
26 Harbour Road, Wanchai, Hong Kong
Phone: 2585-4300
Fax: 2827-7083

EPSON TAIWAN TECHNOLOGY & TRADING LTD.

10F, No. 287 Nanking E. Road, Sec. 3,
Taipei, Taiwan, R.O.C.
Phone: (02) 717-7360
Fax: (02) 712-9164

EPSON ITALIA S.p.A.

V.le F.lli Casiraghi 427
20099 Sesto S.Giovanni
MI, Italy
Phone: 2-262331
Fax: 2-2440750

EPSON IBERICA S.A.

Av. de Roma, 18-26
08290 Cerdanyola del Valles
Barcelona, Spain
Phone: 582. 15.00
Fax: 582. 15.55

**SEIKO EPSON CORPORATION
(Hirooka Office)**

80 Harashinden, Hirooka
Shiojiri-shi, Nagano-ken
399-07 Japan

EPSON PORTUGAL, S.A.

R. do Progresso, 471, 1º Perafita
4460 Matosinhos, Portugal
Phone: (02) 996 14 02
Fax: (02) 996 14 11

EPSON

Ink Jet Printer

EPSON Stylus™ COLOR 400

User's Guide



NOTICE

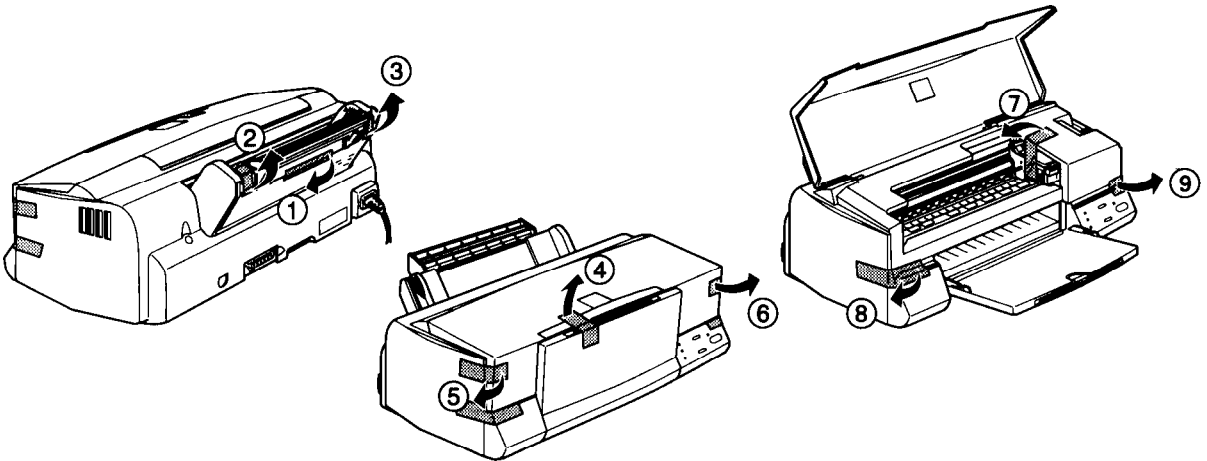

NOTE:

To prevent damage during shipping, several pieces of blue protective material are packed with your printer. You must remove these before you assemble your printer.

HINWEIS:

Zur Vermeidung von Transportschäden ist der Drucker durch schützende Verpackungsteile (blaufarbig) gesichert. Diese Teile müssen vor dem Zusammenbau des Druckers entfernt werden.

ATTENTION:

Afin d'éviter tout dommage durant le transport, des matériaux de protection bleus ont été emballés avec votre imprimante. Vous devez les retirer avant d'installer votre imprimante.

NOTA:

Para evitar daños durante el transporte, su impresora viene protegida por varias piezas azules de material protector. Debe retirar estas piezas antes de montar su impresora.

NOTA:

L'imballaggio della vostra stampante contiene molti elementi protettivi di colore blu, per prevenire danni durante il trasporto. Non dimenticate di toglierli prima di iniziare a utilizzare la stampante.

NOTA:

Para evitar danos durante o transporte, esta impressora possui materiais de protecção de cor azul. Retire-os antes de instalar a impressora.
