

EPSON

EPSON STYLUS™ CX5400

Setup

4047313-00
XXX

Warnings, Cautions and Notes

- Warnings must be followed carefully to avoid bodily injury.**
- Cautions must be observed to avoid damage to your equipment.**

Notes contain important information and useful tips on the operation of this product.

1 Unpacking

Make sure the following parts are included and not damaged.

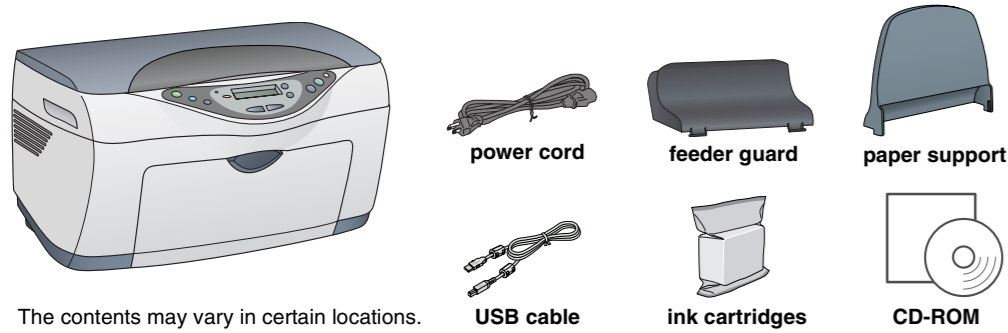

The contents may vary in certain locations.

2 Removing the Tapes

Remove the tapes and protective materials following the Notice Sheet. Make sure the protective materials around the ink cartridges are removed.

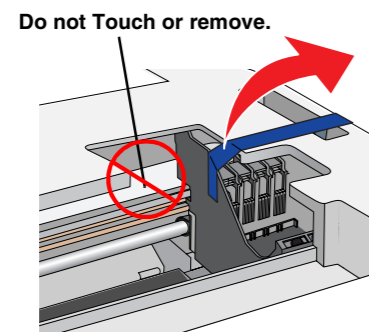

3 Unlocking

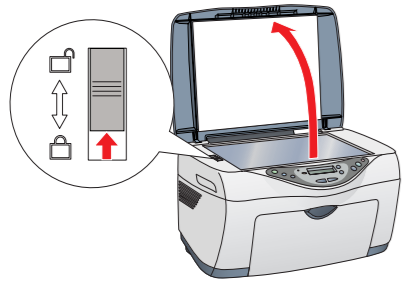

4 Attaching the Parts

- Attach the paper support.
- Insert the feeder guard into two slots in front of the paper support.

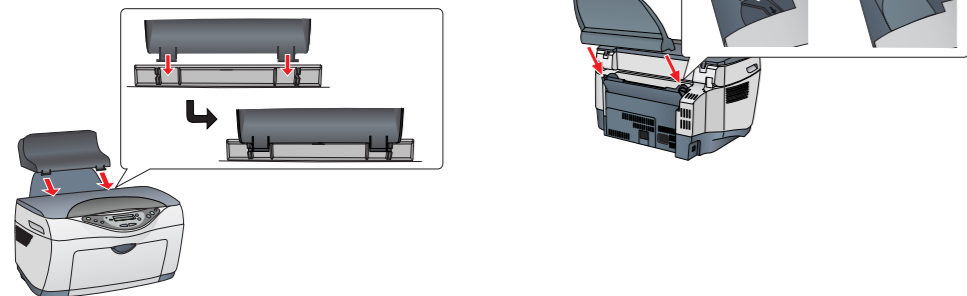

Note:
The feeder guard prevents items put on the document cover from getting into the inside of this product.

5 Turning On

Press the On button until the On light stays on in green.

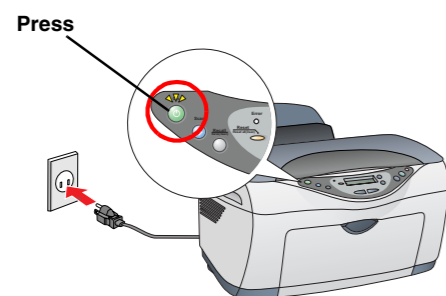

6 Installing Ink Cartridges

- Raise the scanner unit.

- Shake an ink cartridge four or five times and then remove it from its package.

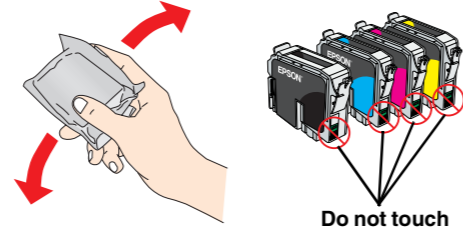

Do not touch

- Lower each cartridge into its holder.
- Press down on each cartridge until it is firmly seated.

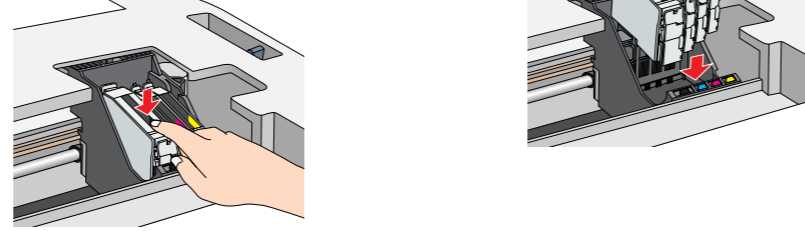

Note:
Install all ink cartridges. This product does not work unless all cartridges are installed properly.

- Lower the scanner unit.

Ink charging starts and it takes about one and a half minutes to complete.

The green light flashes and this product produces a variety of mechanical sounds. This is normal.

- Caution:**
 - Never turn off this product during the ink charging process.
 - Do not load paper until ink charging is complete.

7 Selecting a Language

- Press the right Menu button until Languages appears on the LCD panel.
- Select a language by pressing the Copies/Value buttons.
- Press the Stop button.

Menu items appear in the selected language.

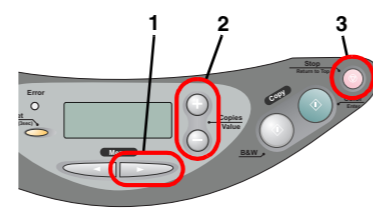

8 Loading Paper

- Lower the output tray and then slide out the extension.
- Move the feeder guard towards you.



- Slide out the edge guide.

- Load a stack of paper to rest against the right side of the feeder and slide the edge guide against the paper. Then set the feeder guard back.

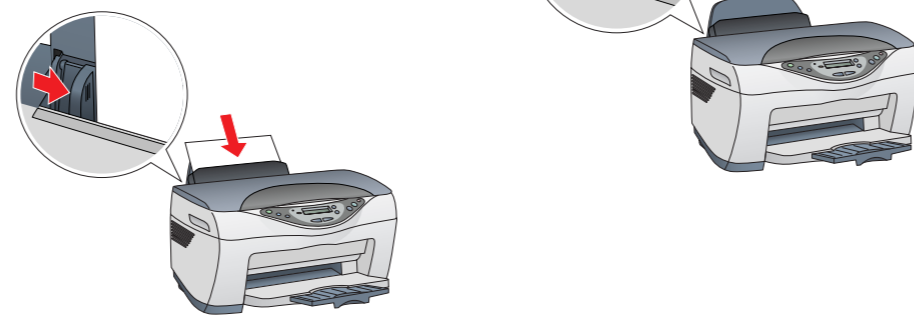

Now you are ready to make copies. See the next section to learn how to make a test copy. If you want to install software, see "Connecting to Your Computer" on this sheet.

9 Making Copies

- Place a document on the document table.

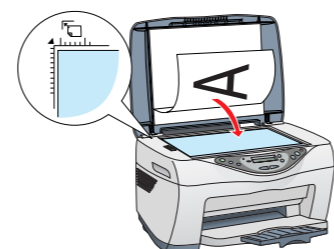

- Press the Copies/Value buttons to set the number of copies.
- Press the B&W Copy button (to copy in grayscale), or the Color Copy button (to copy in color).

Caution:
Do not open the scanner unit during scanning or copying; otherwise, you may damage this product.

The Stylus CX starts Copying.

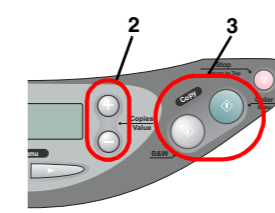

10 Connecting to Your Computer

- Make sure the Stylus CX is turned off.
- Use a USB cable to connect the Stylus CX to your computer.

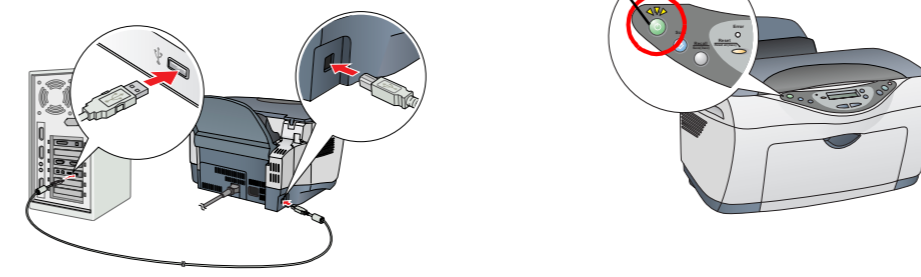

11 Installing the Software

Note

- If your CD is labeled "Multilingual CD", you must install the English software from the English CD first. Next, install your preferred language addition from the Multilingual CD.
- This software does not support the UNIX File System (UFS) for Mac OS X. Install the software on a disk or in a partition that does not use UFS. This product does not support the Max OS X Classic environment.

- Make sure the Stylus CX is connected and turned off, and then insert the software CD.

For Mac OS 8.6 to 9.X, double-click the icon in the software CD.

For Mac OS X, open the Mac OS X folder and then double-click icon.

- Turn off all virus protection programs and then click Continue.
- Read the license agreement and then click Agree.
- Click Install, and then follow the onscreen instructions.
- When you see this screen, turn on your Stylus CX and wait until the screen disappears. Then follow the onscreen instructions. Note that EPSON Smart Panel is installed in several steps.

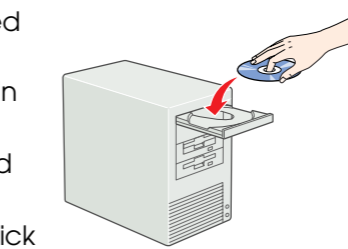
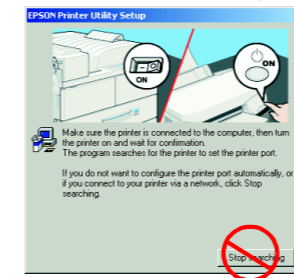

- Click Exit or Restart Now on the final screen, and then remove the CD-ROM.

For Windows users, you are ready to scan and print. See "Features" or "Getting More Information" on this sheet for instructions.

For Macintosh users, see the next section to set up the Stylus CX as a printer.

Setting up the printer for Mac OS 8.6 to 9.X

- Open Chooser from the Apple menu.
- Select CX5400 and your USB port, and then close Chooser.

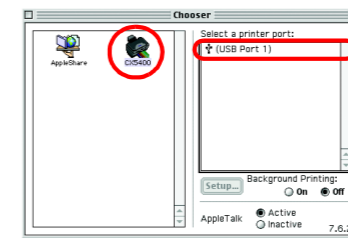

Setting up the printer for Mac OS X

- Open the Applications folder on your hard drive, and then open the Utilities folder and double-click Print Center.
- Click Add Printer in the Printer List dialog box.
- Select EPSON USB, click CX5400(USB), and then select All from the Page Setup pop-up menu. Finally, click Add.
- Make sure Printer List contains the printer (margin-type) options, and then click Close.

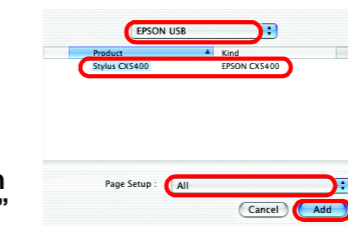

Now you are ready to scan and print for Macintosh users. See "Features" or "Getting More Information" on this sheet for instructions.

Features

Using Copy Mode

This product provides you with a variety of copying options. You can choose from various formats and use many different types of paper.



Standard

You can make copies to various sizes or types of single sheet paper with a 3 mm margin around all edges of paper.

Border Free

You can copy to the full page (including the margin area) of paper.

Small Margin

You can make copies with a 1.5 mm margin around all edges of paper.

Mirror

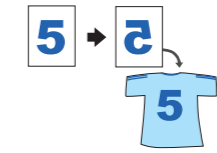

You can create the mirror image of an original image on Iron-On Cool Peel Transfer Paper (image flipped from right to left).

Repeat

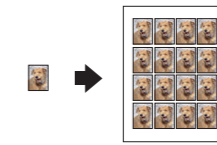

You can create multiple copies of an image on a sheet of paper.

2-up/4-up



You can put two or four pages of the original images on a sheet of paper.

For more information on using the copy functions, see the Copy Guide.

Printing

You can print data, and make photos, postcards, and posters from your computer.

To use this feature, you need to connect your computer with the EPSON Printer software installed. See "Installing the software" on this sheet to install EPSON Printer software.



Scanning

You can scan documents, photos and other materials into an electronic format for your computer, and then use the scanned images in professional and personal projects.

To use the scan features, you need to connect it to your computer with the EPSON Scan and EPSON Smart Panel installed. See "Installing the software" on this sheet to install the EPSON Scan and EPSON Smart Panel.



EPSON Smart Panel

It is the control center of your STYLUS CX. Use it to copy, e-mail, scan, print, fax, or use OCR (Optical Character Recognition).



Getting More Information

Getting Started

Contents	Describes in short how you can start using this product in standalone mode. For full operation details, please refer to the Copy Guide.
----------	---

Copy Guide

Contents	Describes how to use this product as a copy machine, change ink cartridges and check the condition of this product. It also provides troubleshooting tips and customer support information.
How to access	Double - click the ESCX5400 Copy Guide icon on the desktop, or go to your language folder on the Multilingual CD and double - click the Copy Guide icon.

Reference Guide

Contents	Provides basic information on printing and scanning. Information is also available on maintenance, troubleshooting tips, technical informations and customer support.
How to access	Double - click the ESCX5400 Reference Guide icon on the desktop.

Online Help

Contents	Provides you with detailed information on the printer driver and EPSON Scan.
How to access	Click the Help button in the driver dialog box.