

# EPSON

## CARD-686

DBIOS Manual  
(Extended Functions)



## **NOTICE**

No part of this material may be reproduced or duplicated in any form or by any means without the written permission of Seiko Epson. Seiko Epson reserves the right to make changes to this material without notice. Seiko Epson does not assume any liability of any kind arising out of any inaccuracies contained in this material or due to its application or use in any product or circuit and, further, there is no representation that this material is applicable to products requiring high level reliability, such as, medical products. Moreover, no license to any intellectual property rights is granted by implication or otherwise, and there is no representation or warranty that anything made in accordance with this material will be free from any patent or copyright infringement of a third party. This material or portions thereof may contain technology or the subject relating to strategic products under the control of the Foreign Exchange and Foreign Trade Control Law of Japan and may require an export license from the Ministry of International Trade and Industry or other approval from another government agency.

©Seiko Epson Corporation 1997 All rights reserved.

IBM and PS/2 are registered trademarks of International Business Machines Corporation.

MS-DOS are registered trademarks of Microsoft.

All other product names mentioned herein are trademarks and/or registered trademarks of their respective companies.

# Contents

<b>1</b>	<b>CARD-686 DBIOS Manual (Extended Functions) .....</b>	<b>1</b>
	INT 10h-Video services .....	1
<b>2</b>	<b>CARD-686 DBIOS Features .....</b>	<b>11</b>
	Display related extended functions .....	11
	APM related extended functions .....	15
	BIOS parameter table.....	16
<b>Appendix</b>	<b>Technical Information .....</b>	<b>20</b>
	VGA extended CMOS area.....	20
	Memory map .....	22

# CARD-686 DBIOS Manual

## (Extended Functions)

The CARD-686 DBIOS Manual (Extended Functions) explains functions and provides relevant information specific to the CARD-686 DBIOS. For information on basic functions that are identical for all Epson DBIOS products, please refer also to the Epson DBIOS Manual (Basic Functions).

## 1 CARD-686 DBIOS Extended Functions

### INT10h - Video services

The CARD-686 provides the following video modes.

#### Video modes for "CRT" and "CRT & flat panel"

7bit Mode No.	VESA Mode Number	Number of colors	Char. x Row	Char. Cell	Screen Format	Display Mode	Horizontal Frequency (KHz)	Vertical Frequency (Hz)
0h,1h	-	16/256k	40 X 25	9 X 16	360 X 400	Text	31.5	70
2h,3h	-	16/256k	80 X 25	9 X 16	720 X 400	Text	31.5	70
4h,5h	-	4/256k	40 X 25	8 X 8	320 X 200	Graphics	31.5	70
6h	-	2/256k	80 X 25	8 X 8	640 X 200	Graphics	31.5	70
7h	-	Monochrome	80 X 25	9 X 16	720 X 400	Text	31.5	70
0Dh	-	16/256k	40 X 25	8 X 8	320 X 200	Graphics	31.5	70
0Eh	-	16/256k	80 X 25	8 X 14	640 X 200	Graphics	31.5	70
0Fh	-	Monochrome	80 X 25	8 X 14	640 X 350	Graphics	31.5	70
10h	-	16/256k	80 X 25	8 X 14	640 X 350	Graphics	31.5	70
11h	-	2/256k	80 X 30	8 X 16	640 X 480	Graphics	31.5	60
12h	-	16/256k	80 X 30	8 X 16	640 X 480	Graphics	31.5	60
13h	-	256/256k	40 X 25	8 X 8	320 X 200	Graphics	31.5	70
78h	100h	256/256k	80 X 50	8 X 8	640 X 400	Graphics	31.5	70
79h	101h	256/256k	80 X 60	8 X 8	640 X 480	Graphics	31.5	60
6Ah,7Ah	102h	16/256k	100 X 75	8 X 8	800 X 600	Graphics	48	72
7Bh	103h	256/256k	100 X 75	8 X 8	800 X 600	Graphics	48	72
7Ch	104h	16/256k	128 X 96	8 X 8	1024 X 768	Graphics	48	60
7Dh	105h	256/256k	128 X 96	8 X 8	1024 X 768	Graphics	48	60

The shaded video modes cannot be used for "CRT & flat panel".

Video modes for "flat panel"

7bit Mode No.	VESA Mode Number	Monochrome STN	Color STN	Color TFT	Char. X Row	Char. Cell	Screen Format	Display Mode
		Number of Shades	Number of colors	Number of colors				
0h,1h	-	16	16/256K	16/256K	40 X 25	9 X 16	360 X 400	Text
2h,3h	-	16	16/256K	16/256K	80 X 25	9 X 16	720 X 400	Text
4h,5h	-	4	4/256K	4/256K	40 X 25	8 X 8	320 X 200	Graphics
6h	-	2	2/256K	2/256K	80 X 25	8 X 8	640 X 200	Graphics
7h	-	2	Monochrome	Monochrome	80 X 25	9 X 16	720 X 400	Text
0Dh	-	16	16/256K	16/256K	40 X 25	8 X 8	320 X 200	Graphics
0Eh	-	16	16/256K	16/256K	80 X 25	8 X 14	640 X 200	Graphics
0Fh	-	2	Monochrome	Monochrome	80 X 25	8 X 14	640 X 350	Graphics
10h	-	16	16/256K	16/256K	80 X 25	8 X 14	640 X 350	Graphics
11h	-	2	2/256K	2/256K	80 X 30	8 X 16	640 X 480	Graphics
12h	-	16	16/256K	16/256K	80 X 30	8 X 16	640 X 480	Graphics
13h	-	64	256/256K	256/256K	40 X 25	8 X 8	320 X 200	Graphics
78h	100h	64	256/256K	256/256K	80 X 50	8 X 8	640 X 400	Graphics
79h	101h	64	256/256K	256/256K	80 X 60	8 X 8	640 X 480	Graphics
6Ah, 7Ah	102h	64	16/256K	16/256K	100 X 75	8 X 8	800 X 600	Graphics
7Bh	103h	64	256/256K	256/256K	100 X 75	8 X 8	800 X 600	Graphics
7Ch	104h	64	16/256K	16/256K	128 X 96	8 X 8	1024 X 768	Graphics
7Dh	105h	64	256/256K	256/256K	128 X 96	8 X 8	1024 X 768	Graphics

## Function 12h - VGA BIOS extended functions

The CARD-686 provides the following video services.

Function specification	Service name	Description
(BL) = 89h	Reverse video	Control reverse video for monochrome flat panel
(BL) = 8Fh	Expanded mode	Enlarge characters vertically for "CRT & flat panel" or "flat panel"
(BL) = 90h	Vertical position control	Adjust display position for "CRT & flat panel" or "flat panel"
(BL) = 92h	Display select	Select "CRT", "flat panel", or "CRT & flat panel" as display device
(BL) = 9Ah	Get current setting	Get current setting information for video services

### (BL) = 89h - Reverse video

This function controls reverse video for the monochrome flat panel display. It has no effect when a color flat panel display is used.

---

#### INPUT

---

(AH) = 12h  
 (BL) = 89h  
 (AL) = 0 - Text reverse, graphics normal  
 1 - Text normal, graphics normal  
 2 - Text reverse, graphics reverse  
 3 - Text normal, graphics reverse

---

#### OUTPUT

---

(none)

---

**(BL) = 8Fh - Expanded mode**

This function is valid only if the flat panel display is selected. When the video mode is text, this function enlarges characters on the display vertically (including graphics characters).

---

INPUT	
(AH) =	12h
(BL) =	8Fh
(AL) =	0 - Expanded mode enabled 1 - Expanded mode disabled

---

OUTPUT	
	(none)

---

**(BL) = 90h - Vertical position control**

This function is valid for the "flat panel" and "CRT & flat panel" display modes. If the number of scan lines of the currently selected video mode is lower than the number of scan lines of the display in vertical direction, position control of the display image on the flat panel display can be carried out.

---

INPUT	
(AH) =	12h
(BL) =	90h
(AL) =	0 - Display image shown in center of flat panel 1 - Display image shown from top of flat panel

---

OUTPUT	
	(none)

---

**(BL) = 92h - Display select**

Selects the display device. "CRT" or "flat panel" or "CRT & flat panel" can be selected.

---

INPUT	
(AH) =	12h
(BL) =	92h
(AL) =	0 - Select flat panel as display device 1 - Select CRT as display device 2 - Select flat panel and CRT as display device

---

OUTPUT	
	(none)

---

**(BL) = 9Ah - Get current setting**

This function gets the current user option settings related to video.

**INPUT**

(AH) = 12h  
(BL) = 9Ah

**OUTPUT**

(AX) = Option status 1 (see below)  
(BX) = Option status 2 (see below)  
(CX) = Option status 3 (see below)

**(AX) = Option status 1**

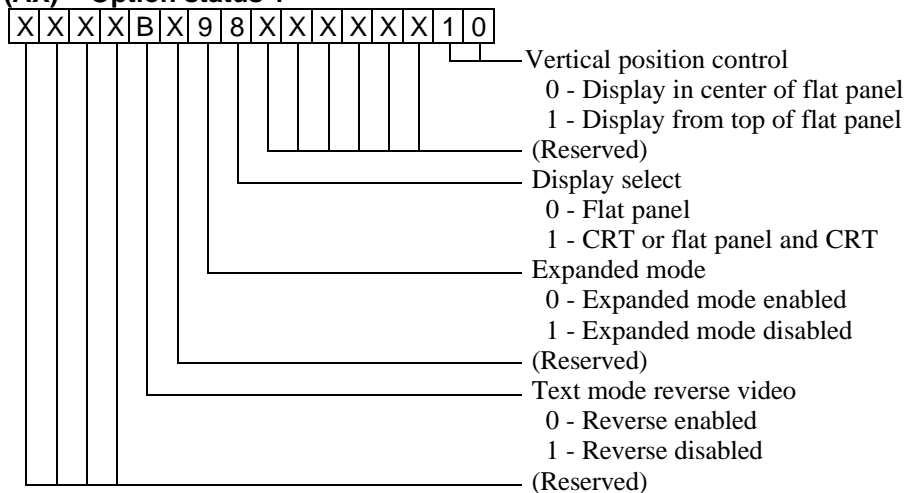

**(BX) = Option status 2**

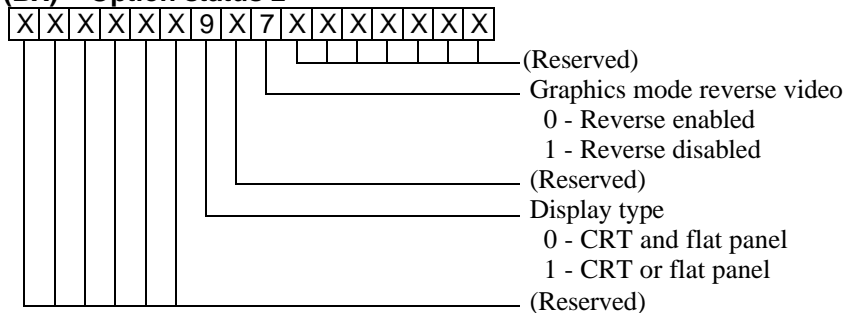

**(CX) = Option status 3**

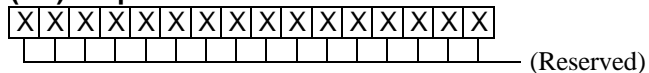



## Function 4Fh - Super VGA BIOS extended functions

The CARD-686 provides the following Super VGA BIOS extended functions. These functions comply with the VESA Super VGA standard version 1.0.

Function specification	Service name	Description
(AL) = 00h	Get Super VGA information	Get function information from the Super VGA BIOS
(AL) = 01h	Get Super VGA mode information	Returns the current Super VGA screen mode
(AL) = 02h	Set Super VGA screen mode	Set Super VGA screen mode
(AL) = 03h	Get Super VGA screen mode information	Returns the current Super VGA screen mode
(AL) = 05h	Control video memory window	Select Super VGA video memory window
(AL) = 06h	Get video memory window position	Returns the current Super VGA video memory window position

### (AL) = 00h - Get Super VGA information

#### INPUT

(AH) = 4Fh  
 (AL) = 00h  
 (ES:DI) = Pointer to information block (see below)

#### OUTPUT

(AH) = 0 - Normal end  
 4Fh - Abnormal end  
 (AL) = 0 - Function not supported  
 4Fh - Function supported  
 (Other registers are maintained)

Note: Information block structure is shown below.

offset(bytes)	information	comment
+00h (4)	'VESA'	4-byte signature
+04h (2)	0100h	VESA version number
+06h (4)	aaaa:bbbb	Pointer to OEM string
+0Ah (4)	0	(Reserved; always 0)
+0Eh (4)	cccc:dddd	Pointer to supported Super VGA modes
+12h (2)		Number of 64KB memory blocks on board
+14h(236)		(Reserved)

**(AL) = 01h - Get Super VGA mode information**

**INPUT**

(AH) = 4Fh  
 (AL) = 01h  
 (ES:DI) = Pointer to mode information block (see below)

**OUTPUT**

(AH) = 0 - Normal end  
 4Fh - Abnormal end  
 (AL) = 0 - Function not supported  
 4Fh - Function supported  
 (Other registers are maintained)

Note: Mode information block structure is shown below.

offset(bytes)	information	comment
+00h (2)	Mode Attributes	(See below)

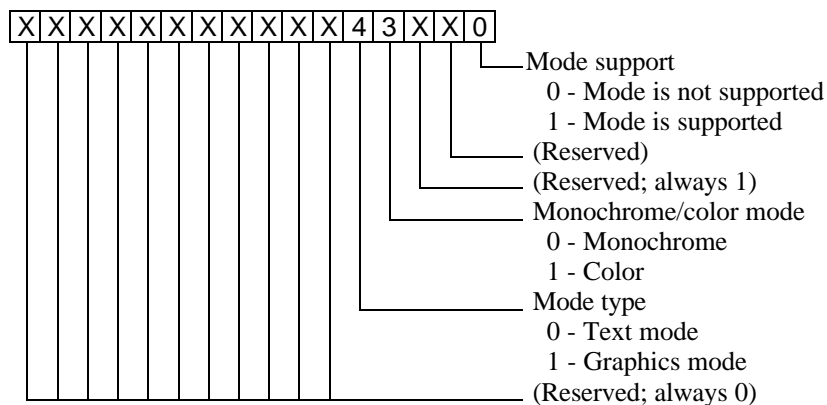

+02h (1)	WinA Attributes	(See below)
----------	-----------------	-------------

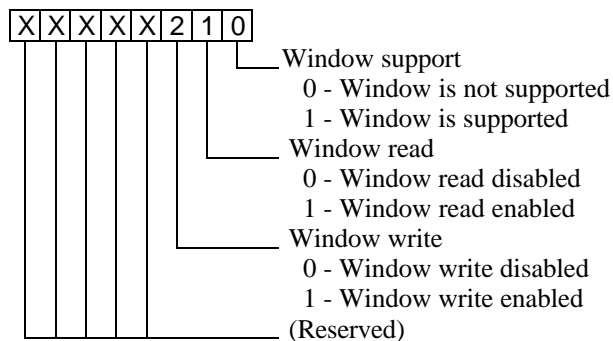

+03h (1)	WinB Attributes	(Same structure as WinA Attributes)
+04h (2)	Win Granularity	Minimum window size (in KB)
+06h (2)	Win Size	Window size (in KB)
+08h (2)	WinA Segment	WinA start segment
+0Ah (2)	WinB Segment	WinB start segment
+0Ch (4)	Win Func Pointer	Pointer to window function
+10h (2)	Bytes per ScanLine	Number of bytes per scan line
+12h (2)	X Resolution	Horizontal resolution
+14h (2)	Y Resolution	Vertical resolution
+16h (1)	X Char Size	Width of character box
+17h (1)	Y Char Size	Height of character box
+18h (1)	Number of Planes	Number of memory planes
+19h (1)	Bits per Pixel	Number of bits per pixel
+1Ah (1)	Number of Banks	Number of banks
+1Bh (1)	Memory Model	Memory model 0: Text 1: CGA graphics 2 : Hercules graphics 3: 4 planes 4-255: Reserved
+1Ch (1)	Bank Size	Bank size (in KB)
+1Dh (1)	Number of Pages	Number of display pages

**(AL) = 02h - Set Super VGA video mode**

INPUT

(AH) = 4Fh  
 (AL) = 02h  
 (BX) = Video mode

OUTPUT

(AH) = 0 - Normal end  
 4Fh - Abnormal end  
 (AL) = 0 - Function not supported  
 4Fh - Function supported  
 (Other registers are maintained)

---

**(AL) = 03h - Get current Super VGA video mode**

---

**INPUT**

(AH) = 4Fh

(AL) = 03h

---

**OUTPUT**

(AH) = 0 - Normal end

4Fh - Abnormal end

(AL) = 0 - Function not supported

4Fh - Function supported

(BX) = Current video mode

(Other registers are maintained)

---

**(AL) = 05h****(BH) = 00h - Control video memory window**

---

**INPUT**

(AH) = 4Fh

(AL) = 05h

(BH) = 00h

(BL) = Window number 0 = WinA, 1 = WinB

(DX) = Window position in video memory

(in window granularity units)

---

**OUTPUT**

(AH) = 0 - Normal end

4Fh - Abnormal end

(AL) = 0 - Function not supported

4Fh - Function supported

(Other registers are maintained)

**(AL) = 05h****(BH) = 01h - Get Super VGA video memory window position**

---

**INPUT**

---

(AH) = 4Fh

(AL) = 05h

(BH) = 01h

(BL) = Window number 0 = WinA, 1 = WinB

---

**OUTPUT**

---

(AH) = 0 - Normal end

4Fh - Abnormal end

(AL) = 0 - Function not supported

4Fh - Function supported

(DX) = Window position in video memory

(in window granularity units)

(Other registers are maintained)

---

## 2 CARD-686 DBIOS Features

### Display related extended functions

The CARD-686 offer the following display related extended functions. For details regarding the corresponding flags in CMOS-RAM, please refer to the extended VGA section of the CMOS-RAM area map in the appendix. For information on VGA BIOS extended functions, please refer to "INT10h - Video services" in section 1 of the current document.

#### **Normal/reverse display video mode**

This function controls the reverse display mode for the monochrome flat panel display. By making this setting in the CMOS-RAM, the normal/reverse display condition at startup can be set independently for graphics mode and text mode.

The CMOS-RAM setting 41h[0]=1 causes startup with reverse display in graphics mode, and the CMOS-RAM setting 41h[1]=1 causes startup with reverse display in text mode. These functions can also be selected from the setup menu.

Applications can temporarily override this setting using the Int10h, (AH)=12h, (BL)=89h reverse video function.

This function is valid only for monochrome flat panel displays. On CRT and color flat panel displays, the setting has no effect. This also applies to the Int10h reverse video functions.

#### **Expanded screen mode**

In 200-line and 400-line screen mode, the expanded mode enlarges the display area in the vertical direction, to make characters easier to read. The expanded screen mode can be used only when "flat panel" or "CRT & flat panel" is selected and when the screen mode uses 200 lines or 400 lines.

The CMOS-RAM setting 42h[7]=1 causes startup with expanded display. The function can also be selected from the setup menu.

Applications can temporarily override this setting using the Int10h, (AH)=12h, (BL)=8Fh expanded mode function.

This function is valid only when "flat panel" or "CRT & flat panel" is selected.

## Vertical position control

This function allows control of image position in the vertical direction. The screen image can either start at the very top of the flat panel display or be centered on the display.

The CMOS-RAM setting 41h[5:4]=00b causes startup with centered display, and 01b with top-aligned display. The function can also be selected from the setup menu.

Applications can temporarily override this setting using the Int10h, (AH)=12h, (BL)=90h vertical position control function.

This function is valid only when "flat panel" or "CRT & flat panel" is selected. Note that the function cannot be used if the expanded screen mode is activated.

## Display select

This function selects either "CRT", "flat panel", or "CRT & flat panel".

The CMOS-RAM setting 40h[1:0]=10b causes startup with flat panel selected, 01b with CRT selected, and 11b with CRT & flat panel selected. The function can also be selected from the setup menu.

Applications can temporarily override this setting using the Int10h, (AH)=12h, (BL)=92h display select function.

## Select startup display device (VGA startup display)

The following configurations are possible for combination of internal VGA and external display adapter:

- 1) No external display adapter is installed
- 2) External CGA display adapter is installed
- 3) External MDA display adapter is installed

In other configurations, such as when an external VGA display adapter or EGA display adapter is installed, the internal VGA is automatically disabled.

The VGA startup display can be set to "CRT", "flat panel", or "CRT & flat panel". Bits 1, 0 of the display option byte (CMOS-RAM 40h) are used to make this selection.

CMOS-RAM 40h, bits 1 and 0	VGA startup display
00	Setting not allowed
01	CRT
10	Flat panel
11	CRT and flat panel

Note that the setting of these bits alone is not sufficient for enabling the VGA startup display. The flat panel enable bit and CRT monitor type setting described below also influence the startup display device.

## CRT monitor type

This parameter indicates whether a CRT monitor is connected to the system or not. Three values are possible: "color CRT", "monochrome CRT", and "no CRT". Auto detection using the analog resistor principle is carried out at startup, allowing the CRT monitor type to be detected automatically. This parameter can be changed using the RAK.

CRT monitor type	Meaning
00 (color)	Indicates a system where a color CRT is connected
01 (monochrome)	Indicates a system where a monochrome CRT is connected
10 (none)	Indicates a system where no CRT is connected
11 (auto)	Auto detection

The cases listed below are considered invalid and will cause an error beep (one long pulse, two short pulses). In this case, the startup display is forced to "CRT & flat panel".

- 1) Startup display is set to "CRT" or "CRT & flat panel", but CRT monitor type is set to "none".
- 2) Startup display is set to "flat panel" or "CRT & flat panel", but flat panel enable bit is set to 0 (disabled).
- 3) Display select setting at startup is "00 (not allowed), or CMOS checksum mismatch has been detected.
- 4) The VGA BIOS initializes the VGA I/O mode at startup to color or monochrome. For color mode, the RAMDAC setting is for color, the startup video mode becomes 03h, and the device byte in the BIOS work area is set to color. For monochrome mode, the startup video mode becomes 07h, and the device byte in the BIOS work area is set to monochrome.

The VGA I/O mode at startup is determined as follows.

VGA I/O mode at startup	Cause
Monochrome	<ul style="list-style-type: none"> <li>• Startup display selection is "CRT", and CRT monitor type is set to "monochrome CRT" (also as a result of auto-detect)</li> <li>• External CGA adapter was detected</li> </ul>
Color	<ul style="list-style-type: none"> <li>• Startup display selection is "CRT", and CRT monitor type is set to "color CRT" (also as a result of auto-detect)</li> <li>• Startup display selection is "CRT &amp; flat panel"</li> <li>• Invalid setting has forced selection of "CRT &amp; flat panel"</li> <li>• External MDA adapter was detected</li> </ul>

Note: In rare cases, external or internal noise may cause a detection error during CRT auto-detection.



## VGA device information preserved in suspended mode

The following VGA device information is preserved in suspended mode.

**Note:**   **Devices shown in shaded fields are not powered in suspended mode.**

### **VGA controller**

**[Register store/restore state]**

The values of all VGA controller registers are stored.

**[Condition where register, store/restore is not possible]**

None

### **VRAM**

**[Register store/restore state]**

VRAM data are stored.

**[Condition where register store/restore is not possible]**

None

### **Flat panel backlight**

**[Register store/restore state]**

The flat panel backlight state is stored.

**[Condition where register store/restore is not possible]**

None

## VGA controller state in standby/suspend condition

The VGA controller state in standby/suspend condition changes as shown below.

**Normal state**

- Flat panel power supply and full-screen refresh ON
- CPU access to VRAM ON
- VRAM refresh ON
- CPU access to RAMDAC ON
- CPU access to I/O register ON

**Standby and suspended state**

- Flat panel power supply and full-screen refresh OFF
- Transition to/return from suspended state uses panel power sequence
- CPU access to VRAM OFF
- VRAM refresh on, with clock rate reduced to 32 kHz
- CPU access to RAMDAC OFF
- PLL stopped

**APM related extended functions**

For the CPU idle function of APM (Advanced Power Management) with CARD-686 DBIOS, user can select the CPU to be stopped or operate partially. Though it can be done by using RAK (ROM Adaptation Kit), the following extended APM OEM function is prepared for this choice so that it can be changed after the system started up.

**Extended APM OEM function****Read APM CPU idle function operation setting**

INPUT \_\_\_\_\_

(AX) = 5380h

(BH) = 04h

OUTPUT \_\_\_\_\_

(CL) = APM CPU idle function operation mode byte

(CF) = 0

**Modify APM CPU idle function operation setting**

INPUT \_\_\_\_\_

(AX) = 5380h

(BH) = 05h

(BL) = APM CPU idle function operation mode byte

OUTPUT \_\_\_\_\_

(CF) = 0

APM CPU idle function operation mode byte

0 = Stop the CPU if the APM CPU idle function is called.

Except for 0 = If the APM CPU idle function is called, the CPU operates partially.

As for the effective value, from 1, to 15. The period CPU actually operates in the partial mode is looked for with the following formula.

$$\text{CPU operation period} = 1/(\text{APM CPU idle function operation mode byte} + 2)$$

For example, if the value of the "APM CPU idle function operation mode byte" is 15, the CPU operation period becomes 1/17. In this case, when an APM CPU idle function is called, the CPU operates with the whole 1/17, and stops 16/17 in average.

## **BIOS parameter table**

The CARD-686 DBIOS allows changing the values of internal BIOS parameters, in order to support a wide range of peripherals. BIOS parameter changes are made using the separately available ROM Adaptation Kit (RAK) for the respective CARD-686 DBIOS version. For various flat panel displays, pre-adjusted parameter files are available which can be installed using a tool supplied with the RAK.

For information on how to use the RAK, refer to the ROM Adaptation Kit Reference Manual.

The following pages contain a short listing of representative BIOS parameters that can be adjusted with the ROM Adaptation Kit.

## System control parameter table

Parameters which control basic operation of the system can be set. The table contains the following parameters.

- Memory test: simple/full/none
- Detect external RAM on ISA bus: yes/no
- Match CMOS-RAM memory size to actual memory size: yes/no
- Plug memory hole under 16 MB when memory size is larger than 16 MB: yes/no
- Set memory size to number below memory hole when memory hole is present: yes/no
- Check time and date value of real-time clock: yes/no
- Check time updating of real-time clock: yes/no
- Check system timer 0 interrupt: yes/no
- Adjust interrupt rate of system timer 0 interrupt
- Check keyboard controller: yes/no
- Check keyboard unit: yes/no
- Enable NumLock at system startup: yes/no
- Detect PS/2 mouse: yes/no
- Perform simple/full PS/2 mouse check
- Detect CGA display adapter: yes/no
- Detect MDA display adapter: yes/no
- Allow write to VRAM area of CGA or MDA display adapter: yes/no
- Initialize VGA: yes/no
- Check internal serial port: yes/no
- Detect serial ports on ISA bus: yes/no
- Select IRQ for COM1/COM2/COM3/COM4 (IRQ4/IRQ3/IRQ11/IRQ10)
- Check internal parallel port: yes/no
- Detect external parallel ports on ISA bus: yes/no
- Detect external floppy disk controller on ISA bus: yes/no
- Perform simple floppy disk controller check: yes/no
- Force IPC (Initial Program Loader) bit to ON: yes/no
- Detect external hard disk controller: yes/no
- Perform drive diagnose test for hard disk controller: yes/no
- Perform simple HDD check: yes/no
- Set wait time before hard disk controller initialization
- Set wait time before initialization of secondary hard disk controller on ISA bus

- Set wait time for ready check of internal hard disk controller
- Set wait time for ready check of secondary hard disk controller on ISA bus
- Select IRQ for secondary hard disk controller on ISA bus
- Beep tone before system start: yes/no
- Display error message when device error is detected: yes/no (for each device)
- Request F1 press when device error is detected: yes/no (for each device)
- Handle E0000h segment ROM in 2KB units: yes/no
- Assign boot device top priority to A: or C:
- Display system prompts and messages at startup: yes/no/set color
- Display user-defined information (max. 60 characters) at startup: yes/no/set color

### Default CMOS-RAM table

The default CMOS-RAM settings can be specified in this table. When the CMOS-RAM has been subject to a power failure such as when the battery has run down and no backup power supply was provided, the default CMOS-RAM values are copied to the CMOS-RAM at the beginning of the BIOS startup procedure. The default CMOS values are stored in the BIOS ROM and can be used in various ways, as follows:

- 1) Copy CMOS values to CMOS-RAM when a power failure has occurred
- 2) Always copy CMOS values to CMOS-RAM at system startup
- 3) Copy CMOS values to CMOS-RAM when CMOS-RAM checksum is not correct
- 4) Copy CMOS values to CMOS-RAM when date or time value is not valid
- 5) Copy CMOS values to CMOS-RAM when RTC (real-time clock) is not being updated

### Flat panel parameter table

VGA controller extended register values can be specified in this table, which serves for setup of the flat panel display at startup.

Pre-adjusted parameter files for major flat panel display models are available on the RAK disk for the respective BIOS version.

## Boot block control table

The boot block control parameters can be specified in this table. The table covers the following items:

- Test conventional memory (0-640KB): no/simple/full
- Test shadow RAM (640KB-1MB): no/simple/full
- Map BIOS ROM to FC0000h-FFFFFFh below 16MB: yes/no
- When memory test is set to "simple", bootup will be faster, but memory problems may not be detected reliably.

## ATA boot control table

The ATA boot control table comprises the following information: PCMCIA controller port address, PCMCIA controller initialization data, parameters for initializing the PCMCIA controller to allow ATA booting, HDD card initialization data, etc. A parameter table file for the PCMCIA controller and HDD card is provided on the RAK disk whose version corresponds to the version of BIOS being used.

## Appendix Technical Information

This section contains information on functions that are exclusive to the CARD-686 DBIOS and are not covered in the Epson DBIOS Basic Functions Reference Manual. For information on other functions, please refer to the Epson DBIOS Basic Functions Reference Manual.

### VGA extended CMOS area

Address	Content
40h	Display option byte
41h	Flat panel option byte
42h	Flat panel font byte
43h	Reserved
44h-47h	Reserved
48h,49h	VGA CMOS-RAM checksum (40h-47h checksum)
*4Ah-4Dh	Reserved
*4Eh	Display adapter information
*4Fh	VGA CMOS-RAM diagnosis status byte

\* These bytes are not included in the checksum because they are written to the VGA BIOS at startup.

### CMOS-RAM bit allocation

40h - Display information byte

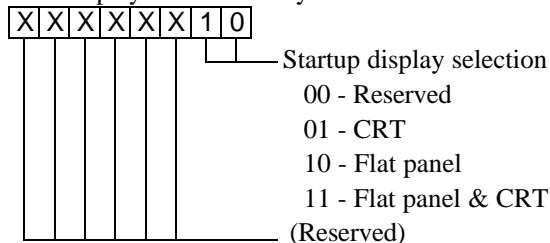

41h - Flat panel option byte

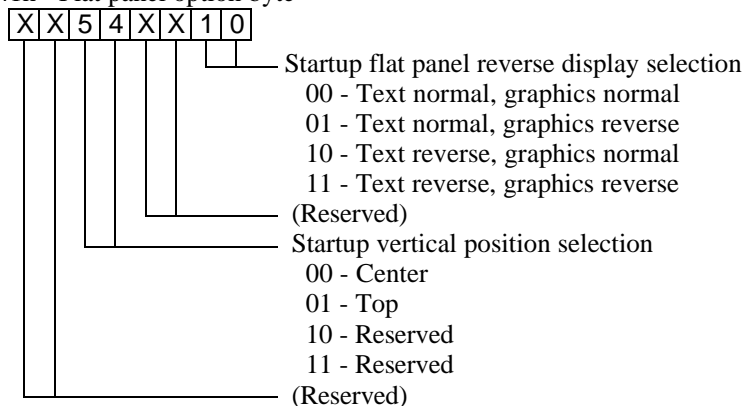

42h - Flat panel font byte

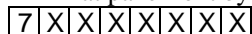

- (Reserved)
- Startup flat panel expanded mode selection
  - 0 - Expanded mode disabled
  - 1 - Expanded mode enabled

43h - 47h Reserved

48h - 49h - VGA CMOS-RAM checksum (address 40h - 47h checksum)

- 48h - Checksum upper byte
- 49h - Checksum lower byte

4Eh - Display adapter information

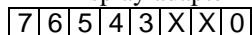

- VGA I/O mode
  - 0 - Color mode
  - 1 - Monochrome mode
 Note: Fixed to 1 when CGA is present
- (Reserved)
- VGA CRT detection
  - 0 - No VGA CRT monitor connected
  - 1 - VGA CRT monitor connected
- VGA flat panel status bit
  - 0 - No flat panel display connected
  - 1 - Flat panel display connected
 Note: This status is taken from the parameter table.
- MDA detection
  - 0 - MDA adapter not detected
  - 1 - MDA adapter detected
- CGA detection
  - 0 - CGA adapter not detected
  - 1 - CGA adapter detected
- MDA and CGA coexist status
  - 0 - MDA or CGA or none present
  - 1 - MDA and CGA present

4Fh - VGA CMOS-RAM diagnosis status byte

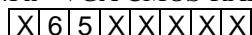

- (Reserved)
- Internal VGA controller status
  - 0 - Disabled
  - 1 - Enabled
- VGA CMOS-RAM area checksum status
  - 0 - No error
  - 1 - Checksum mismatch
- (Reserved)



## Memory map

### **CARD-686 32MB model**

<b>Address</b>	<b>Content</b>	<b>Size</b>
0000000h - 009FFFFh	Base memory	640KB
00A0000h - 00BFFFFh	VRAM area	128KB
00C0000h - 00C7FFFh	VGA BIOS	32KB
00C8000h - 00DFFFFh	Option ROM area	96KB
00E0000h - 00EFFFFh	Option ROM area	64KB
00F0000h - 00FFFFFFh	BIOS	64KB
0100000h - 1FFFFFFh	Extended memory	31744KB

### **CARD-686 64MB model**

<b>Address</b>	<b>Content</b>	<b>Size</b>
0000000h - 009FFFFh	Base memory	640KB
00A0000h - 00BFFFFh	VRAM area	128KB
00C0000h - 00C7FFFh	VGA BIOS	32KB
00C8000h - 00DFFFFh	Option ROM area	96KB
00E0000h - 00EFFFFh	Option ROM area	64KB
00F0000h - 00FFFFFFh	BIOS	64KB
0100000h - 3FFFFFFh	Extended memory	64512KB

# EPSON International Sales Operations

---

## AMERICA

### EPSON ELECTRONICS AMERICA, INC.

#### HEADQUARTERS

1960 E. Grand Avenue  
El Segundo, CA 90245, U.S.A.  
Phone : +1-310-955-5300 Fax : +1-310-955-5400

#### SALES OFFICES

##### West

150 River Oaks Parkway  
San Jose, CA 95134, U.S.A.  
Phone : +1-408-922-0200 Fax : +1-408-922-0238

##### Central

101 Virginia Street, Suite 290  
Crystal Lake, IL 60014, U.S.A.  
Phone : +1-815-455-7630 Fax : +1-815-455-7633

##### Northeast

301 Edgewater Place, Suite 120  
Wakefield, MA 01880, U.S.A.  
Phone : +1-781-246-3600 Fax : +1-781-246-5443

##### Southeast

3010 Royal Blvd. South, Suite 170  
Alpharetta, GA 30005, U.S.A.  
Phone : +1-877-EEA-0020 Fax : +1-770-777-2637

## EUROPE

### EPSON EUROPE ELECTRONICS GmbH

#### HEADQUARTERS

Riesstrasse 15  
80992 Muenchen, GERMANY  
Phone : +49- (0) 89-14005-0 Fax : +49- (0) 89-14005-110

#### - GERMANY -

##### SALES OFFICE

Altstadtstrasse 176  
51379 Leverkusen, GERMANY  
Phone : +49- (0) 217-15045-0 Fax : +49- (0) 217-15045-10

#### - UNITED KINGDOM -

##### UK BRANCH OFFICE

2.4 Doncastle House, Doncastle Road  
Bracknell, Berkshire RG12 8PE, ENGLAND  
Phone : +44- (0) 1344-381700 Fax : +44- (0) 1344-381701

#### - FRANCE -

##### FRENCH BRANCH OFFICE

1 Avenue de l' Atlantique, LP 915 Les Conquerants  
Z.A. de Courtaboeuf 2, F-91976 Les Ulis Cedex, FRANCE  
Phone : +33- (0) 1-64862350 Fax : +33- (0) 1-64862355

## ASIA

#### - CHINA -

### EPSON (CHINA)CO.,LTD.

28F, Beijing Silver Tower 2# North RD DongSanHuan  
ChaoYang District, Beijing, CHINA  
Phone : 64106655 Fax : 64107320

#### SHANGHAI BRANCH

4F, Bldg., 27, No. 69, Gui Jing Road  
Caohejing, Shanghai, CHINA  
Phone : 21-6485-5552 Fax : 21-6485-0775

#### - HONG KONG, CHINA -

### EPSON HONG KONG LTD.

20/F., Harbour Centre, 25 Harbour Road  
Wanchai, HONG KONG  
Phone : +852-2585-4600 Fax : +852-2827-4346  
Telex : 65542 EPSCO HX

#### - TAIWAN, R.O.C. -

### EPSON TAIWAN TECHNOLOGY & TRADING LTD.

10F, No. 287, Nanking East Road, Sec. 3  
Taipei, TAIWAN, R.O.C.  
Phone : 02-2717-7360 Fax : 02-2712-9164  
Telex : 24444 EPSONTB

#### HSINCHU OFFICE

13F-3, No.295, Kuang-Fu Road, Sec. 2  
HsinChu 300, TAIWAN, R.O.C.  
Phone : 03-573-9900 Fax : 03-573-9169

#### - SINGAPORE -

### EPSON SINGAPORE PTE., LTD.

No. 1 Temasek Avenue, #36-00  
Millenia Tower, SINGAPORE 039192  
Phone : +65-337-7911 Fax : +65-334-2716

#### - KOREA -

### SEIKO EPSON CORPORATION

#### KOREA OFFICE

50F, KLI 63 Bldg., 60 Yoido-Dong  
Youngdeungpo-Ku, Seoul, 150-010, KOREA  
Phone : 02-784-6027 Fax : 02-767-3677

#### - JAPAN -

### SEIKO EPSON CORPORATION

#### ELECTRONIC DEVICES MARKETING DIVISION

##### Electronic Device Marketing Department

##### Card Products & Marketing Group

421-8, Hino, Hino-shi, Tokyo 191-8501, JAPAN  
Phone: +81-(0)42-587-7503 Fax: +81-(0)42-587-8423

##### ED International Marketing Department I

##### (Europe & U.S.A.)

421-8, Hino, Hino-shi, Tokyo 191-8501, JAPAN  
Phone: +81-(0)42-587-5812 Fax: +81-(0)42-587-5564

##### ED International Marketing Department II (Asia)

421-8, Hino, Hino-shi, Tokyo 191-8501, JAPAN  
Phone: +81-(0)42-587-5814 Fax: +81-(0)42-587-5110



In pursuit of "Saving" Technology, Epson electronic devices. Our lineup of semiconductors, liquid crystal displays and quartz devices assists in creating the products of our customers' dreams. Epson IS energy savings.



**CARD-686**  
DBIOS Manual  
(Extended Functions)

**SEIKO EPSON CORPORATION**  
**ELECTRONIC DEVICES MARKETING DIVISION**

Electronic Devices Information on Epson WWW server

<http://www.epson.co.jp/device/>

First issue February, 1999  
Printed in Japan © A