

EPSON

Color Digital Camera

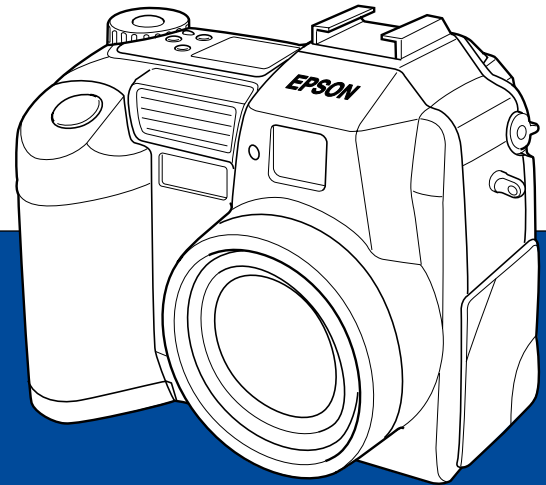

PhotoPC
3100Z

User's Guide

Where to Find Information

This User's Guide

Provides detailed information to help you set up and use your EPSON PhotoPC 3100Z and the optional products available from EPSON. Also contains information on troubleshooting, and instructions on installing the software included on the EPSON PhotoPC 3100Z Software CD-ROM included with your PhotoPC 3100Z.

Online EPSON Digital Camera Software User's Guide

Included in the EPSON PhotoPC 3100Z Software CD-ROM, this guide provides information on installing and using the EPSON Photo!4 software, which allows you to download photos from your camera to your computer and to manage your photos. Includes instructions for the other software utilities included on the software CD-ROM, such as EPSON AutoDownloader which helps you download files in a quick and organized way, and EPSON File Converter, which prepares photos to be uploaded to your camera. Also includes information on contacting customer support.

Online EPSON PhotoQuicker Reference Guide

Provides information on using the EPSON PhotoQuicker software to print your photos. This guide is installed on your computer when you install the EPSON PhotoQuicker software.

Online Help

Provides detailed information and instructions for using EPSON Photo!4 and EPSON Auto Downloader. Online help is automatically installed when you install EPSON Photo!4. See the online *EPSON Digital Camera Software User's Guide* for details on accessing online help.

EPSON®

PhotoPC™
3100Z

COLOR DIGITAL CAMERA



Printed on Recycled Paper.

User's Guide

IMPORTANT NOTICE

All rights reserved. No part of this publication may be reproduced, stored in a retrieval system, or transmitted in any form or by any means, electronic, mechanical, photocopying, recording, or otherwise, without the prior written permission of SEIKO EPSON CORPORATION. No patent liability is assumed with respect to the use of the information contained herein. Neither is any liability assumed for damages resulting from the use of the information contained herein.

Neither SEIKO EPSON CORPORATION nor its affiliates shall be liable to the purchaser of this product or third parties for damages, losses, costs, or expenses incurred by the purchaser or third parties as a result of: accident, misuse, or abuse of this product or unauthorized modifications, repairs, or alterations to this product, or (excluding the U.S.) failure to strictly comply with SEIKO EPSON CORPORATION's operating and maintenance instructions.

SEIKO EPSON CORPORATION shall not be liable against any damages or problems arising from the use of any options or any consumable products other than those designated as Original EPSON Products or EPSON Approved Products by SEIKO EPSON CORPORATION.

EPSON is a registered trademark of SEIKO EPSON CORPORATION. PhotoPC is a trademark of SEIKO EPSON CORPORATION. Macintosh is a registered trademark of Apple Computer, Inc. Microsoft and Windows are registered trademarks of Microsoft Corporation. CompactFlash is a trademark of SanDisk Corporation and has been licensed to CFA (CompactFlash Association).

General Notice: Other product names used herein are for identification purposes only and may be trademarks of their respective owners. EPSON disclaims any and all rights in those marks.

Copyright © 2001 by SEIKO EPSON CORPORATION, Nagano, Japan.

This product conforms to the following Directive(s) and Norm(s):

Directive 89/336/EEC:

EN 55022 Class B

EN 55024

A NOTE CONCERNING RESPONSIBLE USE OF COPYRIGHTED MATERIALS

Like photocopiers, digital cameras can be misused by improperly photographing copyrighted material. Unless acting on the advice of a knowledgeable attorney, be responsible and respectful by obtaining the permission of the copyright holder before photographing published material.

Contents

Introduction

PhotoPC 3100Z Features	1
Options.	2
For United Kingdom users - use of options	3
Safety Instructions	4
When using the camera	4
When using the strap.	5
When using the batteries.	5
Safety information for United Kingdom users.	7
Warnings, Cautions, and Notes	7

Chapter 1 Getting Started

Unpacking Your PhotoPC 3100Z.	1-2
Camera Parts.	1-2
Using the Batteries	1-5
Installing the batteries	1-5
Replacing the batteries.	1-6
Cleaning the batteries	1-7
Storing the batteries	1-8
Disposing of the batteries	1-9
Setting Up Your Camera	1-9

Attaching the strap to your camera	1-9
Attaching the lens cap to your camera.	1-10
Installing and removing a CompactFlash Card	1-11
Turning on your camera for the first time.	1-12

Chapter 2 Taking Pictures

Getting Ready	2-1
Your camera's picture-taking and flash range.	2-2
Turning the camera on and off	2-2
Using the display panel	2-3
Using the dial switch	2-4
Making basic settings	2-5
Using the LCD monitor buttons	2-5
Taking Pictures Using the Viewfinder.	2-6
Using the optical zoom feature	2-7
Using the self timer.	2-8
Taking Pictures Using the LCD monitor	2-9
Using the basic playback feature	2-10
Using the digital zoom	2-12
Using the macro setting to take close-ups.	2-13

Taking Multiple Exposures	2-13
Recording video clips	2-13
Using the continuous shooting feature.	2-15
Using the time lapse feature.	2-15
Using the stitch assist feature.	2-17
Making Audio Recordings for Photos	2-19
Recording audio immediately after taking photos	2-20
Recording audio for existing photos.	2-21
Audio playback using the built-in speaker	2-21

Chapter 3 *Playing Back and Managing Images With Your Camera*

Viewing Images Using the LCD Monitor.	3-1
Displaying one, four, or nine photos at once. . .	3-1
Magnifying photos.	3-2
Viewing a slide show of your photos	3-3
Viewing photo information	3-4
Selecting a folder in the CompactFlash Card. . .	3-5
Playing back video clips	3-5
Managing Images with the LCD Monitor	3-6
Locking and unlocking photos	3-6
Erasing images	3-7
Erasing audio recordings	3-7
Erasing video clips.	3-8
Viewing Pictures on a Television	3-9
Viewing Pictures with an EPSON Projector	3-10

Chapter 4 *Making Settings*

Making Image Capture Settings.	4-1
Adjusting the image quality	4-1
Setting the flash.	4-4
Making camera mode settings	4-6
Changing the color/monochrome setting.	4-7
Making manual focus settings	4-8
Adjusting the sensitivity setting	4-8
Adjusting the white balance setting.	4-9
Making exposure settings	4-11
Changing the metering system.	4-16
Selecting slow synchro timing	4-17
Selecting the internal or external flash.	4-18
Making Camera Settings	4-19
Setting the time and date	4-19
Using the automatic shut-off feature	4-20
Setting the LCD monitor's brightness level	4-20
Adjusting the speaker volume	4-21
Setting the beep and shutter sound	4-21
Selecting the signal system and language.	4-21
Making Print Settings.	4-22
Selecting images and specifying the number of prints	4-23
Making settings to print an index	4-24
Making print quality settings	4-24

Chapter 5 Using Images on Your Computer

System Requirements	5-1
For Windows	5-1
For Macintosh	5-2
The Included Software	5-2
Installing the Software for Windows Users	5-3
Installing the Software for Macintosh Users	5-5
Installing EPSON Photo!4 and other software	5-5
Installing QuickTime 4	5-6
Installing Acrobat Reader	5-7
Setting Up EPSON CameraStarter	5-7
Connecting and Disconnecting the Camera	5-8
Connecting the camera to your computer	5-9
Disconnecting the camera from your computer	5-10
Transferring Images to Your Computer	5-12
Using EPSON digital camera software	5-12
Copying files directly from the memory card	5-13
Viewing the Software User's Guides on Your Computer	5-14
Accessing the EPSON Digital Camera Software User's Guide	5-14
Accessing the EPSON PhotoQuicker User's Guide	5-15

Chapter 6 Camera Options and Accessories

Using Memory Cards	6-1
Inserting a memory card into your computer	6-2
Formatting memory cards	6-3
Using Rechargeable Batteries	6-4
Using the AC Adapter	6-5
Using the Lens Adapter	6-6





Chapter 7 Maintenance and Troubleshooting

Maintenance	7-1
Handling the camera	7-1
Cleaning the camera	7-2
Storing the camera	7-2
Problems and Solutions	7-2
Camera problems	7-2
Picture problems	7-7

Appendix A Specifications

Camera.	A-1
Physical dimensions	A-1
Product type	A-1
Recorded image	A-2
Optical	A-3
Functional	A-4
Interface.	A-4
Power.	A-4
CompactFlash Card	A-5
Optional PCMCIA Adapter	A-6
Optional AC Adapter	A-6

Appendix B Dial Position Settings

Available Settings in the  Dial Position.	B-2
Available Settings in the  Dial Position.	B-3
Available Settings in the  Dial Position.	B-4
Available Settings in the  Dial Position	B-5
When using the Program camera mode.	B-5
When using the Manual camera mode.	B-5
Available Settings in the  Dial Position	B-6
When using the Program camera mode.	B-6
When using the Manual camera mode.	B-6

Glossary

Index

Introduction

Your EPSON® PhotoPC™ 3100Z is a revolutionary, easy-to-use digital camera that enables you to take full-color pictures that you can edit, manipulate, and print using your computer. Create professional letters, documents, and presentations from your desktop using stunning, lifelike images. Share photos with business colleagues or friends over the Internet. Add color and visual appeal to your newsletters, flyers, and brochures. Improve the look of any document using images taken with your PhotoPC 3100Z.

The PhotoPC 3100Z comes with everything you need to get started, including EPSON Photo!4 software that lets you transfer photos from the camera to your computer's hard disk. You can then edit, enhance, or organize your photos, or insert them into your documents. For instructions on using and installing EPSON Photo!4, see the online *EPSON Digital Camera Software User's Guide*.

PhotoPC 3100Z Features

The PhotoPC 3100Z has the following features.

- ❑ 3.3 megapixel CCD
- ❑ 24-bit color image capture
- ❑ High resolution, up to 2544 × 1904 pixels (equivalent to 4.8 megapixels) using HyPict
- ❑ PRINT Image Matching support, which allows you to achieve enhanced results when printing your photos with a printer that supports the PRINT Image Matching system
- ❑ Built-in color LCD monitor for previewing and playing back pictures
- ❑ Built-in microphone and speaker for audio recording and playback
- ❑ Macro photo format
- ❑ Optical ×3 and seamless digital ×2 zoom

- ❑ Continuous shooting of up to 47 pictures (approximately)
- ❑ Automatic, predefined, or manual white balance adjustment
- ❑ Automatic, predefined and adjustable exposure settings (-2.0 to + 2.0 EV, in increments of 0.5 or 0.2)
- ❑ Automatic date and time recording for each picture
- ❑ Built-in flash with automatic flash, forced flash, flash off, red-eye reduction, and leading or trailing slow synchro flash (for taking pictures at night or in dark places) options
- ❑ Built-in hot sync flash shoe for an external flash (sold separately), which can be used for photo shooting in the Manual camera mode. (For information on external flashes, contact your EPSON dealer.)
- ❑ Self-timer (ten second delay)
- ❑ Automatic shut-off to save battery power
- ❑ EPSON Photo!4 software to manage and transfer photos to your computer
- ❑ EPSON File Converter software to convert images and audio recordings stored on your computer to EPSON Photo file format for uploading to your camera
- ❑ Other EPSON software to help you organize your downloads, stitch together photos to create panoramas, and print your photos
- ❑ DPOF file format support, which lets you specify in advance which photos to print and how many prints of each photo to make
- ❑ File formats compatible with both Windows® and Macintosh® applications

Options

The following options are available from EPSON for the PhotoPC 3100Z.

- ❑ CompactFlash™ Card
(for information, contact your EPSON dealer)
- ❑ PCMCIA adapter (B867041)

- ❑ AC Adapter (B867081, B867091, B867101, B867111, B867121, B867131, B867141, B867151, B867161, B867171) for use with a standard electrical outlet
- ❑ Power Pack (B81817*, B818181, B818182) which includes:

Ni-MH Battery Charger
Four Ni-MH Rechargeable Batteries

- ❑ Package of four Ni-MH Rechargeable Batteries (B81811*)

Note:

- ❑ *The asterisk acts as a substitute for the last digit of the product number, which varies by country.*
- ❑ *The PhotoPC 3100Z comes with a 16 MB CompactFlash Card. For details on using this option, see "Using Memory Cards" on page 6-1.*
- ❑ *The AC Adapter model EU-40 and Battery Charger model EU-38 conform to CE marking requirements in accordance with EC Directives 73/23/EEC and 89/336/EEC.*

For United Kingdom users - use of options

EPSON (UK) LTD shall not be liable against any damages or problems arising from the use of any options or consumable products other than those designated as Original EPSON Products or EPSON Approved Products by EPSON (UK) LTD.

Safety Instructions

Read all of these instructions before using the camera, and keep them handy for later reference. Follow all warnings and instructions marked on the camera and options.

When using the camera

Note the following when using the camera.

- ❑ To reduce the risk of electric shock, do not remove the cover of the camera or options. Do not open any compartments except as instructed in this *User's Guide*.
- ❑ Do not insert objects into any openings.
- ❑ To prevent fire or electric shock, do not expose the camera or options to rain or moisture.
- ❑ To prevent fire or electric shock, do not cover the camera with a blanket or other covering that may give off an electric charge.
- ❑ To prevent fire or explosion, do not use the camera where flammable or volatile gas is stored.

- ❑ Do not use the camera outdoors during a thunderstorm.
- ❑ If the camera or option emits unusual noises, odors, or smoke, cancel the current operation and turn the device off immediately. Remove the batteries and/or disconnect the AC adapter from the camera, then unplug the AC adapter from the electrical outlet. Then contact your EPSON dealer.
- ❑ To prevent possible injury, do not take flash pictures in close proximity to anyone's eyes.
- ❑ Only use the type of power source specified in this *User's Guide*.
- ❑ Do not use damaged or frayed power cords.
- ❑ Remove the batteries and/or plug from the camera and refer servicing to qualified service personnel in the following circumstances:

The power cord or plug is damaged; liquid has entered the camera or options; the camera or options have been dropped or the case is damaged; the camera or options do not operate normally or exhibit a distinct change in performance.

- ❑ Never adjust controls that are not mentioned in the operating instructions.
- ❑ Do not touch your camera's flash with your fingers, or any other object, or allow the flash to become dirty. Using the camera under any of these conditions can damage the flash.

If you accidentally touch the flash, or if it becomes dirty, be sure to clean it with a soft, dry cloth before using the camera.

- ❑ If you plan to use the camera and options in Germany, observe the following:

To provide adequate short-circuit protection and over-current protection for these products, the building installation must be protected by a 10 or 16 Amp circuit breaker.

Bei Anschluss des Produkts an die Stromversorgung muss sichergestellt werden, dass die Gebäudeinstallation mit einem 10 A- oder 16 A-Sicherung abgesichert ist.

- ❑ If the liquid crystal solution contained in the display panel or in the LCD monitor leaks out and gets on your hands, wash them thoroughly with soap and water. If it gets into your eyes, flush them immediately with water.

When using the strap

Note the following when using the camera strap.

- ❑ Do not swing the camera about. This can damage the camera or other objects, or cause injury.
- ❑ Do not pull or tighten the strap too much when wearing it; this can cause serious injury.
- ❑ Keep the strap away from children.

When using the batteries

Note the following when using and batteries.

- ❑ Read all relevant safety and operating instructions before using the batteries.
- ❑ Do not use manganese batteries (IEC R6).
- ❑ Do not charge primary (non-rechargeable) batteries.
- ❑ To avoid fire or electric shock, do not use batteries that are leaking or damaged in any way.
- ❑ Only use EPSON Ni-MH batteries according to the directions in this manual.

- ❑ Be aware of electrical shock hazard.
- ❑ Do not handle the batteries with wet hands or use them near water.
- ❑ Do not expose the batteries to water or high humidity.
- ❑ Keep batteries away from heat sources.
- ❑ Do not drop, puncture, disassemble, mutilate, or short-circuit batteries. Do not place the batteries near to or into fire or water.
- ❑ To protect against short-circuiting, do not remove the outside sleeves of the batteries.
- ❑ Do not insert objects into any openings as they may touch dangerous voltage points or short-circuit components.
- ❑ Prevent the batteries from coming into contact with metal objects which could short-circuit the batteries, such as coins or keys.
- ❑ Do not insert batteries into wall outlets or other power sources such as car cigarette lighter sockets.
- ❑ Do not solder lead wires or terminals directly to a battery.
- ❑ If battery acid gets into your eyes or on your skin, immediately rinse the affected area thoroughly with water and seek medical treatment. If a battery is swallowed, seek medical treatment immediately.

Safety information for United Kingdom users



Warning: This appliance must be earthed. Refer to the rating plate for voltage and check that the appliance voltage corresponds to the supply voltage.

Important: The wires in the mains lead fitted to this appliance are coloured in accordance with the following code:

Blue — Neutral

Brown — Live

As the colours of the wires in the mains lead of this appliance may not correspond with the coloured markings identifying the terminals in your plug, proceed as follows:

The blue wire must be connected to the terminal in the plug marked with the letter N.

The brown wire must be connected to the terminal in the plug marked with the letter L.

If damage occurs to the plug, replace the cord set or consult a qualified electrician.

Replace fuses only with a fuse of the correct size and rating.

Warnings, Cautions, and Notes



Warnings must be followed carefully to avoid bodily injury.



Cautions must be observed to avoid damage to your equipment.

Notes contain important information and useful tips for the operation of your camera and options.

This chapter helps you to set up your PhotoPC 3100Z and covers the following topics:

- ❑ Unpacking your PhotoPC 3100Z
- ❑ Getting familiar with the camera parts
- ❑ Installing and replacing batteries
- ❑ Attaching the camera strap and lens cap
- ❑ Installing the CompactFlash Card
- ❑ Setting the language, date, and time for your camera

Unpacking Your PhotoPC 3100Z

Make sure that your camera box contains all of the items shown below.



camera
(with lens cap
attached)



lens adapter



lens cap string



strap

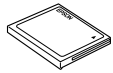

16 MB CompactFlash Card
(installed in the camera)

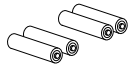

alkaline batteries (4)



USB cable

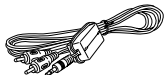

AV cable

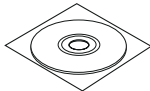

CD-ROM and/or floppy disks
(media type and quantity
vary by location)



camera case

Camera Parts

After unpacking your PhotoPC 3100Z, take a few minutes to learn about the components shown below.

Front view

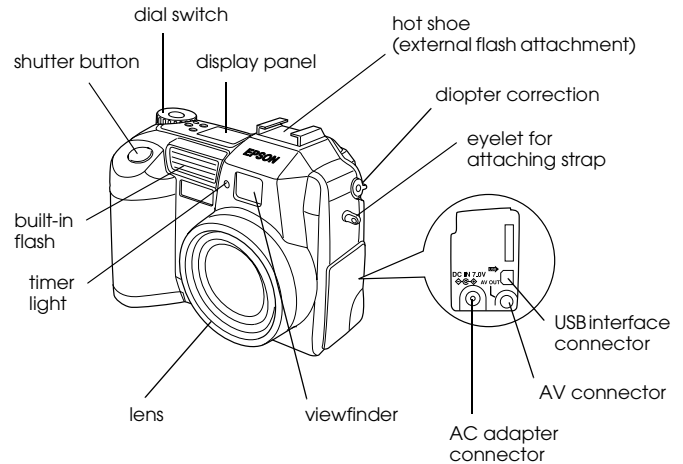

Back view

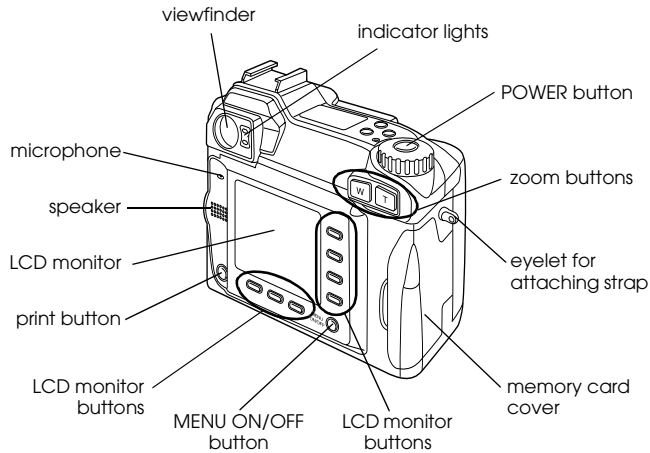

Note:

In this User's Guide, the LCD monitor buttons are named after the corresponding indicators on the LCD monitor, which vary depending upon the dial switch position and the screen displayed.



Warning:

The speaker uses a magnet. Keep important magnetic objects, such as credit cards and floppy disks, away from the speaker. EPSON shall not be held liable for any damages or lost information.

Bottom view

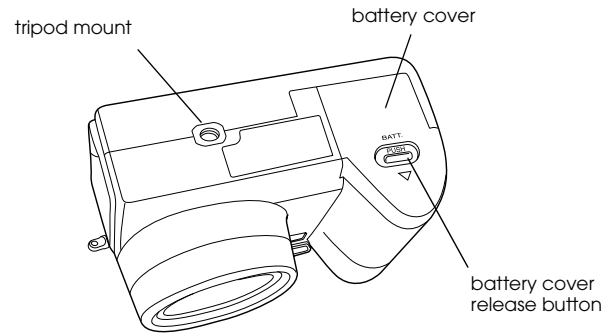

Top view

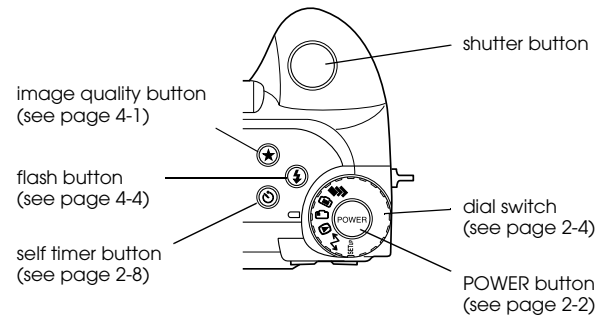

Display panel

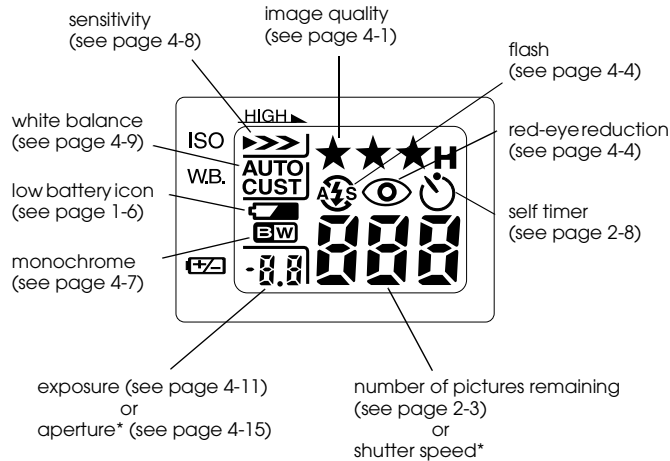

* The shutter speed is displayed when the shutter button is depressed halfway and the camera is in Program or Manual mode.

Indicator lights

The camera has one red and one green indicator light beside the viewfinder. They turn on or blink to guide you through the picture-taking process, or to indicate the camera status. See the following chart for details.

Light	Indication
Green (On)	Camera is warmed up and ready for shooting. Auto focus is locked (when shutter button is depressed halfway). Camera is taking picture using self timer.
Green (Blinking)	Camera is warming up (immediately after camera is turned on). Camera is auto focussing (when shutter button is depressed halfway). Camera is taking a video clip. Memory card is not installed. Lens cap is on. Camera is establishing a connection with the computer. Files are being transferred to and from the memory card.
Red (Blinking)	Insufficient space in memory card to take a picture or video clip. Low battery power.
Red (On)	Error. Contact your EPSON dealer for servicing.

Using the Batteries

Your PhotoPC 3100Z comes with four AA (IEC LR6) alkaline batteries. See the following sections for details on installing, replacing, cleaning, storing, and disposing of the batteries.



Caution:

Do not use manganese batteries (IEC R6).

Note:

- ❑ *Do not leave batteries in the camera for a long time without using them. See “Storing the batteries” on page 1-9 for storage instructions.*
- ❑ *You can also use the optional Ni-MH rechargeable batteries (Model EU-24). For more information on rechargeable batteries, see “Using Rechargeable Batteries” on page 6-4.*

Installing the batteries

Before installing the batteries, be sure to read the safety instructions outlined in “When using the batteries” on page 5.

Make sure that the camera is off, and follow the steps below to install or replace the batteries.

1. Turn the camera upside down with the lens facing you. Hold down the battery cover release button and slide the battery cover as shown below.

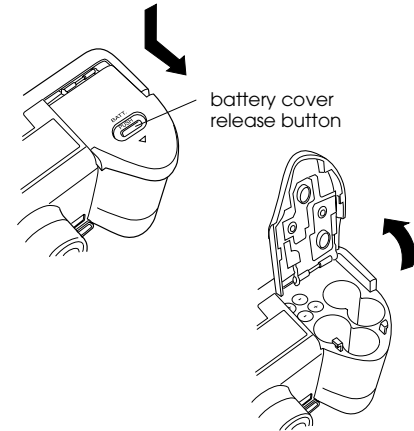

2. Insert four batteries into the compartment, positioning the ⊕ and ⊖ ends as shown below. Then lower the battery cover.

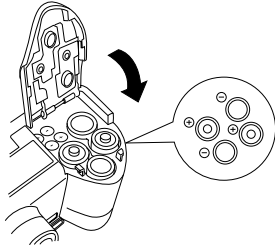

Warning:

Do not use different types of batteries together; this can cause fire or explosion.

3. Swing the battery cover shut and hold it down while you slide it back to lock it, as shown below.

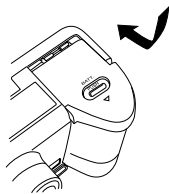

When the battery power is almost out, a low battery icon  appears on the display panel. When the battery power runs out, this icon blinks and the camera turns off automatically. Remove the old batteries, then insert new ones.

Note:

When the battery level is low, the LCD monitor turns off while the flash is being charged. When the charging is complete, the LCD monitor turns back on.

Replacing the batteries

Replace your PhotoPC 3100Z batteries when the low battery icon  appears on the camera's display panel. Be sure to replace all four batteries at the same time. You can replace them with either of the following battery types.

Single-use AA (IEC LR6) alkaline batteries

Rechargeable AA Ni-MH batteries

When the low battery icon  appears, the buttons listed below are unavailable.

When playing back photos and audio recordings:

Delete
SOUND
VIDEO CLIP

When making settings:

 (language and signal system selection)
Memory SETUP
MEMORY CARD FORMAT

Note:

- ❑ *Battery life varies depending on the battery type and the manufacturer.*
- ❑ *If you use rechargeable Ni-MH batteries in the PhotoPC 3100Z, make sure that all four batteries are fully charged when you replace them. If you find that your batteries run out soon after recharging them a number of times, make sure that you discharge them completely before recharging.*
- ❑ *Ni-MH rechargeable batteries with a battery charger are available for purchase from EPSON.*

Cleaning the batteries

Follow the instructions in this section when cleaning the batteries.

Dirty contact points (⊕ and ⊖) on the batteries and inside the battery cover can obstruct the flow of electricity in your camera. This can cause the low battery icon  to flash and your camera to turn off automatically, even if there is still power remaining in your batteries.

To prevent this kind of power loss, keep the contact points (⊕ and ⊖) on the batteries and inside the battery cover clean. When necessary, wipe them with a soft, dry cloth.

If you are using a battery charger, clean the terminals of the battery charger with a soft, dry cloth before use to ensure that your batteries charge fully.



Caution:

- ❑ *Do not use detergents or chemical solvents such as thinner, benzine, or alcohol-based solutions to clean your camera, batteries, or battery charger. Doing so can damage your equipment.*
- ❑ *Never attempt to clean the inside of the battery compartment of your camera. Doing so can damage your camera.*

Keep the battery ends clean by wiping them with a dry cloth.



Warning:

- ❑ *Do not apply heat or force to batteries, and do not disassemble, drop, short-circuit, or put batteries into contact with fire or water.*
- ❑ *Do not carry batteries loose in your pockets.*
- ❑ *Do not use different types of batteries together; this can cause fire or an explosion.*
- ❑ *Always use batteries from the same package as a set. Do not mix old and new batteries.*

Storing the batteries

If you do not plan to use the camera for a long period of time, remove the batteries and store them in a dry location at a low temperature.



Warning:

- ❑ *Do not store batteries together with metal objects, which could short-circuit the batteries.*
- ❑ *Avoid storing batteries in extremely hot or humid locations.*
- ❑ *Store batteries out of reach of children.*
- ❑ *Always remove the batteries from the camera and charger before storing. Batteries left in your camera and charger for a long time may leak and cause damage.*

Disposing of the batteries

Before disposing of batteries, make sure you discharge them completely.



Warning:

- ❑ Be sure to securely cover the + end of each battery with tape when disposing of them to prevent combustion or an explosion.
- ❑ Dispose of used batteries according to the manufacturer's instructions and in compliance with all applicable laws. Contact your local government agency for information about battery recycling and disposal.

For users in The Netherlands:

Do not dispose of the batteries as ordinary refuse. Instead, dispose of them as small chemical waste in accordance with local laws and the following Dutch Government Gazette 45, KCA Marking:



Bij dit produkt zijn batterijen geleverd. Wanneer deze leeg zijn, moet u ze niet weggooien maar inleveren als KCA.

For users in Germany:

Do not dispose of batteries as ordinary refuse. Instead, dispose of them in a recycle box in accordance with local laws.

Setting Up Your Camera

This section explains how to attach the lens cap and strap to your camera, install a memory card, and make a few basic camera settings.

Attaching the strap to your camera

Before attaching the strap, be sure to read the safety instructions outlined in “When using the strap” on page 5.

To attach the strap, follow these steps.

1. Unscrew the screw sleeve on the triangular fastener at the end of the strap. Then attach the fastener to the camera by passing it through an eyelet on one side of the camera as shown below.

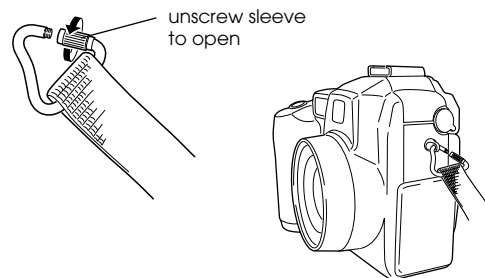

2. Tighten the screw sleeve on the fastener as shown below to close it.

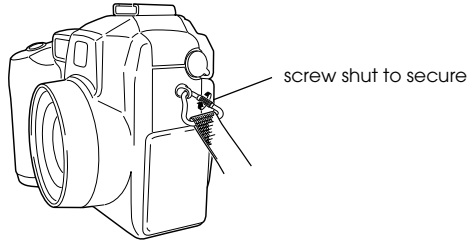

3. After securely closing the fastener, turn it so that the screw sleeve is covered by the strap, as shown below.

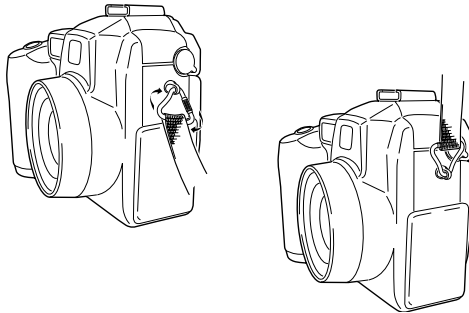

4. Repeat steps 1 through 3 to attach the other end of the strap to the other side of the camera.

Attaching the lens cap to your camera

After you have attached the camera strap, you can attach the lens cap to your camera using the lens caps string. To attach the string to the lens cap and then to the camera, follow these steps.

1. Pass the end of the string with the smaller loop through the eyelet on the edge of the lens cap, then pass the other end of the string through the smaller loop and pull it tight as shown below.

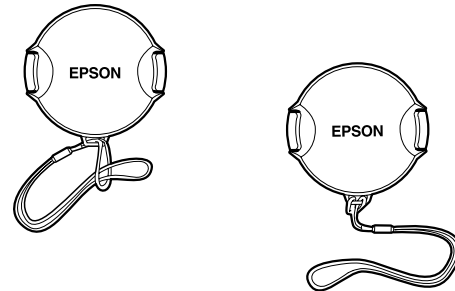

2. Pass the end of the string with the larger loop through the camera strap's triangular fastener as shown below.

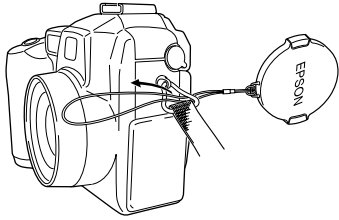

3. Then gently pull the lens cap through the string's larger loop until the string is securely attached to the camera.

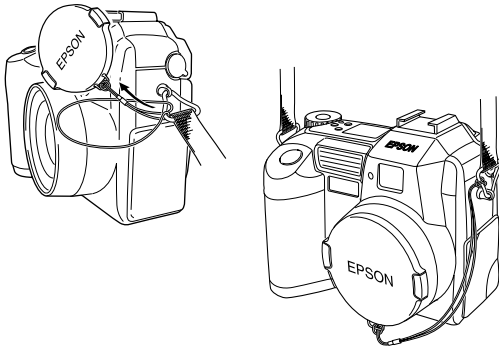

Installing and removing a CompactFlash Card

1

You cannot take photos unless a CompactFlash Card is installed in your camera.

Your camera comes with the memory card already installed. If you need to install or remove the memory card, follow these steps.

1. Make sure the camera is off.
2. Open the memory card cover.

To install the card, make sure that the front of the card and the front of the camera are facing the same direction, then insert the card all the way into the memory card slot.

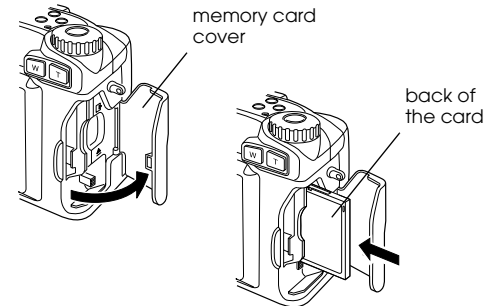

To remove the card, push in the eject button below the memory card slot. Then, remove the card and close the cover.

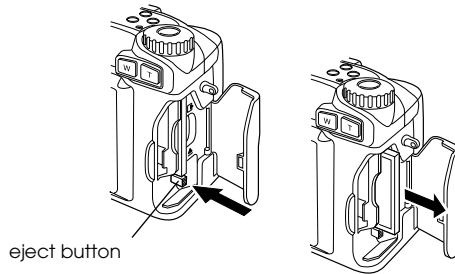

Caution:

- ❑ *Never remove the memory card while the camera is on. Data in the card may be lost or damaged.*
- ❑ *Avoid using or storing the card in direct sunlight, or in places that are extremely hot, humid, or dusty.*

Turning on your camera for the first time

The first time you turn on your camera, you must select the default language for messages displayed on the LCD monitor and set the date and time before you can use the camera to take pictures. See the sections below.

Setting the language

Follow these steps to specify the language the first time you turn on the camera. Depending on the country of purchase, you can choose from English, Japanese, French, German, Italian, Portuguese, Spanish, or Chinese.

1. Turn the camera's dial switch to **SETUP** and press the **POWER** button to turn on the camera. A message appears on the LCD monitor instructing you to set the language.
2. Press the arrow icon buttons to select the appropriate language.
3. Press the **BACK** button to save your selection.

If you need to change the language setting, see "Selecting the signal system and language" on page 4-21.

Setting the date and time

The first time you turn on the camera, after setting the language you must set the date (month, day, and year) and time (hours and minutes). Once these settings are made, the camera automatically records the date and time that each image is taken.

Follow the steps below to set the clock using the LCD monitor.

1. After you finish making the language settings in the previous section, a screen appears with the month setting highlighted in red.

To change the order of the date display, press the top button on the right side of the LCD monitor. You can make the following settings: M.D.Y (for month/day/year); D.M.Y (for day/month/year); and Y.M.D (for year/month/day).

2. To adjust the value of the highlighted item, use the up and down arrow icon buttons.

To change which item is highlighted, use the right and left arrow icon buttons.

3. After setting the correct time and date, save the settings by pressing the BACK button.

You are now ready to take pictures using your PhotoPC 3100Z. Proceed to Chapter 2, "Taking Pictures," for simple, step-by-step instructions.

If you need to change the date and time settings, see "Setting the time and date" on page 4-19.

After taking photos, you can transfer the images to your computer using EPSON Photo!4 and EPSON AutoDownloader. See Chapter 5, "Using Images on Your Computer."

Using the PhotoPC 3100Z to take pictures is similar to using a traditional “point and shoot” camera. This chapter explains the procedures for taking photos with the camera and covers the following topics.

- ❑ Determining the picture-taking range
- ❑ Checking the display panel
- ❑ Making basic settings
- ❑ Taking different kinds of pictures, including still pictures and video clips
- ❑ Making audio recordings

Getting Ready

This section prepares you to take pictures with your PhotoPC 3100Z. It includes information on your camera’s picture-taking range and explains how to make image quality and flash control settings, and how to use the self timer.

Note:

EPSON is not responsible for any images you may lose while using our products and software. Make sure that your camera is working normally before taking important pictures.

Your camera's picture-taking and flash range

The camera should be held at least 50 centimeters away from the subject when composing a shot through the viewfinder, unless you are using the macro setting.

When using the macro setting, close-up photos can be taken when the camera is 6 to 50 centimeters away from the subject. For instructions on using this feature, see “Using the macro setting to take close-ups” on page 2-13.

The flash has the following effective ranges, depending upon the optical zoom ratio and whether or not the macro setting is used.

Wide (minimum zoom): 50 - 420 centimeters

Tele (maximum zoom): 50 - 340 centimeters

Macro: 20 - 50 centimeters

The effective flash range varies, depending on the sensitivity setting. See page A-3 for more details.

Turning the camera on and off

Before turning the camera on, be sure to remove the lens cap from the camera. Use the POWER button in the center of the camera's dial switch to turn the camera on and off.

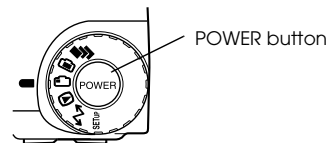

If the dial switch is set to a red icon, the lens extends from the camera when you turn on the camera. The lens retracts when you turn the camera off.

Note:

- ❑ *If the dial switch is not positioned to an icon when you press the POWER button, the power will not turn on. Be sure the dial is set to an icon before you press the POWER button.*
- ❑ *If the camera's shut-off feature turns the camera off while the lens is protruding, the lens does not retract. To retract the lens, press the POWER button once to turn the camera on, and again to turn it back off.*

Using the display panel

The large number in the lower right corner of the display panel shows the approximate number of remaining pictures that you can take.

This number is affected by the image quality setting. When you adjust the image quality, the number of remaining pictures is altered accordingly.

When you take photos, the number of remaining photos and the total number of photos that you can save in the memory card are displayed on the LCD monitor. When you play back photos, the LCD monitor displays the number of the photo that you are viewing and the total number of photos that you have taken.

Note:

- ❑ *If there are any audio recordings stored on your memory card, the number shown on the display panel may be greater than the actual number of remaining photos.*
- ❑ *The number of remaining photos displayed does not include video clips.*

When the memory card is full, the number on the display panel reads 0 (zero), the red indicator light on the back of the camera blinks, and the shutter button does not work. Before you can take any more pictures, you must erase some or all of the images in the memory card. See “Erasing images” on page 3-7 for instructions. If you want to save your photos before erasing them, transfer them to your computer using the EPSON Photo!4 or EPSON Auto Downloader software with the PhotoPC 3100Z connected to your computer, or insert the memory card into a PC Card slot of a different device.

When in the Program and Manual camera modes, the exposure value appears at the left side of the display panel and the shutter speed appears at the right when you depress the shutter button halfway.

When the camera’s dial switch is set to **SETUP**, **SET** is shown on the display panel.

While making an audio recording, **REC** is shown on the display panel.

When taking photos using the time lapse feature, **Int** is shown on the display panel.

Using the dial switch

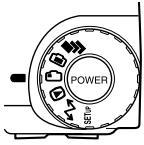

The camera's dial switch has six different positions which determine how the camera works. This section gives an overview of each dial position.

Dial positions for taking pictures

When you want to take pictures, turn the dial switch so that one of the red icons on the top of the dial is selected. The three red dial positions are described below.



For taking multiple exposures, including video clips. See "Taking Multiple Exposures" on page 2-13 for details.



For using the LCD monitor to take pictures and make audio recordings. See "Taking Pictures Using the LCD monitor" on page 2-9 for details.



For using the viewfinder to take pictures. See "Taking Pictures Using the Viewfinder" on page 2-6 for details.

Other dial positions

To perform other camera operations, turn the dial switch so that one of the following icons is selected.



For playing back and managing photos, audio recordings, and video clips. See Chapter 3, "Playing Back and Managing Images With Your Camera," for details.



For connecting the camera to your computer, and making print settings. See "Connecting the camera to your computer" on page 5-9 and "Making Print Settings" on page 4-22 for details.



For viewing information and setting up the camera. See Chapter 4, "Making Settings," for details.

Making basic settings

The three small buttons on the top of the camera allow you to easily make some basic settings. You can use these buttons when the dial switch is set to one of the red icons. The buttons are described below.

- ★ Changes the image quality setting. See “Adjusting the image quality” on page 4-1 for details.
- ⚡ Changes the flash setting. See “Setting the flash” on page 4-4 for details.
- ⌚ Turns the self timer on and off. See “Using the self timer” on page 2-8 for details.

Using the LCD monitor buttons

There are nine buttons on the back of your PhotoPC 3100Z. These buttons are for making various settings and for using the different features of the PhotoPC 3100Z.

With the exception of the round MENU ON/OFF button at the lower right corner, and the round  print button at the lower left corner, these buttons are not named. Throughout this manual, these buttons are often referred to by the icon or words that appear on the LCD monitor next to or above the button. For example, the button below Menu Change is called the MENU CHANGE button. As you use the camera, the icon or words that correspond to each button change, and accordingly the name of the button in the manual also changes.

Other times, the LCD monitor buttons may be referred to only by their location.

Taking Pictures Using the Viewfinder

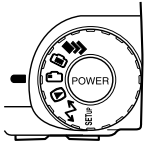

Using the viewfinder instead of the LCD monitor to take pictures saves battery power and helps you hold the camera steady while pressing the shutter button.

Follow the steps below.

1. Remove the lens cap, set the dial switch to , then turn on the camera. Then wait until the green indicator light beside the viewfinder comes on.
2. Look straight through the viewfinder and center your subject in the cross-hairs. If you cannot see clearly, adjust the diopter by turning the correction dial beside the viewfinder.

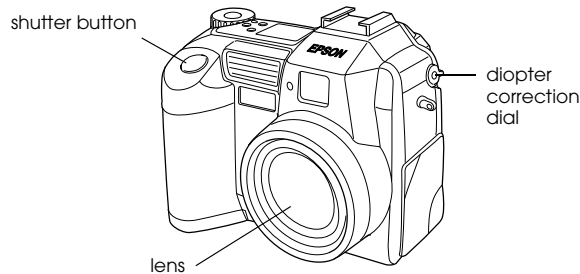

Note:

- ❑ Hold the camera firmly with both hands and keep it still for a few moments after you press the shutter button.
 - ❑ Make sure that you are not blocking the lens with your finger, the strap, clothing, or other objects.
 - ❑ The visible frame in the viewfinder indicates the approximate area that is captured in the photo.
3. Hold the shutter button halfway down to lock the auto focus. The green indicator light beside the viewfinder stops blinking when the lens locks in focus. If you wish, you can now reposition the camera, so that your subject is off-center, without losing focus.



4. Depress the shutter button fully to take the photo.



5. Hold the camera still until the green indicator light beside the viewfinder comes back on, or until the camera makes a clicking sound. Then release the shutter button.

After you take a picture, the green indicator light blinks. This signals that the image has been captured and the camera is processing it. When the light stops blinking, the image is saved. Saved images remain in the memory card even when the camera is turned off, the batteries are removed, or the memory card is removed from the camera.

When the indicator light next to the viewfinder stops blinking, the camera is ready to take another picture.



Using the optical zoom feature

You can capture a smaller portion of the subject at a higher magnification using the optical (x3) zoom feature.

Using the optical zoom

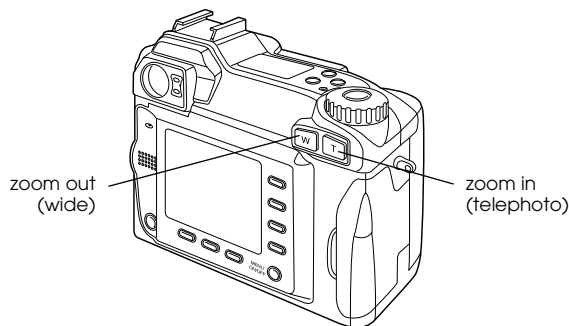
Your PhotoPC 3100Z's optical zoom feature allows you to increase the magnification of your images by as much as three times. To use the optical zoom feature, press the W and T buttons on the back of the camera under the dial switch. To zoom out, press the W button. To zoom in, press the T button. You can use the optical zoom feature at any time when taking photos.



When using the zoom feature in the  or  dial position, the following zoom indicator appears at the top of the LCD monitor.



yellow slider

A yellow slider indicates the current zoom status, moving to the right when you zoom in on your subject and to the left when you zoom out.

Note:

The PhotoPC 3100Z also has a digital zoom feature that allows you to enlarge the image up to six times the original size when used together with the optical zoom. For more information on the digital zoom feature, see "Using the digital zoom" on page 2-12.

Using the self timer



Turning on the self timer creates a 10-second delay between the time you press the shutter button and the moment the image is captured, allowing you to include yourself in photographs. The timer icon appears on the display panel when you turn on the timer. Follow the steps below.

1. Place the camera on a flat surface or a tripod.

2. Remove the lens cap, turn on the camera, and set the dial switch to . Wait until the green indicator light comes on.

Note:

You can also use the self timer when taking photos or video clips using the LCD monitor. For more information on taking photos with the LCD monitor, see "Taking Pictures Using the LCD monitor" on page 2-9. For more information on taking video clips, see "Recording video clips" on page 2-13.

3. Press the  timer button on the top of the camera. The timer icon appears on the display panel.
4. Take a picture. The timer icon and the red timer light on the front of the camera flash slowly for eight seconds, then rapidly for two seconds before the shutter releases.

If the Beep setting is set to Always, the camera makes a steady beeping sound. For information on the Beep setting, see "Setting the beep and shutter sound" on page 4-21.

To take another picture using the self timer, press the  timer button again.

Note:

- ❑ To stop the self timer after pressing the shutter button, press the shutter button again, or press the  timer button.
- ❑ You can use the self timer when taking photos using the continuous shooting feature. The camera takes up to approximately 47 pictures in sequence, beginning ten seconds after you press the shutter button. To turn continuous shooting on, see “Using the continuous shooting feature” on page 2-15.

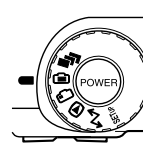
Taking Pictures Using the LCD monitor

By using the LCD monitor, you can get a good idea of what the image will look like before shooting and confirm image quality immediately after shooting. Use the LCD monitor when you want

to take pictures using digital zoom feature or when taking close-ups.

Note:

- ❑ You can turn the LCD monitor’s text display on and off by pressing the MENU ON/OFF button.
- ❑ You can make audio recordings when taking pictures using the LCD monitor. See “Making Audio Recordings for Photos” on page 2-19.
- ❑ You can use the basic playback feature when the dial switch is set to . See “Using the basic playback feature” on page 2-10.

Follow these steps to take pictures using the LCD monitor.

1. Remove the lens cap, set the dial switch to , then turn on the camera. You will see a live preview displayed on the LCD monitor. Center the subject of your photo in the monitor.

Note:

- ❑ *Hold the camera firmly with both hands and keep it still for a few moments after you press the shutter button.*
 - ❑ *Make sure that you are not blocking the lens with your finger, the strap, clothing, or other objects.*
2. Hold the shutter button halfway down to lock the auto focus. A small green circle ● appears in the upper-right corner of the monitor. If you wish, you can now reposition the camera, so that your subject is off-center, without losing focus.



When you are in the Program or Manual camera mode, the shutter speed and aperture settings are shown on the display panel on the top of the camera.

3. Depress the shutter button completely to take the photo.





4. Hold the camera still until the camera makes a clicking sound. Then release the shutter button.

After the picture is taken, it remains displayed on the monitor until the camera finishes processing it. After the green indicator light comes on, you can take another photo or display or manage your photos. See “Playing Back and Managing Images With Your Camera” on page 3-1.

Using the basic playback feature

When you take photos using the LCD monitor, you can view the photos that you have already taken using the basic playback feature. Using this feature, you can view your photos without having to turn the dial switch to the  position after taking a photo. You can use this feature when the LCD monitor is displaying a preview image, or immediately after taking a picture. See the appropriate section below.

Note:

- ❑ *When using the basic playback feature, you can use the  print button to make print settings. See “Making Camera Settings” on page 4-19 for details on using the  print button.*
- ❑ *You cannot view video clips using the basic playback feature.*

When a preview image is being displayed

To use the basic playback feature when the LCD monitor is displaying a preview image, follow the steps below.

1. Remove the lens cap, set the dial switch to  and turn on the camera. A preview image is displayed on the LCD monitor.
2. When the camera is in Manual mode, press the MENU CHANGE button. When the camera is in Program mode or Full Auto mode, go on to step 3.

Note:

See “Making camera mode settings” on page 4-6 for information about the camera mode.

3. Press the  icon to playback your photos.

During playback, you can enlarge or erase photos, view multiple photos, and play back audio recordings. Refer to the appropriate section below.

- ❑ To enlarge photos, see “Magnifying photos” on page 3-2.
- ❑ To erase photos, see “Erasing images” on page 3-7.

- ❑ To change the number of photos that you can view on the LCD monitor at a time, see “Displaying one, four, or nine photos at once” on page 3-1.
- ❑ To play back audio recordings, see “Audio playback using the built-in speaker” on page 2-21.

To return to the preview image when the camera is in Manual mode, press the BACK button twice. To return to the preview image when the camera is in Program mode or Full Auto mode, press the BACK button once.



Immediately after taking a picture

You can also use the basic playback feature immediately after taking a picture. You must first make some settings. Follow these steps.

Note:

Using this feature increases the amount of time that you must wait after taking a picture before you can take the next one.

1. Remove the lens cap, set the dial switch to **SETUP**, and turn on the camera.
2. Press the Shot **SETUP** button on the back of the camera.
3. Press the Confirmation button to select **On**.

4. Turn the dial switch to  and take a picture.
5. After the camera processes the photo, the  icon appears briefly next to the top-right LCD monitor button. Press this button while the icon is displayed to playback your photos.

To delete the photo you just took, press the Delete button. Before taking more photos, press the BACK button or press the shutter button to return to the previewed image.

Using the digital zoom

You can capture a smaller portion of your subject at a higher magnification using the zoom feature. When taking pictures with the LCD monitor, you can use the digital zoom in addition to the optical zoom to seamlessly magnify the image by as much as six times.

To use the digital zoom, you must first make a setting to turn the feature on. Follow these steps.

Note:

For details on using the optical zoom without using the digital zoom, see “Using the optical zoom feature” on page 2-7.

1. Make sure the camera is on and set the dial switch to **SETUP**.
2. Press the Shot SETUP button.
3. Press the D-ZOOM button to turn the digital zoom On or Off, then press the BACK button.

To take a picture using digital zoom, set the dial switch to the  or  dial position.

Press the T button on the back of the camera under the dial switch.

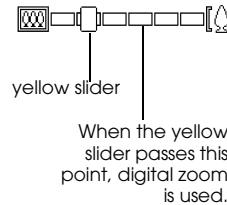

A yellow slider indicates the current zoom status, moving to the right when you push the T button to zoom in on your subject, and to the left when you push the W button to zoom out.

Hold the button down until **DIGITAL ZOOM** appears briefly on the center of the LCD monitor, and a yellow frame appears around the previewed image.

Frame your subject in the LCD monitor and take a picture.

Using the macro setting to take close-ups





The macro feature allows you to take pictures of subjects 6 to 50 centimeters away from the camera.

Note:

You may need to be more than 6 centimeters away from the subject when using the optical zoom feature. See “Using the optical zoom feature” on page 2-7 for details.

Follow the steps below to use the macro feature.

1. Remove the lens cap, set the dial switch to , and turn on the camera.
2. Press the OFF button once. A green frame appears around the previewed image and MACRO is displayed briefly at the center of the monitor.

To use the video clip recording feature, the continuous shooting feature, the time lapse feature or the stitch assist feature, select MACRO and turn the dial switch to . Then press the MODE CHANGE button to select the feature you want to use.

3. Frame your subject in the LCD monitor and take a picture.

Taking Multiple Exposures

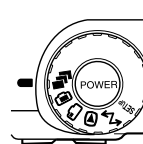

To record video clips, use the continuous shooting feature, time lapse feature, or the stitch assist feature, turn the camera’s dial switch to .

Recording video clips

You can record video clips with sound (up to 25 seconds) or without sound (up to 35 seconds).



Follow these steps to record a video clip.

Note:

- The image quality setting is disabled when taking video clips.
- You can record sound with your video clips only while you are taking the clip. You cannot make an associated audio recording for existing video clips.
- The flash is disabled when recording video clips.

1. Remove the lens cap, set the dial switch to , and press the POWER button to turn on the camera. VIDEO CLIP appears at the top of the LCD monitor, a white frame appears around the previewed image, and the total available amount of recording time is displayed at the upper-left corner of the LCD monitor.

Note:

- ❑ *The amount of recording time available depends on Sound setting you make in the next step, and the amount of space available in your camera's memory card.*
 - ❑ *To use the macro feature when recording a video clip, first turn the dial switch to  and press the  button. Then set the dial switch to  and proceed to the next step.*
2. To record audio with your video clip, press the Sound button to select On. The maximum recording time for this setting is 25 seconds.

To take a video clip with no audio, select Off. The maximum recording time for this setting is 35 seconds.

Note:

For an explanation on using the buttons on the back of the camera, see "Using the LCD monitor buttons" on page 2-5.

3. Frame your subject in the LCD monitor, then press the shutter button to begin recording the video clip.

The amount of time remaining for recording is displayed at the upper-left corner of the LCD monitor. REC is displayed in red directly below the remaining seconds to indicate that you are recording.

4. You can stop recording a clip at any time by pressing the shutter button again, or you can continue recording until recording time runs out.

Using the continuous shooting feature

You can use the continuous shooting feature to break down a complex motion into photos containing a series of easy-to-see steps. You can also use it to take a number of consecutive pictures and then choose the ones that you like best. When the image quality is set to Standard, you can take almost two photos per second, up to approximately 47 photos. When Fine is selected, you can take almost one photo per second, up to approximately 13 photos. When Super Fine is selected, you can take one photo per second, up to approximately seven photos.

Note:

- ❑ *When using the continuous shooting feature, you cannot use the flash or select the HyPict or TIFF image quality settings.*
- ❑ *You cannot make an audio recording while using the continuous shooting feature.*
- ❑ *Settings made in other dial positions remain effective when you use the continuous shooting feature. Before using the continuous shooting feature, turn the dial switch to the appropriate position and make your settings.*



Follow these steps to take pictures using the continuous shooting feature.

1. Remove the lens cap, set the dial switch to , and turn on the camera.
2. Press the MODE CHANGE button. A red frame appears around the previewed image and CONTINUOUS is displayed on the LCD monitor.
3. If necessary, adjust the image quality and activate the self timer using the buttons on the top of the camera. The self timer creates a ten second delay between the time you press the shutter button and the moment the actual image is captured.
4. Depress the shutter button halfway to lock the focus, then depress it fully and hold it down to begin taking a series of photos.
5. Release the shutter button to stop taking pictures.

Using the time lapse feature

You can use the time lapse feature to take pictures automatically at a preset time interval. Use this feature creatively to capture scenes that change over time, such as sunsets, plant life, or a busy street corner. The time interval can be set from five seconds to 24 hours.

Note:

- ❑ *The settings that you make in the  dial position remain when you use the time lapse feature. To change these settings, turn the dial switch to  and make the appropriate settings before using the time lapse feature.*
 - ❑ *You cannot take TIFF files when using the time lapse feature.*
1. Secure the camera on a flat surface or tripod.
 2. Remove the lens cap, turn the dial switch to , and turn on the camera.
 3. Press the MODE CHANGE button until INTERVAL is displayed at the top of the LCD monitor.
 4. The hours, minutes, and seconds appear in the center of the screen with the seconds highlighted.

Press the up and down arrow icon buttons to change the value of the highlighted time unit. To highlight a different time unit, press the left and right arrow icon buttons.

If you wish to quickly select either the longest or the shortest available interval, you can toggle between 24 hours and the shortest available interval by pressing the Max/Min button.

Note:

The shortest available interval varies depending on the current image quality, shutter speed, audio recording, and flash settings.

5. Once you have set the desired interval, frame the subject in the LCD monitor and press the shutter button to begin taking photos.

Note:

- ❑ *The camera may turn off automatically after you take the first picture. It automatically turns back on to take pictures at the specified time.*
- ❑ *When using the self timer feature, the camera takes a photo ten seconds after you press the shutter button, then continues taking photos at the specified time lapse interval.*

6. To turn off the time lapse feature, press the POWER button while Int  appears on the camera's display panel.

Using the stitch assist feature

You can use the PhotoPC 3100Z's stitch assist feature to help take a series of overlapping pictures that can be easily combined into a panorama image with the EPSON Panorama Boutique Light EP included on your CD-ROM.

This feature allows you to take one or two rows of overlapping photos.

an example of two rows of overlapping photos

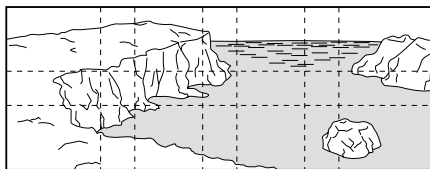

The procedure for taking one level of overlapping pictures is different from the procedure for taking two levels of overlapping pictures.

Note:

- ❑ You cannot use the stitching feature with HyPict or TIFF files.
- ❑ For best results, EPSON recommends using a tripod when using the stitch assist feature.

Taking one row of overlapping photos

To take one row of overlapping photos, take a photo of the left part of the image first, then turn the camera to the right to take subsequent photos.

Follow the steps below.

1 ---> 2 ---> 3 ---> 4

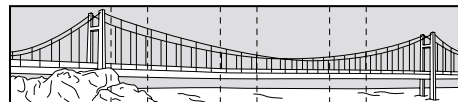

1. Remove the lens cap, set the dial switch to , and turn on the camera.
2. Press the MODE CHANGE button until STITCHING appears at the top of the LCD monitor.
3. Take a picture.

Immediately after taking the picture, the photo displays briefly on the screen for confirmation. During this time, you can erase the photo by pressing the Delete button.

- The right side of the previously taken photo displays on the left of the LCD monitor. Align this section with the left side of the image currently displayed on the LCD monitor so the images overlap, and then take the photo.

If you press the upper right button where the number and left arrow are displayed, the previously taken photo is displayed. If you press the Delete button at this screen, the photo will be deleted. If you press the upper right number where the number and right arrow are displayed, you return to the preview image.

- To add more pictures, repeat step 4. Press the Finish button when you are done adding pictures.

Taking two rows of overlapping photos

To take two rows of overlapping photos, start by taking a photo of the upper left part of the image. To take subsequent photos in the top row, turn the camera to the right before taking each photo. After you finish taking photos in the top row, take the first photo of the bottom row directly below the last photo of the top row. Then turn the camera to the left to take the remaining photos of the bottom row.

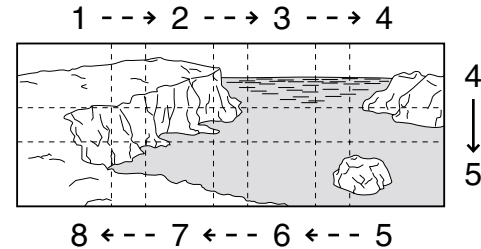

- Follow steps 1 to 4 from “Taking one row of overlapping photos” on page 2-17.
- After you finish taking photos in the top row, press the button below the arrow displayed in the lower left corner of the LCD monitor.

Note:

You can return to the previous screen by pressing the button next to the arrow displayed in the upper right corner of the LCD monitor. This will allow you to continue taking pictures in the top row.

3. The bottom section of the previously taken photo displays on the top of the LCD monitor. Align this section with the top of the image currently displayed on the LCD monitor so the images overlap, and take the picture.
4. The left side of the previously taken photo displays on the right of the LCD monitor. Align this section with the right side of the image currently displayed on the LCD monitor so the images overlap, and take the picture.

If you press the upper right button where the number and left arrow are displayed, the previously taken photo is displayed. If you press the Delete button at this screen, the photo will be deleted. If you press the upper right number where the number and right arrow are displayed, you return to the preview image.

5. When you are finished taking photos in the bottom row, press the Finish button.

If you want to view the photos you just took, you can display them on the LCD monitor. For information on displaying photos on the LCD monitor, see “Viewing Images Using the LCD Monitor” on page 3-1.

Making Audio Recordings for Photos

Your PhotoPC 3100Z has a built-in microphone that can record messages to attach to your images. You can make audio recordings up to ten seconds long immediately after taking photos using the LCD monitor. You can also make recordings for photos that were taken previously.

Note:

- ❑ To play back audio recordings using your camera, see “Audio playback using the built-in speaker” on page 2-21.
- ❑ You can also play back audio recordings from your computer using EPSON Photo!4. See the online EPSON Digital Camera Software User’s Guide for instructions.
- ❑ To erase audio recordings, see “Erasing audio recordings” on page 3-7.

Recording audio immediately after taking photos

To make audio recordings immediately after taking photos, you must first make a few settings. Follow these steps.



1. Remove the lens cap, set the dial switch to **SETUP**, and turn on the camera.
2. Press the Shot **SETUP** button on the back of the camera.

Note:

For an explanation on using the buttons on the back of the camera, see “Using the LCD monitor buttons” on page 2-5.

3. Press the Confirmation button to select **On**.
4. Turn the dial switch to .

Note:

 To make recordings while using the time lapse feature, turn the dial switch to , press the **MODE CHANGE** button twice, then press the **SOUND** button to select **On**. See “Using the time lapse feature” on page 2-15 for more information.

 You cannot make recordings when taking pictures using the viewfinder.

5. Frame your subject in the LCD monitor and take a picture.
6. The captured image is displayed on the LCD monitor momentarily, and **Rec Sound** is displayed at the right. To begin recording, press the **Rec Sound** button. The camera begins making the audio recording.

Note:

When making recordings while using the time lapse feature, **Rec Sound** is not displayed and the camera automatically records audio after the photo is taken.

7. A ten-second countdown is displayed on the screen. You can record audio until the time runs out by speaking into the built-in microphone on the back of the camera. To stop recording before ten seconds is up, press the **Stop** button.

Note:

When making recordings while using the time lapse feature, **Stop** does not appear on the LCD monitor.

Recording audio for existing photos

To make audio recordings for previously taken photos, follow these steps.

Note:

You cannot make an audio recording for existing video clips.

1. Set the dial switch to , then turn on the camera.
2. Press the arrow icon buttons to select the image to which you want to attach an audio recording. If a photo already has an audio recording associated with it, a microphone icon is displayed in the upper-left corner of the photo.
3. Press the MENU CHANGE button, then press the SOUND button.
4. To begin making the recording, press the Sound REC button. You can record audio until the time runs out by speaking into the built-in microphone on the back of the camera.

If there is already an audio recording associated with the current photo, a confirmation message appears. To erase the old recording and make a new one, press Yes. Press NO to cancel recording.

To stop recording before ten seconds is up, press the Stop button.

5. Press the BACK button twice to exit.

Audio playback using the built-in speaker

You can play back the audio files recorded for photos and video clips using the built-in speaker. Follow these steps.

1. Set the dial switch to , then turn on the camera.
2. Press the arrow icon buttons to select an image that has an audio recording associated with it. These images have a microphone icon displayed in the upper-left corner.
3. Press the MENU CHANGE button, then press the SOUND button.
4. Press the Sound Play button to play back the recording.

Press the Sound Stop button to cancel playback.

5. Press the BACK button twice to return to the first screen.

Note:

To adjust the speaker volume, see “Adjusting the speaker volume” on page 4-21.

Playing Back and Managing Images With Your Camera

This chapter explains how to view photos on your camera's LCD monitor, or a television set. It also includes explanations for locking and erasing photos, and for displaying photo information using the controls on your camera.



This chapter covers the following topics.

- ❑ Displaying photos on your camera
- ❑ Playing back video clips on your camera
- ❑ Erasing photos and video clips
- ❑ Preventing images from being erased
- ❑ Viewing photo information
- ❑ Viewing images on your computer, television, or projector

Viewing Images Using the LCD Monitor

When your camera's dial switch is in the  position, you can use the camera's LCD monitor to view your photos and video clips in a variety of ways. You can also view detailed information about each photo.

Note:

- ❑ *When viewing images with the LCD monitor, you can use the  print button to make print settings for photos. See "Making Camera Settings" on page 4-19 for details on using the  print button.*
- ❑ *Only DCF (Design rule for Camera File system) image files can be magnified, have audio recordings attached, or display photo information. Images taken with your EPSON camera are DCF image files.*

Displaying one, four, or nine photos at once

The PhotoPC 3100Z's monitor can display one, four, or nine photos at a time. To change the number of photos displayed, follow these steps.

1. Set the dial switch to **▶**, then turn on the camera. A photo is displayed on the LCD monitor.

Note:

No Images is displayed when there are no photos saved on the camera's memory card.

2. To display four photos at a time, press the Multi button once. Multi changes to 1/9, and small "thumbnails" of the last four photos you took appear on the screen, with the currently selected photo framed in white.

Press the 1/9 button to display nine photos at a time. 1/9 changes to 1/1.

3. Press the arrow icon buttons to select a photo with the white frame. Hold the button down to move through the photos quickly.

When the frame reaches the first or last photo in the current group, the previous or next group of photos is displayed.

4. To display only the currently selected photo, press the 1/1 button. 1/1 changes to Multi.

Magnifying photos

You can view a magnified version of the photos saved in your camera on the LCD monitor. Follow the steps below.

1. Set the dial switch to **▶**, then turn on the camera.
2. To enlarge the view of the currently displayed photo, press the T button on the back of the camera under the dial switch.

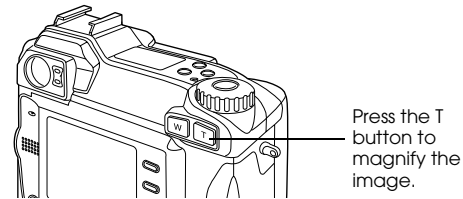

A number appears at the top center of the LCD monitor, and an icon appears in the top left corner of the LCD monitor that indicates the portion of the photo which is currently displayed.

Hold down the T button to continue magnifying the photo. You can magnify the photo until the number at the top center of the LCD monitor reaches x3.0.

Press the **W** button to decrease the level of magnification.

3. Scroll the screen up, down, right, or left using the arrow icon buttons. You can scroll quickly through the screen by holding down any one of the arrow icon buttons.
4. Press the **BACK** button to exit the magnification screen.

Viewing a slide show of your photos

The slide show feature plays back a series of photos on your camera's LCD monitor. To use the slide show, follow the steps below.

Note:

To adjust the brightness of the LCD monitor, see "Setting the LCD monitor's brightness level" on page 4-20.

1. Set the dial switch to **☐**, then turn on the camera.
2. Press the **MENU CHANGE** button, then press the **SLIDE SHOW** button.
3. Press the **Sound** button to turn the playback of audio recordings on or off.

Note:

*The **Sound** button is only available when there are audio recordings saved on the memory card in your camera.*

4. To rotate a photo, press the arrow icon buttons to select the photo that you want to rotate.

To make selecting photos easier, you can display either four or nine photos at a time by pressing the **Multi** button once or twice. A white frame appears around the selected photo.

To rotate the photo 90 degrees to the left from its original orientation, press the **Rotate** button once. Press it again to rotate the photo 90 degrees to the right from its original orientation. Press the button again to return the photo to its original orientation.

To rotate other photos, repeat this step.

5. When you are ready to begin the slide show, press the **Start** button.

To pause the slide show, push the **Pause** button. When the slide show is paused, you can view the previous photo by pressing the **Rev** button, or view the next photo by pressing the **Fwd** button.

Press the Restart button to continue viewing the slide show.

- To cancel the slide show before it is finished, press the Quit button, then press the BACK button twice.

Note:

If the slide show finishes before you press the Quit button, the camera goes into the power save mode.

Viewing photo information

You can view the following information about the currently displayed photo on the LCD monitor.

Image Number: Folder name and image number in the memory card.

Note:

(ⓔ) indicates that the photo is based on the Design rule for camera file system, which is a recording standard for image files.

Date: Date and time

Shutter Speed: 1/1000 to 8

Aperture: F2 to F10.1

Exposure Adjustment: +2.0 to -2.0

Flash: ON or OFF
An icon indicates the flash setting that was used when the photo was taken.

White Balance: Auto, Fixed, or Custom

Others: Icons indicate the sensitivity and metering system settings.
An icon indicates whether the macro feature was used.
D-ZOOM indicates that the digital zoom was used.

To display photo information for a photo, follow these steps.

- Set the dial switch to , then turn on the camera.
- Press the MENU CHANGE button.
- Use the arrow icon buttons to select a photo for which you want to view information, then press the INFO button.
- Press the BACK button twice to return to the first screen.

Selecting a folder in the CompactFlash Card

If there is more than one folder on your CompactFlash Card that your PhotoPC 3100Z can access, you can change the folder that your camera accesses. To change the folder, follow these steps.

1. Set the dial switch to **SETUP**, then press the **POWER** button to turn on the camera.
2. Press **Memory SETUP**. The name of the folder currently being used appears on the right side of the LCD monitor, between the up and down arrow icons.
3. Press the up and down arrow icon buttons to change the folder, then press the **BACK** button.

Playing back video clips

The PhotoPC 3100Z allows you to view your video clips in a variety of ways. You can play them forward or in reverse, in slow motion, or one frame at a time in either direction, and you can fast forward or rewind them. Follow the steps below.

1. Set the dial switch to **▶**, then turn on the camera.

2. Press the **MENU CHANGE** button, then press the **VIDEO CLIP** button. The first frame of the last video clip you took appears on the screen.

Note:

When there are no video clips saved on the camera's memory card, the VIDEO CLIP button is disabled, or the message There is no video clip is displayed.

To display frames from four video clips at a time, press the **Multi** button once. **Multi** changes to 1/9, and small "thumbnail" images of the first frames from the last four video clips you took appear on the screen, with the currently selected video clip framed in white.

Press the 1/9 button to display nine frames at a time. 1/9 changes to 1/1.

3. To select the video clip that you want to play back, press the up and down arrow icon buttons.
4. To play the clip, press the **Play** button.

Note:

The camera's built-in speaker replays the audio during video playback. To adjust the volume of the built-in speaker, see "Adjusting the speaker volume" on page 4-21.

To play the clip in reverse, from the last frame to the first, press the Fwd button. The last frame of the video clip is displayed and Fwd changes to Rev. Then, press the Play button.

To play the clip in slow motion, press the Change Speed button during playback.

5. To pause the clip during playback, press the PAUSE button.

To move forward through the clip one frame at a time while the clip is paused, press the Fwd button. To move through the clip one frame at a time in reverse, press the Rev button. Hold down one of the up and down arrow icon buttons to fast forward or rewind through the clip.

Press the RESTART button to resume playback of the clip.

6. When you are finished playing back the video clip, press the Quit button, then press the BACK button.

Managing Images with the LCD Monitor

This section provides instructions to help you manage your images using the LCD monitor.

Locking and unlocking photos

Use the lock feature to protect your photos from being accidentally erased. If you try to erase a locked photo, a message appears asking you to confirm deletion. Locked files are also erased when you format the memory card.

To lock or unlock selected photos stored on the memory card in your camera, follow these steps.

1. Set the dial switch to , then turn on the camera.
2. Press the arrow icon buttons to move the white frame until the appropriate photo is selected.

To make selecting photos easier, you can display either four or nine photos at a time by pressing the Multi button once or twice. Multiple photos are displayed and a white frame appears around the selected photo.

3. To lock that photo, press the LOCK button. A lock icon appears in the upper-left corner of the photo.

To unlock a locked photo, press the Unlock button. The lock icon is removed from the upper-left corner of the photo.

4. To lock or unlock other photos, repeat steps 2 and 3.

Erasing images

You can erase one photo, several photos, or all of the photos at once using the LCD monitor.

Erasing individual photos

To erase photos saved in your memory card one at a time, follow the steps below.

1. Set the dial switch to **☑**, then turn on the camera.
2. Press the arrow icon buttons to display the photo that you want to erase.

To make selecting photos easier, you can display either four or nine photos at once by pressing the button below Multi once or twice. A white frame is displayed around the selected photo.

3. Press the Delete button to erase the photo.

4. A confirmation message is displayed. Press Yes to erase the photo. Press NO to cancel.

Erasing all of the photos

To erase all of the photos stored on the memory card in your camera at once, follow these steps.

1. Set the dial switch to **☑**, then turn on the camera.
2. Press the Delete All button to erase all of the photos at once.
3. A confirmation message appears. Press Yes to erase all of the photos. Press NO to cancel.

Note:

If any photos are locked, a message is displayed confirming that you want to erase the locked photos. Press NO to erase only the unlocked photos. Press Yes to erase all photos, including those that are locked. For information on locking and unlocking photos, see "Locking and unlocking photos" on page 3-6.

Erasing audio recordings

To erase audio recordings from the memory card in your camera, follow the steps below.

Note:

To make audio recordings, see “Making Audio Recordings for Photos” on page 2-19.

1. Set the dial switch to , then turn on the camera.
2. Use the arrow icon buttons to select a photo with an attached audio recording that you want to erase (a microphone icon is displayed in each photo that has an attached recording).
3. Press the MENU CHANGE button.
4. Press the SOUND button.
5. To erase the selected photo’s audio recording, press the Delete Sound button.

If the selected photo is locked, a message appears informing you that the photo is locked. To erase the locked photo, press Yes. For details on locking and unlocking photos, see “Locking and unlocking photos” on page 3-6.

6. A message is displayed to confirm whether you want to erase the audio recording. Press Yes to erase the recording, or No to cancel.
7. Press the BACK button twice to exit.

Erasing video clips

To erase video clips saved on your memory card, follow the steps below.

1. Set the dial switch to , then turn on the camera.
2. Press the MENU CHANGE button, then press the VIDEO CLIP button. The first frame of the last video clip you took appears on the screen.
3. Use the arrow icon buttons to select the video clip that you want to erase.

To make selecting video clips easier, you can display the first frame from either four or nine clips at a time by pressing the Multi button once or twice. Multiple frames are displayed and a white frame appears around the selected clip.

4. After selecting the video clip, press the Delete button. Press the Yes button to erase the video clip.

To cancel erasing the clip, press the NO button.

Viewing Pictures on a Television

You can display images and play back audio recordings saved on the camera's memory card on a regular television simply by connecting the camera to the television using the AV cable that came with your PhotoPC 3100Z.

Note:

Television telecasting specifications vary by country. Select NTSC or PAL to meet the video signal specifications in your country. See "Selecting the signal system and language" on page 4-21.

Follow the steps below to connect the PhotoPC 3100Z to your television.

1. Make sure the camera and television are turned off.

2. Open the connector cover on the side of the camera.

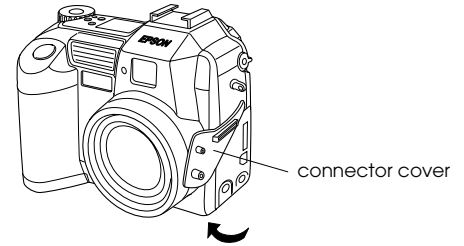

3. Connect the AV cable to the AV OUT port on the camera as shown below.

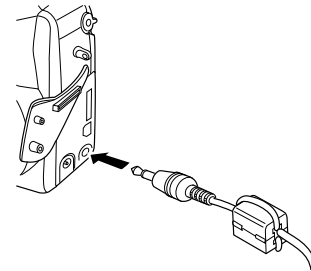

4. Connect the other end of the AV cable to the audio and video input ports on the television.

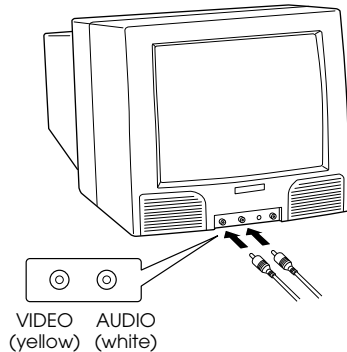

5. Turn on the television and switch it to video mode.
6. Set the dial switch to , then turn on the camera.

The image displayed on the LCD monitor displays on the television. If the camera is connected to the AC adapter, the image is also displayed on the LCD monitor. If the camera is not connected to the AC adapter, the image only displays on the television.

You can use all of the operations and procedures for viewing or managing images on the LCD monitor to view or manage images on the television. For more information on viewing the images, see "Viewing Images Using the LCD Monitor" on page 3-1. For more information on managing the images, see "Managing Images with the LCD Monitor" on page 3-6.

Viewing Pictures with an EPSON Projector

You can display images stored on your camera's memory card using an EPSON Projector that is connected to your camera via the video cable that came with your PhotoPC 3100Z.

See your EPSON Projector documentation for details.



Making Settings

You can make a variety of settings for your PhotoPC 3100Z. The available settings depend on the camera's dial switch position. This chapter explains how to make the following settings.

- ❑ Settings that directly affect the quality of the photos that you take with your camera, such as image quality, flash, exposure, sensitivity, white balance, switching between color and monochrome, switching between internal and external flash, and other advanced settings.
- ❑ General camera settings that do not affect the quality of images, such as the date and time, the language, the LCD monitor's brightness level, the speaker volume level, the beep and shutter sounds, and the automatic shut-off time.
- ❑ Settings that affect the way your pictures are printed.

Making Image Capture Settings



Read this section to make settings that directly affect the quality of the photos that you take with your camera.

You can make all image capture settings while  is selected as the dial switch position. By pressing the camera's MENU ON/OFF button, you can also make some image capture settings while  is selected as the dial switch position. This turns on the LCD monitor and allows you to access and change some of the settings.

Adjusting the image quality

The PhotoPC 3100Z has four basic image quality settings. You can also take high quality uncompressed TIFF images.

Making basic image quality adjustments

While your PhotoPC 3100Z's dial switch is set to , , or , you can cycle through the image quality settings by pressing the ★ image quality button on the top of the camera. The currently selected image quality setting is displayed on the display panel. You can toggle freely between these settings, and take and save pictures with various quality settings on the same CompactFlash Card. The CompactFlash Card's image capacity will vary accordingly.

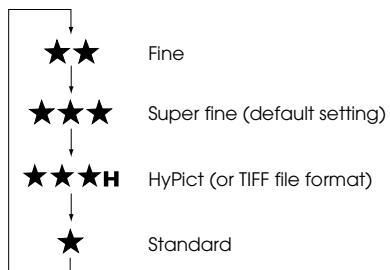

The image quality settings are as follows:

★ **Standard**
Images are captured at 640×480 pixels and the included 16 MB CompactFlash Card holds approximately 199 standard compression photos, or 122 low compression photos, without audio recordings. Images are less detailed than those taken using other settings.

★★ **Fine**
Images are captured at 1600×1200 pixels. These pictures have moderate detail and the included 16 MB CompactFlash Card holds approximately 56 standard compression photos, or 29 low compression photos, without audio recordings.

★★★ **Super fine**
Images are captured at 2048×1536 pixels. These pictures are highly detailed and the included 16 MB CompactFlash Card holds approximately 29 standard compression photos, or 15 low compression photos, without audio recordings.



HyPict

When these icons are shown on the display panel, you can take HyPict or TIFF photos.

HyPict images are captured at 2544 × 1904 pixels. These pictures have even higher detail than super fine images, and the included 16 MB CompactFlash Card stores approximately 12 HyPict photos without audio recordings.

For information on TIFF photos, see “Taking photos in the TIFF file format” on page 4-4.

Note:

- ❑ *The image quality setting is retained when the camera is turned off.*
- ❑ *The number of photos that you can take varies depending on the complexity of the photo and the number and length of audio recording files saved on the memory card.*
- ❑ *For more information on image compression, see “Making image compression settings” on page 4-3.*
- ❑ *After you take a picture using the HyPict setting, the camera takes approximately 18 seconds to process the image.*

- ❑ *HyPict is not available when using the continuous shooting feature.*

Making image compression settings

With your PhotoPC 3100Z, you can set image compression to standard or low. The default setting is standard.

Photos taken at the low image compression setting take up more memory than those taken at the standard setting. This means you can take fewer pictures at the low setting. For more information about the number of pictures you can take at these settings, see “Making basic image quality adjustments” on page 4-2.

Note:

Image compression settings only apply to images with the Standard, Fine, or Super fine image quality settings.

To make the compression setting, follow these steps.

1. Remove the lens cap, turn on the camera, and set the dial switch to **SETUP**.
2. Press the Shot **SETUP** button.
3. Press the second button from the top on the right of the LCD monitor, and select either **Std.compression** or **Low compression**.

4. Press the Back button.

Taking photos in the TIFF file format

In addition to the four basic image quality settings, your PhotoPC 3100Z allows you to take uncompressed images in the TIFF file format. These images are captured at 2048 × 1536 and offer the highest image quality, but have a much larger file size and take longer to process. The included 16 MB CompactFlash Card stores approximately one TIFF photo.



To take TIFF photos, follow these steps.

Note:

- ❑ *To take a TIFF photo, you must use a CompactFlash Card that has at least 9.1 MB of memory available.*
 - ❑ *The continuous shooting feature is disabled when taking TIFF photos.*
1. Remove the lens cap, turn on the camera, and set the dial switch to **SETUP**.
 2. Press the Shot **SETUP** button.
 3. Press the Image button to select TIFF.

Note:

Selecting JPEG allows you to take photos using the HyPict image quality setting, instead of the TIFF file format.

4. Turn the camera's dial switch to  or , then press the **★** image quality button on the top of the camera until **★★★H** appears on the display panel.
5. Press the shutter button to take a TIFF photo.

Note:

After you take a TIFF photo, the camera takes approximately 22 seconds to process the image.

Setting the flash

The flash has the following effective ranges, depending upon the optical zoom ratio and whether or not the macro setting is used.

Wide (minimum zoom): 50-420 centimeters

Tele (maximum zoom): 50-340 centimeters

Macro: 20-50 centimeters

The effective flash range varies depending on the sensitivity setting (see page A-3 for details).

Turn on the camera and press the flash  button on the top of the camera to cycle through the flash settings. The settings appear on the display panel as shown below.

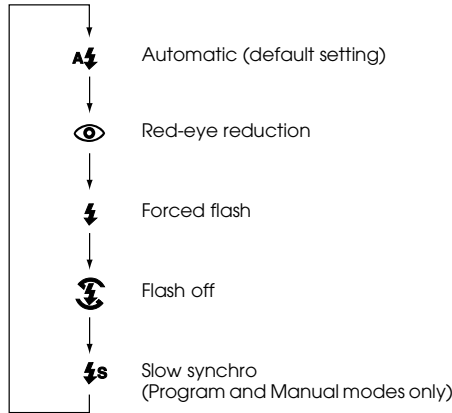

The flash settings are as follows:



Automatic

The flash fires automatically whenever more lighting is needed.



Red-eye reduction

The flash flickers briefly before firing to reduce the red-eye effect in flash photos of people. As with the Automatic setting, the flash fires automatically whenever it's needed for adequate lighting.



Forced flash

The flash fires with every picture you take. Use this setting to compensate for backlighting; for example, when you are facing the sun.



Flash off

The flash is disabled even when adequate lighting is not available. Use this setting for special effects or when using a flash is prohibited.



Slow synchro

The camera's shutter speed slows to enhance the clarity of background details in the photo when taking pictures at dawn or twilight, or in places with an illuminated background.

Note:

- ❑ After turning on the camera and taking a flash photo, the flash icon and the green indicator light beside the viewfinder blink until the flash is fully recharged.
- ❑ When you use the external flash, the internal flash is disabled and the flash  button does not work.
- ❑ Slow synchro is only available in the Program or Manual camera modes. To change the camera mode, see “Making camera mode settings” on page 4-6.
- ❑ You can select a leading or trailing slow synchro setting. To select a slow synchro setting, see “Selecting slow synchro timing” on page 4-17.
- ❑ The flash is disabled when taking video clips or using the continuous shooting feature.

Making camera mode settings

The PhotoPC 3100Z has three camera modes to suit your photographic needs. Each mode gives you a different degree of control over the camera settings, whether you are taking photos using the viewfinder or the LCD monitor. Read this section to choose the appropriate mode, and to change the mode if necessary.

Choosing a camera mode

Choose from the camera modes described below.

Full Auto

Allows you to take photos without having to make complex settings. The available settings include:

- ❑ Flash, including auto, red-eye reduction, forced, and off
- ❑ Self timer
- ❑ Image quality
- ❑ Optical zoom
- ❑ Digital zoom (when using the LCD monitor)
- ❑ Macro (when using the LCD monitor)
- ❑ Quick playback of photos and messages (when using the LCD monitor)

Program

For users who want a moderate amount of control over the camera’s features. Available settings include:

- ❑ All of the settings that are available in the Full Auto camera mode
- ❑ Slow synchro flash

- ❑ Sensitivity
- ❑ Predefined exposure
- ❑ Fine exposure adjustment (in increments of 0.5 EV)
- ❑ Auto, custom, or fixed white balance

Manual

For experienced users who want complete control over the camera's wide array of features. Available settings include:

- ❑ All of the settings that are available in the Full Auto camera mode
- ❑ Slow synchro flash
- ❑ Sensitivity
- ❑ Fine exposure adjustment (in increments of 0.2 EV)
- ❑ Manual exposure adjustment using the auto exposure, manual exposure, aperture priority, and shutter priority
- ❑ Manual focus features
- ❑ Spot and divided brightness metering systems
- ❑ Auto, custom, or fixed white balance

Changing the camera mode

To change the camera mode, follow these steps.

1. Set the dial switch to **SETUP** and turn on the camera. The current camera mode is displayed at the right side of the LCD monitor, below the date and time settings.
2. Press the LCD monitor button next to the current camera mode to change the setting.

Changing the color/monochrome setting

You can take both color and monochrome photos using the PhotoPC 3100Z. To select color or monochrome, follow the steps below.

Note:

- ❑ *The file size is the same for both color and monochrome photos.*
 - ❑ *When taking photos with Monochrome selected, the **EW** icon is shown on the camera's display panel.*
1. Set the dial switch to **SETUP** and turn on the camera.
 2. The current setting is displayed at the right side of the LCD monitor. Press the LCD monitor button next to the current setting to toggle between Color and Monochrome.

Making manual focus settings



When in the Manual camera mode, you can make focus settings manually. Follow these steps.

1. Make sure that MANUAL is selected as the camera mode. (See “Making camera mode settings” on page 4-6.)
2. Remove the lens cap, set the dial switch to , and turn on the camera.

Note:

You cannot make manual focus settings when taking pictures using the viewfinder.



3. If you want to make focus settings manually when using the macro feature, press the  OFF button.
4. Press the MENU CHANGE button.
5. Press the up and down arrow icon buttons to select a manual focus setting.

You can choose between AF for automatic focus,  for when the subject is about one meter away,  for when the subject is about three meters away, and  for when the subject is more than three meters away.

When using the macro feature, you can choose between M1 for when the subject is about 0.2 meters away, M2 for when the subject is about 0.5 meters away, or AF for automatic focus. The smaller the value, the closer the subject should be to the camera.

Adjusting the sensitivity setting

Your PhotoPC 3100Z has the following sensitivity settings.

-  Standard sensitivity, equivalent to ISO 100
-  High sensitivity, equivalent to ISO 200
-  Super high sensitivity, equivalent to ISO 400

When to adjust the sensitivity



Set the sensitivity to high or super high when taking photos in the following situations:

- ❑ If the subject is fast moving (useful for indoor sports)
- ❑ If the subject is far away when using a flash
- ❑ If it is dark and you are not using a flash (useful when flash photography is prohibited)

EPSON recommends setting the sensitivity to standard \triangleright at all other times, as image quality is lower when using higher sensitivity settings.

How to adjust the sensitivity

Follow the steps below to change the sensitivity.

1. Make sure that Program or Manual is selected as the camera mode. (See “Making camera mode settings” on page 4-6.)
2. Remove the lens cap, set the dial switch to  or , and turn on the camera.

If the dial switch is set to , press the MENU ON/OFF button on the back of the camera to turn on the LCD monitor.

3. In the Program camera mode, press the ISO button to toggle between standard, high, and super high sensitivity.

In the Manual camera mode, press the MENU CHANGE button. Then press the ISO button to toggle between standard, high, or super high sensitivity.

Note:

The selected sensitivity setting is displayed under ISO on the LCD monitor.

Adjusting the white balance setting

The PhotoPC 3100Z has three white balance settings that are accessible when the Program or Manual camera mode is selected, one of which is a custom setting that you can make yourself.

When to adjust the white balance



Your camera’s white balance default setting is AUTO. When AUTO is selected, the camera adjusts the white balance automatically. At certain times you may want to manually adjust the white balance setting so that the colors in your images appear more realistic.

For example, make FIX the white balance setting when taking pictures at dusk to increase the reddish color tones in your images. However, keep the white balance set to AUTO when taking pictures under white light to avoid a green tone in your images.

If you are an experienced user, and you want to make your own custom white balance settings, see “Making a custom white balance setting” on page 4-10.

Changing the white balance setting

Follow these steps to change the white balance setting.

1. Make sure that the Program or Manual camera mode is selected. To change the camera mode setting, see “Making camera mode settings” on page 4-6.
2. Remove the lens cap, set the dial switch to  or , and turn on the camera.

If you set the dial switch to , press the MENU ON/OFF button on the back of the camera to turn on the LCD monitor.

3. In the Program camera mode, press the W/B button to toggle between AUTO, FIX and CUSTOM.

In the Manual camera mode, press the Menu Change button. Then press the W/B button to toggle between AUTO, FIX, and CUSTOM and press BACK to save your setting.

Note:

The selected white balance setting is shown beneath W/B on the LCD monitor.

Making a custom white balance setting

Follow the steps below to create your own white balance setting.

Note:

A custom white balance setting remains saved when the camera is turned off.

1. Remove the lens cap, turn the dial switch to SETUP and turn on the camera.
2. Press the Shot SETUP button.
3. Press the New W/B button. A confirmation message is displayed. Press Yes to continue making settings.

4. Place a white sheet in front of the camera lens so that it fills the entire LCD monitor.

Note:

- ❑ *You can also use a colored sheet. For example, to create a sepia hue, use a blue sheet. To create a blue hue, use a yellow sheet. Experiment with other colors for different effects.*
 - ❑ *To quit without making a custom white balance setting, press BACK.*
5. Press the shutter button to make the new setting.

To use your custom white balance setting, see “Changing the white balance setting” on page 4-10.

Making exposure settings

The PhotoPC 3100Z allows you to make many levels of exposure settings in a variety of ways. The following sections explain how to make predefined exposure settings when in the Program camera mode, and how to manually make basic or advanced exposure settings in the Program or Manual camera mode.

Making basic exposure adjustments



Exposure refers to the amount of light the camera captures when a photo is taken.

The camera’s default exposure setting is AUTO. When AUTO is selected, the exposure is adjusted automatically. However, you can manually adjust the exposure to change the darkness or brightness of your photos to compensate for certain conditions.

When to make basic exposure adjustments

Increase the exposure setting when:



- ❑ You want to make your photos lighter.
- ❑ You are taking pictures of a white object which may tend to look grayish in photos.
- ❑ You are taking pictures of an object with a bright background, such as a chair in front of a sunlit window.
- ❑ You are taking photos at the beach or in the snow on a sunny day.

Decrease the exposure setting when:

- ❑ You want to make your photos darker.
- ❑ You are taking pictures of a black object which may tend to look grayish in photos.
- ❑ You are taking pictures of an object with a black background.

How to make basic exposure adjustments

Follow the steps below to change the exposure setting.

1. Make sure that Program or Manual is selected as the camera mode. To change the camera mode setting, see “Making camera mode settings” on page 4-6.
2. Remove the lens cap, set the dial switch to  or , and turn on the camera.

If the dial switch is set to , press the MENU ON/OFF button on the back of the camera to turn on the LCD monitor.

3. Press the LCD monitor buttons next to  to raise or lower the exposure value.

In the Program camera mode, you can make nine different settings in increments of 0.5, from -2.0 to 2.0 EV.

When in the Manual camera mode, you can adjust the exposure when Auto Exposure or Aperture Priority is selected. You can make 21 different settings in increments of 0.2, from -2.0 to 2.0 EV.

Note:

- ❑ *The selected exposure setting is shown at the right side of the LCD monitor.*
- ❑ *Photographic knowledge and experience is necessary to correctly adjust the exposure. Be sure the exposure settings are appropriate when taking important photos.*
- ❑ *When shooting under poor photographic conditions, EPSON recommends taking several photos of the same subject using different exposures.*

Making predefined exposure settings

The PhotoPC 3100Z has four predefined exposure settings available when the Program camera mode is selected.

When to use a predefined exposure setting

Refer to the descriptions below to make the appropriate settings.

Normal

For taking basic photographs. Uses the following settings:

- Auto exposure
- Divided brightness metering system

Sports

For photographing fast-moving subjects. Uses the following settings:

- High shutter speed
- Automatic sensitivity
- Divided brightness metering system

Portrait

For photographing portraits. Uses the following settings:

- Wide aperture setting
- Spot metering system



Landscape

For photographing landscapes or scenery. Uses the following settings:

- Aperture priority
- Divided brightness metering system

How to change the predefined exposure setting

Follow the steps below to make the predefined exposure setting.

1. Make sure the Program camera mode is selected. See “Making camera mode settings” on page 4-6 for details.
2. Remove the lens cap, set the dial switch to  or , and turn on the camera.

If the dial switch is set to , press the MENU ON/OFF button on the back of the camera to turn on the LCD monitor.

3. Press the Program button to toggle between Normal, Sports, Portrait, or Landscape.

Making advanced exposure adjustments

When the Manual camera mode is selected, you can manually set the correct exposure by changing the shutter speed and the aperture. Select Auto Exposure, Aperture Priority, Shutter Priority or Manual Exposure as the exposure mode. Although these exposure modes are similar to the predefined program modes available in the Program camera mode, you can manually make advanced exposure adjustments when in the Manual mode.



Note:

Photographic experience and knowledge is necessary to make proper shutter speed and the aperture adjustments. Be sure to make appropriate settings before taking important photos.

You can specify shutter speeds from 8 to 1/1000 seconds. You can specify an aperture of F2, F2.3, F2.8, F4.0, F5.6, or F8.0.

Auto exposure

Auto exposure is an easy-to-use feature that automatically adjusts the shutter speed and the aperture to achieve the correct exposure. Select the auto exposure feature as follows.

1. Make sure that Manual is selected as the camera mode. (See “Making camera mode settings” on page 4-6.)
2. Remove the lens cap, set the dial switch to  or , and turn on the camera.



If the dial switch is set to , press the MENU ON/OFF button on the back of the camera to turn on the LCD monitor.

3. Press the button at the top-right of the LCD monitor repeatedly until Auto Exposure is displayed.
4. To make fine exposure adjustments, press the LCD monitor buttons next to  to raise or lower the exposure value.

Aperture priority

Aperture priority allows you to select the aperture first, so that the camera automatically adjusts the shutter speed for the correct exposure. Select the aperture priority feature as follows.

1. Make sure that Manual is selected as the camera mode. See “Making camera mode settings” on page 4-6 for details.

2. Remove the lens cap, set the dial switch to  or , and turn on the camera.

If the dial switch is set to , press the MENU ON/OFF button on the back of the camera to turn on the LCD monitor.



3. Press the button at the top-right of the LCD monitor repeatedly until Aperture Priority is displayed.
4. To change the aperture value, press the left and right arrow icon buttons.

To adjust the exposure, press the buttons next to  at the right side of the LCD monitor.

Shutter priority

Shutter priority allows you to select the shutter speed first, so that the camera automatically adjusts the aperture for the correct exposure. Select the shutter priority feature as follows.

1. Make sure that Manual is selected as the camera mode. See “Making camera mode settings” on page 4-6 for details.

2. Remove the lens cap, set the dial switch to  or , and turn on the camera.

If the dial switch is set to , press the MENU ON/OFF button on the back of the camera to turn on the LCD monitor.

3. Press the button at the top-right of the LCD monitor repeatedly until Shutter Priority is displayed.
4. To change the shutter speed, press the left and right arrow icon buttons.

To adjust the exposure, press the buttons next to  at the right side of the LCD monitor.

Manual exposure

Manual exposure allows you to manually adjust the shutter speed and the aperture to set the exposure. Make the manual exposure setting as follows.

Note:

You cannot make manual exposure settings when taking pictures with the viewfinder.

1. Make sure that Manual is selected as the camera mode. See “Making camera mode settings” on page 4-6 for details.
2. Remove the lens cap, turn on the camera, and set the dial switch to .
3. Press the button at the top-right of the LCD monitor repeatedly until Manual Exposure is displayed.
4. To adjust the aperture, press the left and right arrow icon buttons.

To adjust the shutter speed, press the up and down arrow icon buttons.

Changing the metering system

Your camera uses the divided brightness metering system by default. When in the Manual camera mode, you can switch freely between the divided brightness and spot metering systems.

Note:

When taking photos using the portrait exposure setting, the camera automatically uses the spot metering system. To select Portrait as the exposure setting, see “Making predefined exposure settings” on page 4-13.

When to change the metering system



Use the spot metering system in most photographic situations.

Use the divided brightness metering system in the following situations:

- When taking pictures of objects that have a bright background, such as a chair in front of a sun-lit window
- When there is a clear contrast in shading between the upper and lower part of the frame

How to change the metering system

Follow the steps below to change the metering system.

1. Make sure that Manual is selected as the camera mode. See “Making camera mode settings” on page 4-6 for details.
2. Remove the lens cap, set the dial switch to  or , then turn on the camera.

If the dial switch is set to , press the MENU ON/OFF button on the back of the camera to turn on the LCD monitor.

3. Press the MENU CHANGE button.
4. To change the metering system, press the Metering button.



When the divided brightness metering system is selected, a square-shaped icon with nine squares inside it appears in the lower-right corner of the LCD monitor.





When the spot metering system is selected, a square icon with a small circle inside it appears in the lower-right corner of the LCD monitor.



Selecting slow synchro timing

You can set the flash timing to slow synchro. Leading synchro, the default slow synchro setting, is suitable for most situations. Trailing synchro is a special setting for expressing motion. Follow the steps below to specify the slow synchro setting.

Note:

You cannot select slow synchro timing when using an external flash, or when Full Auto is selected as the camera mode.

1. Set the dial switch to , then turn on the camera.
2. Make sure that Manual or Program is selected as the camera mode. See “Making camera mode settings” on page 4-6 for details.
3. Press the Shot SETUP button. Leading, Trailing, or Ext Flash (if you are using an external flash) is displayed at the right side of the LCD monitor.
4. Press the button next to this setting to choose between Leading and Trailing.
5. Set the dial switch to  or .

6. Make sure that slow synchro is selected as the flash setting. Press the flash  button on the top of the camera until the slow synchro icon  appears on the display panel on the top of the camera.

Note:

For details on making the flash setting, see “Setting the flash” on page 4-4 for details.

Selecting the internal or external flash

The PhotoPC 3100Z has a convenient built-in flash which satisfies ordinary flash needs. If you need more light, you can attach an external flash (sold separately as a camera accessory) to the PhotoPC 3100Z.

To mount the external flash, turn off the flash and your camera, slide the mounting foot of the flash into the hot-shoe attachment on the top of the PhotoPC 3100Z, and secure the lock mechanism. For details about using the flash, refer to its documentation.



Warning:

Be sure to turn off the camera and flash before connecting them.

Note:

When using the external flash, the internal flash setting is disabled and the  button does not work.

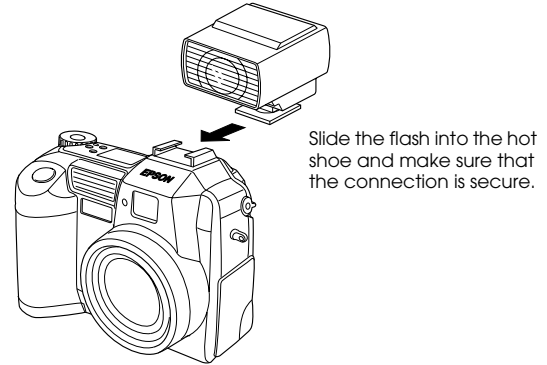

Follow the steps below to specify an internal or external flash.

1. Make sure that the camera is in the Manual camera mode. To change the camera mode setting, see “Making camera mode settings” on page 4-6.

Note:

The external flash only works in the Manual camera mode. To change the camera mode setting, see “Making camera mode settings” on page 4-6.

2. Set the dial switch to **SETUP** and turn on the camera.
3. Press the Shot **SETUP** button.
4. Leading or Trailing appears at the right side of the LCD monitor. Press the button next to this setting until Ext Flash is displayed.
5. Press the **BACK** button to return to the previous screen.

Making Camera Settings

When the camera's dial switch is in the **SETUP** position, you can make certain camera settings, including setting the internal clock and changing the camera mode, the beep and shutter sound, the LCD monitor's brightness level, the speaker volume, and the automatic shut-off time. You can also set the display language.

Setting the time and date

Follow the instructions in this section to set the time and date.

1. Set the dial switch to **SETUP** and turn on the camera.
2. The date (month, day, and year) and the time (hour and minute) appear at the upper-right corner of the LCD monitor. Press the button next to the date and time.
3. To change the order in which the date is displayed, press the top button on the right side of the LCD monitor. You can make the following settings: M.D.Y (for month/day/year); D.M.Y (for day/month/year); and Y.M.D (for year/month/day).
4. To adjust the value of the highlighted item, use the up and down arrow icon buttons.

To change which item is highlighted, use the right and left arrow icon buttons.

5. After setting the correct time and date, save the settings by pressing the **BACK** button.

Note:

- ❑ You must reset the time if the camera is unplugged and the batteries are removed for more than one week.
- ❑ You can also set the time and date using your computer. See the online EPSON Digital Camera Software User's Guide for details.

Using the automatic shut-off feature

When using this feature, your camera saves battery power by automatically shutting off when idle for a designated period of time. You can have the camera shut off after thirty seconds, one minute, or five minutes. This feature is only enabled when using batteries to power the camera.

Note:

If the camera is connected to a computer, the power does not turn off.

Changing the setting

To change the automatic shut-off interval, follow these steps.

1. Set the dial switch to **SETUP** and turn on the camera.

2. Press the Camera **SETUP** button. The current setting appears at the top-right corner of the LCD monitor.
3. Press the Power Save button. You can select 30 seconds, 1 minute, or 5 minutes as the interval.
4. Press **BACK** to save your setting.

Turning the camera back on

When the dial switch is set to a red icon, you can turn the camera back on by pressing the shutter button or the **POWER** button.

When the dial switch is set to **SETUP**, **AV**, or **Q**, you can turn the camera back on by pressing any button on the back of the camera, or the **POWER** button.

Setting the LCD monitor's brightness level

Follow these steps to change the LCD monitor's brightness level.

1. Set the dial switch to **SETUP** and turn on the camera.
2. Press the Camera **SETUP** button.
3. Press the arrow icon buttons to increase or decrease the brightness level.

4. Press the BACK button to return to the previous screen.

Adjusting the speaker volume

Follow these steps to adjust the volume of the built-in speaker.

1. Set the dial switch to **SETUP** and turn on the camera.
2. Press the Camera **SETUP** button.
3. Press the **Volume** button to adjust the speaker volume level.
4. Press **BACK** to return to the previous screen.

Setting the beep and shutter sound

You can choose to have the camera beep whenever you press an LCD monitor button and make a shutter sound whenever you take a picture, only make a shutter sound when you take a picture, or never make a sound. You can also set the camera to beep when using the self timer if **Beep** is set to **Always**. Follow these steps to change the sound setting.

Note:

To adjust the volume of the built-in speaker, see the previous section.

1. Set the dial switch to **SETUP** and turn on the camera.
2. Press the Camera **SETUP** button.
3. Press the button below **Beep** to select **Always**, **Shutter**, or **Never**. Then press the **BACK** button to return to the previous screen.

Selecting the signal system and language



In order to view your photos and video clips on a television, you need to choose either the **NTSC** or **PAL** signal system to meet your local television broadcasting standards.

You can also choose **English**, **Japanese**, **French**, **German**, **Italian**, **Portuguese**, or **Spanish** (and **Chinese** in some areas), as the language used to display camera information on the LCD monitor.

To select the signal system and language, follow the steps below.

1. Set the dial switch to **SETUP** and turn on the camera.
2. Press the  button.

3. Press the arrow icon buttons to move the cursor to the language of your choice.
4. Press the TV button to select NTSC or PAL.
5. Press the BACK button to save your selection.

Making Print Settings

You can use your PhotoPC 3100Z to make settings that determine how your photos are printed. After you select which photos you want to print, you can make the following settings:

- ❑ The number of prints for each selected photo
- ❑ Whether to print an index of the selected photos

Settings for the number of prints and for index prints are saved in a Digital Print Order Format (DPOF) file on the camera's memory card. You can apply these settings when using a printer or printing application that supports the DPOF standard. Also, in some countries you will find print shops that support this standard and can print according to the settings in your DPOF file. Using the DPOF file to relay these settings to your printer, printing application, or print shop helps make printing quick and easy.

- ❑ Brightness settings
- ❑ Sharpness settings

These brightness and sharpness settings are recorded in each image file as PRINT Image Matching information. This information can be used by printers that support the PRINT Image Matching system for enhanced printing results.

PRINT Image Matching is a new standard that allows digital cameras to record special information about the photos it takes and relay that information seamlessly to a printer compatible with this standard. Your PhotoPC 3100Z records this special information in each JPEG photo it takes. By using a printer that is also compatible with the PRINT Image Matching system, you can achieve printing results that were until now unattainable.

Note:



PRINT Image Matching information does not change the image data or the way the image is displayed on a computer screen.

To make these settings, see the following sections.

Note:

- ❑ *You cannot make print settings for video clips.*
- ❑ *To print the images in your memory card, see the online EPSON Digital Camera Software User's Guide.*

Selecting images and specifying the number of prints

When the camera's dial switch is set to the  position, you can use the  print button on the back of the camera to select a photo to be printed. You can also use the  print button to specify the number of prints, from zero to nine prints. Follow the steps below.

1. Remove the lens cap, set the dial switch to , then turn on the camera.
2. Press the arrow icon buttons to select the photo that you want to print.

To make selecting photos easier, you can display either four or nine photos at a time by pressing the Multi button once or twice. A white frame appears around the selected photo.

3. Press the  print button once to specify one print for that photo. Press the button again to increase the number of specified prints. The number of prints appears with a green background in the left corner of the photo. You can specify up to nine prints per photo.

You can specify zero prints by holding down the  print button, or by pushing the button when there are nine prints specified.

Making settings to print an index

To make settings for printing an index of all photos saved in the memory card, follow the steps below.

1. Select the photos you want to be included in the index as described in the previous section.
2. Turn the dial switch to the **↖** position.
3. To make the setting for printing an index, press the **INDEX** button to select **On**.

To change the setting, press the **INDEX** button again to select **Off**.

Making print quality settings

You can make settings that affect the brightness and the sharpness of the image when it is printed. First, select the images you want to print as explained in “Selecting images and specifying the number of prints” on page 4-23, then follow the steps in the appropriate section below.

Note:

- ❑ *These settings only affect the quality of the printout when you use a printer that supports the PRINT Image Matching system.*

- ❑ *These settings do not affect the image data, or the quality of the image when it is displayed on a computer monitor.*
1. Turn the dial switch to the **↖** position, then turn on the camera if necessary.
 2. Press the **ADJUST** button.
 3. To change the print setting for sharpness, press the **Sharpness** button. You can choose between **Std.** (standard), **High**, and **Low**.

To change the print setting for brightness, press the **Brightness** button. You can choose between **Std.** (standard), **High**, and **Low**.

Note:

- ❑ *The brightness of the image on the LCD monitor changes when you change the brightness setting. This approximates the effect the setting will have when printed by a printer that supports the PRINT Image Matching system.*
- ❑ *You can also specify the number of prints for the selected photo by pressing the arrow buttons.*
- ❑ *You can make print quality settings only for JPEG images taken with your PhotoPC 3100Z. You cannot make print quality settings for TIFF images.*

4. Push the **BACK** button to save your settings.

Using Images on Your Computer

This chapter prepares you to transfer your photos, video clips, and audio recordings from the camera's memory card to your computer. The following topics are covered.

- ❑ System requirements for your computer
- ❑ Installing the included EPSON software
- ❑ Connecting the camera to your computer
- ❑ Transferring image and audio recording files to your computer from the camera's memory card
- ❑ Viewing the software User's Guides

Note:

For information on using the EPSON camera software, see the online EPSON Digital Camera Software User's Guide. For information on printing photos with EPSON PhotoQuicker, see the online EPSON PhotoQuicker User's Guide.

System Requirements

To connect the PhotoPC 3100Z digital camera to your computer and run the digital camera software, refer to this section for the system requirements.

For Windows

The system requirements for Windows computers when connecting the PhotoPC 3100Z are as follows:

486 processor or higher

USB port (TYPE A receptacle)

At least 48 MB RAM
(64 MB when using EPSON PhotoQuicker)

Hard disk drive with at least 50 MB of free space
(170 MB when using EPSON PhotoQuicker)

VGA monitor with at least 256-color display

Microsoft® Windows 98 pre-installed, Windows Millennium Edition, or Windows 2000 pre-installed

QuickTime 4.1.2 or later

For Macintosh

The system requirements for Macintosh computers when connecting the PhotoPC 3100Z with a USB cable are as follows:

Power PC G3 processor or higher

Apple Macintosh with built-in USB port

48 MB RAM

(128 MB when using EPSON PhotoQuicker together with EPSON Photo!4)

Hard disk drive with at least 50 MB free space
(170 MB when using EPSON PhotoQuicker)

Monitor with a minimum resolution of 640 × 480

Macintosh OS 8.5.1 to OS 9.1

(Panorama Stitcher Light EP requires

Macintosh OS 8.6 to OS 9.1)

QuickTime 4.1.2 or later

Note:

The included software cannot be used with the Multiple Users function of Mac OS 9.

The Included Software

The EPSON Camera Software CD-ROM that comes with your PhotoPC 3100Z digital camera contains the following EPSON software.

- ❑ **PhotoPC 3100Z USB driver**
Driver necessary to connect your camera to your computer (except for Windows 2000 users and Macintosh OS 9).
- ❑ **EPSON Photo!4**
Software for viewing and managing the images you capture with your PhotoPC 3100Z.
- ❑ **EPSON CameraStarter**
Utility that starts automatically when you connect your camera to your computer and provides you with a convenient way to launch EPSON AutoDownloader and EPSON PhotoQuicker. (Automatically installed with EPSON Photo!4.)
- ❑ **EPSON AutoDownloader**
Utility that provides you with a quick and organized way to transfer your photos, video clips, and audio recordings from the camera to your computer. (Automatically installed with EPSON Photo!4.)

- ❑ **EPSON CardMonitor**
Utility that enables EPSON CameraStarter to start automatically by detecting when the camera is connected to your computer, or when the memory card is inserted into a PC Card slot.
- ❑ **EPSON PhotoQuicker**
Software for printing your images.
- ❑ **Panorama Stitcher Light EP**
Software for creating panoramas by combining overlapping images, especially those taken using your PhotoPC 3100Z's stitch assist feature.
- ❑ **EPSON File Converter**
Software for converting files so that they can be uploaded (with EPSON Photo!4) and used on your camera.
- ❑ **QuickTime 4**
Software necessary for viewing video clips.
- ❑ **Adobe Acrobat Reader**
Software for viewing the PDF online manuals contained in the included CD-ROMs.

Installing the Software for Windows Users

Follow the steps below to install the USB driver and other software on the included PhotoPC 3100Z Camera Software CD-ROM.

Note:

Do not connect your camera to your computer before you install the software.

1. Turn on the computer and insert the included Camera Software CD into the CD-ROM drive.

If a dialog box prompts you to select a language, click the appropriate language, then click .

2. The EPSON Installation Program dialog box appears. Select Install Digital Camera Software, then click .

Note:

If the EPSON Installation Program dialog box does not appear, double-click the My Computer icon. Click the CD-ROM icon, then select Open from the File menu. Then double-click Setup.exe.

- The following dialog box containing a list of software appears.

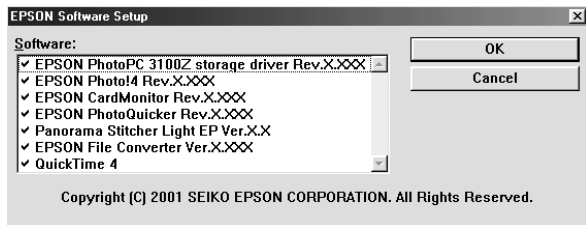

Software with a check mark next to it will be installed on your PC in the order listed. Click a software title in the list to remove or add a check mark.

Note:

- Be sure to install all the software when installing software for the first time.
- EPSON AutoDownloader and EPSON CameraStarter are automatically installed when you install EPSON Photo!4.
- For a short description of each software, see “The Included Software” on page 5-2.

Note for Windows 2000 users:

The PhotoPC 3100Z uses the USB driver included with Windows 2000. Therefore, EPSON PhotoPC 3100Z storage driver does not appear in the list of software and does not need to be installed.

- Click OK, then follow the on-screen instructions.
- After installing the first software, click Finish. The installation process begins automatically for the next software that you selected in step 3.
- Follow the on-screen instructions until all the software are installed.
- When you finish installing the last software, the following dialog box is displayed.

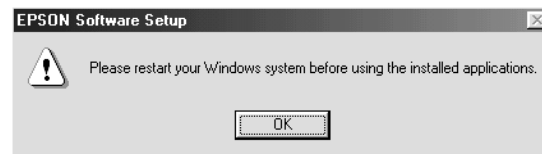

Click OK, then restart your computer.

Note:

Be sure to restart your computer after you are finished installing software from the Camera Software CD-ROM.

Installing the Software for Macintosh Users

Follow the steps in the sections below to install the USB driver and other software on the included PhotoPC 3100Z Camera Software CD-ROM.

Installing EPSON Photo!4 and other software

1. Turn on the computer and insert the included CD in the CD-ROM drive.
2. In the EPSON folder that appears on your computer's desktop, double-click the icon of your preferred language.

Note:

If the EPSON folder does not appear on your desktop, double-click the EPSON icon on your desktop.

3. Double-click the Installer icon. The following dialog box appears with a list of the software that will be installed.



Note:

- EPSON AutoDownloader and EPSON CameraStarter are automatically installed when you install EPSON Photo!4.
- Be sure to install all the software when installing software for the first time.

- ❑ *On the Macintosh OS 9, the USB driver is not installed. The PhotoPC 3100Z uses the USB driver included in Macintosh OS 9.*

4. To begin installing the software, click the Start button. Follow the on-screen instructions.

Note for Macintosh OS 8.5.x users:
Panorama Stitcher Light EP is not available and will not be installed.

5. After you finish installing the software, the following message appears.



Click Restart to restart your computer.

Note:
Be sure to restart your computer after you finish installing the software.

After your computer restarts, go to the next section to install QuickTime 4.

Installing QuickTime 4

QuickTime 4 is necessary for viewing video clips taken with your PhotoPC 3100Z on your computer. Follow the steps below to install QuickTime 4.

Note:
If QuickTime 4.1.2 or later is already installed on your computer, skip to the next section to install Acrobat Reader.

1. Turn on the computer and insert the included CD in the CD-ROM drive.
2. In the EPSON folder that appears on your computer's desktop, double-click the icon of your preferred language.

Note:
If the EPSON folder does not appear on your desktop, double-click the EPSON icon on your desktop.

3. Double-click the QuickTime folder, then double-click the QuickTime Installer icon.
4. Follow the on-screen instructions.

Installing Acrobat Reader

Acrobat Reader is necessary for viewing the online *EPSON Digital Camera Software Users Guide*. Follow the steps below to install Acrobat Reader.

Note:

If Acrobat Reader is already installed on your computer, skip to the next section to set up EPSON CameraStarter.

1. Turn on the computer and insert the included CD in the CD-ROM drive.
2. In the EPSON folder that appears on your computer's desktop, double-click the English icon.

Note:

If the EPSON folder does not appear on your desktop, double-click the EPSON icon on your desktop.

3. Double-click the Manual folder.
4. Double-click the Acrobat Reader folder. Then double-click the Acrobat Installer icon.
5. Follow the on-screen instructions.

After you finish installation, go to the next section to set up EPSON CameraStarter.

Setting Up EPSON CameraStarter

EPSON CameraStarter provides a convenient way to launch EPSON AutoDownloader and EPSON PhotoQuicker so that you can transfer files from your memory card to a computer, print your images, or do both in one session.

You can set up EPSON CameraStarter to open automatically when you connect your camera to your computer, or when you insert the card into a PC Card slot. To make these settings, follow the steps below.

Note:

- ❑ *You must use the memory card with your PhotoPC 3100Z before inserting it into a PC Card slot if you want EPSON CameraStarter to open automatically.*
- ❑ *To start CameraStarter automatically when a memory card is inserted, CardMonitor must be installed. For instructions on installing CardMonitor, see "Installing the Software for Windows Users" on page 5-3 or "Installing the Software for Macintosh Users" on page 5-5.*

1. Start EPSON CameraStarter as described below.

In Windows

Click Start, point to Programs, then to EPSON Camera and then to EPSON Photo!4, then click EPSON CameraStarter.

On a Macintosh

Double-click the EPSON Photo!4 folder, then double-click the EPSON CameraStarter icon.

The EPSON CameraStarter dialog box appears.

2. Click the Settings button.
3. To make EPSON CameraStarter open automatically when you connect a PhotoPC 3100Z containing a memory to your computer, or when you insert your memory card into your EPSON printer's PC Card slot, click the Show EPSON CameraStarter button.

If you want CameraStarter to open automatically when you insert your memory card into a PC Card slot of a device other than your printer, such as your computer or a memory card reader, select the Monitor card insertion into Card Reader slots check box.

Note:

Never insert or remove a memory card from your camera while the camera is on. For instructions on connecting your camera to your computer, see "Connecting the camera to your computer" on page 5-9.

If you do not want EPSON CameraStarter to open automatically, click the Ignore the Event button.

4. Click OK, then click Exit.

Note:

The Settings button is unavailable if EPSON CardMonitor is not installed.

Connecting and Disconnecting the Camera

Use the included USB cable to connect the camera to the computer. When your camera is connected, you can download or copy image and audio recording files to the computer, or upload photo and audio recording files saved in the computer to the memory card. Be sure to properly disconnect your camera after you finish using it. Follow the steps below.

Connecting the camera to your computer

You can connect your PhotoPC 3100Z to a Windows or Macintosh computer using the included USB cable.

Before connecting your camera, make sure that the USB driver is installed in your computer (except for Windows 2000 and Macintosh OS 9). For installation instructions, see “Installing the Software for Windows Users” on page 5-3 or “Installing the Software for Macintosh Users” on page 5-5.

Note:

- ❑ *Make sure the camera’s batteries have enough power before connecting the camera to your computer. If the PhotoPC 3100Z turns off automatically while connected because of low battery power, your computer may function improperly. EPSON highly recommends using the optional AC adapter whenever you connect the camera to your computer.*
- ❑ *When the camera is connected to the computer, you cannot use the buttons on the camera, and the camera’s automatic power save feature is disabled.*
- ❑ *Although you can connect the USB cable at any time, EPSON recommends connecting it in the manner described below to secure the connection.*

- ❑ *If the EPSON software does not recognize the camera when it is connected, see the Troubleshooting chapter in the online EPSON Digital Camera Software User’s Guide included on your CD-ROM.*

To connect the camera, follow the steps below.

1. Turn on your computer.
2. Plug the cable connector into the USB port on your computer or USB hub.

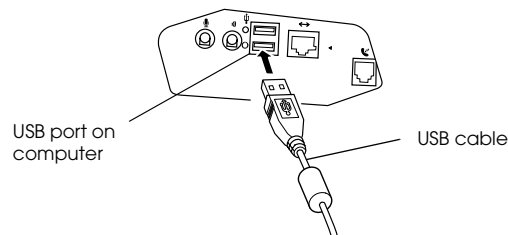

Caution:

Be sure to use the USB cable that comes with your camera to avoid damaging the camera’s interface connector.

3. Open the connector cover on the side of the camera. Insert the other end of the USB cable into the interface connector. Make sure that the shape of the cable connector corresponds to the shape of the interface connector.

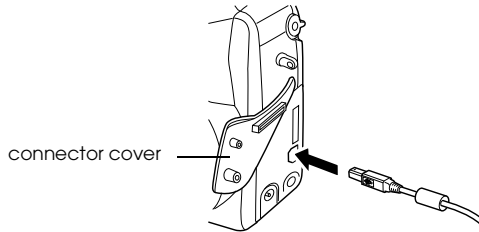

Caution:

Be sure to position the cable correctly before inserting it into the connector. Otherwise, the cable and connector may be damaged.

4. Set the camera's dial switch to  and turn the camera on.

The first time you connect your camera to your computer, the computer may display some windows while it associates the USB driver to the camera. This is normal and only happens the first time the camera is connected.

If you have not yet installed the USB driver, a message asking you to locate the driver will appear. If this happens, cancel the operation and disconnect the camera from the computer. Close all applications, then install the USB driver following the instructions in "Installing the Software for Windows Users" on page 5-3 or "Installing the Software for Macintosh Users" on page 5-5.

When you connect the camera, the green indicator light next to the viewfinder blinks while the connection is being established. While the camera is connected, stars move across the display panel at the top of the camera.



Caution:

Keep your camera and computer away from potential sources of electromagnetic interference, such as loudspeakers or the base units of cordless telephones.

Disconnecting the camera from your computer

After you are finished using the camera with the computer, be sure to disconnect the camera properly. Follow the steps in the appropriate section below.



Caution:

Be sure to follow these steps when disconnecting the camera. Doing otherwise may damage the camera or memory card, and could cause your computer to function improperly.

Disconnecting the camera in Windows Me and 98

1. Double-click the My Computer icon on the desktop. The My Computer window appears.
2. Right-click the Removable Disk icon, then click Eject.

Note:

If there is more than one Removable Disk icon, be sure to right-click the icon corresponding with the PhotoPC 3100Z. To check this, you can use the icon's Properties dialog box. See your Windows documentation for details.

3. Remove the USB cable, or turn off the camera.

Disconnecting the camera in Windows 2000

1. Double-click the eject icon in the task bar.

the eject icon

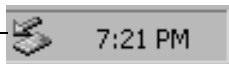

The Unplug or Eject Hardware dialog box appears.

Note:

You can also right-click the eject icon in the task bar, then click Unplug or eject hardware to display the Unplug or Eject Hardware dialog box.

2. Click the Stop button. The Stop a Hardware device dialog box appears.
3. Select USB Mass Storage Device, then click the OK button.
4. A confirmation message appears. Click OK.

Note:

If the Problem Ejecting USB Mass Storage Device window appears, click the OK button and redo the operation from step 1.

5. Remove the USB cable, or turn off the camera.

Note:

You can also disconnect the camera by clicking the eject icon on the task bar once, then clicking Stop USB Mass Storage Device, and clicking OK.

Disconnecting the camera from a Macintosh

1. On the desktop, move the EPSON_DSC icon into the Trash.
2. Remove the USB cable, or turn off the camera.

Transferring Images to Your Computer

The EPSON software that came with your PhotoPC 3100Z allows you to transfer image and audio recording files taken with your camera to your computer's hard drive in a convenient and organized way. You can also copy files to your computer directly from your memory card drive. To transfer images, the camera's memory card must be accessible in one of the following ways.

- ❑ The camera must be properly connected to your computer's USB port, and the CompactFlash memory card must be inserted in the camera.
- ❑ The memory card must be properly inserted into a PC Card slot in your computer.
- ❑ The memory card must be properly inserted into a PC Card slot in your printer, card reader, or other device that is connected to your computer.

For instructions on transferring images to your computer, see the following sections.

Using EPSON digital camera software

You can use the following software included with your PhotoPC 3100Z to download files to your computer's hard disk.

- ❑ **EPSON AutoDownloader**
Use this software to automatically transfer files into a specified folder. You can also make a variety of download settings that help you further organize your files and simplify the download process.
- ❑ **EPSON Photo!4**
Use this software to move and copy files between windows, folders or applications via the drag & drop method, or from the memory card.

For details on using these applications, see the online *EPSON Digital Camera Software User's Guide* included in the software CD-ROM. Also, refer to the online help for these applications.

Copying files directly from the memory card

To copy files to your computer, follow these steps.

Note:

- ❑ *When inserting the memory card into a Macintosh using the optional PCMCIA adapter, you must enable the PC Exchange extension software to access files on memory cards. See your Macintosh documentation for more information.*
 - ❑ *You can also access the files on your memory card using the included EPSON Photo!4 software. For instructions, see the online EPSON Digital Camera Software User's Guide.*
1. Connect the camera to your computer, or insert the memory card into the PC Card slot in your computer or other device.

Note:

For instructions on connecting your camera, see "Connecting the camera to your computer" on page 5-9. To insert the memory card into your computer, see "Inserting a memory card into your computer" on page 6-2. To insert the memory card into a different device, see the documentation for that device.

2. For photos, find and double-click the DCIM folder on the memory card drive. Then double-click the 100EPSON folder. Your image files are listed.

For video clips, find and double-click the Movie folder on the memory card drive. Your video clip files are listed.

Note:

- ❑ *The PhotoPC 3100Z saves audio recording files with the photo files in the automatically generated 100EPSON folder.*
- ❑ *Photos, audio recordings, and video clips that you have taken are automatically named in the order in which they were saved to the memory card. For example, Epsn0012 is the name of the twelfth photo that was saved. Photo files use the JPG or TIFF extension, audio recording files use the WAV extension, and video clip files use the MOV extension.*

3. Double-click a file to view its thumbnail image.
4. Copy the images to the desired folder on your hard drive.

Viewing the Software User's Guides on Your Computer

For information on using the included software, you can view the following user's guides on your computer.

EPSON Digital Camera Software User's Guide
EPSON PhotoQuicker User's Guide

See the sections below to view these manuals.

Accessing the EPSON Digital Camera Software User's Guide

Follow the steps below to view the online digital camera software manual.

For Windows

1. Turn on the computer and insert the included PhotoPC 3100Z Camera Software CD into the CD-ROM drive.

If a dialog box prompts you to select a language, click the appropriate language, then click .

2. The EPSON Installation Program dialog box appears. Select View PDF Manual, then click .

Note:

If the EPSON Installation Program dialog box does not appear, double-click the My Computer icon. Click the CD-ROM icon, then select Open from the File menu. Then double-click Setup.exe.

3. Follow the on-screen instructions to view the manual.

Note:

If Acrobat Reader is not installed in your computer, or an out-of-date version is installed, the on-screen instructions will guide you through installation of a current version of Acrobat Reader.

For Macintosh

1. Turn on the computer and insert the included PhotoPC 3100Z Camera Software CD into the CD-ROM drive.

In the EPSON folder that appears on your computer's desktop, double-click the English icon.

Note:

If the EPSON folder does not appear on your desktop, double-click the EPSON icon on your desktop.

2. Double-click the Manual folder.

Note:

If Acrobat Reader is not yet installed on your system, double-click the Acrobat Reader folder, then double-click the Reader installer icon to install Adobe Acrobat.

3. Double-click the EPSON Software User's Guide.pdf to view the manual.

Accessing the EPSON PhotoQuicker User's Guide

The online EPSON PhotoQuicker User's Guide is installed automatically when you install the EPSON PhotoQuicker software. Follow the steps below to view the manual.

For Windows

Click Start, point to Programs, then to EPSON PhotoQuicker, and then click EPSON PhotoQuicker3.0 User's Guide.

For Macintosh

Double-click the EPSON PhotoQuicker3.0 folder on your hard drive, then double-click the EPSON PhotoQuicker User's Manual icon.

Camera Options and Accessories

This chapter describes how to use the options that are available from EPSON to expand the memory and flexibility of your PhotoPC 3100Z.

The following topics are included in this chapter.

- ❑ Using CompactFlash memory cards
- ❑ Using the PCMCIA adapter
- ❑ Using rechargeable batteries
- ❑ Using the AC adapter
- ❑ Using the lens adapter

Using Memory Cards

The PhotoPC 3100Z has 2 MB of internal memory, which is primarily used to store optional software programs. It also comes with a 16 MB CompactFlash Memory Card to store photos.

Note:

A memory card must be installed in your PhotoPC 3100Z before you can take pictures. One has been installed in the camera prior to shipment. To install a memory card, see "Installing and removing a CompactFlash Card" on page 1-11.

The following table shows the approximate photo storage capacity of the 16 MB CompactFlash Card using various image quality and compression settings.

Image Quality Setting	Photo Storage Capacity (Standard compression)	Photo Storage Capacity (Low compression)
Standard	199 photos	122 photos
Fine	56 photos	29 photos
Super fine	29 photos	15 photos
HyPict	12 photos	
Tiff	1 photos	

Note:

- ❑ *The number of photos that you can save on a memory card may differ slightly from what is shown in the chart above, depending on the complexity of each photo.*
- ❑ *If you attach audio recordings to photos saved on your memory card, or if any video clips are saved on your memory card, the number of photos that you can save on that card may decrease.*
- ❑ *For information about the availability of CompactFlash Cards in your area, contact your EPSON dealer.*

Inserting a memory card into your computer

You can insert a memory card into any computer equipped with a Type II PCMCIA memory card slot. This allows you to copy photos directly from your memory card to your computer, to copy programs from your computer to your camera, or to erase programs from your memory card.

To insert the memory card in your computer, follow these steps.

1. If necessary, remove the memory card from the camera. See “Installing and removing a CompactFlash Card” on page 1-11.
2. Insert the memory card all the way into the optional adapter, as shown below.

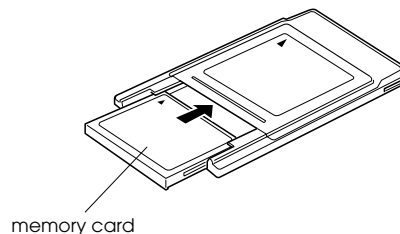

3. Insert the adapter into your computer's Type II PCMCIA slot.

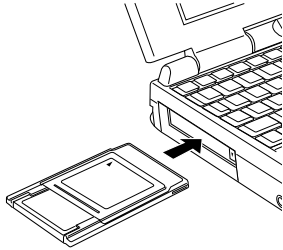

To copy photos from a memory card to your computer, see “Transferring Images to Your Computer” on page 5-12.

Formatting memory cards

The included CompactFlash Card is formatted prior to shipment. Only format a memory card when you want to erase all the data on the card or when a message on the LCD monitor instructs you to do so.

To format a memory card, follow these steps.



Caution:

When you format a memory card, all the data on the card is erased, including any locked images.

1. Make sure the memory card is inserted in the camera. See “Installing and removing a CompactFlash Card” on page 1-11.
2. Turn on the camera, turn the dial switch to **SETUP**, then press **Memory SETUP**.

Note:

*If no memory card is installed in the camera, the **Memory SETUP** button is unavailable.*

3. Press **MEMORY CARD FORMAT** to format the memory card.
4. A confirmation message appears. Press the **Yes** button to format the card. Press **NO** to cancel the operation.

Note:

*If any photos in the memory card are locked, a message is displayed informing you that the photos will be erased if you reformat the card. Press **Yes** to format the card. Press **NO** to cancel.*

5. Press the **Back** button.

Using Rechargeable Batteries

You can use Ni-MH rechargeable batteries (Model EU-24) with your PhotoPC 3100Z, instead of the included four AA (IEC LR6) alkaline batteries. The rechargeable batteries help you save time and money that you might otherwise spend buying replacement alkaline batteries. Be sure to charge your new rechargeable batteries before installing them in the camera.



Caution:

Do not use manganese batteries (IEC R6).

Keep the following points in mind when using these batteries.

- ❑ To fully charge new batteries or batteries that have not been used for a long time, you may have to charge them two or three times.
- ❑ Use the batteries regularly so that they continue to charge well. Batteries which have not been used for a long time will not charge well, but will return to normal with regular use.
- ❑ Discharge batteries completely before recharging them. If your batteries are not completely drained of power, you may not be able to recharge them fully.
- ❑ Batteries that are charged in a hot environment wear out more quickly.
- ❑ Do not leave batteries in the camera or charger for a long time without using them. See “Storing the batteries” on page 1-8 for storage instructions.
- ❑ Rechargeable batteries wear out with repeated use; as their charging capacity decreases, your camera’s operating time decreases. Replace the batteries when their operation time becomes short.
- ❑ When the batteries are fully charged, the light turns off. To charge your batteries again, unplug the AC power cord, then plug it back in.

Note:

Replace the batteries with new Ni-MH batteries if the charger light stays on for more than 240 minutes or if the charger light flashes for more than half an hour.

After the light goes off, unplug the charger. To avoid overcharging, unplug the charger as soon as possible after the light goes off.

Using the AC Adapter

The AC adapter (B867**1) allows you to connect your PhotoPC 3100Z to a standard electrical outlet. This is especially useful when you are previewing pictures, transferring pictures, operating the camera from your computer, or using the Print Mark program. The adapter powers the camera, but does not charge the batteries. In some locations the AC adapter comes with a separate AC power cable.

Note:

- ❑ *The asterisks are substitutes for the respective digits of the product number, which varies by country.*
- ❑ *Read the AC adapter's documentation before using this product.*



Warning:

- ❑ *Only use the included AC adapter that is designed for the PhotoPC 3100Z. Using another adapter could cause fire, electrical shock, or injury.*
- ❑ *Do not use the AC power cable or the adapter for any purpose other than powering your PhotoPC 3100Z.*
- ❑ *If the AC plug does not fit your outlet, have a proper outlet installed by a qualified electrician.*

- ❑ *To avoid radiation danger, do not expose or remove the ferrite core.*
- ❑ *To prevent fire or electric shock, do not cover the AC adapter with a blanket or similar covering that could give off an electrical charge.*

To avoid losing any images or settings, make sure that the camera is finished processing and is turned off before you connect or disconnect the AC adapter. Then follow the steps below.

1. If your AC adapter has a separate AC power cable, push the cable connector firmly into the AC inlet.

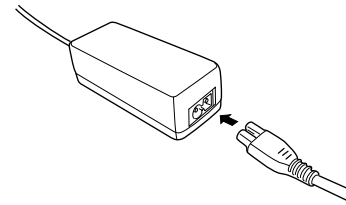

2. Open the connector cover on the side of the camera.

3. Plug the adapter cable into the DC port on the camera.

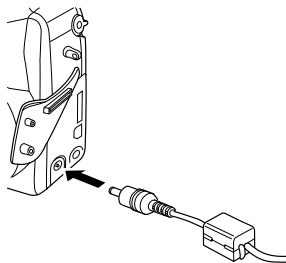

4. Plug the AC adapter into an electrical outlet.



Caution:

- ❑ Place the camera and the AC adapter near an electrical outlet where the plug can be easily unplugged.

Note for French-speaking users:

Placez l'appareil photographique et ses options près d'une prise de courant où la prise peut être débranchée facilement.

- ❑ Avoid electrical outlets that are controlled by wall switches or automatic timers. Also, avoid outlets on the same circuit as large appliances that can cause fluctuations in line voltage.

Using the Lens Adapter

The lens adapter allows you to mount an accessory lens onto the camera lens. You can mount a 49-mm diameter lens (sold separately).

To mount the accessory lens, screw the lens adapter onto the camera lens, then screw the accessory lens onto it.

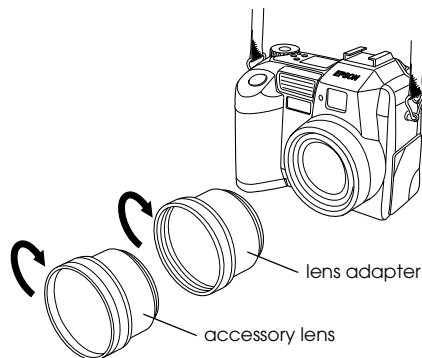

Note:

- ❑ Use the LCD monitor to take photos when an accessory lens is attached.
- ❑ Do not attach an accessory lens directly to the camera. Always use the lens adapter.

Maintenance and Troubleshooting

The PhotoPC 3100Z is easy to take care of, and most problems can be solved quickly and easily.

This chapter helps you maintain your camera and contains information on the following topics.

- ❑ Handling, cleaning and storing the camera
- ❑ Cleaning the battery charger
- ❑ Solutions for camera and image problems

Note:

See the online EPSON Digital Camera Software User's Guide for solutions to software problems.

Maintenance

Your PhotoPC 3100Z requires only basic care. Before you perform any maintenance on the camera, be sure to read the "Safety Instructions" on page 4. Then follow these guidelines.

Handling the camera

Keep the following points in mind when handling the camera.

- ❑ To avoid damaging the optics of the camera, do not expose the lens to direct sunlight for extended periods of time.
- ❑ Avoid sudden temperature changes, which can cause moisture to form on the camera and options. Keep the camera and options in a case or a bag if you need to move them from a cold environment to a warm one. Allow time for the camera and options to adjust to temperature changes before using them.

Cleaning the camera

Keep the following in mind when cleaning the camera.

- ❑ Use a clean, dry cloth to keep the camera free of dust.
- ❑ Do not use harsh or abrasive cleaners.
- ❑ To clean the lens, make sure the camera is turned off, then blow off any loose dust or dirt. Next breathe on the lens and wipe off all moisture with a soft, lint-free cloth or lens cleaning tissue.
- ❑ If necessary, clean the battery contacts with a dry cloth.

Storing the camera

If you are not planning to use the camera for a long period of time, remove the batteries and store them at a low temperature in a dry location. This prevents damage to the camera from battery leaks or corrosion.

Store the camera in its case. Do not store the camera in the following locations.

- ❑ Where it will be exposed to direct sunlight. For example, on a car dashboard
- ❑ Near sources of bright light or high humidity
- ❑ Near sources of heat or in a closed car
- ❑ In areas with excessive dirt or dust
- ❑ Where it will be exposed to strong vibrations or magnetic fields

Problems and Solutions

Refer to this list of problems and possible solutions before calling your dealer for help.

Camera problems

The following are problems that you may encounter while using your camera.

The camera has no power.

The camera may have shut off automatically. To turn the power back on, press the POWER button. Alternatively, you can turn the camera back on by pressing the shutter button, or pressing a button on the back of the camera, depending on the camera's dial switch position. See "Turning the camera back on" on page 4-20 for more details.

Make sure that the batteries are installed correctly. See "Installing the batteries" on page 1-5. Also, make sure that you are using appropriate batteries and that they are charged. See "Replacing the batteries" on page 1-6 and replace the batteries if necessary.

If you are using the AC adapter, make sure that it is plugged into a working outlet.

You cannot see clearly through the viewfinder.

Adjust the diopter by turning the correction dial next to the viewfinder. The dial switch must be set to ; otherwise you will be unable to adjust the diopter.

The camera does not take a picture when you press the shutter button.

The flash may be recharging. Wait until the indicator light beside the viewfinder turns green, then try again.

Make sure that the memory card is installed correctly. To install a memory card, see "Installing and removing a CompactFlash Card" on page 1-11.

The camera's memory card may be full. Check the picture counter on the display panel. If it reads 0 (zero), your memory card is full. Erase some pictures using the LCD monitor, or transfer the pictures to your computer and then erase them.

Note:

To erase pictures using the LCD monitor, see "Erasing images" on page 3-7. To transfer pictures to your computer before erasing them, see the EPSON Digital Camera Software User's Guide.



The camera may be connected to your computer. When it is connected, you cannot use any of the buttons on the camera itself. See the EPSON Digital Camera Software User's Guide for instructions on taking pictures using your computer.

The camera takes too long to take a picture.

You may be pressing the shutter button all the way down at once. This forces the camera to focus, make exposure adjustments, and capture the image all at the same time. To make the process more efficient, you can have the camera perform these operations separately. First, depress the shutter button halfway to lock the auto focus, then press the shutter button the rest of the way down to take the photo. For more information, see “Taking Pictures Using the Viewfinder” on page 2-6, or “Taking Pictures Using the LCD monitor” on page 2-9.

If you want to take pictures quickly in succession, use the continuous shooting feature. This feature allows you to take up to ten pictures in succession before the camera saves them to the memory card. See “Using the continuous shooting feature” on page 2-15.

The flash does not work.

Make sure that your flash is not set to . Also, when using the  automatic flash setting, the flash only fires when there is insufficient light. See “Setting the flash” on page 4-4 for details on setting the flash.

Make sure that the batteries are installed correctly. See “Installing the batteries” on page 1-5. Also, make sure that you are using appropriate batteries and that they are charged. See “Replacing the batteries” on page 1-6.



Note:

When you use the continuous shooting feature or take video clips, the flash is disabled.

The lens is still protruding even though the camera is turned off.

The camera may have shut off automatically. If the lens is protruding when the shut-off feature turns off the camera, the lens does not retract. To retract the lens, press the POWER button once to turn the camera back on, then again to turn the camera off.

The batteries may be low. Use the optional AC adapter, or replace the batteries with new or recharged batteries, then turn the camera on and off again. The lens retracts.

Nothing appears on the LCD monitor when the camera's dial switch is set to , , or .

Make sure that the batteries are installed correctly. See "Installing the batteries" on page 1-5. Also, make sure that you are using appropriate batteries and that they are charged. See "Replacing the batteries" on page 1-6.



The camera may have shut off automatically. Press the POWER button to turn the camera back on. Alternatively, you can turn the camera back on by pressing the shutter button or an LCD monitor button, depending on your camera's dial switch position. See "Turning the camera back on" on page 4-20 for more details.

Note:

The LCD monitor shuts off automatically when you use EPSON Photo!4.

The image on the LCD monitor is too dark, or is not visible at all.

Adjust the brightness of the LCD monitor, following the instructions in "Setting the LCD monitor's brightness level" on page 4-20.

Make sure that the dial switch is set to , , or .

Note:

The LCD monitor shuts off automatically when you use EPSON Photo!4.

You cannot take certain kinds of pictures or make the settings that you want when using the LCD monitor.

Some of the camera's settings and features cannot be used at the same time. For example, you cannot use the continuous shooting feature and the HyPict image quality setting at the same time. For instructions on making camera settings, see Chapter 4, "Making Settings."

To adjust the white balance, exposure, and sensitivity settings, you must first select the Program or Manual camera mode. See "Making camera mode settings" on page 4-6.

Nothing appears on the TV monitor when the camera is connected to your television.

Make sure that the AV cable is connected correctly. For details, see “Viewing Pictures on a Television” on page 3-9.

Make sure that the camera is on and that the dial switch is turned to .

Make sure that the television is switched to video mode.

Make sure that the batteries are installed correctly. See “Installing the batteries” on page 1-5. Also, make sure that you are using appropriate batteries and that they are sufficiently charged. See “Replacing the batteries” on page 1-6.

Your camera may not be compatible with local television broadcasting standards. Select either the NTSC or PAL signal system to match the television broadcasting standards in your country. See “Selecting the signal system and language” on page 4-21 for details.

Note:

Also, see your television documentation for possible solutions.

You cannot take a picture with the camera when a memory card is installed.

Check your camera’s LCD monitor for messages. If a message instructs you to format or eject the card, do so. To format the memory card, see “Formatting memory cards” on page 6-3. To remove the card, see “Installing and removing a CompactFlash Card” on page 1-11.

Your memory card may be full. Check the picture counter on the display panel. If it reads 0 (zero), the memory is full. In this situation, insert a different card, erase some pictures using the LCD monitor, or transfer the pictures to your computer and then erase them.

Note:

To erase pictures using the LCD monitor, see “Erasing images” on page 3-7. To transfer pictures to your computer before erasing them, see the online EPSON Digital Camera Software User’s Guide.

Even after you take a picture, the number on the display panel stays the same.

This number shows how many more pictures you can take. The number may not change, depending on the image quality or the complexity of the photos you take.

Picture problems

If you are not satisfied with the pictures that you get from your PhotoPC 3100Z, you may need to adjust some of the camera's settings, or you may need to brush up on your photography techniques. Try the suggestions listed below.

The picture on the computer screen and/or printout differs in quality from the image displayed on the LCD monitor.

The PhotoPC 3100Z captures images in 24-bit color (16 million colors). Your pictures will not be displayed at maximum image quality if your monitor or your computer's video controller does not support this color depth. You may need to upgrade your system to achieve the best possible image quality.

If the image on the LCD monitor and computer screen are different, check the gamma correction and color correction settings. Try a different combination of these settings.

If your pictures look better on the computer screen or LCD than when you print them out, you may need to upgrade your printer. EPSON color ink jet printers provide excellent image quality.





Your picture is blurry or out of focus.

Make sure that your subject is within the camera's effective range. While the sensitivity is set to standard, make sure that you are at least 50 centimeters away from the subject when taking a picture without the flash. When you use the built-in flash, make sure that you are within the effective flash range of 50 to 420 centimeters for a wide-angle shot, and 50 to 340 centimeters for a telephoto shot. When using the macro feature, you can position the camera 20 to 50 centimeters away from the subject when using the flash, or 6 to 50 centimeters when not using the flash.

Observe the following:

- Make sure that the subject is not moving.
- Hold the camera steady while the image is being captured.
- Make sure that your flash is not set to .
- Center your subject in the LCD monitor. When you take photos using the viewfinder, center your subject in the cross-hairs.

Your picture is too dark (underexposed).

You may need to use the flash. Set the flash to , , , or , following the instructions given in “Setting the flash” on page 4-4.

When you use the built-in flash, make sure that you are within the effective flash range of 50 to 420 centimeters for a wide-angle shot, and 50 to 340 centimeters for a telephoto shot. When the sensitivity is set to standard and you are using the macro feature, stay 20 to 50 centimeters away from the subject.



If you need more light, attach a high capacity flash (sold separately as a camera accessory) to your PhotoPC 3100Z. For more details, see “Selecting the internal or external flash” on page 4-18. For instructions on using an external flash, see the documentation for the flash.

You can adjust the exposure to make your photos brighter. See “Making exposure settings” on page 4-11.

Use image-editing software to adjust the picture's brightness and contrast.

If you are using the macro feature to take close-up photos, be sure to provide adequate lighting for your subject, since the camera's aperture is automatically set to the smallest setting.

Your picture is too light (overexposed).

If you are using the  forced flash setting, the flash may be too bright. Try setting the flash to the  automatic setting. See “Setting the flash” on page 4-4.

You can adjust the exposure manually to make your photos darker. For instructions, see “Making exposure settings” on page 4-11.

When you use the flash and the macro function together, you may find that your pictures come out too light, since the flash is close to the subject. In this case, try setting the flash to .

If you are facing a bright light source, you may need to take your picture from a different angle.

You can adjust the exposure to make your photos brighter. See “Making exposure settings” on page 4-11.

Use image-editing software to adjust the picture's brightness and contrast.

When you use the external flash, EPSON recommends setting the camera to Manual camera mode to get the correct exposure.

Part of your picture is missing.

Make sure that you are not blocking the lens with your finger, the strap, clothing, or other objects.

A horizontal or vertical red line appears on your picture.

Red lines are caused by glare. Avoid photographing very shiny surfaces that reflect light into your lens.

The wrong date and/or time is displayed on your camera.

If you remove the batteries from your camera for a certain time period, you will need to reset the clock. See "Setting the time and date" on page 4-19 to set the clock using the LCD monitor. You can also set the clock using your computer. For instructions, see the *online EPSON Digital Camera Software User's Guide*.

The color in your photos does not look right.

When you take pictures under certain artificial lighting conditions, the colors may be slightly distorted. You can use image-editing software to adjust the color.

When you want to get more realistically colored images (for example, reddish images at dusk), set the white balance to FIX. For instructions, see "Adjusting the white balance setting" on page 4-9.

Your pictures do not look as good as they used to.

Your camera's lens may be dirty or dusty. Try cleaning it, following the instructions in "Cleaning the camera" on page 7-2.

The area captured in the photo is different from what you saw in the viewfinder.

Take care to look straight through the viewfinder.

When taking photos using the macro feature, be sure to use the LCD monitor rather than the viewfinder to frame your subject.

Keep in mind that the area visible through the viewfinder is slightly smaller than the area captured in the actual photo.

Specifications

Camera

Model G790A

Physical dimensions

Width	108 mm
Height	89 mm
Depth	65 mm
Weight	358 g (without batteries, strap, lens cover, and memory card)
Temperature	Operating: 5 to 35°C Non-operating: -20 to 60°C
Humidity (non-condensing)	Operating: 30% to 80% Non-operating: 10% to 80%

Product type

Type	Digital still AF camera with LCD monitor
CCD	1/1.8 inch color area CCD (3.3 megapixels)
Zoom	Optical ×3 zoom Digital ×2 zoom
LCD monitor	1.8-inch TFT color LCD monitor (approximately 110 K pixels)
Internal ROM	2 MB (program memory only)
Memory card	CompactFlash Card

Recorded image

Data types

JPEG image following Exif Ver.2.1 and recorded based on Design rule for camera file system (16 million colors, 24 bit)

Note:

Exif is a standard format for audio/image files. Design rule for camera file system is a recording standard for image files. These standards have been established by the Japan Electronics and Information Technology Industries Association (JEITA).

TIFF image

Image quality modes
(image size)

HyPict
2544 × 1904 pixels

HyPict TIFF
2048 × 1536 pixels

Super fine
2048 × 1536 pixels

Fine
1600 × 1200 pixels

Standard
640 × 480 pixels

Alternative formats

Monochrome, macro, digital ×2 zoom, continuous shooting, and slow flash

Optical

Lens	f = 7 - 21 mm (equivalent to a 34 - 102 mm lens on a 35 mm camera) F2 (7 mm) - F2.5 (21 mm)
Focal length	0.5 m to infinity 0.2 m to 0.5 m (macro mode) From 0.06 m (macro mode, wide)
Focus	Auto/manual focus
Sensitivity	Equivalent to ISO 100/200/400
Aperture	F2.0, F2.3, F2.8, F4.0, F5.6, F8.0
Shutter	Mechanical shutter of 8 to 1/1000 seconds with electric iris
Exposure control	Divided brightness metering program auto, spot metering program auto, and manual exposure adjustment (-2 EV to +2 EV, 9 or 21 steps)
White balance	TTL automatic white balance Fixed (sunlight) User defined
Viewfinder	Real-image optical (view range approx. 83%)

Self timer	Ten seconds
Flash	Built-in automatic luminance control flash (an external flash, which is sold separately, can be attached)
Flash modes	Automatic, red-eye reduction, forced flash, flash off, and leading or trailing slow synchro

Built-in flash range

Sensitivity setting	Range (Wide)	Range (Telephoto)
ISO 100	0.5 - 4.2 m	0.5 - 3.4 m
ISO 200	0.5 - 5.9 m	0.5 - 4.8 m
ISO 400	0.5 - 8.4 m	0.5 - 6.7 m

Functional

Photo processing time in seconds (approximate)

Image quality mode	Photo processing time	Photo processing time for playback
Standard	0.7	0.5
Fine	1.0	0.5
Super fine	1.0	0.5
HyPict JPG*	18	0.5
TIFF	22	0.5

* For HyPict JPG, the processing time varies depending on the subject of the photograph.

Interface

USB	Max. 12 Mbps (for the USB cable)
Video out	NTSC or PAL

Power

Sources	DC 1.2 V × 4 (4.8 V) Ni-MH batteries Model EU-24
	DC 1.5 V × 4 (6.0 V) Alkaline batteries Model IEC LR6
	DC 7.0 V Optional AC Adapter Model EU-40

Battery life
(when using the four included alkaline batteries and taken under conditions determined by EPSON)

Taking photos using the View Finder	Approx. 4,000 pictures
Taking photos using the LCD monitor (with automatic shut-off set to 30 seconds)	Approx. 155 pictures
Playing back photos	Approx. 210 min.

Battery Charger

Model EU-38

Input	AC 100 - 240 V, 50 - 60 Hz
Output	DC 1.2 V 490 mA × 4
Compatible batteries	EPSON Ni-MH Batteries (Model EU-24)
Charging time	Max. 240 min.
Power consumption	8 W
Charging temperature	5 to 35°C
Dimensions	76 × 115 × 28 mm
Weight	Approx. 130 g

Battery

Model EU-24

Type name	Cylindrical sealed Nickel-Metal Hydride rechargeable battery
Type	SBA HR6 IEC HR15/51
Size	AA / IEC LR6 compatible
Ratings	DC 1.2 V

Temperature	Charging: 5 to 35°C Storage: -20 to 30°C
Humidity	45 to 85% RH
Weight	Approx. 25 g per cell

CompactFlash Card

Model ECFD-16

Storage capacity	16 MB
------------------	-------

Note:

For information about the availability of CompactFlash Cards, contact your EPSON dealer.

Physical Dimensions:

Width	42.8 mm
Height	36.8 mm
Depth	3.3 mm

A

Optional PCMCIA Adapter

Interface	PCMCIA PC Card ATA
Card slot type	Type II
Physical Dimensions:	
Width	54.0 mm
Height	85.6 mm
Depth	5.0 mm

Optional AC Adapter

Model EU-40





Input	AC 100 - 240 V, 50 - 60 Hz
Output	DC 7.0 V, 2.0 A
Power consumption	Max. 0.4 A, 19 W
Physical Dimensions:	
Width	43 mm
Height	31 mm
Depth	104 mm
Weight	Approx. 210 g (Without AC power cord)

Dial Position Settings

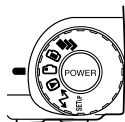
The PhotoPC 3100Z has six dial positions. This appendix shows the available settings in each dial position.

Dial switch positions



-  For taking multiple exposures
-  For taking photos using the LCD monitor
-  For taking photos using the viewfinder
-  For playing back and managing photos
-  For using EPSON Photo!4, EPSON Auto Downloader, and EPSON PhotoQuicker software and making print settings
- SETUP** For viewing information and setting up the camera

Display panel

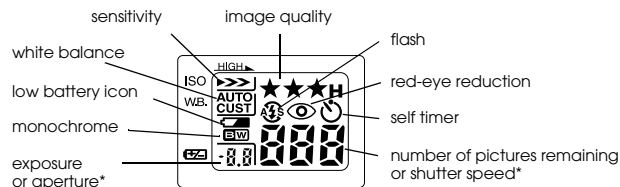

* When in the Program or Manual camera mode and shutter is pressed halfway.

Image quality settings (not available for video clips)



* Cannot be selected when using the stitch assist or continuous shooting feature.

Flash settings

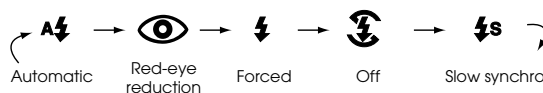

- When using the the continuous shooting feature, the external flash, or when taking video clips, the flash is automatically set to **S**.
- When in the Full Auto camera mode, slow synchro is disabled.

Available Settings in the SETUP Dial Position

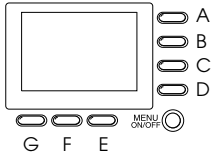

*Button name key
(for this appendix only)*

Setting	Button Sequence
Month, day, year, hour, and minutes (See page 4-19)	<ol style="list-style-type: none"> 1. Press A. 2. Press A to change the order of the date display. 3. Press B or C to make setting for current item. 4. Press E or F to change item. 5. Repeat steps 2 and 3 as necessary. 6. Press G when finished.
Language (See page 4-21)	<ol style="list-style-type: none"> 1. Press F. 2. Press E or F to highlight language. 3. Press G.
Camera mode (See page 4-6)	Press B to select Full Auto, Program, or Manual.
Color/monochrome (See page 4-7)	Press C to select Color or Monochrome.
Basic playback feature (See page 2-10)	<ol style="list-style-type: none"> 1. Press D, then A to turn feature on/off. 2. Press G.

Setting	Button Sequence
Slow synchro timing (See page 4-17)	Press B to select Manual or Program, then press D. Press C to select Trailing or Leading. Press G.
External flash (See page 4-18)	<ol style="list-style-type: none"> 1. Press B to select Manual. Press D. 2. Press C to select Ext Flash. 3. Press G.
TIFF/HyPict (JPEG) selection (See page 4-4)	<ol style="list-style-type: none"> 1. Press D. 2. Press E to select JPEG or TIFF, then G.
Custom white balance (See page 4-10)	<ol style="list-style-type: none"> 1. Press D, then F, then D. 2. Press the shutter button, then G.
Format memory card (See page 6-3)	<ol style="list-style-type: none"> 1. Press E. 2. Press A, then D, then G.
TV signal system (See page 4-21)	<ol style="list-style-type: none"> 1. Press F, then A to select NTSC or PAL. 2. Press G.
Shut-off feature (See page 4-20)	<ol style="list-style-type: none"> 1. Press G. 2. Press A to change setting. Press G.
LCD monitor brightness (See page 4-20)	Press G. Press B or C to adjust, then press G.
Speaker volume (See page 4-21)	<ol style="list-style-type: none"> 1. Press G. 2. Press D to select high or low. Press G.
Beep/shutter sound (See page 4-21)	<ol style="list-style-type: none"> 1. Press G, then press E to select Always, Shutter, or Never. 2. Press G.

Available Settings in the ↖ ↗ Dial Position

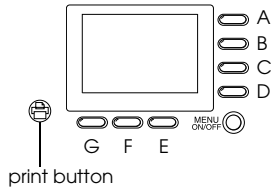

Button name key
(for this appendix only)

Setting	Button Sequence
Number of prints for currently displayed photo (See page 4-23)	<ol style="list-style-type: none"> 1. Press B or C to choose photo. 2. Press print button to increase number of prints.

Note:

To make settings in this dial position, you must first select an image for printing. For more information about selecting images for printing, see “Selecting images and specifying the number of prints” on page 4-23.

Setting	Button Sequence
Index print (See page 4-24)	Press G to select Index On.
Print sharpness (See page 4-24)	<ol style="list-style-type: none"> 1. Press E. 2. Press A to select Std., High, or Low. 3. Press G.
Print brightness (See page 4-24)	<ol style="list-style-type: none"> 1. Press E. 2. Press D to select Std., High, or Low. 3. Press G.

Available Settings in the Dial Position

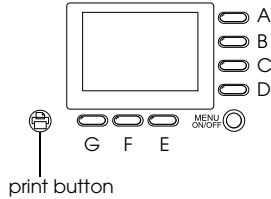

Button name key
(for this appendix only)

Setting	Button Sequence
Magnify photo (See page 3-2)	1. Press, or press and hold T button to magnify. 2. Use W button zoom out.
View different photo (See page 3-1)	Press B or C.
Erase all photos (See page 3-7)	Press A, then press D.
Erase current photo (See page 3-7)	Press D, then press A.
View multiple images (See page 3-1)	Press F as many times as necessary.
View photo information (See page 3-4)	1. Press G, then press A. 2. When finished, press G twice.

Setting	Button Sequence
Play back video clip (See page 3-5)	1. Press G, then press D. 2. Press B or C to choose clip. 3. Press A to play clip. 4. When finished, press G three times.
Erase video clip (See page 3-8)	1. Press G, then press D. 2. Press B or C to choose clip. 3. Press D, then A to erase clip. 4. When finished, press G twice.
Make audio recording for existing photo (See page 2-21)	1. Press G, then E. 2. Press B or C to choose photo. 3. Press A to begin recording, and G to stop. 4. When finished, press G twice.
Play audio recording (See page 2-21)	1. Press G, then E. 2. Press B or C to choose photo. 3. Press D to play recording. 4. When finished, press G twice.
Delete audio recording (See page 3-7)	1. Press G, then E. 2. Press B or C to choose photo. 3. Press E, then A. 4. When finished, press G twice.
View slide show (See page 3-3)	1. Press G, then F. 2. Press D to start slide show.
Specify number of prints (See page 4-23)	1. Press B or C to choose photo. 2. Press print button to increase number of prints.

Available Settings in the Dial Position

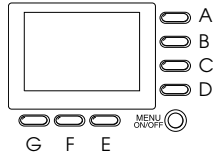

Button name key
(for this appendix only)

Note:

To make settings in this dial position, you must first press the MENU ON/OFF button to turn on the LCD monitor. When finished making settings, press the button again to turn the LCD monitor off.

When using the Program camera mode

Setting	Button Sequence
Basic exposure adjustment (See page 4-11)	Press B or C to change the exposure value.
White balance (See page 4-9)	Press E to select AUTO, FIX, or CUSTOM.
Sensitivity (See page 4-8)	Press F repeatedly to cycle through settings.
Predefined exposure (See page 4-13)	Press G to select Normal, Sports, Portrait, or Landscape.

When using the Manual camera mode

Setting	Button Sequence
Advanced exposure (See page 4-14)	<ol style="list-style-type: none"> 1. Press A to select Auto Exposure or Aperture Priority. 2. Press B and C to change exposure value.
Aperture (See page 4-15)	<ol style="list-style-type: none"> 1. Press A to select Aperture Priority. 2. Press E or F to change aperture value.
Manual focus (See page 4-8)	<ol style="list-style-type: none"> 1. Press A to select Auto Exposure or Aperture Priority, then press G. 2. Press B or C to change focus setting. 3. Press G.
Metering system (See page 4-16)	<ol style="list-style-type: none"> 1. Press A to select Auto Exposure or Aperture Priority, then press G. 2. Press D to select spot or divided brightness metering system. 3. Press G.
White balance (See page 4-9)	<ol style="list-style-type: none"> 1. Press A to select Auto Exposure or Aperture Priority, then press G. 2. Press E to select Auto, Fix, or Custom. 3. Press G.
Sensitivity (See page 4-8)	<ol style="list-style-type: none"> 1. Press A to select Auto Exposure or Aperture Priority, then press G. 2. Press F to change the sensitivity setting. 3. Press G.

Available Settings in the Dial Position

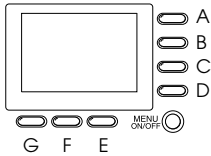

Button name key
(for this appendix only)

When using the Program camera mode

Setting	Button Sequence
Macro (See page 2-13)	Press D until  ON is displayed.
Basic exposure (See page 4-11)	Press B or C to change exposure value.
White balance (See page 4-9)	Press E to select AUTO, FIX or CUSTOM.
Sensitivity (See page 4-8)	Press F to change the sensitivity setting.
Predefined exposure setting (See page 4-13)	Press G to select Normal, Sports, Portrait, or Landscape.

When using the Manual camera mode

Setting	Button Sequence
Macro (See page 2-13)	Press D until  ON is displayed.
Shutter speed (See page 4-16)	1. Press A to select Manual Exposure. 2. Press B or C to change shutter speed.
Advanced exposure (See page 4-14)	1. Press A to select Auto Exposure or Aperture Priority. 2. Press B or C to change the exposure.
Aperture (See page 4-15)	1. Press A to select Aperture Priority or Manual Exposure. 2. Press E or F to change the aperture value.
Manual focus (See page 4-8)	1. Press G. 2. Press B or C to change focus setting. 3. Press G.
Metering system (See page 4-16)	1. Press G. 2. Press D to select spot or divided brightness metering system 3. Press G.
White balance (See page 4-9)	1. Press G, then press E to select Auto, Fix, or Custom. 2. Press G.
Sensitivity (See page 4-8)	1. Press G, then press F to change the sensitivity setting. 2. Press G.

Glossary

application

A software program that helps you carry out a particular task, such as word processing, image editing, or financial planning.

bit

Short for binary digit. The smallest unit of data in computer processing. A bit can represent two values: on and off, or 1 and 0.

default

A value or setting that takes effect when the equipment is turned on, reset, or initialized. Also known as a factory setting.

Design rule for camera file system

Recording standard for image files. Established by the Japan Electronics and Information Technology Industries Association (JEITA).

DPOF

Digital Print Order Format. Settings for the number of prints and for index prints are saved in a DPOF file on the camera's memory card. You can apply these settings when using a printer or printing application that supports the DPOF standard.

Exif2.1

Standard format for audio/image files. Established by the Japan Electronics and Information Technology Industries Association (JEITA).

exposure

The amount of light the camera captures when a photo is taken.

image

Data representing a two-dimensional scene. A digital image is composed of pixels arranged in a rectangular array with a certain height and width. Each pixel may consist of one or more bits of information, representing the brightness of the image at that point.

ink jet printer

A printer that transfers ink onto paper by spraying ink through a number of small nozzles.

interface

A piece of hardware, a method, or a standard used to connect the computer and the camera.

JPEG

A file format for storing color and grayscale images in compressed files. Data saved using the JPEG format generally receives greater compression than data saved using TIFF and other formats. See also *TIFF*.

macro

An enlargement or a close-up of an image.

NTSC

National Television Standards Committee. A video encoding standard primarily used in North America and Japan.

PAL

Phase Alternation Line. A video encoding standard primarily used in Europe and Australia.

pixel

Short for picture element. Each image is composed of a number of pixels. Pixels are also counted in units of dots.

port

An interface channel through which data is transmitted between devices.

PRINT Image Matching

A new standard that allows digital cameras to record special information about the photos it takes and relay that information seamlessly to a printer compatible with this standard. This information can be used by printers that support the PRINT Image Matching system for enhanced printing results.

resolution

An indication of how finely an image is resolved into pixels. See *pixel*.

thumbnails

Small representations of images.

TIFF

A file format for storing color and grayscale images in files with little or no data compression. (TIFF files made with the PhotoPC 3100Z receive no data compression.) Saving data in the TIFF format results in files that are larger and have finer image quality than image files with greater data compression, such as JPEG and other format files. See *JPEG*.

white balance

The balance between the whiteness and color in your image. When the white balance is fixed to the environment where the picture is taken, the colors in your images appear more like those seen by the eye.

zoom

To show a smaller area of an image at a higher magnification (zoom in) or a larger area at a lower magnification (zoom out).

Index

A

- AC adapter
 - connector, 1-2
 - specifications, A-6
 - using, 6-5 to 6-6
- Accessory lens, 6-6
- Acrobat Reader
 - installing in Windows, 5-3
 - installing on your Macintosh, 5-7
- Activating the shutter, 2-6, 2-10
- Alkaline batteries, 1-2
- Aperture priority, 4-15
- Attaching the strap, 1-9
- Audio recordings, 2-3, 2-19 to 2-22, 3-7, 6-2
- Auto exposure, 4-14
- Automatic flash, 4-5
- Automatic shut-off feature, 4-20, 5-9
- AV connector, 1-2

B

- Basic playback feature, 2-10 to 2-12
- Batteries
 - checking, 1-6
 - disposing of, 1-9
 - handling, 1-7
 - installing, 1-5
 - low battery icon, 1-4
 - replacing, 1-6

- specifications, A-5
- storing, 1-8
- Battery charger
 - specifications, A-5
- Battery cover
 - location, 1-3
 - release button, 1-3, 1-5
- Beep and shutter sound, 2-7, 2-10, 4-21
- Brightness
 - LCD monitor, 4-20
 - print quality, 4-24
- Buttons
 - flash, 1-3, 4-4 to 4-6
 - image quality, 1-3, 4-1 to 4-3
 - location, 1-3
 - MENU ON/OFF, 1-3, 2-9, 4-1, B-5
 - naming, 2-5
 - POWER, 1-3, 2-2
 - print, 1-3, 4-23
 - self timer, 1-3, 2-8 to 2-9
 - shutter, 1-2, 1-3, 2-6, 2-10
 - zoom, 1-3, 2-7, 2-12
- Buttons location, 1-2

C

- Cables
 - AV, 1-2
 - USB, 1-2

Camera

- buttons, 1-2 to 1-3
- cleaning, 7-2
- connecting to a projector, 3-10
- connecting to a television, 3-9
- connecting to your computer, 5-9
- disconnecting from a Macintosh, 5-12
- disconnecting from your computer in Windows 2000, 5-11
- disconnecting from your computer in Windows Me and 98, 5-11
- handling, 7-1
- parts, 1-2 to 1-5
- physical dimensions, A-1
- problems, 7-3 to 7-6
- storing, 7-2
- turning on and off, 2-2

Camera buttons

- flash, 1-3, 4-4 to 4-6
- image quality, 1-3, 4-1 to 4-3
- MENU ON/OFF, 1-3, 2-9, 4-1, B-5
- naming, 2-5
- POWER, 1-3, 2-2
- print, 1-3, 4-23
- self timer, 1-3, 2-8 to 2-9
- shutter, 1-2, 1-3, 2-6, 2-10
- zoom, 1-3, 2-7, 2-12

Camera case, 1-2

Camera indicator lights, 5-10

Camera modes

- changing, 4-7
- Full Auto, 4-6
- making settings, 4-6 to 4-7
- Manual, 4-7, 4-9
- Program, 4-6, 4-9

Checking

- batteries, 1-6
- picture counter, 2-3, 7-3, 7-6

Cleaning the camera, 7-2

Color/monochrome setting, 4-7

CompactFlash Card

- copying images from card to computer, 5-13
- formatting, 6-3
- installing in camera, 1-11 to 1-12
- installing in computer, 6-2
- removing from camera, 1-12
- selecting a folder, 3-5
- specifications, A-5
- storage capacity, 6-1

Connecting the camera to your computer, 5-9

Continuous shooting, 2-15

Copying images

- directly from the memory card, 5-13
- using EPSON digital camera software, 5-12, 5-13

Cover

- battery, 1-3
- memory card, 1-3

D

Date and time setting, 1-13, 4-19

Dial switch

- connecting position, 4-24, 5-9 to 5-10, B-3
- LCD monitor position, 2-9 to 2-13, 4-1 to 4-18, B-6
- location, 1-2, 1-3
- multiple exposures position, 2-13 to 2-19
- playing back position, 3-1 to 3-10, 4-23, B-4
- positions, 2-4, B-1

- setting up position, 4-3 to 4-7, 4-10, 4-17, 4-19 to 4-22, B-2
- viewfinder position, 2-6 to 2-9, 4-1 to 4-18, B-5
- Digital zoom, 2-12
- Diopter correction, 1-2, 2-6
- Disconnecting the camera
 - from a Macintosh, 5-12
 - from your computer in Windows 2000, 5-11
 - from your computer in Windows Me and 98, 5-11
- Display panel
 - icons, 1-4
 - location, 1-2
- Disposing of batteries, 1-9
- Divided brightness metering system, 4-17
- DPOF file, 4-22

E

- EPSON AutoDownloader
 - installing in Windows, 5-3
 - installing on your Macintosh, 5-5
- EPSON CameraStarter
 - features, 5-7
 - installing in Windows, 5-3
 - installing on your Macintosh, 5-5
- EPSON CardMonitor
 - installing in Windows, 5-3
 - installing on your Macintosh, 5-5
- EPSON File Converter
 - installing in Windows, 5-3
 - installing on your Macintosh, 5-5
- EPSON Photo!4
 - installing in Windows, 5-3
 - installing on your Macintosh, 5-5

- EPSON PhotoQuicker
 - accessing the User's Guide, 5-15
 - installing in Windows, 5-3
 - installing on your Macintosh, 5-5
- Erasing
 - all the photos, 3-7
 - audio recordings, 3-7
 - individual photos, 3-7
 - video clips, 3-8
- Exposure
 - adjusting, 4-11 to 4-16
 - aperture priority, 4-15
 - auto exposure, 4-14
 - manual exposure, 4-16
 - predefined settings, 4-13
 - shutter priority, 4-15
- External flash
 - attachment, 1-2
 - installing, 4-18
 - selecting, 4-18

F

- File formats
 - JPEG, 4-4, 5-13
 - MOV, 5-13
 - TIFF, 4-4, 5-13
 - WAV, 5-13
- Fine image quality setting, 4-2
- Flash
 - button, 1-3
 - location, 1-2
 - range, A-3

selecting internal or external, 4-18

settings, 4-4 to 4-6

Forced flash, 4-5

Formatting memory cards, 6-3

Full Auto camera mode, 4-6

H

Hot shoe, 1-2

HyPict image quality setting, 4-3

I

Icons

divided brightness metering system, 4-17

flash, 1-4

image quality, 1-4

low battery, 1-4, 1-6

monochrome, 1-4

red-eye reduction, 1-4

self timer, 1-4

sensitivity, 1-4

spot metering system, 4-17

Image compression settings, 4-3

Image quality

button, 1-3

settings, 4-1 to 4-3

Index print, 4-24

Indicator lights, 1-3, 1-4, 2-6, 2-7, 2-10, 5-10

Installing

Acrobat Reader in Windows, 5-3

Acrobat Reader on your Macintosh, 5-7

batteries, 1-5

CompactFlash Card in camera, 1-11 to 1-12

EPSON AutoDownloader in Windows, 5-3

EPSON AutoDownloader on your Macintosh, 5-5

EPSON CameraStarter in Windows, 5-3

EPSON CameraStarter on your Macintosh, 5-5

EPSON CardMonitor in Windows, 5-3

EPSON CardMonitor on your Macintosh, 5-5

EPSON File Converter in Windows, 5-3

EPSON File Converter on your Macintosh, 5-5

EPSON Photo!4 in Windows, 5-3

EPSON Photo!4 on your Macintosh, 5-5

EPSON PhotoQuicker in Windows, 5-3

EPSON PhotoQuicker on your Macintosh, 5-5

Panorama Stitcher Light EP in Windows, 5-3

Panorama Stitcher Light EP on your Macintosh, 5-5

QuickTime 4 in Windows, 5-3

QuickTime 4 on your Macintosh, 5-6

Software in Windows, 5-3

Software on your Macintosh, 5-5

USB driver in Windows, 5-3

USB driver on your Macintosh, 5-5

Interface

connector, 1-2

specifications, A-4

Internal flash, 4-18

J

JPEG file format, 4-4, 5-13

L

Languages, 1-12, 4-21

LCD monitor

location, 1-3

- using to take pictures, 2-9 to 2-13
- LCD monitor buttons, 1-3
 - names, 2-5
 - using, 2-5
- Lens, 1-2
- Lens adapter, 1-2, 6-6
- Lights
 - indicator, 1-3, 1-4, 2-6, 2-7, 2-10
 - timer, 1-2, 2-8
- Locking photos, 3-6
- Low battery icon, 1-4

M

- Macro feature, 2-13
- Maintenance, 7-1
- Manual camera mode, 4-7, 4-9
- Manual exposure, 4-16
- Manual focus settings, 4-8
- Memory card, *See* CompactFlash Card
- MENU ON/OFF button, 1-3, 2-9, 4-1, B-5
- Metering system settings, 4-16
- Microphone, 1-3
- Monochrome/color setting, 4-7
- MOV file format, 5-13
- Multi-photo playback, 3-1 to 3-2

N

- Ni-MH rechargeable batteries, 6-4
- NTSC, 4-21
- Number of prints, settings, 4-23

O

- Optical specifications, A-3
- Optical zoom, 2-7
- Options
 - AC adapter, 6-5 to 6-6, A-6
 - available options, 2
 - lens adapter, 6-6
 - Ni-MH rechargeable batteries, 6-4
 - PCMCIA adapter, 6-2, A-6
 - Power Pack, 6-4
- Overlapping photos, *See* Stitch assist feature

P

- PAL, 4-21
- Panorama Stitcher Light EP
 - installing in Windows, 5-3
 - installing on your Macintosh, 5-5
- PCMCIA adapter
 - specifications, A-6
 - using, 6-2
- Photographs, *See* Pictures
- Photo information, 3-4
- Photo processing time, A-4
- Physical dimensions, A-1
- Picture counter, 2-3
- Pictures
 - close-ups, 2-13
 - copying directly from the memory card, 5-13
 - copying using EPSON digital camera software, 5-12
 - erasing, 3-7
 - locking, 3-6
 - memory storage capacity, 4-2

- problems, 7-7 to 7-9
- processing time, A-4
- recorded image specifications, A-2
- shooting range, 2-2
- taking using the LCD monitor, 2-9 to 2-13
- taking using the viewfinder, 2-6 to 2-7
- unlocking, 3-6
- Playing back audio recordings
 - with the built-in speaker, 2-21
- Playing back photos
 - multiple photos at once, 3-1 to 3-2
 - on the LCD monitor, 3-1 to 3-4
 - using a projector, 3-10
 - using a television, 3-9
 - using the magnification feature, 3-2
 - when taking photos with the LCD monitor, 2-10 to 2-12
- Playing back video clips, 3-5
- POWER button, 1-3, 2-2
- Power specifications, A-4
- Print button, 1-3, 4-23
- PRINT Image Matching, 4-22
- Print settings
 - brightness, 4-24
 - index print, 4-24
 - number of prints per image, 4-23
 - sharpness, 4-24
- Problems
 - camera, 7-3 to 7-6
 - picture, 7-7 to 7-9
- Program camera mode, 4-6, 4-9
- Projector, connecting to the camera, 3-10

Q

- QuickTime 4
 - installing in Windows, 5-3
 - installing on your Macintosh, 5-6

R

- Rechargeable batteries, 6-4
- Recording audio
 - for existing photos, 2-21
 - immediately after taking photos, 2-20
- Red-eye reduction, 4-5
- Removing CompactFlash Card from camera, 1-12
- Replacing batteries, 1-6

S

- Safety information for UK users, 7
- Safety instructions
 - when using the batteries, 5 to 6
 - when using the camera, 4 to 5
 - when using the strap, 5
- Self timer
 - button, 1-3
 - light, 1-2
 - using, 2-8 to 2-9
- Sensitivity setting, 4-8
- Setting indicators
 - aperture, 1-4
 - checking the display panel, 2-3
 - white balance, 1-4
- Settings
 - automatic shut-off feature, 4-20

- available in Full Auto camera mode, 4-6
- available in Manual camera mode, 4-7, 4-9
- available in Program camera mode, 4-6, 4-9
- beep and shutter sound, 4-21
- color/monochrome, 4-7
- custom white balance, 4-10
- date and time, 1-13, 4-19
- exposure, 4-11 to 4-16
- flash, 4-4 to 4-6
- image compression, 4-3
- image quality, 4-1 to 4-3
- index print, 4-24
- internal or external flash, 4-18
- language, 1-12, 4-21
- LCD monitor brightness, 4-20
- manual focus, 4-8
- metering system, 4-16
- number of prints per image, 4-23
- predefined exposure, 4-13
- print brightness, 4-24
- print sharpness, 4-24
- sensitivity, 4-8
- signal system, 4-21
- speaker volume, 4-21
- white balance, 4-9

Sharpness, 4-24

Shut-off feature, 4-20

Shutter button

- location, 1-2, 1-3
- using, 2-6, 2-10

Shutter priority, 4-15

Shutter sound, 2-7, 2-10, 4-21

Signal system, 4-21

Slide show, 3-3 to 3-4

Slow synchro

- setting, 4-17
- using, 4-4 to 4-6

Software

- accessing the User's Guide, 5-14
- installing in Windows, 5-3
- installing on your Macintosh, 5-5
- setting up EPSON CameraStarter, 5-7

Speaker

- adjusting volume, 4-21
- location, 1-3

Specifications

- AC adapter, A-6
- battery, A-5
- battery charger, A-5
- camera, A-1 to A-5
- CompactFlash Card, A-5
- optical, A-3
- PCMCIA adapter, A-6

Spot metering system, 4-17

Standard image quality setting, 4-2

Stitch assist feature

- taking one row of overlapping photos, 2-17
- taking two rows of overlapping photos, 2-18

Storage capacity

- CompactFlash Card, 6-1
- internal memory, 6-1

Storing

- the batteries, 1-8
- the camera, 7-2

Strap

- attaching, 1-9

- eyelet, 1-3
- Super fine image quality setting, 4-2
- System requirements
 - for Macintosh, 5-2
 - for Windows, 5-1

T

- Taking pictures
 - continuously, 2-15
 - one row of overlapping photos, 2-17
 - two rows of overlapping photos, 2-18
 - using the digital zoom feature, 2-12
 - using the macro feature, 2-13
 - using the optical zoom feature, 2-7
 - using the self timer, 2-8 to 2-9
 - using the stitch assist feature
 - using the time lapse feature, 2-15
- Taking pictures with the LCD monitor, 2-9 to 2-13
- Taking pictures with the viewfinder, 2-6 to 2-7
- Telephoto zoom, 2-7
- Television, connecting to camera, 3-9
- TIFF file format, 4-4, 5-13
- Time lapse feature, 2-15
- Timer light, 1-2
- Tripod socket, 1-3
- Troubleshooting, 7-2 to 7-9
- Turning the camera on and off, 2-2

U

- United Kingdom users
 - safety information, 7
 - use of options, 3

- Unlocking photos, 3-6
- Unpacking your camera, 1-2
- USB cable, 5-9, 5-11
- USB driver
 - installing in Windows, 5-3
 - installing on your Macintosh, 5-5
- USB interface connector, 1-2

V

- Video clips
 - erasing, 3-8
 - playing back, 3-5
 - recording, 2-13
- Viewfinder
 - location, 1-2, 1-3
 - using to take pictures, 2-6 to 2-9
- Viewing slide show, 3-3 to 3-4

W

- WAV file format, 5-13
- White balance
 - adjusting the setting, 4-9
 - making a custom setting, 4-10
 - when to adjust, 4-9
- Wide zoom, 2-7

Z

- Zoom
 - buttons, 1-3, 2-7, 2-12
 - digital, 2-12
 - optical, 2-7

EPSON OVERSEAS MARKETING LOCATIONS

EPSON AMERICA, INC.

20770 Madrona Ave.
P.O. Box 2842
Torrance, CA 90509-2842
Phone: (800) 922-8911
Fax: (310) 782-5220

EPSON UK LTD.

Campus 100, Maylands Avenue,
Hemel Hempstead, Herts,
HP2 7TJ, U.K.
Phone: (+44) 01442 261144
Fax: (+44) 01442 227227

EPSON DEUTSCHLAND GmbH

Zülpicher Straße 6,
40549 Düsseldorf Germany
Phone: (0211) 56030
Fax: (0211) 5047787

EPSON FRANCE S.A.

68 bis, rue Marjolin
92300, Levallois-Perret, France
Phone: 33.1.40.87.37.37
Telex: 610657

EPSON AUSTRALIA PTY. LTD.

70 GIBBES STREET,
CHATSWOOD 2067 NSW.
Phone: 2-9903-9000
Fax: 2-9903-9177

EPSON SINGAPORE PTE. LTD.

No. 1 Temasek Avenue #36-00
Millenia Tower, Singapore 039192
Phone: (065) 33 77 911
Fax: (065) 33 41 185

EPSON HONG KONG LTD.

Rooms 4706-10, 47/F,
China Resources Bldg.,
26 Harbour Road, Wanchai,
Hong Kong
Phone: 2585-4300
Fax: 2827-7083

EPSON TAIWAN TECHNOLOGY & TRADING LTD.

10F, No. 287 Nanking E. Road, Sec. 3,
Taipei, Taiwan, R.O.C.
Phone: (02) 717-7360
Fax: (02) 712-9164

EPSON ITALIA S.p.A.

V.le F.lli Casiraghi 427
20099 Sesto S.Giovanni
MI, Italy
Phone: 2-262331
Fax: 2-2440750

EPSON IBERICA S.A.

Av. de Roma, 18-26
08290 Cerdanyola del Valles
Barcelona, Spain
Phone: 582. 15.00
Fax: 582. 15.55

EPSON PORTUGAL, S.A.

R. do Progresso, 471, 1ª Perafita
4460 Matosinhos, Portugal
Phone: (02) 996 14 02
Fax: (02) 996 14 11

SEIKO EPSON CORPORATION (Hirooka Office)

80 Harashinden, Hirooka
Shiojiri-shi, Nagano-ken
399-0785 Japan

EPSON

Color Digital Camera

**PRINT
Image
Matching**

**PhotoPC
3100Z**

User's Guide