

# EPSON

Ink Jet Printer

## EPSON *Stylus*™ COLOR 300

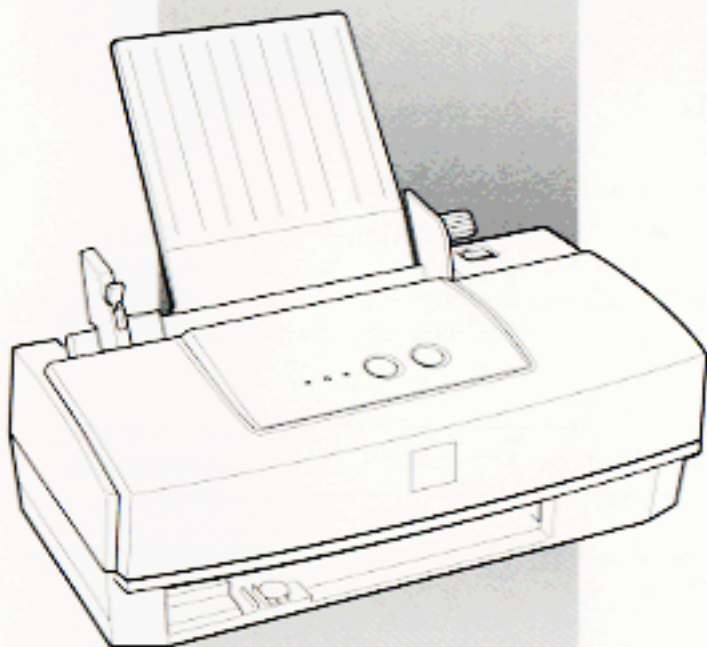

## User's Guide

# Where to Find Information

## *This User's Guide*

Provides you with information on using your EPSON Stylus COLOR 300 and consumable products, from setting up to troubleshooting.

## *Online Help*

Provides you with detailed information and instructions on the Windows printer software that controls your printer. Online help will be automatically installed when you install the printer software. See Chapter 3 for information on accessing online help.

## *EPSON Answers (CD-ROM only)*

Provides you with additional information on using your printer and printing with colors. EPSON Answers will be automatically installed if you install the CD-ROM version of the printer software. Here's what you'll find in EPSON Answers:

- ❑ **How To** displays a step-by-step guide for using your printer, information about printer maintenance, and instructions on replacing consumable products.
- ❑ **Problem Solver** helps you fix common printing problems when you encounter them.
- ❑ **Test Print** lets you print a test page to check the results of settings you have made and provides links to other sections of EPSON Answers based on the results.
- ❑ **Color Guide** explains the ABC's of color printing and shows you how to get impressive results from your printer.

# EPSON Stylus™ COLOR 300

Color Ink Jet Printer

All rights reserved. No part of this publication may be reproduced, stored in a retrieval system, or transmitted in any form or by any means, electronic, mechanical, photocopying, recording, or otherwise, without the prior written permission of SEIKO EPSON CORP. The information contained herein is designed only for use with this EPSON printer. EPSON is not responsible for any use of this information as applied to other printers.

Neither SEIKO EPSON CORP. nor its affiliates shall be liable to the purchaser of this product or third parties for damages, losses, costs, or expenses incurred by purchaser or third parties as a result of: accident, misuse, or abuse of this product or unauthorized modifications, repairs, or alterations to this product, or (excluding the U.S.) failure to strictly comply with SEIKO EPSON CORP.'s operating and maintenance instructions.

SEIKO EPSON CORP. shall not be liable for any damages or problems arising from the use of any options or any consumable products other than those designated as Original EPSON Products or EPSON Approved Products by SEIKO EPSON CORP.

Microsoft and Windows are registered trademarks of Microsoft Corporation.  
IBM is a registered trademark of International Business Machines Corporation.

**General Notice:** *Other product names used herein are for identification purposes only and may be trademarks of their respective owners. EPSON disclaims any and all rights in those marks.*

Copyright © 1997 by SEIKO EPSON CORPORATION, Nagano, Japan.



Printed on Recycled Paper.

## User's Guide

---

# Declaration of Conformity

According to ISO/IEC Guide 22 and EN 45014

Manufacturer: SEIKO EPSON CORPORATION  
Address: 3-5, Owa 3-chome, Suwa-shi,  
Nagano-ken 392 Japan

Representative: EPSON EUROPE B.V.  
Address: Prof. J. H. Bavincklaan 5 1183  
AT Amstelveen  
The Netherlands

Declares that the Product:

Product Name: Ink Jet Printer  
Type Name: EPSON Stylus COLOR 300  
Model: P870C

Conforms to the following Directive(s) and Norm(s):

Directive 89/336/EEC:

EN 55022 class B  
EN 61000-3-2  
EN 61000-3-3  
EN 50082-1  
IEC 801-2  
IEC 801-3  
IEC 801-4

Directive 73/23/EEC:

EN 60950

June 1997

M. Hamamoto  
President of EPSON EUROPE B.V.

---

# Contents

## *Safety Information*

---

Important Safety Instructions . . . . .	1
A few precautions . . . . .	2
ENERGY STAR Compliance . . . . .	4
For United Kingdom Users . . . . .	4
Warnings, Cautions, and Notes . . . . .	5

## *Chapter 1 Getting to Know Your Printer*

---

Printer Parts and Control Panel Functions . . . . .	1-2
System Requirements . . . . .	1-4
Options and Consumable Products . . . . .	1-5

## *Chapter 2 Setting Up the Printer*

---

Unpacking the Printer . . . . .	2-2
Attaching the Paper Support . . . . .	2-3
Choosing a Place for the Printer . . . . .	2-3
Using a printer stand . . . . .	2-4
Plugging in the Printer . . . . .	2-5
Installing the Ink Cartridge . . . . .	2-6
Connecting the Printer to Your PC . . . . .	2-11
Installing the Printer Software . . . . .	2-12
Installing the software for Windows 95 . . . . .	2-13
Installing the software for Windows 3.1 . . . . .	2-19

### *Chapter 3 Starting to Print*

---

Loading Plain Paper . . . . .	3-2
Accessing the Printer Software . . . . .	3-5
From Windows applications . . . . .	3-5
From Windows 95 . . . . .	3-6
From Windows 3.1 . . . . .	3-6
Getting Information Through Online Help . . . . .	3-7
From Windows applications . . . . .	3-7
From Windows 95 . . . . .	3-7
From Windows 3.1 . . . . .	3-8

### *Chapter 4 Printing on Special Paper*

---

Setting the Paper Thickness and Adjust Levers . . . . .	4-2
Setting the paper thickness lever . . . . .	4-2
Setting the adjust lever . . . . .	4-3
Loading Special Paper and Other Media . . . . .	4-4
Loading Envelopes . . . . .	4-6

### *Chapter 5 Maintenance and Transportation*

---

Replacing the Ink Cartridge . . . . .	5-2
Cleaning the Print Head . . . . .	5-6
Aligning the Print Head . . . . .	5-8
Cleaning the Printer . . . . .	5-9
Transporting the Printer . . . . .	5-10

## Chapter 6 *Troubleshooting*

---

Diagnosing the Problem . . . . .	6-2
Error indicators . . . . .	6-2
Printer operation check . . . . .	6-3
Problems and Solutions . . . . .	6-5
Power supply . . . . .	6-6
Operation . . . . .	6-7
Paper handling . . . . .	6-12
Printing quality . . . . .	6-15
Increasing the Print Speed . . . . .	6-21
Fixing Ink Cartridge Problems . . . . .	6-22
Contacting Customer Support . . . . .	6-24
For United Kingdom and the Republic of Ireland users . . . . .	6-24
For Australian users . . . . .	6-26
For Singapore users . . . . .	6-28
For Hong Kong users . . . . .	6-28
For Philippines users . . . . .	6-29

## Appendix *Printer Specifications*

---

Printing . . . . .	A-2
Paper . . . . .	A-2
Printable area . . . . .	A-4
Ink Cartridge (S020138) . . . . .	A-5
Mechanical . . . . .	A-6
Electrical . . . . .	A-6
Environmental . . . . .	A-7
Safety Approvals . . . . .	A-7

## *Glossary*

---

## *Index*

---





---

# *Safety Information*

---

## *Important Safety Instructions*

Read all of these instructions and save them for later reference. Follow all warnings and instructions marked on the printer.

- Do not place the printer on an unstable surface or near a radiator or heat source.
- Place the printer on a flat surface. The printer will not operate properly if it is tilted or at an angle.
- Do not block or cover the openings in the printer's cabinet. Do not insert objects through the slots.
- Use only the type of power source indicated on the printer's label.
- Connect all equipment to properly grounded power outlets. Avoid using outlets on the same circuit as photocopiers or air control systems that regularly switch on and off.
- Do not use a damaged or frayed power cord.
- If you use an extension cord with the printer, make sure the total ampere rating of all devices plugged into the extension cord does not exceed the cord's ampere rating. Also, make sure the total ampere rating of all devices plugged into the wall outlet does not exceed the wall outlet's ampere rating.
- Unplug the printer before cleaning. Clean with a damp cloth only. Do not spill liquid on the printer.
- Except as specifically explained in this guide do not attempt to service the printer yourself.

- ❑ Unplug the printer and refer servicing to qualified service personnel under the following conditions:

If the power cord or plug is damaged; if liquid has entered the printer; if the printer has been dropped or the cabinet damaged; if the printer does not operate normally or exhibits a distinct change in performance. Adjust only those controls that are covered by the operating instructions.

- ❑ If you plan to use the printer in Germany, observe the following:



To provide adequate short-circuit protection and over-current protection for this printer, the building installation must be protected by a 16 Amp circuit breaker.

Bei Anschluß des Druckers an die Stromversorgung muß sichergestellt werden, daß die Gebäudeinstallation mit einem 16 A-Überstromschalter abgesichert ist.

### *A few precautions*

Even if you are familiar with other types of printers, be sure to read through the following list of precautions before operating your ink jet printer.

- ❑ Do not put your hand inside the printer or touch the ink cartridge during printing.
- ❑ Do not move the print head by hand; otherwise you may damage the printer.
- ❑ Under normal circumstances, ink will not come out of ink cartridges. If ink gets on your skin, wash it off with soap and water. If it gets in your eyes, flush them immediately with water.
- ❑ Keep ink cartridges out of the reach of children.

- ❑ Do not dismantle ink cartridges or try to refill them. This could result in damage to the print head.
- ❑ Once you install an ink cartridge, do not open the ink cartridge clamp or remove the cartridge except to replace it with a new one. The cartridge may become unusable otherwise.
- ❑ Install the ink cartridge immediately after you remove it from its package. Leaving the cartridge unpacked for a long time before use may result in reduced print quality.
- ❑ Do not use an ink cartridge beyond the date printed on the cartridge carton. For best results, use up the ink cartridges within six months of installing them.
- ❑ Do not shake an ink cartridge; this can cause leakage.
- ❑ Always turn the printer off using the power switch. The  power light flashes until the print head is capped, which means it is at rest in the far right position. Do not unplug the printer or turn off the power to the outlet until the  power light stops flashing. The printer caps the print head when no data is received for several seconds.
- ❑ Before transporting the printer, make sure the print head is in the far right position and the ink cartridge is in place.



---

## **ENERGY STAR Compliance**

As an ENERGY STAR Partner, EPSON has determined that this product meets the ENERGY STAR guidelines for energy efficiency.

The International ENERGY STAR Office Equipment Program is a voluntary partnership with the computer and office equipment industry to promote the introduction of energy-efficient personal computers, monitors, printers, fax machines, and copiers in an effort to reduce air pollution caused by power generation.

---

## **For United Kingdom Users**

### **Use of options**

EPSON (UK) Limited shall not be liable against any damages or problems arising from the use of any options or consumable products other than those designated as Original EPSON Products or EPSON Approved Products by EPSON (UK) Limited.

### **Safety information**



**Warning:** *This appliance must be earthed. Refer to rating plate for voltage and check that the appliance voltage corresponds to the supply voltage.*

**Important:** *The wires in the mains lead fitted to this appliance are coloured in accordance with the following code:*

*Green and yellow — Earth  
Blue — Neutral  
Brown — Live*

**If you have to fit a plug:**

As the colours of the mains lead of this appliance may not match coloured markings used to identify the terminals in a plug, please proceed as follows:

The green and yellow wire must be connected to the terminal in the plug which is marked with the letter E or the Earth symbol ( $\perp$ ).

The blue wire must be connected to the terminal in the plug marked with the letter N.

The brown wire must be connected to the terminal in the plug marked with the letter L.

If damage occurs to the plug, replace the cord set or consult a qualified electrician.

Replace fuses only with a fuse of the correct size and rating.

---

## *Warnings, Cautions, and Notes*



**Warnings** must be followed carefully to avoid bodily injury.



**Cautions** must be observed to avoid damage to your equipment.

**Notes** contain important information and useful tips on the operation of your printer.



Printer Parts and Control Panel Functions . . . . .	1-2
System Requirements . . . . .	1-4
Options and Consumable Products . . . . .	1-5



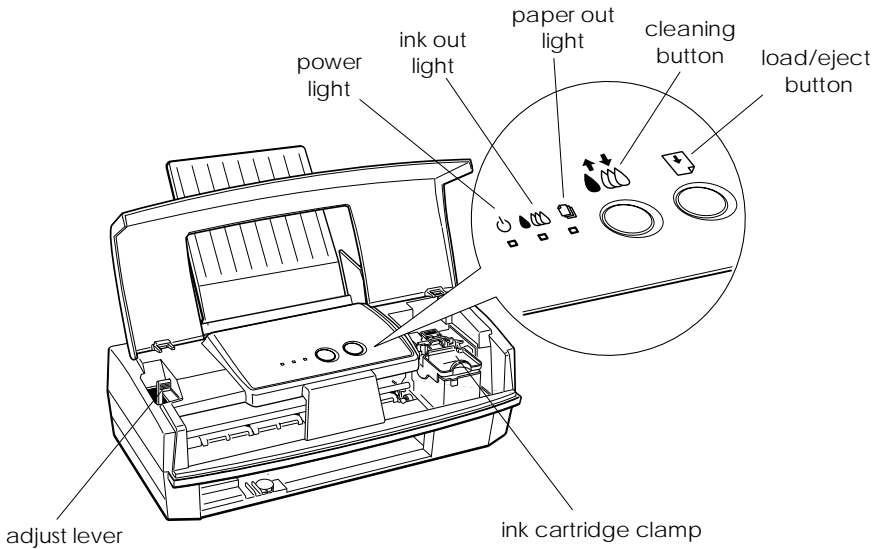
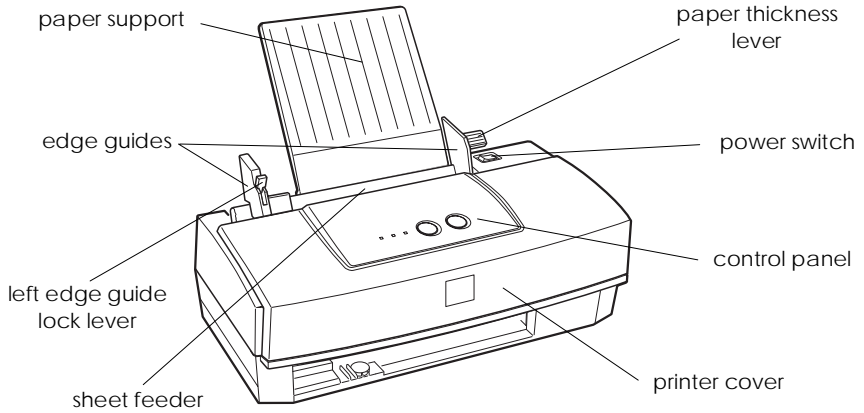

---

## Printer Parts and Control Panel Functions









## Buttons

Button	Function
 <b>Load/Eject</b>	Loads or ejects paper if pressed and released within 2 seconds. Resumes printing if pressed after a paper out error.
 <b>Cleaning</b>	Moves the print head to the ink cartridge replacement position if pressed for 3 seconds while the  ink out light is flashing or on. Returns the print head to its home position after ink cartridge replacement. Performs print head cleaning if pressed for 3 seconds when the  ink out light is off.

## Lights

The lights turn on or flash to indicate the printer status.

			Printer Status
○	-	-	Printer is on.
◐	-	-	Receiving data, replacing an ink cartridge, charging ink, or cleaning the print head.
-	-	○	Paper out. Load paper in the sheet feeder; then press the  load/eject button to resume printing.
-	-	◐	Paper jam. Take all the paper out of the feeder, and reload the paper. If the light continues to flash, turn off the printer and gently pull all the paper out of the printer.
-	◐	-	Ink low. The ink cartridge is nearly empty. Obtain an ink cartridge (S020138).
-	○	-	Ink out. The ink cartridge is not installed or is empty. Install or replace the ink cartridge (S020138).

○ = on, ◐ = flashing, - = irrelevant

---

## ***System Requirements***

To use your printer with a PC, you need Microsoft® Windows® 3.1, Windows for Workgroups, or Windows 95; and a shielded, twisted-pair parallel cable.

The following tables show the system requirements for using just the essential software, printer driver and utilities, and also for using EPSON Answers, the multi-media guide to your printer and color printing.

### ***Essential printer software***

To install and use the printer software (printer driver and utilities) included on the CD-ROM or floppy disk packed with your printer, the following is required:

Minimum system	Recommended system
80386/25 MHz processor	Pentium or higher processor
16MB RAM	32MB RAM or more
20MB hard disk space	50MB or more free hard disk space
VGA monitor	VGA or better monitor

### ***EPSON Answers***

To use the EPSON Answers online guide included with your printer software, your system should also meet the following requirements:

- IBM® -compatible PC with a 486, 586, or Pentium™ processor
- 8MB of RAM (16MB recommended)
- 20MB of free disk space for full program installation (40MB or more recommended)

- ❑ VGA, Super VGA, or better display adaptor and color monitor
- ❑ 640 x 480 screen resolution (800 x 600 recommended)
- ❑ Double-speed CD-ROM drive (Quad-speed or faster recommended)

To run EPSON Answers, see your CD-ROM booklet.

Your computer dealer can help you update your system if it does not meet these requirements.

---

## *Options and Consumable Products*

### *Interface cables*

EPSON supplies several types of interface cables. You can use any interface cable that meets the specifications listed below. See your computer manual for any additional requirements.

Parallel Interface Cable (shielded) C83602\* from D-SUB 25-pin (computer) to 36-pin Amphenol 57 Series (printer)

**Note:**

*The asterisk (\*) is a substitute for the last digit of the product number, which varies by country.*

### *Ink cartridge*

Color ink cartridge            S020138

## *EPSON special media*

Paper specifically designed for ink jet printers will meet most high-quality printing needs.

EPSON 360 dpi Ink Jet Paper (A4)	S041025
	S041059
EPSON 360 dpi Ink Jet Paper (Letter)	S041060
EPSON Photo Quality Ink Jet Paper (A4)	S041026
	S041061
EPSON Photo Quality Ink Jet Paper (Letter)	S041062
EPSON Photo Quality Ink Jet Paper (Legal)	S041067
EPSON Photo Quality Ink Jet Card (A6)	S041054
EPSON Photo Quality Glossy Film (A4)	S041071
EPSON Photo Quality Glossy Film (Letter)	S041072
EPSON Photo Quality Glossy Film (A6)	S041107
EPSON Photo Quality Glossy Paper (A4)	S041126
EPSON Photo Quality Glossy Paper (Letter)	S041124
EPSON Ink Jet Transparencies (A4)	S041063
EPSON Ink Jet Transparencies (Letter)	S041064
EPSON Photo Quality Self Adhesive Sheet (A4)	S041106
EPSON Photo Paper (4 x 6 in.)	S041134

### **Note:**

- The availability of special media varies by country.*
- Since the name on the special media packaging may vary in certain markets, you may need to use the product number to confirm the type of special media you have.*
- Ink jet printers are particularly sensitive to the condition of your paper. Keep unused paper in its original packaging and store it in a cool, dry place.*

Unpacking the Printer . . . . .	2-2
Attaching the Paper Support . . . . .	2-3
Choosing a Place for the Printer . . . . .	2-3
Using a printer stand . . . . .	2-4
Plugging in the Printer . . . . .	2-5
Installing the Ink Cartridge . . . . .	2-6
Connecting the Printer to Your PC . . . . .	2-11
Installing the Printer Software . . . . .	2-12
Installing the software for Windows 95 . . . . .	2-13
Installing the software for Windows 3.1 . . . . .	2-19

---

## Unpacking the Printer

Your printer box should include a CD-ROM, which includes the printer software that runs your printer, and the following items:

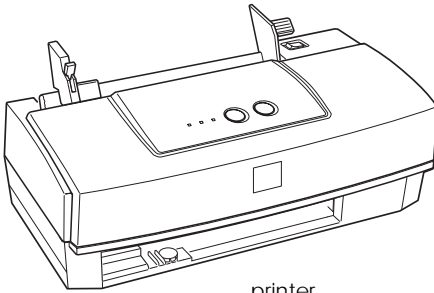

printer

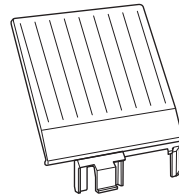

paper support

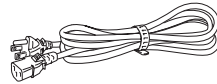

power cord



ink cartridge

In some locations, the power cord comes attached to the printer. The shape of the AC plug varies by country; be sure the plug included is the right shape for your location.

Remove all protective materials packed with your printer before you set it up and turn on the power. Follow the instructions inserted with the printer to remove these materials. Save all packaging and protective materials in case you need to transport the printer later.

---

## Attaching the Paper Support

Insert the paper support into the central slot at the rear of the printer as shown below.

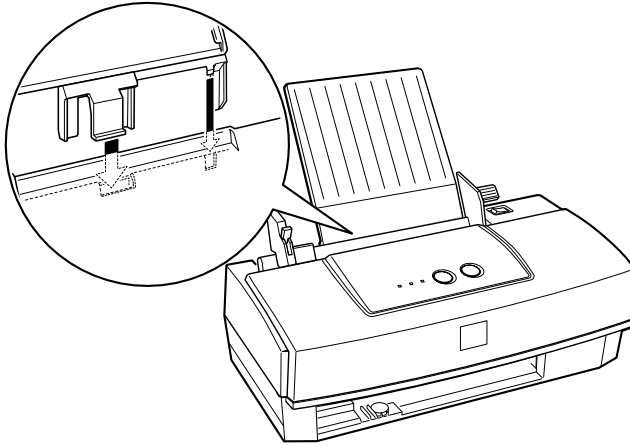

---

## Choosing a Place for the Printer

Follow the guidelines listed below when selecting a location for your printer.

- Place the printer on a flat, stable surface. The printer will not operate properly if it is tilted or at an angle.
- Place the printer close enough to the computer for the interface cable to reach it easily.
- Leave enough room on the table at the front of the printer for the paper to flow freely out of it.
- Leave adequate room for easy operation and maintenance.
- Avoid using or storing the printer in places subject to rapid changes in temperature and humidity. Also keep it away from direct sunlight, strong light, or heat sources.

- ❑ Avoid places subject to shocks and vibrations.
- ❑ Place the printer near a wall outlet where the plug can be easily unplugged.

***Note for French-speaking users:***

*Placez l'imprimante près d'une prise de contact où la fiche peut être débranchée facilement.*

- ❑ Avoid electrical outlets controlled by wall switches or automatic timers. Also, avoid outlets on the same circuit as large motors or other appliances that can cause fluctuations in line voltage.
- ❑ Keep the entire computer system away from potential sources of electromagnetic interference, such as loudspeakers or the base units of cordless telephones.
- ❑ Use a grounded power outlet; do not use an adapter plug.

### ***Using a printer stand***

When using a printer stand, note the following:

- ❑ Use a stand that can support at least 10.0 kg (22.1 lb).
- ❑ Never use a stand that tilts the printer. The printer should always be kept level.



---

## Plugging in the Printer

1. Make sure that the printer is turned off.

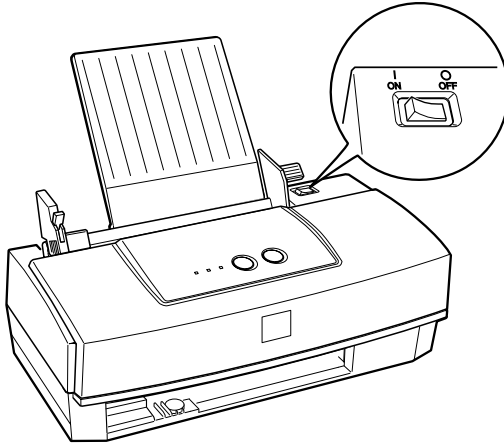

2. Check the label on the back of the printer to make sure the voltage required by the printer matches that of the electrical outlet you will be plugging it into. Also, make sure that you have the correct power cable for your power source.



**Caution:**

*It is not possible to change the printer's voltage. If the rated voltage and your outlet voltage do not match, contact your dealer for assistance. Do not plug in the power cord.*

3. If the power cord is not attached to the printer, connect it to the AC inlet on the back of the printer.
4. Plug the power cord into a properly grounded electrical outlet.

---

## Installing the Ink Cartridge





**Warning:**

*The ink cartridge is a self-contained unit. Under ordinary use, ink will not leak from a cartridge. If ink does get on your hands, wash them thoroughly with soap and water. If ink gets into your eyes, flush them immediately with water.*



Install the ink cartridge as follows:

**Note:**

*Do not open the ink cartridge package until just before you install the cartridge, or the ink may dry up.*

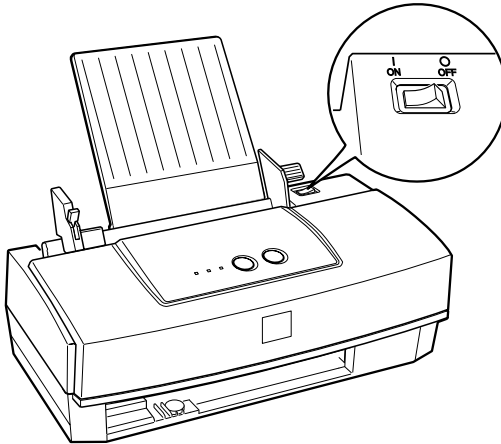
1. Turn on the printer. The  power light and the  ink out light come on.



2. Hold down the  cleaning button for three seconds. The  power light begins flashing, and the print head moves slightly left to the ink cartridge replacement position.

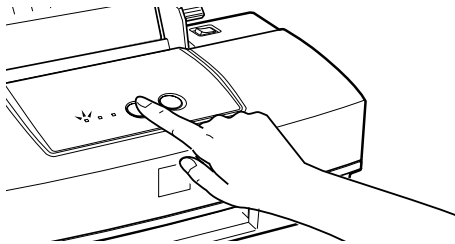

**Caution:**

*Do not move the print head by hand. Always use the  cleaning button to move it. Otherwise you may damage the printer.*

3. Holding both sides of the cover, open the printer cover.

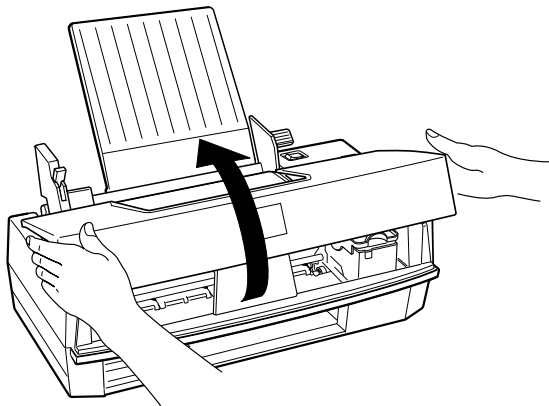

4. Lift up the ink cartridge clamp as far as it will go. Remove the protective material from the cartridge holder.

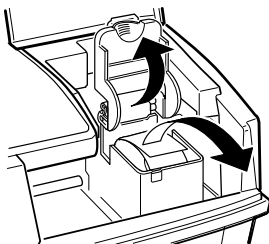

5. Open the ink cartridge package. Next, remove only the yellow tape seal from the top of the cartridge as shown below.



**Caution:**

- ❑ *You must remove the yellow tape seal from the cartridge. Installing the cartridge with the yellow tape still attached will permanently damage it.*
- ❑ *Do not remove the whole tape seal (especially the white portion) from the top of the cartridge. Remove only the yellow portion.*
- ❑ *Do not remove the tape seal from the bottom of the cartridge; otherwise, ink will leak.*

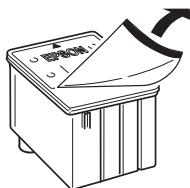

(S020138)

6. Lower the ink cartridge into the holder with the label face up and the arrow mark pointing to the rear. Do not push down on the ink cartridge.

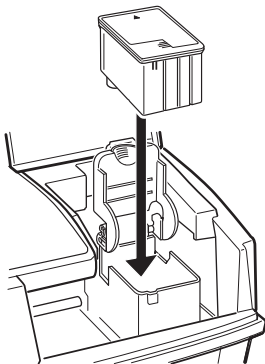

7. Press the ink cartridge clamp down until it locks in place.

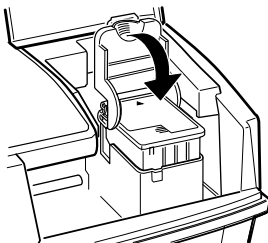

**Caution:**

*Once you install the ink cartridge, do not open the clamp again until you replace the ink cartridge. Otherwise, the cartridge may become unusable.*

8. Press the  cleaning button. The printer moves the print head to its home (far right) position.



**Note:**

*Even if you do not press the  cleaning button, the printer moves the print head unit back to its home position about 60 seconds after you install the ink cartridge.*

The printer charges the ink delivery system. The first time you install the ink cartridge, this operation takes a few minutes.



**Caution:**

*During the ink charging process, the  power light flashes. Never turn off the printer while the  power light is flashing. Doing so can result in incomplete charging of printer ink.*

9. Close the printer cover.

The life of a cartridge depends on the amount of text and color graphics you print, or the number of colors you use in your document.

**Note:**

*When ink runs out, see “Replacing the Ink Cartridge” in Chapter 5.*

---

## Connecting the Printer to Your PC

To connect the printer to your computer using the built-in parallel interface, you need a shielded, twisted-pair parallel cable.

Connect the printer to the computer as follows:

1. Make sure both the printer and computer are turned off.
2. Plug the cable connector securely into the printer's interface connector. Then squeeze the wire clips together until they lock in place on both sides. If your cable has a ground wire, connect it to the ground connector below the interface connector.

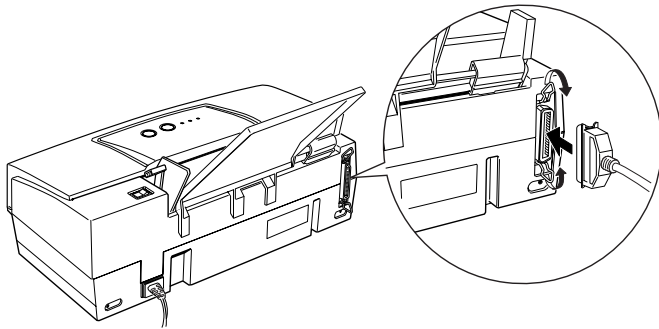

3. Plug the other end of the cable into the computer's parallel interface. If there is a ground wire at the computer end of the cable, connect it to the ground connector at the back of the computer.

See the next section for instructions on installing the printer software. You must install the printer software before using your printer.

---

## *Installing the Printer Software*

After connecting the printer to your computer, install the printer software. It is included in the “Printer Software for EPSON Stylus COLOR 300” CD-ROM shipped with your printer.

Your printer software includes:

- ❑ **Printer driver**  
The printer driver is software that runs, or “drives”, your printer. With it, you can make settings such as print quality, media type, and paper size.
- ❑ **Utilities**  
The Status Monitor utility helps you check the current status of your printer. The Nozzle Check, Head Cleaning, and Print Head Alignment utilities help you keep your printer in top operating condition.
- ❑ **Online help**  
Online help gives you instant on-screen access to detailed information and instructions on how to use your printer.
- ❑ **EPSON Answers**  
EPSON Answers provides you with additional information on using your printer and printing with colors. See the booklet packed with the CD-ROM for more information. EPSON Answers is not included in the floppy disk version.

If you are using the floppy disk version of the software, before you begin installation, make a backup copy of the EPSON printer software disk.

To make a floppy disk version of the printer software on your CD-ROM, you can use the Driver disk creation utility included on the CD as described on next page for Windows 95 or page 2-19 for Windows 3.1.



## Installing the software for Windows 95

If you are using Windows 3.1, see page 2-19 for instructions.

1. Make sure Windows 95 is running and the printer is off.
2. **For CD-ROM users:**  
Insert the printer software CD shipped with your printer in the CD-ROM drive. The dialog box shown below appears. Click Install.

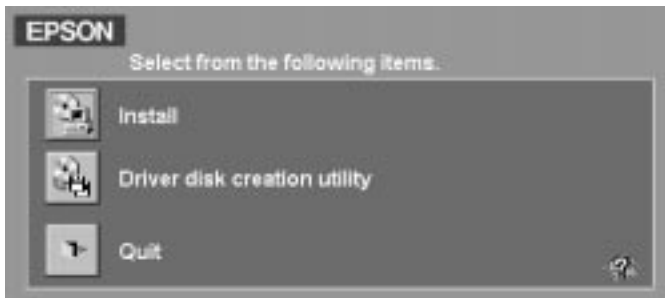

### **Note:**

- ❑ *If this dialog box does not appear, double-click the My Computer icon, and then double-click the CD-ROM drive icon. If this dialog box still does not appear, double-click the Setup.exe icon, and go to step 3.*
- ❑ *To make a floppy disk version of the essential printer software (printer driver, utilities, and online help), click Driver disk creation utility and follow the on-screen instructions.*

### **For floppy disk users:**

Insert the printer software floppy disk in the floppy drive and double-click the My Computer icon. Double-click the appropriate drive icon, and double-click the Setup.exe icon.

3. Select your printer icon in the EPSON Printer Utility Setup dialog box. Click OK to start the installation and follow the on-screen instructions.

**Note:**

*Installation time varies depending on your computer system.*

**For CD-ROM users:**

EPSON Answers installation begins automatically once the printer driver and utilities are installed. Follow the on-screen instructions.

**For floppy disk users:**

Click OK when the installation of the printer driver and utilities is completed.

Your printer software is now installed. For detailed information on accessing the software, see Chapter 3.

If you use your printer on a network with Windows 95, see page 2-17.

## Installing the software using Windows 95 plug-and-play function

Follow these steps to install the printer software using Windows 95 plug-and-play capabilities.

### Note:

To install the printer software using Windows 95 plug-and-play capabilities, your computer's parallel port must be an IEEE-1284 compatible, bidirectional parallel port. See your computer documentation for more information.

1. Make sure the printer is connected to the computer's parallel port.
2. Turn off your printer and computer, if necessary.
3. Turn on the printer first; then turn on the computer. Your computer begins loading Windows 95.
4. If you defined a password, enter it at the prompt. You see the New Hardware Found screen.

### Note:

If you do not see the New Hardware Found screen, please follow the procedure under "Installing the software for Windows 95" on page 2-13 instead.

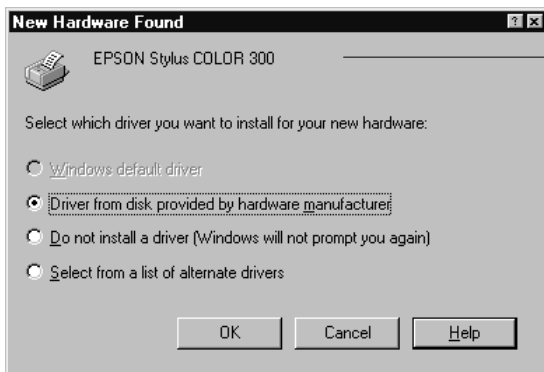

Make sure your printer name is displayed.

5. Click the Driver from disk provided by hardware manufacturer button. Do not select any of the other buttons.
6. Click OK. You see the Install From Disk screen.
7. **For CD-ROM users:**

There are two versions of the printer software, English only and the multiple-language version. If your CD does not have “Multiple-language version” written on it, insert the CD in the CD-ROM drive, type D:\Windows, click OK, and go to step 8.

If your CD has “Multiple-language version” written on it, insert the CD in the CD-ROM drive, type D:\, and then type your preferred language: English, Francais, German, Italian, Portugal, or Spanish, followed by \Windows. Click OK.

**For floppy disk users:**

Insert the printer software floppy disk in a disk drive. If the drive you are installing from is displayed on the screen, click OK. Otherwise, change the drive letter in the Copy manufacturer’s files from box and click OK.

8. At the next screen, you can type a unique name for the printer in the Printer name box. We recommend that you keep the model name as shown.

Select Yes (No is the default setting) to use this printer as the default printer for Windows 95 applications.

9. Click the Finish button.

**Note:**

*Installation time varies depending on your computer system.*

**For CD-ROM users:**

EPSON Answers installation begins automatically once the printer driver and utilities are installed. Follow the on-screen instructions.

**For floppy disk users:**

Click OK when installation is completed.

Your printer software is now installed. For detailed information on accessing the software, see Chapter 3.

If you use your printer on a network with Windows 95, see the next section.

### *Using your printer on a network with Windows 95*

To print over a network, you need to set up your printer as a remote printer. Follow these steps:

1. Double-click the My Computer icon.
2. Double-click the Printers folder.
3. Right-click the icon of your printer, and click Properties. Be sure to right-click.

4. Click the Details tab. The following window appears:



5. Click the Add Port button, then specify the network path to the printer. Click OK.
6. After you have made your settings on the Details menu, click Start, point to Programs and Epson, then click Spool Manager<sup>4</sup>. The Spool Manager window opens.
7. Select your printer, click the Queue menu, then click Setup. The Queue setup window opens.
8. Make sure the Use Print Manager for this port option is on; it is on if the box contains a check mark. Then click OK.

Now you can use your printer on a network.

## Installing the software for Windows 3.1

Follow these steps to install the software using Windows 3.1:

1. Make sure Windows 3.1 is running and the Program Manager window is open.
2. Insert the EPSON printer software CD shipped with your printer in the CD-ROM drive. (If you use the floppy disk version, insert it in a disk drive.)
3. From the File menu, choose Run. You see the Run dialog box. In the Command Line box, type D:\SETUP. (If your CD-ROM drive has a drive letter other than “D” or you are using the floppy version, substitute the appropriate letter.)

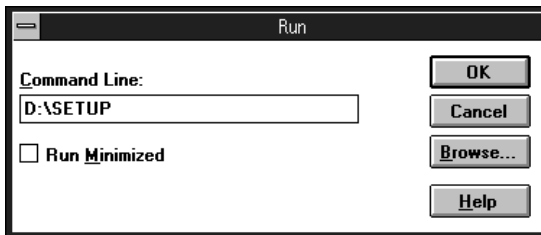

**Note:**

*If you wish to make a floppy disk version of the essential printer software (printer driver, utilities, and online help) that comes on your CD-ROM, type EPSETUP instead of SETUP. In the dialog box that appears, click the Driver disk creation utility button and follow the on-screen instructions.*

4. Click OK. Select your printer icon in the EPSON Printer Utility Setup dialog box.

5. Click **OK** to start installation and follow the on-screen instructions.

**For CD-ROM users:**

EPSON Answers installation begins automatically once the printer driver and utilities are installed. Follow the on-screen instructions.

**For floppy disk users:**

Click **OK** when the installation of the printer driver and utilities is completed.

The installation program automatically selects this printer as the default printer for Windows applications.

Your printer software is now installed. For information on accessing the printer software, see Chapter 3, "Accessing the Printer Software."



## Chapter 3

# Starting to Print

---

Loading Plain Paper . . . . .	3-2
Accessing the Printer Software . . . . .	3-5
From Windows applications . . . . .	3-5
From Windows 95 . . . . .	3-6
From Windows 3.1 . . . . .	3-6
Getting Information Through Online Help . . . . .	3-7
From Windows applications . . . . .	3-7
From Windows 95 . . . . .	3-7
From Windows 3.1 . . . . .	3-8



---

## *Loading Plain Paper*

The following procedure describes how to load plain paper in the printer.

You can also print on ink jet paper, transparencies, index cards, photo-quality glossy paper/film, photo paper, envelopes, and adhesive sheets. For instructions on using special media, see Chapter 4, “Printing on Special Paper.”

1. Make sure the paper thickness lever is set to the plain paper position.

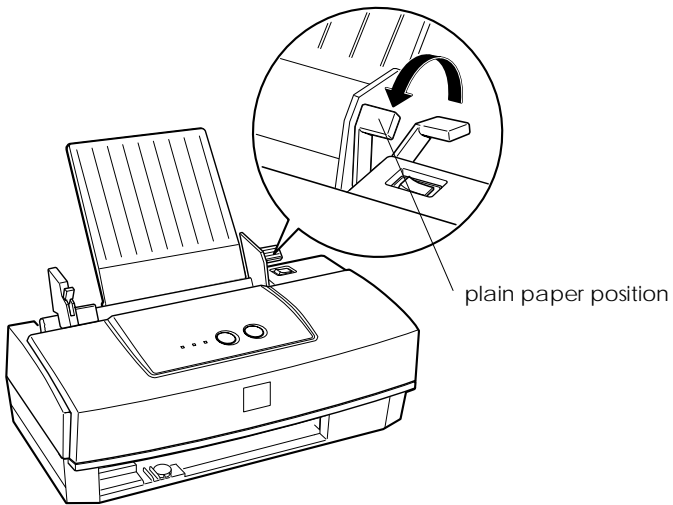

2. Push down the left edge guide lock lever and slide the left edge guide to the left as far as it will go.

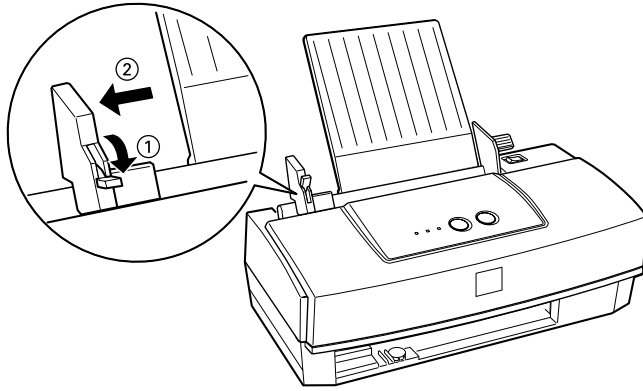

3. Load a stack of paper with the printable surface up and the right edge of the paper resting against the right side of the sheet feeder.

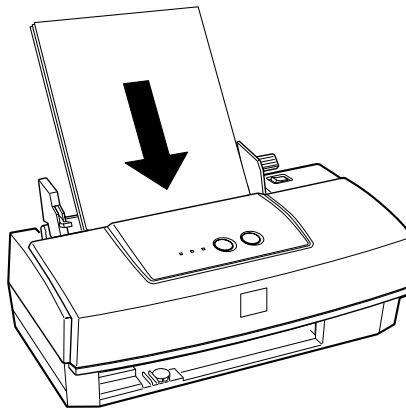

**Note:**

*The sheet feeder can hold up to 100 sheets of 17-lb or 64 g/m<sup>2</sup> plain paper. Do not load paper above the arrow mark, which is located on the inside surface of the edge guide.*

- Slide the left edge guide against the left edge of the paper; then push up the lock lever to secure the left edge guide. Remove the paper.

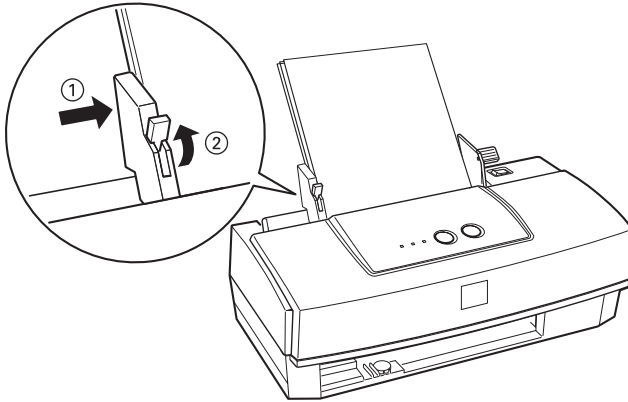

- Fan the stack of paper; then tap it on a flat surface to even the edges.
- While holding the printable side of the paper toward you, insert it gently straight up and down into the printer. Then rest the paper against the paper support. This step ensures that the paper is properly loaded in the paper path.

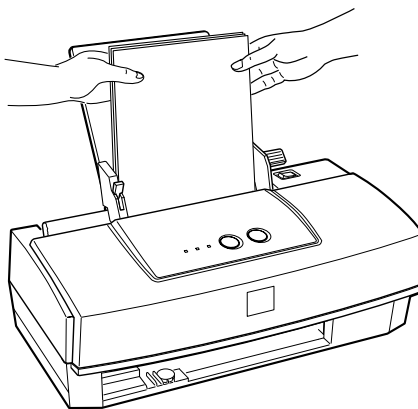

---

## *Accessing the Printer Software*

The way you should access the printer driver settings depends on how you want the settings to take effect. Be aware that settings you make in your application override settings made directly in the driver, so in most cases you should access the driver from your application to make sure that the printer driver settings are appropriate for your document.

- ❑ If you want the settings to apply only to the document(s) you will print in a particular Windows application, see “From Windows applications” below.
- ❑ If you want the settings to apply to your Windows applications, see the next page.

### *From Windows applications*

How you should access the printer software varies depending on the application, application version, and Windows version you are using. Read the following to get a general idea of how to access the software.

From the File menu, choose Print or Print Setup. In the dialog box that appears click Printer, Setup, Properties, or Options. You may need to click a combination of these buttons.

The Main and Paper menus contain the printer driver settings. The Utility menu contains the printer utilities. Click the tabs at the top of the menus to open them.

For information on the printer driver settings, see online help.

## *From Windows 95*

Follow these steps to access the printer software from My Computer.

If you are using Windows 3.1, see the next section.

1. Double-click the My Computer icon.
2. Double-click the Printers folder.
3. Right-click the icon of your printer, and click Properties. The Properties window appears.
4. Click the menu tabs at the top of the Properties window to open the printer software menus. The Main and Paper menus contain the printer driver settings. The Utility menu contains the printer utilities.

For information on the printer driver settings, see online help.

## *From Windows 3.1*

Follow these steps to access the printer software from Program Manager:

1. Open the Main program group and double-click the Control Panel icon.
2. Double-click the Printers icon.
3. Choose your printer from the Installed Printers list.
4. Choose Setup. You see the Main menu of the printer software window. The Main and Paper menus contain the printer driver settings. The Utility menu contains the printer utilities. Click the tabs at the top of the menus to open them.

For information on the printer driver settings, see online help.

---

## Getting Information Through Online Help

Your printer software has an extensive online help feature that includes detailed information and instructions about printer driver settings and the printer utilities. Online help will answer most of your questions about the printer driver settings and the utilities.



### From Windows applications

To access online help from your application, open the File menu and choose Print or Print Setup. Then click Printer, Setup, Options, or Properties (you may need to click a combination of these buttons) depending on the software you are using. Click the Help button at the bottom of the Main, Paper, and Utility menus for help related to the items on that menu.

If you are running Windows 95, you can get specific help related to any item on a menu by right-clicking the item, then clicking the What's This? prompt.

### From Windows 95

To access online help directly from Start, click the Start button, point to Programs and Epson, and then click EPSON Stylus COLOR 300 Help. You see the help contents window.

### *From Windows 3.1*

To access online help directly from Program Manager, open the EPSON program group and click the EPSON Stylus COLOR 300 Help icon. You see the help contents window.



## Chapter 4

---

# *Printing on Special Paper*

Setting the Paper Thickness and Adjust Levers . . . . .	4-2
Setting the paper thickness lever . . . . .	4-2
Setting the adjust lever . . . . .	4-3
Loading Special Paper and Other Media . . . . .	4-4
Loading Envelopes . . . . .	4-6



---

## Setting the Paper Thickness and Adjust Levers

Before you start printing on special paper, you may need to change the paper thickness lever and the adjust lever settings.

**Note:**

*When changing these settings, make sure the printer is paused and no paper is in the sheet feeder or the paper path.*

### Setting the paper thickness lever

The paper thickness lever has two settings: plain paper and thick paper. You should set the lever to the position that best suits the media you plan to use for printing, as shown in the table below.

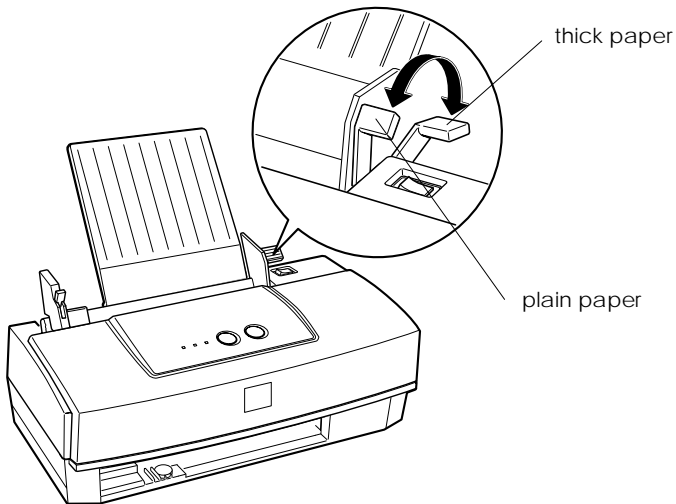

Lever Position	Paper Type
Plain paper	Standard paper, coated paper, transparencies, glossy paper/film
Thick paper	Envelopes, index cards, self adhesive sheets, photo paper

## Setting the adjust lever

When you print on thick paper such as envelopes or if ink smears on your documents, set the adjust lever to the “+” position. To change the setting, open the printer cover and position the lever as shown below.

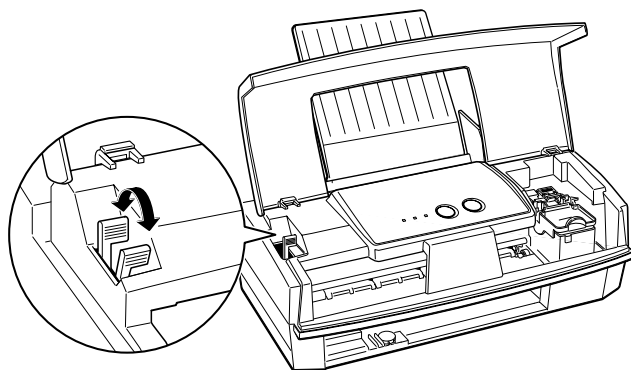

4

Lever Position	Paper Type
0	Standard paper, coated paper, index cards, transparencies, glossy paper/film
+	Envelopes

**Note:**

*If the ink on your printout smears, set the adjust lever to the “+” position.*

---

## *Loading Special Paper and Other Media*

You can use most plain bond paper to achieve good results. However, coated papers and glossy paper/film give you better results because they reduce the amount of ink that is absorbed.

EPSON provides special media that are formulated for the ink used in EPSON ink jet printers. EPSON recommends you to use media distributed by EPSON to ensure high-quality results. For a list of EPSON special media, see page 1-6, or “Printing Supplies” in online help.

When loading special paper distributed by EPSON, read the instruction sheet packed with your special media first and keep the following in mind:

- ❑ Make sure the printable surface of the paper is face up when loading media into the sheet feeder. See the instruction sheet packed with the media to determine which side is the printable surface. Some media features cut corners to help identify the correct loading direction, as shown below.

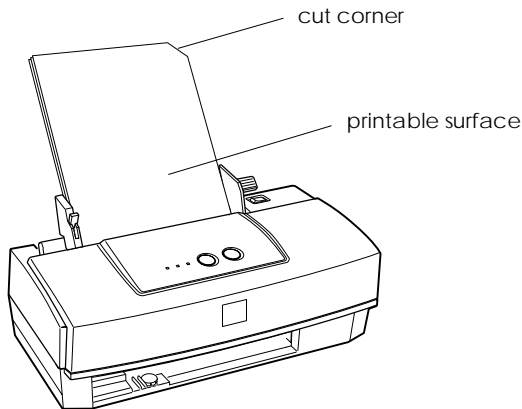

- ❑ Make sure the paper thickness lever setting and the adjust lever position are appropriate for the paper. See “Setting the Paper Thickness and Adjust Levers,” on page 4-2.

- ❑ Loading capacity for special media is explained below.

EPSON 360 dpi  
Ink Jet Paper and Photo  
Quality Ink Jet Paper

Up to the arrow mark on the left edge guide. For legal-size, halfway up to the arrow mark.

EPSON Photo Quality  
Ink Jet Cards

Up to 30 index cards. Always place the provided support sheet beneath the cards when loading.

EPSON Photo Quality  
Glossy Paper

One sheet at a time. Always place the support sheet\* under the glossy paper.

EPSON Photo Quality  
Glossy Film

One sheet at a time for best results. If you wish to load multiple sheets of glossy film, load only up to 30 sheets and set the minimum top margin of the page to 30 mm. For A6 size, one sheet at a time. Always put a support sheet\* or a sheet of plain paper under the glossy film.

EPSON Ink Jet  
Transparencies

Up to 30 transparencies. Always put a sheet of plain paper under the stack of transparencies.

EPSON Photo Quality  
Adhesive Sheets

One sheet at a time.

EPSON Photo Paper

Up to 20 sheets. Always put a support sheet\* under the stack of Photo Paper.

Envelopes

Up to 10 envelopes.

\*If a support sheet is packed with the paper, load it underneath the paper, but do not print on it.

---

## *Loading Envelopes*

When printing on envelopes, please note the following:

- ❑ You can load up to 10 envelopes into the sheet feeder.
- ❑ Set the paper thickness lever to “thick paper”, and the adjust lever to “+” position.
- ❑ Load envelopes top edge first with the flap side down, as shown below.

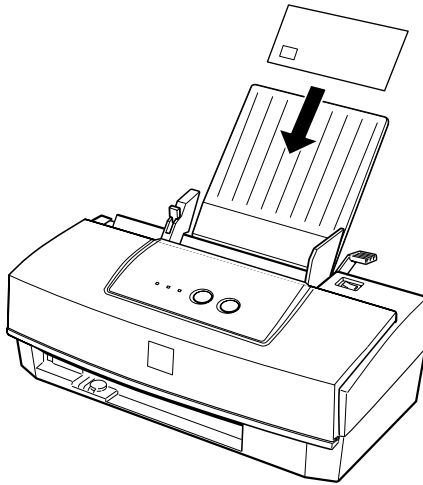

- ❑ Do not use envelopes that are curled or folded. Also avoid using envelopes that are too thin; they may curl during printing.
- ❑ Select Plain Paper as the Media Type setting in the printer driver. For more details on making printer driver settings, see online help.

## Chapter 5

---



# *Maintenance and Transportation*

Replacing the Ink Cartridge . . . . .	5-2
Cleaning the Print Head . . . . .	5-6
Aligning the Print Head . . . . .	5-8
Cleaning the Printer . . . . .	5-9
Transporting the Printer . . . . .	5-10



---

## Replacing the Ink Cartridge

Your printer's  ink out light tells you when it's time to replace the ink cartridge. A flashing  ink out light indicates that the cartridge is low on ink. When the ink cartridge is empty, the printer stops automatically and the  ink out light is lit continuously.

### **Note:**



- If you need to replace the ink cartridge with a new one before the  ink out light flashes, see “Fixing Ink Cartridge Problems” on page 6-22.*
- EPSON recommends the use of genuine EPSON ink cartridges. Other products not manufactured by EPSON may cause damage to your printer not covered by EPSON's warranties.*



### **Caution:**

- Leave the old cartridge installed in the printer until you are ready to replace it with a new one.*
- Once you remove an ink cartridge, it becomes unusable and cannot be reinstalled even if ink remains. Otherwise, it may damage the printer or cause the ink level sensor to malfunction.*

To replace the ink cartridge, follow these steps.

1. Make sure the  power light is on and the  ink out light is flashing or on.
2. Open the printer cover.





3. Hold down the  cleaning button for three seconds. The  power light begins flashing, and the print head moves left slightly to the cartridge replacement position.

**Caution:**

*Do not move the print head by hand. Always use the  cleaning button to move it. Otherwise you may damage the printer.*

**Note:**

- If you press the  cleaning button for three seconds when the  ink out light is off, the printer starts cleaning the print head.
  - The print head automatically returns to the home (far right) position after about 60 seconds if you don't begin the installation procedure.
4. Lift up the ink cartridge clamp as far as it will go. When you do, the cartridge will rise partly out of the ink cartridge holder.

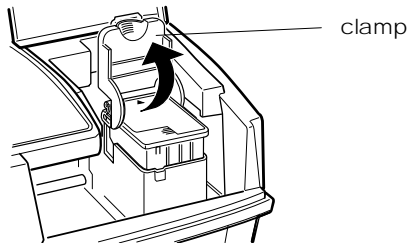
**Caution:**

*Once you open the ink cartridge clamp, the ink cartridge becomes unusable and cannot be reinstalled even if ink remains. Otherwise, it may damage the printer or cause the ink level sensor to malfunction.*

- Lift the cartridge out of the printer and dispose of it properly. Do not take the used cartridge apart or try to refill it.

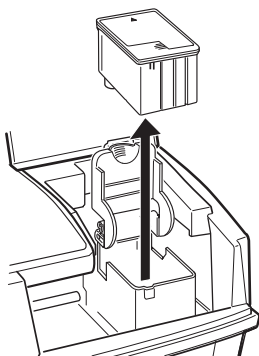

**Warning:**

*If ink gets on your hands, wash them thoroughly with soap and water. If ink gets into your eyes, flush them immediately with water.*

- Open the ink cartridge package. Next, remove only the yellow tape seal from the top of the cartridge as shown below.



**Caution:**

- You must remove the yellow tape seal from the cartridge. Installing the cartridge with the yellow tape still attached will permanently damage it.*
- Do not remove the whole tape seal (especially the white portion) from the top of the cartridge. Only remove the yellow portion.*
- Do not remove the tape seal from the bottom of the cartridge; otherwise, ink will leak.*



(S020138)

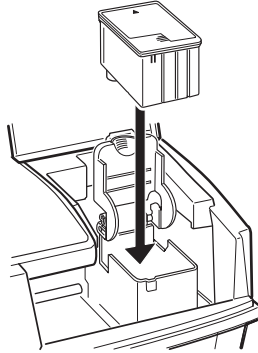

7. Lower the ink cartridge into the holder with the label face up and the arrow mark pointing to the rear. Do not push down on the ink cartridge.



8. Press the ink cartridge clamp down until it locks in place.
9. Press the  cleaning button again to return the print head to the far right position. The printer charges the ink delivery system for about one minute.



**Caution:**

The  power light continues to flash while the printer performs the ink charging operation. Never turn off the printer while the  power light is flashing. Doing so can result in incomplete charging of printer ink.

**Note:**

Even if you do not press the  cleaning button, the printer moves the print head back to its home position about 60 seconds after you replace the ink cartridge.

10. Close the printer cover.

---

## *Cleaning the Print Head*

If you find that the printed image is unexpectedly faint or dots in the printed image are missing, you may be able to solve these problems by cleaning the print head, which ensures that the nozzles are delivering ink properly.

You can clean the print head from your computer with the Head Cleaning utility in the printer software, or from the printer itself by using the printer's control panel buttons.



### **Note:**

- ❑ *Print head cleaning uses ink. To avoid wasting ink, clean the print head only if print quality declines.*
- ❑ *Use the Nozzle Check utility to confirm that the print head needs to be cleaned. This saves ink. See “Utility menu” in online help for more information.*
- ❑ *Do not start the Head Cleaning or Nozzle Check utility while printing is in progress; otherwise your printout may be marred.*
- ❑ *When the  ink out light is flashing or on, you cannot clean the print head. Replace the ink cartridge first.*



### *Using the Head Cleaning utility*

To use the Head Cleaning utility, see “Utility menu” in online help.

### *Using the control panel buttons*

1. Make sure that the  power light is on and the  ink out light is off.

**Note:**

*If the  ink out light is flashing or on, you cannot clean the head, and this operation will start the ink cartridge replacement procedure. If you do not want to replace an ink cartridge at this moment, press the  cleaning button to return the print head to its home position.*

2. Hold down the  cleaning button for three seconds.

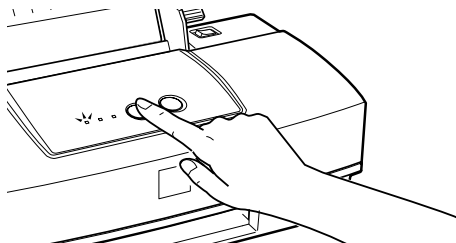

The printer starts cleaning the print head and the  power light begins flashing.



**Caution:**

*This operation takes about one minute to complete. Never turn off the printer while the  power light is flashing.*

3. When the  power light stops flashing, print a few lines from a document to confirm that the head is clean and to reset the cleaning cycle.

If the print quality does not improve, repeat step 2 and then print a few lines to check the output.

---

## *Aligning the Print Head*

If you notice a misalignment of vertical lines, you may be able to solve this problem from your computer using the Print Head Alignment utility.

1. Make sure paper is loaded in the sheet feeder.



**Caution:**

*Use paper at least 210 mm (8.27 inches) wide; for example, A4 size paper loaded short edge first. Otherwise, the print head will spray ink directly onto the platen.*

2. Access the printer software as described in Chapter 3, then click the Utility tab at the top of the printer software window.
3. Click the Print Head Alignment button.
4. Follow the messages on your screen to align the print head.

---

## *Cleaning the Printer*

To keep your printer operating at its best, you should clean it thoroughly several times a year.

1. Make sure the printer is turned off. Then unplug the power cord.
2. Remove any paper from the sheet feeder.
3. Use a soft brush to carefully brush away all dust and dirt.
4. If the outer case or the inside of the sheet feeder is dirty, clean it with a soft, clean cloth dampened with mild detergent. Keep the printer cover closed to prevent water from getting inside.
5. If the inside of the printer accidentally gets soiled with ink, wipe it off with a damp cloth.



### ***Warning:***

*Be careful not to touch the gears inside the printer.*



### ***Caution:***

- Never use alcohol or thinners to clean the printer; these chemicals can damage the components as well as the case.*
- Be careful not to get water on the printer mechanism or electronic components.*
- Do not use a hard or abrasive brush.*
- Do not spray the inside of the printer with lubricants; unsuitable oils can damage the mechanism. Contact your dealer or a qualified service person if lubrication is needed.*

---

## *Transporting the Printer*

To transport your printer, carefully repack it using the original box and packing materials as follows:

1. Open the printer cover and make sure the print head is positioned at the far right of the printer. If not, turn on the printer and wait until the print head returns to the far right position. Turn off the printer and close the printer cover.



**Caution:**

*Leave the ink cartridge installed when you transport the printer. Removing the cartridge during transport can damage the printer.*

2. Unplug the power cord from the electrical outlet; then disconnect the interface cable from the printer.
3. Remove the paper from the sheet feeder and the paper path; then remove the paper support.
4. Attach the protective materials to the printer.
5. Repack the printer and power cord in the original box.
6. Keep the printer flat in the box during transport.



## Chapter 6

# Troubleshooting

---

Diagnosing the Problem . . . . .	6-2
Error indicators . . . . .	6-2
Printer operation check . . . . .	6-3
Problems and Solutions . . . . .	6-5
Power supply . . . . .	6-6
Operation . . . . .	6-7
Paper handling . . . . .	6-12
Printing quality . . . . .	6-15
Increasing the Print Speed . . . . .	6-21
Fixing Ink Cartridge Problems . . . . .	6-22
Contacting Customer Support . . . . .	6-24
For United Kingdom and the Republic of Ireland users . . . . .	6-24
For Australian users . . . . .	6-26
For Singapore users . . . . .	6-28
For Hong Kong users . . . . .	6-28
For Philippines users . . . . .	6-29





## Diagnosing the Problem

If you find something wrong with your printer, you may be able to solve the problem by:

- ❑ Checking the “Error indicators” (see below)
- ❑ Performing a “Printer operation check” (see the next page)
- ❑ Applying the recommended solutions on the “Problems and Solutions” (see page 6-5)

### Error indicators

If your printer stops working and the lights on the control panel are on or flashing, use the following table to diagnose and fix the problem.

			Problem and Solution
-	-	○	<b>Paper Out</b>
No paper is loaded in the printer.			Load paper in the sheet feeder; then press the  load/eject button to turn this light off. The printer resumes printing.
The paper is not loaded correctly.			Remove and reload the paper. See “Loading Paper” in Chapter 3.
-	-	◌◌	<b>Paper Jam</b>
Paper has jammed in the printer.			Take all the paper out of the feeder, and reload the paper. If the light continues to flash, turn off the printer and gently pull all the paper out of the printer. If it tears and pieces remain inside the printer, open the printer cover and remove the pieces of paper.
-	○	-	<b>Ink Out</b>
The ink cartridge is not installed or is empty.			Install or replace the ink cartridge (S020138). See page 5-2.
◌◌	○	○	<b>Carriage Error</b>
Printer failed.			Turn off the printer. After a few seconds turn it on and try printing again. If the error is not cleared, contact your dealer.
◌◌	◌◌	◌◌	<b>Unknown Printer Error</b>
An unknown printer error has occurred.			Turn off the printer, and contact your dealer.

○ = on, ◌◌ = flashing, - = irrelevant

## Printer operation check

Performing a printer operation check can help you determine whether the problem comes from the printer or the computer.

To perform a printer operation check, follow these steps:

1. Make sure both the printer and computer are turned off.
2. Unlock the wire clips on both sides of the interface connector and remove the ground connector, if necessary. Then disconnect the cable from the printer's interface connector.

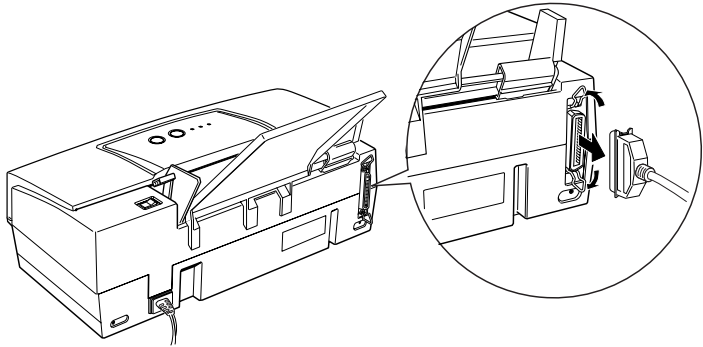

3. Make sure that paper is loaded in the sheet feeder.



**Caution:**

*Use paper at least 182 mm (7.17 inches) wide; for example, B5 size paper loaded short edge first. Otherwise, the print head will spray ink directly onto the platen during the self test and smear any documents you print afterwards.*

4. Hold down the  load/eject button and turn on the printer; then release the button.

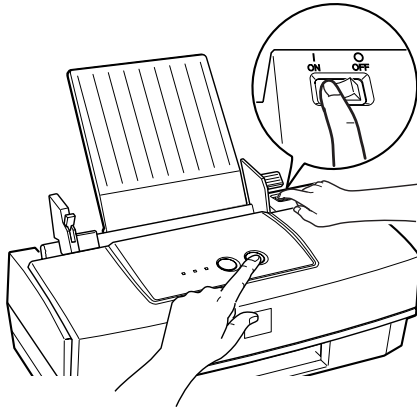

The printer prints an operation check page including the version of your printer's ROM, the ink counter code, and a nozzle check pattern. Here is a typical printout:

The above sample is in black and white, but the actual test prints in color (CMYK).

5. Turn off the printer after it finishes printing one page.
  - ❑ If the operation check page results appear as shown in step 4, this means that the printer itself is all right and that the problem probably lies in the printer software settings, application settings, the interface cable, or the computer itself. See “Problems and Solutions” below for possible causes and solutions to the problem.
  - ❑ If any segment of the printed lines on the operation check page is missing, there is a problem with the printer. This could be a clogged ink nozzle or a misaligned print head. See “Cleaning the Print Head” on page 5-6, or “Aligning the Print Head” on page 5-8.

---

## *Problems and Solutions*

This section divides printer problems into five sections:

- Power supply . . . . page 6-6
- Operation . . . . . page 6-7
- Paper handling . . . page 6-12
- Printing quality . . . page 6-15

Go to the section that most likely contains the source of the problem, and look for the description that matches the problem. The causes and solutions are listed from the most likely to the least likely, so try them in the order that they are written until the problem is solved.

## Power supply

### The lights come on briefly but then go off and stay off.

Cause	What to do
The printer's voltage rating does not match the voltage of your electrical outlet.	Check the printer and outlet voltage ratings. If the voltages do not match, unplug the printer immediately and contact your dealer.



#### **Warning:**

*Do not reconnect the power cord to an electrical outlet that does not have matching voltage.*

### The printer does not work and the control panel lights are off.

Cause	What to do
The printer is turned off.	Turn on the printer. The  power light will come on.
The electrical outlet is controlled by an outside switch or automatic timer.	Use a different outlet.
The electrical outlet is out of order.	Plug another electrical device into the outlet to determine whether the outlet is working. If it is not, use a different outlet.
The power cord is not properly plugged into the electrical outlet.	Turn off the printer, make sure the power cord is firmly plugged into the electrical outlet, and turn the printer back on. If the lights don't come on, contact your dealer.

## Operation

### The power light is on but nothing prints.

Cause	What to do
The interface cable is not plugged in securely.	Confirm that the cable is securely fastened to the printer and the computer. If the cable is connected correctly, perform a printer operation check as described on page 6-3.
Your interface cable does not meet both the printer and computer specifications.	Use an interface cable that meets both printer and computer specifications. See page 1-5.
Your software is not properly set up for your printer.	Make sure that your printer is selected in your software.  If you cannot select your printer, install or reinstall the printer software as described in Chapter 2.

### Nothing prints and several of the control panel lights are on or flashing.

Cause	What to do
Several common printer errors have occurred at once.	Use the table in “Error indicators” earlier in this chapter to determine what combination of errors may have occurred, and apply the recommended solutions.

### **The printer sounds like it is printing, but nothing prints.**

<b>Cause</b>	<b>What to do</b>
The print head nozzles are clogged.	Clean the print head. See page 5-6. If this does not work after a few trials, contact your dealer.
The ink cartridge is older than six months or beyond the date on the packaging.	Try cleaning the print head. If that does not solve the problem, replace the ink cartridge. If the V light is off, see “Fixing Ink Cartridge Problems” on page 6-22.

### **The printer operation check page prints well, but nothing prints from an application.**

<b>Cause</b>	<b>What to do</b>
Your printer is not selected in your software.	Select your printer in the printer setup section of your software.
The interface cable does not meet both the printer and computer requirements.	Use a printer cable that meets the requirements shown under “Interface cables“ on page 1-5.
Your computer is not 100% IBM <sup>®</sup> AT compatible.	Select Use Print Manager for this port in the Queue Setup window. To access this window, double-click the EPSON Spool Manager4 icon in the EPSON folder and select Setup from the Queue menu.
Your computer system’s memory is insufficient to handle the volume of data in your document.	Try reducing the image resolution of your document in your image-editing software.  Install more memory in your computer if you can.  Select lower resolution or less colors for your display setting as described below.



For Windows 95, choose a lower resolution setting as the Color Palette setting. To access the Color Palette, click Start, point to Settings, and choose Control Panel. Then double-click the Display icon and click the Settings tab. For detailed information on making this setting, see your Windows 95 user's guide.

For Windows 3.1, double-click the Windows Setup icon on the Main menu; then click Options and choose Change System Settings. Then choose a lower resolution setting for your display from the Display pop-up list. For detailed information on making this setting, see your Windows 3.1 user's guide.

If you have a display adapter setting utility, use it to set lower resolution. For detailed information, see your display board user's guide.

### **Color documents print out in black and white.**

<b>Cause</b>	<b>What to do</b>
Your printer is not selected in your software.	Select your printer in your software.
Color printing is not selected in your application or in the printer driver.	Select color printing in your application and the printer driver. Try to print again. If the image still comes out in black and white, try printing from another program. If this fixes the problem, contact the manufacturer of the application you had trouble with.

### Printing starts too high or too low on the page.

Cause	What to do
Margins are set incorrectly in your application.	Check that the margins are set correctly in your program. See “Printable area” in the Appendix.
The size of the paper loaded in the printer does not match the paper size setting within your application.	Load the correct size of paper, or change the paper size settings within your application to match the size of the paper you are using.



### Print speed is not what you expect.

Cause	What to do
The image resolution and the amount of color used in the document may be too high.	Carefully considering your use of color and resolution can help you optimize your printing times. For more details, see “Increasing the Print Speed” later in this chapter.

**Note:**

*High resolution printing and color printing significantly increase the amount of data to be processed. These two factors have the greatest effect on print speed.*

### The print head moved to the ink cartridge replacement position unexpectedly.

Cause	What to do
The  cleaning button was pressed while the  ink out light was flashing or on.	The ink cartridge is low or out of ink. Replace the ink cartridge as described on page 5-2.

**The New Hardware Found screen appears even though the printer software has already been installed.**

<b>Cause</b>	<b>What to do</b>
This error may occur in the Windows 95 operating system.	In the New Hardware Found screen, click Do not install a driver [Windows will not prompt you again], then click OK.

**The Status Monitor window does not appear (Windows 95 only).**

<b>Cause</b>	<b>What to do</b>
The Use Print Manager for this port option is checked in the Queue Setup window.	<b>Make sure</b> Use Print Manager for this port is not checked. Click the Start button, point to Programs, point to Epson, and click Spool Manager4. Then click Setup on the Queue menu in the EPSON Spool Manager window.
The Enable bi-directional support for this printer option is not selected in the Spool Settings window.	<b>You must select</b> Enable bi-directional support for this printer in the Spool Settings window to use the Status Monitor. To access the Spool Settings window, click the Start button, point to Settings, and click Printers. Right-click the icon for your printer and choose Properties from the drop-down menu. Click the Details tab; then click Spool Settings. Select Enable bi-directional support for this printer.

## *Paper handling*

<b>Paper does not feed properly from the sheet feeder.</b>	
------------------------------------------------------------	--

<b>Cause</b>	<b>What to do</b>
The paper may have been loaded too deeply into the printer.	Remove the paper and gently reinsert it straight up and down into the printer.
Too many sheets are loaded in the sheet feeder.	Take the paper stack out of the feeder, remove some sheets, and reload the stack. Load paper only up to the arrow mark on the left edge guide.
The edge guides are not set correctly.	Adjust the guides against the stack of paper. See “Loading Paper” in Chapter 3.
Paper is jammed in the paper path.	Turn off the printer and gently pull all of the paper out of the printer. If it tears and pieces remain inside the printer, open the printer cover; then remove any remaining pieces of paper.
The paper is curled or folded.	Use flat, undamaged paper.
The paper is old or creased.	Use only new, smooth sheets of paper.
The paper’s size is not compatible with the printer.	Use paper that meets the paper requirements for this printer. See “Paper” in the Appendix.
The paper is too thin.	Make sure the paper meets the paper requirements for this printer. See “Paper” in the Appendix.

### **The printer loads more than one sheet at a time.**

<b>Cause</b>	<b>What to do</b>
The paper may have been loaded too deeply into the printer.	Remove the paper and gently reinsert it straight up and down into the printer.
Too many sheets are loaded in the sheet feeder.	Take the paper stack out of the feeder, remove some sheets, and reload the stack. Load paper only up to the arrow mark on the left edge guide.
The edge guides are not set correctly.	Adjust the guides against the stack of paper. See “Loading Paper” in Chapter 3.
The paper thickness lever or the adjust lever position may not be set correctly.	Make sure the paper thickness lever and adjust lever positions are set correctly. See page 4-2.
The paper is too thin.	Make sure the paper meets the paper requirements for this printer. See “Paper” in the Appendix.

### **Ejected paper is wrinkled.**

<b>Cause</b>	<b>What to do</b>
The paper is too thin or damp.	Do not store your paper in a damp or humid environment. Store paper in its original packaging.

## **Paper does not fully eject.**

<b>Cause</b>	<b>What to do</b>
The paper is too long.	Press the  load/eject button to eject the paper. Use paper that meets the paper requirements for this printer. See “Paper” in the Appendix.

## **Paper feed or paper jam problems occur frequently.**

<b>Cause</b>	<b>What to do</b>
Sheets of paper are stuck together.	Fan the stack of paper and straighten it before loading.
The edge guides are not set correctly.	Adjust the guides against the stack of paper.
The paper is too thin or rough.	Make sure the paper meets the paper requirements for this printer. See “Paper” in the Appendix.
Special media that should be loaded one sheet at a time is loaded more than one sheet at a time.	Check the loading capacity for special media described on page 4-5.
Too many sheets are loaded in the sheet feeder.	Load paper only up to the arrow mark on the left edge guide.
The printable side of the paper is not loaded correctly.	Try turning the stack of paper over in the sheet feeder. Most packages of paper indicate the printable side with an arrow on the end of the package. Make sure the printable side is loaded face up.

## Printing quality

### The printed image has gaps or faint areas.

Cause	What to do
The paper thickness lever or the adjust lever position may not be set correctly.	Make sure the paper thickness lever and adjust lever positions are set correctly. See page 4-2.
The print head nozzles are clogged.	Clean the print head. See page 5-6.
The paper quality has been reduced due to age.	Use new paper.
The printer driver settings may not be correct.	Select Automatic on the printer driver's Main menu and make sure the Media Type setting is appropriate for the type of paper loaded in the printer. See online help. To access online help, see page 3-7.

### The printed image is blurred.

Cause	What to do
Your paper is moist or damp.	Do not store your paper in a damp or humid environment. Store the paper in its original packaging.
The printer driver settings may not be correct.	Select Automatic on the printer driver's Main menu and make sure the Media Type setting is appropriate for the type of paper loaded in the printer. See online help. To access online help, see page 3-7.

## Printed image is smeared.

### Cause

### What to do

The paper thickness lever or the adjust lever position may not be set correctly.

Make sure the paper thickness lever and adjust lever positions are set correctly. See page 4-2.

Special paper was loaded without the support sheet or a regular sheet of paper under it.

Load the support sheet or a piece of plain paper under the special paper.

Multiple sheets of EPSON Photo Quality Glossy Film are loaded.

Load glossy film one sheet at a time with the loading support sheet or a piece of plain paper under the glossy film.

If you need to load multiple sheets of glossy film, load only up to 30 sheets and set the top margin of the page to 30 mm or more.

Ink has leaked on the platen.

Wipe the inside of the printer as shown below with a soft, clean cloth.

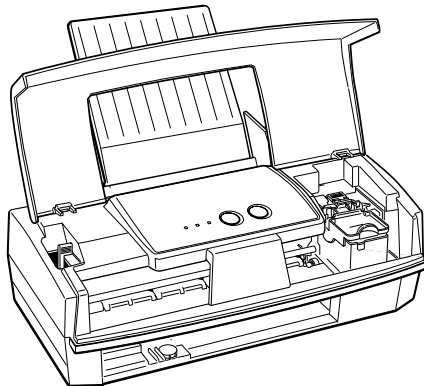

### **Warning:**

*Be careful not to touch the gears inside the printer.*



### White horizontal lines appear in the printed image.

Cause	What to do
The print head nozzles are clogged.	Clean the print head. See page 5-6.
The ink cartridge is low on ink.	Check the control panel to confirm that the  ink out light is flashing, and replace the ink cartridge. See page 5-2.
The Media Type setting on the Main menu of the printer driver is incorrect.	Make sure the Media Type setting matches the type of paper loaded in the printer. See online help. To access online help, see page 3-7.

### Vertical lines do not align.

Cause	What to do
The print head is misaligned.	Align the print head. See page 5-8.
The printing position is misaligned.	Make sure the High Speed option in your printer driver's More Settings dialog box is not selected.

## Printing quality is not what you expect.

Cause	What to do
The paper loaded is not the paper selected in your application or the printer driver.	<p>Make sure you load the correct paper in the printer and that you select the same media type in your application and/or the printer driver. For information on Media Type settings in the printer driver, see online help.</p> <p>Make sure you are using paper that meets the paper requirements for this printer. See “Paper” in Appendix.</p>
You are not printing on the correct side of the paper.	Check the paper packaging for the correct side for printing; then load the printable side of the paper face up in the sheet feeder.
The printer driver settings are not correct.	Check the printer driver settings to make sure they are appropriate. If these settings are correct, check the settings in your application, because some driver settings are overridden by application settings. Also, for more information on making appropriate printer driver settings, see online help.

## Colors are different than what you expect.

Cause	What to do
Black ink is selected in your printer driver.	Set the Ink setting to Color.
The paper is not loaded printable side up.	Make sure that the printable side of the paper is facing up.

The Media Type setting does not match the paper loaded.	Change the Media Type setting in your printer driver to match the type of media you have loaded, or load media that matches the Media Type setting. See online help.
The print head nozzles for a particular color of ink are clogged.	Clean the print head. See page 5-6.
The ICM setting in your driver is not appropriate for your document.	Select Automatic on the printer driver's Main menu.
Your printer and monitor are not properly calibrated for color matching.	See the user's guides of your image-editing software and your monitor for information on calibrating your system for color matching.
Since monitors and printers produce colors differently, printed colors will not always match on-screen colors perfectly.	See online help or the EPSON Answers CD-ROM for color printing information.

### Colors are not very vibrant.

Cause	What to do
The image was printed on the wrong side of ink jet paper.	Make sure that you are printing on the coated side of the paper. If necessary, flip over the paper and try printing again. If printing does not improve clean the print head.
The Media Type setting does not match the loaded paper.	Make sure the Media Type setting matches the type of paper loaded in the printer, or load media that matches the Media Type setting. See online help.

**Color dots are missing in printed characters or graphics.  
The printed color image has gaps or faint areas.**

Cause	What to do
The color print head nozzles are clogged.	Clean the print head. See page 5-6.

**Black dots are missing in printed characters or graphics.  
The printed black image has gaps or faint areas.**

Cause	What to do
The black print head nozzles are clogged.	Clean the print head. See page 5-6.

**Photographic images look grainy or rough.**

Cause	What to do
The printing position is misaligned.	Align the print head. See page 5-8.
The resolution of the original image data or the resolution setting for the image in your image-editing software may be too low.	Increase the image resolution in your image-editing software. Keep in mind that higher resolution images take longer to print.

**Even after using the Head Cleaning utility, the output quality does not improve.**

Cause	What to do
You attempted to clean the print head while the ink cartridge was low or out of ink.	Check the  ink out light. If the light is on or flashing, the Head Cleaning utility does not work. Replace the ink cartridge. See page 5-2.

---

## Increasing the Print Speed

Just as printing at a high resolution requires more processing time, printing in color takes longer than printing in black because the volume of data in a color document is much greater. For this reason, it is important to be selective in your use of color if you also require a faster print speed.

The following table shows the factors that inversely affect print speed and print quality (increasing one will decrease the other).

	Priority	
	Print speed	Print quality
<b>Printer driver settings</b>		
Print Quality	Economy	Fine - 720 dpi
High Speed	On	Off
Halftoning	No Halftoning	Error Diffusion
<b>Data characteristics</b>		
Image size	Small	Large
Resolution	Low	High

The table below shows the factors related to print speed only.

	Print speed	
	Faster	Slower
<b>Printer software settings</b>		
Ink	Black	Color
Collate*	Off	On
Flip Horizontal*	Off	On
Reverse Order*	Off	On
Page rotate*	Off	On
<b>Data characteristics</b>		
Variety of colors	Grayscale **	Full color

	Print speed	
	Faster	Slower
<b>Hardware resources</b>		
System speed	Fast	Slow
HDD free space	Large	Small
Memory free space	Large	Small
<b>Software status</b>		
Running applications	One	Many
Virtual memory	Not in use	In use

\*Varies depending on the printer driver and application software you are using.

\*\*Grayscale means using black ink only to print varying shades of gray, from pure black to pure white.

---

## Fixing Ink Cartridge Problems

If output quality does not improve even after cleaning (page 5-6) and aligning (page 5-8) the print head, you may need to replace the ink cartridge.

### **Note:**

*Be sure to use up ink cartridges by the date marked on the cartridge label; otherwise the ink may become unusable.*



To replace an ink cartridge before the  ink out light flashes, follow the steps below.



### **Caution:**

*Once you remove an ink cartridge, it becomes unusable and cannot be reinstalled even if ink remains. Otherwise, it may damage the printer or cause the ink level sensor to malfunction.*

1. Make sure the printer is on, then open the printer cover.

2. Hold down the  load/eject button for three seconds, the print head moves to the replace position. The  power light begins flashing.
3. Lift the ink cartridge clamp. Dispose of the ink cartridge properly.
4. Remove the yellow tape seal from the new cartridge and lower the cartridge into the cartridge holder.
5. Press the ink cartridge clamp down until it locks in place.





**Caution:**

*Once you install the cartridge, do not open the clamp again until you replace the ink cartridge. Otherwise, the cartridge may become unusable.*

6. Press the  load/eject button again. The printer moves the print head back to its home position and charges ink in the system.



**Caution:**

*The  power light continues to flash while the printer performs the ink charging operation. Never turn off the printer while the  power light is flashing. Doing so can result in incomplete charging of ink.*

**Note:**

*Even if you do not press the  load/eject button, the printer moves the print head back to its home position about 60 seconds after you replace the cartridge.*

---

## *Contacting Customer Support*

If your printer is not operating properly and you cannot solve your problem with the troubleshooting information in this guide and EPSON Answers, contact customer support services for assistance.

To help you much more quickly, please give us the exact information below.

**Serial number of your printer:**

(See the label on the back of the printer.)

**Printer model:**

**Brand and model of your computer:**

**Printer software version:**

(Click About on the printer driver's Main menu.)

**Version of Windows (95, 3.1, etc.) you are using now:**

**Version of software applications you normally use with your printer:**

### *For United Kingdom and the Republic of Ireland users*

If you purchased your printer in the UK or the Republic of Ireland, Epson (UK) Limited provides a range of customer services and technical support.

**Note:**

*For customers in the Republic of Ireland, please use the correct dialing codes when dialing the UK telephone numbers listed in the following sections. For example the Enquiry Desk fax number, 01442 227271, should be dialed as 0044 1442 227271 from the Republic of Ireland.*



## *Enquiry Desk*

The enquiry desk team can be contacted by calling 0800 220546 in the UK or 1 800 409132 from the Republic of Ireland, by faxing 01442 227271, and via the Internet at [info@epson.co.uk](mailto:info@epson.co.uk). They can provide the following information:

- ❑ Information and literature on new EPSON products (also available from Faxon Epson)
- ❑ Where to purchase genuine EPSON consumables, accessories and options

## *Customer Support*

Our Customer Support team can provide the following services:

- ❑ Technical information on installing, configuring, and operating your EPSON products
- ❑ Arranging for faulty EPSON products to be repaired within the warranty period

For information on contacting our Customer Support team, please see the Service and Support Information booklet that came with your EPSON product.

If this booklet is not available, details can be found on Faxon Epson faxback service, EPtec Bulletin Board Service or on EPSON's World Wide Web site. See below for details.

## *Faxon Epson*

Contact Faxon Epson faxback service for:

- ❑ Literature and specifications on the latest EPSON products
- ❑ Support information including troubleshooting tips, switch settings and driver information

To use Faxon Epson, call 01442 227332 using a touch-tone phone. You will be asked to follow a simple routine to register your document request, and once you have entered your telephone and fax numbers, Faxon Epson will fax a copy of the document catalogue to your fax machine.

When you have found the documents that you need in the catalogue, call Faxon Epson again and enter the document ID numbers. The documents will be faxed to you automatically.

### *EPtec - Bulletin Board Service*

Call the Epson Bulletin Board Service on 01442 227479 for the latest drivers and utilities. No membership is required. Make sure that your communications software is set to 8 data bits, 1 stop bit, no parity bit, ANSI terminal mode emulation and a modem speed of up to 28.8 Kbps. Downloading protocols supported include Xmodem, Ymodem and Zmodem. See the documentation that came with your communications software and modem for more information.

When you first connect to the Bulletin Board Service, you will be asked for your name, company name, phone number and a password (which you can invent yourself).

### *World Wide Web*

If you can connect to the Internet and have a Web Browser, you can access EPSON's World Wide Web site at <http://www.epson.com>. Here you will find information on the latest EPSON products, software drivers, and answers to frequently asked questions.

### *For Australian users*

EPSON Australia wishes to provide you with a high level of Customer Service. As well as this *User's Guide*, we provide the following sources for obtaining information:

## EPSON FAXBACK

EPSON FAXBACK will fax you the latest specifications and pricing for most EPSON products offered in Australia. There is also technical information including details of the latest software and drivers available. Phone (02) 9903 9075 and the system will guide you through a number of choices before faxing the information to your fax machine.

## EPSON Bulletin Board System

This is where you can download the latest software and drivers. Visit the BBS to check out the latest versions. If you have a modem, phone (02) 9417 5090.

## Internet URL <http://www.epson.com.au>

Access the EPSON Australia World Wide Web pages. Worth taking your modem here for the occasional surf! You can get the same information as offered on the EPSON FAXBACK and the EPSON Bulletin Board plus more.

## Your Dealer

Don't forget that your dealer can often help identify and resolve problems. The dealer should always be the first call for advice on problems. They can often solve problems quickly and easily as well as give you advice on the next step to take.

## EPSON Helpdesk

EPSON Helpdesk is provided as a final backup to make sure our clients have access to advice. Operators on the Helpdesk can aid you in diagnosing hardware and software problems. They can also advise you on the latest EPSON products and where the nearest dealer or service agent is located. Many types of queries are answered here.

Access to the Helpdesk is at no charge to purchasers of new products for the first 12 months of that product's life. After that period, a different phone number is used and charges are debited to your telephone account. The current charge rates are specified when you ring the chargeable support number. You are asked to signify your acceptance before any charges are incurred.

The Helpdesk numbers are:

first 12 months	(02) 9903 9040
after 12 months	1 902 263 192
fax number	(02) 9903 9189

We encourage you to have all the relevant information on hand when you ring. The more information you prepare, the faster we can help solve the problem. This information includes the user's guide for your EPSON product, type of computer, operating system, application programs, and any other information you feel is required.

### *For Singapore users*

Contact the telephone and fax numbers below:

Phone:	(065) 337-7911
Fax:	(065) 334-1185

### *For Hong Kong users*

To obtain technical support as well as other after-sales services, users are welcome to contact EPSON Hong Kong Limited.

### *Internet home page*

EPSON Hong Kong has established a local home page in both Chinese and English on the Internet to provide users with the following information:

- Product information
- Answers to Frequently Asked Questions (FAQs)
- Latest versions of EPSON printer drivers

Users can access our World Wide Web home page at:  
<http://www.epson.com.hk>.

### *Electronic bulletin board system*

An electronic bulletin board system (BBS) is also available to obtain printer information and the latest versions of printer drivers. You can log on to the following number for the BBS service: (852) 2827-4244

### *Technical Support Hotline*

You can also contact our technical staff at the following telephone and fax numbers:

Phone: (852) 2585-4399

Fax: (852) 2827-4383

### *For Philippines users*

To obtain technical support as well as other after sales services, users are welcome to contact the EPSON Philippines Representative Office at the telephone and fax numbers below:

Phone: (632) 813-6552

Fax: (632) 813-6545

BBS: (632) 814-0595



*Appendix*

---

***Printer Specifications***

Printing . . . . . A-2

Paper . . . . . A-2

    Printable area . . . . . A-4

Ink Cartridge (S020138) . . . . . A-5

Mechanical . . . . . A-6

Electrical . . . . . A-6

Environmental . . . . . A-7

Safety Approvals . . . . . A-7



---

## Printing

Printing method:	On-demand ink jet
Nozzle configuration:	Monochrome (black) 31 nozzles Color (cyan, magenta, yellow) 33 nozzles (11 (each color) × 3)
Resolution:	Maximum 360-dpi raster on a 720-dpi x 720-dpi matrix. Dots are printed in an alternating pattern in which horizontal and vertical dots are non-contiguous. Contiguous printing of dots is available only on the diagonal plane, which yields an effective resolution greater than 360dpi.
Print direction:	Bidirectional with logic seeking
Input buffer:	25KB

---

## Paper

**Note:**

*Since the quality of any particular brand or type of paper may be changed by the manufacturer at any time, EPSON can not attest to the quality of any non-EPSON brand or type of paper. Always test samples of paper stock before purchasing large quantities or printing large jobs.*

**Single sheets:**

Size	A4 (210 mm × 297 mm) B5 (182 mm × 257 mm) Letter (216 mm × 279 mm) Half letter (139.7 mm × 215.9 mm) Legal (216 mm × 356 mm) Executive (184.2 mm × 266.7 mm)
Paper types	Plain bond paper
Thickness	0.08 mm to 0.11 mm (0.003 to 0.004 inch)
Weight	64 g/m <sup>2</sup> (17 lb) to 90 g/m <sup>2</sup> (24 lb)



**Envelopes:**

Size	No. 10 (104 mm × 240 mm) DL (110 mm × 220 mm)
Paper types	Plain bond paper, air mail
Thickness	0.16 mm to 0.52 mm (0.006 to 0.02 inch)
Weight	45 g/m <sup>2</sup> (12 lb) to 90 g/m <sup>2</sup> (24 lb)

**Index cards:**

Size	A6 (105 mm × 148 mm)
Paper types	Special papers distributed by EPSON

**Transparencies, glossy film, glossy paper:**

Size	A4 (210 mm × 297 mm) Letter (216 mm × 279 mm) A6 (105 mm × 148 mm) Glossy film only
Paper types	Special papers distributed by EPSON

**Self adhesive sheets:**

Size	A4 (210 mm x 297 mm)
Paper types	Special papers distributed by EPSON

**Photo paper:**

Size	4 x 6" (102 mm x 152 mm)
Paper types	Special papers distributed by EPSON

**Note:**

*When printing on envelopes, index cards, and adhesive sheets you must set the paper thickness lever to "Thick Paper" position.*

*Poor quality paper may reduce print quality and cause paper jams or other problems. If you encounter problems, switch to a higher grade of paper.*

*Do not load curled or folded paper.*

*Ink jet paper, envelopes, glossy film/paper, and transparencies are only usable under normal conditions:*

Temperature	15 to 25°C (59 to 77°F)
Humidity	40 to 60% RH

**A**

## Printable area

Single sheets/index cards/adhesive sheets/transparencies

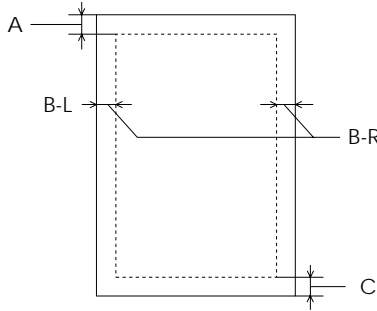

## Envelopes

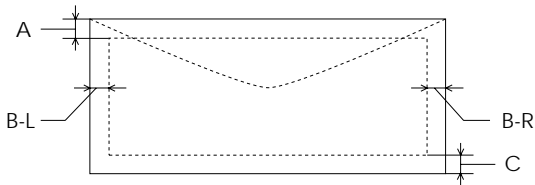

A: The minimum top margin is 3.0 mm (0.12 inch).

When loading multiple sheets of EPSON Photo Quality Glossy Film, the minimum top margin is 30 mm (1.2 inches).

B: The minimum left margin is 3.0 mm (0.12 inch).

The minimum right margin for single sheet paper is 3.0 mm (0.12 inch) except for letter and legal size paper. The minimum right margin for letter and legal size paper is 10.0 mm (0.35 inch).

The minimum right margin for envelopes is as follows:

13.8 mm (0.54 inch) for DL envelopes.

33.8 mm (1.32 inches) for No. 10 envelopes.

C: The minimum bottom margin is 14.0 mm (0.54 inch).

### **Note:**

*Always load paper into the sheet feeder short edge first. Load envelopes top edge first with the flap side down.*

---

## Ink Cartridge (S020138)

Colors	Cyan, Magenta, Yellow, and Black
Print capacity*	220 pages (A4, 360 dpi, 5% duty each color) 450 pages (A4, Text, monochrome printing only)
Cartridge life	2 years from production date if unopened; 6 months if opened at 25°C (77°F)
Temperature	Storage: -30 to 40°C (-22 to 104°F) 1 month at 40°C (104°F) Transit: -30 to 60°C (-22 to 140°F) 1 month at 40°C (104°F) 120 hours at 60°C (140°F) Freezing:** -6°C (21.2°F)
Dimensions	45.9 mm (W) × 56.5 mm (D) × 38.5 mm (H)

\* The print capacity may vary, depending on how often you use the print head cleaning function and how often you use the printer.

\*\* It thaws and is usable after approximately 3 hours at 25°C (77°F).



**Caution:**

- EPSON recommends the use of original EPSON ink cartridges only. Other products not manufactured by EPSON may cause damage to your printer not covered by EPSON's warranties.*
- Do not use an ink cartridge if the date on the package has expired.*

---

## ***Mechanical***

Paper feed method:	Friction
Paper path:	Sheet feeder, rear entry
Sheet feeder capacity:	About 100 sheets at 64 g/m <sup>2</sup> (17 lb) paper
Dimensions:	Storage Width: 396.7 mm (15.6 inches) Depth: 205.6 mm (8.1 inches) Height: 162.0 mm (6.4 inches)  Printing Width: 396.7 mm (15.6 inches) Depth: 321 mm (20.8 inches) Height: 267.3 mm (10.5 inches)
Weight:	3.9 kg (8.6 pounds) without the ink cartridge

---

## ***Electrical***

	120V Model	220–240V Model
Input voltage range	103.5 to 132V	198 to 264V
Rated frequency range	50 to 60 Hz	
Input frequency range	49.5 to 60.5 Hz	
Rated current	0.5 A	0.3 A
Power consumption	Approx. 15W (ISO10561 Letter Pattern)	

**Note:**

*Check the label on the back of the printer for the voltage of your printer.*

---

## *Environmental*

Temperature:	Operation: 10 to 35°C (50 to 95°F) Storage: * -20 to 60°C (-4 to 140°F) 1 month at 40°C (104°F) 120 hours at 60°C (140°F)
Humidity:	Operation: 20 to 80% RH Storage: ** 5 to 85% RH
	* Stored in shipping container ** Without condensation

---

## *Safety Approvals*

### Safety standards:

U.S. model	UL 1950 with D3, CSA C22.2 No.950 with D3
------------	-------------------------------------------

European model	EN60950 (TÜV and NEMKO)
----------------	-------------------------

### EMI:

U.S. model	FCC part 15 subpart B class B, CSA C108.8 class B
------------	---------------------------------------------------

European model	EN 55022 (CISPR Pub. 22) class B EN 50082-1 EN 61000-3-2 EN 61000-3-3
----------------	--------------------------------------------------------------------------------

Australian model	AS/NZS 3548 class B
------------------	---------------------





---

# Glossary

The following definitions apply specifically to printers.

***application***

A software program that helps you carry out a particular task, such as word processing or financial planning.

***banding***

The horizontal lines that sometimes appear when printing graphics. This occurs when the print head is misaligned.

***bidirectional printing***

Printing in which the print heads print in both directions. This increases the speed of printing.

***bit***

A binary digit (0 or 1), which is the smallest unit of information used by a printer or computer.

***brightness***

The lightness or darkness of an image.

***buffer***

The portion of the printer's memory used to store data before printing it.

***byte***

A unit of information consisting of eight bits.

***characters per inch (cpi)***

A measure of the size of text characters, sometimes referred to as pitch.

***CMYK***

Cyan (blue-green), magenta, yellow, and black. These colored inks are used to create the subtractive system array of printed colors.

***cpi***

See *characters per inch*.

***default***

A value or setting that takes effect when the equipment is turned on, reset, or initialized.

***dithering***

A halftoning method in which dots are arranged in an orderly pattern. Dithering works best for printing images with solid colors, such as charts and graphs. See also *halftoning*.

***dot matrix***

A method of printing in which each letter or symbol is formed by a pattern (matrix) of individual dots.

***dpi***

Dots per inch. The dpi measures the resolution. See also *resolution*.

***driver***

A software program that sends instructions to a computer peripheral to tell it what to do. For example, your printer driver accepts print data from your word processor application and sends instructions to the printer on how to print this data.

***economy printing***

Printing in which images are printed with fewer dots to save ink.

***error diffusion***

This halftoning setting smoothes out edges by blending dots of varying colors.

***font***

A style of type designated by a family name.

***grayscale***

A scale of shades of gray from black to white. Grayscale is used to represent colors when printing with black ink only.

***halftones***

Patterns of black or colored dots used to reproduce an image.

***halftoning***

Method of using dot patterns to represent an image. Halftoning makes it possible to produce varying shades of gray using only black dots, or a nearly infinite array of colors using only a few colors of dots. See also *halftones*.

***high speed printing***

Printing in which images are printed in both directions. This provides faster printing.

***initialization***

Returns the printer to its defaults (fixed set of conditions). This happens every time you turn on the printer or reset the printer.

***ink jet***

A method of printing in which each letter or symbol is formed by precisely spraying ink onto paper.

***interface***

The connection between the computer and a peripheral such as a printer. Generally, printers have two interfaces, parallel and serial. A parallel interface transmits data one byte, or eight bits, at a time. A serial interface transmits data one bit at a time.

***loading position***

The position to which the paper is automatically loaded.

***media***

Materials upon which data is printed, such as envelopes, plain paper, special paper, and transparencies.



***monochrome***

This means printing with only one color of ink, which is generally black ink.

***parallel interface***

See *interface*.

***printable area***

The area of a page on which the printer can print. It is smaller than the physical size of the page due to margins.

***printer driver***

A software program that sends commands for using the features of a particular printer. Often shortened to “driver”.

***Printer Operation Check***

A method for checking the operation of the printer. When you perform a printer operation check, the printer prints the ROM version, ink counter code, and a nozzle check pattern.

***print head alignment***

A maintenance procedure you should perform when the black and color inks on your printout are misaligned or the printout seems fuzzy.

***printing mode***

The number of dots per inch used to represent an image. Your printer has three printing mode settings: Fine (720 dpi), Normal (360 dpi), and Economy.

***print queue***

If your printer is connected to a network, print jobs that are sent to the printer while it is busy are stored in a waiting line, or print queue, until they can be printed.

***RAM***

Random Access Memory. The portion of the printer’s memory used as a buffer and for storing user-defined characters. All data stored in RAM is lost when the printer is turned off.

***reset***

To reinitialize the printer, or return a printer to its defaults by turning the printer off and then back on.

***resolution***

The number of dots per inch used to represent an image.

***ROM***

Read Only Memory. A portion of memory that can only be read and cannot be used for data storage. ROM retains its contents when you turn off the printer.

***RGB***

Red, green, and blue. These colors, in phosphors irradiated by the computer monitor’s electron gun, are used to create the additive array of screen colors.

***spool***

The first step in printing. The printer driver converts the print data into codes that your printer understands. This data is then sent to the printer directly or to the print server.

***spool manager***

The software program that converts print data into codes that your printer understands.

***status monitor***

The software program that allows you to check the amount of ink remaining before printing. This is available for Windows 95 only.

***subtractive colors***

Colors produced by pigments that absorb some colors of light and reflect others. See also *CMYK*.

<b>EPSON OVERSEAS MARKETING LOCATIONS</b>
-------------------------------------------

---

**EPSON AMERICA, INC.**

20770 Madrona Ave.  
P.O. Box 2842  
Torrance, CA 90509-2842  
Phone: (800) 922-8911  
Fax: (310) 782-5220

**EPSON UK LTD.**

Campus 100, Maylands Avenue,  
Hemel Hempstead, Herts,  
HP2 7TJ, U.K.  
Phone: (+44) 01442 61144  
Fax: (+44) 01442 227227

---

**EPSON DEUTSCHLAND GmbH**

Zülpicher Straße 6,  
40549 Düsseldorf Germany  
Phone: (0211) 56030  
Telex: 8584786

**EPSON FRANCE S.A.**

68 bis, rue Marjolin  
92300, Levallois-Perret, France  
Phone: 33.1.40.87.37.37  
Telex: 610657

---

**EPSON AUSTRALIA PTY. LTD.**

70 GIBBES STREET, CHATSWOOD 2067 NSW.  
Phone: 2-9903-9000  
Fax: 2-9903-9177

**EPSON SINGAPORE PTE. LTD.**

No. 1 Temasek Avenue #36-00  
Millenia Tower, Singapore 039192  
Phone: (065) 33 77 911  
Fax: (065) 33 41 185

---

**EPSON HONG KONG LTD.**

Rooms 4706-10, 47/F,  
China Resources Bldg.,  
26 Harbour Road, Wanchai, Hong Kong  
Phone: 2585-4300  
Fax: 2827-7083

**EPSON TAIWAN TECHNOLOGY & TRADING LTD.**

10F, No. 287 Nanking E. Road, Sec. 3,  
Taipei, Taiwan, R.O.C.  
Phone: (02) 717-7360  
Fax: (02) 712-9164

---

**EPSON ITALIA S.p.A.**

V.le F.lli Casiraghi 427  
20099 Sesto S.Giovanni  
MI, Italy  
Phone: 2-262331  
Fax: 2-2440750

**EPSON IBERICA S.A.**

Av. de Roma, 18-26  
08290 Cerdanyola del Valles  
Barcelona, Spain  
Phone: 582. 15.00  
Fax: 582. 15.55

---

**SEIKO EPSON CORPORATION  
(Hirooka Office)**

80 Harashinden, Hirooka  
Shiojiri-shi, Nagano-ken  
399-07 Japan

**EPSON PORTUGAL, S.A.**

R. do Progresso, 471, 1º Perafita  
4460 Matosinhos, Portugal  
Phone: (02) 996 14 02  
Fax: (02) 996 14 11

**EPSON**

Ink Jet Printer

**EPSON** *Stylus* COLOR 300

**User's Guide**



# NOTICE

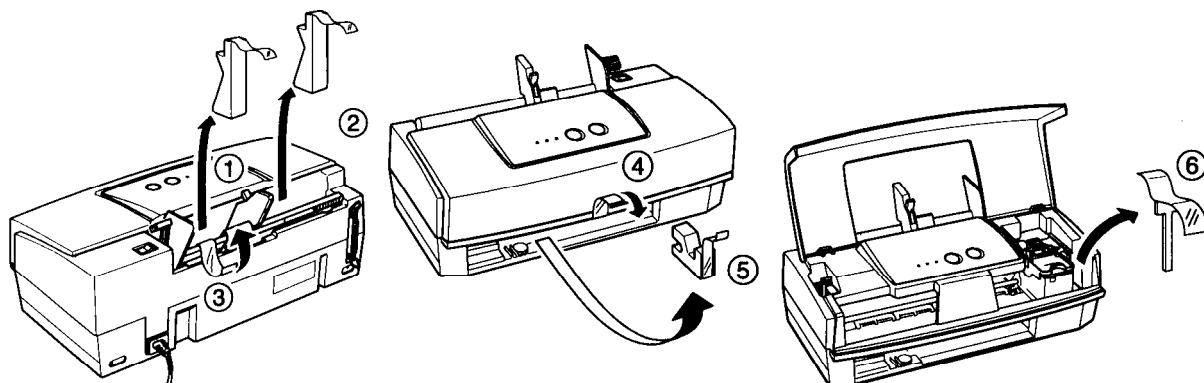

---

## NOTE:

To prevent damage during shipping, several pieces of blue protective material are packed with your printer. You must remove these before you assemble your printer.

---

## HINWEIS:

Zur Vermeidung von Transportschaden ist der Drucker durch schützende Verpackungsteile (blaufarbig) gesichert. Diese Teile müssen vor dem Zusammenbau des Druckers entfernt werden.

---

## ATTENTION:

Afin d'éviter tout dommage durant le transport, des matériaux de protection bleus ont été emballés avec votre imprimante. Vous devez les retirer avant d'installer votre imprimante.

---

## NOTA:

Para evitar daños durante el transporte, su impresora viene protegida por varias piezas azules de material protector. Debe retirar estas piezas antes de montar su impresora.

---

## NOTA:

L'imballaggio della vostra stampante contiene molti elementi protettivi di colore blu, per prevenire danni durante il trasporto. Non dimenticate di toglierli prima di iniziare a utilizzare la stampante.

---

## NOTA:

Para evitar danos durante o transporte, esta impressora possui materiais de protecção de cor azul. Retire-os antes de instalar a impressora.

---

# **Ink Charging** **Requires Up to 4 Minutes!**

*NEVER **turn off** the printer while the  power light is flashing; you will use up more ink than necessary.*

*ALWAYS see and follow your printer user's guide.*

---

## **Die Aktivierung des Tintenzuleitungssystems** **dauert ca. 4 Minuten!**

*Schalten Sie den Drucker **NIEMALS** aus, solange die Anzeige Betriebsbereit bzw.  blinkt, ansonsten verbrauchen Sie unnötig Tinte.*

*Lesen und befolgen Sie dazu **UNBEDINGT** das Benutzerhandbuch.*

---

## **Le processus de chargement** **de l'encre dure environ 4 minutes!**

***Ne mettez jamais l'imprimante hors tension** tant que le voyant Marche/Arrêt clignote sinon vous utiliserez plus d'encre que nécessaire.*

*Veillez **toujours** consulter et suivre les consignes de chargement d'encre du manuel d'utilisation de votre imprimante.*

# For EPSON Special Media Users

If a cleaning sheet is packed with your special media, feed it through the printer every time you finish printing a package of paper, or you may experience paper loading problems. If you have an EPSON Stylus COLOR 300, follow the instructions on the cleaning sheet for Type ① printers. If you have an EPSON Stylus COLOR 1520 or an EPSON Stylus COLOR 3000, follow the instructions on the cleaning sheet for Type ② printers.