

EPSON

Ink Jet Printer

EPSON *Stylus*[™] COLOR 600

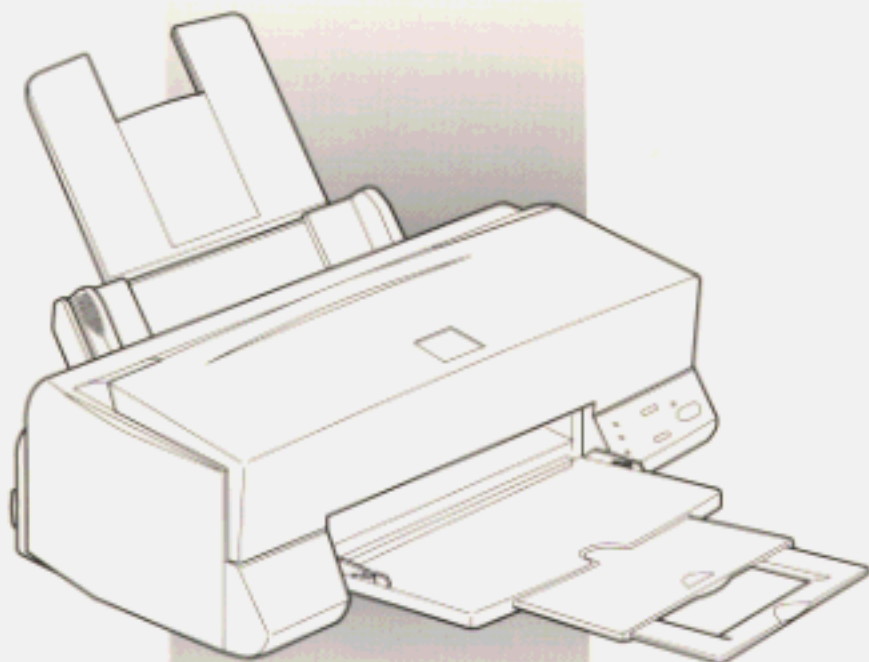

User's Guide

Where to Find Information

This User's Guide

Provides you with all the information you need to use your EPSON Stylus COLOR 600 and consumable products, from setting up to troubleshooting. If you use Microsoft® Windows NT®, see the Windows NT-based software users guide.

Online Help

Provides you with detailed information and instructions on the printer software that controls your printer. (Online help will be automatically installed when you install the printer software.)

EPSON Answers (for Windows 95 and 3.1 only)

Provides Windows 95 and 3.1 users with additional information on using your printer and printing with colors. Here's what you'll find in EPSON Answers:

- ❑ **How To** displays a step-by-step guide for using your printer, information about printer maintenance, and instructions on replacing consumable products.
- ❑ **Problem Solver** helps you fix common printing problems when you encounter them.
- ❑ **Test Print** lets you print a test page to check the results of settings you have made and provides links to other sections of EPSON Answers based on the results.
- ❑ **Color Guide** explains the ABC's of color printing and shows you how to get impressive results from your printer. (A printed *Color Guide* is also included with your printer.)

EPSON® Stylus™ COLOR 600

Color Ink Jet Printer

All rights reserved. No part of this publication may be reproduced, stored in a retrieval system, or transmitted in any form or by any means, electronic, mechanical, photocopying, recording, or otherwise, without the prior written permission of SEIKO EPSON CORPORATION. The information contained herein is designed only for use with this EPSON printer. EPSON is not responsible for any use of this information as applied to other printers.

Neither SEIKO EPSON CORPORATION nor its affiliates shall be liable to the purchaser of this product or third parties for damages, losses, costs, or expenses incurred by the purchaser or third parties as a result of: accident, misuse, or abuse of this product or unauthorized modifications, repairs, or alterations to this product, or (excluding the U.S.) failure to strictly comply with SEIKO EPSON CORPORATION's operating and maintenance instructions.

SEIKO EPSON CORPORATION shall not be liable for any damages or problems arising from the use of any options or any consumable products other than those designated as Original EPSON Products or EPSON Approved Products by SEIKO EPSON CORPORATION.

EPSON and EPSON ESC/P are registered trademarks and EPSON ESC/P 2 and EPSON Stylus are trademarks of SEIKO EPSON CORPORATION.

Microsoft and Windows are registered trademarks of Microsoft Corporation.

General Notice: Other product names used herein are for identification purposes only and may be trademarks of their respective owners. EPSON disclaims any and all rights in those marks.

Copyright © 1996 by SEIKO EPSON CORPORATION, Nagano, Japan.



Printed on Recycled Paper.

User's Guide

Declaration of Conformity

According to ISO/IEC Guide 22 and EN 45014

Manufacturer: SEIKO EPSON CORPORATION
Address: 3-5, Owa 3-chome, Suwa-shi,
Nagano-ken 392 Japan

Representative: EPSON EUROPE B.V.
Address: Prof. J. H. Bavincklaan 5 1183
AT Amstelveen
The Netherlands

Declares that the Product:

Product Name: Ink Jet Printer
Type Name: EPSON Stylus COLOR 600
Model: P954A

Conforms to the following Directive(s) and Norm(s):

Directive 89/336/EEC:

EN 55022 Class B
EN 61000-3-2
EN 61000-3-3
EN 50082-1
IEC 801-2
IEC 801-3
IEC 801-4

Directive 73/23/EEC:

EN 60950

December 1996

M. Hamamoto
President of EPSON EUROPE B.V.

Contents

Safety Instructions

Important Safety Instructions	1
A few precautions	2
ENERGY STAR Compliance	3
For United Kingdom Users	4
Warnings, Cautions, and Notes	5

Chapter 1 Getting to Know Your Printer

Printer Parts and Control Panel Functions	1-2
System Requirements	1-4
When using your printer with a PC	1-4
When using your printer with a Macintosh	1-5
Options and Consumable Products	1-7
Options	1-7
Consumable products	1-7

Chapter 2 Getting Started

Unpacking the Printer	2-2
Attaching the Paper Support	2-3
Choosing a Place for the Printer	2-3
Using a printer stand	2-4
Plugging in the Printer	2-5
Installing the Ink Cartridges	2-6
Connecting the Printer to Your PC	2-11
Installing the Printer Software in Your PC	2-12
Installing in Windows 95	2-13
Installing in Windows 95 (using plug-and-play)	2-14
Installing in Windows 3.1	2-18

Connecting the Printer to Your Macintosh	2-20
Installing the Printer Software in Your Macintosh	2-21
Installing the printer software	2-21
Printer software components	2-23
Using the Chooser to select your printer	2-24

Chapter 3 Starting to Print

Loading Paper	3-2
Printing with Windows	3-5
Printing with a Macintosh	3-8

Chapter 4 Using the Printer Software for Windows

Introducing the Printer Software Functions	4-2
Accessing the Printer Software	4-3
From Windows applications	4-3
From Windows 95	4-4
From Windows 3.1	4-5
Using the Automatic Setting	4-6
Using the Predefined Settings	4-7
Customizing the Print Settings	4-9
Saving your settings	4-10
Making the Media Type Setting	4-11
Using EPSON Printer Utilities	4-13
EPSON Status Monitor	4-14
Nozzle Check	4-15
Head Cleaning	4-15
Print Head Alignment	4-15
Checking Printer Status	4-16
Understanding the EPSON Spool Manager	4-16
Understanding the Despooler	4-17
Getting Information Through Online Help	4-18
From Windows applications	4-18
From Windows 95	4-18
From Windows 3.1	4-18

Chapter 5 Using the Printer Software for Macintosh

Introducing the Printer Software Functions	5-2
Using the Automatic Setting	5-3
Using the Predefined Settings	5-5
Customizing the Print Settings	5-8
Making your settings	5-8
Saving your settings	5-9
Choosing your settings	5-10
Modifying visual effects	5-10
Controlling the printing quality	5-15
Changing the Paper Size	5-18
Defining a Custom Paper Size	5-19
Using EPSON Printer Utilities	5-20
EPSON StatusMonitor	5-21
Nozzle Check	5-22
Head Cleaning	5-23
Print Head Alignment	5-23
Using the EPSON Monitor2 Utility	5-24

Chapter 6 Printing on Special Paper

Loading Special Paper and Other Media	6-2
About special media cleaning sheets	6-5
Loading Envelopes	6-6
Loading Transparencies	6-7
Using EPSON Photo Paper (S041134)	6-8
Loading	6-8
Removing the perforated margins	6-10
Storing EPSON Photo Paper	6-10

Chapter 7 Maintenance and Transportation

Replacing an Ink Cartridge	7-2
Cleaning the Printer	7-8
Transporting the Printer	7-9

Chapter 8 *Troubleshooting*

Diagnosing the Problem	8-2
Error indicators	8-2
Status Monitor	8-4
Printer operation check	8-4
Problems and Solutions	8-7
Power supply	8-7
Operation	8-8
Paper handling	8-14
Printing quality	8-17
Increasing the Print Speed	8-24
Cleaning the Print Head	8-26
Aligning the Print Head	8-29
Ink Cartridge Problems	8-30
Contacting Customer Support	8-34
For United Kingdom and the Republic of Ireland users	8-34
For Australian users	8-37
For Hong Kong and Singapore users	8-39
For Philippines users	8-40

Appendix A Using the Printer with DOS

Installing the Printer Software for DOS Programs	A-2
Using Built-in Fonts and Character Tables	A-3
Fonts	A-4
Cleaning the Print Head	A-6
Aligning the Print Head	A-7
Using Power-On Functions	A-8

Appendix B Tips for Color Printing

Basics of Color	B-2
Image Resolution and Image Size	B-5
Basics of Color Documents	B-7

Appendix C Specifications

Technical Specifications	C-2
Printing	C-2
Paper	C-4
Ink cartridges	C-7
Mechanical	C-8
Electrical	C-8
Environmental	C-9
Initialization	C-9
Default settings	C-10
Safety approvals	C-11
Interface Specifications	C-12
Parallel interface	C-12
Serial interface	C-13
ESC/P 2 Control Codes	C-14
Character Tables	C-15
International character sets	C-19
Characters available with ESC (^ command	C-20

Glossary

Index

Safety Instructions

Important Safety Instructions

Read all of these instructions and save them for later reference. Follow all warnings and instructions marked on the printer.

- Do not place the printer on an unstable surface or near a radiator or heat source.
- Place the printer on a flat surface. The printer will not operate properly if it is tilted or at an angle.
- Do not block or cover the openings in the printer's cabinet. Do not insert objects through the slots.
- Use only the type of power source indicated on the printer's label.
- Connect all equipment to properly grounded power outlets. Avoid using outlets on the same circuit as photocopiers or air control systems that regularly switch on and off.
- Do not use a damaged or frayed power cord.
- If you use an extension cord with the printer, make sure the total ampere rating of the devices plugged into the extension cord does not exceed the cord's ampere rating. Also, make sure the total ampere rating of all devices plugged into the wall outlet does not exceed the wall outlet's ampere rating.
- Unplug the printer before cleaning. Clean with a damp cloth only. Do not spill liquid on the printer.
- Except as specifically explained in this guide, do not attempt to service the printer yourself.

- ❑ Unplug the printer and refer servicing to qualified service personnel under the following conditions:

If the power cord or plug is damaged; if liquid has entered the printer; if the printer has been dropped or the cabinet damaged; if the printer does not operate normally or exhibits a distinct change in performance. Adjust only those controls that are covered by the operating instructions.

- ❑ If you plan to use the printer in Germany, observe the following:

To provide adequate short-circuit protection and over-current protection for this printer, the building installation must be protected by a 16 Amp circuit breaker.

Bei Anschluß des Druckers an die Stromversorgung muß sichergestellt werden, daß die Gebäudeinstallation mit einem 16 A-Überstromschalter abgesichert ist.

A few precautions

Even if you are familiar with other types of printers, be sure to read through the following list of precautions before operating your ink jet printer.

- ❑ Do not put your hand inside the printer or touch the ink cartridges during printing.
- ❑ Under normal circumstances, ink will not come out of the cartridges. If it does get on your skin, wash it off with soap and water. If it gets in your eyes, flush them immediately with water.
- ❑ Keep ink cartridges out of the reach of children.
- ❑ Do not dismantle the ink cartridges or try to refill them. This could result in damage to the print head.

- ❑ Once you install an ink cartridge, do not open the clamp or remove the cartridge except to replace it with a new one. The cartridge may become unusable otherwise.
- ❑ Install the ink cartridge immediately after you remove it from its package. Leaving the cartridge unpacked for a long time before use may result in reduced print quality.
- ❑ Do not use an ink cartridge beyond the date printed on the cartridge carton. For best results, use up the ink cartridges within six months of installing them.
- ❑ Do not shake an ink cartridge; this can cause leakage.
- ❑ Always turn the printer off using the ⏻ power button. When this button is pressed, the ⏻ power light flashes briefly then goes out. Do not unplug the printer or turn off the power to the outlet until the ⏻ power light is off.
- ❑ Before transporting the printer, make sure the print head is capped in the far right position and the ink cartridges are in place.

ENERGY STAR Compliance



As an ENERGY STAR Partner, EPSON has determined that this product meets the ENERGY STAR guidelines for energy efficiency.

The International ENERGY STAR Office Equipment Program is a voluntary partnership with the computer and office equipment industry to promote the introduction of energy-efficient personal computers, monitors, printers, fax machines, and copiers in an effort to reduce air pollution caused by power generation.

For United Kingdom Users

Use of options

Epson (UK) Limited shall not be liable against any damages or problems arising from the use of any options or consumable products other than those designated as Original EPSON Products or EPSON Approved Products by Epson (UK) Limited.

Safety information



Warning: *This appliance must be earthed. Refer to rating plate for voltage and check that the appliance voltage corresponds to the supply voltage.*

Important: *The wires in the mains lead fitted to this appliance are coloured in accordance with the following code:*

Green and yellow — Earth

Blue — Neutral

Brown — Live

If you have to fit a plug:

As the colours of the mains lead of this appliance may not match coloured markings used to identify the terminals in a plug, please proceed as follows:

The green and yellow wire must be connected to the terminal in the plug which is marked with the letter E or the Earth symbol (\perp).

The blue wire must be connected to the terminal in the plug marked with the letter N.

The brown wire must be connected to the terminal in the plug marked with the letter L.

If damage occurs to the plug, replace the cord set or consult a qualified electrician.

Replace fuses only with a fuse of the correct size and rating.

Warnings, Cautions, and Notes



Warnings must be followed carefully to avoid bodily injury.



Cautions must be observed to avoid damage to your equipment.

Notes contain important information and useful tips on the operation of your printer.





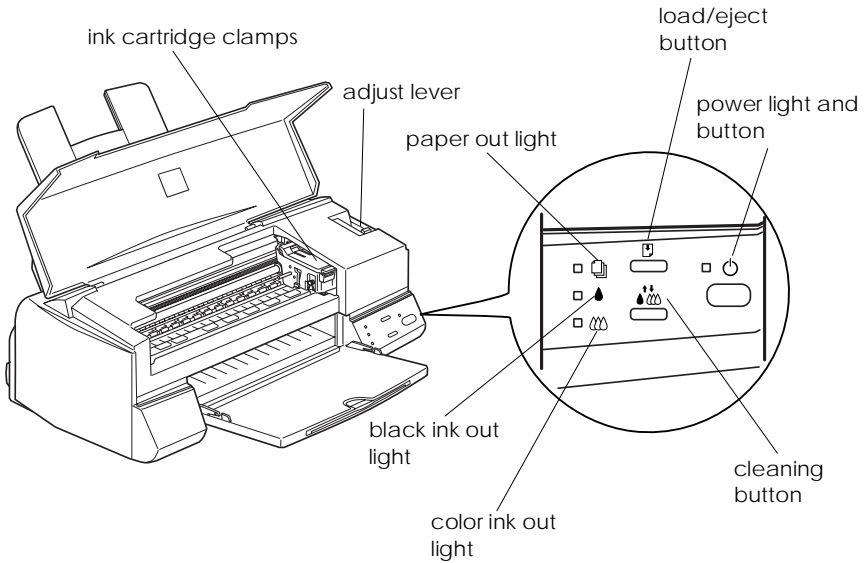
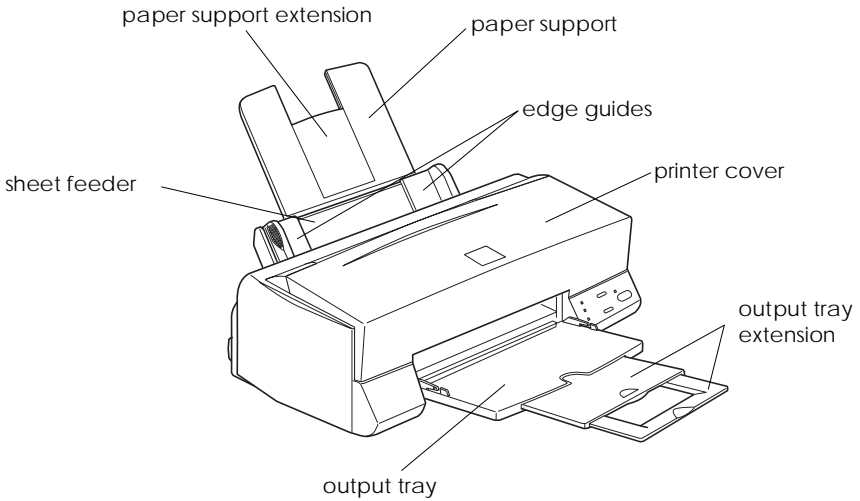

Getting to Know Your Printer

Printer Parts and Control Panel Functions	1-2
System Requirements	1-4
When using your printer with a PC	1-4
When using your printer with a Macintosh	1-5
Options and Consumable Products	1-6
Options	1-6
Consumable products	1-6

Printer Parts and Control Panel Functions









Buttons

Button	Function
 power	Turns the printer on and off. Clears the print buffer if pressed twice while the power is on.
 load/eject	Loads or ejects paper if pressed and released within two seconds. Resumes printing if pressed after a paper out error.
 cleaning	Moves the print head to the replacement position if pressed for about three seconds while the  or  ink out light is flashing or on. Returns the print head to its home position after ink cartridge replacement. Performs print head cleaning if pressed for about three seconds when both the  and  ink out lights are off.

Lights

The lights on the front of the printer indicate the printer status, such as receiving data, paper jam, or low on ink. The following table describes what the lights mean.

				Printer Status
○	-	-	-	Printer is on.
◐	-	-	-	Receiving data, replacing an ink cartridge, charging ink, or cleaning print head.
-	○	-	-	Paper out. Load paper in the sheet feeder; then press the  load/eject button to resume printing.
-	◐	●	●	Paper jam. Take all the paper out of the sheet feeder, reload the paper, then press the  load/eject button. If the light continues to flash, turn off the printer and gently pull out any paper that may be jammed in the printer.
-	-	◐	-	Ink low. The black ink cartridge is nearly empty. Obtain a black ink cartridge (S020093).
-	-	○	-	Ink out. The black ink cartridge is empty. Replace the black ink cartridge (S020093).
-	-	-	◐	Ink low. The color ink cartridge is nearly empty. Obtain a color ink cartridge (S020089).
-	-	-	○	Ink out. The color ink cartridge is empty. Replace the color ink cartridge (S020089).

○ = on, ● = off, ◐ = flashing, - = irrelevant

System Requirements

When using your printer with a PC

To use your printer, you need Microsoft Windows 3.1, Windows for Workgroups, Windows 95, Windows NT 4.0, or DOS; and a shielded, twisted-pair parallel cable. For system requirements and details on using the printer software with Windows NT, see the *Windows NT 3.51/4.0 Printer software User's Guide*.

To install and use the printer software (printer driver and utilities) included on the CD-ROM or floppy disk packed with your printer, the following is required:

Minimum system	Recommended system
80386/16 MHz processor	Pentium processor
16MB RAM	32MB RAM
20MB hard disk space	More than 50MB free hard disk space
VGA monitor	VGA or better monitor

If you decide to use the EPSON Answers online guide included with your printer software, your system should also meet the following requirements:

- At least 20MB of free disk space for full program installation
- Double-speed CD-ROM drive (Quad-speed or faster recommended)

Your computer dealer can help you update your system if it does not meet these requirements.

When using your printer with a Macintosh

The following are the hardware and system requirements that must be met to use this printer with a Macintosh.

Applicable computer models (as of July 1, 1996)

Macintosh LC II, LC III, LC475, LC520, LC575, LC630
 Macintosh IIcx, IIci, IIsi, IIvi, IIvx
 Macintosh Quadra Series
 Macintosh Centris Series
 Macintosh PowerBook™ Series (excluding PowerBook 100)
 Macintosh PowerBook Duo Series
 Macintosh Performa Series
 Power Macintosh Series

Interface cables

To use your printer with a Macintosh, you need a standard Apple System Peripheral-8 cable (8-pin mini-circular connector) or equivalent.

Environment

Minimum system	Recommended system
System 7.1	System 7.5 or later
3MB of available memory	8MB or more of available memory

Note:

- ❑ *The amount of available memory varies according to the number and kind of applications that are open. To see how much memory is available, choose About This Macintosh from the Apple menu and refer to the memory size (listed in kilobytes) under “Largest Unused Block” (1,024K=1MB).*
- ❑ *The memory requirements above are for printing on Letter size paper. These requirements may vary depending on the size of the paper, the type of application you are using, and the complexity of the document you want to print.*
- ❑ *You need an additional 1MB of available memory when background printing is turned on.*

In addition to these system and memory requirements, you also need 6MB of free hard disk space to install your printer software. To print, you need extra hard disk space amounting to about double the size of the file you want to print.

Options

The following options are available for use with your printer.

Interface cables

EPSON supplies several types of interface cables. You can use any interface cable that meets the specifications listed below. See your computer manual for any additional requirements.

Parallel Interface Cable (shielded) C83602* from D-SUB 25-pin (computer) to 36-pin Amphenol 57 series (printer)

Note:

The asterisk is a substitute for the last digit of the product number, which varies by country.

Consumable products

Ink cartridges

Black ink cartridge	S020093
Color ink cartridge	S020089

EPSON special media

Most plain paper works well in your printer. In addition, paper specifically designed for ink jet printers such as EPSON's *360 dpi Ink Jet Paper* will meet most high-quality printing needs.

EPSON 360 dpi Ink Jet Paper (A4)	S041059
	S041025
EPSON 360 dpi Ink Jet Paper (Letter)	S041060
EPSON Photo Quality Ink Jet Paper (A4)	S041061
	S041026
EPSON Photo Quality Ink Jet Paper (Letter)	S041062
EPSON Photo Quality Ink Jet Paper (Legal)	S041067
EPSON Photo Quality Ink Jet Card (A6)	S041054
EPSON Photo Quality Ink Jet Card (5 × 8 in.)	S041121
EPSON Photo Quality Ink Jet Card (8 × 10 in.)	S041122
EPSON Photo Quality Glossy Film (A4)	S041071
EPSON Photo Quality Glossy Film (Letter)	S041072
EPSON Photo Quality Glossy Film (A6)	S041107
EPSON Photo Quality Glossy Paper (A4)	S041126
EPSON Photo Quality Glossy Paper (Letter)	S041124
EPSON Ink Jet Transparencies (A4)	S041063
EPSON Ink Jet Transparencies (Letter)	S041064
EPSON Photo Quality Self Adhesive Sheet (A4)	S041106
EPSON Photo Paper (4 × 6 in.)	S041134

Note:

- ❑ *The availability of special media varies by country.*
- ❑ *Ink jet printers are particularly sensitive to the condition of your paper. Keep unused paper in its original packaging and store it in a cool, dry place.*

Chapter 2

Getting Started

2

Unpacking the Printer	2-2
Attaching the Paper Support	2-3
Choosing a Place for the Printer	2-3
Using a printer stand	2-4
Plugging in the Printer	2-5
Installing the Ink Cartridges	2-6
Connecting the Printer to Your PC	2-11
Installing the Printer Software in Your PC	2-12
Installing in Windows 95	2-13
Installing in Windows 95 (using plug-and-play)	2-14
Installing in Windows 3.1	2-18
Connecting the Printer to Your Macintosh	2-20
Installing the Printer Software in Your Macintosh	2-21
Installing the printer software	2-21
Printer software components	2-23
Using the Chooser to select your printer	2-24

Unpacking the Printer

Your printer box should contain a CD-ROM, which includes the printer driver software that runs your printer, and the following items:

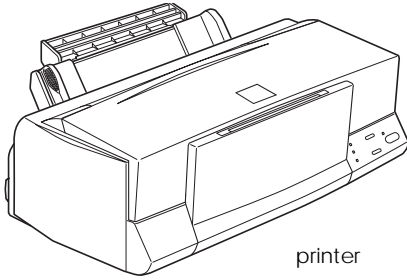

printer

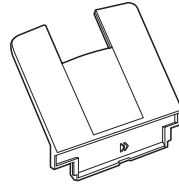

paper support



power cord



black ink cartridge

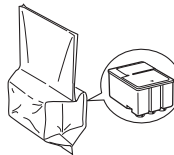

color ink cartridge

In some locations, the power cord comes attached to the printer. The shape of the AC plug varies by country; be sure the plug included is the right shape for your location.

Remove all protective materials packed with your printer before you set it up and turn on the power. Follow the instructions inserted with the printer to remove these materials. Save all packaging and protective materials in case you need to transport the printer later.

Attaching the Paper Support

Insert the paper support into the slots at the rear of the printer as shown below.

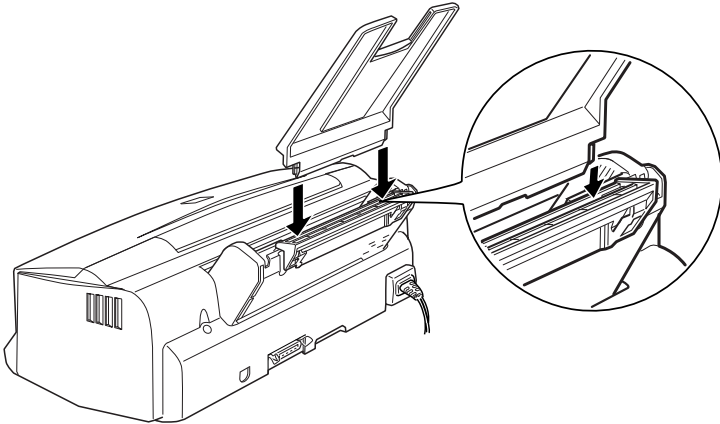

Note:

To print on transparencies, you need to reposition the paper support as described in “Loading Transparencies” in Chapter 6.

Choosing a Place for the Printer

Follow the guidelines listed below when placing your printer.

- Place the printer on a flat, stable surface. The printer will not operate properly if it is tilted or at an angle.
- Place the printer close enough to the computer for the interface cable to reach it easily.
- Leave adequate room for easy operation and maintenance.
- Leave enough room on the table at the front of the printer to lower the output tray.

- ❑ Avoid using or storing the printer in places subject to rapid changes in temperature and humidity. Also keep it away from direct sunlight, strong light, or heat sources.
- ❑ Avoid places subject to shocks and vibrations.
- ❑ Place the printer near a wall outlet where the plug can be easily unplugged.

Note for French-speaking users:

Placez l'imprimante près d'une prise de contact où la fiche peut être débranchée facilement.

- ❑ Avoid electrical outlets controlled by wall switches or automatic timers. Also, avoid outlets on the same circuit as large motors or other appliances that can cause fluctuations in line voltage.
- ❑ Keep the entire computer system away from potential sources of electromagnetic interference, such as loudspeakers or the base units of cordless telephones.
- ❑ Use a grounded power outlet; do not use an adapter plug.

Using a printer stand

When using a printer stand, note the following:

- ❑ Use a stand that can support at least 11.0 kg (24.3 lb).
- ❑ Never use a stand that tilts the printer. The printer should always be kept level.

Plugging in the Printer

1. Make sure that the printer is turned off. It is off when the  power button protrudes slightly from the surface of the control panel.

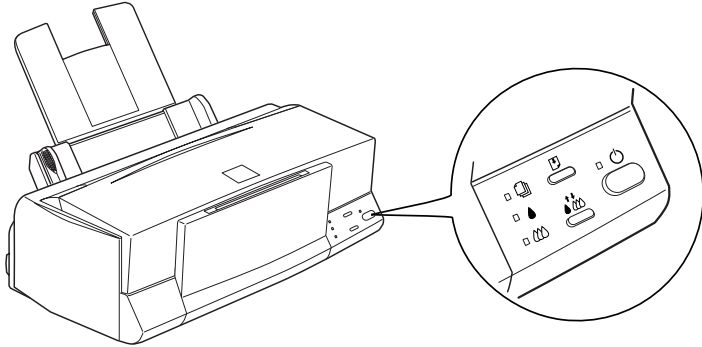

2. Check the label on the back of the printer to make sure the voltage required by the printer matches that of the electrical outlet you will be plugging it into. Also, make sure that you have the correct power cable for your power source.



Caution:

It is not possible to change the printer's voltage. If the rated voltage and your outlet voltage do not match, contact your dealer for assistance. Do not plug in the power cord.

3. If the power cord is not attached to the printer, connect it to the AC inlet on the back of the printer.
4. Plug the power cord into a properly grounded electrical outlet.

Installing the Ink Cartridges



Warning:

The ink cartridges are self-contained units. Under ordinary use, ink will not leak from a cartridge. If ink does get on your hands, wash them thoroughly with soap and water. If ink gets into your eyes, flush them immediately with water.

Install the ink cartridges as follows:

Note:

Do not open the ink cartridge packages until just before you install the cartridges, or the ink may dry up.

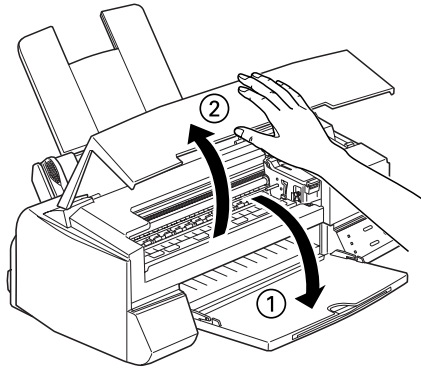

1. Lower the output tray at the front of the printer; then, holding the center edge of the cover, open the printer cover.

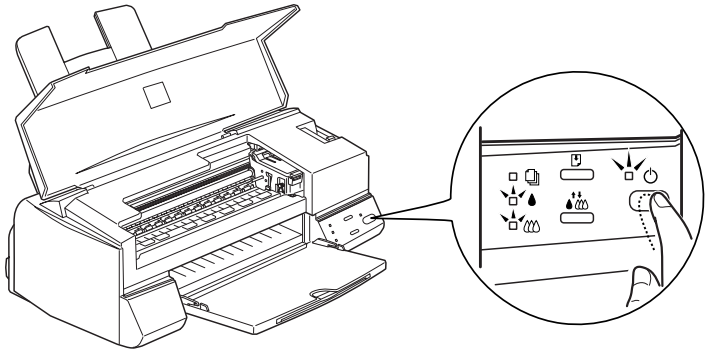

2. Turn on the printer by pressing the  power button.



2

The print head moves slightly to the left, which is the ink cartridge install position. The  power light flashes and the  and  ink out lights come on.

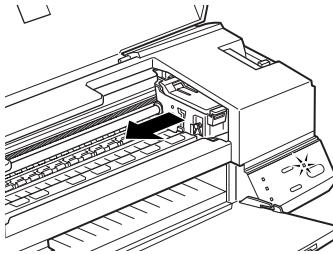

Caution:

Do not move the print head by hand. Otherwise you may damage the printer.

3. Lift up the two ink cartridge clamps.

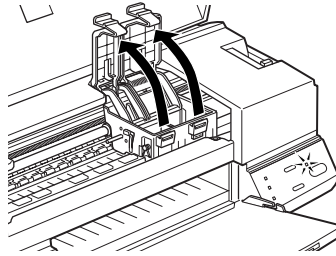

4. Open the ink cartridge packages. Next, remove only the yellow tape seals from each cartridge as shown below.



black ink cartridge
(S020093)

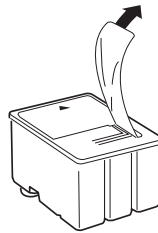

color ink cartridge
(S020089)



Caution:

- You must remove the yellow tape seals from the cartridges. If you attempt to print using a cartridge with this tape seal still attached, the cartridge may become unusable.
- Do not remove the whole tape seal (especially the white portion) from the top of the cartridge. Remove only the yellow portion.
- Do not remove the tape seals from the bottom of the cartridges; otherwise, ink will leak.

- Lower the cartridges into their holders with the labels face-up and the arrow marks pointing to the rear. The color cartridge, which is larger, goes on the right and the black ink cartridge goes on the left.

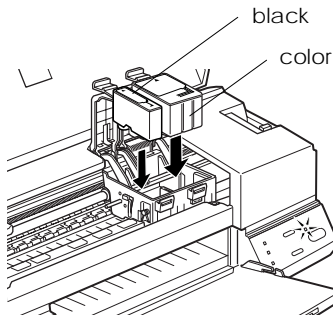

Note:

Install both ink cartridges. If either of the cartridges is not installed, the printer will not work.

- Press the ink cartridge clamps down until they lock in place.

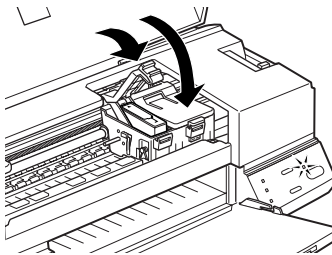

Caution:

Once you install the ink cartridges, do not open their clamps again until you replace the ink cartridges. Otherwise, the cartridges may become unusable.

7. Press the  cleaning button then close the printer cover. The printer moves the print head and begins charging the ink delivery system.



Note:

Even if you do not press the  cleaning button, the printer moves the print head and begins the ink charging process about 60 seconds after you install the cartridges.

The ink charging process takes about five minutes to complete, during which time the printer produces a variety of mechanical sounds. These sounds are normal. When the ink delivery system has been charged, the print head returns to its home (far right) position.



Caution:

During the ink charging process, the  power light flashes. Never turn off the printer while the  power light is flashing.

The life of a cartridge depends on the amount of text and graphics you print. The life of a color ink cartridge depends on the amount and the number of colors used in your documents.

Note:

When ink runs out, see “Replacing an Ink Cartridge” in Chapter 7.

Now you are ready to connect the printer to your computer. To connect the printer to your PC, see the following section. To connect it to your Macintosh, see page 2-21.

Connecting the Printer to Your PC

To connect the printer to your computer using the built-in parallel interface, you will need a shielded, twisted-pair parallel cable. To connect the printer to a Macintosh, see page 2-20.

2

Follow the steps below to connect the printer to the computer:

1. Make sure both the printer and computer are turned off.
2. Plug the cable connector securely into the printer's interface connector. Then squeeze the wire clips together until they lock in place on both sides. If your cable has a ground wire, connect it to the ground connector below the interface connector.

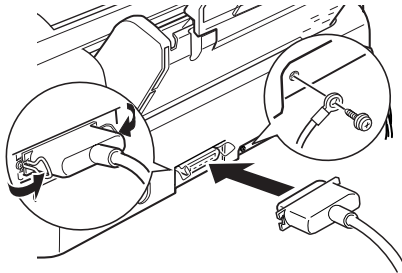

3. Plug the other end of the cable into the computer's parallel interface. If there is a ground wire at the computer end of the cable, connect it to the ground connector at the back of the computer.

Now see the next section for instructions on installing the printer software. You must install the printer software before using your printer.

Installing the Printer Software in Your PC

After connecting the printer to your computer, install the Windows printer software. It is included on the “Printer Software for EPSON Stylus COLOR 600” CD-ROM shipped with your printer. For installation instructions for the NT-based printer software, see the *Windows NT 3.51/4.0 Printer Software User’s Guide*.

Your printer software includes:

- ❑ **Printer driver**
The printer driver gives you complete control over your printer. With it, you can make settings such as Print Quality, Media Type, and Paper Size.
- ❑ **Utilities**
The Status Monitor utility allows you to check the current status of your printer. The Nozzle Check, Head Cleaning, and Print Head Alignment utilities help you to keep your printer in top operating condition.
- ❑ **EPSON folder or program group**
The EPSON folder (Windows 95) or program group (Windows 3.1) contains the EPSON Stylus COLOR 600 Help, Spool Manager 4, and EPSON ReadMe files. Help gives you instant on-screen access to detailed information and instructions on how to use your printer and printer software, Spool Manager 4 provides you with extra control over the printing process, and ReadMe contains the most up-to-date information available regarding your printer and printer software.
- ❑ **EPSON Answers**
EPSON Answers provides you with additional information on using your printer and printing with colors. See the booklet packed with the CD-ROM for more information. EPSON Answers is not included in the floppy disk version.

If you are using the floppy disk version of the software, before you begin installation, make a backup copy of the EPSON printer software disk. If you wish to make a floppy disk version of the printer software on your CD-ROM, you can use the driver disk creation utility included on the CD. See page 2-15 for Windows 95, or page 2-18 for Windows 3.1.

Installing in Windows 95

Follow the steps below to install the printer software in Windows 95.

1. Make sure Windows 95 is running and the printer is off.
2. Insert the printer software CD shipped with your printer in the CD-ROM drive. Click Install in the dialog box that appears, shown below.



If this dialog box does not appear when you insert the printer software CD, double-click the My Computer icon, then double-click the CD-ROM drive icon (or floppy disk drive icon if using the floppy disk version). If the dialog box shown above still does not appear, double-click the Setup.exe icon. You may need to use the arrows to scroll through the folder to find it.

Note:

If you wish to make a floppy disk version of the printer software included on your CD-ROM, click the Driver disk creation utility button and follow the on-screen instructions.

3. Select your printer icon in the EPSON Printer Utility Setup dialog box.



4. Make sure EPSON Stylus COLOR 600 is selected, and click OK to start the printer software installation. Follow the on-screen messages and when the installation is complete, click OK again.

Your printer software is now installed. For information on opening and using the software, see Chapter 3, “Printing With Windows.”

Installing in Windows 95 (using plug-and-play)

Follow these steps to install the printer software using Windows 95 plug-and-play capabilities.

Note:

To install the printer software using Windows 95 plug-and-play capabilities, your computer's parallel port must be an IEEE 1284 compatible, bidirectional parallel port. See your computer documentation for more information.*

1. Make sure the printer is connected to the computer's parallel port.
2. Turn off your printer and computer, if necessary.
3. Turn on the printer first; then turn on the computer. Your computer begins loading Windows 95.
4. If you defined a password, enter it at the prompt. You see the New Hardware Found screen.

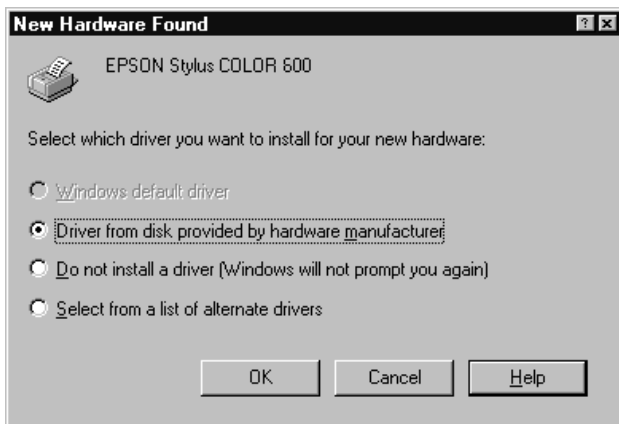

Note:

If you do not see the New Hardware Found screen or if you run into any kind of problem, click Cancel and follow the installation procedure on page 2-13 instead.

5. Make sure your printer model name is displayed on the screen. Then click the Driver from disk provided by hardware manufacturer button. Do not select any of the other buttons.
6. Click OK. You see the Install From Disk screen.

7. Insert the printer software CD shipped with your printer in the CD-ROM drive. Depending on the country, the CD-ROM may contain multiple-language versions of the printer software.

First try typing D:\Win95 and clicking OK. If an error message does not appear, proceed to step 8. If an error message does appear, you have the multiple-language version and you need to click OK to return to the Install From Disk screen. Type D:\ then specify your preferred language by typing English, Francais, German, Italian, Portugal, or Spanish, followed by \Win95. Click OK. (If your CD-ROM drive uses a drive letter other than “D”, substitute the appropriate letter.)

If you use the floppy disk version, insert it in a disk drive. If the drive you are installing from is displayed on the screen, click OK. Otherwise, change the drive letter in the Copy manufacturer’s files from box and click OK.

8. At the next screen you can type a unique name for the printer in the Printer name box. We recommend that you keep the model name as shown. The program will copy the files to your hard disk and add an icon to the Printers folder using the printer name you assign. To use this printer as the default printer for Windows 95 applications, select Yes. (No is the default setting.)
9. Click the Finish button.

The printer software that controls your printer is now installed. For information on accessing and using the software, see Chapter 3, “Printing With Windows.”

Using your printer on a network with Windows 95

If you want to use your printer on a network, you need to set up your printer as a network printer. Follow these steps:

1. Double-click the My Computer icon.
2. Double-click the Printers folder.
3. Right-click the icon of your printer, and click Properties. Be sure to right-click.
4. Click the Details tab. The following window appears:



5. Click the Add Port button, then specify the network path to the printer. Click OK.

Note:

If you want to print from DOS applications as well as from Windows applications, click the Capture Printer Port button instead of the Add Port button. Click anywhere in the Device box and select the printer port your printer is connected to, then specify the network path to the printer. Make sure Reconnect at logon is selected, then click OK.

6. After you have made your settings on the Details menu, click Start, point to Programs and Epson, then click Spool Manager4. The Spool Manager window opens.
7. Select your printer, click the Queue menu, then click Setup. The Queue setup window opens.
8. Make sure the Use Print Manager for this port option is on; it is on if the box contains a check mark. Then click OK.

Now you can use your printer on a network.

Installing in Windows 3.1

Follow these steps to install the software using Windows 3.1:

1. Make sure Windows 3.1 is running and the Program Manager window is open.
2. Insert the EPSON printer software CD shipped with your printer in the CD-ROM drive. (If you use the floppy disk version, insert it in a disk drive.)
3. From the File menu, choose Run. You see the Run dialog box. In the Command Line box, type D:\SETUP (If your CD-ROM drive has a drive letter other than "D" or you are using the floppy version, substitute the appropriate letter.)

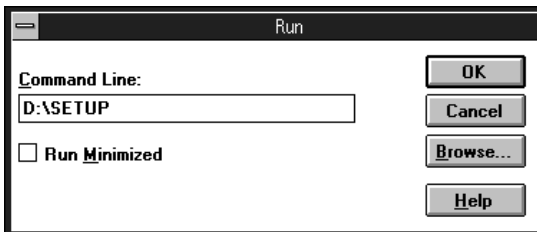

Note:

If you wish to make a floppy disk version of the essential printer software (printer driver, utilities, and online help) on your CD-ROM, type EPSETUP instead of SETUP. In the dialog box that appears, click the Driver disk creation utility button and follow the on-screen instructions.

4. Click OK. You see the EPSON Printer Utility Setup dialog box.



5. Select your printer icon and click OK. The installation program begins copying the printer software files.

After a few moments, the installation program creates the EPSON program group in Windows.

6. When the installation is complete, click OK to exit the installation program.

The installation program automatically selects this printer as the default printer for Windows applications.

When installation of the printer driver and utilities is completed, EPSON Answers installation begins. Follow the on-screen instructions.

Your printer software is now installed. For information on opening and using the printer driver and utilities, see “Starting to Print with Windows” in Chapter 3.

Connecting the Printer to Your Macintosh

To use the printer's built-in serial interface, you will need an Apple System Peripheral-8 cable. Read the following steps to connect the printer to your Macintosh.

1. Make sure both your printer and Macintosh are switched off.
2. Connect one end of the interface cable to the serial connector on the back of the printer.

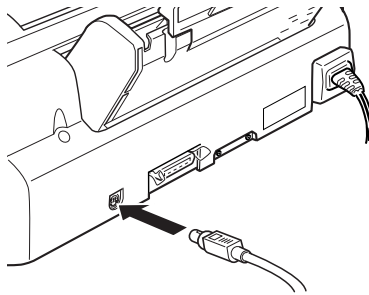

3. Connect the other end of the interface cable to either the modem port or printer port on the Macintosh. The ports are marked with the following icons.



modem port



printer port

4. Turn on the printer by pressing the  power button.
5. Turn on your Macintosh.

See “Installing the Printer Software in Your Macintosh” for instructions on installing the printer software. You must install the printer software before using your printer.

Installing the Printer Software in Your Macintosh

Always use the EPSON Stylus COLOR 600 Macintosh printer software when printing with your printer. This software is specially designed to allow easy access to all the features of the printer.



Caution:

Turn off all virus protection programs before you install your printer software.

Installing the printer software

Follow the steps below to install your printer software. If you are using the floppy disk version, make a backup copy of the EPSON Macintosh printer software disk before you begin installation.

1. Turn on your Macintosh and insert the EPSON printer software CD shipped with your printer into its CD-ROM drive. (If you use the floppy disk version, insert it in a disk drive.)

The EPSON printer software disk opens automatically and, depending on the country, displays either a single installer icon or separate folders containing installer icons for several languages. Double-click the Installer icon if it is displayed, or open the folder for your preferred language, then open the Disk 1 folder and double-click the installer icon inside it.

2. After the initial screen appears, click Continue to advance to the following dialog box, where you can choose to install all or some of the software components included on your printer software CD. For information on the included software, see page 2-23.



3. If you want to install all of the printer software included on your printer software CD-ROM, make sure the disk on which you want to install the software is displayed in the Destination Disk box, then click Install.

If you are low on disk space, select Custom Install from the pop-up menu and click EPSON Stylus Printer Driver Package. Confirm the destination for installation, then click Install. (If you later decide you need the Power Macintosh Extension Module, select and install it using the custom install procedure described here.)

Note:

Click the  button to get information on each component.

4. When a message appears informing you that installation is finished, click Restart to complete the installation and restart your computer.

Printer software components

Your printer software CD-ROM includes the following software components:

EPSON Stylus Printer Driver Package

- ❑ **EPSON Stylus (EX)**
This is the printer driver software that gives you control over your printer. With it, you can make settings such as Print Quality, Media Type, and Paper Size.
- ❑ **EPSON Monitor2**
Monitors and manages background printing jobs. You must turn on background printing in the Chooser to use this utility. For more information, see “Using the EPSON Monitor2 Utility” on page 5-24.
- ❑ **ColorSync™ 2.0 and Profiles**
Matches the colors in your printout with the colors displayed on your screen automatically. Use this when printing scanned photographs or computer graphics.

To use this feature, you may need to set the system profile for your monitor. Access the ColorSync System Profile utility through the Control Panel and click the Set Profile button. Select your monitor from the list of monitors that appears, and then click Select. Close the dialog box.

- ❑ **StatusMonitor**
Keeps track of the current status of your printer, and alerts you when printer errors occur. You can open it from the Utility dialog box in the printer software. For more information, see “Using EPSON Printer Utilities” in Chapter 5.

- ❑ **Nozzle Check**
Checks the print head for clogging. You can open this utility from the Utility dialog box in the printer software. For more information, see “Using EPSON Printer Utilities” in Chapter 5.
- ❑ **Head Cleaning**
Cleans the print head to maintain the best print quality. You can open this utility from the Utility dialog box in the printer software. For more information, see “Using EPSON Printer Utilities” in Chapter 5.
- ❑ **Print Head Alignment**
Adjusts the print head so that vertical lines are aligned. You can open this utility from the Utility dialog box in the printer software. For more information, see “Using EPSON Printer Utilities” in Chapter 5.

Power Macintosh Extension Module

Increases the printing speed, especially when printing CAD documents or line art. For more information, see your Macintosh user’s guide.

Using the Chooser to select your printer

After you install the printer software, you need to open the Chooser to select your printer. You have to choose the printer only the first time you use it or whenever you want to switch to another printer. Your Macintosh will always print using the last printer selected.

Note:

If you are using a Macintosh Quadra 950 or 900, you need to choose Compatible in the Serial Switch dialog box before selecting your printer from the Chooser. To open the Serial Switch dialog box, choose Control Panel from the Apple menu, then choose Serial Switch.

1. Make sure the printer is connected to your Macintosh and is turned on.
2. Choose Chooser from the Apple menu. Then click the EPSON Stylus(EX) icon and the port your printer is connected to.

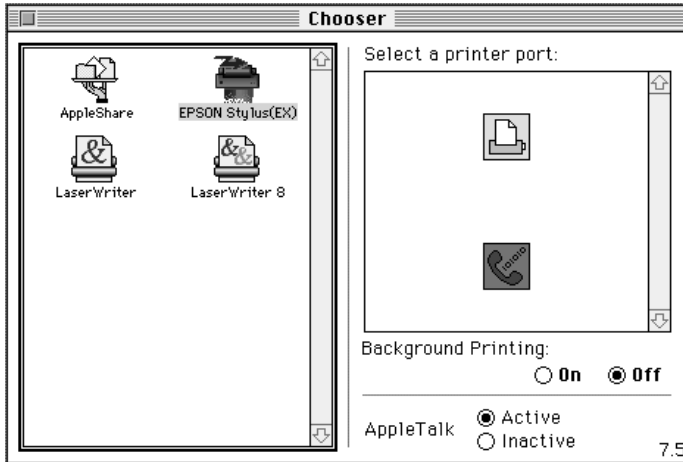

Note:

If you don't see the EPSON Stylus(EX) icon, use the arrows on the right to scroll through the available icons.

3. If your printer is connected to the Macintosh's printer port and you are not using an AppleTalk network, make AppleTalk inactive by clicking the Inactive radio button. You may also need to restart your Macintosh to make AppleTalk inactive.

You do not need to make AppleTalk inactive if the printer is connected to the modem port.



Caution:

Do not make AppleTalk inactive if the Macintosh is connected to an AppleTalk network.

4. Click the Background Printing radio buttons to turn background printing on or off.

When background printing is on, you can use your Macintosh while it is preparing a document for printing. You must turn on background printing to use the EPSON Monitor2 utility to manage print jobs. For more information, see “Using the EPSON Monitor2 Utility” in Chapter 5.

5. Close the Chooser.

Your Macintosh will check that the printer is connected correctly. If the following message appears, follow the instructions on the screen, click **OK**, and repeat the steps above.

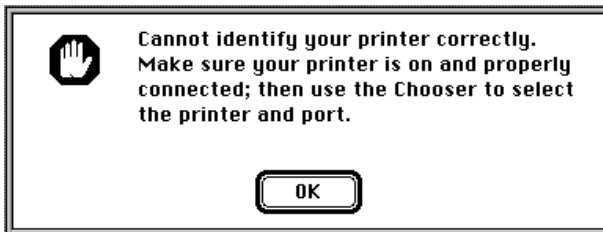

Chapter 3

Starting to Print

Loading Paper	3-2
Printing with Windows	3-5
Printing with a Macintosh	3-8



Loading Paper

The following procedure describes how to load plain paper into the printer.

You can also print on ink jet paper, transparencies, photo-quality glossy film or paper, envelopes, index cards, and adhesive sheets. For details on using such media, see Chapter 6, “Printing on Special Paper.”

Note:

To print on transparencies, you need to reposition the paper support as described in “Loading Transparencies” in Chapter 6.

1. Lower the output tray at the front of the printer and slide out the extension.

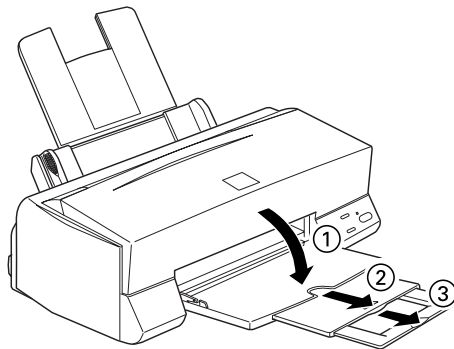

2. Slide the left edge guide to the left as far as it will go.

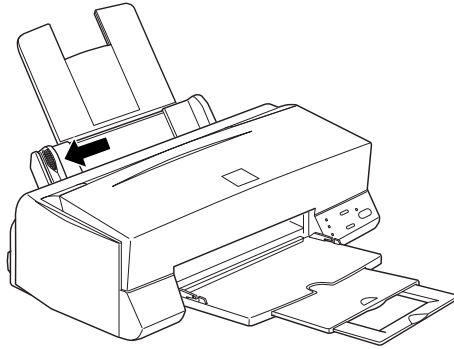

If you load long paper (for example, legal size paper), pull up the paper support extension.

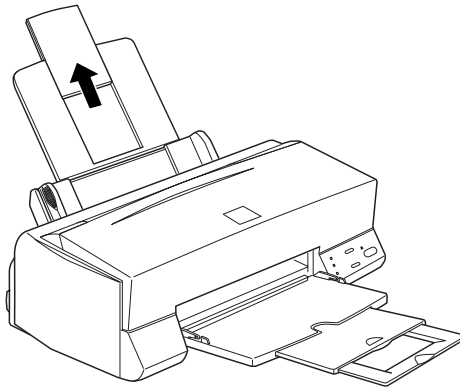

3. Fan a stack of paper; then tap it on a flat surface to even the edges.

4. Load the stack of paper with the printable surface up and the right edge of the paper resting against the right side of the sheet feeder.

Note:

- ❑ *Always load paper into the sheet feeder short edge first. Load envelopes flap edge first with the flap side down.*
- ❑ *Load pre-printed forms or letterhead top edge first.*

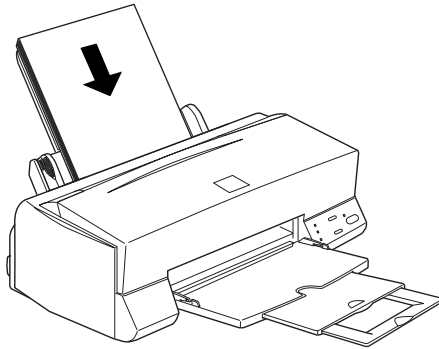

5. Slide the left edge guide against the left edge of the paper. Make sure the paper stack fits under both the edge guide tab and arrow mark as shown below.

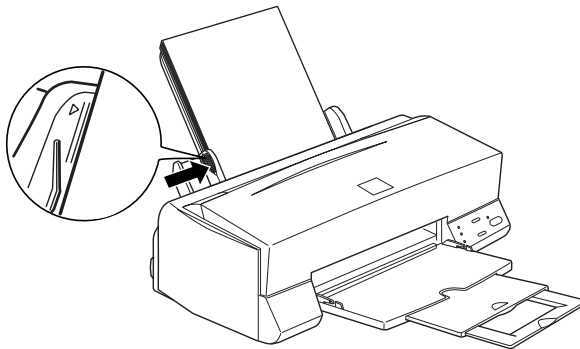

Printing with Windows

To get started printing right away, follow the printing method explained below, which is typical of many Windows applications. The actual way you print may vary depending on the application you use. See your application manual for details. See page 3-8 for information on printing with a Macintosh.

Note:

While many Windows applications override the settings made with the printer driver, some do not, so you must verify the settings to get the results you expect.

1. From your application, open the document you want to print.
2. Click Print on the File menu. The Print dialog box (or a similar dialog box) appears.
3. Make sure your printer is selected and then click Printer, Setup, Properties, or Options. You may need to click a combination of these buttons. The printer software window appears.



4. Click the Main tab if necessary, and make sure the Mode option is set to Automatic.

Note:

When Automatic is selected, the printer software determines the best settings according to the Media Type and Ink settings you make.

5. Click anywhere in the Media Type box, and select the media you loaded in the printer. If you don't see your media in the list, use the arrow on the right to scroll through the list. See "Making the Media Type Setting" on page 4-10 for more information.
6. Select Color as the Ink setting if your document includes color. Select Black if you are printing black text, a draft, or if you want colors to print as varying shades of gray.
7. Click the Paper tab. The Paper menu appears.



8. Select the size of the paper you loaded in the printer from the Paper Size list. If you don't see your paper size in the list, use the arrow on the right to scroll through the list.

Note:

If your paper size is not included in the list, select User Defined and enter the paper size in the dialog box that appears. For information on the User Defined option, see online help.

9. Make the Orientation setting. The effect of your setting is shown in the display to the left.

Note:

Always load paper into the sheet feeder short edge first. Load envelopes flap edge first with the flap side down.

10. Click OK at the bottom of the window. You return to the Print dialog box (or a similar dialog box).
11. Click Close, OK, or Print to print. You may need to click a combination of these buttons.

While your document is printing, the EPSON Despooler dialog box will appear, showing the printing progress and the status of your printer. If you are printing from Windows 95, this dialog box also displays the Status Monitor.

See Chapter 4 and online help for detailed information on printer driver settings, the EPSON Despooler, and the Status Monitor.

Printing with a Macintosh



To get started printing right away, follow the printing method explained below, which is typical of many Macintosh applications. The actual way you print may vary depending on the application you use. See your application manual for details. If you are printing from Windows applications, see the previous section.

Note:

While many Macintosh applications override the settings made with the printer driver, some do not, so you must verify the settings to get the results you expect.

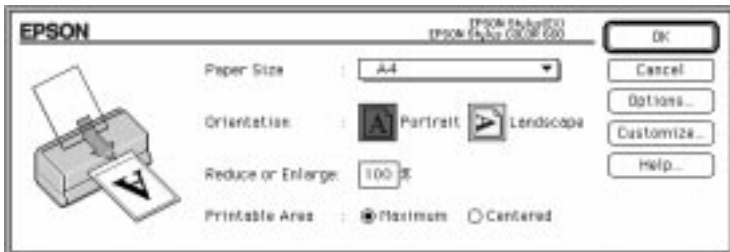
1. From your application, open the document you want to print.
2. Choose Page Setup from the File menu. This brings up the dialog box shown below.



3. Select the paper size you loaded in the printer from the Paper Size list.
4. Check the Orientation option for  Portrait or  Landscape orientation.

Note:

Always load paper into the sheet feeder short edge first. Load envelopes flap edge first with the flap side down.

5. After making your settings, click the OK button to close the Page Setup dialog box.

Note:

You cannot print from the Page Setup dialog box. You can only print from the Print dialog box.

6. Choose Print from the File menu. This brings up the dialog box shown below.

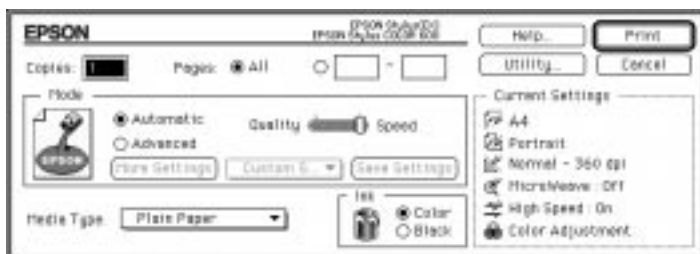

7. Make sure the Mode option is set to Automatic.

When Automatic is selected, the printer software determines the best settings according to the Media Type and Ink settings you make.

8. Select the type of paper you loaded in the printer from the Media Type list.
9. Select Color as the Ink option if your document includes color. Select Black if you are printing black text, a draft, or if you want colors to print as varying shades of gray.
10. Click Print to start printing.

Chapter 4

Using the Printer Software for Windows

Introducing the Printer Software Functions	4-2
Accessing the Printer Software	4-3
From Windows applications	4-3
From Windows 95	4-4
From Windows 3.1	4-5
Using the Automatic Setting	4-6
Using the Predefined Settings	4-7
Customizing the Print Settings	4-9
Saving your settings	4-10
Making the Media Type Setting	4-11
Using EPSON Printer Utilities	4-13
EPSON Status Monitor	4-14
Nozzle Check	4-15
Head Cleaning	4-15
Print Head Alignment	4-15
Checking Printer Status	4-16
Understanding the EPSON Spool Manager	4-16
Understanding the Despooler	4-17
Getting Information Through Online Help	4-18
From Windows applications	4-18
From Windows 95	4-18
From Windows 3.1	4-18



Introducing the Printer Software Functions

The printer software includes a printer driver and printer utilities. The printer driver lets you choose from a wide variety of settings to get the best results from your printer. The printer utilities help you check the printer and keep it in top condition.

The quickest and easiest way to start printing is to leave the Mode option set to Automatic on the printer driver's Main menu. This way you only need to check the Media Type and Ink settings, as described on page 3-5.

Basically, there are three levels of settings: the Automatic setting; the predefined settings, which give you more control over printer settings; and the custom settings, which you make to fit your individual needs. To work with predefined and custom settings, you need to select Advanced as the Mode option. These settings are described in detail starting on page 4-5.

Several printer utilities are provided to help you check the condition of the printer and perform maintenance procedures. See pages 5-20 through 5-23 for information on the Status Monitor, Nozzle Check, Head Cleaning, and Print Head Alignment utilities. For instructions on using the Status Monitor, see page 5-21, and for instructions on using any of the other utilities, see Chapter 8, "Troubleshooting."

Accessing the Printer Software

As explained on the following pages, you can access the printer driver settings and printer utilities contained in your printer software directly from any Windows application, or from My Computer in Windows 95 or Program Manager in Windows 3.1. The print settings made in many Windows applications override similar settings made in the printer driver, so in most cases you should access the printer software from your application to make sure that the settings are appropriate for the document you want to print.

Note:

Online help is available for details about the printer driver settings.

4

From Windows applications

How you should access the printer software varies depending on the application, application version, and Windows version you are using. Read the following to get a general idea of how to access the software.

From the File menu, choose Print or Print Setup. In the dialog box that appears click Printer, Setup, Properties, or Options. You may need to click a combination of these buttons.

The Main and Paper menus contain the printer driver settings. The Utility menu contains the printer utilities. Click the tabs at the top of the menus to open them.

For information on the printer driver settings, see online help and pages 4-5 to 4-11. See page 4-12 for information on the printer utilities.

From Windows 95

Follow these steps to access the printer software from My Computer.

If you are using Windows 3.1, see the next page.

1. Double-click the My Computer icon.
2. Double-click the Printers folder.
3. Right-click the icon of your printer, and click Properties. Be sure to right-click. The Properties window appears.
4. Click the menu tabs at the top of the Properties window to open the printer software menus. The Main and Paper menus contain the printer driver settings. The Utility menu contains the printer utilities.

For information on the printer driver settings, see online help and pages 4-5 to 4-11. See page 4-12 for information on the printer utilities.

From Windows 3.1

Follow these steps to access the printer software from Program Manager:

1. Open the Main program group and double-click the Control Panel icon.
2. Double-click the Printers icon.
3. Choose your printer from the Installed Printers list.
4. Choose Setup. You see the Main menu of the printer software window. The Main and Paper menus contain the printer driver settings. The Utility menu contains the printer utilities. Click the tabs at the top of the menus to open them.

For information on the printer driver settings, see online help and pages 4-5 to 4-11. See page 4-12 for information on the printer utilities.

Using the Automatic Setting

When Automatic is selected on the Main menu, the printer driver takes care of all detailed settings according to the Media Type and Ink settings you make (see page 4-10 for details on the Media Type settings). If you leave Mode set to Automatic, Media Type and Ink are the only settings you need to check yourself. Most Windows applications feature paper size and page layout settings which override similar settings on the Paper menu, but if your application does not, you should also check the items on the Paper menu.



Note:

If you choose Plain Paper, Photo Quality Ink Jet Paper, Photo Quality Glossy Paper or Photo Quality Glossy Film as the Media Type setting while Automatic is selected, a slide bar appears in the Mode box that lets you choose Quality or Speed. Select Quality when print quality is more important than speed.

Online help provides more information about the printer driver settings. See page 4-17 for instructions on using online help.

Using the Predefined Settings

The predefined settings are provided to help you optimize the print settings for a particular kind of printout, such as presentation documents or images taken by a video or digital camera. You will find the predefined settings in the list below the Advanced button on the Main menu.

To choose a predefined setting, click Advanced, then select the most appropriate setting from the list according to the type of document or image you will print.

When you choose a predefined setting, other settings such as Print Quality, Halftoning, and Color are set automatically. Changes are shown in the Current Settings display at the bottom of the Main menu. Before printing, be sure to verify the Media Type and Ink settings, as they may be affected by the predefined setting you select. See page 4-10 for more information on the Media Type settings.

The printer driver provides the following predefined settings:

Photo	Good for printing scanned photos
Text/Graph	Good for printing presentation documents such as graphs and charts
PhotoEnhance	Good for printing images captured using a video, digital camera, or scanner. EPSON PhotoEnhance automatically adjusts the contrast, saturation, and brightness of the original image data to produce sharper, more vivid color printouts. PhotoEnhance does not affect your original image data.

Note:

Printing with PhotoEnhance selected may take longer depending on your computer system and the amount of data contained in your image.

Text	Good for printing text-only documents
Economy	Good for printing drafts of text
ICM	ICM means Image Color Matching. This feature automatically adjusts printout colors to match colors on your screen.

Note:

- ICM is only available for Windows 95.*

- Selecting PhotoEnhance or ICM automatically sets the Ink option to Color. Also, some Media Type settings are not available depending on the selected predefined setting and on the Ink setting if a predefined setting is selected.*

Customizing the Print Settings

Many users will never need to manually make their own print settings. However, if you need more control over the driver, want to make the most detailed settings available, or just want to experiment, click the Advanced button on the Main menu and then click the More Settings button. The More Settings dialog box appears:



4

Some settings are enabled or disabled depending on the Print Quality, Media Type, and Ink settings you make. To save time and effort, always customize your settings in this order: Print Quality, Media Type, Ink, and then make other settings. See the next section for details about making the Media Type setting.

After making your settings, click OK. Your settings will be applied and you will return to the Main menu. To return to the Main menu without applying your changes, click Cancel. For details on the settings, see online help.

Saving your settings

To save your custom settings, click Save Settings on the Main menu. The Custom Settings dialog box appears:

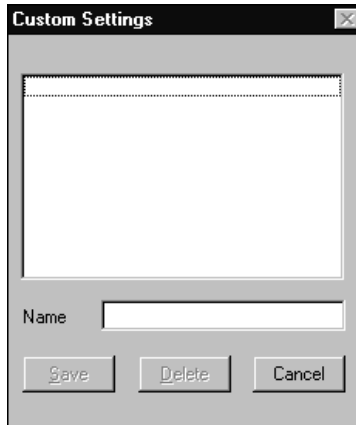

Type a unique name for your custom settings in the Name box, and click the Save button. Your settings will appear in the list under the Advanced button on the Main menu.

Note:

- ❑ *You cannot use a predefined setting name for your custom settings.*
- ❑ *To delete a custom setting, click Save Settings on the Main menu, select the setting in the Custom Settings dialog box and then click Delete.*
- ❑ *You cannot delete the predefined settings.*

If you change the Media Type or Ink setting when one of your customized settings is selected in the Advanced settings list on the Main menu, the setting selected in the list changes to Custom Settings. The customized setting that was previously selected is not affected by this change. To return to your customized setting, simply reselect it in the settings list.

Making the Media Type Setting

On the Main menu, select the Media Type setting that matches the paper you loaded in the printer. See the following to determine the Media Type setting (shown in bold) for your paper. First find your paper, then click the corresponding Media Type setting.

Note:

If the corresponding Media Type option for your paper is not shown in the Media Type list, change the Print Quality setting in the More Settings dialog box, select Automatic as the Mode setting, or change the predefined setting in the Advanced settings list on the Main menu.

Plain Paper

Plain paper
Envelopes

360 dpi Ink Jet Paper

EPSON 360 dpi Ink Jet Paper (A4)	S041059
	S041025
EPSON 360 dpi Ink Jet Paper (Letter)	S041060

Photo Quality Ink Jet Paper

EPSON Photo Quality Ink Jet Paper (A4)	S041061
	S041026
EPSON Photo Quality Ink Jet Paper (Letter)	S041062
EPSON Photo Quality Ink Jet Paper (Legal)	S041067
EPSON Photo Quality Ink Jet Card (A6)	S041054
EPSON Photo Quality Ink Jet Card (5 × 8 in.)	S041121
EPSON Photo Quality Ink Jet Card (8 × 10 in.)	S041122
EPSON Photo Quality Self Adhesive Sheet (A4)	S041106

Ink Jet Transparencies

EPSON Ink Jet Transparencies (A4)	S041063
EPSON Ink Jet Transparencies (Letter)	S041064

Photo Quality Glossy Paper

EPSON Photo Quality Glossy Paper (A4)	S041126
EPSON Photo Quality Glossy Paper (Letter)	S041124
EPSON Photo Paper (4 × 6 in.)	S041134

Photo Quality Glossy Film

EPSON Photo Quality Glossy Film (A4)	S041071
EPSON Photo Quality Glossy Film (Letter)	S041072
EPSON Photo Quality Glossy Film (A6)	S041107

Note:

The availability of special media varies by country.

Using EPSON Printer Utilities

EPSON printer utilities allow you to check the current printer status and do some printer maintenance from your screen. To access the utilities, click the Utility tab in the printer software window, then click the button for the utility you want to use. The utilities are explained briefly below. For more details, see online help.

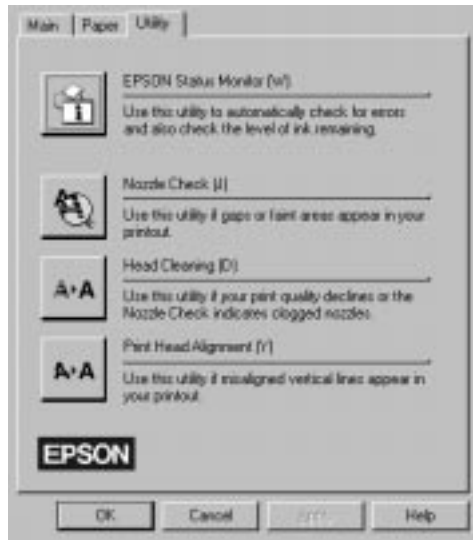

Note:

The letter in parentheses after the utility name indicates the shortcut key for that utility. Press the Alt key and the letter on the keyboard to open that utility.

EPSON Status Monitor

The Status Monitor utility helps you to keep track of the printer, and it alerts you if there are any problems. You can also check how much ink is remaining before printing and while printing. When you install the printer software for Windows 95, the Status Monitor is automatically copied to your hard disk.

Note:

The Status Monitor is only available for Windows 95.

The Status Monitor utility is available only when the printer is connected directly to the host computer. You cannot use this utility when printing over a network.

When you send a print job to the printer, the Status Monitor will appear in the Despooler dialog box. For information on the Despooler dialog box, see “Understanding the EPSON Spool Manager” on page 4-15.

The Status Monitor provides information about the printer status as shown by the icons below.



Checking the printer status.



An error has occurred. Your printer cannot print. Check your printer.



The printer is ready.



The printer is printing.



The ink level is low or out.

Nozzle Check

You can check the print head nozzles for clogging with this utility. Check the nozzles when you notice a decline in print quality and after cleaning to confirm that the print head nozzles have been cleared. In case the nozzle check indicates the print head needs cleaning, you can access the Head Cleaning utility directly from the Nozzle Check utility. See Chapter 8, “Troubleshooting,” for more information.

Head Cleaning

You can clean the print head with this utility. You may need to clean the head if you notice a decline in print quality. Before and after print head cleaning, use the Nozzle Check utility to check whether the print head needs to be cleaned (again). You can access the Nozzle Check utility directly from the Head Cleaning utility. See Chapter 8, “Troubleshooting,” for more information.

Print Head Alignment

This utility aligns the print head. Use this utility when you notice a misalignment of vertical lines. See Chapter 8, “Troubleshooting,” for more information.

Note:

- ❑ *Do not use the Nozzle Check, Head Cleaning, and Print Head Alignment utilities with printers connected to your computer through a network.*
- ❑ *Do not use the Nozzle Check, Head Cleaning, and Print Head Alignment utilities while printing is in progress; otherwise your printout may be marred.*

Checking Printer Status

When you send a print job to the printer, the EPSON Despooler and Status Monitor appear in the lower right portion of your screen. The Despooler shows the progress of the current print job and allows you to control the progress of the print job, as described below.

Understanding the EPSON Spool Manager

The EPSON Spool Manager is similar to Windows Print Manager. If it receives two or more print jobs at one time, it puts them in a line (with printers on a network this may be called a print queue) in the order received. When a print job reaches the top of the line, the EPSON Despooler sends the job to the printer.

The Spool Manager starts automatically when you print from your application. To access the Spool Manager from Windows 95, click the EPSON Spool Manager icon after it appears on the taskbar. To access the Spool Manager from Windows 3.1, double-click the EPSON Spool Manager icon after it appears at the bottom of your desktop. For more information, see online help.

Understanding the Despooler

When you send a print job to the printer, the EPSON Despooler dialog box appears in the lower right portion of your computer screen. This box shows the progress of the current print job and provides printer status information.



4

You can control printing from the Despooler dialog box using the stop, pause, and reprint buttons as explained below.



Stop Cancels printing



Pause Pauses printing until you press it again



Reprint Restarts printing from the current page, reprints the whole document, or holds the document for printing later

The Status Monitor at the bottom of the Despooler dialog box only appears if you are using Windows 95. See page 4-13 for more details.

Getting Information Through Online Help

Your printer software has an extensive online help feature that includes detailed information and instructions about printer driver settings and the printer utilities. Online help will answer most of your questions about your printer software.

From Windows applications

To access online help from your application, open the File menu and choose Print or Print Setup. Then click Printer, Setup, Options, or Properties (you may need to click a combination of these buttons) depending on the software you are using. Click the Help button at the bottom of the Main, Paper, or Utility menu for help related to the items on that menu.

If you are running Windows 95, or Windows NT 4.0 you can get specific help related to any item on a menu by right-clicking the item, then clicking the What's This? prompt.

From Windows 95

To access online help from Start, click the Start button, point to Programs and Epson, and then click EPSON Stylus COLOR 600 Help. You see the help contents window.

From Windows 3.1

To access online help from Program Manager, open the EPSON program group and double-click the EPSON Stylus COLOR 600 Help icon. You see the help contents window.

Chapter 5

Using the Printer Software for Macintosh

Introducing the Printer Software Functions	5-2
Using the Automatic Setting	5-3
Using the Predefined Settings	5-5
Customizing the Print Settings	5-8
Making your settings	5-8
Saving your settings	5-9
Choosing your settings	5-10
Modifying visual effects	5-10
Controlling the printing quality	5-15
Changing the Paper Size	5-18
Defining a Custom Paper Size	5-19
Using EPSON Printer Utilities	5-20
EPSON StatusMonitor	5-21
Nozzle Check	5-22
Head Cleaning	5-23
Print Head Alignment	5-23
Using the EPSON Monitor2 Utility	5-24



Introducing the Printer Software Functions

The printer software includes a printer driver and printer utilities. The printer driver lets you choose from a wide variety of settings to get the best results from your printer. The printer utilities help you check the printer and keep it in top condition.

The quickest and easiest way to start printing is to leave the Mode option set to Automatic in the Print dialog box. This way you only need to check the Media Type and Ink settings, as described on page 5-4.

Basically, there are three levels of settings: the Automatic setting; the predefined settings, which give you more control over printer settings; and the custom settings, which you make to fit your individual needs. To work with predefined and custom settings, you need to select Advanced as the Mode option. These settings are described in detail below.

Several printer utilities are provided to help you check the condition of the printer and perform maintenance procedures. See pages 5-20 through 5-23 for information on the Status Monitor, Nozzle Check, Head Cleaning, and Print Head Alignment utilities. For instructions on using the Status Monitor, see page 5-21, and for instructions on using any of the other utilities, see Chapter 8, "Troubleshooting."

Using the Automatic Setting

When Automatic is selected as the Mode setting in the Print dialog box, the printer driver takes care of all detailed settings according to the Media Type and Ink settings you make (see page 5-4 for details on making the Media Type setting). Most users will never have to switch from the Automatic to the Advanced mode. However, if your application program does not give you enough control over the printout, you may want to switch to Advanced mode to experiment with the predefined settings or make your own custom settings. See page 5-6 for information on the predefined settings, and page 5-8 for information on making custom settings.

To access the Print dialog box, click Print on the File menu of your application. The Print dialog box appears:



Note:

If you choose Plain Paper, Photo Quality Ink Jet Paper, Photo Quality Glossy Paper or Photo Quality Glossy Film as the Media Type setting while Automatic is selected, a slide bar appears in the Mode box that lets you choose Quality or Speed. Select Quality when print quality is more important than speed.

Before printing, be sure to verify the Media Type and Ink settings as described below because they also have an effect on the other settings. You may also need to check the Page Setup dialog box for other basic settings such as paper size. See page 5-18 for information on the Page Setup dialog box.

Media Type

Select the Media Type setting that matches the kind of paper you loaded in the printer. See below to determine which Media Type setting (shown in bold) best matches your paper.

Plain Paper

Plain paper
Envelopes

360 dpi Ink Jet Paper

EPSON 360 dpi Ink Jet Paper (A4)	S041059
	S041025
EPSON 360 dpi Ink Jet Paper (Letter)	S041060

Photo Quality Ink Jet Paper

EPSON Photo Quality Ink Jet Paper (A4)	S041061
	S041026
EPSON Photo Quality Ink Jet Paper (Letter)	S041062
EPSON Photo Quality Ink Jet Paper (Legal)	S041067
EPSON Photo Quality Ink Jet Card (A6)	S041054
EPSON Photo Quality Ink Jet Card (5 × 8 in.)	S041121
EPSON Photo Quality Ink Jet Card (8 × 10 in.)	S041122
EPSON Photo Quality Self Adhesive Sheet (A4)	S041106

Ink Jet Transparencies

EPSON Ink Jet Transparencies (A4)	S041063
EPSON Ink Jet Transparencies (Letter)	S041064

Photo Quality Glossy Paper

EPSON Photo Quality Glossy Paper (A4)	S041126
EPSON Photo Quality Glossy Paper (Letter)	S041124
EPSON Photo Paper (4 × 6 in.)	S041134

Photo Quality Glossy Film

EPSON Photo Quality Glossy Film (A4)	S041071
EPSON Photo Quality Glossy Film (Letter)	S041072
EPSON Photo Quality Glossy Film (A6)	S041107

Note:

The availability of special media varies by country.

Ink

If your document includes color, select Color. If you are printing black text, a draft, or if you want colors to print as varying shades of gray, choose Black.

Using the Predefined Settings

The predefined settings are provided to help you optimize the print settings for a particular kind of printout such as presentation documents or images taken by a video or digital camera.

The predefined settings appear in a list located between the More Settings and Save Settings buttons in the Print dialog box. This list is enabled when you click the Advanced button.

To select a predefined setting, click the Advanced button, then click in the list and select a setting according to the type of document or image you want to print.

When you choose a predefined setting, other settings such as Print Quality, Halftoning, and Color are set automatically. Changes are shown in the Current Settings display on the right side of the Print dialog box. Before printing, be sure to verify the Media Type and Ink settings, as they may be affected by the predefined setting you select. See the previous section for more information on the Media Type and Ink settings.

The printer driver provides the following predefined settings:

Photo

This setting is best for printing scanned photographs. It increases the contrast in an image.

Note:

Changing the Ink setting after Photo is selected returns the settings list to Custom Settings, so always make your Ink setting before you select this option.

Text/Graph

This setting is best for graphics-intensive documents such as charts and graphs for presentations. It intensifies the colors but lightens the midtones and highlights of an image.

Note:

Changing the Ink setting after Text/Graph is selected returns the settings list to Custom Settings, so always make your Ink setting before you select this option.

PhotoEnhance

This setting is best for printing images captured using a video, digital camera, or scanner. EPSON PhotoEnhance feature produces sharper images and more vivid colors by automatically adjusting the contrast, saturation, and brightness of the original image data.

Note:

- Selecting PhotoEnhance automatically sets the Ink option to Color. Changing the Ink setting after PhotoEnhance is selected returns the settings list to Custom Settings.*
- Printing with PhotoEnhance selected may take longer depending on your computer system and the amount of data contained in your image.*

Economy

This setting provides you with faster printing and saves ink. The printer uses less ink by printing fewer dots per character. Choose this setting for rough drafts of text only.

Note:

Changing the Ink setting after Economy is selected returns the settings list to Custom Settings, so always make your Ink setting before you select this option.

ColorSync™

This setting automatically adjusts printout colors to match the colors on your screen.

Note:

Selecting ColorSync automatically sets the Ink option to Color. Changing the Ink setting after ColorSync is selected returns the settings list to Custom Settings.

Text

This setting is best for printing text-only documents. It provides you with faster printing than the Text/Graph setting with only a slight decrease in printing quality.

Note:

Changing the Ink setting after Text is selected returns the setting list to Custom Settings, so always make your Ink setting before you select this option.

Customizing the Print Settings

Many users will never need to manually make their own print settings. However, if you need more control over the driver, want to make the most detailed settings available, or just want to experiment, customize your print settings as described below.

Making your settings

1. Click the Advanced button in the Print dialog box.
2. Click the More Settings button. The More Settings dialog box appears. The settings in the More Settings dialog box allow you to modify visual effects and control printing quality. These settings are explained in detail later in this chapter.

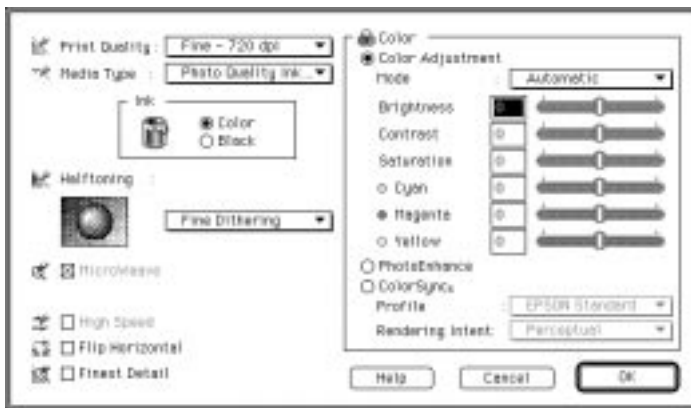

Note:

The Print Quality, Media Type, and Ink settings affect the availability of other options, so always make your settings in this order: Print Quality, Media Type, Ink, then other settings.

3. After making your settings, click OK. Your settings will be applied and you will return to the Print dialog box. To return to the Print dialog box without applying your settings, click Cancel.

Saving your settings

To save your custom settings as a group, follow these steps:

1. Click Save Settings in the Print dialog box. The Custom Settings dialog box appears.

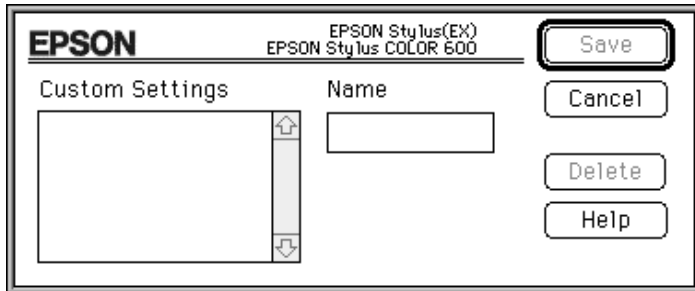

2. Type a unique name (up to 16 characters) for your custom settings in the Name box.
3. Click Save.

You can save up to 10 groups of settings. You can select your saved group of settings from the settings list in the Print dialog box.

Note:

- ❑ *You cannot use a predefined setting name for your custom settings.*
- ❑ *To delete a custom setting, select the setting in the Custom Settings dialog box and click Delete.*
- ❑ *You cannot delete the predefined settings.*

Choosing your settings

To choose your settings, click **Advanced** in the **Print** dialog box, then click in the settings list beside the **More Settings** button and select your setting.

If you change the **Media Type** or **Ink** option when one of your customized settings is selected in the settings list, the selection shown in the list returns to **Custom Settings**. The customized setting that was previously selected is not affected by this change. To return to your customized setting, simply reselect it in the list.

Modifying visual effects

If you want to make detailed modifications to the printed appearance of your color and black-and-white documents, you can use the **Color** and **Halftoning** settings in the **More Settings** dialog box. You can also invert the entire image using the **Flip Horizontal** option.

You may need to experiment with different settings to get the output you want.

Note:

*When **Color** is selected as the **Ink** setting, all **Color** settings are available. When **Black** is selected, only **Contrast** and **Brightness** are available. See page 5-5 for information on the **Ink** settings.*

Color Adjustment

The Color Adjustment settings provide you with a level of control over printed colors that you can not find in many applications.

Mode

There are four color adjustment modes as follows:

Automatic

Analyzes the print data and optimizes color correction for the type of data sent to the printer.

Photo-realistic

Provides output that closely matches the original data. Use this setting for color photographs.

Vivid

Intensifies the colors and lightens the midtones and highlights of an image. Use this setting for presentation graphics, such as charts and graphs.

No Color Adjustment

The printer driver does not enhance the color. Choose this option only when making a ColorSync profile for this printer. When printing normally, choose one of the other modes.

Slide bars

For the settings below, drag the slide bar to the right or left with your mouse or type a value in the box next to the slide bar to adjust a setting. The range varies from -25% to +25%.

Brightness

Changes the overall lightness or darkness of an image.

Contrast

Magnifies or minimizes the difference between the bright or dark parts of an image.

Saturation

Modifies the vividness of color. Lower saturation produces colors that are duller than those produced with higher saturation.

Cyan, Magenta, Yellow

Adjusts the amount of each of the three basic colors used for printing.

PhotoEnhance

Select this option when printing images taken with a video camera, digital camera, or scanner. EPSON PhotoEnhance automatically adjusts the contrast, saturation, and brightness of the original image data to produce sharper, more vivid color printouts. PhotoEnhance does not affect your original image data.

When PhotoEnhance is selected, other settings are dimmed, meaning you cannot change those settings.

Note:

- ❑ *PhotoEnhance is only available when Color is selected as the Ink option.*
- ❑ *Printing with PhotoEnhance selected may take longer depending on your computer system and on the amount of data contained in your image.*

ColorSync™

Select ColorSync when matching printed colors with the colors on your screen is important. It automatically adjusts the color range to print colors the way they appear on your screen. There are two settings, Profile and Rendering Intent. See below for details.

To use this feature, make sure you set the system profile for your monitor. To set your monitor profile, access the ColorSync System Profile utility through the Control Panel and click the Set Profile button. Select your monitor from the list of monitors that appears, and then click Select. Close the dialog box.

Note:

ColorSync is available only when Color is selected as the Ink option.

Profile

Matches the colors in your output with the colors displayed on your monitor. This software provides one profile, EPSON Standard, which is custom-designed to work with your printer. When this option is selected, the printer software uses the profile provided by EPSON.

Some companies may provide other profiles with their products. If installed, these profiles will appear in the Profile list.

Rendering Intent

Transfers the color information using the profile you have chosen from the Profile list.

Perceptual

The best option for reproducing photographs and printouts that are not suited to the other options.

Saturation

The best option for reproducing vivid images. Use this setting for presentation graphics, such as charts and graphics.

Colorimetric

The best option when precise matching of colors is most important, for example, when printing a company logo. Colorimetric attempts to reproduce colors the way the eye distinguishes them. Keep in mind that Colorimetric, or any other color matching method, may not always reproduce colors perfectly due to differences in the way scanners, printers, and other devices process color data. See Appendix B, “Tips for Color Printing,” for more information.

Halftoning

Use the Halftoning settings to achieve the results described below.

- ❑ Select No Halftoning when printing text only. Although this setting provides faster printing, it should never be used with color.
- ❑ Select Error Diffusion to make edges and colors softer when printing photographic images. Error diffusion blends every colored dot in your image with the surrounding colored dots.
- ❑ Dithering arranges dots in orderly patterns and is best suited for printing charts, graphs, and other images that require precise, solid areas of bright colors. Select Coarse Dithering for images with limited detail and shading. Select Fine Dithering for images with significant detail but limited shading.

Flip Horizontal

This feature flips the image 180° along its vertical axis. Printed images and text appear backwards.

Controlling the printing quality

Use the following controls in the More Settings dialog box to adjust the quality of the output. Some settings in this dialog box may be determined by Print Quality and Media Type settings.

Print Quality

The available Print Quality settings are:

SuperFine - 1440 dpi

Select this setting when you want the highest quality output at 1440 dpi. With this setting, we recommend the use of EPSON Photo Quality media. See page 5-4 for a complete list of EPSON special media.

Fine - 720 dpi

Select this setting when you want high-quality output at 720 dpi. With this setting, we recommend the use of EPSON Photo Quality media. See page 5-4 for a complete list of EPSON special media.

Normal - 360 dpi

Select this setting for most types of documents. Use this setting for plain paper, EPSON Ink Jet Transparencies, or EPSON 360 dpi Ink Jet Paper. See page 5-4 for a complete list of EPSON special media.

Economy

Select this option for printing rough drafts of text. This setting speeds printing and saves ink by printing fewer dots per character.

Note:

The Print Quality settings limit the availability of Media Type settings. Before selecting the Media Type, make the Print Quality setting. See page 5-4 for details on the Media Type settings.

MicroWeave

MicroWeave allows your printer to generate superior output because graphics data is re-ordered and printed in finer increments. This technology reduces the possibility of banding, the light horizontal lines that can mar an image.

Note:

- ❑ *You can select MicroWeave when printing with black ink, but the printing time is significantly longer.*
- ❑ *MicroWeave is switched off automatically when Economy is selected as the predefined setting in the Print dialog box or as the Print Quality setting in the More Settings dialog box.*

High Speed

This setting activates bidirectional printing, which reduces the time it takes to print an image. Keep in mind that High Speed should be switched off for highest quality printing.

Note:

If vertical lines printed when High Speed is selected appear misaligned, you may need to align the print head. For details, see “Aligning the Print Head” on page 8-29.

Finest Detail

If you select Fine - 720 dpi as the Print Quality setting, you can turn on Finest Detail to print text and line art with very sharp edges. Be aware that it may take considerably longer to print using this feature and it will increase your Macintosh memory requirements. Additionally, you may not be able to print some larger images, and some patterns may not print correctly. If you experience problems printing with Finest Detail on, turn it off or add more memory.

Changing the Paper Size

To change the paper size, choose Page Setup from the File menu of your application. The following dialog box appears:



Paper Size

You can use any of the following predefined paper sizes.

A4	Envelope #10
B5	Envelope C6
A5	Envelope DL
Letter	A6 Index card
Executive	Index card 5 × 8 in
Legal	Index card 8 × 10 in
Half Letter	EPSON Photo Paper 4 × 6 in

Note:

Always load paper into the sheet feeder short edge first. Load envelopes flap edge first with the flap side down.

Orientation

Use this setting to specify the direction of printing on the page,

 Portrait or  Landscape.

Reduce or Enlarge

Use this setting to reduce or enlarge the size of your image.

Printable Area

Select Maximum to make your printout as large as possible on the paper. Select Centered to position your printout at equal distances from the edges.

Defining a Custom Paper Size

If your paper size is not included in the paper size list in the Page Setup dialog box, follow the steps below to define a custom paper size.

1. In the Page Setup dialog box, click Customize.
The following dialog box appears:

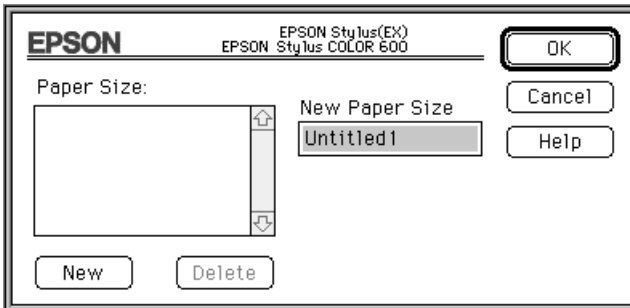

2. To define a new paper size, click New. The dialog box updates to allow you to enter a name for the new size.

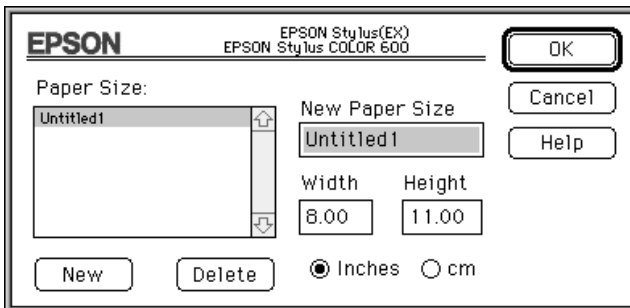

3. Type the paper size name in the New Paper Size box.
4. Specify the measurement unit as either inches or cm.
5. Type in the width and the height.
6. Click OK. You return to the Page Setup dialog box.

You can define up to eight paper sizes. The paper size names you create will appear in the Paper Size menu in the Page Setup dialog box.

To delete a custom paper size, click Customize in the Page Setup dialog box, select its name from the list in the Custom Paper dialog box, and click Delete.

Using EPSON Printer Utilities

EPSON printer utilities allow you to check the current printer status and do some printer maintenance from your screen. Click Utility in the Print dialog box to view the Utility dialog box:



EPSON StatusMonitor

The StatusMonitor utility regularly monitors the printer status. If it detects a printer error, it will inform you with an error message.

You can also use this utility to check how much ink is remaining before printing.

To use the StatusMonitor, follow these steps:

Click the EPSON StatusMonitor button in the Utility dialog box. The following dialog box appears:

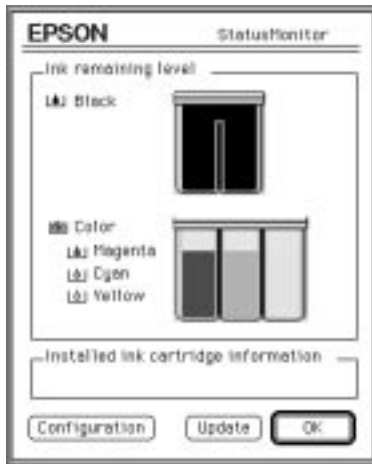

The StatusMonitor checks the amount of ink remaining once when you click the StatusMonitor button in the Utility dialog box. To update the ink-level information, click the Update button.

The StatusMonitor provides an error message when a printer error occurs while printing. You can choose how error information will be displayed using the Configuration setting dialog box. Click the Configuration button while the StatusMonitor dialog box is open. The following dialog box appears:

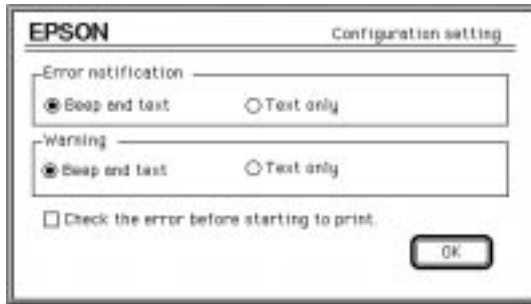

Choose the method and click OK.

Nozzle Check

Checks whether or not the print head nozzles need to be cleaned. Click the Nozzle Check button to print the nozzle check pattern. If the print head needs cleaning, you can directly enter the Head Cleaning utility from this utility. After you clean the print head, you can return to the Nozzle Check utility directly from the Head Cleaning utility.

For detailed information on print head cleaning, see Chapter 8, "Troubleshooting."

Head Cleaning

Cleans the print head. If print quality declines, use this utility to ensure the nozzles are delivering ink properly. Before and after print head cleaning, use the Nozzle Check utility to check whether the print head needs to be cleaned (again). You can access the Nozzle Check utility directly from the Head Cleaning utility. If the print quality does not improve, repeat print head cleaning.

For detailed information on print head cleaning, see Chapter 8, “Troubleshooting.”

Note:

To avoid wasting ink, clean the print head only if print quality declines.

Print Head Alignment

Aligns the print head so that images print clearly. If you find that your printed image is fuzzy or the vertical lines in your printout are not properly aligned, you may need to use this utility.

For more details on using this utility, see Chapter 8, “Troubleshooting.”

Using the EPSON Monitor2 Utility

After you send a print job to the printer, you can use the EPSON Monitor2 utility to check on what print jobs are queued for printing. You can cancel any print job in the queue. This utility also shows the status of the job currently being printed.

Before using EPSON Monitor2, you must first turn on background printing in the Chooser.

After starting a printing operation, select Epson Monitor2 from the Application menu at the right end of the menu bar. This opens a dialog box similar to the following:

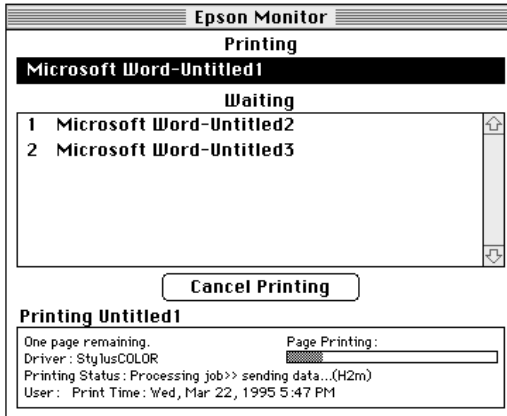

To cancel a print job, click the name of the job and then click Cancel Printing.

Chapter 6

Printing on Special Paper

Loading Special Paper and Other Media	6-2
About special media cleaning sheets	6-5
Loading Envelopes	6-6
Loading Transparencies	6-7
Using EPSON Photo Paper (S041134)	6-8
Loading	6-8
Removing the perforated margins	6-10
Storing EPSON Photo Paper	6-10



Loading Special Paper and Other Media

You can use most plain bond paper to achieve good results. However, coated papers and glossy paper/film give you better results because they reduce the amount of ink that is absorbed.

EPSON provides special media that are formulated for the ink used in EPSON ink jet printers. EPSON recommends you to use media distributed by EPSON to ensure high-quality results. For a list of EPSON special media, see page 1-6, or “Printing Supplies” in online help.

When loading special paper distributed by EPSON, read the instruction sheets packed with your special media first and keep the following in mind.

- ❑ Make sure the printable surface of the paper is face up when loading media into the sheet feeder. See the instruction sheets packed with the media to determine which side is the printable surface. Some media features cut corners to help identify the correct loading direction, as shown below.

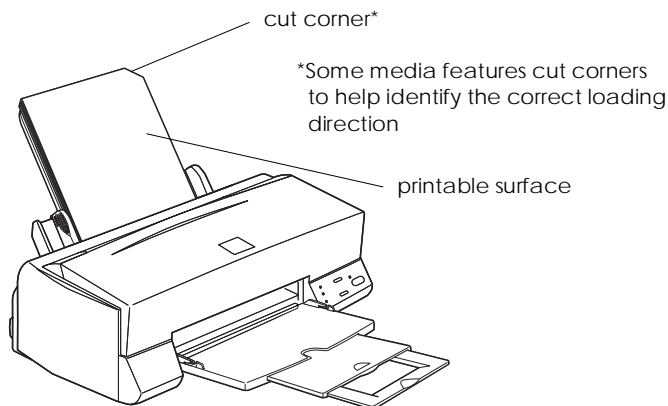

- ❑ Make sure the paper stack fits under the edge guide tab and the arrow mark, both of which are located on the inside surface of the left edge guide. Basic loading capacity for special media is explained below.

EPSON 360 dpi
Ink Jet Paper and Photo
Quality Ink Jet Paper

You can load paper up to the arrow mark. If you load legal-size ink jet paper, do not load it more than halfway to the arrow mark.

EPSON Photo Quality
Ink Jet Cards

You can load up to 30 index cards. Always place the included support sheet under the cards when loading them.

EPSON Photo Quality
Glossy Paper

You can load up to 20 sheets.

EPSON Photo Quality
Glossy Film

For best results, you should load glossy film one sheet at a time. If you wish to load multiple sheets of glossy film, load only up to 30 sheets and set the minimum top margin of the page to 30 mm. Before loading glossy film, always put a support sheet* or a sheet of plain paper under the glossy film. Be sure to remove each printout from the output tray immediately after printing. Before stacking or storing your printout, allow enough time for the ink to dry thoroughly and except for A6 size glossy film cover the printed side of every sheet with an enclosed protective sheet.

**EPSON Ink Jet
Transparencies**

You can load up to 10 transparencies. Always put a support sheet* or a sheet of plain paper under the stack of transparencies. You also need to reposition the paper support. See page 6-8. Be sure to remove each printout from the output tray immediately after printing. Before stacking or storing your printout, allow enough time for the ink to dry thoroughly and cover the printed side of every sheet with an enclosed protective sheet.

**EPSON Photo Quality
Adhesive Sheets**

You can load one sheet at a time.

Envelopes

You can load up to 10 envelopes.

*If a support sheet is packed with the paper, load it underneath the paper, but do not print on it.

- ❑ If ink smears on your documents when printing on thick special media, such as envelopes or index cards, set the adjust lever to the “+” position. To change the setting, open the printer cover and position the lever as shown below.

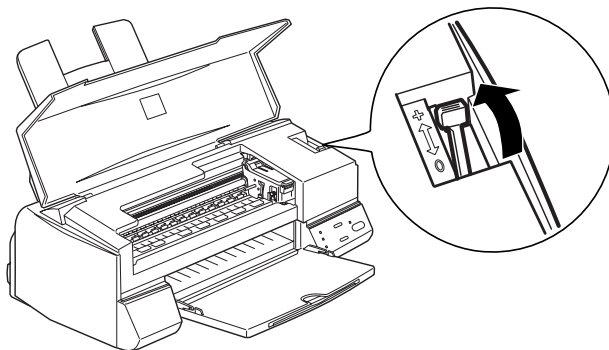

Note:

Return the adjust lever to the “0” position before printing on media of normal thickness. Leaving the lever in the “+” position may cause gaps in the printed image.

About special media cleaning sheets

Cleaning sheets packaged with EPSON special media should not be used with this printer. The cleaning function performed by these sheets is not necessary with this printer, and the sheets could jam in the printer.

Loading Envelopes

When printing on envelopes, please note the following:

- ❑ You can load up to 10 envelopes into the sheet feeder.
- ❑ Load envelopes flap edge first with the flap side down, as shown below.

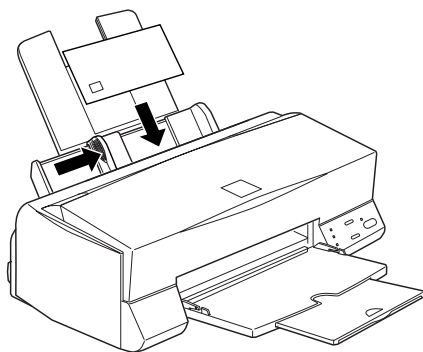

- ❑ Do not use envelopes that are curled or folded. Also avoid using envelopes that are too thin; they may curl during printing.
- ❑ Select Plain Paper as the Media Type setting in the printer driver. For more details on making printer driver settings, see online help for Windows, or Chapter 6 for Macintosh.
- ❑ If ink smears on your documents, set the adjust lever to the "+" position. To change the setting, open the printer cover and reposition the lever. See the illustration on page 6-6.

Note:

Return the adjust lever to the "0" position, which is the normal position, after you finish printing on envelopes. Leaving the lever in the "+" position may cause the printed image to have gaps on other media.

Loading Transparencies

When printing on transparencies, please note the following:

- ❑ Before loading transparencies, remove the paper support and reinstall it into the slots at the back of the printer as shown below.

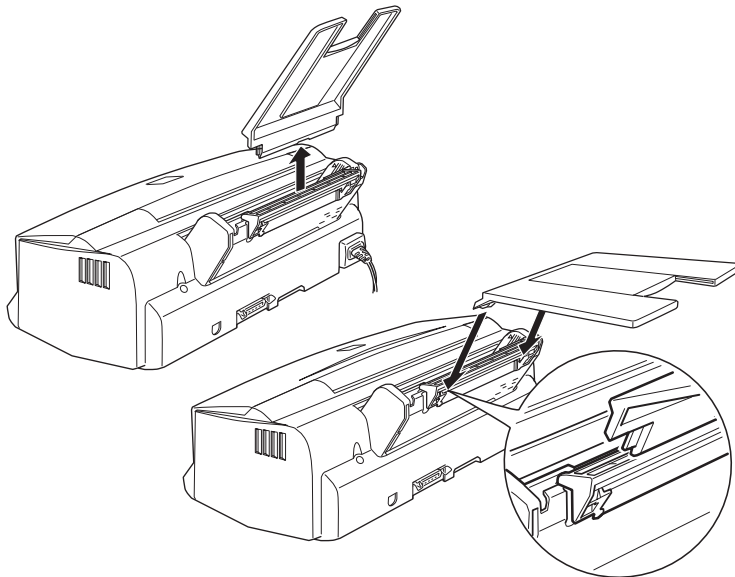

- ❑ Always put a support sheet or a sheet of plain paper under the stack of transparencies.
- ❑ You can load up to 10 transparencies.
- ❑ Make sure the printable surface of the paper is face up when loading transparencies into the sheet feeder. See the illustration on page 6-4.
- ❑ Select Ink Jet Transparencies as the Media Type setting in the printer driver. For more details on making printer driver settings, see online help for Windows, or Chapter 5 for Macintosh.

Using EPSON Photo Paper (S041134)

EPSON Photo Paper (S041134) is perforated around the margins so you can trim your printed images to look like 4 × 6 inch (102 × 152 mm) photographs. Please note the following when using this paper.

Loading

- ❑ Load the paper printable side up with the perforated margins positioned as shown below.

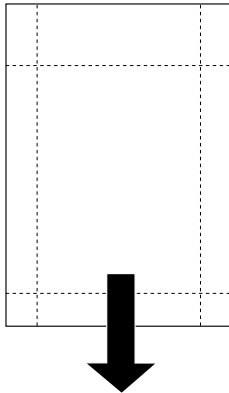

loading position

- ❑ Use flat, undamaged paper. If the paper or the support sheet is curled, flatten it before loading to avoid paper feeding problems.
- ❑ Always place the included support sheet under the stack of Photo Paper, but do not print on it.
- ❑ You can load up to 20 sheets of Photo Paper into the sheet feeder.

- ❑ To print on the coated (whiter) side of Photo Paper, select Photo Quality Glossy Paper as the Media Type setting and EPSON PhotoPaper 4X6 in as the Paper Size setting in your printer driver.

Note:

The outside edge of your image might be cut off when you remove the perforated margins.

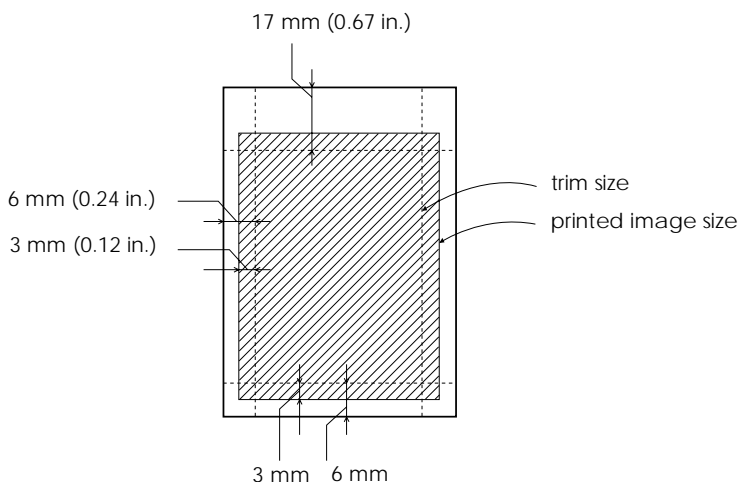

- ❑ You can also print with black ink on the non-coated side (EPSON logo side) of Photo Paper. To print on this side, select 360 dpi Ink Jet Paper as the Media Type setting and then select EPSON Photo Paper 4X6 in as the Paper Size setting.
- ❑ Cut or tear the paper at the perforation only after printing. Do not cut, tear, or fold the paper before printing.

Removing the perforated margins

- ❑ To remove the perforated margins, fold the paper back and forth a few times along the perforations, then carefully tear the margins off.

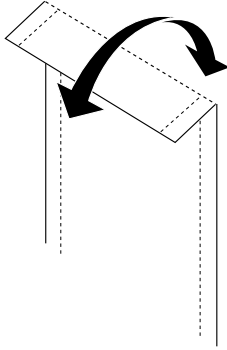

- ❑ You may also remove the margins by cutting along the perforations.

Storing EPSON Photo Paper

- ❑ Return unused paper to the original package as soon as you finish printing, and avoid storing it in places exposed to high temperature, humidity, or direct sunlight.

Chapter 7



Maintenance and Transportation

Replacing an Ink Cartridge	7-2
Cleaning the Printer	7-8
Transporting the Printer	7-9

Replacing an Ink Cartridge

The printer's indicator lights will inform you as described below when it is time to obtain a replacement ink cartridge and when it is time to replace an empty cartridge.

Note:

If you need to replace an ink cartridge when the  and  lights are off, see "Ink Cartridge Problems" on page 8-30.

EPSON recommends the use of genuine EPSON ink cartridges. Other products not manufactured by EPSON may cause damage to your printer not covered by EPSON's warranties.

When the  ink out light is

- flashing obtain a replacement black ink cartridge (S020093).
- on replace the empty black ink cartridge.

When the  ink out light is

- flashing obtain a replacement color ink cartridge (S020089).
- on replace the empty color ink cartridge.

Note:



If the ink runs out, you cannot continue printing until you replace it even if the other ink cartridge still contains ink.





Caution:



- Once you remove an ink cartridge, it becomes unusable and cannot be reinstalled even if ink remains.*
- Leave the old cartridge installed in the printer until you are ready to replace it with a new one. Attempting to print without a cartridge installed can damage the printer.*

To replace an ink cartridge, follow these steps.

1. Make sure the printer is on. The  power light should be on, but not flashing. Determine which cartridge needs to be replaced as indicated by the  black and  color ink out lights.

Note:

If you press the  cleaning button for three seconds when the  and  ink out lights are off, the printer starts cleaning the print head.

2. Make sure the output tray at the front of the printer is lowered; then open the printer cover.
3. Hold down the  cleaning button for three seconds until the print head moves left slightly to the cartridge replacement position. The  power light flashes when the print head is in position.

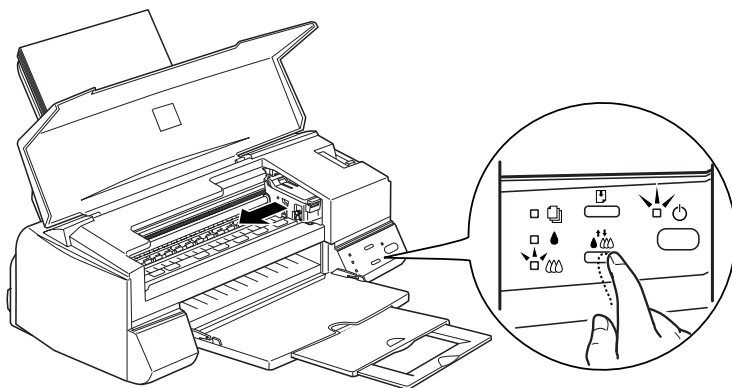

Caution:

Do not move the print head by hand. Always use the  cleaning button to move it. Otherwise you may damage the printer.

Note:

The printer automatically moves the print head back to its home (far right) position after about 60 seconds if you have not started the replacement procedure.

4. Lift up the clamp that holds the cartridge you want to replace as far as it will go. When you do, the cartridge will rise partly out of the cartridge holder. The following illustration shows color ink replacement. For black ink replacement, lift up only the smaller clamp on the left.



Caution:

Once you open the ink cartridge clamp, the ink cartridge becomes unusable and cannot be reinstalled even if ink remains.

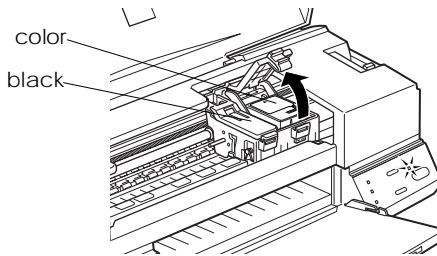

5. Lift the cartridge out of the printer and dispose of it properly. Do not take the used cartridge apart or try to refill it.



Warning:

If ink gets on your hands, wash them thoroughly with soap and water. If ink gets into your eyes, flush them immediately with water.

6. Make sure the replacement ink cartridge is the correct one, color or black. Remove the ink cartridge from its protective bag. Next, remove only the yellow tape seal from the cartridge as shown below.



black S020093

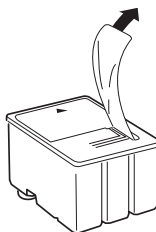

color S020089



Caution:

- You must remove the yellow tape seal from the cartridge. Leaving the tape on when you install the cartridge will permanently damage it.*
- Do not remove the whole tape seal (especially the white portion) from the top of the cartridge. Remove only the yellow portion.*
- Do not remove the tape seal from the bottom of the cartridge; otherwise, ink will leak.*

7. Lower the ink cartridge into the cartridge holder with the label on the cartridge face up and the arrow on the cartridge pointing to the rear of the printer. The larger (color) cartridge goes on the right, the black ink cartridge on the left.

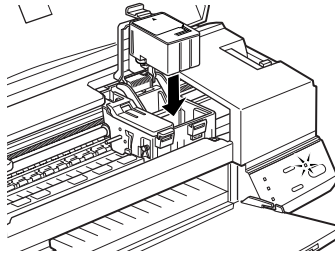

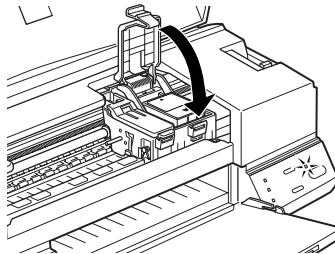

8. Press the ink cartridge clamp down until it locks in place. The following illustration shows color ink replacement. For black ink replacement, press down the smaller clamp on the left.



Caution:

Once you install the cartridges, do not open their clamps again until you replace the ink cartridges. Otherwise, the cartridges may become unusable.

9. Press the  cleaning button then close the printer cover. The printer moves the print head and begins charging the ink delivery system. This process takes about two minutes to complete.

When the ink charging process is finished, the printer returns the print head to its home position and the  power light stops flashing.



Caution:

The  power light continues to flash while the printer performs the ink charging operation. Never turn off the printer while this light is flashing. Doing so can result in incomplete charging of ink.

Note:

Even if you do not press the  cleaning button, the printer moves the print head and begins the ink charging process about 60 seconds after you replace the ink cartridge.

Cleaning the Printer

To keep your printer operating at its best, you should clean it thoroughly several times a year.

1. Make sure the printer is turned off and all the control panel lights are off. Then unplug the power cord.
2. Remove any paper from the sheet feeder.
3. Use a soft brush to carefully clean away all dust and dirt.
4. If the outer case or the inside of the sheet feeder is dirty, clean it with a soft, clean cloth dampened with mild detergent. Keep the printer cover closed to prevent water from getting inside.
5. If the inside of the printer accidentally gets soiled with ink, wipe it off with a damp cloth.



Warning:

Be careful not to touch the gears inside the printer.



Caution:

- Never use alcohols or thinners to clean the printer; these chemicals can damage the components as well as the case.*
- Be careful not to get water on the printer mechanism or electronic components.*
- Do not use a hard or abrasive brush.*
- Do not spray the inside of the printer with lubricants; unsuitable oils can damage the mechanism. Contact your dealer or a qualified service person if lubrication is needed.*

Transporting the Printer

If you need to transport your printer some distance, carefully repack it using the original box and packing materials as follows:

1. Open the printer cover and make sure that the print head is capped. It is capped when it is in the far right (home) position. If the print head is not capped, turn on the printer; then turn it off again. The print head returns to the home position and is capped. Close the printer cover.



Caution:

Leave the ink cartridges installed when you transport the printer. Removing the cartridges during transport can damage the printer.

2. Unplug the power cord from the electrical outlet; then disconnect the interface cable from the printer.
3. Remove the paper from the sheet feeder and remove the paper support.
4. Push in the output extension tray, and then raise the output tray.
5. Attach the protective materials to the printer.
6. Repack the printer and power cord in the original box.
7. Keep the printer level during transport.

Diagnosing the Problem	8-2
Error indicators	8-2
Status Monitor	8-4
Printer operation check	8-4
Problems and Solutions	8-7
Power supply	8-7
Operation	8-8
Paper handling	8-14
Printing quality	8-17
Increasing the Print Speed	8-24
Cleaning the Print Head	8-26
Aligning the Print Head	8-29
Ink Cartridge Problems	8-30
Contacting Customer Support	8-34
For United Kingdom and the Republic of Ireland users	8-34
For Australian users	8-37
For Hong Kong and Singapore users	8-39
For Philippines users	8-40











Diagnosing the Problem

Troubleshooting printer problems is best handled in two easy steps: first diagnose the problem, then apply likely solutions until the problem is fixed. The information that you need to diagnose the most common problems is provided by the printer's control panel lights and by the Status Monitor utility (Windows 95 and Macintosh only). In addition, you can determine whether a problem lies with the printer itself or with the computer by performing a printer operation check.

















In "Problems and Solutions" later in this chapter you can find causes and solutions to specific printer problems. Use the information presented in this chapter to pinpoint the source of your problem, then apply the recommended solutions until the problem is solved.

Error indicators

You can identify many common printer problems with the lights on the control panel. If your printer stops working and the lights are on or flashing, use the following table of panel light patterns to diagnose the problem, then follow the recommended corrective measures.

Lights	Problem and Solution	
	Paper Out	
	No paper is loaded in the printer.	Load paper in the sheet feeder; then press the  load/eject button to turn this light off. The printer resumes printing.
	The paper is not loaded correctly.	Remove and reload the paper; then press the  load/eject button to turn this light off. The printer resumes printing.
  	Paper Jam	
	Paper has jammed in the printer.	Take all the paper out of the sheet feeder, reload the paper, then press the  load/eject button. If the light continues to flash, turn off the printer and gently pull out any paper that may be jammed in the printer. If it tears and pieces remain inside the printer, open the printer cover and remove the pieces of paper. Turn on the printer and try again.
	Ink Low (black ink cartridge)	
	The black ink cartridge is nearly empty.	Obtain a replacement black ink cartridge (S020093). See page xx for details.
	Ink Out (black ink cartridge)	
	The black ink cartridge is empty.	Replace the black ink cartridge with a new one (S020093). See page xx for details.
	Ink Low (color ink cartridge)	
	The color ink cartridge is nearly empty.	Obtain a replacement color ink cartridge (S020089). See page xx for details.
	Ink Out (color ink cartridge)	
	The color ink cartridge is empty.	Replace the color ink cartridge with a new one (S020089). See page xx for details.

□ = on, ■ = off, □ = flashing

Lights	Problem and Solution	
       	Carriage Error	
	The printer failed.	Press the  power button twice to reset the printer. If the error is not cleared, contact your dealer.
       	Unknown Printer Error	
	An unknown printer error has occurred.	Turn off the printer, and contact your dealer.

□ = on, ■ = off,  = flashing

Status Monitor

If you are using Windows 95 or a Macintosh, you can use the Status Monitor to check the printer's current status. For more details, see Chapter 4, "Using the Printer Software for Windows", or Chapter 5, "Using the Printer Software for Macintosh."

Printer operation check

Performing a printer operation check can help you determine whether the problem comes from the printer or the computer.

- If the operation check page results appear as shown in step 4 below, this means that the printer itself is all right and that the problem probably lies in the printer software settings, application settings, the interface cable (be sure to use a shielded cable), or the computer itself.

- ❑ If the operation check page does not print satisfactorily, for example, if any segment of the printed lines is missing, there is a problem with the printer. This could be a clogged ink nozzle or a misaligned print head. See “Problems and Solutions” below for possible causes and solutions to the problem, or go directly to “Cleaning the Print Head” on page 8-26.

To perform a printer operation check, follow these steps:

1. Make sure both the printer and computer are turned off.
2. Unlock the wire clips on both sides of the interface connector and remove the ground connector, if necessary. Then disconnect the cable from the printer’s interface connector.

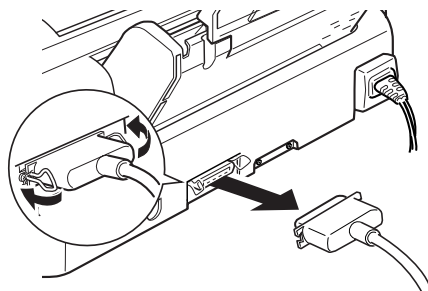



3. Make sure that paper is loaded in the sheet feeder.



Caution:

Use paper at least 182 mm (7.17 inches) wide; for example, B5 size paper loaded short edge first. Otherwise, the print head will spray ink directly onto the platen, which could mar future printouts.

4. Hold down the  load/eject button and press the  power button to turn the printer on. Then release both buttons.

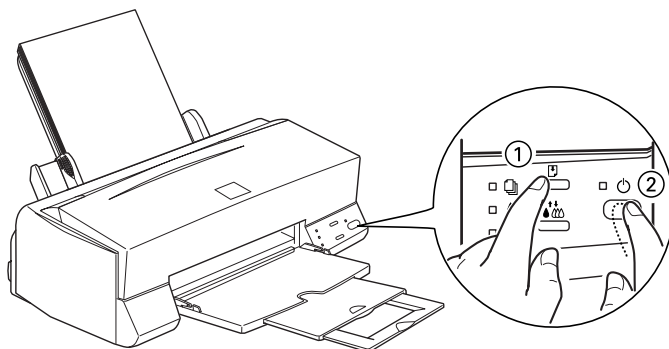

The printer prints an operation check page including the version of your printer's ROM, the ink counter code, and a nozzle check pattern. Here is a typical printout:

The above sample is in black and white, but the actual test prints in color.

5. Press the  power button to turn off the printer after it finishes printing the operation check page.

Problems and Solutions

This section divides printer problems into five categories:

- Power supply page 8-7
- Operation page 8-8
- Paper handling page 8-14
- Printing quality page 8-16

Go to the category for the type of problem you have and look for the description that most closely matches the problem. The most likely causes and solutions are listed first, so try them in the order that they are written until the problem is solved.

Power supply

The lights come on briefly but then go off and stay off.

Cause	What to do
The printer's voltage rating may not match the voltage of your electrical outlet.	Check the printer and outlet voltage ratings. If the voltages do not match, unplug the printer immediately and contact your dealer.  Warning: <i>Do not reconnect the power cord to an electrical outlet that does not have matching voltage.</i>

The printer does not work and the control panel lights are off.

Cause	What to do
The printer is turned off.	Press the ⏻ power button. The ⏻ power light will come on.
The power cord is not properly plugged into the electrical outlet.	Turn off the printer, make sure the power cord is firmly plugged into the electrical outlet, and turn the printer back on.
The electrical outlet is controlled by an outside switch or automatic timer.	Use a different outlet.
The electric outlet is out of order.	Plug another electrical device into the outlet to determine whether the outlet is working. If it is not, use a different outlet.

Operation

The ⏻ power light is on but nothing prints.

Cause	What to do
The interface cable is not plugged in securely.	Confirm that the cable is fastened to the printer and the computer securely. If the cable is connected correctly, run a printer operation check as described on page 8-4.
Your interface cable does not meet both the printer and computer specifications.	Use an interface cable that meets both printer and computer specifications. See “Interface Specifications” in Appendix C.



Your software is not properly set up for your printer. Make sure that your printer is properly selected in your software.

Install or reinstall the printer software as described in Chapter 2.

Nothing prints and the control panel lights are on or flashing.

Cause	What to do
Several common printer errors have occurred at once.	Use the table in “Error indicators” earlier in this chapter to determine what combination of errors may have occurred, and apply the recommended solutions.

The printer sounds like it is printing, but nothing prints.

Cause	What to do
The print head nozzles are clogged.	Clean the print head. See “Cleaning the Print Head” later in this chapter. If this does not work after four or five trials, see below.
One or both of the ink cartridges have been used longer than six months or beyond the date on the packaging.	Try cleaning the print head. If that does not solve the problem, replace the ink cartridges as needed. If the  and  ink out lights are off, see page 8-30 to replace the ink cartridge.

The printer operation check prints well, but nothing prints from within an application program.

Cause	What to do
Your printer is not selected in your software.	Select your printer in the printer setup section of your software.
The interface cable does not meet both the printer and computer requirements.	Use a printer cable that meets the requirements shown under “System Requirements“ on page 1-4.
Your computer is not 100% IBM [®] AT compatible.	Select Use Print Manager for this port in the Queue Setup window. To access this window, click the EPSON Spool Manager4 icon in the EPSON folder (Windows 95) or double-click this icon in the EPSON program group (Windows 3.1), and select Setup from the Queue menu.
Your computer system’s memory is too small to handle the volume of data in your document.	<p>Try reducing the image resolution of your document in your image-editing software.</p> <p>Install more memory in your computer if you can.</p> <p>Select lower resolution or less colors for your display setting as described below.</p> <p>For Windows 95, choose a lower resolution setting as the Color Palette setting. To access the Color Palette, click Start, point to Settings, and choose Control Panel. Then double-click the Display icon and click the Settings tab. For detailed information on making this setting, see your Windows 95 user’s guide.</p>

For Windows 3.1, double-click the Windows Setup icon on the Main menu; then click Options and choose Change System Settings. Then choose a lower resolution setting for your display from the Display pop-up list. For detailed information on making this setting, see your Windows 3.1 user's guide.

If you have a display-adapter setting utility, use it to set the lower resolution. For detailed information, see your display board user's guide.

For Macintosh, choose Control Panel from the Apple menu and select Monitors. Select a lower resolution. For detailed information on making this setting, see your Macintosh user's guide.

The “Sorry, EPSON Stylus COLOR cannot be used” error appears. (Macintosh only)

Cause	What to do
The printer driver has been corrupted.	Remove and reinstall the driver: From the printer software floppy disk or CD-ROM, click Installer, click Continue, and select Custom Remove from the pop-up list that displays “Easy Install.” Then select EPSON Stylus Series Printer Driver, and click Remove. Click Continue, if necessary, and click Restart. See page 2-20 for instructions on installing the printer driver.

Color documents print out in black and white.

Cause	What to do
Your printer is not selected in your software.	Select your printer in your software.
Color printing is not selected in your application or in the printer driver.	Select color printing in your application and the printer driver. Try to print again. If the image still comes out in black and white, try printing from another program. If this fixes the problem, contact the manufacturer of the software you had trouble with.

Printing starts too high or too low on the page.

Cause	What to do
Margins are set incorrectly in your application.	Check that the margins are set correctly in your program. See the printable area specifications on page C-6 in Appendix C.
The size of the paper loaded in the printer does not match the paper size setting within your application program or printer driver.	Load the correct size of paper, or change the paper size settings within your application program or printer driver to match the size of paper you are using.



Print speed is not what you expect.

Cause	What to do
The image resolution and the amount of color used in the document may be too high.	Carefully considering your use of color and resolution can help you optimize your printing times. For more details, see “Increasing the Print Speed” later in this chapter.
	Note: <i>High resolution printing and color printing significantly increase the amount of data to be processed. These two factors have the greatest effect on print speed.</i>

Something on the page is wrong or missing.

Cause	What to do
An unknown problem has occurred.	Disconnect the interface cable from the computer; then try the printer operation check described earlier in this chapter.
The printer settings within your application are incorrect.	Adjust the printer settings within your application and print again.
The interface cable is not plugged in securely.	Check that the cable is securely connected to the printer and the computer.

The print head moved to the ink cartridge replacement position unexpectedly.



Cause	What to do
The  cleaning button was pressed while the  or  light was flashing or on.	One or both of the ink cartridges is low or out of ink. Replace the ink cartridges as described on page 7-2.

The New Hardware Found screen appears even though the printer software has already been installed.

Cause	What to do
This error may occur when using Windows 95.	Click the Do not install a driver (Windows will not prompt you again) button; then click OK.

Paper handling

Paper does not feed properly from the sheet feeder.

Cause	What to do
Too many sheets are loaded in the sheet feeder.	Take the paper stack out of the feeder, remove some sheets, and reload the stack. Before you load paper, check the amount of paper you can load in the sheet feeder. See Chapter 6.
The edge guides are not set correctly.	Adjust the guides against the stack of paper. See “Loading Paper” in Chapter 3.
Paper is jammed in the paper path.	Take all the paper out of the sheet feeder, reload the paper, then press the  load/eject button. If the  paper out light continues to flash, turn off the printer and gently pull out any paper that may be jammed in the printer. If it tears and pieces remain inside the printer, open the printer cover; then remove the pieces of paper.
The paper stack does not fit under the edge guide tab inside the left edge guide.	Reload the paper so that it fits under the edge guide tab. See “Loading Paper” in Chapter 3.
The paper is curled or folded.	Use flat, undamaged paper.

The paper is old or creased.	Use only new, smooth sheets of paper.
The paper's size is not compatible with the printer.	Use paper that meets the paper requirements for this printer. See "Paper" in Appendix C.

The printer loads more than one sheet at a time.

Cause	What to do
Too many sheets are loaded in the sheet feeder.	Take the paper stack out of the feeder, remove some sheets, and reload paper. Before you load paper, check the amount of paper you can load in the sheet feeder. See Chapter 6.
The edge guides are not set correctly.	Adjust the guides against the stack of paper. See "Loading Paper" in Chapter 3.
The paper is too thin.	Make sure the paper meets the paper requirements for this printer. See "Paper" in Appendix C.

Ejected paper is wrinkled.

Cause	What to do
The paper is damp.	Do not store your paper in a damp or humid environment. Store paper in its original packaging.
The paper is too thin.	Make sure the paper meets the paper requirements for this printer. See "Paper" in Appendix C.

Paper does not fully eject.

Cause	What to do
The paper is too long.	Press the  load/eject button to eject the paper. Use paper that meets the paper requirements for this printer. See “Paper” in Appendix C.

Paper feed or paper jam problems occur frequently.

Cause	What to do
Sheets of paper are stuck together.	Fan the stack of paper and align the edges before loading.
The paper is too thin or rough.	Make sure the paper meets the paper requirements for this printer. See “Paper” in Appendix C.
Too many sheets are loaded in the sheet feeder.	Check the paper package and Chapter 6, “Printing on Special Paper”, for the amount of paper you can load at one time in the sheet feeder .
The printable side of the paper is not correctly loaded.	Try turning the stack of paper over in the sheet feeder. Most packages of paper indicate the printable side with an arrow on the end of the package. Make sure the printable side is loaded face up.

Printing quality

The printed image has gaps or faint areas.

Cause	What to do
The print head nozzles are clogged.	Clean the print head. See “Cleaning the Print Head” later in this chapter.
The paper quality has been degraded due to age.	Use new paper.
The printer driver settings may not be correct.	Select Automatic on the printer driver’s Main menu (Windows) or Print dialog box (Macintosh), and make sure the Media Type setting is appropriate for the type of paper loaded in the printer.

The printed image is blurred.

Cause	What to do
Your paper is damp.	Do not store your paper in a damp or humid environment. Store the paper in its original packaging.
The printer driver settings may not be correct.	Select Automatic on the printer driver’s Main menu (Windows) or Print dialog box (Macintosh), and make sure the Media Type setting is appropriate for the type of paper loaded in the printer.

The printed image is smeared.

Cause	What to do
The paper you loaded is too thick.	Open the printer cover and set the adjust lever to the “+” position. See Chapter 6, “Printing on Special Paper.”

Special paper was loaded without the support sheet or a regular sheet of paper under it. Index cards, glossy film, glossy paper, and transparencies should be loaded with the support sheet or a piece of plain paper under them.

Load the support sheet or a piece of plain paper under the special paper. See Chapter 6, "Printing on Special Paper," or the instructions packed with your paper.

Multiple sheets of EPSON Photo Quality Glossy Film are loaded.

Load glossy film one sheet at a time with the loading support sheet or a piece of plain paper under it.

If you need to load multiple sheets of glossy film, load only up to 30 sheets with the loading support sheet or a piece of plain paper under them and set the top margin of the page to 30 mm or more.

Ink has leaked on the platen.

Wipe the inside of the printer as shown below with a soft, clean cloth.

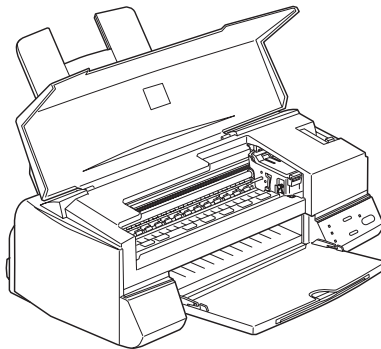



Warning:

Be careful not to touch the gears inside the printer.

The print head nozzles are clogged.	Clean the print head. See “Cleaning the Print Head” later in this chapter.
-------------------------------------	--

White horizontal lines appear in the printed image.

Cause	What to do
The print head nozzles are clogged.	Clean the print head. See “Cleaning the Print Head” later in this chapter.
One of the ink cartridges is low on ink.	Check the control panel to confirm that the  or  ink out light is flashing, and replace the appropriate ink cartridge.
The MicroWeave option in your printer driver is not selected.	Turn on MicroWeave in your printer driver.
The Media Type setting in your printer driver is incorrect.	Make sure the Media Type setting matches the type of paper loaded in the printer.

Vertical printed lines do not align.

Cause	What to do
The print head is misaligned.	Align the print head with the Print Head Alignment utility. See “Aligning the Print Head” later in this chapter.
The printing position is misaligned.	Make sure the High Speed option in your printer driver is not selected.

Printing quality is not what you expect.

Cause	What to do
The paper loaded is not the paper selected in your application or the printer driver.	<p>Make sure you loaded the correct paper in the printer and that you selected the same media type in your application and/or the printer software.</p> <p>Make sure you are using paper that meets the paper requirements for this printer. See “Paper” in Appendix C.</p>
You are not printing on the correct side of the paper.	Check the paper packaging for the correct side for printing; then load the printable side of the paper face up in the sheet feeder.
The printer driver settings are not correct.	Check the printer driver settings to make sure they are appropriate. If these settings are correct, check your application because some settings are overridden by application settings. Also, for more information on making printer driver settings, see online help for Windows, or Chapter 5 for Macintosh.
The High Speed setting is selected in the printer driver.	To obtain higher quality output, make sure High Speed is not selected.

Colors are different than you expect.

Cause	What to do
The color print head nozzles are clogged.	Clean the print head. See “Cleaning the Print Head” later in this chapter.
Black ink is selected in your printer driver.	Set the Ink setting to Color.
The paper is not loaded printable side up.	Check that the printable side of the paper is facing up.
The Media Type setting does not match the paper loaded.	Change the Media Type setting in your printer driver to match the type of media you have loaded. Load media that matches the Media Type setting you selected in the printer driver.
The ICM (Windows) or ColorSync (Macintosh) setting in your driver is not appropriate for your document.	Select Automatic as the Mode setting in the printer driver.
Your printer and monitor are not properly calibrated for color matching.	See the user’s guides of your image-editing software and your monitor for information on calibrating your system for color matching.
Since monitors and printers produce colors differently, printed colors will not always match on-screen colors perfectly.	See Appendix B, “Tips for Color Printing”.

Colors are not very vibrant.

Cause	What to do
The image was printed on the wrong side of EPSON Ink Jet Paper.	Make sure that you are printing on the coated side of the paper. If necessary, flip over the paper and try printing again. If printing has not improved, clean the print heads as described later in this chapter.
The Media Type setting does not match the paper loaded.	Make sure the Media Type setting in your printer driver matches the type of media you have loaded, or load media that matches the Media Type setting.

**Color dots are missing in printed characters or graphics.
The printed color image has gaps or faint areas.**

Cause	What to do
The color print head nozzles are clogged.	Clean the print head. See “Cleaning the Print Head” later in this chapter.

**Black dots are missing in printed characters or graphics.
The printed black image is light or faint.**

Cause	What to do
The black print head nozzles are clogged.	Clean the print head. See “Cleaning the Print Head” later in this chapter.



Photographic images look grainy or rough.

Cause	What to do
The printing position is misaligned.	Align the print heads with the Print Head Alignment utility. See “Aligning the Print Head” later in this chapter.
The resolution of the original image data or the resolution setting for the image in your image-editing software may be too low.	Increase the image resolution in your image-editing software. Keep in mind that higher resolution images take longer to print.

The Status Monitor window does not appear when you are using Windows 95.

Cause	What to do
The Use Print Manager for this port option is selected in the Queue Setup window.	Make sure Use Print Manager for this port is not selected. Click the Start button, point to Programs, point to Epson, and click Spool Manager4. Then click Queue and Setup in the EPSON Spool Manager window.
The Enable bi-directional support for this printer option is not selected in the Spool Settings window.	You must select Enable bi-directional support for this printer in the Spool Settings window to use the Status Monitor. To access the Spool Settings window, click the Start button, point to Settings, and click Printers. Right-click the icon for your printer and choose Properties from the drop-down menu. Click the Details tab; then click Spool Settings. Select Enable bi-directional support for this printer.

When you clean the print head using the Head Cleaning utility, the output quality does not improve.

Cause	What to do
You attempted to clean the print head while one or both of the ink cartridges were low or out of ink.	Check the  and  ink out lights. When one or both of the ink cartridges are low or out, the Head Cleaning utility has no effect. Replace the ink cartridges as needed. See page 8-2.

Increasing the Print Speed

Just as printing at a high resolution requires more processing time, printing in color takes longer than printing in black because the volume of data in a color document is much greater. For this reason, it is important to be selective in your use of color if you also require a faster print speed.

Even if your document requires the highest resolution and extensive use of color, for example when printing a camera-ready composite that includes color photographs, it may still be possible to optimize the print speed by adjusting other printing conditions. Keep in mind that changing some conditions to increase the print speed may also lower print quality.

The following table shows the factors that inversely affect print speed and print quality (increasing one will decrease the other).

Print quality	Lower	Higher
Print speed	Faster	Slower
Printer software settings		
Print Quality	Economy	SuperFine-1440 dpi
High Speed	On	Off
Halftoning	No halftoning	Error Diffusion

Print quality Print speed	Lower Faster	Higher Slower
Data characteristics		
Image size	Small	Large
Resolution	Low	High

The table below shows the factors related to print speed only.

	Print speed	
	Faster	Slower
Printer software settings		
Ink	Black	Color
Collate*	Off	On
Page reverse*	Off	On
Page rotate*	Off	On
Data characteristics		
Variety of colors	Grayscale **	Full color
Hardware resources		
System speed	Fast	Slow
HDD free space	Large	Small
Memory free space	Large	Small
Software status		
Running applications	One	Many
Virtual memory	Not in use	In use

*Varies depending on the printer software and application software you are using.

**Grayscale means using black ink only to print varying shades of gray, from pure black to pure white.



Cleaning the Print Head

If you find that the printed image is unexpectedly faint or dots in the printed image are missing, you may be able to solve these problems by cleaning the print head, which ensures that the nozzles are delivering ink properly.

You can clean the print head from your computer using the Head Cleaning utility in the printer software.



If you are using DOS or you cannot clean the print head with this utility, you can use the printer's control panel instead. For more details, see "Cleaning the Print Head" in Appendix A.

Note:



- Print head cleaning uses ink. To avoid wasting ink, clean the print head only if print quality declines.*
- Use the Nozzle Check utility to confirm that the print head needs to be cleaned.*
- When the  black or  color ink out light is flashing or on, you cannot clean the print head. Replace the appropriate ink cartridge first.*
- Do not start the Head Cleaning or Nozzle Check utility while printing is in progress; otherwise your printout may be marred.*

To clean the print head, follow these steps:

For Windows users:

1. Make sure that the printer is on, and the  and  ink out lights are off.

Note:

The print head cannot be cleaned if the  or  ink out light is flashing or on. Replace the ink cartridges as needed before proceeding.

2. Access the printer driver setting menu as described in Chapter 4.
3. Click the Utility tab, then click the Head Cleaning button.
4. Follow the on-screen messages.

The  power light flashes while the printer performs the cleaning cycle. This operation takes about two minutes to complete.



Caution:

Never turn off the printer while the  power light is flashing. Doing so may damage the printer.

5. When the  power light stops flashing, click Print nozzle check pattern in the Head Cleaning dialog box and use the pattern to confirm that the head is clean and to reset the cleaning cycle.



Nozzle check pattern:

The above sample is in black and white, but the actual check pattern prints in color.



In the check pattern, if you find that any segments are missing from the test lines, you may need to repeat the head cleaning and print the nozzle check pattern again.

If print quality hasn't improved after repeating this procedure four or five times, follow the recommendations listed in this chapter. If the print quality still has not improved, contact your dealer.

For Macintosh users:

1. Make sure that the printer is on, and the  and  ink out lights are off.

Note:

The print head cannot be cleaned if the  or  ink out light is flashing or on. Replace the ink cartridges as needed before proceeding.

2. Choose Utility from the Print dialog box.
3. Click the Head Cleaning button.
4. Follow the on-screen messages.

The  power light flashes while the printer performs the cleaning cycle. This operation takes about two minutes to complete.



Caution:

Never turn off the printer while  power light is flashing. Doing so may damage the printer.

5. When the  power light stops flashing, click the Confirmation button in the Head Cleaning dialog box to print a nozzle check pattern and to reset the cleaning cycle. Use the check pattern to confirm the head is clean. See page 8-27 to see a sample of the nozzle check pattern.

In the check pattern, if you find that any segments are missing from the test lines, you may need to repeat the head cleaning and print the nozzle check pattern again. If print quality hasn't improved after repeating this procedure four or five times, try other recommendations listed in this chapter. If the print quality still has not improved, contact your dealer.

Aligning the Print Head

If you notice a misalignment of vertical lines, you may be able to solve these problems from your computer using the Print Head Alignment utility in the printer software.

If you are using DOS or you cannot align the print head with this utility, see Appendix A.

Note:

Do not start the Print Head Alignment utility while printing is in progress; otherwise your printout may be marred.

For Windows users:

1. Make sure paper is loaded in the sheet feeder.



Caution:

Use paper at least 210 mm (8.27 inches) wide; for example, A4 size paper loaded short edge first. Otherwise, the print head will spray ink directly onto the platen, which could mar future printouts.

2. Access the Utility menu as described in Chapter 4.
3. Click the Print Head Alignment button.
4. Follow the messages on your screen to align the print head.

For Macintosh users:

1. Make sure paper is loaded in the sheet feeder.





Caution:

Use paper at least 210 mm (8.27 inches) wide; for example, A4 size paper loaded short edge first. Otherwise, the print head will spray ink directly onto the platen. This may cause any documents you print afterwards to be smeared.

2. Choose Utility from the Print dialog box.
3. Click the Print Head Alignment button.
4. Follow the messages on your screen to align the print head.

Ink Cartridge Problems

If output quality does not improve even after cleaning and aligning the print head, you may need to replace one or both of the ink cartridges.



To replace an ink cartridge while the  and  ink out lights are off, follow these steps.

If the  or  ink out light is flashing or is on, replace the empty ink cartridge as described in “Replacing an Ink Cartridge” on page x-xx.



Caution:

- Once you remove an ink cartridge it becomes unusable and cannot be reinstalled even if ink remains.*
 - Leave the old cartridge installed in the printer until you are ready to replace it with a new one.*
1. Make sure the printer is on. The  power light should be on, but not flashing.

2. Lower the output tray at the front of the printer; then open the printer cover.
3. Hold down the  load/eject button for three seconds. The print head moves to the replacement position. The  power light begins flashing.

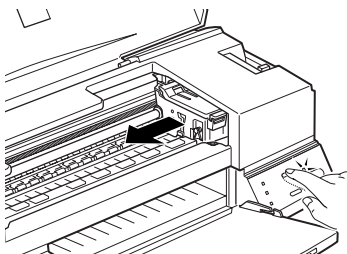
**Caution:**

Do not move the print head by hand. Always use the  load/eject button to move it. Otherwise you may damage the printer.

Note:

The printer automatically moves the print head back to its home (far right) position after 60 seconds if you have not started the replacement procedure.

4. Lift up the clamp that holds the cartridge you want to replace. When you do, the cartridge rises partly out of the cartridge holder. For color ink cartridge replacement, lift up the larger clamp on the right. For black ink cartridge replacement, lift up the smaller clamp on the left.

5. Lift the cartridge out of the printer and dispose of it properly. Do not take the used cartridge apart or try to refill it.



Warning:

If ink gets on your hands, wash them thoroughly with soap and water. If ink gets into your eyes, flush them immediately with water.

6. Remove the ink cartridge from its protective bag. Next, remove only the yellow tape seal from the cartridge as shown below.



black S020093



color S020089



Caution:

- You must remove the yellow tape seal from the cartridge. Leaving the tape on when you install the cartridge will permanently damage it.*
 - Do not remove the tape seal from the bottom of the cartridge; otherwise, ink will leak.*
7. Lower the ink cartridge into the cartridge holder with the label on the cartridge face up and the arrow on the cartridge pointing to the rear of the printer.

8. Press the ink cartridge clamp down until it locks in place. The following illustration shows color ink replacement. For black ink replacement, press down the smaller clamp on the left.

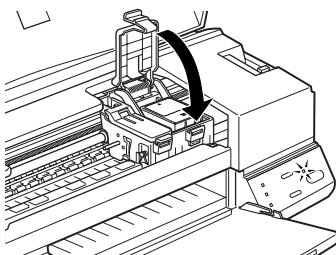
**Caution:**

Once you install the cartridges, do not open their clamps again until you replace the ink cartridges. Otherwise, the cartridges may become unusable.

9. Press the  load/eject button then close the printer cover. The printer moves the print head and begins charging the ink delivery system. This operation takes about two minutes to complete.

When the ink charging process is finished, the printer returns the print head to its home position and the  power light stops flashing.

**Caution:**

The  power light continues to flash while the printer performs the ink charging operation. Never turn off the printer while this light is flashing. Doing so can result in incomplete charging of ink.

Even if you do not press the  load/eject button, the printer moves the print head and begins the ink charging process about 60 seconds after you replace the cartridge.

Contacting Customer Support

If your printer is not operating properly and you cannot solve your problem with the troubleshooting information in this guide, online help, and EPSON Answers, contact customer support services for assistance.

We will be able to help you much more quickly if you are able to give the exact information indicated below.

Serial number of your printer:

(The serial number label is on the back of the printer.)

Printer model:

Brand and model of your computer:

Printer software version:

(Click About on the printer driver's Main menu.)

Version of Windows (95, 3.1, etc.) you are using now:

Version of software applications you normally use with your printer:

For United Kingdom and the Republic of Ireland users

If you purchased your printer in the UK or the Republic of Ireland, Epson (UK) Limited provides a range of customer services and technical support.

Note:

For customers in the Republic of Ireland, please use the correct dialing codes when dialing the UK telephone numbers listed in the following sections. For example the Enquiry Desk fax number, 01442 227271, should be dialed as 0044 1442 227271 from the Republic of Ireland.

Enquiry Desk

The enquiry desk team can be contacted by calling 0800 220546 in the UK or 1 800 409132 from the Republic of Ireland, by faxing 01442 227271, and via the Internet at info@epson.co.uk. They can provide the following information:

- Information and literature on new EPSON products (also available from Faxon Epson)
- Where to purchase genuine EPSON consumables, accessories and options

Customer Support

Our Customer Support team can provide the following services:

- Technical information on installing, configuring, and operating your EPSON products
- Arranging for faulty EPSON products to be repaired within the warranty period

For information on contacting our Customer Support team, please see the Service and Support Information booklet that came with your EPSON product.

If this booklet is not available, details can be found on Faxon Epson faxback service, EPtec Bulletin Board Service or on EPSON's World Wide Web site. See below for details.

Faxon Epson

Contact Faxon Epson faxback service for:

- ❑ Literature and specifications on the latest EPSON products
- ❑ Support information including troubleshooting tips, switch settings and driver information

To use Faxon Epson, call 01442 227332 using a touch-tone phone. You will be asked to follow a simple routine to register your document request, and once you have entered your telephone and fax numbers, Faxon Epson will fax a copy of the document catalogue to your fax machine.

When you have found the documents that you need in the catalogue, call Faxon Epson again and enter the document ID numbers. The documents will be faxed to you automatically.

EPtec - Bulletin Board Service

Call the Epson Bulletin Board Service on 01442 227479 for the latest drivers and utilities. No membership is required. Make sure that your communications software is set to 8 data bits, 1 stop bit, no parity bit, ANSI terminal mode emulation and a modem speed of up to 28.8 Kbps. Downloading protocols supported include Xmodem, Ymodem and Zmodem. See the documentation that came with your communications software and modem for more information.

When you first connect to the Bulletin Board Service, you will be asked for your name, company name, phone number and a password (which you can invent yourself).

World Wide Web

If you can connect to the Internet and have a Web Browser, you can access EPSON's World Wide Web site at <http://www.epson.com>. Here you will find information on the latest EPSON products, software drivers, and answers to frequently asked questions.

For Australian users

EPSON Australia wishes to provide you with a high level of Customer Service. As well as this *User's Guide*, we provide the following sources for obtaining information:

EPSON FAXBACK

EPSON FAXBACK will fax you the latest specifications and pricing for most EPSON products offered in Australia. There is also technical information including details of the latest software and drivers available. Phone (02) 9903 9075 and the system will guide you through a number of choices before faxing the information to your fax machine.

EPSON Bulletin Board System

This is where you can download the latest software and drivers. Visit the BBS to check out the latest versions. If you have a modem, phone (02) 9417 5090.

Internet URL <http://www.epson.com.au>

Access the EPSON Australia World Wide Web pages. Worth taking your modem here for the occasional surf! You can get the same information as offered on the EPSON FAXBACK and the EPSON Bulletin Board plus more.

Your Dealer

Don't forget that your dealer can often help identify and resolve problems. The dealer should always be the first call for advice on problems. They can often solve problems quickly and easily as well as give you advice on the next step to take.

EPSON Helpdesk

EPSON Helpdesk is provided as a final backup to make sure our clients have access to advice. Operators on the Helpdesk can aid you in diagnosing hardware and software problems. They can also advise you on the latest EPSON products and where the nearest dealer or service agent is located. Many types of queries are answered here.

Access to the Helpdesk is at no charge to purchasers of new products for the first 12 months of that product's life. After that period, a different phone number is used and charges are debited to your telephone account. The current charge rates are specified when you ring the chargeable support number. You are asked to signify your acceptance before any charges are incurred.

The Helpdesk numbers are:

first 12 months	(02) 9903 9040
after 12 months	1 902 263 192
fax number	(02) 9903 9189

We encourage you to have all the relevant information on hand when you ring. The more information you prepare, the faster we can help solve the problem. This information includes the user's guide for your EPSON product, type of computer, operating system, application programs, and any other information you feel is required.

For Hong Kong and Singapore users

Contact the phone or fax number shown below for your area:

Hong Kong

Phone: 2585 4300
Fax: 2827 7083

Singapore

Phone: 3377911
Fax: 3341185

Internet home page

EPSON Hong Kong has established a local home page in both Chinese and English on the Internet to provide users with the following information:

- Product information
- Answers to Frequently Asked Questions (FAQs)
- Latest versions of EPSON printer drivers

Users can access our World Wide Web home page at:
<http://www.epson.com.hk>.

Electronic bulletin board system

An electronic bulletin board system (BBS) is also available to obtain printer information and the latest versions of printer drivers. You can log on to the following number for the BBS service:

BBS: (852) 2827-4244

Technical Support Hotline

You can also contact our technical staff at the following telephone and fax numbers:

Phone: (852) 2585-4399

Fax: (852) 2827-4383

For Philippines users

To obtain technical support as well as other after sales services, users are welcome to contact the EPSON Philippines Representative Office at the telephone and fax numbers below:

Phone: (632) 813-6552

Fax: (632) 813-6545

BBS: (632) 814-0595

Appendix A

Using the Printer with DOS

Installing the Printer Software for DOS Programs	A-2
Using Built-in Fonts and Character Tables	A-3
Fonts	A-4
Cleaning the Print Head	A-6
Aligning the Print Head	A-7
Using Power-On Functions	A-8



Installing the Printer Software for DOS Programs

Most DOS software programs include software for EPSON ESC/P 2™ printers. You need to select the correct printer software to take advantage of your printer's advanced built-in scalable fonts and graphics handling.

Most DOS programs require you to select from a list of printers to install the printer software. If your printer is not included in the list, contact your software manufacturer to obtain updated software.

If your printer software is not available, pick the first printer available in the list below.

When printing black only:

- LQ-870/1170
- LQ-570 (+)/1070(+)
- SQ-870/1070
- LQ-850
- LQ-500

When printing black and color:

- EPSON Stylus PRO
- EPSON Stylus COLOR 500
- EPSON Stylus COLOR II
- LQ-860
- LQ-2550

Note:

The drivers for the printers listed above do not provide all EPSON Stylus COLOR 600 features, such as 720-dpi printing, 1440-dpi printing and MicroWeave.

DOS software varies greatly. See the printing section of your software manual for information on accessing the printer driver settings.

Using Built-in Fonts and Character Tables

Your printer has eight built-in fonts and eleven character tables that you can select using the printer's default-setting mode as described below. The settings you choose take effect each time you turn on the printer. Available fonts are listed in the next section. For available character tables, see Appendix C.

Note:

Font and character table selections you make with your software override the settings you make using the default-setting mode. For best results, use your software to make these settings.

To change the default font or character table, follow these steps:

1. Make sure the printer is turned off and paper is loaded in the sheet feeder.



Note:

Use paper at least A4 (210 mm/8.27 inches) size or wider. Otherwise, the print heads will spray ink directly onto the platen, which could mar future printouts.

2. Hold down the  cleaning button and turn on the printer to enter the default-setting mode.

The printer loads a sheet of paper and prints a brief summary and instructions. It instructs you to select the language that you want messages printed in (English, French, German, Italian, or Spanish).

3. Press the  cleaning button until the following lights indicate the language of your choice:

Language			
English	<input type="radio"/>	<input checked="" type="radio"/>	<input checked="" type="radio"/>
French	<input checked="" type="radio"/>	<input type="radio"/>	<input checked="" type="radio"/>
German	<input type="radio"/>	<input type="radio"/>	<input checked="" type="radio"/>
Italian	<input checked="" type="radio"/>	<input checked="" type="radio"/>	<input type="radio"/>
Spanish	<input type="radio"/>	<input checked="" type="radio"/>	<input type="radio"/>

○ = On, ● = Off



4. Press the  load/eject button to print the current default font and character table and the next instructions in the language you selected. The printed instructions list all of the fonts and character tables you can select and show you how the control panel lights appear for each selection. Use the instruction sheets to change the settings from the control panel.
5. After making your changes, exit the default-setting mode by turning off the printer.

Note:

- You may exit the default-setting mode any time by turning off the printer. Any changes you have made remain in effect until you change them again.*
- If you want to check the current default font and character table, enter the default-setting mode again and print the current settings. The current settings are indicated with arrows.*

Fonts

Your printer has eight built-in character fonts including two EPSON fonts: EPSON Roman T and EPSON Sans Serif H. (Roman T is similar to the Times™ font; Sans Serif H is similar to Helvetica™)

The table below shows the available fonts.

Fonts	Sample
EPSON Courier	
EPSON Roman T	
EPSON Sans Serif H	
EPSON Roman	
EPSON Sans Serif	
EPSON Prestige	
EPSON Script	
Draft	

Note:

- ❑ *Roman T and Sans Serif H fonts are available in proportional spacing only.*
- ❑ *Some of the character tables might not be able to print with EPSON Roman T and EPSON Sans Serif H fonts. In these cases, selected character tables are printed with EPSON Roman.*

Scalable fonts

The size of the Roman, Sans Serif, Roman T, and Sans Serif H fonts can be selected from 8 to 32 points in 2-point increments through your software or by sending an ESC/P 2™ command. See the documentation that came with your software for information on selecting the size of scalable fonts.

EPSON
Roman

EPSON
Roman T

EPSON
Sans Serif

EPSON
Sans Serif H



scalable sample





Cleaning the Print Head



If print quality diminishes, use the printer's built-in print head cleaning cycle to ensure that the nozzles are delivering ink properly.

To avoid wasting ink, clean the print head only if print quality declines.

1. Make sure that the printer is on and the  and  ink out lights are off.

Note:

The print head cannot be cleaned if the  or  ink out light is flashing or on. Replace the ink cartridges as needed before proceeding.

2. Press the  cleaning button for three seconds. The  power light begins flashing, and the printer ejects any paper in the paper path and starts cleaning the print head. This operation takes about two minutes to complete.



Caution:

Never turn off the printer while the  power light is flashing. Doing so may damage the printer.

3. After the  power light stops flashing, print a few lines to confirm that the head is clean and to reset the cleaning cycle.

If you entered the print head cleaning mode while the printer was printing a document, the printer feeds paper and resumes printing automatically.

If the print quality does not improve, repeat step 2, then print a few lines to check the output. If print quality hasn't improved after repeating this procedure four or five times, see Chapter 8, "Troubleshooting." If the print quality still has not improved after following the recommendations listed in Chapter 8, contact your dealer.

Aligning the Print Head

When you find that the printed image is fuzzy or the vertical lines in your printout are not properly aligned, you may need to align the print head with the EPSON Print Head Alignment Utility. This utility aligns the print head to print images clearly. You may need to align the print head when you transport the printer or move it to a different environment.

To install this utility on your hard drive, insert the EPSON Printer Software CD-ROM into your CD-ROM drive and then type `D:\SETUP` at the DOS prompt. (If your CD-ROM driver has a different drive letter, or if you are using the floppy version, substitute it for `D:\`.) Follow the directions on the screen. After running the setup program, change to the drive and directory that contains the utility (or set the path to the directory). Then type `EPCALIB` and press Enter. The following window appears:



Make sure your printer is selected. Click Next, then follow the directions on the screen.

Note:

This utility is designed to be run in DOS with or without a mouse.

Using Power-On Functions

The functions below (in italics) are available if you hold down the corresponding control panel buttons while turning on the printer:

Printer operation check =  load/eject button

Prints test pages including a nozzle check pattern, the version of your printer's ROM, and an ink counter code. See page 8-4 for more details.

Default setting =  cleaning button

Enters the default-setting mode. You can change the printer's default font and character table. See "Using Built-in Fonts and Character Tables" on page A-3.

Appendix B

Tips for Color Printing

Basics of Color B-2
Image Resolution and Image Size B-5
Basics of Color Documents B-7



Basics of Color

This section describes the basic properties of color, the relationships between colors, and how to use color to improve the quality of your printed documents.

Properties of color

Color is composed of three properties: Hue, Saturation, and Brightness.

Hue	The name of the color, such as red, blue, or violet. The circle that represents the relationship between all hues is called the hue circle.
Saturation	The vividness of the color. This represents the amount of gray in proportion to the hue.
Brightness	The relative lightness or darkness of the color.

The method for representing these properties is called the Munsell renotation color system. The hue circle and the Munsell renotation color system are useful to understand the properties of color. See also the *Color Guide*.

Synchronizing monitor colors and printer colors

Your printer produces images by printing tiny patterns of ink dots on paper. It uses the colors cyan (C), magenta (M), yellow (Y), and black (K) to create a blending effect that makes you think you are seeing millions of colors. This type of color, produced by pigments that absorb some colors of light and reflect others, is called subtractive.

Note:

In theory, pure cyan, magenta, and yellow should produce black, but actually they produce a muddy brown and must be combined with black ink to produce a true black (K).

Your monitor produces images by illuminating color phosphors on the screen with an electron gun. (A phosphor is a substance that gives off light when irradiated.) Each screen point (pixel) has three colored phosphors: red (R), green (G), and blue (B).

Since the printer and monitor produce color images differently, and also the available range of color produced by the monitor and printer are different, the image on the screen does not exactly match your printed output all of the time. If you want to adjust, or calibrate, the printed color to more closely match the on-screen color, you may have to experiment with the printer driver settings.

Additionally, color management software is available from a variety of software and monitor companies to help you match colors produced by your monitor and printer. See your image-editing software user's guide for information on color matching.

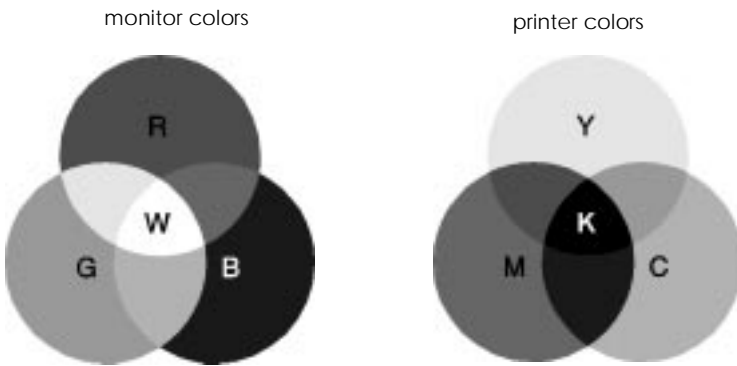

The range of colors that can be displayed:

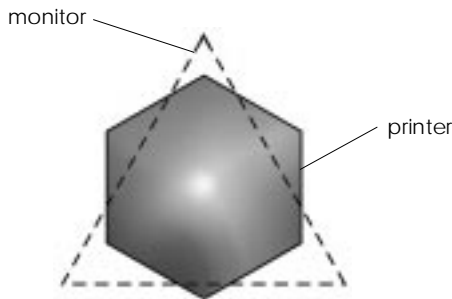

Note:

When printing a scanned image, you may find it more difficult to match colors. Because scanners create the original image data using CMYK, the data format of your image will be changed twice.

Process of color printing

A printer produces color images by printing tiny patterns of ink dots using CMYK colors as mentioned in the previous section. Because most ink jet printers are not able to print different gradations of the three primary colors, they must use a halftoning method in order to represent millions of colors or the gradation of colors as follows:



Dithering and error diffusion are the most commonly used halftoning methods.

Dithering

Dithering uniformly aligns individual dots of different colored inks to create the appearance of neutral colors. This method is suitable for printing documents that contain large areas of solid color, such as bar charts and graphs.

Error diffusion

Error diffusion randomly places individual dots of different colors to create the appearance of neutral colors. By randomly placing dots, the printer can achieve excellent colors and subtle color gradation. This method is suited for printing documents that contain finely detailed graphics or photographic images.

Image Resolution and Image Size

The resolution of your original image affects the quality of your printouts. Generally, the higher the resolution, the better the print quality. However, keep in mind that the higher the resolution, the longer the wait for processing and printing a document.

Generally, the printed image size is in inverse proportion to the image resolution, as shown below. The larger the image size, the lower the image resolution. Conversely, the smaller the image size, the higher the image resolution.

Note:

Some applications have a function that can correct this relationship.

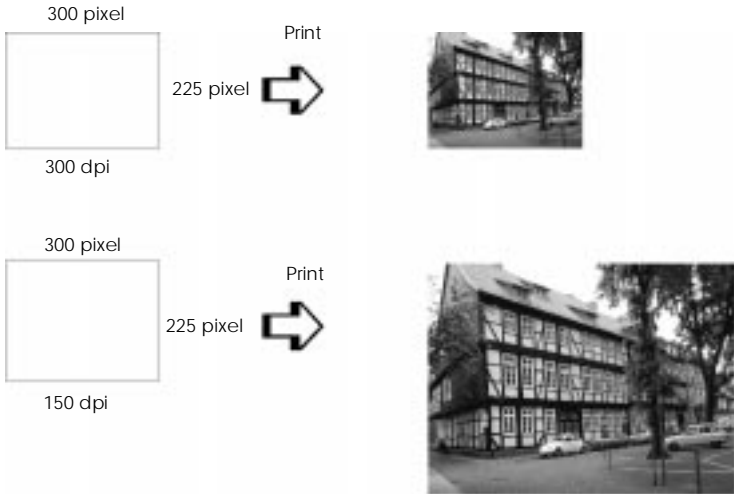

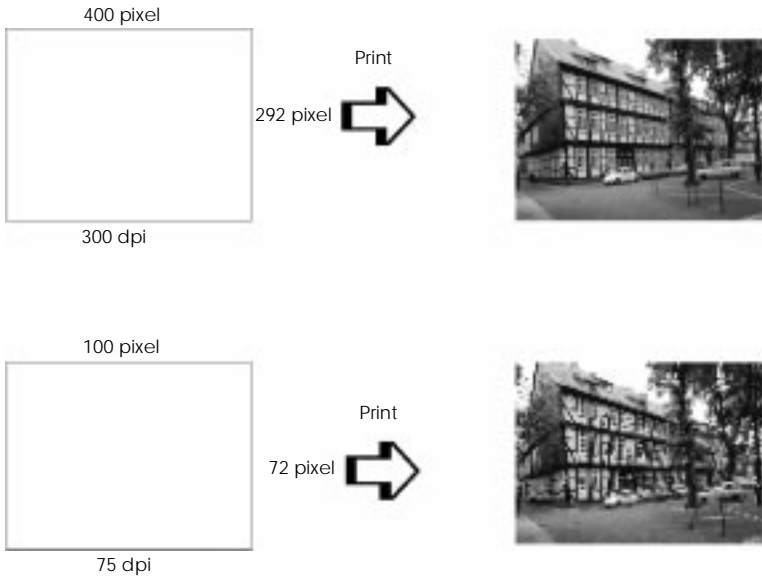

Since increasing the image size means decreasing the image resolution, you must take care that print quality or color tone is not degraded when working with images pasted into documents created with word processing software. To avoid print quality and color tone problems, change the size and the resolution of the image in your graphics application before pasting it into your document.

Basics of Color Documents

To help you use color to maximize your document's impact on its readers, determine the who, what, when, where, why, and how of color printing.

Know WHO your readers are and WHAT your purpose is

Your documents are intended to communicate information, opinions, or feelings to one or more people and also to get results. Therefore, first you need to think about who is going to see your work: customer, co-worker, or other; and what your purpose is: to advise, sell, propose, and so on.

For example:

A marketing proposal with generous quantities of bright, fluorescent colors might fail to impress a conservative accounting firm, yet win over a music video company.

Know WHEN to use color

While color can enhance any document, you need to decide when color helps expand understanding of your message and when it distracts the reader. Sometimes a serious business message is best delivered without additional colors. (Remember that white and black are colors, too.)

For example:

A job offer letter to a prospective employee works best in black and white, while a list of safety rules benefits from attention-getting color.

Decide WHERE color will most benefit your document

If you use color on every page or all over a page, you may lose not only the impact of color, but also the clarity and readability of your work. When used consistently and strategically, color breaks up the monotony of black-and-white text reading.

Note:

- Avoid placing too many color pictures, tables, or icons on a page.*
- Size your color images so that they do not overpower text or graphics.*
- Avoid using too much colored text. It is more difficult to read than black-on-white or white-on-black text.*

Know WHY you are using color

Color adds interest and clarity, and makes documents appear easier to understand. Just as you use fonts and graphics to create appeal and capture attention, color provides an additional visual interpretation of a document that influences the reader.

For example:

An overhead presentation of sales results by territory is far more interesting and memorable if you show the figures with colored charts and graphs.

Know How to select colors

- Use just one hue in the hue circle to make your document unified. Modify saturation or brightness to add interest.

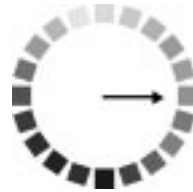

- Use contrasting hues to make your work more eye-catching.

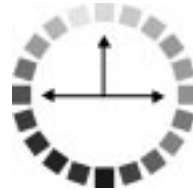

- Use of complementary colors in documents is generally not recommended.

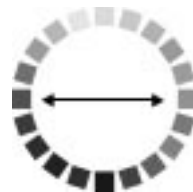

- Determine a rule for using color throughout the document.

Note:

See the Color Guide for the hue circle.

Appendix C

Specifications

Technical Specifications	C-2
Printing	C-2
Paper	C-4
Ink cartridges	C-7
Mechanical	C-8
Electrical	C-8
Environmental	C-9
Initialization	C-9
Default settings	C-10
Safety approvals	C-11
Interface Specifications	C-12
Parallel interface	C-12
Serial interface	C-13
ESC/P 2 Control Codes	C-14
Character Tables	C-15
International character sets	C-19
Characters available with ESC (^ command	C-20



Technical Specifications

Printing

Printing method: On-demand ink jet
Nozzle configuration: Monochrome (black) 64 nozzles
(32 × 2 staggered)
Color 32 nozzles × 3 (cyan, magenta, yellow)

Printable columns and printing speeds:

Character mode:

Character pitch (characters per inch)	Printing column	Draft speed	LQ printing speed
10	80	400 cps	200 cps
12	96	480 cps	240 cps
15	120	600 cps	300 cps
17 (10 condensed)	137	684 cps	342 cps
20 (12 condensed)	160	800 cps	400 cps

cps stands for characters per second.

Raster graphics mode:

Print quality	Printable area	Available dots	CR speed
180 dpi	8.26 inches	1488	20 ips
360 dpi	8.26 inches	2976	20 ips
720 dpi	8.26 inches	5952	20 ips

ips stands for inches per second.

Resolution: Maximum 1440 dpi × 720 dpi

Print direction: Bidirectional with logic seeking for text and graphics. (Auto print direction can be set in the default-setting mode.)

Control code: ESC/P 2 and expanded raster graphics code

Line spacing: 1/6 inch, 1/8 inch, or programmable in 1/360-inch increments

Paper feed speed: 66.6 milliseconds per 1/6-inch line

Input buffer: 32KB

Bitmap fonts:

Font	10 cpi	12 cpi	15 cpi	Proportional
EPSON Roman	○	○	○	○
EPSON Sans Serif	○	○	○	○
EPSON Courier	○	○	○	—
EPSON Prestige	○	○	○	—
EPSON Script	○	○	○	—

Select other font/pitch combinations using ESC/P 2 commands.
See the Command List later in this appendix.

Scalable fonts:

Font	Minimum point size	Maximum point size	Increments
EPSON Roman	8	32	2
EPSON Sans Serif	8	32	2
EPSON Roman T	8	32	2
EPSON Sans Serif H	8	32	2

Each font has four variations: normal, bold, italic, and bold italic.

Character tables: 1 italic and 10 graphics character tables

Character sets: 14 international character sets and 1 legal character set

Paper

Note:

Since the quality of any particular brand or type of paper may be changed by the manufacturer at any time, EPSON cannot attest to the quality of any non-EPSON brand or type of paper. Always test samples of paper stock before purchasing large quantities or printing large jobs.

Single sheets:

Size	A4 (210 mm × 297 mm) A5 (148 mm × 210 mm) B5 (182 mm × 257 mm) Letter (216 mm × 279 mm) Legal (216 mm × 356 mm) Half Letter (139.7 mm × 215.9 mm) Executive (184.2 mm × 266.7 mm)
Paper types	Plain bond paper, special papers distributed by EPSON
Thickness	0.08 mm to 0.11 mm (0.003 to 0.004 inch)
Weight	64 g/m ² (17 lb) to 90 g/m ² (24 lb)

Transparencies, glossy film, glossy paper:

Size	A4 (210 mm × 297 mm) Letter (216 mm × 279 mm) A6 (105 mm × 148 mm)* *Glossy film only
Paper types	Special papers distributed by EPSON

Self Adhesive sheets:

Size	A4 (210 mm × 297 mm)
Paper types	Special paper distributed by EPSON

Photo paper

Size	4 × 6" (102 mm × 152 mm)
Paper types	Special papers distributed by EPSON

Envelopes:

Size	No. 10 (240 mm × 104 mm) DL (220 mm × 110 mm) C6 (114 mm × 162 mm)
Paper types	Plain bond paper, air mail
Thickness	0.16 mm to 0.43 mm (0.006 to 0.017 inch)
Weight	45 g/m ² (12 lb) to 75 g/m ² (20 lb)

Index cards:

Size	A6 (105 mm × 148 mm) 5 × 8 inches (127 mm × 203 mm) 10 × 8 inches (254 mm × 203 mm)
Paper types	Special papers distributed by EPSON
Thickness	0.23 mm (0.0091 inch)
Weight	188 g/m ²

Note:

- Poor quality paper may reduce print quality and cause paper jams and other problems. If you encounter problems, switch to a higher grade of paper.*
- Do not load curled or folded paper.*
- Ink jet paper, envelopes, glossy film, glossy paper, and transparencies are only usable under normal conditions:*

<i>Temperature</i>	<i>15 to 25°C (59 to 77°F)</i>
<i>Humidity</i>	<i>40 to 60% RH</i>
- EPSON Photo Quality Glossy Paper and Photo Quality Self Adhesive Sheets should be stored under the following conditions:*

<i>Temperature</i>	<i>15 to 30°C (59 to 86°F)</i>
<i>Humidity</i>	<i>20 to 60% RH</i>



Printable area:

Single sheets/index cards

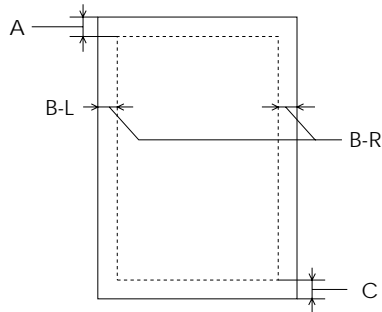

Envelopes

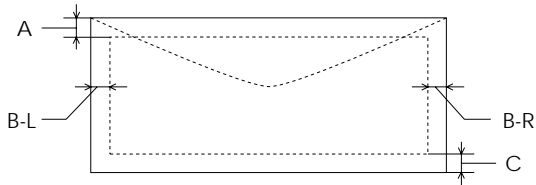

A: The minimum top margin is 3.0 mm (0.12 inch).

When loading multiple sheets of EPSON Photo Quality Film, the minimum top margin is 30 mm (1.2 inches).

B: The minimum left margin is 3.0 mm (0.12 inch).

The minimum right margin for single sheet paper is 3.0 mm (0.12 inch) except for letter and legal size paper. The minimum right margin for letter and legal size paper is 9.0 mm (0.35 inch).

The minimum right margin for envelopes is as follows:
7 mm (0.28 inch) for DL envelopes.
28 mm (1.10 inches) for No. 10 envelopes.
3 mm (0.12 inch) for C6 envelopes.

C: The minimum bottom margin is 14.0 mm (0.54 inch).

Note:

Always load paper into the sheet feeder short edge first. However, envelopes should be loaded long edge first.

Ink cartridges

Black ink cartridge (S020093):

Color	Black
Print capacity*	540 pages/A4 (ISO/IEC 10561 Letter Pattern at 360 dpi)
Cartridge life	2 years from production date if unopened; 6 months if opened at 25°C (77°F)
Temperature	Storage: -20 to 40°C (-4 to 104°F) 1 month at 40°C (104°F) Transit: -30 to 60°C (-22 to 140°F) 1 month at 40°C (104°F) 120 hours at 60°C (140°F) Freezing:** -16°C (3.2°F)
Dimensions	19.8 mm (W) × 52.7 mm (D) × 38.5 mm (H)

Color ink cartridge (S020089):

Colors	Cyan, Magenta, and Yellow
Print capacity*	300 pages (A4, 360 dpi, 5% duty each color)
Cartridge life	2 years from production date if unopened; 6 months if opened at 25°C (77°F)
Temperature	Storage: -20 to 40°C (-4 to 104°F) 1 month at 40°C (104°F) Transit: -30 to 60°C (-22 to 140°F) 1 month at 40°C (104°F) 120 hours at 60°C (140°F) Freezing:** -18°C (-0.4°F)
Dimensions	42.9 mm (W) × 52.7 mm (D) × 38.5 mm (H)

* The print capacity may vary depending on how often you use the print head cleaning function.

** It thaws and is usable after approximately 3 hours at 25°C (77°F).



Caution:

- EPSON recommends the use of genuine EPSON ink cartridges. Other products not manufactured by EPSON may cause damage to your printer not covered by EPSON's warranties.
- Do not use an ink cartridge if the date on the package has expired.

Mechanical

Paper feed method:	Friction
Paper path:	Sheet feeder, rear entry
Sheet feeder capacity:	100 sheets at 64 g/m ² (17 lb) paper
Total print volume:	75,000 pages (A4, Text)
Dimensions:	Storage Width: 429 mm (16.9 inches) Depth: 275 mm (10.8 inches) Height: 168 mm (6.6 inches) Printing (standard) Width: 429 mm (16.9 inches) Depth: 613 mm (24.1 inches) Height: 309 mm (12.2 inches) Printing (on transparencies) Width: 429 mm (16.9 inches) Depth: 695 mm (27.4 inches) Height: 196 mm (7.7 inches)
Weight:	5.2 kg (11.5 pounds) without the ink cartridges

Electrical

	120V Model	220–240V Model
Input voltage range	103.5 to 132V	198 to 264V
Rated frequency range	50 to 60 Hz	
Input frequency range	49.5 to 60.5 Hz	
Rated current	0.4A	0.2A
Power consumption	Approx. 15W (ISO/IEC 10561 Letter Pattern)	

This product is also designed for IT power system with phase to phase voltage 220-240V.

Note:

Check the label on the back of the printer for the voltage of your printer.

Environmental

Temperature:	Operation: 10 to 35°C (50 to 95°F) Storage: ^{*1} -20 to 60°C (-4 to 140°F) 1 month at 40°C (104°F) 120 hours at 60°C (140°F)
Humidity:	Operation: 20 to 80% RH Storage: ^{*1,*2} 5 to 85% RH
	^{*1} Stored in shipping container ^{*2} Without condensation

Initialization

The printer can be initialized (returned to a fixed set of conditions) in these ways:

Hardware initialization	<ul style="list-style-type: none">* The printer is turned on. _____* The printer receives an INIT signal from the parallel interface.
Software initialization	<ul style="list-style-type: none">* Software sends the ESC @ (initialize the printer) command. The last panel settings are kept.

C

Hardware initialization

When the printer is turned on, the printer mechanism is initialized and the input data buffer and print buffer are cleared. Printer settings are returned to their default values as shown in the table below. However, the printer mechanism is not initialized if the printer is turned on within ten seconds after turning it off. In this case, the printer caps the print head, and ejects any paper in the paper path.

Software initialization

Clears the print buffer and returns printer settings to the default values shown below. However, software initialization does not initialize the printer mechanism or clear the data buffer.

Default settings

The table below shows the default settings that take effect when the printer is initialized.

Item	Default setting
Top-of-form position	Current paper position
Page length	Single sheets: 22 inches
Left and right margins	Cancelled
Line spacing	1/6-inch line spacing
Character pitch	Last font selected using default-setting mode
Vertical tab position	Cleared
Horizontal tab positions	Every eight characters
Font selection	Last font selected using default-setting mode
Special printing effects	Cancelled (except condensed and economy printing)
User-defined character set	Hardware/control panel initialization: cleared Software initialization: deselected only

Safety approvals

Safety standards:

U.S. model UL 1950 with D3, CSA C22.2 No.950 with D3

European model EN60950 (VDE and NEMKO)

EMC:

U.S. model FCC part 15 subpart B class B
CSA C108.8 class B

European model EN 55022 (CISPR Pub. 22) class B
EN 61000-3-2
EN 61000-3-3
EN 50082-1
IEC801-2
IEC801-3
IEC801-4

Australian model AS/NZS 3548 class B

C

Interface Specifications

Your printer is equipped with an 8-bit parallel interface and a serial interface.

Parallel interface

The built-in parallel interface has the following characteristics:

Foward channel

Data format:	8-bit parallel, IEEE-1284 compatibility mode
Synchronization:	$\overline{\text{STROBE}}$ pulse
Handshake timing:	BUSY and $\overline{\text{ACKNLG}}$ signals
Signal level:	TTL compatible
Connector:	57-30360 Amphenol connector or equivalent

Reverse channel

Transmission mode:	IEEE-1284 Nibble mode
Adaptable connector:	57-30360 Amphenol Connector or equivalent
Synchronization:	Refer to the IEEE-1284 specification
Handshaking:	Refer to the IEEE-1284 specification
Signal level:	IEEE-1284 Level 1 device
Data transmission timing:	Refer to the IEEE-1284 specification

Serial interface

The printer's built-in serial interface is based on the RS-423 standard. This interface has the following characteristics:

Standard:	Based on RS-423
Synchronization:	Synchronous
Bit rate:	Approx. 900K bps
Handshaking:	X-ON/X-OFF DTR protocol
Word format:	
Data bit	8 bits
Parity bit	None
Start bit	1 bit
Stop bit	1 bit
Connector:	8-pin mini-circular connector
Recommended cable:	Apple System Peripheral-8 cable (Part number M0197)

ESC/P 2 Control Codes

Selecting EPSON ESC/P 2 printer in your software allows you to use the most advanced font and graphics handling available. See the *ESC/P Reference Manual* for details.

General operation:

ESC @, ESC U, ESC EM

Paper feeding:

CR, FF, LF, ESC 0, ESC 2, ESC 3, ESC +

Page format:

ESC (C, ESC C, ESC C 0, ESC Q, ESC I, ESC (c, ESC N, ESC O

Print position motion:

ESC \$, ESC \, ESC (V, ESC (v, ESC D, HT, ESC B, ESC J, VT

Font selection:

ESC k, ESC x, ESC X, ESC P, ESC M, ESC g, ESC p, ESC 4, ESC 5, ESC E, ESC F, ESC !

Font enhancement:

ESC W, DC 4, SO, DC2, SI, ESC w, ESC G, ESC H, ESC T, ESC S, ESC -, ESC (-, ESC q

Spacing:

ESC Space, ESC c, ESC (U

Character handling:

ESC t, ESC (t, ESC R, ESC %, ESC &, ESC :, ESC 6, ESC 7, ESC (^

Bit image:

ESC *

Graphics:

ESC (G, ESC ., ESC (i, ESC (e, ESC (\, ESC (s

Color:

ESC r, ESC (r

Printing mode:

ESC (K

Character Tables

These character tables are selected with the default-setting mode or by using software commands.

All tables except the italic character table are the same as the PC437 table for hex codes 00 through 7F, so only the PC437 table is shown completely. The rest of the tables show only the characters for hex codes 80 through FF.

PC437 (U.S./Standard Europe)

PC850 (Multilingual)

PC860 (Portuguese)

PC861 (Icelandic)

PC863 (Canadian-French)

PC865 (Nordic)

Abicomp

BRASCI

Roman 8

C

ISO Latin 1

Italic

International character sets

You can select one of the following international character sets with the default-setting mode or the ESC R command. For example, when you select “Italic France,” the characters in the “France” row on the table below are used in the italic character table.

The following eight international character sets can be selected with the default-setting mode or with the ESC R command.

The following seven additional sets can be selected only with the ESC R command.

C

Characters available with ESC (^ command

To print the characters in the table below, use the ESC (^ command.

Glossary

The following definitions apply specifically to printers.

application

A software program that helps you carry out a particular task, such as word processing or financial planning.

ASCII

American Standard Code for Information Interchange. A standardized coding system for assigning numerical codes to letters and symbols.

banding

The horizontal lines that sometimes appear when printing graphics. This occurs when the print head carriage return is misaligned. See also *MicroWeave*.

bidirectional printing

Printing in which the print heads print in both directions. This increases the speed of printing.

bit

A binary digit (0 or 1), which is the smallest unit of information used by a printer or computer.

brightness

The lightness or darkness of an image.

buffer

The portion of the printer's memory used to store data before printing it.

byte

A unit of information consisting of eight bits.

characters per inch (cpi)

A measure of the size of text characters, sometimes referred to as pitch.

character table

A collection of letters, numbers, and symbols that provides you with the characters used in a particular language.

CMYK

Cyan (blue-green), magenta, yellow, and black. These colored inks are used to create the subtractive system array of printed colors.

ColorSync

Macintosh software that is designed to help you get WYSIWIG (what you see is what you get) color output. This software prints colors as you see them on your screen.

cpi (characters per inch)

A measure of the size of text characters, sometimes referred to as pitch.

default

A value or setting that takes effect when the equipment is turned on, reset, or initialized.

default-setting mode

A feature that allows you to change fonts or character tables from the printer's control panel if you cannot change them in your software.

dithering

A halftoning method in which dots are arranged in an orderly pattern. Dithering works best for printing images with solid colors, such as charts and graphs. See also *Halftoning*.

dot matrix

A method of printing in which each letter or symbol is formed by a pattern (matrix) of individual dots.

dpi

Dots per inch. The dpi measures the resolution. See also *resolution*.

driver

A software program that sends instructions to a computer peripheral to tell it what to do. For example, your printer driver accepts print data from your word processing application and sends instructions to the printer on how to print this data.

economy printing

Printing in which images are printed with fewer dots to save ink.

emulation

Emulation means using the control codes of another kind of printer. Most users will never need to make this setting but some experienced users may find this helpful.

Error Diffusion

This halftoning setting smooths out edges by randomly placing dots of varying colors. This has the opposite effect of the *Finest Detail* setting.

ESC/P

Abbreviation for Epson Standard Code for Printers. This system of commands gives you control of your printer from your computer. It is standard for all EPSON printers and supported by most application programs for personal computers.

ESC/P 2

The enhanced version of the ESC/P printer command language. Commands in this language produce laser-like features, such as scalable fonts and enhanced graphics printing.

Finest Detail

This printer driver setting automatically makes your printed images sharper and clearer. This has the opposite effect of the *Error Diffusion* setting. Be aware that this may increase the time required for printing.

font

A style of type designated by a family name.

grayscale

A scale of shades of gray from black to white. Grayscale is used to represent colors when printing with black ink only.

halftones

Patterns of black or colored dots used to reproduce an image.

halftoning

A method of using dot patterns to represent an image. Halftoning makes it possible to produce varying shades of gray using only black dots, or a nearly infinite array of colors using only a few colors of dots.

high speed printing

Printing in which images are printed in both directions. This provides faster printing. This is also called bidirectional printing.

initialization

Returns the printer to its defaults (fixed set of conditions). This happens every time you turn on the printer or reset the printer.

ink jet

A method of printing in which each letter or symbol is formed by precisely spraying ink onto paper.

interface

The connection between the computer and a peripheral such as a printer. Generally, printers have two interfaces, parallel and serial. A parallel interface transmits data one byte, or eight bits, at a time. A serial interface transmits data one bit at a time.

italic

A typestyle in which the characters slant. *This sentence is italicized.*

loading position

The position to which the paper is automatically loaded.

IPS

Inches per second. This scale is used to measure the print head speed.

media

Materials upon which data is printed, such as envelopes, plain paper, special paper, and transparency film.

MicroWeave

Printing in which images are printed in finer increments to reduce the possibility of banding and to produce laser-like images. See also *banding*.

monochrome

This means printing with only one color of ink, which is generally black ink.

parallel interface

See *interface*.

power-on functions

These are special functions, such as a printer operation check, that you can perform by holding down a control panel button while turning on the printer.

printable area

The area of a page on which the printer can print. It is smaller than the physical size of the page due to margins.

printer driver

A software program that sends commands for using the features of a particular printer. Often shortened to “driver.” See also *driver*.

printer operation check

A method for checking the operation of the printer. When you perform a printer operation check, the printer prints the ROM version, code page, ink counter code, and a nozzle check pattern.

print head alignment mode

This allows you to align the print head if you can't use the print head alignment utility. See also *print head alignment*.

print head alignment

A maintenance procedure you should perform when the black and color inks on your printout are misaligned or the printout seems fuzzy.

print server

The print server acts as a post office for all print jobs sent over a network. It receives the jobs and then distributes them to the assigned printer. It also holds extra print jobs while the printer is busy. See also *print queue*.

print queue

If your printer is connected to a network, print jobs that are sent to the printer while it is busy are stored in a waiting line, or print queue, until they can be printed.

proportional printing

Printing in which the width of the character varies from character to character. For example, a capital W receives much more space than a lowercase i. The result looks more like a typeset book than a typewritten draft.

RAM

Random Access Memory. The portion of the printer's memory used as a buffer and for storing user-defined characters. All data stored in RAM is lost when the printer is turned off.

reset

To return a printer to its defaults either by sending a command, an INIT signal, or by turning the printer off and then back on.

resolution

The number of dots per inch used to represent an image.

ROM

Read Only Memory. A portion of memory that can only be read and cannot be used for data storage. ROM retains its contents when you turn off the printer.

RGB

Red, green, and blue. These colors, in phosphors irradiated by the computer monitor's electron gun, are used to create the additive array of screen colors.

sans serif

A type of font that does not have serifs, or lines crossing the ends of characters to enhance readability. The entries in the index are printed in a sans serif font, but the explanations are printed in a font with serifs.

scalable fonts

Fonts that can be enlarged or shrunk. Non-scalable fonts are called bitmap fonts and they can't change in size.

screen pattern

This feature prints shaded areas as they appear on screen, instead of printing them as halftones.

serial interface

See *interface*.

spool

The process by which the printer driver converts the print data into codes that your printer understands. This data is then sent to the printer directly or to the print server.

spool manager

A software program that converts print data into codes that your printer understands. See also *spool*.

status monitor

A software program that allows you to check the printer's status, such as the amount of ink remaining before printing.

subtractive colors

Colors produced by pigments that absorb some colors of light and reflect others. See also *CMYK*.

unidirectional printing

Printing in which the print head prints in one direction only. Unidirectional printing is useful for printing graphics because it allows more precise vertical alignment than bidirectional printing.

user-defined characters

Characters that are defined and stored in the printer by the user. Also called downloaded characters.

WYSIWIG



What-you-see-is-what-you-get. This term is used to describe printout that looks exactly like it appears on screen.

Index

A

- Adjust lever, 1-2, 6-6–7
- Advanced setting
 - Macintosh, 5-2, 5-6, 5-8
 - Windows, 4-2, 4-6, 4-8. *See also online help*
- Alignment, print head, 8-29–30, A-7.
See also Utilities
- AppleTalk*, 2-25
- Automatic setting
 - Macintosh, 5-2–3
 - Windows, 4-2, 4-5

B

- Brightness, B-2
- Brightness setting
 - Macintosh, 5-12
 - Windows. *See online help*
- Buttons, 1-3
 -  load/eject, 1-3
 -  power, 1-3
 -  print head cleaning, 1-3, 8-3, A-6

C

- Cables. *See* Interface cables
- Cartridges. *See* Ink cartridges
- Character tables, C-15–20
- Chooser*, selecting printer with, 2-24–26
- Cleaning
 - printer, 7-7
 - print head, 8-26–28, A-6
- Cleaning sheets, 6-4

- Coarse Dithering setting
 - Macintosh, 5-15
 - Windows. *See online help*
 - See also* Halftoning settings
- Coated paper, 6-3. *See also* Special paper
- Color, tips on using, B-2–8
- Color Adjustment settings
 - Macintosh, 5-11–12
 - Windows. *See online help*
- Colorimetric setting*, 5-14
- Color settings
 - Macintosh, 5-6, 5-11–14
 - Windows, 4-6. *See also online help*
- Color slide bars
 - Macintosh, 5-12
 - Windows. *See online help*
- ColorSync setting*, 5-13
- Computer requirements, 1-4–5
- Connecting the printer
 - to a Macintosh, 2-20
 - to a PC, 2-11
- Consumable products, 1-6–7
- Contrast setting
 - Macintosh, 5-12
 - Windows. *See online help*
- Control panel, 1-2, A-8
- Current Settings display
 - Macintosh, 5-6
 - Windows, 4-6
- Customer support, 8-34–39
- Customizing paper size
 - Macintosh, 5-19
 - Windows, 3-7. *See also online help*

*Macintosh only

†Windows only

Customizing print settings
 Macintosh, 5-8-17
 Windows, 4-8-9
Cyan, Magenta, Yellow setting
 Macintosh, 5-12
 Windows. *See online help*

D

Default settings, C-10
Default-setting mode, A-3-5
Despooler[†], 4-15-16. *See also online help*
Dithering, B-4. *See also* Halftoning settings
DOS programs, A-2
Driver. *See* Printer driver
Driver disk creation[†], 2-12, 2-15, 2-18

E

Economy setting
 Macintosh, 5-7, 5-16
 Windows, 4-7. *See also online help*
 See also Print Quality settings
Edge guides, 1-2, 3-3-4
Envelopes
 loading, 6-7
 printable area, C-6
 specifications, C-5
EPSON Answers[†], 2-12
 installing, 2-14, 2-16, 2-19
 system requirements for, 1-4
EPSON Despooler[†], 4-15-16
EPSON Monitor2*, 5-24
EPSON special media, 1-7. *See also*
 Special paper
EPSON Spool Manager[†], 4-15
EPSON Status Monitor
 Macintosh, 5-21
 Windows, 4-13

*Macintosh only

[†]Windows only

EPSON Stylus Printer Driver
 Package*, 2-22-24
Error diffusion, B-4
Error Diffusion setting
 Macintosh, 5-15
 Windows. *See online help*
Error indicators, 8-2-3
ESC/P 2 control codes, C-14

F

Fine-720 dpi setting
 Macintosh, 5-16
 Windows. *See online help*
 See also Print Quality settings
Fine Dithering setting
 Macintosh, 5-15
 Windows. *See online help*
 See also Halftoning settings
Finest Detail setting
 Macintosh, 5-17
 Windows. *See online help*
Flip Horizontal*, 5-15
Fonts, built-in, A-4-5

G

Glossy film, 6-3, 6-5. *See also* Special paper
Glossy paper, 6-3, 6-5. *See also*
 Special paper

H





Halftoning settings
 Macintosh, 5-15
 Windows. *See online help*
Head. *See* Print head
Head Cleaning utility. *See* Utilities
Help, online, 2-12, 4-17

High Speed setting
Macintosh, 5-17
Windows. *See online help*
Hue, B-2

I

ICM setting[†], 4-7. *See also online help*
Image resolution and size, B-5
Index cards, 1-7, 6-3, 6-5
 printable area, C-6
 specifications, C-5
 See also Special paper
Ink cartridges, 1-6
 installing, 2-6-10
 problems with, 8-30-33
 replacing, 7-2-6
 specifications, C-7
Ink jet paper, 1-7, 6-5. *See also* Special paper
Ink low, 1-3, 7-2-3, 8-3
Ink out, 1-3, 7-2-3, 8-3
Ink setting
 Macintosh, 5-5
 Windows. *See online help*
Installing
 ink cartridges, 2-6-10
 Macintosh printer software,
 2-21-22
 paper support, 2-3
 printer software for DOS, A-2
 Windows printer software,
 2-12-19
Interface
 cables, 1-6
 parallel, C-12
 specifications, C-12-13
 serial, C-13

L

Lights, 1-3
  black ink out, 1-3, 7-2-3, 8-3
  color ink out, 1-3, 7-2-3, 8-3
  paper out, 1-3, 8-3
  power, 1-3, 8-3
Loading paper. *See* Paper

M

Main menu[†], 4-3-4. *See also online help*
Maintenance, Chapter 7
Matching, color, B-2-4
 Macintosh, 5-10-14
 Windows, 4-7. *See also online help*
Media Type settings
 Macintosh, 5-4-5
 Windows, 4-10-11. *See also online help*
MicroWeave setting
 Macintosh, 5-17
 Windows. *See online help*
More Settings dialog box
 Macintosh, 5-8, 5-10, 5-15
 Windows, 4-8. *See also online help*
N
Network printing[†], 2-16-17
No Halftoning setting
 Macintosh, 5-15
 Windows. *See online help*
 See also Halftoning settings
Normal-360 dpi setting
 Macintosh, 5-16
 Windows. *See online help*
 See also Print Quality settings

*Macintosh only

†Windows only

Nozzle Check utility
Windows, 4-14
Macintosh, 5-22

O

Online help[†], 2-12, 4-17
Options, 1-6
Orientation setting
Macintosh, 5-18
Windows. *See online help*
Output tray, 1-2, 3-2

P

Page Setup dialog box*, 3-8-9, 5-18

Paper

jam, 1-3, 8-3
out, 1-3, 8-3
specifications, C-4-6
support, 2-3
See also Special paper

Paper, matching with Media Type
setting

Macintosh, 5-4-5
Windows, 4-10-11

Paper loading, 3-2-4

See also Special Paper

Paper menu[†], 3-6-7, 4-3-4. *See also
online help*

Paper Size settings

Macintosh, 5-18-20
Windows, 3-7. *See also online
help*

Perceptual setting*, 5-14

Photo quality paper, 1-7, 6-5. *See also*

Special paper

Photo setting

Macintosh, 5-6
Windows, 4-7. *See also online
help*

Power Macintosh Extension
Module*, 2-22, 2-24

Power-on functions, A-8

Predefined settings

Macintosh, 5-6-7
Windows, 4-6-7. *See also online
help*

Print

quality, 8-16-23, 8-26-30
speed, 8-24-25

Printable Area setting

Macintosh, 5-19
Windows. *See online help*

Printable area specifications, C-6

Print dialog box*, 3-9, 5-3

Printer

cleaning, 7-7
operation check, 8-4-6
parts, 1-2
stand, 2-4
transporting, 7-8
unpacking, 2-2

Printer driver

DOS, A-2
Macintosh, 2-25, 5-2-20. *See also*

Printer software for
Macintosh

Windows, 2-12, 4-2-11. *See also
online help and* Printer
software for Windows

Printer software for Macintosh

accessing, 3-8, 5-3
Advanced setting, 5-2, 5-6, 5-8
Automatic setting, 5-2-5
customized settings, 5-2, 5-8-10
installing, 2-21-22
predefined settings, 5-2, 5-6-7

*Macintosh only

†Windows only

Printer software for Windows
 accessing, 3-5, 4-2-4
 Advanced setting, 4-2, 4-6, 4-8.
See also online help
 Automatic setting, 4-2, 4-5
 customized settings, 4-2, 4-8-9
 installing, 2-12-19
 predefined settings, 4-2, 4-6-7
See also online help

Printer utilities. *See* Utilities

Print head
 alignment, 8-29-30, A-7
 cleaning, 8-26-28, A-6

Printing, basics
 Macintosh, 3-8-9
 Windows, 3-5-7

Printing problems. *See*
 Troubleshooting

Print Quality settings
 Macintosh, 5-15-16
 Windows. *See online help*

Print settings
 DOS, A-2-5
 Macintosh, 5-2-20. *See also*
 Printer software for
 Macintosh
 Windows, 4-2-11. *See also online*
help and Printer software for
 Windows

Profile setting*, 5-13

Q

Quality vs. Speed slide bar
 Macintosh, 5-3
 Windows, 4-5. *See also online*
help

R

Reduce or Enlarge setting*, 5-18
 Rendering Intent setting*, 5-14
 Replacing an ink cartridge. *See* Ink
 cartridges

Resolution
 image, B-5-6
 printing, C-3
See also Print Quality settings

S

Safety
 approvals, C-11
 instructions, 1-5

Saturation, B-2

Saturation setting
 Macintosh, 5-12, 5-14
 Windows. *See online help*

Scalable fonts, A-5, C-3

Self adhesive sheets, 1-7, 6-5

Special media, 1-7. *See also* **Special
 paper**

Special paper, 1-7, 6-2-3
 cleaning sheets, 6-4
 loading, 6-4-8

Specifications, C-2-11
 default settings, C-10
 electrical, C-8
 environmental, C-9
 ink cartridges, C-7
 initialization, C-9
 interface, C-12-13
 mechanical, C-8
 paper, C-4-6
 printable area, C-6
 printing, C-2-3
 safety approvals, C-11

*Macintosh only

†Windows only

Spool Manager[†], 4-15
Status Monitor
 Macintosh, 5-21–22
 Windows, 4-13
SuperFine-1440 dpi setting
 Macintosh, 5-16
 Windows. *See online help*
 See also **Print Quality settings**
System requirements, 1-4–5

T

Text/Graph setting
 Macintosh, 5-7
 Windows, 4-7. *See also online help*
Transporting the printer, 7-8
Transparencies, 1-7, 6-3, 6-5, 6-8
Troubleshooting, Chapter 8
 ink cartridges, 8-30–33
 operation, 8-8–13
 paper handling, 8-14–16
 power supply, 8-7–8
 printing quality, 8-16–23
 printer utilities, 10-23–24

U

Unpacking the printer, 2-2
User Defined Paper Size dialog box[†].
 See online help
Utilities
 Driver disk creation[†], 2-12,
 2-15, 2-18
 Macintosh, 5-20–23
 Windows, 4-12–14
Utility menu[†], 4-3–4, 4-12. *See also online help*

V

Video/Digital Camera setting
 Macintosh, 5-7, 5-12
 Windows, 4-7. *See also online help*

*Macintosh only

†Windows only

EPSON OVERSEAS MARKETING LOCATIONS

EPSON AMERICA, INC.

20770 Madrona Ave.
P.O. Box 2842
Torrance, CA 90509-2842
Phone: (800) 922-8911
Fax: (310) 782-5220

EPSON UK LTD.

Campus 100, Maylands Avenue,
Hemel Hempstead, Herts,
HP2 7TJ, U.K.
Phone: (+44) 01442 61144
Fax: (+44) 01442 227227

EPSON DEUTSCHLAND GmbH

Zülpicher Straße 6,
40549 Düsseldorf Germany
Phone: (0211) 56030
Telex: 8584786

EPSON FRANCE S.A.

68 bis, rue Marjolin
92300, Levallois-Perret, France
Phone: 33.1.40.87.37.37
Telex: 610657

EPSON AUSTRALIA PTY. LTD.

70 GIBBES STREET, CHATSWOOD 2067 NSW.
Phone: 2-9903-9000
Fax: 2-9903-9177

EPSON SINGAPORE PTE. LTD.

No. 1 Temasek Avenue #36-00
Millenia Tower, Singapore 039192
Phone: (065) 33 77 911
Fax: (065) 33 41 185

EPSON HONG KONG LTD.

Rooms 4706-10, 47/F,
China Resources Bldg.,
26 Harbour Road, Wanchai, Hong Kong
Phone: 2585-4300
Fax: 2827-7083

EPSON TAIWAN TECHNOLOGY & TRADING LTD.

10F, No. 287 Nanking E. Road, Sec. 3,
Taipei, Taiwan, R.O.C.
Phone: (02) 717-7360
Fax: (02) 712-9164

EPSON ITALIA S.p.A.

V.le F.lli Casiraghi 427
20099 Sesto S.Giovanni
MI, Italy
Phone: 2-262331
Fax: 2-2440750

EPSON IBERICA S.A.

Av. de Roma, 18-26
08290 Cerdanyola del Valles
Barcelona, Spain
Phone: 582. 15.00
Fax: 582. 15.55

**SEIKO EPSON CORPORATION
(Hirooka Office)**

80 Harashinden, Hirooka
Shiojiri-shi, Nagano-ken
399-07 Japan

EPSON PORTUGAL, S.A.

R. do Progresso, 471, 1º Perafita
4460 Matosinhos, Portugal
Phone: (02) 996 14 02
Fax: (02) 996 14 11

EPSON

Ink Jet Printer

EPSON Stylus™ COLOR 600

User's Guide

