

Color Ink Jet Printer

EPSON STYLUS™

PHOTO EX

297x420mm

PHOTO EX 4400dpi

User's Guide

4008578
S01-00

NOTICE

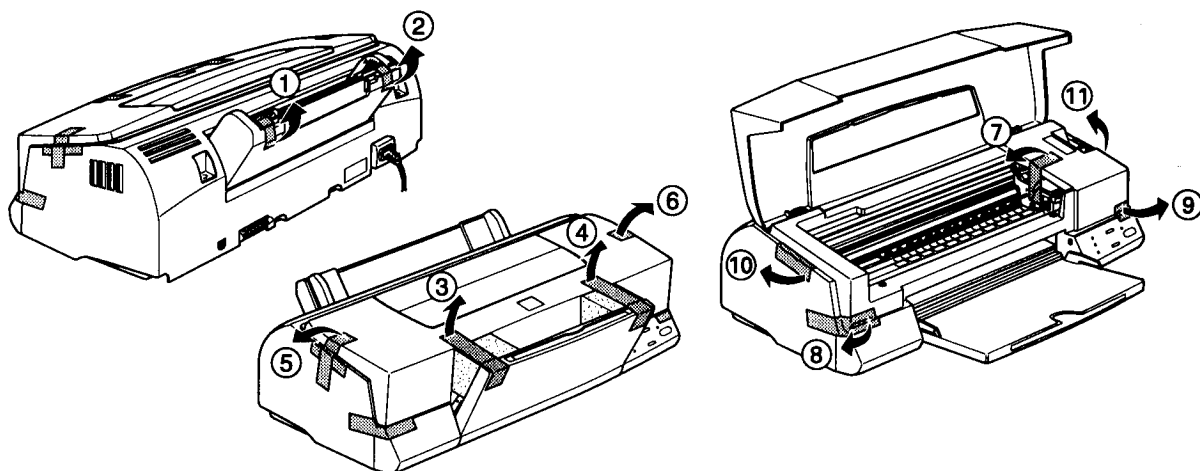

NOTE:

To prevent damage during shipping, several pieces of blue protective material are packed with your printer. You must remove these before you assemble your printer.

HINWEIS:

Zur Vermeidung von Transportschäden ist der Drucker durch schützende Verpackungsteile (blaufarbig) gesichert. Diese Teile müssen vor dem Zusammenbau des Druckers entfernt werden.

ATTENTION:

Afin d'éviter tout dommage durant le transport, des matériaux de protection bleus ont été emballés avec votre imprimante. Vous devez les retirer avant d'installer votre imprimante.

NOTA:

Para evitar daños durante el transporte, su impresora viene protegida por varias piezas azules de material protector. Debe retirar estas piezas antes de montar su impresora.

NOTA:

L'imballaggio della vostra stampante contiene molti elementi protettivi di colore blu, per prevenire danni durante il trasporto. Non dimenticate di toglierli prima di iniziare a utilizzare la stampante.

NOTA:

Para evitar danos durante o transporte, esta impressora possui materiais de protecção de cor azul. Retire-os antes de instalar a impressora.

Where to Find Information

This User's Guide

Provides you with all the information you need to use your EPSON STYLUS PHOTO EX, and their consumable products, from setting up to troubleshooting.

Online Help

Provides you with detailed information and instructions on the printer software that controls your printer (online help will be automatically installed when you install the printer software).

Color Guide

Explains how color printing works and shows you how to get impressive results from your printer.

EPSON STYLUS™ PHOTO EX

Color Ink Jet Printer

All rights reserved. No part of this publication may be reproduced, stored in a retrieval system, or transmitted in any form or by any means, electronic, mechanical, photocopying, recording, or otherwise, without the prior written permission of SEIKO EPSON CORPORATION. The information contained herein is designed only for use with this EPSON printer. EPSON is not responsible for any use of this information as applied to other printers.

Neither SEIKO EPSON CORPORATION nor its affiliates shall be liable to the purchaser of this product or third parties for damages, losses, costs, or expenses incurred by the purchaser or third parties as a result of: accident, misuse, or abuse of this product or unauthorized modifications, repairs, or alterations to this product, or (excluding the U.S.) failure to strictly comply with SEIKO EPSON CORPORATION's operating and maintenance instructions.

SEIKO EPSON CORPORATION shall not be liable for any damages or problems arising from the use of any options or any consumable products other than those designated as Original EPSON Products or EPSON Approved Products by SEIKO EPSON CORPORATION.

EPSON and EPSON ESC/P are registered trademarks and EPSON ESC/P Raster and EPSON Stylus are trademarks of SEIKO EPSON CORPORATION.

Microsoft and Windows are registered trademarks of Microsoft Corporation.

General Notice: *Other product names used herein are for identification purposes only and may be trademarks of their respective owners. EPSON disclaims any and all rights in those marks.*

Copyright © 1998 by SEIKO EPSON CORPORATION, Nagano, Japan.



Printed on Recycled Paper.

User's Guide

Declaration of Conformity

According to ISO/IEC Guide 22 and EN 45014

Manufacturer: SEIKO EPSON CORPORATION
Address: 3-5, Owa 3-chome, Suwa-shi,
Nagano-ken 392 Japan

Representative: EPSON EUROPE B.V.
Address: Prof. J. H. Bavincklaan 5 1183
AT Amstelveen
The Netherlands

Declares that the Product:

Product Name: Ink Jet Printer
Model: P953A

Conforms to the following Directive(s) and Norm(s):

Directive 89/336/EEC:

EN 55022 Class B
EN 61000-3-2
EN 61000-3-3
EN 50082-1
IEC 801-2
IEC 801-3
IEC 801-4

Directive 73/23/EEC:

EN 60950

February 1998

Y. Ishii
President of EPSON EUROPE B.V.

Contents

Safety Instructions

Important Safety Instructions	1
A few precautions	2
ENERGY STAR Compliance	4
For United Kingdom Users	4
Warnings, Cautions, and Notes	5

Chapter 1 Getting to Know Your Printer

Printer Parts and Control Panel Functions	1-2
System Requirements	1-4
When using your printer with a PC	1-4
When using your printer with a Macintosh	1-5
Options and Consumable Products	1-6
Options	1-6
Consumable products	1-7

Chapter 2 Getting Started

Unpacking the Printer	2-2
Choosing a Place for the Printer	2-3
Using a printer stand	2-4
Attaching the Paper Support	2-4
Plugging in the Printer	2-5
Installing the Ink Cartridges	2-5
Connecting the Printer to Your PC	2-11
Installing the Printer Software in Your PC	2-12
Installing in Windows 95 or Windows NT 4.0	2-13
Installing in Windows 95 (using plug-and-play)	2-15
Installing in Windows 3.1	2-18

Using Your Printer on a Network	2-20
With Windows 95	2-20
With Windows NT 4.0	2-22
Connecting the Printer to Your Macintosh	2-25
Installing the Printer Software in Your Macintosh	2-26
Installing the printer software	2-26
Using the Chooser to select your printer	2-29

Chapter 3 Starting to Print

Loading Paper	3-2
Printing With Windows	3-5
Printing With a Macintosh	3-8

Chapter 4 Using the Printer Software for Windows

The Printer Software	4-2
Accessing the Printer Software	4-2
From Windows applications	4-3
From Windows 95 or Windows NT 4.0	4-3
From Windows 3.1	4-4
Making Changes to Printer Driver Settings	4-5
Using the Automatic Setting	4-5
Using the Predefined Settings	4-6
Customizing the Print Settings	4-8
Making the Media Type Setting	4-10
Modifying the Printout Style (Windows 95 & NT 4.0)	4-12
Using EPSON Printer Utilities	4-15
EPSON Status Monitor 2 (for Windows 95)	4-16
Nozzle Check	4-16
Head Cleaning	4-16
Print Head Alignment	4-17
Printer and Option Information	4-17
Speed & Progress (for Windows 95)	4-19

Checking Printer Status (for Windows 95 and 3.1)	4-21
Understanding the EPSON Spool Manager	4-23
Using EPSON Status Monitor 2 (for Windows 95)	4-24
Getting Information Through Online Help	4-30
Accessing help from your application	4-30
Accessing help from Windows 95 or NT 4.0	4-30
Accessing help from Windows 3.1	4-30

Chapter 5 Using the Printer Software for Macintosh

The Printer Software	5-2
Making Changes to Printer Driver Settings	5-2
Using the Automatic Setting	5-3
Using the Predefined Settings	5-6
Customizing the Print Settings	5-9
Saving your settings	5-16
Using your saved settings	5-17
Changing the Paper Size	5-17
Defining a Custom Paper Size	5-19
Modifying the Printout Method and Style	5-20
Using EPSON Printer Utilities	5-22
EPSON StatusMonitor	5-23
Configuration	5-24
Nozzle Check	5-24
Head Cleaning	5-24
Print Head Alignment	5-25
Controlling Background Printing	5-25

Chapter 6 Printing on Special Paper

Choosing Special Paper and Other Media	6-2
About special media cleaning sheets	6-4
Loading Special Paper and Other Media	6-4
Loading Envelopes	6-7
Loading Transparencies	6-8

Chapter 7 Maintenance and Transportation

Replacing an Ink Cartridge	7-2
Cleaning the Printer	7-8
Transporting the Printer	7-9

Chapter 8 Troubleshooting

Diagnosing the Problem	8-2
Error indicators	8-2
Status Monitor	8-4
Printer operation check	8-4
Problems and Solutions	8-7
Power supply	8-7
Operation	8-8
Paper handling	8-14
Printing quality	8-17
Printer utilities	8-24
Increasing the Print Speed	8-25
Using DMA transfer (for Windows 95)	8-26
Uninstalling Printer Software (Windows 95)	8-29
Cleaning the Print Head	8-30
Using the Head Cleaning utility	8-30
Using the control panel	8-33
Aligning the Print Head	8-34
Ink Cartridge Problems	8-34
Contacting Customer Support	8-39
For United Kingdom and the Republic of Ireland users	8-39
For Australian users	8-41
For Singapore users	8-43
For Hong Kong users	8-43
For Philippines users	8-44

Appendix A Tips for Color Printing

Basics of Color	A-2
Image Resolution and Image Size	A-5
Basics of Color Documents	A-7

Appendix B Specifications

Technical Specifications	B-2
Printing	B-2
Paper	B-2
Ink cartridges	B-6
Mechanical	B-7
Electrical	B-8
Environmental	B-8
Initialization	B-9
Safety approvals	B-10
Interface Specifications	B-11
Parallel interface	B-11
Serial interface	B-12

Glossary

Index

Safety Instructions

Important Safety Instructions

Read all of these instructions and save them for later reference. Follow all warnings and instructions marked on the printer.

- Do not place the printer on an unstable surface or near a radiator or heat source.
- Place the printer on a flat surface. The printer will not operate properly if it is tilted or at an angle.
- Do not block or cover the openings in the printer's cabinet. Do not insert objects through the slots.
- Use only the type of power source indicated on the printer's label.
- Connect all equipment to properly grounded power outlets. Avoid using outlets on the same circuit as photocopiers or air control systems that regularly switch on and off.
- Do not use a damaged or frayed power cord.
- If you use an extension cord with the printer, make sure the total ampere rating of the devices plugged into the extension cord does not exceed the cord's ampere rating. Also, make sure the total ampere rating of all devices plugged into the wall outlet does not exceed the wall outlet's ampere rating.
- Unplug the printer before cleaning. Clean with a damp cloth only. Do not spill liquid on the printer.
- Except as specifically explained in this guide, do not attempt to service the printer yourself.

- ❑ Unplug the printer and refer servicing to qualified service personnel under the following conditions:

If the power cord or plug is damaged; if liquid has entered the printer; if the printer has been dropped or the cabinet damaged; if the printer does not operate normally or exhibits a distinct change in performance. Adjust only those controls that are covered by the operating instructions.

- ❑ If you plan to use the printer in Germany, observe the following:

To provide adequate short-circuit protection and over-current protection for this printer, the building installation must be protected by a 16 Amp circuit breaker.

Bei Anschluß des Druckers an die Stromversorgung muß sichergestellt werden, daß die Gebäudeinstallation mit einem 16 A-Überstromschalter abgesichert ist.

A few precautions

Even if you are familiar with other types of printers, be sure to read through the following list of precautions before operating your ink jet printer.

- ❑ Do not put your hand inside the printer or touch the ink cartridges during printing.
- ❑ Do not move the print head by hand; otherwise you may damage the printer.
- ❑ Under normal circumstances, ink will not come out of the cartridges. If it does get on your skin, wash it off with soap and water. If it gets in your eyes, flush them immediately with water.
- ❑ Keep ink cartridges out of the reach of children.

- ❑ Do not dismantle the ink cartridges or try to refill them. This could damage the print head.
- ❑ Once you install an ink cartridge, do not open the clamp or remove the cartridge except to replace it with a new one. The cartridge may become unusable otherwise.
- ❑ Install the ink cartridge immediately after you remove it from its package. Leaving the cartridge unpacked for a long time before use may reduce print quality.
- ❑ Do not use an ink cartridge beyond the date printed on the cartridge carton. For best results, use up the ink cartridges within six months of installing them.
- ❑ Do not shake an ink cartridge; this can cause leakage.
- ❑ Always turn the printer off using the ⏻ power button. When this button is pressed, the ⏻ power light flashes briefly. Do not unplug the printer or turn off the power to the outlet until the ⏻ power light is off.
- ❑ Before transporting the printer, make sure the print head is capped in the far right position and the ink cartridges are in place.



ENERGY STAR Compliance

As an ENERGY STAR Partner, EPSON has determined that this product meets the ENERGY STAR guidelines for energy efficiency.

The International ENERGY STAR Office Equipment Program is a voluntary partnership with the computer and office equipment industry to promote the introduction of energy-efficient personal computers, monitors, printers, fax machines, and copiers in an effort to reduce air pollution caused by power generation.

For United Kingdom Users

Use of options

EPSON (UK) Limited shall not be liable against any damages or problems arising from the use of any options or consumable products other than those designated as Original EPSON Products or EPSON Approved Products by EPSON (UK) Limited.

Safety information



Warning: This appliance must be earthed. Refer to rating plate for voltage and check that the appliance voltage corresponds to the supply voltage.

Important: The wires in the mains lead fitted to this appliance are coloured in accordance with the following code:

Green and yellow — Earth
Blue — Neutral
Brown — Live

If you have to fit a plug:

As the colours of the mains lead of this appliance may not match coloured markings used to identify the terminals in a plug, please proceed as follows:

The green and yellow wire must be connected to the terminal in the plug which is marked with the letter E or the Earth symbol (\perp).

The blue wire must be connected to the terminal in the plug marked with the letter N.

The brown wire must be connected to the terminal in the plug marked with the letter L.

If damage occurs to the plug, replace the cord set or consult a qualified electrician.

Replace fuses only with a fuse of the correct size and rating.

Warnings, Cautions, and Notes



***Warnings** must be followed carefully to avoid bodily injury.*



***Cautions** must be observed to avoid damage to your equipment.*

***Notes** contain important information and useful tips on the operation of your printer.*





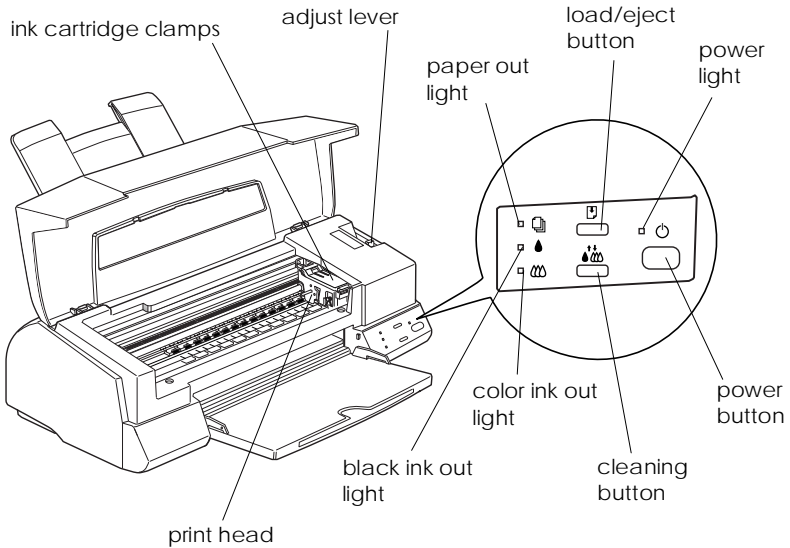
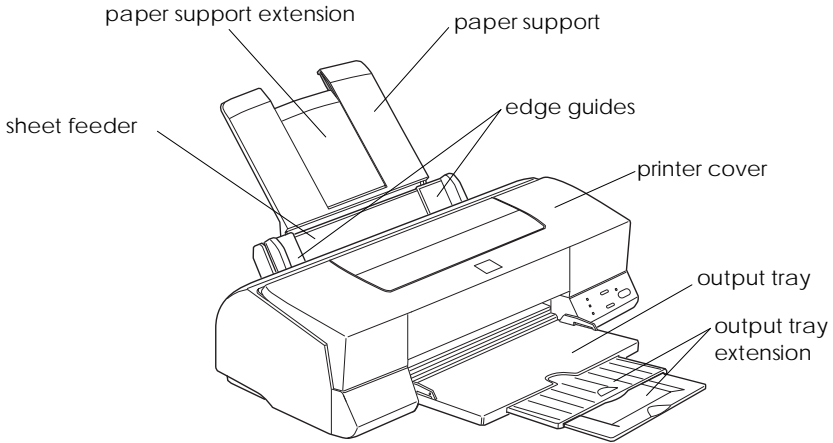

Getting to Know Your Printer

Printer Parts and Control Panel Functions	1-2
System Requirements	1-4
When using your printer with a PC	1-4
When using your printer with a Macintosh	1-5
Options and Consumable Products	1-6
Options	1-6
Consumable products	1-7

Printer Parts and Control Panel Functions









Buttons

Button	Function
 power	Turns the printer on and off.
 load/eject	Loads or ejects paper if pressed and released within two seconds. Resumes printing if pressed after a paper out error.
 cleaning	Moves the print head to the replacement position if pressed for about three seconds while the  or  ink out light is flashing or on. Returns the print head to its home position after ink cartridge replacement. Performs print head cleaning if pressed for about three seconds when both the  and  ink out lights are off.

Lights

The lights on the front of the printer indicate the printer status, such as receiving data, paper jam, or low on ink. The following table describes what the lights mean.

				Printer Status
○	-	-	-	Printer is on.
◊	-	-	-	Receiving data, replacing an ink cartridge, charging ink, or cleaning the print head.
-	○	-	-	Paper out. Load paper in the sheet feeder; then press the  load/eject button to resume printing.
-	◊	●	●	Paper jam. Take all the paper out of the sheet feeder, reload the paper, then press the  load/eject button. If the light continues to flash, turn off the printer and gently pull out any paper that may be jammed in the printer.
-	-	◊	-	Ink low. The black ink cartridge is nearly empty. Obtain a black ink cartridge (S020093).
-	-	○	-	Ink out. The black ink cartridge is empty. Replace the black ink cartridge (S020093).
-	-	-	◊	Ink low. The color ink cartridge is nearly empty. Obtain a color ink cartridge (S020110).
-	-	-	○	Ink out. The color ink cartridge is empty. Replace the color ink cartridge (S020110).

○ = on, ● = off, ◊ = flashing, - = irrelevant

System Requirements

When using your printer with a PC

To use your printer with a PC, you need Microsoft Windows 3.1, Windows for Workgroups, Windows 95, or Windows NT 4.0; and a shielded, twisted-pair parallel cable.

To install and use the printer software (printer driver and utilities) included on the CD-ROM or floppy disk packed with your printer, your system should meet the following requirements:

Minimum system	Recommended system
80386/25 MHz processor for Windows 3.1 80486/25MHz processor for Windows 95 and NT 4.0	Pentium or higher processor * For Windows NT, Intel or Intel x86 compatible processors only
16MB RAM	32MB RAM or more
20MB hard disk space	50MB or more free hard disk space
VGA monitor	VGA or better monitor

Your computer dealer can help you update your system if it does not meet these requirements.

When using your printer with a Macintosh

The following are the hardware and system requirements that must be met to use this printer with a Macintosh.

Applicable computer models (as of July 1, 1997)

Macintosh LC II, LC III, LC475, LC520, LC575, LC630
 Macintosh IIcx, IIci, IIsi, IIvi, IIvx
 Macintosh Quadra Series
 Macintosh Centris Series
 Macintosh PowerBook™ Series (excluding PowerBook 100)
 Macintosh PowerBook Duo Series
 Macintosh Performa Series
 Power Macintosh Series

Interface cables

To use your printer with a Macintosh, you need a standard Apple System Peripheral-8 cable (8-pin mini-DIN) or equivalent.

Environment

Minimum system	Recommended system
System 7.1	System 7.5 or later
5MB of available memory 10MB of available memory when BG is on	8MB or more of available memory 16MB or more of available memory when BG is on

Note:

- ❑ *The amount of available memory varies according to the number and kind of applications that are open. To see how much memory is available, choose About This Macintosh from the Apple menu and refer to the memory size (listed in kilobytes) under “Largest Unused Block” (1,024K=1MB).*
- ❑ *The memory requirements above are for printing on letter size paper. These requirements may vary depending on the size of the paper, the type of application you are using, and the complexity of the document you want to print.*

In addition to these system and memory requirements, you also need 8MB of free hard disk space to install your printer software. To print, you need extra hard disk space amounting to about double the size of the file you want to print.

Options and Consumable Products

Options

The following options are available for use with your printer.

Interface cables

EPSON supplies several types of interface cable. You can use any interface cable that meets the specifications listed below. See your computer manual for any additional requirements.

Parallel Interface Cable (shielded) C83602* from D-SUB 25-pin (computer) to 36-pin Amphenol 57 series (printer)

Note:

The asterisk () is a substitute for the last digit of the product number, which varies by country.*

Consumable products

Ink cartridges

Black ink cartridge	S020093
Color ink cartridge	S020110

EPSON special media

Most plain paper works well in your printer. In addition, you can use paper specifically designed for ink jet printers. The quality of the printout depends on the type of paper used. See the table below for the names and product numbers of the different types of EPSON special media available.

EPSON 360 dpi Ink Jet Paper (A4)	S041059
	S041025
EPSON360 dpi Ink Jet Paper (Letter)	S041060
	S041028
EPSON 360 dpi Ink Jet Paper (A3)	S041065
	S041046
EPSON Photo Quality Ink Jet Paper (A4)	S041061
	S041026
EPSON Photo Quality Ink Jet Paper (Letter)	S041062
	S041029
EPSON Photo Quality Ink Jet Paper (Legal)	S041067
	S041048
EPSON Photo Quality Ink Jet Paper (A3)	S041068
	S041045
EPSON Photo Quality Glossy Paper (A4)	S041126
EPSON Photo Quality Glossy Paper (Letter)	S041124
EPSON Photo Quality Glossy Paper (A3)	S041125
EPSON Photo Quality Glossy Film (A4)	S041071
EPSON Photo Quality Glossy Film (Letter)	S041072
EPSON Photo Quality Glossy Film (A3)	S041073
EPSON Photo Quality Glossy Film (A6)	S041107

EPSON Photo Quality Ink Jet Card (A6)	S041054
EPSON Photo Quality Ink Jet Card (5 × 8 in.)	S041121
EPSON Photo Quality Ink Jet Card (8 × 10 in.)	S041122
EPSON Ink Jet Transparencies (A4)	S041063
EPSON Ink Jet Transparencies (Letter)	S041064
EPSON Photo Quality Self Adhesive Sheet (A4)	S041106
EPSON Photo Paper (4 × 6 in.)	S041134
EPSON Photo Paper (A4)	S041140
EPSON Photo Paper (Letter)	S041141
EPSON Photo Paper (A3)	S041142
EPSON Photo Stickers (A6)	S041144
EPSON Panoramic Photo Paper (210 × 594 mm)	S041145
EPSON Iron-On Cool Peel Transfer Paper (A4)	S041154
EPSON Iron-On Cool Peel Transfer Paper(Letter)	S041153
	S041155

Note:

- ❑ *The availability of special media varies by country.*
- ❑ *Ink jet printers are particularly sensitive to the condition of the paper. Keep unused paper in its original packaging and store it in a cool, dark place.*

Before using these media, see page 4-10 or 5-4 for details of the media type settings, and page 6-4 for the loading capacity of different types of special media. Also read the instruction sheets packed with your special media.

Chapter 2

Getting Started

Unpacking the Printer	2-2
Choosing a Place for the Printer	2-3
Using a printer stand	2-4
Attaching the Paper Support	2-4
Plugging in the Printer	2-5
Installing the Ink Cartridges	2-5
Connecting the Printer to Your PC	2-11
Installing the Printer Software in Your PC	2-12
Installing in Windows 95 or Windows NT 4.0	2-13
Installing in Windows 95 (using plug-and-play)	2-15
Installing in Windows 3.1	2-18
Using Your Printer on a Network	2-20
With Windows 95	2-20
With Windows NT 4.0	2-22
Connecting the Printer to Your Macintosh	2-25
Installing the Printer Software in Your Macintosh	2-26
Installing the printer software	2-26
Using the Chooser to select your printer	2-29

Unpacking the Printer

Your printer box should contain a CD-ROM, which includes the printer driver software that runs your printer, and the following items:

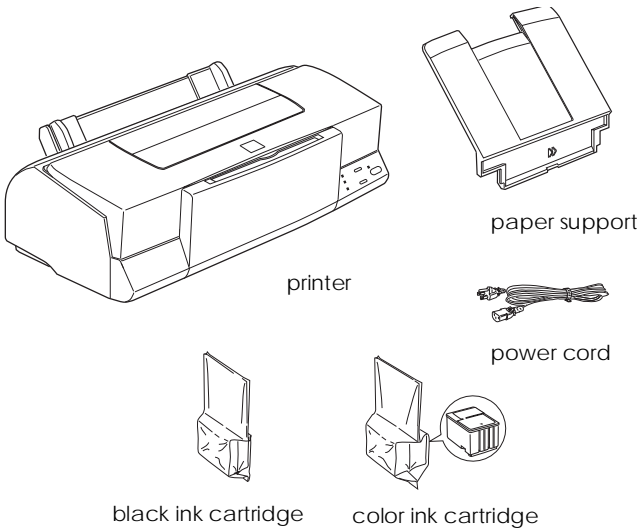

In some locations, the power cord comes attached to the printer. The shape of the AC plug varies by country; be sure the plug included is the right shape for your location.

Remove all protective materials packed with your printer before you set it up and turn on the power. Follow the instructions inserted with the printer to remove these materials. Save all packaging and protective materials in case you need to transport the printer later.

Choosing a Place for the Printer

Follow the guidelines listed below when placing your printer.

- Place the printer on a flat, stable surface. The printer will not operate properly if it is tilted or at an angle.
- Place the printer close enough to the computer for the interface cable to reach it easily.
- Leave adequate room for easy operation and maintenance.
- Leave enough room on the table at the front of the printer to lower the output tray.
- Avoid using or storing the printer in places subject to rapid changes in temperature and humidity. Also keep it away from direct sunlight, strong light, or heat sources.
- Avoid places subject to shocks and vibrations.
- Place the printer near a wall outlet where the plug can be easily unplugged.

Note for French-speaking users:

Placez l'imprimante près d'une prise de contact où la fiche peut être débranchée facilement.

- Avoid electrical outlets controlled by wall switches or automatic timers. If you must use electrical outlets controlled by wall switches, do not use the wall switches to control them. Also, avoid outlets on the same circuit as large motors or other appliances that can cause fluctuations in line voltage.
- Keep the entire computer system away from potential sources of electromagnetic interference, such as loudspeakers or the base units of cordless telephones.
- Use a grounded power outlet; do not use an adapter plug.

Using a printer stand

When using a printer stand, note the following:

- ❑ Use a stand that can support at least 31.0 kg (68.3 lb).
- ❑ Never use a stand that tilts the printer. The printer should always be kept level.

Attaching the Paper Support

Insert the paper support into the slot at the rear of the printer as shown below.

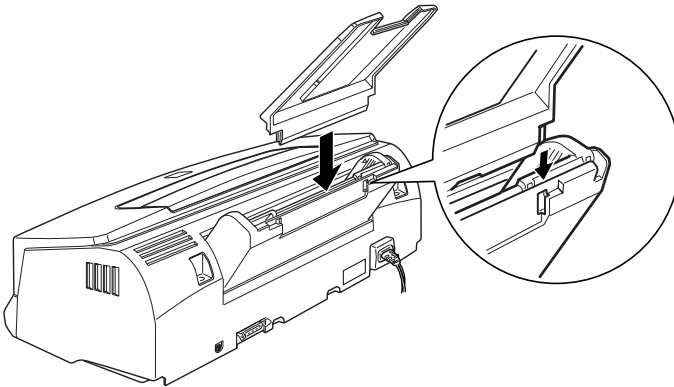

Plugging in the Printer

1. Check the label on the back of the printer to make sure the voltage required by the printer matches that of the electrical outlet into which you will be plugging it. Also, make sure that you have the correct power cable for your power source.

**Caution:**

It is not possible to change the printer's voltage. If the rated voltage and your outlet voltage do not match, contact your dealer for assistance. Do not plug in the power cord.

2. If the power cord is not attached to the printer, connect it to the AC inlet on the back of the printer.
3. Plug the power cord into a properly grounded electrical outlet.

Installing the Ink Cartridges

**Warning:**

The ink cartridges are self-contained units. Under ordinary conditions of use, ink will not leak from a cartridge. If ink does get on your hands, wash them thoroughly with soap and water. If ink gets into your eyes, flush them immediately with water.

Install the ink cartridges as follows:

Note:

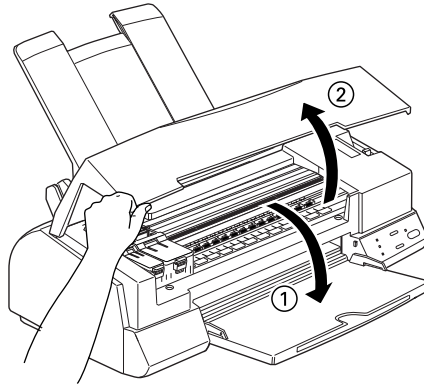

- Do not open the ink cartridge packages until just before you install them, or the ink may dry up.*
- Always use new ink cartridges. Reinstalling partially empty ink cartridges causes the printer to send inaccurate information to the Status Monitor regarding the amount of ink remaining.*

1. Lower the output tray at the front of the printer; then, holding the center edge of the cover, open the printer cover.

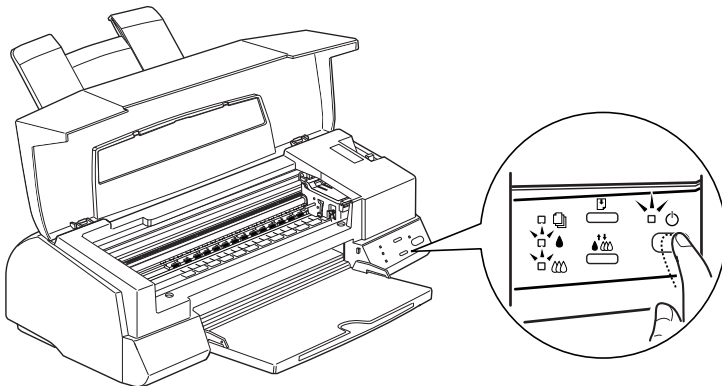

2. Turn on the printer by pressing the  power button.



The print head moves to the ink cartridge installment position on the left-hand side. The  power light flashes and the  and  ink out lights come on.

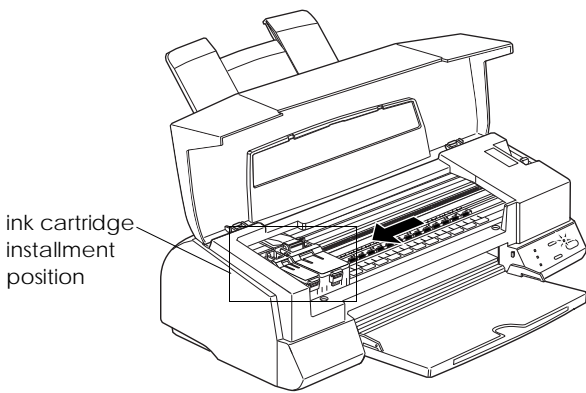

Caution:

Do not move the print head by hand; otherwise you may damage the printer.

3. Lift up the two ink cartridge clamps.

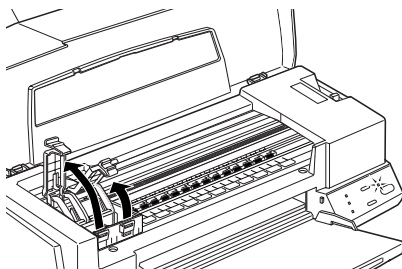

4. Open the ink cartridge packages. Next, remove the yellow tape seals only from each cartridge as shown below.

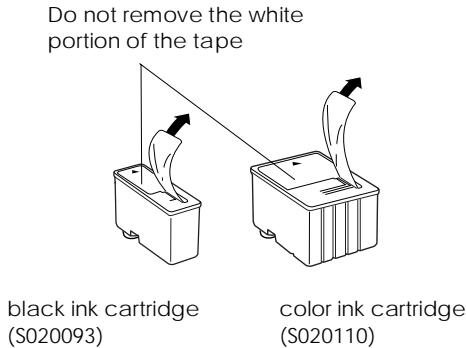

Caution:

- You must remove the yellow tape seals from the cartridges. If you attempt to print using a cartridge with the yellow tape seal still attached, the cartridge may become unusable. It's OK if the yellow tape does not completely tear off along the dotted line.*
- Do not remove the white portion of the tape seal from the top of the cartridge; otherwise, the cartridge may become clogged and you cannot print with it.*
- Do not remove the tape seal from the bottom of the cartridge; otherwise, ink will leak.*

- 5. Lower the cartridges into their holders with the labels face-up and the arrow marks pointing to the rear. The (larger) color cartridge goes on the right and the (smaller) black ink cartridge goes on the left.

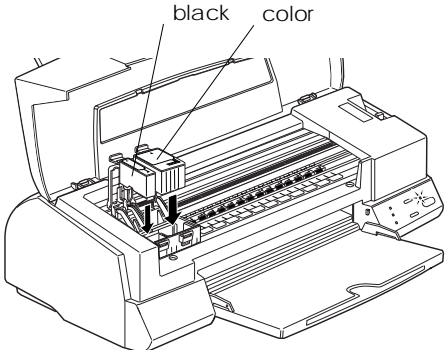

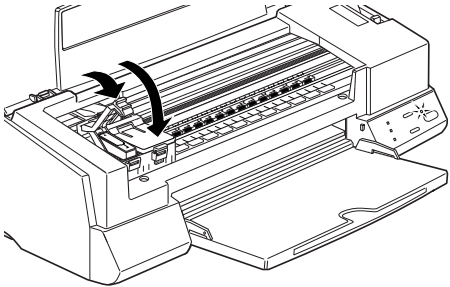

Note:
Install both ink cartridges. If either of the cartridges is not installed, the printer will not work.

- 6. Press the ink cartridge clamps down until they lock in place.



Caution:
Once you install the ink cartridges, do not open their clamps again until you replace the ink cartridges. Otherwise, the cartridges may become unusable.

7. Press the  cleaning button; then close the printer cover. The printer moves the print head and begins charging the ink delivery system. During the ink charging process, the  power light flashes.

Note:

Even if you do not press the  cleaning button, the printer moves the print head and begins the ink charging process about 60 seconds after you install the cartridges.

The ink charging process takes about two minutes to complete, during which time the printer produces a variety of mechanical sounds. These sounds are normal. When the ink delivery system has been charged, the  power light stops flashing.



Caution:

Never turn off the printer while the  power light is flashing. Doing so can result in incomplete charging of ink and you will not be able to print with the printer.

The life of a cartridge depends on the amount of text and graphics you print. The life of a color ink cartridge depends on the amount and the number of colors used in your documents.

Note:

When the ink runs out, see “Replacing an Ink Cartridge” on page 7-2.

Now you are ready to connect the printer to your computer. To connect the printer to your PC, see the following section. To connect it to your Macintosh, see page 2-25.

Connecting the Printer to Your PC

To connect the printer to your computer using the built-in parallel interface, you will need a shielded, twisted-pair parallel cable. To connect the printer to a Macintosh, see page 2-25.

2

Follow the steps below to connect the printer to the computer:

1. Make sure both the printer and computer are turned off.
2. Plug the cable connector securely into the printer's interface connector. Then squeeze the wire clips together until they lock in place on both sides. If your cable has a ground wire, connect it to the ground connector below the interface connector.

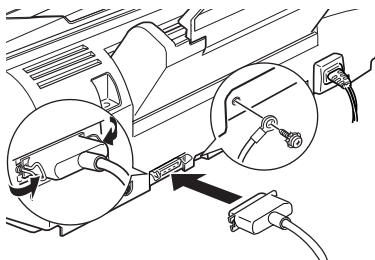

3. Plug the other end of the cable into the computer's parallel interface. If there is a ground wire at the computer end of the cable, connect it to the ground connector at the back of the computer.

Now see the next section for instructions on installing the printer software. You must install the printer software before using your printer.

Installing the Printer Software in Your PC

After connecting the printer to your computer, install the Windows printer software. It is included on the “Printer Software for EPSON STYLUS PHOTO EX” CD-ROM shipped with your printer.

Your printer software includes:

- ❑ **Printer driver**
The printer driver gives you complete control over your printer. With it, you can make settings such as Print Quality, Media Type, and Paper Size.
- ❑ **Utilities**
The Nozzle Check, Head Cleaning, and Print Head Alignment utilities help you to keep your printer in top operating condition. The Status Monitor utility allows you to check the current status of your printer.
- ❑ **Online help**
Online help gives you instant on-screen access to detailed information and instructions on how to use your printer.
- ❑ **EPSON Status Monitor 2 (for Windows 95)**
The EPSON Status Monitor 2 allows you to view printer status information such as the amount of ink remaining, and check for any printer errors.
- ❑ **HIGH QUALITY IMAGES (for Windows 95 and NT 4.0)**
HIGH QUALITY IMAGES allows you to see the kind of high-quality printout available from the EPSON STYLUS PHOTO EX quickly and easily. See the booklet packed with the CD-ROM for more information.

If you are using the floppy disk version of the software, make a backup copy of the EPSON printer software disk before you begin installation. If you wish to make a floppy disk version of the printer software on your CD-ROM, you can use the driver disk creation utility included on the CD. See below for Windows 95 and NT 4.0, or page 2-18 for Windows 3.1.

Installing in Windows 95 or Windows NT 4.0

Follow the steps below to install the printer software in Windows 95 or NT 4.0.

Note for Windows NT 4.0 users:

Printer driver installation may require network administration privileges. Ask your network administrator for more details.

1. Make sure Windows 95 or NT 4.0 is running and the printer is off.
2. Insert the printer software CD in the CD-ROM drive (if you use the floppy disk version, insert it in a disk drive). If the dialog box below appears, double-click Install Printer Driver/Utility; or you can also install by selecting Install Printer Driver/Utility and then clicking the arrow on the top right.

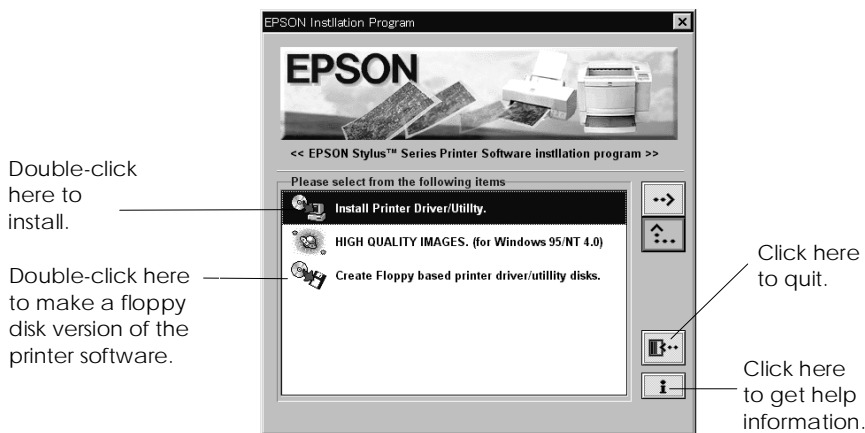

If this dialog box does not appear, double-click the My Computer icon, then double-click the CD-ROM drive icon (or floppy disk drive icon for floppy disk users). If this dialog box appears, double-click Install Printer Driver/Utility.

If this dialog box still does not appear, double-click the Setup.exe icon. You may need to use the arrows to scroll through the folder to find it.

3. If the dialog box below appears, click OK to start the printer software installation.



4. When the installation is complete, click OK again.
5. For Windows 95, the EPSON Status Monitor 2 utility installation starts automatically.

Note:

- You can stop the EPSON Status Monitor 2 utility installation by clicking the Cancel button. If you want to install it later, see "Installing the EPSON Status Monitor 2 utility" on page 4-29.*
- Installation time varies, depending on your computer system.*

Your printer software is now installed. The installation program automatically selects this printer as the default printer for Windows applications.

If you use your printer on a network, you need to set up your printer as a remote printer. See page 2-20 (for Windows 95) or page 2-22 (for Windows NT4.0).

Before using the printer software, read the README file located in the EPSON (Printers) folder. For information on opening and using the software, see “Printing With Windows” in Chapter 3, and Chapter 4, “Using the Printer Software for Windows” for using the utilities and further information on the printer driver.

Installing in Windows 95 (using plug-and-play)

Follow these steps to install the printer software using Windows 95 plug-and-play capabilities.

Note:

To install the printer software using Windows 95 plug-and-play capabilities, your computer's parallel port must be an IEEE 1284 compatible, bidirectional parallel port. See your computer documentation for more information.

1. Make sure the printer is connected to the computer's parallel port.
2. Turn off your printer and computer, if necessary.
3. Turn on the printer first; then turn on the computer. Your computer begins loading Windows 95.

4. If you defined a password, enter it at the prompt. You see the New Hardware Found screen.



If this screen does not appear, click **Cancel** and follow the installation procedure on page 2-13 instead.

5. Make sure your printer model name is displayed on the screen. Then click the **Driver from disk provided by hardware manufacturer** button. Do not select any of the other buttons.
6. Click **OK**. You see the **Install From Disk** screen.
7. Insert the printer software CD shipped with your printer in the CD-ROM drive. Depending on the country, the CD-ROM may contain a multiple-language version of the printer software.

First try typing `D:\Win95` and clicking **OK**. If an error message does not appear, proceed to step 8. If an error message appears, click **OK** to return to the **Install From Disk** screen. Type `D:\` then specify your preferred language by typing `English`, `Francais`, `German`, `Italian`, `Portugal`, or `Spanish`, followed by `\Win95`. Click **OK**. (If your CD-ROM drive uses a drive letter other than “D”, substitute the appropriate letter.)

If you use the floppy disk version, insert it in a disk drive. Type A:\Win95 and click OK. If you inserted the floppy disk in a drive other than drive "A", substitute the appropriate letter.

8. At the next screen you can type a unique name for the printer in the Printer name box. We recommend that you keep the model name as shown. The program will copy the files to your hard disk and add an icon to the Printers folder using the printer name you assign. To use this printer as the default printer for Windows 95 applications, select Yes. (No is the default setting.)
9. Click Finish.

Note:

- The EPSON Status Monitor 2 utility installation starts automatically. You can stop the installation by clicking the Cancel button. If you want to install it later, see "Installing the Status Monitor 2 utility" on page 4-29.*
- Installation time varies depending on your computer system.*

If you use the floppy disk version, click OK when the installation is completed.

Your printer software is now installed. Before using the printer software, be sure to read the README file located in the EPSON folder. For information on opening and using the software, see "Printing With Windows" in Chapter 3, and Chapter 4, "Using the Printer Software for Windows" for using the utilities and further information on the printer driver.

If you use your printer on a network with Windows 95, see page 2-20.

Installing in Windows 3.1

Follow these steps to install the software in Windows 3.1:

1. Make sure Windows 3.1 is running and the Program Manager window is open.
2. Insert the EPSON printer software CD shipped with your printer in the CD-ROM drive (if you use the floppy disk version, insert it in a disk drive).
3. Choose Run from the File menu. You see the Run dialog box. In the Command Line box, type D:\EPSETUP; and click OK (if the CD-ROM drive has a drive letter other than “D”, substitute the appropriate letter).
If you are using the floppy disk version, type A:\SETUP; and click OK (if the floppy disk drive has a drive letter other than “A”, substitute the appropriate letter).

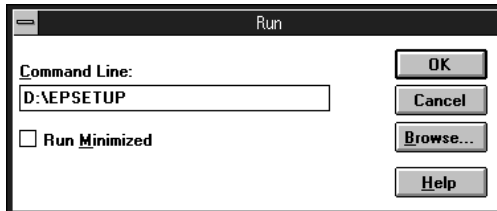

4. If the dialog box below appears, double-click Install Printer Driver/Utility; or you can also install by selecting Install Printer Driver/Utility and then clicking the arrow on the top right.

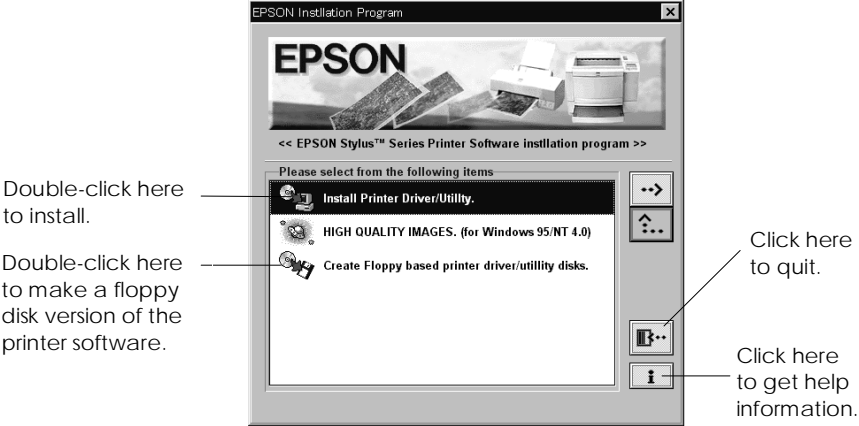

5. Select your printer icon in the EPSON Printer Utility Setup dialog box. Click OK. The installation program begins copying the printer software files.



6. When the installation is complete, click OK to exit the installation program.

The installation program automatically selects this printer as the default printer for Windows applications.

Before using the printer software, be sure to read the README file located in the EPSON group. For information on opening and using the printer driver, see “Printing With Windows” in Chapter 3, and Chapter 4, “Using the Printer Software for Windows” for using the utilities and further information on the printer driver.

Using Your Printer on a Network

With Windows 95

To use your printer over a network with Windows 95, you must set up the computer to which the printer is connected (the print server) and also set up the other computers on the network which will use the computer (the client computers). To set up the print server so that the printer is shared across the network, see your Windows 95 documentation.

The instructions below explain how to set up your Windows 95 as a client computer to use your printer, after you have set up the print server.

1. Make sure your printer software is installed (see page 2-13 if it is not installed).
2. Double-click the My Computer icon.
3. Double-click the Printers folder.
4. Right-click the icon of your printer, and click Properties.
5. Click the Details tab. Then click the Add Port button.

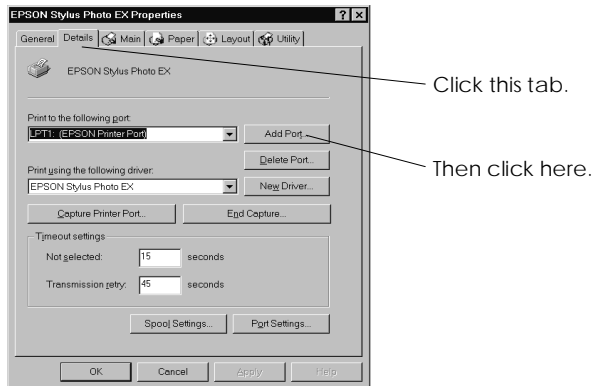

6. In the following dialog box, click Browse.

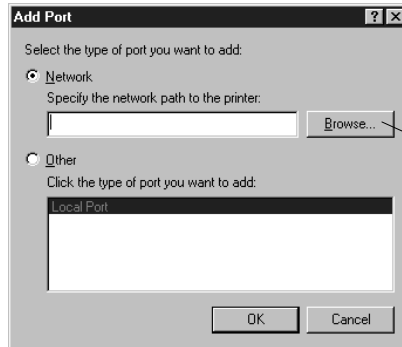

2

Click here to specify the network path.

7. Double-click the icon of the computer that is directly connected to the printer. Then click the icon of the printer you plan to use on the network.

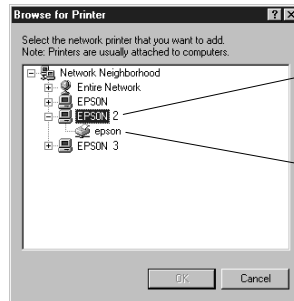

Select the computer that is connected to the printer.

Select the printer.

8. Click OK and follow the messages on the screen.

Now you can use the printer connected to the print server over the network from the client computer.

With Windows NT 4.0

To use your printer over a network with Windows NT 4.0, you must set up the computer to which the printer is connected (the print server) and also set up the other computers on the network which will use the computer (the client computers).

To set up the print server so that the printer is shared across the network, see your Windows NT 4.0 documentation.

The instructions below explain how to set up your Windows NT 4.0 as a client computer to use your printer, after you have set up the print server.

1. Make sure your printer software is installed (see page 2-13 if it is not installed).
2. Click Start, point to Settings, and click Printers.
3. Double-click the Add Printer icon.
4. Click the Network printer radio button. Click Next.
5. Select the print queue where print jobs destined for this printer will be sent, or select the network path to the printer.

Note:

Be sure to confirm all network settings with the network administrator.

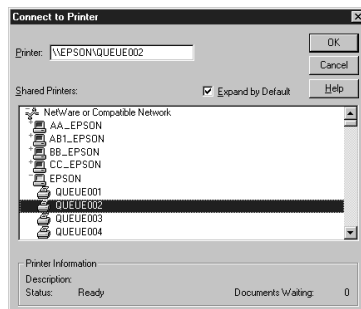

6. If the following dialog box appears, click OK and go to the next step.

If this dialog box does not appear, your printer is set up and ready to accept print jobs over the network, see Chapter 3 for information on how to start printing.

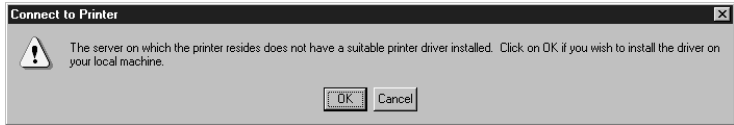

7. Click Have Disk.

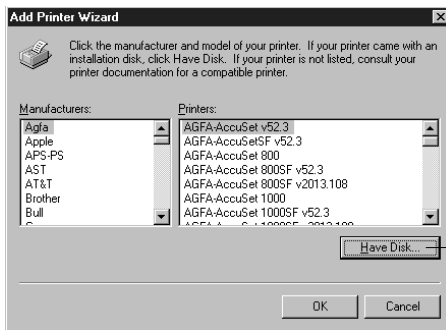

Click here.

8. Insert the printer software CD or floppy disk in the appropriate drive.
9. For the English version of the CD-ROM, type D:\WINNT40 and click OK. For the multiple-language version CD-ROM, type D:\ followed by your preferred language: English, Francais, German, Italian, Portugal, or Spanish. Then type \WINNT40, and click OK. (If you inserted the CD in a drive other than drive “D”, substitute the appropriate letter.)

If you use the floppy disk version of the printer software, type A:\WINNT40 and click OK. (If you inserted the floppy disk other than “A”, substitute the appropriate letter.)

10. Select your printer in the dialog box below and follow the on-screen instructions.



Select the model of your printer.

Note for Windows NT 4.0 users:

If your printer does not print correctly as a remote printer, the following procedure may help you solve the problem.

1. Install the Windows NT 4.0 printer software in your computer as described on page 2-13.
2. Click Start, and select Settings and Printers.
3. Right-click the icon of your printer, and click Properties.
4. Select a printer port other than LPT1 in the Port menu.
5. From the DOS prompt, type the network path to your printer, for example:
C:\net use lpt2: \\epserver\printer
then press the Enter key. If you selected a port other than lpt2: in step 4, substitute this port for “lpt2” in the command above. You should also substitute the name of your print server for “epserver”, and the name of the printer, as defined on the print server, for “printer”.
6. Restart your computer.

Note:

If you need to cancel this setting, type /d instead of the network path to your printer in step 5, for example, C:\net use lpt2: /d.

Connecting the Printer to Your Macintosh

To use the printer's built-in serial interface, you will need an Apple System Peripheral-8 cable. Read the following steps to connect the printer to your Macintosh:

1. Make sure both your printer and Macintosh are turned off.
2. Connect one end of the interface cable to the serial connector on the back of the printer.

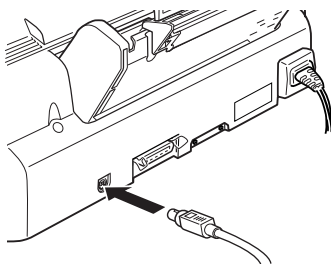

3. Connect the other end of the interface cable to either the modem port or printer port on the Macintosh. The ports are marked with the following icons.



modem port



printer port

4. Turn on the printer by pressing the ⏻ power button.
5. Turn on your Macintosh.

See below for instructions on installing the printer software. You must install the printer software before using your printer.

Installing the Printer Software in Your Macintosh

Always use the EPSON STYLUS PHOTO EX Macintosh printer software when printing with your printer. This software is specially designed to allow easy access to all the features of the printer.



Caution:

Turn off all virus protection programs before you install your printer software.

Installing the printer software

Follow the steps below to install your printer software. If you are using the floppy disk version, make a backup copy of the EPSON Macintosh printer software disk before you begin installation.

1. Turn on your Macintosh and insert the EPSON printer software CD shipped with your printer into its CD-ROM drive (if you use the floppy disk version, insert it in a disk drive).

The EPSON printer software disk opens automatically and, depending on the country, displays either a single installer icon or separate folders containing installer icons for several languages. Double-click the installer icon if it is displayed, or open the folder for your preferred language, then open the Disk 1 folder and double-click the installer icon inside it.

- After the initial screen appears, click Continue to advance to the following dialog box, where you can install all or some of the software components included on your printer software CD. For information on the included software, see page 2-28.

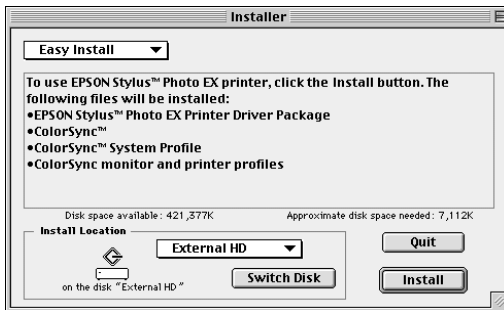

- If you want to install all of the printer software included on your printer software CD-ROM, make sure the Destination Disk box shows the correct disk drive and click Install.

If you are low on disk space, select Custom Install from the pop-up menu and click Serial Driver Package. Confirm the destination for installation, then click Install.

Note:

Click the  button to get information on each component.

- When a message appears informing you that installation is finished, click Restart to complete the installation and restart your computer.

Printer software components

Your printer software CD-ROM includes the following software components:

Serial Driver Package

- ❑ **SP EX**

This is the printer driver software that gives you control over your printer. With it, you can make settings such as Print Quality, Media Type, and Paper Size.
- ❑ **EPSON Monitor3**

Monitors and manages background printing jobs. You must turn on background printing in the Chooser to use this utility. For more information, see “Controlling Background Printing” on page 5-25.
- ❑ **StatusMonitor**

Keeps track of the current status of your printer, and alerts you when printer errors occur. You can open it from the Utility dialog box in the printer software. For more information, see “Using EPSON Printer Utilities” on page 5-22
- ❑ **Nozzle Check**

Checks the print head for clogging. You can open this utility from the Utility dialog box in the printer software. For more information, see “Using EPSON Printer Utilities” on page 5-22.
- ❑ **Head Cleaning**

Cleans the print head to maintain the best print quality. You can open this utility from the Utility dialog box in the printer software. For more information, see “Using EPSON Printer Utilities” on page 5-22 , and “Cleaning the Print Head” on page 8-30.
- ❑ **Print Head Alignment**

Adjusts the print head so that vertical lines are aligned. You can open this utility from the Utility dialog box in the printer software. For more information, see “Using EPSON Printer Utilities” on page 5-22, and “Aligning the Print Head” on page 8-34.

ColorSync™ 2.0 and Profiles

Matches the colors in your printout with the colors displayed on your screen. Use this when printing scanned photographs or computer graphics.

To use this feature, you may need to set the system profile for your monitor. Access the ColorSync™ System Profile utility through the Control Panel and click the Set Profile button. Select your monitor from the list of monitors that appears, and then click Select. Close the dialog box.

2

Using the Chooser to select your printer

After you install the printer software, you need to open the Chooser to select your printer. You have to choose the printer only the first time you use it or whenever you want to switch to another printer. Your Macintosh will always print using the last printer selected.

Note:

If you are using a Macintosh Quadra 950 or 900, you need to choose Compatible in the Serial Switch dialog box before selecting your printer from the Chooser. To open the Serial Switch dialog box, choose Control Panel from the Apple menu, then choose Serial Switch.

1. Make sure the printer is connected to your Macintosh and is turned on.
2. Choose Chooser from the Apple menu. Then click the icon corresponding to your printer and the port your printer is connected to. If you don't see the appropriate icon, use the arrows on the right to scroll through the available icons.

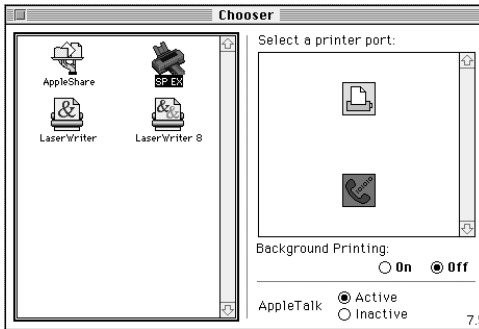

Note:

- If you are using AppleTalk on the printer port, select the modem port or leave AppleTalk inactive.*
- If you are using AppleTalk on the modem port, select the printer port or leave AppleTalk inactive.*
- If you are using your Macintosh in an Ethernet environment, you can connect your printer to either the printer port or modem port and leave AppleTalk active.*



Caution:

Do not make AppleTalk inactive if the Macintosh is connected to an AppleTalk network. However, if your Macintosh has a 68030 microprocessor CPU, make AppleTalk inactive whenever you print with the EPSON STYLUS PHOTO EX.

3. Click the Background Printing radio buttons to turn background printing on or off.

When background printing is on, you can use your Macintosh while it is preparing a document for printing. You must turn on background printing to use the EPSON Monitor 3 utility to manage print jobs. For more information, see “Using EPSON Printer Utilities” on page 5-22.

4. Close the Chooser.

Chapter 3

Starting to Print

Loading Paper	3-2
Printing With Windows	3-5
Printing With a Macintosh	3-8



Loading Paper

The following procedure describes how to load plain paper into the printer.

You can also print on special media including ink jet paper, transparencies, photo-quality glossy film or paper, envelopes, index cards, and adhesive sheets. For details on using such kinds of media, see Chapter 6, “Printing on Special Paper.”

1. Lower the output tray at the front of the printer and slide out the extension.

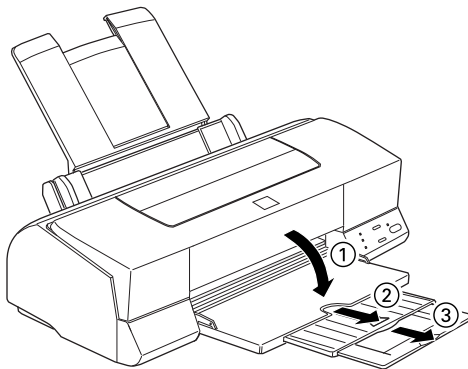

- Slide the left edge guide so that the distance between the edge guides is slightly wider than the width of your paper.

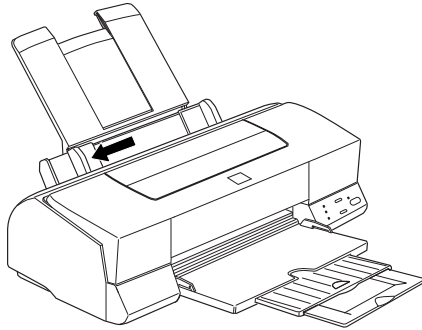

If you load long paper (for example, legal size paper), pull up the paper support extension.

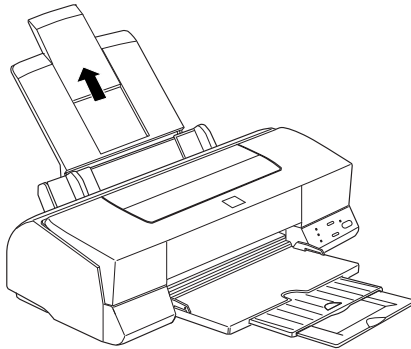

- Fan a stack of paper; then tap it on a flat surface to even the edges.

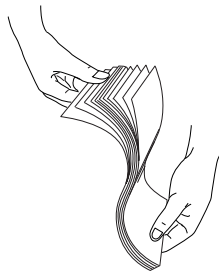

4. Load the stack of paper with the printable surface up, the paper top edge first and the right edge of the paper stack resting against the right side of the sheet feeder.

Note:

- ❑ *Always load paper into the sheet feeder short edge first. Load envelopes flap edge first with the flap side down.*
- ❑ *Load pre-printed forms or letterhead top edge first.*

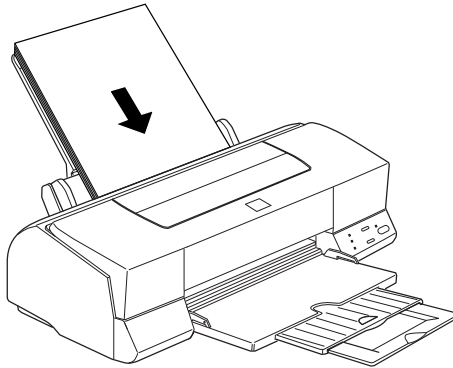

5. Slide the left edge guide against the left edge of the paper stack. Make sure the paper stack fits under both the edge guide tab and arrow mark as shown below.

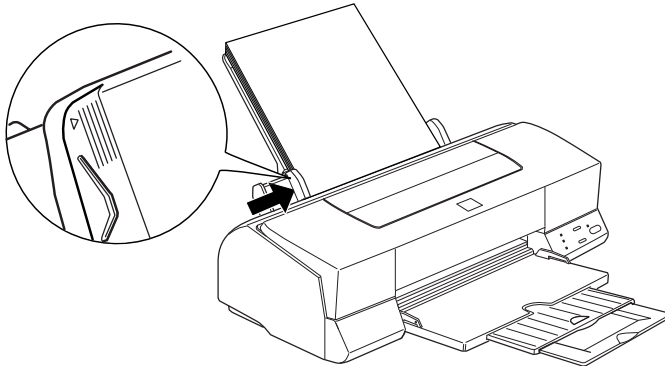

Printing With Windows

To get started with printing right away, follow the printing method explained below, which is typical of many Windows applications. The actual way you print may vary depending on the application you use. See your application manual for details. See page 3-8 for information on printing with a Macintosh.

Note:

While many Windows applications override the settings made with the printer driver, some do not, so you must verify the settings to get the results you expect.

1. From your application, open the document you want to print.
2. Click Print on the File menu. The Print dialog box (or a similar dialog box) appears.
3. Make sure your printer is selected and then click Printer, Setup, Properties, or Options. You may need to click more than one of these buttons in different dialog boxes. The printer software window appears.



4. Click the Main tab if necessary, and make sure the Mode option is set to Automatic.

Note:

When Automatic is selected, the printer software optimizes other settings according to the Media Type and Ink settings you make.

5. Click anywhere in the Media Type box, and select the media you loaded in the printer. If you don't see your media in the list, use the arrow on the right to scroll through the list. See "Making the Media Type Setting" on page 4-10 for more information.

Note:

Depending on the Media Type you choose, a slide bar appears in the Mode box that lets you choose Quality or Speed. Select Quality when print quality is more important than speed.

6. Select Color as the Ink setting if your document includes color. Select Black if you are printing black text, a draft, or if you want colors to print as varying shades of gray.
7. Click the Paper tab. The Paper menu appears.



8. Select the size of the paper you loaded in the printer from the Paper Size list. If you don't see your paper size in the list, use the arrow on the right to scroll through the list.

Note:

If your paper size is not included in the list, select User Defined and enter the paper size in the dialog box that appears. For information on the User Defined option, see online help.

9. Make the Orientation setting. The effect of your setting is shown in the display to the left.
10. Click OK at the bottom of the window. You return to the Print dialog box (or a similar dialog box).
11. Click Close, OK, or Print to print. You may need to click more than one of these buttons in different dialog boxes.

For Windows 95 and 3.1 users:

While your document is printing, the EPSON Despooler dialog box (Windows 3.1) or the EPSON Progress Meter (Windows 95) appears, showing the printing progress and the status of your printer. For details, see "Checking Printer Status" on page 4-21 and online help.

Printing With a Macintosh



To get started printing right away, follow the printing method explained below, which is typical of many Macintosh applications. The actual way you print may vary depending on the application you use. See your application manual for details. If you are printing from Windows applications, see the previous section.

Note:

While many Macintosh applications override the settings made with the printer driver, some do not, so you must verify the settings to get the results you expect.

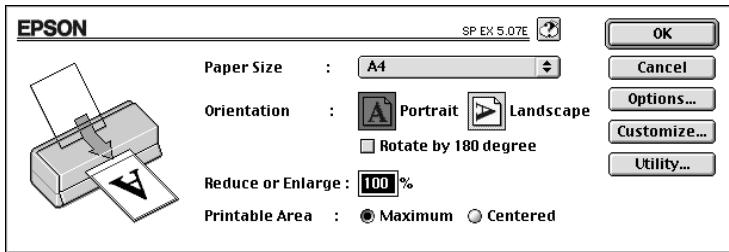
1. From your application, open the document you want to print.
2. Choose Page Setup from the File menu. This brings up the dialog box shown below.



3. Select the paper size you loaded in the printer from the Paper Size list.
4. Select  Portrait or  Landscape as the orientation option.
5. After making your settings, click the OK button to close the Page Setup dialog box.

Note:

You cannot print from the Page Setup dialog box. You can only print from the Print dialog box.

- Choose Print from the File menu. This brings up the dialog box shown below.

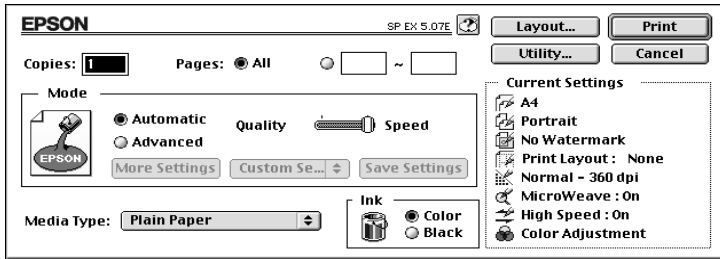

- Make sure the Mode option is set to Automatic.

Note:

When Automatic is selected, the printer software optimizes other settings according to the Media Type and Ink settings you make.

- Select the type of paper you loaded in the printer from the Media Type list. See page 5-4 for information.

Note:

Depending on the Media Type you choose, a slide bar appears in the Mode box that lets you choose Quality or Speed. Select Quality when print quality is more important than speed.

- Select Color as the Ink option if your document includes color. Select Black if you are printing black text, a draft, or if you want colors to print as varying shades of gray.
- Click Print to start printing.

Chapter 4

Using the Printer Software for Windows

The Printer Software	4-2
Accessing the Printer Software	4-2
From Windows applications	4-3
From Windows 95 or Windows NT 4.0	4-3
From Windows 3.1	4-4
Making Changes to Printer Driver Settings	4-5
Using the Automatic Setting	4-5
Using the Predefined Settings	4-6
Customizing the Print Settings	4-8
Making the Media Type Setting	4-10
Modifying the Printout Style (Windows 95 & NT 4.0)	4-12
Using EPSON Printer Utilities	4-15
EPSON Status Monitor 2 (for Windows 95)	4-16
Nozzle Check	4-16
Head Cleaning	4-16
Print Head Alignment	4-17
Printer and Option Information	4-17
Speed & Progress (for Windows 95)	4-19
Checking Printer Status (for Windows 95 and 3.1)	4-21
Understanding the EPSON Spool Manager	4-23
Using EPSON Status Monitor 2 (for Windows 95)	4-24
Getting Information Through Online Help	4-30
Accessing help from your application	4-30
Accessing help from Windows 95 or NT 4.0	4-30
Accessing help from Windows 3.1	4-30



The Printer Software

The printer software includes a printer driver and printer utilities. The printer driver lets you choose from a wide variety of settings to get the best results from your printer. The printer utilities help you check the printer and keep it in top condition. There are four levels of settings:

Automatic setting	The quickest and easiest way to start printing. See page 4-5.
Predefined settings	More control over printer settings according to the kind of printout. See page 4-6.
Custom settings	Fit your individual needs. See page 4-8.
Printout style settings (Windows 95 and NT 4.0)	Convenient functions for setting the printout method and style. See page 4-12.

To check the condition of the printer or perform a maintenance procedure, go to page 4-15.

Accessing the Printer Software

You can access the printer driver settings and printer utilities directly from any Windows application, or from My Computer (Windows 95 and NT 4.0) or Program Manager (Windows 3.1).

The print settings made in many Windows applications override similar settings made in the printer driver, so in most cases you should access the printer software from your application to make sure that the settings are appropriate for the document you want to print.

Note:

Online help is available for details about the printer driver settings.

From Windows applications

How you should access the printer software varies depending on the application, application version, and version of Windows you are using. Read the following for a general idea of how to access the software.

1. Choose Print or Print Setup from the File menu.
2. Click Printer, Setup, Properties, or Options in the dialog box that appears. (You may need to click a combination of these buttons.)

The Main, Paper, and Layout (for Windows 95 and NT 4.0) menus contain the printer driver settings. The Utility menu contains the printer utilities.

3. Click the corresponding tab at the top of the window to view a menu.

For information on the printer driver settings, see online help and pages 4-5 to 4-14. See page 4-15 for information on the printer utilities.

From Windows 95 or Windows NT 4.0

Follow these steps to access the printer software from My Computer.

1. Double-click the My Computer icon.
2. Double-click the Printers folder.

3. For Windows 95, right-click your printer icon, and click Properties.
For Windows NT 4.0, right-click your printer icon, then click Document Defaults.

The Main, Paper, and Layout menus contain the printer driver settings. The Utility menu contains the printer utilities.

4. Click the corresponding tab at the top of the window to view a menu.

For information on the printer driver settings, see online help and pages 4-5 to 4-14. See page 4-15 for information on the printer utilities.

From Windows 3.1

Follow these steps to access the printer software from Program Manager:

1. Double-click the Control Panel icon in the Main group.
2. Double-click the Printers icon.
3. Choose your printer from the Installed Printers list.
4. Choose Setup. You see the Main menu of the printer software window. The Main and Paper menus contain the printer driver settings. The Utility menu contains the printer utilities.
5. Click the corresponding tab at the top of the window to view a menu.

For information on the printer driver settings, see online help and pages 4-5 to 4-14. See page 4-15 for information on the printer utilities.

Making Changes to Printer Driver Settings

Accessing the printer software will show you the following printer driver setting menus (tabs) as well as the Utility menu.

Main	Mode, Media Type, Ink
Paper	Paper size, Copies, Orientation, Printable Area
Layout	Proportional Printing, Print Layout, Watermark

The layout menu is available only for Windows 95 and NT 4.0 users.

4

Using the Automatic Setting

When Automatic is selected on the Main menu, the printer driver takes care of all detailed settings according to the Media Type and Ink settings you make (see page 4-10 for details on the Media Type settings). So, Media Type and Ink are the only settings you need to make by yourself. Most Windows applications feature paper size and page layout settings which override similar settings on the Paper menu, but if your application does not, you should verify the settings on the Paper menu.



Note:

Depending on the media you choose in the Media Type list (while Automatic is selected), a slide bar may appear in the Mode box that lets you choose Quality or Speed. Select Quality when print quality is more important than speed.

Online help provides more information about the printer driver settings. See page 4-30 for instructions on using online help.

Using the Predefined Settings

The predefined settings are provided to help you optimize the print settings for a particular kind of printout, such as presentation documents or images taken by a video or digital camera.

1. Click Advanced on the Main menu.

You will find the predefined settings in the list below the Advanced button.

2. Select the most appropriate setting from the list according to the type of document or image you will print.

When you choose a predefined setting, other settings such as Print Quality, Halftoning, and Color are set automatically. Changes are shown in the Current Settings display at the bottom of the Main menu.

3. Before printing, be sure to verify the Media Type and Ink settings, as they may be affected by the predefined setting you select. See page 4-10 for more information on the Media Type setting.

The printer driver provides the following predefined settings:

Advanced Photo	Good for printing scanned photos and digitally-captured images in high quality. Also helps prevent the misprinting of ink dots that may occur due to the movement of the printer head and paper.
Photo	Good for printing scanned photos.
Text/Graph	Good for printing presentation documents such as graphs and charts
PhotoEnhance (for Windows 3.1) OR PhotoEnhance2 (for Windows 95 and NT 4.0)	Good for printing images captured using a video, digital camera, or scanner. EPSON PhotoEnhance and PhotoEnhance2 automatically adjust the contrast, saturation, and brightness of the original image data to produce sharper, more vivid color printouts. The PhotoEnhance and PhotoEnhance2 settings do not affect your original image data. Note: <i>Printing with PhotoEnhance or PhotoEnhance2 selected may increase the print time, depending on your computer system and the amount of data contained in your image.</i>
Text	Good for printing text-only documents
Economy	Good for printing drafts of text
ICM (for Windows 95)	ICM means Image Color Matching. This feature automatically adjusts printout colors to match colors on your screen.

Customizing the Print Settings

Many users will never need to make their own print settings manually. However, if you need more control over the driver, want to make the most detailed settings available, or just want to experiment, see below.

1. Click Advanced on the Main menu and then click More Settings. The More Settings dialog box appears:

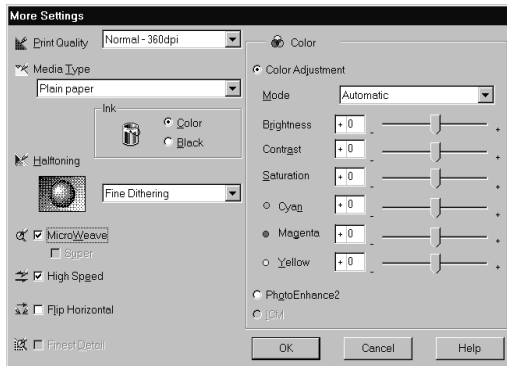

2. Select the Print Quality setting.
3. Select the Media Type that you loaded in the printer. See the next section for details.
4. Choose Color or Black in the Ink option.
5. Make other settings. For details, see online help.

Note:

Some settings are enabled or disabled depending on the Print Quality, Media Type, and Ink settings you make.

6. Click OK to apply your settings and return to the Main menu. Click Cancel to return to the Main menu without applying your settings.

Saving your settings

To save your custom settings, click **Save Settings** on the **Main** menu. The **Custom Settings** dialog box appears:

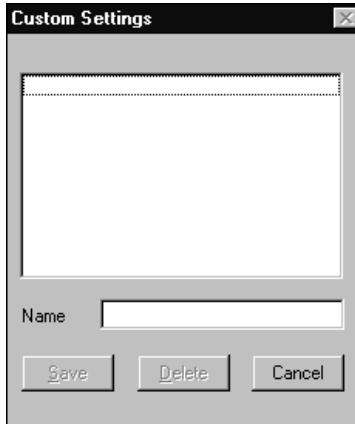

Type a unique name for your custom settings in the **Name** box, and click the **Save** button. Your settings will appear in the list under the **Advanced** button on the **Main** menu.

Note:

- ❑ *You cannot use a predefined setting name for your custom settings.*
- ❑ *To delete a custom setting, click **Save Settings** on the **Main** menu, select the setting in the **Custom Settings** dialog box and then click **Delete**.*
- ❑ *You cannot delete the predefined settings.*

If you change the **Media Type** or **Ink** setting when one of your custom settings is selected in the **Advanced** settings list on the **Main** menu, the setting selected in the list changes to **Custom Settings**. The custom setting that was previously selected is not affected by this change. To return to your custom setting, simply reselect it from the settings list.

Making the Media Type Setting

On the Main menu, select the Media Type setting that matches the paper you loaded in the printer. See the following to determine the Media Type setting (shown in bold) for your paper. First find your paper, then click the corresponding Media Type setting.

Note:

If the corresponding Media Type option for your paper is not shown in the Media Type list, change the Print Quality setting in the More Settings dialog box, select Automatic as the Mode setting, or change the predefined setting in the Advanced settings list on the Main menu.

Plain Paper

Plain paper Envelopes

360 dpi Ink Jet Paper

EPSON 360 dpi Ink Jet Paper (A4)	S041059
	S041025
EPSON 360 dpi Ink Jet Paper (Letter)	S041060
	S041028
EPSON 360 dpi Ink Jet Paper (A3)	S041065
	S041046
EPSON Iron-On Cool Peel Transfer Paper (A4)	S041154
EPSON Iron-On Cool Peel Transfer Paper(Letter)	S041153
	S041155

Photo Quality Ink Jet Paper

EPSON Photo Quality Ink Jet Paper (A4)	S041061
	S041026
EPSON Photo Quality Ink Jet Paper (Letter)	S041062
	S041029
EPSON Photo Quality Ink Jet Paper (Legal)	S041067
	S041048
EPSON Photo Quality Ink Jet Paper (A3)	S041068
	S041045

EPSON Photo Quality Ink Jet Card (A6)	S041054
EPSON Photo Quality Ink Jet Card (5 × 8 in.)	S041121
EPSON Photo Quality Ink Jet Card (8 × 10 in.)	S041122
EPSON Photo Quality Self Adhesive Sheet (A4)	S041106

Ink Jet Transparencies

EPSON Ink Jet Transparencies (A4)	S041063
EPSON Ink Jet Transparencies (Letter)	S041064

Photo Paper

EPSON Photo Quality Glossy Paper (A4)	S041126
EPSON Photo Quality Glossy Paper (Letter)	S041124
EPSON Photo Quality Glossy Paper (A3)	S041125
EPSON Photo Paper (4 × 6 in.)	S041134
EPSON Photo Paper (A4)	S041140
EPSON Photo Paper (Letter)	S041141
EPSON Photo Paper (A3)	S041142
EPSON Panoramic Photo Paper (210 × 594 mm)	S041145

Photo Quality Glossy Film

EPSON Photo Quality Glossy Film (A4)	S041071
EPSON Photo Quality Glossy Film (Letter)	S041072
EPSON Photo Quality Glossy Film (A3)	S041073
EPSON Photo Quality Glossy Film (A6)	S041107
EPSON Photo Stickers (A6)	S041144

Note:

The availability of special media varies by country.

Modifying the Printout Style (Windows 95 & NT 4.0)

The Orientation feature in the Paper menu and the Layout menu allow you to make various print settings that affect the way your document is printed and the look of your printout.

This section describes the features provided for Windows 95 and NT 4.0. For more details, see online help.

Using the Orientation feature (Paper menu)

The orientation box contains the Rotate by 180° setting.



Check here to minimize the blank area at the bottom of your printout.

The Rotate by 180° setting rotates your document 180 degrees vertically, which allows you to print closer to the bottom edge. This is possible because the printer's minimum top margin is smaller than the minimum bottom margin.

Using the Layout menu

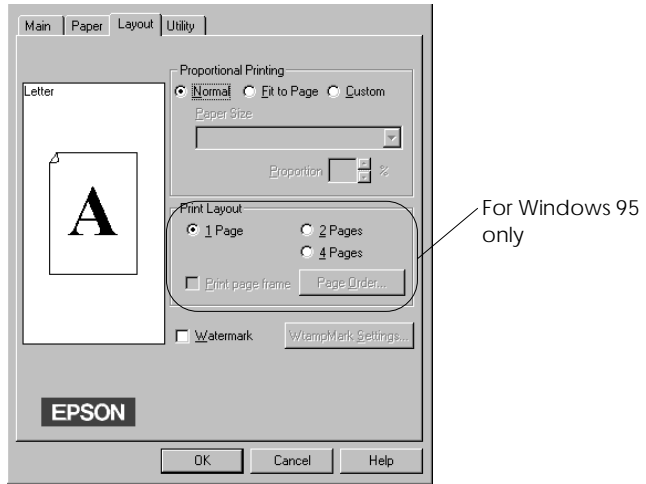

Proportional Printing

- Normal** Prints your document at its normal size.
- Fit to Page** Proportionally enlarges or reduces the size of your document to make it fit the paper size you select in the Paper Size list.
- Custom** Allows you to manually define the percentage you want to enlarge or reduce an image. Click the arrows next to the Proportion box to select a scaling ratio from 10% to 400%.

Print Layout (for Windows 95)

2 Pages/4 Pages	Prints 2 or 4 pages of your document on a single piece of paper.
Page Order	Allows you to select the order of the printed pages.
Print page frames	Allows you to print a frame around each page on the sheet of paper. The Print page frames feature is active if a check appears in the check box.

Watermark

Check the Watermark check box to activate the currently selected watermark and to enable the Watermark Settings button, which opens the Watermark Settings dialog box.

In the Watermark Settings dialog box you can select from a list of predefined watermarks, or you can select a bitmap (.BMP) file as your own custom watermark. The Watermark Settings dialog box also allows you to make a variety of detailed watermark settings, for example you can select the size, color, and position of your watermark.

Using EPSON Printer Utilities

EPSON printer utilities allow you to perform some printer maintenance from your screen. For Windows 95, utilities to check the current printer status are also available. To access the utilities, click the Utility tab in the printer software window, then click the button for the utility you want to use. The utilities are explained briefly below. For more details, see online help.

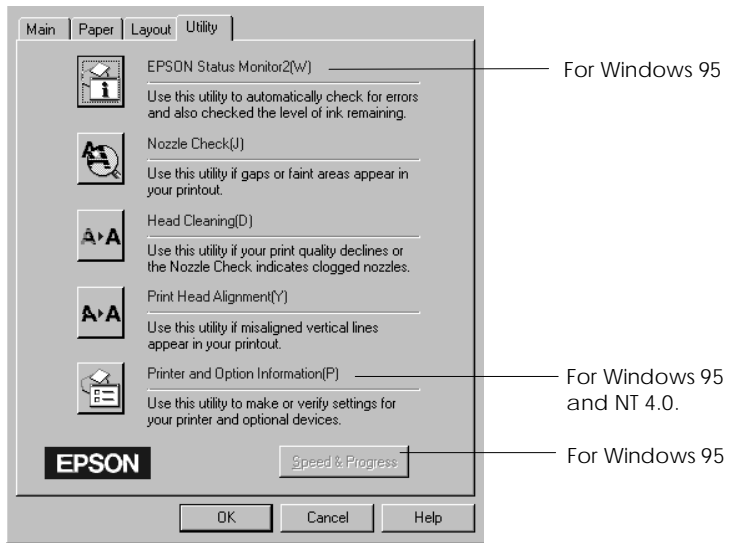

4

Note:

- ❑ *The letter in parentheses after the utility name indicates the shortcut key for that utility. Press Alt and the appropriate letter on the keyboard to open that utility.*
- ❑ *While printing is in progress, pressing any of the utility buttons, except the EPSON Status Monitor 2 button, may mar your printouts.*

EPSON Status Monitor 2 (for Windows 95)

Provides you with printer status information, such as the amount of ink remaining, and checks for printer errors.

This utility is available only if:

- You have installed the Status Monitor 2 (if not, see page 4-29),
- The printer is connected directly to the host computer via the parallel port (LPT1), and
- Your system is configured to support bi-directional communication.

The online help included with the EPSON Status Monitor 2 utility provides you with detailed information about using EPSON Status Monitor 2. Click Help in the Printer Status window.

Nozzle Check

Checks the print head nozzles for clogging. Check the nozzles if you notice a decline in print quality, and also after cleaning to confirm that the print head nozzles have been cleared. In case the nozzle check indicates the print head needs cleaning, you can access the Head Cleaning utility directly from the Nozzle Check utility.

Head Cleaning

Cleans the print head. You may need to clean the head if you notice a decline in print quality. Before and after print head cleaning, use the Nozzle Check utility to check whether the print head needs to be cleaned (again). You can access the Nozzle Check utility directly from the Head Cleaning utility.

Print Head Alignment

Aligns the print head. Use this utility if you notice your printouts contain misaligned vertical lines while the High Speed setting is turned on in the More Setting dialog box.

Note:

- ❑ *Do not use the Nozzle Check, Head Cleaning, and Print Head Alignment utilities with printers connected to your computer through a network.*
- ❑ *Do not use the Nozzle Check, Head Cleaning, and Print Head Alignment utilities while printing is in progress; otherwise your printout may be marred.*

Printer and Option Information

This utility allows the printer driver to confirm printer configuration information. It also provides specific information regarding certain characteristics of the printer such as Printer ID (Windows 95 and Windows NT 4.0 only).

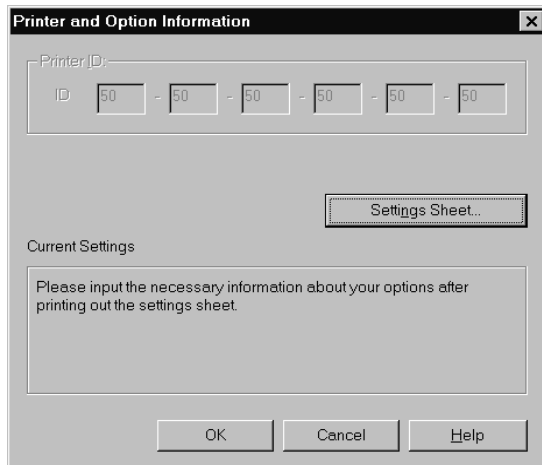

The information displayed in the Printer and Option Information dialog box and the ability to update that information automatically varies, depending on your system setup. Under certain circumstances, you may need to input some information manually. If a message appears in the Current Settings window prompting you to enter settings, or if you change the printer's configuration, follow the steps below to make the necessary settings manually:

1. Click the Settings Sheet button in the Printer and Option Information dialog box to print out information about your printer and options. This requires A4 or letter size paper. You will see a printout similar to the one below.

```
Printer ID
50- 50- 50- 50- 50- 50
```

2. Make sure the settings in the utility match the information on the printed Settings Sheet. If they do not match, correct the settings on the screen to match the information on the settings sheet.
3. Click OK to exit this menu and save your settings.

Speed & Progress (for Windows 95)

You can make certain print speed settings to your system with this button. Click the Speed & Progress button to view the following dialog box and the settings that are described below.

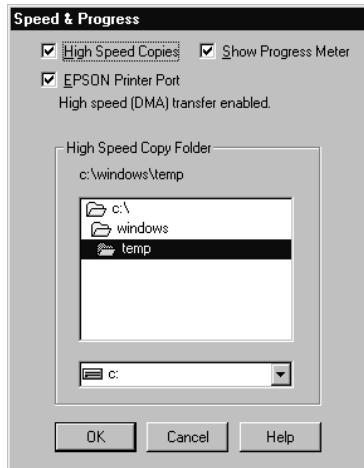

High Speed Copies

Turns on high-speed printing for multiple copies. This speeds up printing by using your hard disk space as a cache when printing multiple copies of your document.

Show Progress Meter

Displays the Progress Meter every time you print. See also page 4-21.

EPSON Printer Port

Turns on the EPSON printer port, which is optimized for EPSON printers, instead of the Windows default printer port. This speeds up the data transfer rate to EPSON printers.

DMA Transfer

A message may appear below the EPSON printer port setting stating the DMA transfer capability of your system. If you do not see a message, DMA transfer is not available on your system.

One of the following messages may appear:

- High Speed (DMA) Transfer enabled.

DMA transfer is already enabled on your system.

- For higher data transfer rates, use DMA transfer.

You may be able to make printing faster by enabling DMA transfer on your system. See page 8-26 for instructions about how to enable DMA transfer.

Checking Printer Status (for Windows 95 and 3.1)

When you send a print job to the printer, the Progress Meter (Windows 95), or the Despooler (Windows 3.1) appears on your computer screen.

From Windows 95 (Progress Meter)

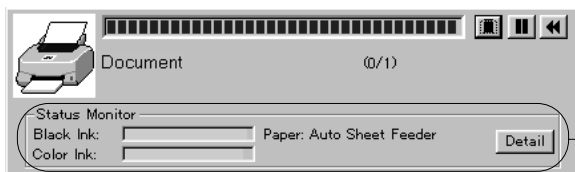

Appears only when the Status Monitor utility is installed

4

This meter shows the progress of the current print job and provides printer status information when bidirectional communication between the printer and computer is established.

If you click the Detail button, you can open the Printer Status window to obtain more detailed information.

Note:

The Progress Meter does not appear when Show Progress is turned off in the Speed & Progress dialog box. See page 4-19 for information.



Stop Cancels printing



Pause Pauses printing until you press it again



Reprint Restarts printing from the current page, reprints the whole document, or holds the document for printing later

From Windows 3.1 (Despooler)



This dialog box shows the progress of the current print job.

You can also cancel, pause and resume, and restart selected print jobs from the Progress Meter or the Despooler.



Stop Cancels printing



Pause Pauses printing until you press it again



Reprint Restarts printing from the current page, reprints the whole document, or holds the document for printing later

Understanding the EPSON Spool Manager

The EPSON Spool Manager is similar to the Windows Print Manager. If a print job or jobs are received by the EPSON Spool Manager while a print job is being processed, the new jobs are placed in a print queue, ready to be processed in the order in which they were received. When a print job reaches the top of the line, the EPSON Spool Manager sends the job to the printer.

From Windows 95

Click the EPSON Stylus Photo EX button after it appears on the taskbar. You can see the status and information for the print jobs and also you can cancel, pause and resume, or restart selected print jobs from the Spool Manager.

4

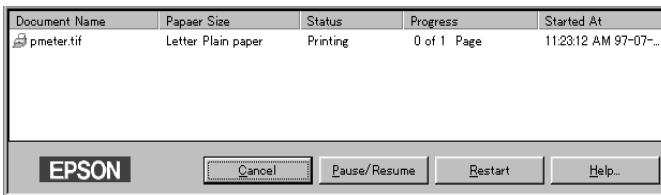

From Windows 3.1

Double-click the EPSON Spool Manager icon after it appears at the bottom of your desktop, or double-click the Spool Manager icon in the EPSON group. For more information, see online help.

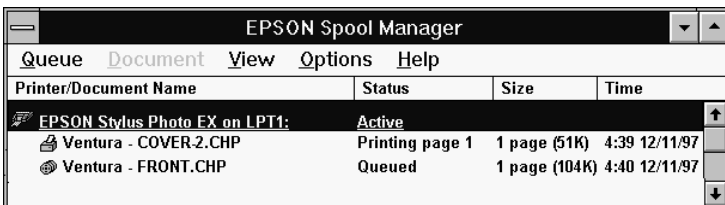

Using EPSON Status Monitor 2 (for Windows 95)

If you installed the Status Monitor utility (see page 2-14), you can get detailed information on the printer status.

Note:

- ❑ *If you have not installed the Status Monitor yet, see “Installing the Status Monitor 2 utility” later in this chapter.*
- ❑ *Before using the Status Monitor, be sure to read the README file located in the EPSON Status Monitor 2 folder in the Epson folder on your hard drive.*

There are two ways to access EPSON Status Monitor 2:

- ❑ Double-click the printer-shaped background monitoring icon on the taskbar at the bottom of your computer screen.

Note:

You must restart your computer after installing EPSON Status Monitor 2 to view the background monitoring icon.

- ❑ Click Start, point to Programs, click Epson, and then click EPSON Status Monitor 2.

You see the Status Monitor 2 window:

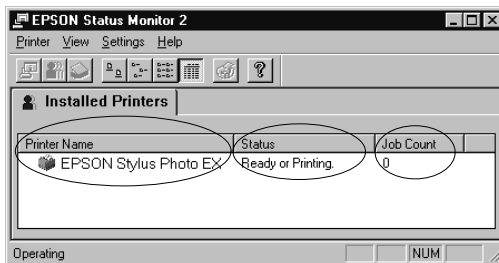

The EPSON Status Monitor 2 window displays:

Printer icon

The color of the printer icon indicates the current printer status.

Green	Ready
Yellow	Some kind of maintenance is necessary
Red	An error has occurred
Dimmed	Communication problem between Status Monitor 2 and printer

Printer Name

The name of the EPSON printer connected directly to your computer appears in this column.

Note:

- You can add or delete printers from the list. To save computer memory, delete printers you do not need to monitor (this does not remove the printer driver from your computer). Choose Add Printer or Delete Printer on the Settings menu.*
- You can rearrange the order of the printers in the list. Click the Printer Name, Status, or Job Count title bar to change the order of the printers.*

Status

Brief messages appear here regarding the current status of the printer.

Job Count

Shows the number of jobs waiting to print.

Note:

To get more information, choose Job Status on the Printer menu or click the Job Status  button on the tool bar.

To get more detailed information, double-click the printer name, select the printer and then choose Printer Status on the Printer menu, or select the printer and click the Printer Status  button on the tool bar. See “Printer Status window” below for details.

Note:

You can control the contents of the Status Monitor 2 window using the View menu. See online help for Status Monitor 2.

Printer Status window

If you access the Printer Status window as described above, the following appears:

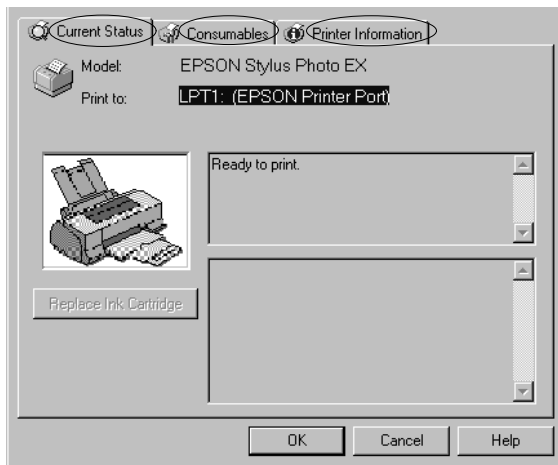

Note:

You can also access the Printer Status window from the Status Alert dialog box. See the next section for the Status Alert dialog box.

You can open the three menus described below by clicking the tabs at the top of the Printer Status window:

- Current Status**
Provides you with detailed printer status information, a graphic display, and status messages. If a printer error occurs, troubleshooting tips appear in the bottom message box.
- Consumables**
Shows the graphic display for the amount of ink remaining.
- Printer information**
Provides you with information about network connections and other printer resources (for printers connected over a network).

For details, see online help for the EPSON Status Monitor 2 utility.

Making monitoring settings

You can make monitoring settings, such as selecting the monitoring interval and turning on or off background monitoring.

1. Make sure the Status Monitor is active (it is active if a printer-shaped icon appears on the taskbar at the bottom of your computer screen). If the Status Monitor is inactive, open the EPSON Status Monitor 2 window from Start, as described on page 4-24. Then point to **Background Monitoring on the Settings menu** and click **Monitor** from **restart** or **Monitor now** to enable Status Monitor.

Note:

The Background Monitoring and Status Alert settings are not available while the Status Monitor is inactive.

2. Select the printer you want to monitor from the Installed Printers list, and then click Monitoring Preferences on the Settings menu. The dialog box below appears.

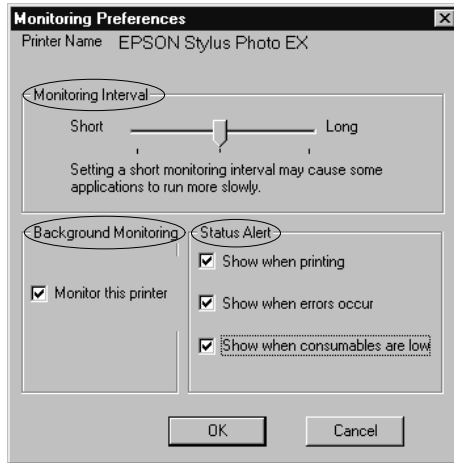

- ❑ **Monitoring Interval**
You can adjust the monitoring interval by dragging the slider.

Note:

Setting a short monitoring interval may slow down some applications.

- ❑ **Background Monitoring**
If this is turned on, the Status Alert dialog box automatically appears to inform you of the printer status while you are using application programs. You can select when the Alert dialog box appears by using the Status Alert options on the right.
- ❑ **Status Alert**
You can specify when you want the Status Alert dialog box to appear.

3. Click OK to save your settings.

Note:

If you want the Status Alert dialog box to appear in front of other windows on the desktop, right-click the background monitoring icon and choose Show on Top.

Installing the Status Monitor 2 utility

Note:

If you installed the Status Monitor 2 utility when you installed the printer software, you do not need to install it again.

4

To use the Status Monitor 2, you need to install the software as described below:

1. Make sure Windows 95 is running. Insert the printer software CD-ROM in the CD-ROM driver (if you are using floppy disks, insert the floppy disk in the floppy disk drive).
2. If a dialog box appears, click Quit.
3. Click Start, and select Run.
4. Type D:\ and specify your preferred language (see page 2-16) followed by \status2 in the box.
If you inserted the CD in a drive other than drive "D", substitute the appropriate letter.
If you use the floppy disk version, substitute the letter of the floppy disk drive.
5. Click OK. The installation starts. Follow the instructions on the screen.

Getting Information Through Online Help

Your printer software has an extensive online help feature, which will answer most of your questions about your printer software. It provides you with instructions on printing, making printer driver settings, using printer utilities, and troubleshooting printer errors.

Accessing help from your application

Open the File menu and choose Print or Print Setup. Then click Printer, Setup, Options, or Properties (you may need to click a combination of these buttons) depending on the software you are using. Click the Help button at the bottom of the Main, Paper, Layout, or Utility menu for help related to the items on that menu.

For Windows 95 and NT 4.0 users:

You can get specific help related to any item on a menu by right-clicking the item, then clicking the What's This? prompt.

Accessing help from Windows 95 or NT 4.0

Click the Start button, point to Programs and Epson (Windows 95) or EPSON Printers (Windows NT 4.0), and then click EPSON Stylus Photo EX Help. You see the help contents window.

Accessing help from Windows 3.1

Open the EPSON group and double-click the EPSON Stylus Photo EX Help icon. You see the help contents window.

Chapter 5

Using the Printer Software for Macintosh

The Printer Software	5-2
Making Changes to Printer Driver Settings	5-2
Using the Automatic Setting	5-3
Using the Predefined Settings	5-6
Customizing the Print Settings	5-9
Saving your settings	5-16
Using your saved settings	5-17
Changing the Paper Size	5-17
Defining a Custom Paper Size	5-19
Modifying the Printout Method and Style	5-20
Using EPSON Printer Utilities	5-22
EPSON StatusMonitor	5-23
Configuration	5-24
Nozzle Check	5-24
Head Cleaning	5-24
Print Head Alignment	5-25
Controlling Background Printing	5-25



The Printer Software

The printer software includes a printer driver and printer utilities. The printer driver lets you choose from a wide variety of settings to get the best results from your printer. The printer utilities help you check the printer and keep it in top condition.

The quickest and easiest way to start printing is to leave the Mode option set to Automatic in the Print dialog box. This way you only need to check the Media Type and Ink settings, as described on page 5-4.

Basically, there are three levels of settings: the Automatic setting; the predefined settings, which give you more control over printer settings; and the custom settings, which you make to suit your individual needs. These settings are described in detail below.

To check the condition of the printer or perform a maintenance procedure, see “Using EPSON Printer Utilities” on page 5-22.

Making Changes to Printer Driver Settings

You will find the printer driver settings in the following dialog boxes:

- Print dialog box (click Print on the File menu of your application or click Options in the Page Setup dialog box)
- Page Setup dialog box (click Page Setup on the File menu of your application)
- Layout dialog box (click Layout in the Print dialog box)

Using the Automatic Setting

When Automatic is selected as the Mode setting in the Print dialog box, the printer driver takes care of all detailed settings according to the Media Type and Ink settings you make (see page 5-4 for details on the Media Type setting). Usually, you will never have to change this setting. However, if your application program does not give you enough control over the printout, you may want to experiment with the predefined settings or make your own custom settings. See page 5-6 for information on the predefined settings, and page 5-9 for information on making custom settings.

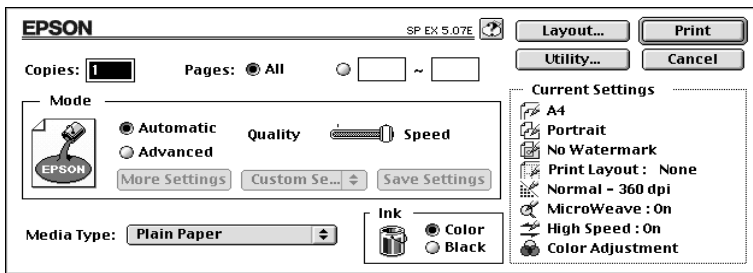

Note:

Depending on the media you choose in the Media Type list while Automatic is selected, a slide bar may appear in the Mode box that lets you choose Quality or Speed. Select Quality when print quality is more important than speed.

Before printing, verify the Media Type and Ink settings as described below because they also have an effect on the other settings. You may also need to check the Page Setup dialog box for other basic settings such as paper size. See page 5-17 for information on the Page Setup dialog box.

Media Type

Select the Media Type setting that matches the kind of paper you loaded in the printer. See below to determine which Media Type setting (shown in bold) best matches your paper.

Plain Paper

Plain paper
Envelopes

360 dpi Ink Jet Paper

EPSON 360 dpi Ink Jet Paper (A4)	S041059
	S041025
EPSON 360 dpi Ink Jet Paper (Letter)	S041060
	S041028
EPSON 360 dpi Ink Jet Paper (A3)	S041065
	S041046
EPSON Iron-on Cool Peel Transfer Paper (A4)	S041154
EPSON Iron-on Cool Peel Transfer Paper (Letter)	S041153
	S041155

Photo Quality Ink Jet Paper

EPSON Photo Quality Ink Jet Paper (A4)	S041061
	S041026
EPSON Photo Quality Ink Jet Paper (Letter)	S041062
	S041029
EPSON Photo Quality Ink Jet Paper (Legal)	S041067
	S041048
EPSON Photo Quality Ink Jet Paper (A3)	S041068
	S041045
EPSON Photo Quality Ink Jet Card (A6)	S041054
EPSON Photo Quality Ink Jet Card (5 × 8 in.)	S041121
EPSON Photo Quality Ink Jet Card (8 × 10 in.)	S041122
EPSON Photo Quality Self Adhesive Sheet (A4)	S041106

Ink Jet Transparencies

EPSON Ink Jet Transparencies (A4)	S041063
EPSON Ink Jet Transparencies (Letter)	S041064

Photo Paper

EPSON Photo Quality Glossy Paper (A4)	S041126
EPSON Photo Quality Glossy Paper (Letter)	S041124
EPSON Photo Quality Glossy Paper (A3)	S041125
EPSON Photo Paper (4 × 6 in.)	S041134
EPSON Photo Paper (A4)	S041140
EPSON Photo Paper (Letter)	S041141
EPSON Photo Paper (A3)	S041142
EPSON Panoramic Photo Paper (210 × 594 mm)	S041145

Photo Quality Glossy Film

EPSON Photo Quality Glossy Film (A4)	S041071
EPSON Photo Quality Glossy Film (Letter)	S041072
EPSON Photo Quality Glossy Film (A3)	S041073
EPSON Photo Quality Glossy Film (A6)	S041107
EPSON Photo Stickers (A6)	S041144

Note:

The availability of special media varies by country.

Ink

If your document includes color, select Color. If you are printing black text, a draft, or if you want colors to print as varying shades of gray, choose Black.

Using the Predefined Settings

If you click *Advanced* in the Print dialog box, you can select a predefined setting. The predefined settings are provided to help you optimize the print settings for a particular kind of printout, such as presentation documents or images taken by a video or digital camera.

You will find the predefined settings in a list located between the *More Settings* and *Save Settings* buttons in the Print dialog box.

When you choose a predefined setting, other settings such as *Print Quality*, *Halftoning*, and *Color* are set automatically. Changes are shown in the *Current Settings* display on the right side of the Print dialog box. Before printing, be sure to verify the *Media Type* and *Ink* settings, as they may be affected by the predefined setting you select. See the previous section for more information on the *Media Type* and *Ink* settings.

The printer driver provides the following predefined settings:

Advanced Photo

This setting provides you with excellent reproduction of scanned images or digitally captured images, though printing is slower with *Advanced Photo*. You will get the best results if you use this setting in combination with high quality paper.

Photo

This setting is best for printing scanned photographs. It increases the contrast in an image.

Note:

Changing the Ink setting after Photo is selected returns the settings list to Custom Settings, so always make your Ink setting before you select this option.

Text/Graph

This setting is best for graphics-intensive documents such as charts and graphs for presentations. It intensifies the colors but lightens the midtones and highlights of an image.

Note:

Changing the Ink setting after Text/Graph is selected returns the settings list to Custom Settings, so always make your Ink setting before you select this option.

PhotoEnhance2

This setting is best for printing images captured using a video recorder, digital camera, or scanner. The EPSON PhotoEnhance2 feature produces sharper images and more vivid colors by automatically adjusting the contrast, saturation, and brightness of the original image data.

Note:

- Selecting PhotoEnhance2 automatically sets the Ink option to Color. Changing the Ink setting after PhotoEnhance2 is selected returns the settings list to Custom Settings.*
- Printing with PhotoEnhance2 selected may take longer than other settings, depending on your computer system and the amount of data contained in your image.*

Economy

This setting provides you with faster printing and saves ink. The printer uses less ink by printing fewer dots per character. Choose this setting for rough drafts of text only.

Note:

Changing the Ink setting after Economy is selected returns the settings list to Custom Settings, so always make your Ink setting before you select this option.

ColorSync

This setting automatically adjusts printed colors to match the colors on your screen.

Note:

Selecting ColorSync automatically sets the Ink option to Color. Changing the Ink setting after ColorSync is selected returns the settings list to Custom Settings.

Text

This setting is best for printing text-only documents. It provides you with faster printing than the Text/Graph setting with only a slight decrease in printing quality.

Note:

Changing the Ink setting after Text is selected returns the setting list to Custom Settings, so always make your Ink setting before you select this option.

Customizing the Print Settings

Many users will never need to make their own print settings manually. However, if you need more control over the driver, want to make the most detailed settings available, or just want to experiment, click the Advanced button in the Print dialog box. Then click the More Settings button. The More Settings dialog box appears.

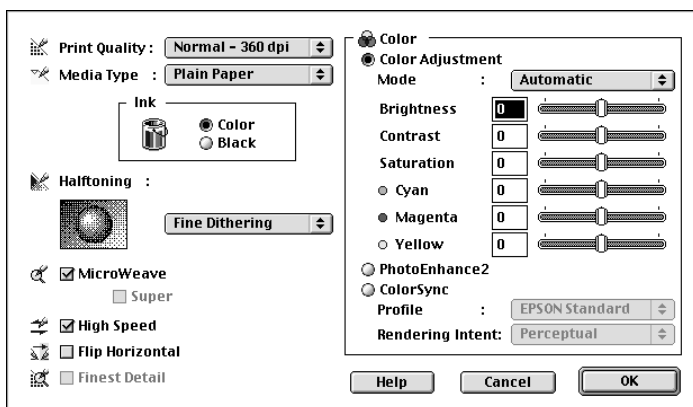

5

Print Quality

The available Print Quality settings are:

SuperFine - 1440 dpi

Select this setting when you want the highest quality output at 1440 dpi. This mode is best for your most important images, so be sure to use this setting only with the highest quality media, such as EPSON Photo Quality Ink Jet Paper.

Fine - 720 dpi

Select this setting when you want high-quality output at 720 dpi. With this setting, be sure to use a high quality media type, such as EPSON Photo Quality media. See page 5-4 for a complete list of EPSON special media.

Normal - 360 dpi

Select this setting for most types of documents. Use this setting for plain paper, EPSON Ink Jet Transparencies, or EPSON 360 dpi Ink Jet Paper. See page 5-4 for a complete list of EPSON special media.

Economy

Select this option for printing rough drafts of text. This setting speeds printing and saves ink by printing fewer dots per character.

Note:

The Print Quality settings limit the availability of Media Type settings. Make the Print Quality settings, before selecting the Media Type.

Media Type

Select the Media Type setting that matches the paper you loaded in the printer. See page 5-4 for details.

Ink

Select Color if your printout includes color. Select Black if you are printing black text only, a draft, or if you want colors to print as varying shades of gray.

Halftoning

No Halftoning

Select this setting when printing text only. Although this setting provides faster printing, it should never be used with color.

Error Diffusion	Select this setting when printing documents that contain detailed graphics or photographic images. Error diffusion blends individual colored dots with the colors of the surrounding dots to create the appearance of natural colors. By blending colored dots, the printer can achieve excellent colors and subtle color gradation.
Fine Dithering	Dithering arranges dots in orderly patterns and is best suited for printing charts, graphs, and other images that require precise, solid areas of bright colors. Select Fine Dithering for images with significant detail but limited shading.

MicroWeave

MicroWeave allows your printer to generate superior output because graphics data is re-ordered and printed in finer increments. This technology reduces the possibility of banding, the light horizontal lines that can mar an image.

Super (MicroWeave) will be selected, depending on other settings as described above. You may want to select Super if your printout still has banding problems even with MicroWeave turned on. However, the printing time is longer when Super is selected.

High Speed

This setting activates bidirectional printing, which reduces the time it takes to print an image. Keep in mind that High Speed should be switched off when high quality is important.

Note:

If vertical lines appear misaligned when High Speed is selected, you may need to align the print heads. For details, see “Aligning the Print Heads” on page 8-34.

Flip Horizontal

This feature inverts an image, printing it reversed left-to-right.

Finest Detail

If you select Fine - 720 dpi as the Print Quality setting, you can turn on Finest Detail to print text and line art with very sharp edges. Be aware that it may take considerably longer to print using this feature and it will increase your Macintosh memory requirements. Additionally, you may not be able to print some larger images, and some patterns may not print correctly. If you experience problems printing with Finest Detail on, turn it off or add more memory.

Color Adjustment

The Color Adjustment settings provide you with a level of control over printed colors that you will not find in many applications.

Mode

There are four color adjustment modes as follows:

Automatic	Analyzes the print data and optimizes color correction for the type of data sent to the printer.
-----------	--

Photo-realistic	Provides output that closely matches the original data. Use this setting for color photographs.
Vivid	Intensifies the colors and lightens the midtones and highlights of an image. Use this setting for presentation graphics, such as charts and graphs.
No Color Adjustment	The printer driver does not enhance the color. Choose this option only when making a ColorSync profile for this printer. When printing normally, choose one of the other modes.

Slide bars

For the settings below, drag the slide bar to the right or left with your mouse or type a value in the box next to the slide bar to adjust a setting. The range varies from -25% to +25%.

Brightness	Changes the overall lightness or darkness of an image.
Contrast	Magnifies or minimizes the difference between the bright or dark parts of an image.
Saturation*	Modifies the vividness of color. Lower saturation produces colors that are dull, and higher saturation produces colors that are rich.
Cyan, Magenta, Yellow*	Adjusts the amount of each of the three primary colors used in color printing.

*for color printing only

PhotoEnhance2

Select this option when printing images taken with a video camera, digital camera, or scanner. EPSON PhotoEnhance2 automatically adjusts the contrast, saturation, and brightness of the original image data to produce sharper, more vivid color printouts. PhotoEnhance2 does not affect your original image data.

When PhotoEnhance2 is selected, other settings are dimmed, meaning you cannot change those settings.

Note:

- PhotoEnhance2 is only available when Color is selected as the Ink option.*
- Printing with PhotoEnhance2 selected may take longer than other settings, depending on your computer system and on the amount of data contained in the image.*

ColorSync

Select ColorSync when matching printed colors with the colors on your screen is important. It automatically adjusts the color range to print colors the way they appear on your screen. There are two settings, Profile and Rendering Intent. See below for details.

To use this feature, make sure you have set the system profile for your monitor. To set your monitor profile, access the ColorSync System Profile utility through the Control Panel and click the Set Profile button. Select your monitor from the list of monitors that appears, and then click Select. Close the dialog box.

Note:

ColorSync is available only when Color is selected.

Profile

Matches the colors in your output with the colors displayed on your monitor. This software provides one profile, EPSON Standard, which is custom-designed to work with your printer. When this option is selected, the printer software uses the profile provided by EPSON.

Some companies may provide other profiles with their products. If installed, these profiles will appear in the Profile list.

Rendering Intent

Transfers the color information using the profile you have chosen from the Profile list.

Perceptual	The best option for reproducing photographs and printouts that are not suited for the other options.
Saturation	The best option for reproducing vivid images. Use this setting for presentation graphics, such as charts and graphics.
Colorimetric	The best option when precise matching of colors is most important, for example, when printing a company logo. Colorimetric attempts to reproduce colors the way the eye distinguishes them. Keep in mind that Colorimetric, or any other color matching method, may not always reproduce colors perfectly, due to differences in the way scanners, printers, and other devices process color data. See Appendix A, “Tips for Color Printing,” for more information.

After making your settings, click OK. Your settings will be applied and you will return to the Print dialog box. To return to the Print dialog box without applying your settings, click Cancel.

Saving your settings

To save your custom settings as a group, follow these steps:

1. Click Save Settings in the Print dialog box. The Custom Settings dialog box appears.

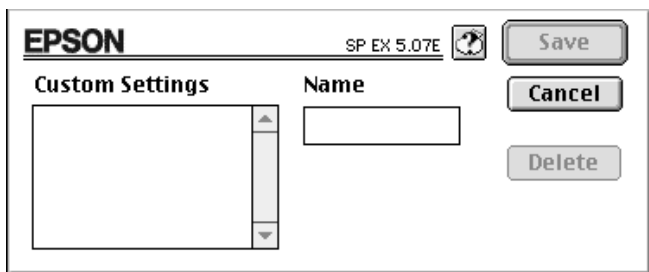

2. Type a unique name (up to 16 characters) for your custom settings in the Name box.
3. Click Save.

You can save up to 10 groups of settings. You can select your saved group of settings from the settings list in the Print dialog box.

Note:

- You cannot use a predefined setting name for your custom settings.*
- To delete a custom setting, select the setting in the Custom Settings dialog box and click Delete.*
- You cannot delete the predefined settings.*

Using your saved settings

To select your settings, click **Advanced** in the **Print** dialog box, then click in the settings list beside the **More Settings** button and select your setting.

If you change the **Media Type** or **Ink** option when one of your customized settings is selected in the settings list, the selection shown in the list returns to **Custom Settings**. The customized setting that was previously selected is not affected by this change. To return to your customized setting, simply reselect it in the list.

Changing the Paper Size

To change the paper size, choose **Page Setup** from the **File** menu of your application. The following dialog box appears:

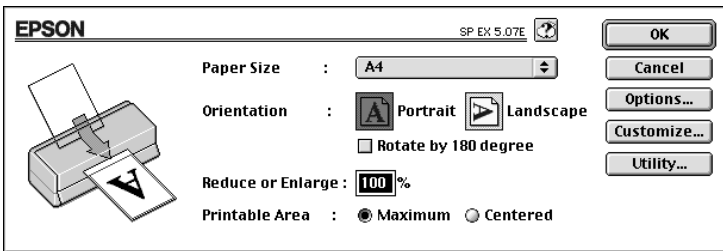

Paper Size

You can select any of the following predefined paper sizes. If you do not see your paper size in this list, see the next page for instructions on defining a custom paper size.



A3	Envelope #10
B4	Envelope C6
A4	Envelope DL
B5	A6 Index card
A5	Index card 5 × 8 in
Letter	Index card 8 × 10 in
Legal	EPSON Photo Paper 4 × 6 in
Executive	Panoramic 210 × 594 mm
Half Letter	Ledger

Note:

Always load paper into the sheet feeder short edge first. Load envelopes flap edge first with the flap side down.

Orientation

Use this setting to specify the direction of printing on the page,

 Portrait or  Landscape.

Rotate by 180 degrees

Select this setting when you want to rotate your document and minimize the blank area at the bottom of your document.

Reduce or Enlarge

Use this setting to reduce or enlarge the size of your image.

Printable Area

Select Maximum to make your printout as large as possible on the paper. Select Centered to position your printout at equal distances from the top and bottom, and the left and right edges.

Defining a Custom Paper Size

If your paper size is not included in the paper size list in the Page Setup dialog box, follow the steps below to define a custom paper size.

1. In the Page Setup dialog box, click **Customize**.
The following dialog box appears:

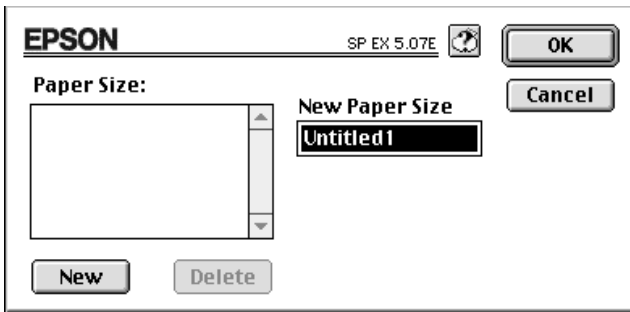

2. To define a new paper size, click **New**. The dialog box changes to allow you to enter a name for the new size.

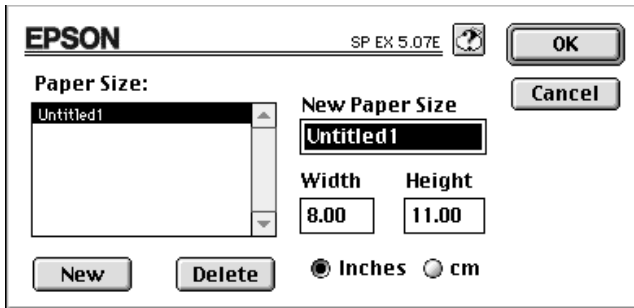

3. Type the paper size name in the **New Paper Size** box.
4. Specify the measurement unit as either **inches** or **cm**.
5. Type in the width and the height.

6. Click OK. You return to the Page Setup dialog box.

You can define up to 8 paper sizes. The paper size names you create will appear in the Paper Size menu in the Page Setup dialog box.

To delete a custom paper size, click Customize in the Page Setup dialog box, select its name from the list in the Custom Paper dialog box, and click Delete.

Modifying the Printout Method and Style

To modify the printout style, click Print on the File menu of your application and click Layout in the Print dialog box.

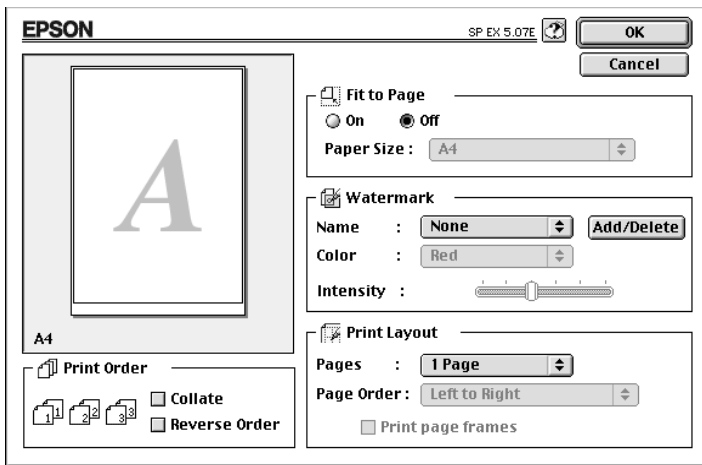

Fit to Page

Selecting this setting proportionally enlarges or reduces the size of the image to make it fit the paper size you selected in the Paper Size list. To use this function, select On and select the size of the paper you loaded in the printer from the list.

Watermark

Selecting this function enables you to print a watermark on the same page you print your document.

Select the watermark you want to print from the Watermark list; then select its color and intensity.

You can also add (or delete) PICT files as custom watermarks to the Watermark list. Follow the steps below to add custom watermarks:

1. Click the Add/Delete button to the right of the Watermark list. The following dialog box appears:

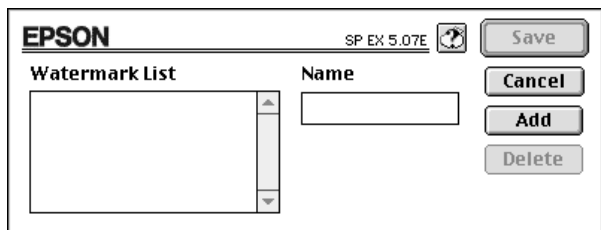

2. Click Add. Select the image file you want to add and click Open.

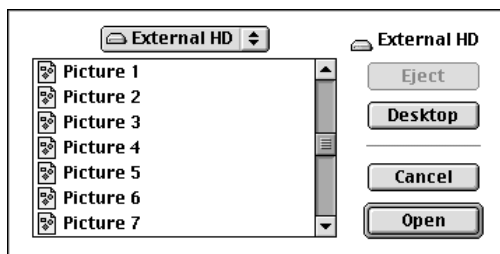

3. Enter a name for the watermark, and click Save.

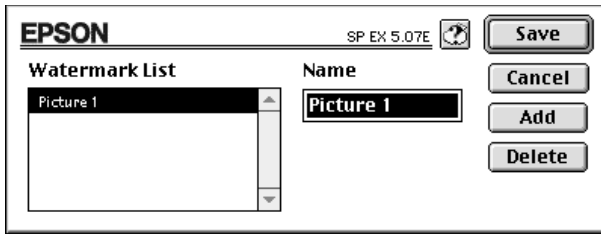

Your custom watermark will appear in the Watermark list.

Print Layout

You can print two or four pages on a sheet of paper by selecting 2 Pages or 4 Pages in the Print Layout box. You can also choose to print a frame around each page on the sheet of paper.

Print Order

You can determine the order in which you print multiple copies of your document; collated (printed a set at a time) or in reverse order.

Using EPSON Printer Utilities

EPSON printer utilities allow you to check the current printer status and do some printer maintenance from your screen. Click Utility in the Print dialog box to view the Utility dialog box:

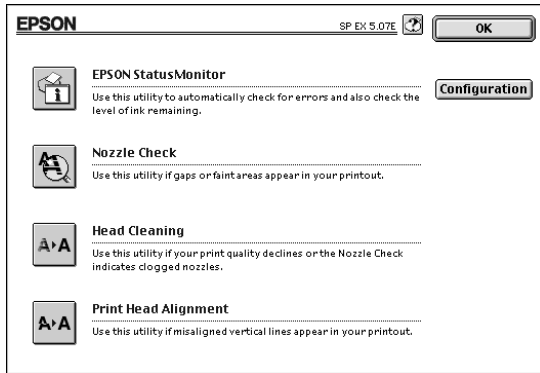

EPSON StatusMonitor

The StatusMonitor utility regularly monitors the printer status. If it detects a printer error, it will inform you with an error message.

You can also use this utility to check how much ink is remaining before printing.

To use the StatusMonitor, click the EPSON StatusMonitor button. The following dialog box appears:

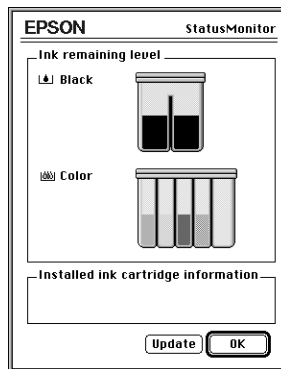

The StatusMonitor checks the amount of ink remaining when opened. To update the ink-level information, click the Update button.

Configuration

Clicking this button displays the Configuration dialog box, where you can choose how the StatusMonitor notifies you in case of an error or if a warning message becomes necessary. You can also choose when the printer status check will be carried out, and you can choose the folders for the temporary spooling of print data and for multiple copy print data storage.

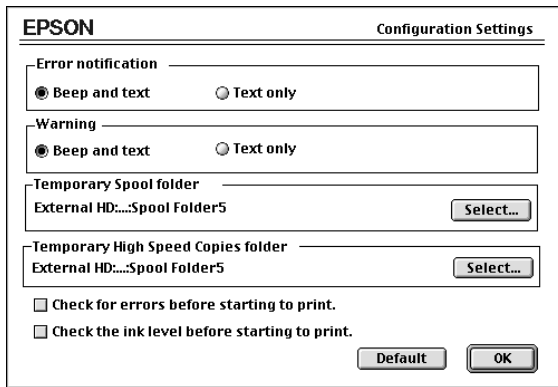

Nozzle Check

You can check the print head nozzles for clogging with this utility. Check the nozzles if you notice a decline in print quality, and also after cleaning to confirm that the print head nozzles have been cleaned. You can access the Head Cleaning utility directly from the Nozzle Check utility.

Head Cleaning

You can clean the print heads with this utility. You may need to clean the heads if you notice a decline in print quality. Before and after print head cleaning, use the Nozzle Check utility to check whether the print heads need to be cleaned (again). You can access the Nozzle Check utility directly from the Head Cleaning utility.

Print Head Alignment

Aligns the print head. Use this utility if you notice your printouts contain misaligned vertical lines while the High Speed setting is turned on in the More Setting dialog box.

Controlling Background Printing

After you send a print job to the printer, you can use the EPSON Monitor3 to check or cancel any print jobs that are queued for printing. This utility also shows the status of the job currently being printed.

To use EPSON Monitor3, you must first turn on Background Printing in the Chooser. Then after sending a print job to the printer, select EPSON Monitor3 from the Application menu at the right end of the menu bar. This opens a dialog box similar to the following:

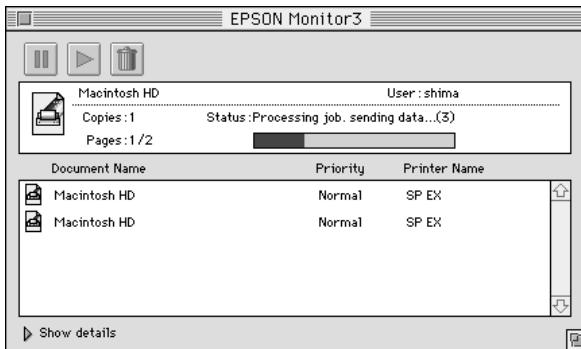

Note:

You can open EPSON Monitor3 by double-clicking the EPSON Monitor3 icon in the Extensions folder.

To pause printing, click the document, and click  at the top of the dialog box. The document name will move to the end of the print queue.

To restart printing the document which you have paused, as described above, click the document, and click  at the top of the dialog box.

To cancel a print job, click the document, and click  at the top of the dialog box.

To prioritize print jobs, follow the steps below.

1. Click the Show details arrow at the bottom of the dialog box. You will see an extended dialog box similar to the one below.

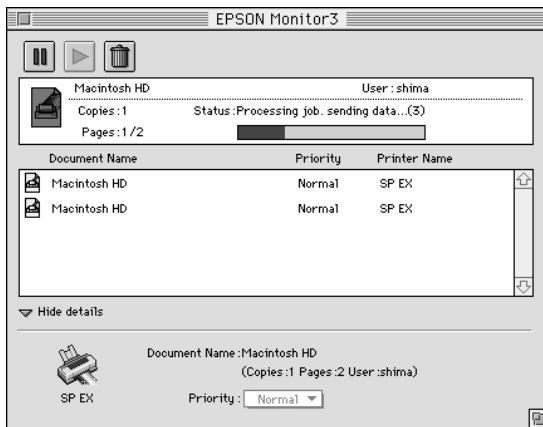

2. Click a document name in the document name box to change its priority.
3. Select Urgent, Normal, or Hold from the Priority list.

Chapter 6

Printing on Special Paper

Choosing Special Paper and Other Media	6-2
About special media cleaning sheets	6-4
Loading Special Paper and Other Media	6-4
Loading Envelopes	6-7
Loading Transparencies	6-8



Choosing Special Paper and Other Media

You can use most plain bond paper with your printer and achieve good results. Coated papers and glossy papers give you better results because they reduce the amount of ink that is absorbed.

You should get good printing results with most types of coated paper. However, print quality can vary depending on the paper quality and the manufacturer. Test the printout quality before purchasing large quantities of paper.

EPSON provides special media such as ink jet (coated) paper, transparencies, glossy paper, glossy film, index cards, and adhesive sheets that are formulated for the inks used in EPSON ink jet printers. EPSON recommends that you use media distributed by EPSON to ensure high-quality results.

The product names of some EPSON media currently on the market may vary depending on when the media was distributed. The following table lists media types whose product names have changed. The media names used in this manual are shown in the “Current name” column, and the former names for the same media are shown in the “Former name” column. The quality and use of this media are the same, regardless of the name on the media packaging.

Coated (Ink Jet) Paper

Former name	Current name
Special Coated Paper for 360 dpi Printing (A4) S041059, S041025 (Letter) S041060 (A3) S041065, S041046	EPSON 360 dpi Ink Jet Paper

Former name	Current name
Special Coated Paper for 720 dpi Printing (A4) S041061, S041026 (Letter) S041062 (Legal) S041067, S041048 (A3) S041068, S041045	EPSON Photo Quality Ink Jet Paper
Special Coated Index Card for 720 dpi Printing (A6) S041054	EPSON Photo Quality Ink Jet Card

Transparencies

Former name	Current name
Transparency Film (A4) S041063 (Letter) S041064	EPSON Ink Jet Transparencies

Glossy Film

Former name	Current name
High Quality Glossy Paper (A4) S041071 (Letter) S041072 (A3) S041073	EPSON Photo Quality Glossy Film

Note:

- The availability of special media varies by country.*
- Since the name on the special media packaging may vary in certain markets, you may need to use the product number to confirm the type of special media you have.*

About special media cleaning sheets

Cleaning sheets packaged with EPSON special media should not be used with this printer. The cleaning function performed by these sheets is not necessary with this printer, and the sheets could jam in the printer.

Loading Special Paper and Other Media

When loading special paper distributed by EPSON, read the instruction sheets packed with your special media first and keep the following in mind:

- ❑ Make sure the printable surface of the paper is face up when loading media into the sheet feeder. See the instruction sheets packed with the media to determine which side is the printable surface. Some media types feature cut corners to help identify the correct loading direction, as shown below.

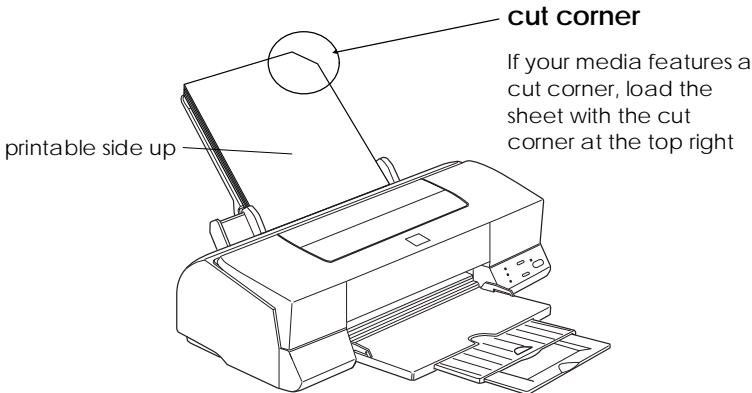

- ❑ Make sure the paper stack fits under the edge guide tab and the arrow mark, both of which are located on the inside surface of the left edge guide. Basic loading capacities for different types of special media are explained below.

EPSON 360 dpi
Ink Jet Paper and Photo
Quality Ink Jet Paper

You can load paper up to the arrow mark on the left edge guide. If you load legal-size ink jet paper, do not load it more than halfway to the arrow mark.

EPSON Photo Quality
Ink Jet Cards

You can load up to 30 index cards. Always place the included support sheet* under the cards when loading them.

EPSON Photo Quality
Glossy Paper

You can load up to 20 sheets. Before loading glossy paper, always put a support sheet* or a sheet of plain paper under the stack of glossy paper.

EPSON Photo Quality
Glossy Film

For best results, you should load glossy film one sheet at a time. If you wish to load multiple sheets of glossy film, load only up to 30 sheets and set the minimum top margin of the page to 30 mm. Before loading glossy film, always put a support sheet* or a sheet of plain paper under the glossy film.

EPSON Ink Jet
Transparencies

You can load up to 10 transparencies. Always put a sheet of plain paper under the stack of transparencies.

EPSON Photo Quality
Adhesive Sheets

You can load one sheet at a time.

Envelopes

You can load up to 10 envelopes. See page 6-7.

EPSON Photo Paper

When you use A4 size paper, you can load up to 20 sheets; while you can load up to 10 sheets when you use ledger, letter, and A3 size paper. Before loading Photo Paper, always put a support sheet* under the stack of Photo Paper.

Photo Stickers

One sheet at a time. Always put a support sheet* under the sticker.

EPSON Panoramic Photo Paper

One sheet at a time.

EPSON Iron-On Cool Peel Transfer Paper

One sheet at a time.

*If a support sheet is packed with the paper, load it underneath the paper, but do not print on it.

- Set the adjust lever to the “+” position when you print on envelopes, or if ink smears on your documents when printing on thick special media. To change the setting, open the printer cover and position the lever as shown below.

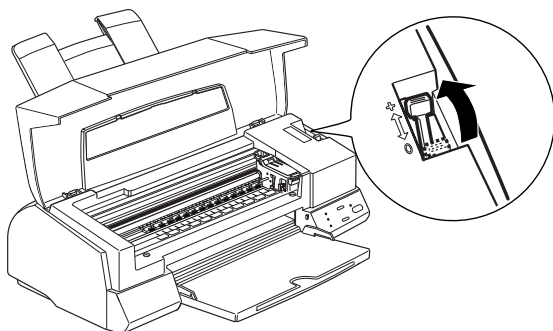

Note:

Return the adjust lever to the “0” position before printing on media of normal thickness. If you leave the lever in the “+” position, this may cause gaps to appear on the printouts when you print on other media.

Loading Envelopes

When printing on envelopes, please note the following:

- ❑ You can load up to 10 envelopes into the sheet feeder.
- ❑ Load envelopes flap edge first with the flap side down, as shown below.

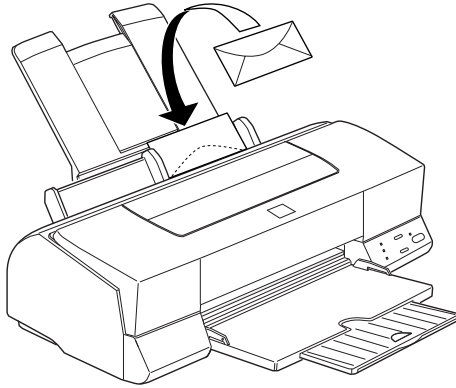

- ❑ Do not use envelopes that are curled or folded, and avoid using envelopes that are too thin; they may curl during printing.
- ❑ Select Plain Paper as the Media Type setting in the printer driver. For more details on making printer driver settings, see online help for Windows, or Chapter 5 for Macintosh.
- ❑ Set the adjust lever to the "+" position before printing on envelopes. To change the setting, open the printer cover and reposition the lever. See the illustration on page 6-6.

Note:

Return the adjust lever to the "0" position, which is the normal position, after you finish printing on envelopes. If you leave the lever in the "+" position, this may cause gaps to appear on the printouts when you print on other media.

Loading Transparencies

When printing on transparencies, please note the following:

- ❑ Always put a sheet of plain paper under the stack of transparencies.
- ❑ You can load up to 10 transparencies.
- ❑ Make sure the printable surface of the paper is face up when loading transparencies into the sheet feeder. See the illustration below.

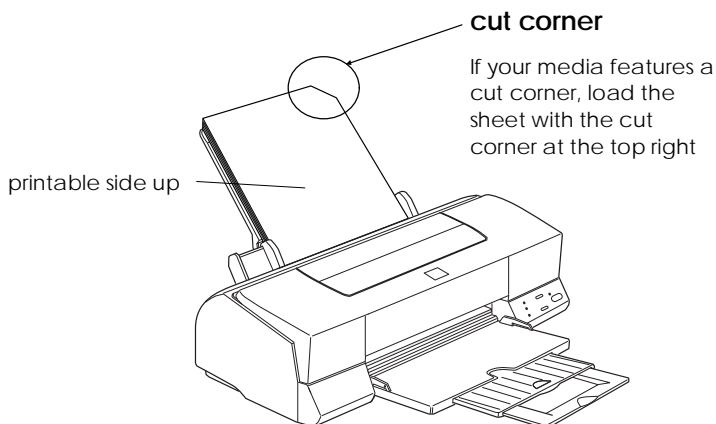

- ❑ Select Ink Jet Transparencies as the Media Type setting in the printer driver. For more details on making printer driver settings, see online help for Windows, or Chapter 5 for Macintosh.

Chapter 7



Maintenance and Transportation

Replacing an Ink Cartridge	7-2
Cleaning the Printer	7-8
Transporting the Printer	7-9

Replacing an Ink Cartridge

The printer's indicator lights will inform you as described below when it is time to obtain a replacement ink cartridge and when it is time to replace an empty cartridge.

Note:

If you need to replace an ink cartridge when the  and  lights are off, see "Ink Cartridge Problems" on page 8-34.

EPSON recommends the use of genuine EPSON ink cartridges. Other products not manufactured by EPSON may cause damage to your printer not covered by EPSON's warranties.

When the  ink out light is

- flashing obtain a replacement black ink cartridge (S020093).
- on replace the empty black ink cartridge.

When the  ink out light is

- flashing obtain a replacement color ink cartridge (S020110).
- on replace the empty color ink cartridge.

Note:





If the ink of one cartridge runs out, you cannot continue printing until you replace it, even if the other ink cartridge still contains ink.



Caution:

- ❑ *Once you remove an ink cartridge, it becomes unusable and cannot be reinstalled even if ink remains in it.*
- ❑ *Leave the old cartridge installed in the printer until you are ready to replace it with a new one. Attempting to print a document or storing the printer without a cartridge installed can damage the printer.*

To replace an ink cartridge, follow these steps.

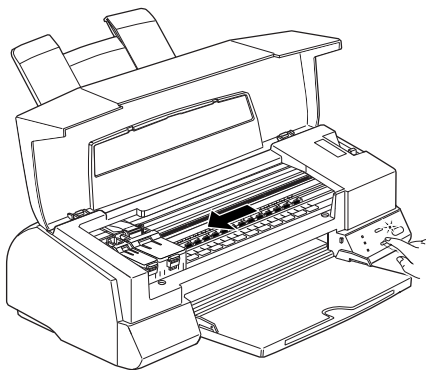

1. Make sure the printer is on. The  power light should be on, but not flashing. Determine which cartridge needs to be replaced, as indicated by the  black and  color ink out lights.
2. Make sure the output tray at the front of the printer is lowered; then open the printer cover.
3. Hold down the  cleaning button for three seconds until the print head moves to the cartridge replacement position on the left-hand side. The  power light flashes when the print head is in position.



Caution:

Do not move the print head by hand. Always use the  cleaning button to move it; otherwise you may damage the printer.

Note:

- *If you press the  cleaning button for three seconds when the  and  ink out lights are off, the printer starts cleaning the print head.*
- *The printer automatically moves the print head back to its home (far right) position after about 60 seconds if you have not started the replacement procedure.*

4. Lift up the clamp that holds the cartridge you want to replace as far as it will go. When you do, the cartridge will rise partly out of the cartridge holder. The following illustration shows color ink replacement. To replace black ink, lift up only the smaller clamp on the left.

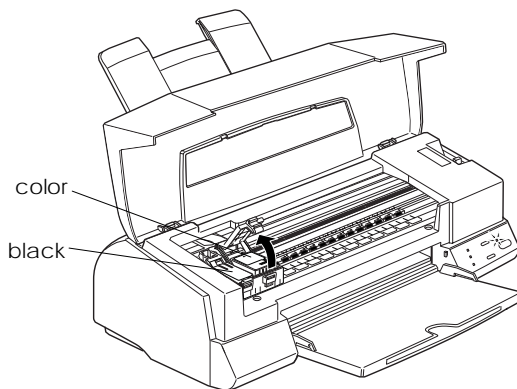

Caution:

Once you open the ink cartridge clamp, the ink cartridge becomes unusable and cannot be reinstalled even if ink remains.

- Lift the cartridge out of the printer and dispose of it according to your local garbage disposal regulations. Do not take the used cartridge apart or try to refill it.



Warning:

If ink gets on your hands, wash them thoroughly with soap and water. If ink gets into your eyes, flush them immediately with water.

- Make sure the replacement ink cartridge is the correct one, color or black. Remove the ink cartridge from its protective bag. Next, remove only the yellow tape seal from the cartridge as shown below.

Do not remove the white portion of the tape

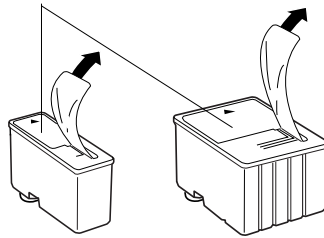

black S020093

color S020110



Caution:

- You must remove the yellow tape seals from the cartridges. If you attempt to print using a cartridge with the yellow tape seal still attached, the cartridge may become unusable. It's OK if the yellow tape does not completely tear off along the dotted line.
- Do not remove the white portion of the tape seal from the top of the cartridge; otherwise, the cartridge may become clogged and you cannot print with it.
- Do not remove the tape seal from the bottom of the cartridge; otherwise, ink will leak.

7. Lower the ink cartridge into the cartridge holder with the label on the cartridge face up and the arrow on the cartridge pointing to the rear of the printer. The larger (color) cartridge goes on the right, the smaller (black) ink cartridge on the left.

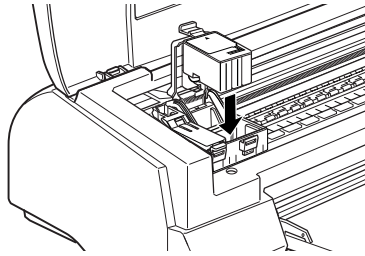

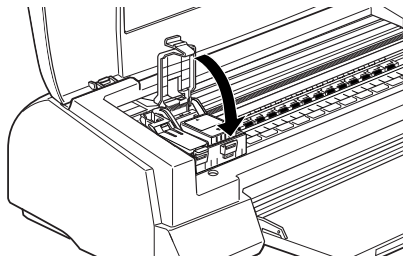

8. Press the ink cartridge clamp down until it locks in place. The following illustration shows color ink replacement. For black ink replacement, press down the smaller clamp on the left.



Caution:

Once you install the cartridges, do not open their clamps again until you replace the ink cartridges; otherwise, the cartridges may become unusable.

9. Press the  cleaning button then close the printer cover. The printer moves the print head and begins charging the ink delivery system. This process takes about two minutes to complete.

When the ink charging process is finished, the  power light stops flashing.



Caution:

The  power light continues to flash while the printer performs the ink charging operation. Never turn off the printer while this light is flashing. Doing so can result in incomplete charging of ink and you will not be able to print with the printer.

Note:

Even if you do not press the  cleaning button, the printer moves the print head and begins the ink charging process about 60 seconds after you replace the ink cartridge.

Cleaning the Printer

To keep your printer operating at its best, you should clean it thoroughly several times a year.

1. Make sure the printer is turned off and all the control panel lights are off. Then unplug the power cord.
2. Remove any paper from the sheet feeder.
3. Use a soft brush to carefully clean away all dust and dirt.
4. If the outer case or the inside of the sheet feeder is dirty, clean it with a soft, clean cloth dampened with mild detergent. Keep the printer cover closed to prevent water from getting inside.
5. If the inside of the printer accidentally gets soiled with ink, wipe it off with a damp cloth.



Warning:

Be careful not to touch the gears inside the printer.



Caution:

- Never use alcohol or thinners to clean the printer; these chemicals can damage the components as well as the case.*
- Be careful not to get water on the printer mechanism or electronic components.*
- Do not use a hard or abrasive brush.*
- Do not spray the inside of the printer with lubricants; unsuitable oils can damage the mechanism. Contact your dealer or a qualified service person if lubrication is needed.*

Transporting the Printer

If you need to transport your printer some distance, carefully repack it using the original box and packing materials as follows:

1. Open the printer cover and make sure that the print head is capped. It is capped when it is in the far right (home) position. If the print head is not capped, turn on the printer; then turn it off again. The print head returns to the home position and is capped. Close the printer cover.



Caution:

Leave the ink cartridges installed when you transport the printer. Removing the cartridges during transport can damage the printer.

2. Unplug the power cord from the electrical outlet; then disconnect the interface cable from the printer.
3. Remove the paper from the sheet feeder and remove the paper support.
4. Push in the output extension tray, and then raise the output tray.
5. Attach the protective materials to the printer.
6. Repack the printer and power cord in the original box.
7. Keep the printer level during transport.

Diagnosing the Problem	8-2
Error indicators	8-2
Status Monitor	8-4
Printer operation check	8-4
Problems and Solutions	8-7
Power supply	8-7
Operation	8-8
Paper handling	8-14
Printing quality	8-17
Printer utilities	8-24
Increasing the Print Speed	8-25
Using DMA transfer (for Windows 95)	8-26
Uninstalling Printer Software (Windows 95)	8-29
Cleaning the Print Head	8-30
Using the Head Cleaning utility	8-30
Using the control panel	8-33
Aligning the Print Head	8-34
Ink Cartridge Problems	8-34
Contacting Customer Support	8-39
For United Kingdom and the Republic of Ireland users	8-39
For Australian users	8-41
For Singapore users	8-43
For Hong Kong users	8-43
For Philippines users	8-44









Diagnosing the Problem

Troubleshooting printer problems is best handled in two easy steps: first diagnose the problem, then apply likely solutions until the problem is fixed. The information that you need to diagnose the most common problems is provided by the printer's control panel lights and by the Status Monitor 2 (Windows 95 only) and the StatusMonitor (Macintosh only) utility. In addition, you can determine whether a problem lies with the printer itself or with the computer by performing a printer operation check.

In "Problems and Solutions" later in this chapter you can find causes and solutions to specific printer problems. Use the information presented in this chapter to pinpoint the source of your problem, then apply the recommended solutions until the problem is solved.

Error indicators

You can identify many common printer problems with the lights on the control panel. If your printer stops working and the lights are on or flashing, use the following table of panel light patterns to diagnose the problem, then follow the recommended corrective measures.

   				Problem and Solution
-	○	-	-	Paper Out
No paper is loaded in the printer.				Load paper in the sheet feeder; then press the  load/eject button to turn this light off. The printer resumes printing.
The paper is not loaded correctly.				Remove and reload the paper; then press the  load/eject button to turn this light off. The printer resumes printing.
-	◌	●	●	Paper Jam
Paper has jammed in the printer.				Take all the paper out of the sheet feeder, reload the paper, then press the  load/eject button. If the light continues to flash, turn off the printer and gently pull out any paper that may be jammed in the printer. If it tears and pieces remain inside the printer, open the printer cover and remove the pieces of paper. Turn on the printer and try again.
-	-	◌	-	Ink Low (black ink cartridge)
The black ink cartridge is nearly empty.				Obtain a replacement black ink cartridge (S020093).
-	-	○	-	Ink Out (black ink cartridge)
The black ink cartridge is empty.				Replace the black ink cartridge with a new one (S020093).
-	-	-	◌	Ink Low (color ink cartridge)
The color ink cartridge is nearly empty.				Obtain a replacement color ink cartridge (S020110).
-	-	-	○	Ink Out (color ink cartridge)
The color ink cartridge is empty.				Replace the color ink cartridge with a new one (S020110).
◌	◌	○	○	Carriage Error
The printer failed.				Press the  power button twice to reset the printer. If the error is not cleared, contact your dealer.
◌	◌	◌	◌	Unknown Printer Error
An unknown printer error has occurred.				Turn off the printer, and after a few seconds turn it on again. If the error is not cleared, contact your dealer.

○ = on, ● = off, ◌ = flashing, - = irrelevant

Status Monitor

If you are using Windows 95 or a Macintosh, you can use the Status Monitor 2 (for Windows 95) or StatusMonitor (for Macintosh) to check the printer's current status. For more details, see page 4-16 (for Windows) or page 5-23 (for Macintosh).

Printer operation check

Performing a printer operation check can help you determine whether the problem comes from the printer or the computer.

- ❑ If the page resulting from operation check appears as shown in step 4 below, this means that the printer itself is all right and that the problem probably lies in the printer software settings, application settings, the interface cable (be sure to use a shielded cable), or the computer itself.
- ❑ If the operation check page does not print satisfactorily, for example, if any segment of the printed lines is missing, there is a problem with the printer. This could be a clogged ink nozzle or a misaligned print head. See "Problems and Solutions" below for possible causes and solutions to the problem, or go directly to "Cleaning the Print Head" on page 8-30.

To perform a printer operation check, follow these steps:

1. Make sure both the printer and computer are turned off.
2. Unlock the wire clips on both sides of the interface connector and remove the ground connector, if necessary. Then disconnect the cable from the printer's interface connector.

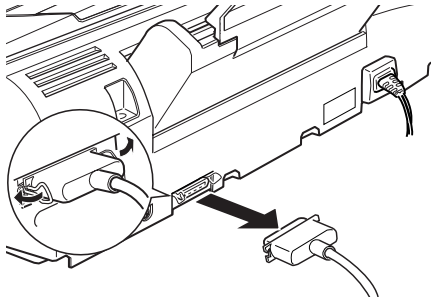



3. Make sure that paper is loaded in the sheet feeder.



Caution:

Use paper at least 182 mm (7.17 inches) wide; for example, A4 size paper loaded short edge first. Otherwise, the print head will spray ink directly onto the platen, which could mar future printouts.

4. Hold down the  load/eject button and press the  power button to turn the printer on. Then release both buttons.

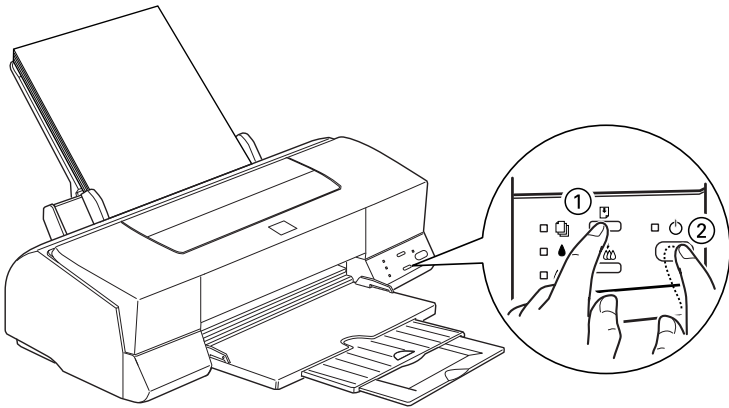

The printer prints an operation check page including the version of your printer's ROM, the ink counter code, character table, and a nozzle check pattern. Here is a typical printout:

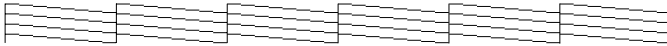

The above sample is in black and white, but the actual test prints in color.

5. Press the  power button to turn off the printer after it finishes printing the operation check page.

Problems and Solutions

This section divides printer problems into five categories:

Power supply	page 8-7
Operation	page 8-8
Paper handling	page 8-14
Printing quality	page 8-17
Printer utilities	page 8-24

Go to the category for the type of problem you have and look for the description that most closely matches the problem. The most likely causes and solutions are listed first, so try them in the order that they are written until the problem is solved.

Power supply

The lights come on briefly but then go off and stay off.

Cause	What to do
The printer's voltage rating may not match the voltage of your electrical outlet.	Check the printer and outlet voltage ratings. If the voltages do not match, unplug the printer immediately and contact your dealer.



Warning:

Do not reconnect the power cord to an electrical outlet that does not have matching voltage.

The printer does not work and the control panel lights are off.

Cause	What to do
The printer is turned off.	Press the ⏻ power button. The ⏻ power light will come on.
The power cord is not properly plugged into the electrical outlet.	Turn off the printer, make sure the power cord is firmly plugged into the electrical outlet, and turn the printer back on.
The electrical outlet is controlled by an outside switch or automatic timer.	Use a different outlet. If you must use electrical outlets controlled by wall switches, do not use the wall switches to control them.
The electric outlet is out of order.	Plug another electrical device into the outlet to determine whether the outlet is working. If it is not, use a different outlet.

Operation

The ⏻ power light is on but nothing prints.

Cause	What to do
The interface cable is not connected properly.	Confirm that the cable is fastened to the printer and the computer securely. If the cable is connected correctly, run a printer operation check as described on page 8-4. If your Macintosh has a built-in modem, connect the interface cable to the Macintosh's printer port.

Your interface cable does not meet both the printer and computer specifications.	Use an interface cable that meets both printer and computer specifications. See “Connecting the Printer to Your PC” or “Connecting the Printer to Your Macintosh” in Chapter 2. Also see “Interface Specifications” in Appendix B.
--	--

Your software is not properly set up for your printer.	Make sure that your printer is properly selected in your software. Install or reinstall the printer software as described in Chapter 2.
--	--

Nothing prints and the control panel lights are on or flashing.

Cause	What to do
Several common printer errors have occurred at once.	Use the table in “Error indicators” on page 8-3 to determine what combination of errors may have occurred, and apply the recommended solutions.

The printer sounds as though it is printing, but nothing prints.

Cause	What to do
The print head nozzles are clogged.	Clean the print head. See “Cleaning the Print Head” on page 8-30. If this does not work after four or five trials, see below.
One or both of the ink cartridges have been used longer than six months or beyond the date on the packaging.	Try cleaning the print head. If that does not solve the problem, replace the ink cartridges as described on page 8-34.

The printer operation check prints well, but nothing prints from within an application program.

Cause	What to do
Your printer is not selected in your software.	Select your printer in the printer setup section of your software.
The interface cable does not meet both the printer and computer requirements.	Use a printer cable that meets the requirements shown under “System Requirements“ on page 1-4.
Your computer is not 100% IBM [®] AT compatible.	Select Use Print Manager for this port in the Queue Setup window. To access this window, click the EPSON Spool Manager4 icon in the EPSON folder (Windows 95) or double-click this icon in the EPSON program group (Windows 3.1), and select Setup from the Queue menu.
Your computer system’s memory is too small to handle the volume of data in your document.	<p>Try reducing the image resolution of your document in your image-editing software.</p> <p>Install more memory in your computer if you can.</p> <p>Select lower resolution or fewer colors for your display setting as described below.</p> <p>For Windows 95, choose a lower resolution setting as the Color Palette setting. To access the Color Palette, click Start, point to Settings, and choose Control Panel. Then double-click the Display icon and click the Settings tab. For detailed information on making this setting, see your Windows 95 user’s guide.</p>

For Windows 3.1, double-click the Windows Setup icon on the Main menu; then click Options and choose Change System Settings. Then choose a lower resolution setting for your display from the Display pop-up list. For detailed information on making this setting, see your Windows 3.1 user's guide.

If you have a display-adapter setting utility, use it to set the lower resolution. For detailed information, see your display board user's guide.

For Macintosh, choose Control Panel from the Apple menu and select Monitors. Select a lower resolution. For detailed information on making this setting, see your Macintosh user's guide.

Color documents print out in black and white.

Cause	What to do
Your printer is not selected in your software.	Select your printer in your software.
Color printing is not selected in your application or in the printer driver.	Select color printing in your application and the printer driver. Try to print again. If the image still comes out in black and white, try printing from another program. If this fixes the problem, contact the manufacturer of the software with which you had trouble.

Printing starts too high or too low on the page.

Cause	What to do
Margins are set incorrectly in your application.	Check that the margins are set correctly in your program. See the printable area specifications on page B-5 in Appendix B.
The size of the paper loaded in the printer does not match the paper size setting within your application program or printer driver.	Load the correct size of paper, or change the paper size settings within your application program or printer driver to match the size of paper you are using.

Print speed is not what you expect.

Cause	What to do
The image resolution and the amount of color used in the document may be too high.	Carefully considering your use of color and resolution can help you optimize your printing times. For more details, see “Increasing the Print Speed” on page 8-25.



Note:

High resolution printing and color printing significantly increase the amount of data to be processed. These two factors have the greatest effect on print speed.

Something on the page is wrong or missing.

Cause	What to do
The printer settings within your application are incorrect.	Adjust the printer settings within your application and print again. If your Macintosh has only one serial port, choose Chooser from the Apple menu and select the  modem port.
The interface cable is not connected properly.	Check that the cable is securely connected to the printer and the computer. If your Macintosh has a built-in modem, connect the interface cable to the Macintosh's printer port.
An unknown problem has occurred.	Disconnect the interface cable from the computer; then try the printer operation check described on page 8-4.

The print head moved to the ink cartridge replacement position unexpectedly.



Cause	What to do
The  cleaning button was pressed while the  or  light was flashing or on.	One or both of the ink cartridges is low or out of ink. Replace the ink cartridges as described on page 7-2.

The New Hardware Found screen appears even though the printer software has already been installed.

Cause	What to do
This error may occur when using Windows 95.	Click the Do not install a driver (Windows will not prompt you again) button; then click OK.

Paper handling

Paper does not feed properly from the sheet feeder.

Cause	What to do
Too many sheets are loaded in the sheet feeder.	Take the paper stack out of the feeder, remove some sheets, and reload the stack. Before you load paper, see page 6-4 to check the amount of paper you can load in the sheet feeder.
The edge guides are not set correctly.	Adjust the guides against the stack of paper. See “Loading Paper” on page 3-2.
Paper is jammed in the paper path.	Take all the paper out of the sheet feeder, reload the paper, then press the  load/eject button. If the  paper out light continues to flash, turn off the printer and gently pull out any paper that may be jammed in the printer. If it tears and pieces remain inside the printer, open the printer cover; then remove the pieces of paper.
The paper stack does not fit under the edge guide tab inside the left edge guide.	Reload the paper so that it fits under the edge guide tab. See “Loading Paper” on page 3-2.
The paper is curled or folded.	Use flat, undamaged paper.
The paper is old or creased.	Use only new, smooth sheets of paper.
The paper’s size is not compatible with the printer.	Use paper that meets the paper requirements for this printer. See “Paper” on page B-2.

The printer loads more than one sheet at a time.

Cause	What to do
Too many sheets are loaded in the sheet feeder.	Take the paper stack out of the feeder, remove some sheets, and reload paper. Before you load paper, see page 6-4 to check the amount of paper you can load in the sheet feeder.
The edge guides are not set correctly.	Adjust the guides against the stack of paper. See “Loading Paper” on page 3-2.
The paper was not fanned before being loaded in the sheet feeder.	Remove the paper stack and fan it. Tap it on a flat surface to even the edges. Then reload the paper.
The edges of the paper stack are not even.	Remove the paper stack and tap it on a flat surface to even the edges. Then reload the paper.
The paper is too thin.	Make sure the paper meets the paper requirements for this printer. See “Paper” on page B-2.

Ejected paper is wrinkled.

Cause	What to do
The paper is damp.	Do not store your paper in a damp or humid environment. Store paper in its original packaging.
The paper is too thin.	Make sure the paper meets the paper requirements for this printer. See “Paper” on page B-2.

Paper does not eject fully.

Cause	What to do
The paper is too long.	Press the  load/eject button to eject the paper. Use paper that meets the paper requirements for this printer. See “Paper” on page B-2.

Paper feed or paper jam problems occur frequently.

Cause	What to do
Sheets of paper are stuck together.	Fan the stack of paper and align the edges before loading.
The paper is too thin or rough.	Make sure the paper meets the paper requirements for this printer. See “Paper” on page B-2.
Too many sheets are loaded in the sheet feeder.	Check the paper package and “Loading Special Paper and Other Media” on page 6-4 for the amount of paper you can load at one time in the sheet feeder.
The printable side of the paper is not correctly loaded.	Try turning the stack of paper over in the sheet feeder. Most packages of paper indicate the printable side with an arrow on the end of the package. Make sure the printable side is loaded face up.

Printing quality

The printed image has gaps or faint areas.

Cause	What to do
The print head nozzles are clogged.	Clean the print head. See “Cleaning the Print Head” on page 8-30.
The paper quality has been degraded due to age.	Use new paper.
The printer driver settings may not be correct.	Select Automatic on the printer driver’s Main menu (Windows) or Print dialog box (Macintosh), and make sure the Media Type setting is appropriate for the type of paper loaded in the printer.

The printed image is blurred.

Cause	What to do
Your paper is damp.	Do not store your paper in a damp or humid environment. Store the paper in its original packaging.
The printer driver settings may not be correct.	Select Automatic on the printer driver’s Main menu (Windows) or Print dialog box (Macintosh), and make sure the Media Type setting is appropriate for the type of paper loaded in the printer.

The printed image is smeared.

Cause

What to do

The paper is too thick.

Open the printer cover and set the adjust lever to the “+” position. See page 6-6 in Chapter 6, “Printing on Special Paper.”

Special paper was loaded without the support sheet or a regular sheet of paper under it though it requires one.

Load the support sheet or a piece of plain paper under the special paper. See Chapter 6, “Printing on Special Paper,” or the instructions packed with your paper.

Multiple sheets of EPSON Photo Quality Glossy Film are loaded.

Load glossy film one sheet at a time with the loading support sheet or a piece of plain paper under it.

If you need to load multiple sheets of glossy film, load only up to 30 sheets with the loading support sheet or a piece of plain paper under them and set the top margin of the page to 30 mm or more.

Ink has leaked on the platen. Use a soft, clean cloth to wipe the area inside of the printer shown below (shaded area).

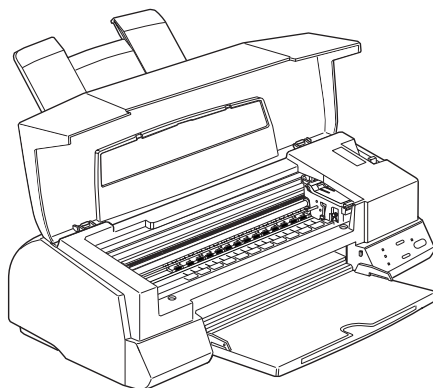



Warning:

Be careful not to touch the gears inside the printer.

The print head nozzles are clogged.

Clean the print head. See “Cleaning the Print Head” on page 8-30.

White horizontal lines appear in the printed image.

Cause	What to do
The Media Type setting in your printer driver is incorrect.	Make sure the Media Type setting matches the type of paper loaded in the printer.
The MicroWeave or Super MicroWeave option in your printer driver is not selected.	Turn on MicroWeave or Super MicroWeave in your printer driver.
One of the ink cartridges is low on ink.	Check the control panel to confirm if the  or  ink out light is flashing, and replace the appropriate ink cartridge.

The print head nozzles are clogged.	Clean the print head. See “Cleaning the Print Head” on page 8-30.
-------------------------------------	---

Vertical printed lines do not align.

Cause	What to do
The print head is misaligned.	Align the print head using the Print Head Alignment utility. See “Aligning the Print Head” on page 8-34.
The printing position is misaligned.	Make sure the High Speed option in your printer driver is not selected.

Printing quality is not what you expect.

Cause	What to do
The paper loaded is not the paper selected in your application or the printer driver.	Make sure you loaded the correct paper in the printer and that you selected the same media type in your application and/or the printer software. Make sure you are using paper that meets the paper requirements for this printer. See “Paper” on page B-2.
You are not printing on the correct side of the paper.	Check the paper packaging for the correct side for printing; then load the printable side of the paper face up in the sheet feeder.

The printer driver settings are not correct.	Check the printer driver settings to make sure they are appropriate. If these settings are correct, check your application because some settings are overridden by application settings. Also, for more information on making printer driver settings, see online help for Windows, or Chapter 5 for Macintosh.
The High Speed setting is selected in the printer driver.	To obtain higher quality output, make sure High Speed is not selected.

Colors are different from what you expect.

Cause	What to do
The color print head nozzles are clogged.	Clean the print head. See “Cleaning the Print Head” on page 8-30.
Black ink is selected in your printer driver.	Set the Ink setting to Color.
The paper is not loaded printable side up.	Check that the printable side of the paper is facing up.
The Media Type setting does not match the paper loaded.	Change the Media Type setting in your printer driver to match the type of media you have loaded.
	Load media that matches the Media Type setting you selected in the printer driver.
The ICM (Windows) or ColorSync (Macintosh) setting in your driver is not appropriate for your document.	Select Automatic as the Mode setting in the printer driver.

Your printer and monitor are not properly calibrated for color matching.	See the user's guides of your image-editing software and your monitor for information on calibrating your system for color matching.
--	--

Since monitors and printers produce colors differently, printed colors will not always match on-screen colors perfectly.	See Appendix A, "Tips for Color Printing."
--	--

Colors are not very vivid.

Cause	What to do
The image was printed on the wrong side of EPSON Ink Jet Paper.	Make sure that you are printing on the coated side of the paper. If necessary, flip over the paper and try printing again. If print quality does not improve, clean the print heads as described on page 8-30.
The Media Type setting does not match the paper loaded.	Make sure the Media Type setting in your printer driver matches the type of media you have loaded, or load media that matches the Media Type setting.

Color dots are missing in printed graphics or characters. The printed color image has gaps or faint areas.

Cause	What to do
The color print head nozzles are clogged.	Clean the print head. See "Cleaning the Print Head" on page 8-30.

**Black dots are missing in printed graphics or characters.
The printed black image is light or faint.**

Cause	What to do
The black print head nozzles are clogged.	Clean the print head. See “Cleaning the Print Head” on page 8-30.

Photographic images look grainy or rough.



Cause	What to do
The printing position is misaligned.	Align the print heads with the Print Head Alignment utility. See “Aligning the Print Head” on page 8-34.
The resolution of the original image data or the resolution setting for the image in your image-editing software may be too low.	<p>Increase the image resolution in your image-editing software. Keep in mind that higher resolution images take longer to print.</p> <p>Use of the EPSON PhotoEnhance or PhotoEnhance2 feature is recommended for printing photographic images. On the printer driver’s Main menu (Windows) or Print dialog box (Macintosh), click the Advanced button and select PhotoEnhance or PhotoEnhance2 from the settings list.</p>

Printer utilities

The Status Monitor window does not appear when you are using Windows 95.

Cause	What to do
The Enable bi-directional support for this printer option is not selected in the Spool Settings window.	You must select Enable bi-directional support for this printer in the Spool Settings window to use the Status Monitor. To access the Spool Settings window, click the Start button, point to Settings, and click Printers. Right-click the icon for your printer and choose Properties from the drop-down menu. Click the Details tab; then click Spool Settings. Select Enable bi-directional support for this printer.

When you clean the print head using the Head Cleaning utility, the output quality does not improve.

Cause	What to do
You attempted to clean the print head while one or both of the ink cartridges were low or out of ink.	Check the  and  ink out lights. When one or both of the ink cartridges are low or out, the Head Cleaning utility has no effect. Replace the ink cartridges as needed. See page 7-2.

Increasing the Print Speed

Just as printing at a high resolution requires more processing time, printing in color takes longer than printing in black because the volume of data in a color document is much greater. For this reason, it is important to be selective in your use of color if you also require a faster print speed.

Even if your document requires the highest resolution and extensive use of color, for example when printing a camera-ready composite that includes color photographs, it may still be possible to optimize the print speed by adjusting other printing conditions. Keep in mind that changing some conditions to increase the print speed may also lower print quality.

The following table shows the factors that inversely affect print speed and print quality (increasing one will decrease the other).

Print quality Print speed	Lower Faster	Higher Slower
Printer software settings		
Print Quality	Economy	SuperFine -1440 dpi
Halftoning	No halftoning	Error Diffusion
High Speed	On	Off
MicroWeave Super	Off	On
Finest Detail	Off	On
Data characteristics		
Image size	Small	Large
Resolution	Low	High

The table below shows the factors related to print speed only.

	Print speed	
	Faster	Slower
Printer software settings		
Ink	Black	Color
Collate*	Off	On
Page reverse*	Off	On
Page rotate*	Off	On
Data characteristics		
Variety of colors	Grayscale **	Full color
Hardware resources		
System speed	Fast	Slow
HDD free space	Large	Small
Memory free space	Large	Small
Software status		
Running applications	One	Many
Virtual memory	Not in use	In use

*Varies depending on the printer software and application software you are using.

**Grayscale means using black ink only to print varying shades of gray, from pure black to pure white.

Using DMA transfer (for Windows 95)

Using DMA transfer to send print data to the computer may help you speed up printing. This is only available for computers that have a parallel port which supports ECP mode. See your computer's manual to determine if it supports ECP mode and DMA transfer.

To make DMA transfer available, see below.

1. Double-click the My Computer icon, double-click the Printer icon, right-click EPSON Stylus Photo EX, and select Property. The printer driver window appears.
2. Click the Utility tab and click the Speed & Progress button on the Utility menu. The Speed & Progress dialog box appears.
3. If a message appears on the Speed & Progress dialog box, compare it with the table below.

Message	Action
High Speed (DMA) Transfer enabled.	DMA transfer is already enabled. Click OK to close the dialog box.
For higher data transfer rates, use DMA Transfer.	Go to step 4.
<No message>	Your system cannot use DMA transfer. However if you change the parallel port setting to ECP or Enhanced using your computer's BIOS Setup program, you may be able to use DMA transfer. Consult your computer's manual or computer maker for instructions. Note: <i>Before you run the BIOS Setup program, uninstall the printer software. After running the Setup program, reinstall the printer software.</i>

4. Double-click the My Computer icon and double-click Control Panel.
5. Double-click the System icon and click the Device Manager tab.
6. Double-click the Ports (COM & LPT) icon and double-click LPT1. If you have connected your printer to a port other than LPT1, double-click the appropriate port icon.

- Click the Resources tab and click the Use automatic settings check box to deselect the Automatic Setting. (Make sure there is no check in the Use automatic settings check box.) Write down the Input/Output Range addresses shown in the Resource settings box.

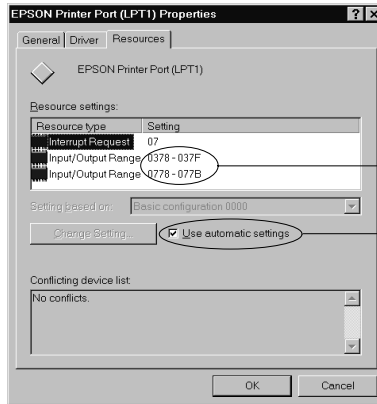

Write down this address.

Click here to uncheck the check box.

- Select a basic configuration setting from the Setting Based on list that uses the same Input/Output Range addresses as you wrote down in Step 7, and make sure the Direct Memory Access channel and Interrupt Request numbers are allocated and displayed. Confirm also that the Conflicting Device list box shows No conflicts.

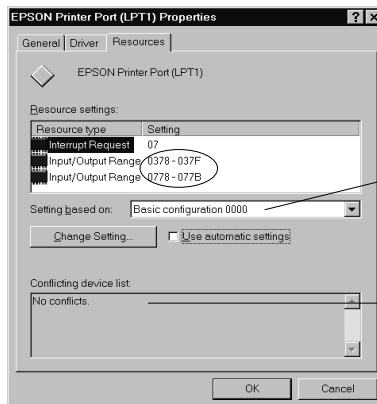

Select a configuration setting.

Confirm there are no conflicts.

9. Click OK to save the setting.
10. Repeat steps 1 and 2 on page 8-27 to verify whether DMA transfer has been enabled.

Note:

You may not be able to use DMA transfer on some computers even after you make the settings explained above. Consult your computer maker for information on the DMA transfer capability of your computer.

Uninstalling Printer Software (Windows 95)

If you need to uninstall the EPSON printer driver and utilities for Windows 95, follow the instructions below.



1. Double-click the My Computer icon and double-click the Control Panel icon.
2. Double-click Add/Remove Programs.
3. Select EPSON Printer Software to uninstall the printer driver, or select EPSON Status Monitor 2 to uninstall the utility.
4. Click Add/Remove. If you are uninstalling printer software, a dialog box appears and you need to select the printer icon for the driver you want to uninstall.
5. Follow the instructions on the screen to uninstall the software.

Cleaning the Print Head

If you find that the printed image is unexpectedly faint, or dots in the printed image are missing, you may be able to solve these problems by cleaning the print head, which ensures that the nozzles are delivering ink properly.

You can clean the print head from your computer using the Head Cleaning utility in the printer software, or from the printer itself by using the printer's control panel buttons.



Note:

- ❑ *Print head cleaning uses ink. To avoid wasting ink, clean the print head only if print quality declines. Use the Nozzle Check utility to confirm that the print head needs to be cleaned.*
- ❑ *If the  black or  color ink out light is flashing or on, you cannot clean the print head. Replace the appropriate ink cartridge first.*

To clean the print head, follow these steps:

Using the Head Cleaning utility

For Windows users:

1. Make sure that the printer is on, and the  and  ink out lights are off.
2. Access the Utility menu as described in Chapter 4. Then click the Head Cleaning button.

3. Follow the on-screen messages.

The  power light flashes while the printer performs the cleaning cycle. This operation takes about two minutes to complete.



Caution:

Never turn off the printer while the  power light is flashing. Doing so may damage the printer.

4. When the  power light stops flashing, click Print nozzle check pattern in the Head Cleaning dialog box and use the pattern to confirm that the head is clean and to reset the cleaning cycle.

Nozzle check pattern:





The above sample is in black and white, but the actual check pattern prints in color.

In the check pattern, if you find that any segments are missing from the test lines, you may need to repeat the head cleaning and print the nozzle check pattern again.



If print quality does not improve after repeating this procedure four or five times, follow the recommendations listed in this chapter. If the print quality still does not improve, contact your dealer.

For Macintosh users:

1. Make sure that the printer is on, and the  and  ink out lights are off.
2. Choose Utility from the Print dialog box. Then click the Head Cleaning button.
3. Follow the on-screen messages.

The  power light flashes while the printer performs the cleaning cycle. This operation takes about two minutes to complete.



Caution:





Never turn off the printer while  power light is flashing. Doing so may damage the printer.

4. When the  power light stops flashing, click the Confirmation button in the Head Cleaning dialog box to print a nozzle check pattern and to reset the cleaning cycle. Use the check pattern to confirm the head is clean. See page 8-31 to see a sample of the nozzle check pattern.

In the check pattern, if you find that any segments are missing from the test lines, you may need to repeat the head cleaning and print the nozzle check pattern again. If print quality hasn't improved after repeating this procedure four or five times, try other recommendations listed in this chapter. If the quality still has not improved, contact your dealer.

Using the control panel

To clean the print head using the control panel buttons, follow these steps.

1. Make sure that the printer is on and the  and  ink out lights are off.
2. Press the  cleaning button for three seconds. The  power light begins flashing, and the printer ejects any paper in the paper path and starts cleaning the print head. This operation takes about two minutes to complete.

**Caution:**

Never turn off the printer while the  power light is flashing. Doing so may damage the printer.

3. After the  power light stops flashing, print a few lines to confirm that the head is clean and to reset the cleaning cycle.

If the print quality does not improve, repeat step 2, then print a few lines to check the output. If print quality does not improve after repeating this procedure four or five times, follow the recommendations listed in this chapter. If the quality still does not improve, contact your dealer.

Aligning the Print Head

Aligns the print head. Use this utility if you notice your printouts contain misaligned vertical lines while the High Speed setting is turned on in the More Setting dialog box.



Caution:

Before using this utility, make sure the paper loaded in the printer is at least 210 mm (8.27 inches) wide; for example, A4 size paper loaded short edge first. Otherwise, the print head will spray ink directly onto the platen, which could mar future printouts.

For Windows users:



1. Make sure A4 or wider paper is loaded in the sheet feeder.
2. Click the Utility tab in the printer software window. Then click the Print Head Alignment button.
3. Follow the messages on your screen to align the print head.

For Macintosh users:

1. Make sure A4 or wider paper is loaded in the sheet feeder.
2. Choose Utility from the Print dialog box. Then click the Print Head Alignment button.
3. Follow the messages on your screen to align the print head.



Ink Cartridge Problems

If output quality does not improve even after cleaning and aligning the print head, you may need to replace one or both of the ink cartridges.

To replace an ink cartridge while the  and  ink out lights are off, follow these steps.



Caution:

- Once you remove an ink cartridge it becomes unusable and cannot be reinstalled, even if ink remains in it.*
 - Leave the old cartridge installed in the printer until you are ready to replace it with a new one.*
1. Make sure the printer is on. The  power light should be on, but not flashing.
 2. Lower the output tray at the front of the printer; then open the printer cover.
 3. Hold down the  load/eject button for three seconds. The print head moves to the replacement position. The  power light begins flashing.

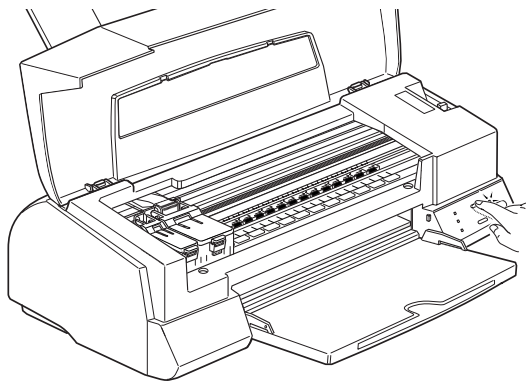

Caution:

Do not move the print head by hand. Always use the  load/eject button to move it. Otherwise you may damage the printer.

Note:

The printer automatically moves the print head back to its home (far right) position after 60 seconds if you have not started the replacement procedure.

4. Lift up the clamp that holds the cartridge you want to replace. When you do, the cartridge rises partly out of the cartridge holder. To replace the color ink cartridge, lift up the larger clamp on the right. To replace the black ink cartridge, lift up the smaller clamp on the left.
5. Lift the cartridge out of the printer and dispose of it according to your local garbage disposal regulations. Do not take the used cartridge apart or try to refill it.



Warning:

If ink gets on your hands, wash them thoroughly with soap and water. If ink gets into your eyes, flush them immediately with water.

- Remove the ink cartridge from its protective bag. Next, remove only the yellow tape seal from the cartridge, as shown below.

Do not remove the white portion of the tape

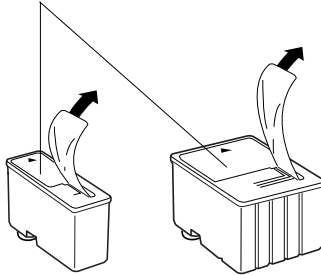

black S020093

color S020110



Caution:

- You must remove the yellow tape seals from the cartridges. If you attempt to print using a cartridge with the yellow tape seal still attached, the cartridge may become unusable. It's OK if the yellow tape does not completely tear off along the dotted line.
 - Do not remove the white portion of the tape seal from the top of the cartridge; otherwise, the cartridge may become clogged and you cannot print with it.
 - Do not remove the tape seal from the bottom of the cartridge; otherwise, ink will leak.
- Lower the ink cartridge into the cartridge holder with the label on the cartridge face up and the arrow on the cartridge pointing to the rear of the printer.

8. Press the ink cartridge clamp down until it locks in place. The following illustration shows color ink replacement. For black ink replacement, press down the smaller clamp on the left.

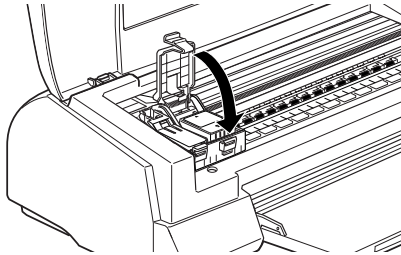

Caution:

Once you install the cartridges, do not open their clamps again until you replace the ink cartridges. Otherwise, the cartridges may become unusable.

9. Press the  load/eject button, then close the printer cover. The printer moves the print head and begins charging the ink delivery system. This operation takes about two minutes to complete.

When the ink charging process is finished, the  power light stops flashing.



Caution:

The  power light continues to flash while the printer performs the ink charging operation. Never turn off the printer while this light is flashing. Doing so can result in incomplete charging of ink and you will not be able to print with the printer.

Note:

Even if you do not press the  load/eject button, the printer moves the print head and begins the ink charging process about 60 seconds after you replace the cartridge.

Contacting Customer Support

If your printer is not operating properly and you cannot solve your problem with the troubleshooting information in this guide and online help, contact customer support services for assistance.

We will be able to help you much more quickly if you are able to give the exact information indicated below.

Serial number of your printer:

(The serial number label is on the back of the printer.)

Printer model:

Brand and model of your computer:

Printer software version:

(See your Version menu.)

Version of Windows (95, 3.1, etc.) you are using now:

Version of software applications you normally use with your printer:

For United Kingdom and the Republic of Ireland users

If you purchased your printer in the UK or the Republic of Ireland, EPSON (UK) Limited provides a range of customer services and technical support.

Note:

For customers in the Republic of Ireland, please use the correct dialing codes when dialing the UK telephone numbers listed in the following sections. For example the Enquiry Desk fax number, 01442 227271, should be dialed as 0044 1442 227271 from the Republic of Ireland.

Enquiry Desk

The enquiry desk team can be contacted by calling 0800 220546 in the UK or 1 800 409132 from the Republic of Ireland, by faxing 01442 227271, and via the Internet at info@epson.co.uk. They can provide the following information:

- Information and literature on new EPSON products (also available from Faxon Epson)
- Where to purchase genuine EPSON consumables, accessories and options

Customer Support

Our Customer Support team can provide the following services:

- Technical information on installing, configuring, and operating your EPSON products
- Arranging for faulty EPSON products to be repaired within the warranty period

For information on contacting our Customer Support team, please see the Service and Support Information booklet that came with your EPSON product.

If this booklet is not available, details can be found on Faxon Epson faxback service, EPtec Bulletin Board Service or on EPSON's World Wide Web site. See below for details.

Faxon Epson

Contact Faxon Epson faxback service for:

- Literature and specifications on the latest EPSON products
- Support information including troubleshooting tips, switch settings and driver information

To use Faxon Epson, call 01442 227332 using a touch-tone phone. You will be asked to follow a simple routine to register your document request, and once you have entered your telephone and fax numbers, Faxon Epson will fax a copy of the document catalogue to your fax machine.

When you have found the documents that you need in the catalogue, call Faxon Epson again and enter the document ID numbers. The documents will be faxed to you automatically.

EPtec - Bulletin Board Service

Call the Epson Bulletin Board Service on 01442 227479 for the latest drivers and utilities. No membership is required. Make sure that your communications software is set to 8 data bits, 1 stop bit, no parity bit, ANSI terminal mode emulation and a modem speed of up to 28.8 Kbps. Downloading protocols supported include Xmodem, Ymodem and Zmodem. See the documentation that came with your communications software and modem for more information.

When you first connect to the Bulletin Board Service, you will be asked for your name, company name, phone number and a password (which you can invent yourself).

World Wide Web

If you can connect to the Internet and have a Web Browser, you can access EPSON's World Wide Web site at <http://www.epson.com>. Here you will find information on the latest EPSON products, software drivers, and answers to frequently asked questions.

For Australian users

EPSON Australia wishes to provide you with a high level of Customer Service. As well as this *User's Guide*, we provide the following sources for obtaining information:

EPSON FAXBACK

EPSON FAXBACK will fax you the latest specifications and pricing for most EPSON products offered in Australia. There is also technical information including details of the latest software and drivers available. Phone (02) 9903 9075 and the system will guide you through a number of choices before faxing the information to your fax machine.

EPSON Bulletin Board System

This is where you can download the latest software and drivers. Visit the BBS to check out the latest versions. If you have a modem, phone (02) 9417 5090.

Internet URL <http://www.epson.com.au>

Access the EPSON Australia World Wide Web pages. Worth taking your modem here for the occasional surf! You can get the same information as offered on the EPSON FAXBACK and the EPSON Bulletin Board plus more.

Your Dealer

Don't forget that your dealer can often help identify and resolve problems. The dealer should always be the first call for advice on problems. They can often solve problems quickly and easily as well as give you advice on the next step to take.

EPSON Helpdesk

EPSON Helpdesk is provided as a final backup to make sure our clients have access to advice. Operators on the Helpdesk can aid you in diagnosing hardware and software problems. They can also advise you on the latest EPSON products and where the nearest dealer or service agent is located. Many types of queries are answered here.

The Helpdesk numbers are:

Phone: (02) 9903 9040
Fax: (02) 9903 9189

We encourage you to have all the relevant information on hand when you ring. The more information you prepare, the faster we can help solve the problem. This information includes the *User's Guide* for your EPSON product, type of computer, operating system, application programs, and any other information you feel is required.

For Singapore users

Contact the telephone and fax numbers below:

Phone: (065) 337-7911
Fax: (065) 334-1185

For Hong Kong users

To obtain technical support as well as other after-sales services, users are welcome to contact EPSON Hong Kong Limited.

Internet home page

EPSON Hong Kong has established a local home page in both Chinese and English on the Internet to provide users with the following information:

- Product information
- Answers to Frequently Asked Questions (FAQs)
- Latest versions of EPSON printer drivers

Users can access our World Wide Web home page at:
<http://www.epson.com.hk>

Electronic bulletin board system

An electronic bulletin board system (BBS) is also available to obtain printer information and the latest versions of printer drivers. You can log on to the following number for the BBS service:

BBS: (852) 2827-4244

Technical Support Hotline

You can also contact our technical staff at the following telephone and fax numbers:

Phone: (852) 2585-4399

Fax: (852) 2827-4383

For Philippines users

To obtain technical support as well as other after sales services, users are welcome to contact the EPSON Philippines Representative Office at the telephone and fax numbers below:

Phone: (632) 813-6552

Fax: (632) 813-6545

BBS: (632) 814-0595

Appendix A

Tips for Color Printing

Basics of Color A-2
Image Resolution and Image Size A-5
Basics of Color Documents A-7



Basics of Color

This section describes the basic properties of color, the relationships between colors, and how to use color to improve the quality of your printed documents.

Properties of color

Color is composed of three properties: Hue, Saturation, and Brightness.

Hue	The name of the color, such as red, blue, or violet. The circle that represents the relationship between all hues is called the hue circle.
Saturation	The vividness of the color. This represents the amount of gray in proportion to the hue.
Brightness	The relative lightness or darkness of the color.

The method for representing these properties is called the Munsell renotation color system. The hue circle and the Munsell renotation color system are useful to understand the properties of color. See also the *Color Guide*.

Synchronizing monitor colors and printer colors

Your printer produces images by printing tiny patterns of ink dots on paper. It uses the colors cyan (C), magenta (M), yellow (Y), and black (K) to create a blending effect that makes you think you are seeing millions of colors. This type of color, produced by pigments that absorb some colors of light and reflect others, is called subtractive.

Note:

In theory, pure cyan, magenta, and yellow should produce black, but actually they produce a muddy brown and must be combined with black ink to produce a true black (K).

Your monitor produces images by illuminating color phosphors on the screen with an electron gun (a phosphor is a substance that gives off light when irradiated). Each screen point (pixel) has three colored phosphors: red (R), green (G), and blue (B).

Since the printer and monitor produce color images differently, and the available range of color produced by the monitor and printer are different, the image on the screen does not exactly match your printed output all of the time. If you want to adjust, or calibrate, the printed color to more closely match the on-screen color, you may have to experiment with the printer driver settings.

Additionally, color management software is available from a variety of software and monitor companies to help you match colors produced by your monitor and printer. See your image-editing software user's guide for information on color matching.

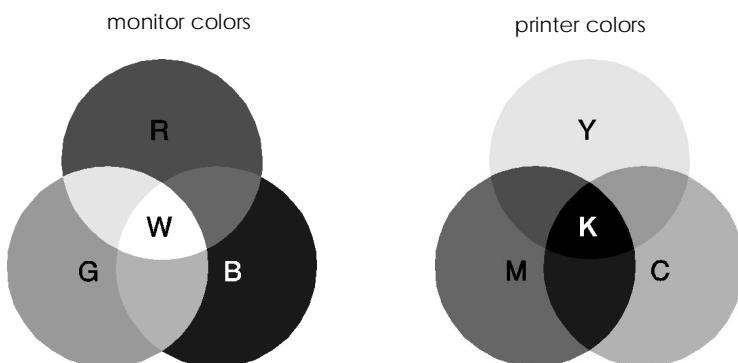

A

The range of colors that can be displayed:

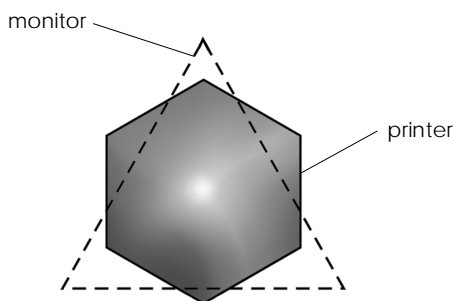

Note:

When printing a scanned image, you may find it more difficult to match colors. Because scanners create the original image data using CMYK, the data format of your image will be changed twice.

Process of color printing

A printer produces color images by printing tiny patterns of ink dots using CMYK colors as mentioned in the previous section. Because most ink jet printers are not able to print different gradations of the three primary colors, they must use a halftoning method in order to represent millions of colors or the gradation of colors as follows:

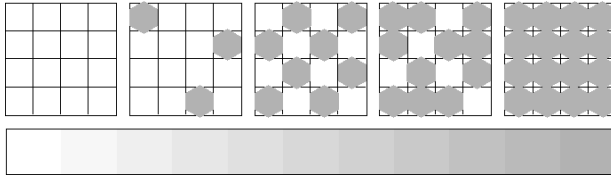

Dithering and error diffusion are the most commonly used halftoning methods.

Dithering

Dithering uniformly aligns individual dots of different colored inks to create the appearance of neutral colors. This method is suitable for printing documents that contain large areas of solid color, such as bar charts and graphs.

Error diffusion

Error diffusion randomly places individual dots of different colors to create the appearance of neutral colors. By randomly placing dots, the printer can achieve excellent colors and subtle color gradation. This method is suited for printing documents that contain finely detailed graphics or photographic images.

Image Resolution and Image Size

The resolution of your original image affects the quality of your printouts. Generally, the higher the resolution, the better the print quality. However, keep in mind that the higher the resolution, the longer the wait for processing and printing a document.

Generally, the printed image size is in inverse proportion to the image resolution, as shown below. The larger the image size, the lower the image resolution. Conversely, the smaller the image size, the higher the image resolution.

Note:

Some applications have a function that can correct this relationship.

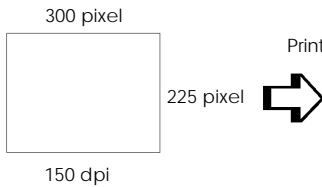

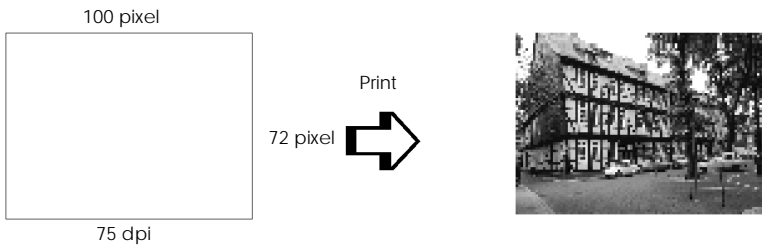
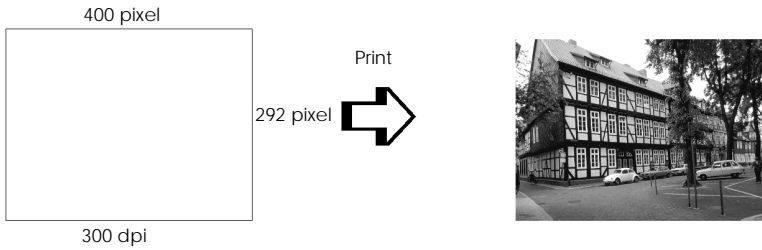

Since increasing the image size means decreasing the image resolution, you must take care that print quality or color tone is not degraded when working with images pasted into documents created with word processing software. To avoid print quality and color tone problems, change the size and the resolution of the image in your graphics application before pasting it into your document.

Basics of Color Documents

To help you use color to maximize your document's impact on its readers, determine the who, what, when, where, why, and how of color printing.

Know WHO your readers are and WHAT your purpose is

Your documents are intended to communicate information, opinions, or feelings to one or more people and also to get results. Therefore, first you need to think about who is going to see your work: customer, co-worker, or other; and what your purpose is: to advise, sell, propose, and so on.

For example:

A marketing proposal with generous quantities of bright, fluorescent colors might fail to impress a conservative accounting firm, yet win over a music video company.

A

Know WHEN to use color

While color can enhance any document, you need to decide when color helps expand understanding of your message and when it distracts the reader. Sometimes a serious business message is best delivered without additional colors (remember that white and black are colors, too).

For example:

A job offer letter to a prospective employee works best in black and white, while a list of safety rules benefits from attention-getting color.

Decide WHERE color will most benefit your document

If you use color on every page or all over a page, you may lose not only the impact of color, but also the clarity and readability of your work. When used consistently and strategically, color breaks up the monotony of black-and-white text reading.

Note:

- Avoid placing too many color pictures, tables, or icons on a page.*
- Size your color images so that they do not overpower text or graphics.*
- Avoid using too much colored text. It is more difficult to read than black-on-white or white-on-black text.*

Know WHY you are using color

Color adds interest and clarity, and makes documents appear easier to understand. Just as you use fonts and graphics to create appeal and capture attention, color provides an additional visual interpretation of a document that influences the reader.

For example:

An overhead presentation of sales results by territory is far more interesting and memorable if you show the figures with colored charts and graphs.

Know HOW to select colors

- Use just one hue in the hue circle to make your document unified. Modify saturation or brightness to add interest.

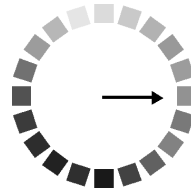

- Use contrasting hues to make your work more eye-catching.

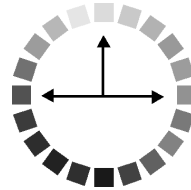

- Use of complementary colors in documents is generally not recommended.

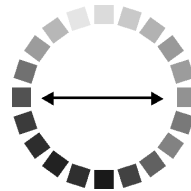

- Determine a rule for using color throughout the document.

Note:

See the Color Guide for the hue circle.

Appendix B

Specifications

Technical Specifications	B-2
Printing	B-2
Paper	B-2
Ink cartridges	B-6
Mechanical	B-7
Electrical	B-8
Environmental	B-8
Initialization	B-9
Safety approvals	B-10
Interface Specifications	B-11
Parallel interface	B-11
Serial interface	B-12



Technical Specifications

Printing

Printing method:	On-demand ink jet
Nozzle configuration	
Black:	32 nozzles
Color:	32 nozzles × 5 (cyan, magenta, yellow, light cyan, light magenta)

Printable columns and printing speeds:

Print quality	Printable width	Available dots	CR speed
180 dpi*	291.1 mm (11.46 inches)	2062	20 ips**
360 dpi	291.1 mm (11.46 inches)	4125	20 ips
720 dpi	291.1 mm (11.46 inches)	8250	20 ips

* dpi stands for "dots per inch".

** ips stands for "inches per second".

Resolution:	Maximum 1440 dpi × 720 dpi
Print direction:	Bidirectional with logic seeking
Control code:	ESC/P Raster

Paper

Note:

Since the quality of any particular brand or type of paper may be changed by the manufacturer at any time, EPSON cannot attest to the quality of any non-EPSON brand or type of paper. Always test samples of paper stock before purchasing large quantities or printing large jobs.

Single sheets:

Size	A3 (297 × 420 mm) B4 (257 × 364 mm) A4 (210 mm × 297 mm) A5 (148 mm × 210 mm) B5 (182 mm × 257 mm) Letter (216 mm × 279 mm) Legal (216 mm × 356 mm) Executive (190.5 mm × 254 mm) Ledger (279 mm × 432 mm) Half Letter (139.7 mm × 215.9 mm)
Paper types	Plain bond paper, special papers distributed by EPSON
Thickness (for plain bond paper)	0.08 mm to 0.11 mm (0.003 to 0.004 inch)
Weight (for plain bond paper)	64 g/m ² (17 lb) to 90 g/m ² (24 lb)

Transparencies, glossy film, glossy paper:

Size	A4 (210 mm × 297 mm) Letter (216 mm × 279 mm) A6 (105 mm × 148 mm)* *Glossy film only
Paper types	Special papers distributed by EPSON

Adhesive sheets:

Size	A4 (210 mm × 297 mm)
Paper types	Special paper distributed by EPSON

Envelopes:

Size	No. 10 (240 mm × 104 mm) DL (220 mm × 110 mm) C6 (114 mm × 162 mm)
Paper types	Plain bond paper, air mail
Thickness	0.16 mm to 0.43 mm (0.006 to 0.017 inch)
Weight	45 g/m ² (12 lb) to 75 g/m ² (20 lb)

Index cards:

Size	A6 (105 mm × 148 mm) 5 × 8 inches (127 mm × 203 mm) 10 × 8 inches (254 mm × 203 mm)
Paper types	Special papers distributed by EPSON

Photo Paper:

Size	A4 (210 mm × 297 mm) Letter (216 mm × 279 mm) 4 × 6 inches (102 mm × 152 mm) Panoramic (210 mm × 594 mm)
Paper types	Special papers distributed by EPSON

Photo Stickers:

Size	A6 (105 mm × 148 mm)
Paper types	Special papers distributed by EPSON

Iron-On Cool Transfer Paper:

Size	A4 (210 mm × 297 mm) Letter (216 mm × 279 mm)
Paper types	Special papers distributed by EPSON

Note:

Poor quality paper may reduce print quality and cause paper jams and other problems. If you encounter problems, switch to a higher grade of paper.

Do not load curled or folded paper.

Special papers distributed by EPSON are only usable under normal conditions:

Temperature	15 to 25°C (59 to 77°F)
Humidity	40 to 60% RH

Printouts on EPSON Photo Quality Glossy Film should be stored under the following conditions:

Temperature	15 to 30°C (59 to 86°F)
Humidity	20 to 60% RH

Printable area:

Single sheets/index cards

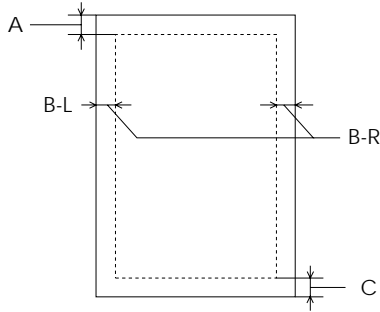

Envelopes

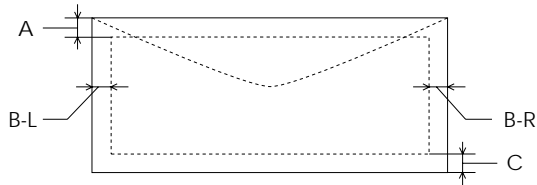

A: The minimum top margin is 3.0 mm (0.12 inch).

When loading multiple sheets of EPSON Photo Quality Film, the minimum top margin is 30 mm (1.2 inches).

B: The minimum left margin is 3.0 mm (0.12 inch).

The minimum right margin for single sheet paper is 3.0 mm (0.12 inch) except for letter and legal size paper. The minimum right margin for letter and legal size paper is 9.0 mm (0.35 inch).

The minimum right margin for envelopes is as follows:

7 mm (0.28 inch) for DL envelopes.

28 mm (1.10 inches) for No. 10 envelopes.

3 mm (0.12 inch) for C6 envelopes.

C: The minimum bottom margin is 14.0 mm (0.54 inch).

Note:

Always load paper into the sheet feeder short edge first. However, envelopes should be loaded long edge first.

Ink cartridges

Black ink cartridge (S020093):

Color	Black
Print capacity*	540 pages/A4 (ISO/IEC 10561 Letter Pattern at 360 dpi)
Cartridge life	2 years from production date if unopened; 6 months if opened, at 25°C (77°F)
Temperature	Storage (installed): -20 to 40°C (-4 to 104°F) 1 month at 40°C (104°F) Storage (uninstalled): -30 to 40°C (-22 to 104°F) 1 month at 40°C (104°F) Transit: -30 to 60°C (-22 to 140°F) 1 month at 40°C (104°F) 120 hours at 60°C (140°F) Freezing:** -15°C (3.2°F)
Dimensions	19.8 mm (W) × 52.7 mm (D) × 38.5 mm (H)

Color ink cartridge (S020110):

Colors	Cyan, Magenta, Yellow, Light Magenta, Light Cyan
Print capacity*	220 pages (A4, 360 dpi, 5% duty each color)
Cartridge life	2 years from production date if unopened; 6 months if opened at 25°C (77°F)
Temperature	Storage (installed) : -20 to 40°C (-4 to 104°F) 1 month at 40°C (104°F) Storage (uninstalled): -30 to 40°C (-22 to 104°F) 1 month at 40°C (104°F) Transit: -30 to 60°C (-22 to 140°F) 1 month at 40°C (104°F) 120 hours at 60°C (140°F) Freezing:** -17°C (-0.4°F)
Dimensions	51.4 mm (W) × 52.7 mm (D) × 38.5 mm (H)

* The print capacity may vary depending on how often you use the print head cleaning function.

** The cartridge will thaw and become usable after approximately 3 hours at 25°C (77°F).



Caution:

- EPSON recommends the use of genuine EPSON ink cartridges. Other products not manufactured by EPSON may cause damage to your printer not covered by EPSON's warranties.*
- Do not use an ink cartridge if the date on the package has expired.*

Mechanical

Paper feed method:	Friction
Paper path:	Sheet feeder, rear entry
Sheet feeder capacity:	100 sheets at 64 g/m ² (17 lb) paper
Dimensions:	Storage Width: 546 mm (21.5 inches) Depth: 262 mm (10.3 inches) Height: 172 mm (6.8 inches)
	Printing (maximum dimensions) Width: 546 mm (21.5 inches) Depth: 788 mm (31.0 inches) Height: 353 mm (13.9 inches)
Weight:	7 kg (15.4 lb) without the ink cartridges

B

Electrical

	120V Model	220–240V Model
Input voltage range	99 to 132V	198 to 264V
Rated frequency range	50 to 60 Hz	
Input frequency range	49.5 to 60.5 Hz	
Rated current	0.4A	0.2A
Power consumption	Approx. 15W (ISO/IEC 10561 Letter Pattern) Approx. 5W in standby mode (120V model) Approx. 5.5W in standby mode (220–240V model)	

This product is also designed for IT power system phase to phase voltage 220-240V.

Note:

Check the label on the back of the printer for the voltage of your printer.

Environmental

Temperature:

Operation: 10 to 35°C (50 to 95°F)

Storage: ^{*}-20 to 60°C (-4 to 140°F)

1 month at 40°C (104°F)

120 hours at 60°C (140°F)

Humidity (without condensation):

Operation: 20 to 80% RH

Storage: ^{*}5 to 85% RH

^{*}Stored in shipping container

Initialization

The printer can be initialized (returned to a fixed set of conditions) in these ways:

Hardware initialization	<ul style="list-style-type: none">* The printer is turned on.* The printer receives an INIT signal from the parallel interface.
Software initialization	<ul style="list-style-type: none">* Software sends a ESC @ (initialize the printer) command.

Hardware initialization

When the printer is turned on, the printer mechanism is initialized and the input data buffer and print buffer are cleared. Printer settings are returned to their default values. However, the printer mechanism is not initialized if the printer is turned on within ten seconds after turning it off. In this case, the printer caps the print head, and ejects any paper in the paper path.

Software initialization

Clears the print buffer and returns printer settings to their default values. However, software initialization does not initialize the printer mechanism or clear the data buffer.

Safety approvals

Safety standards:

U.S. model	UL 1950 with D3, CSA C22.2 No.950 with D3
European model	EN60950 (VDE and NEMKO)

EMC:

U.S. model	FCC part 15 subpart B class B CSA C108.8 class B
European model	EN 55022 (CISPR Pub. 22) class B EN 61000-3-2 EN 61000-3-3 EN 50082-1 IEC801-2 IEC801-3 IEC801-4
Australian model	AS/NZS 3548 class B

Interface Specifications

Your printer is equipped with an 8-bit parallel interface and a serial interface.

Parallel interface

The built-in parallel interface has the following characteristics:

Forward channel

Data format:	8-bit parallel, IEEE-1284 compatibility mode
Synchronization:	$\overline{\text{STROBE}}$ pulse
Handshake timing:	BUSY and $\overline{\text{ACKNLG}}$ signals
Signal level:	TTL compatible
Connector:	57-30360 Amphenol connector or equivalent

Reverse channel

Transmission mode:	IEEE-1284 Nibble mode
Adaptable connector:	57-30360 Amphenol connector or equivalent
Synchronization:	Refer to the IEEE-1284 specification
Handshaking:	Refer to the IEEE-1284 specification
Signal level:	IEEE-1284 Level 1 device
Data transmission timing:	Refer to the IEEE-1284 specification

B

Serial interface

The printer's built-in serial interface is based on the RS-423 standard. This interface has the following characteristics:

Standard:	Based on RS-423
Synchronization:	Synchronous
Bit rate:	Approx. 900K bps
Handshaking:	X-ON/X-OFF and DTR protocol
Word format:	
Data bit	8 bits
Parity bit	None
Start bit	1 bit
Stop bit	1 bit
Connector:	8-pin mini-DIN
Recommended cable:	Apple System Peripheral-8 cable (part number M0197)

Glossary

The following definitions apply specifically to printers.

application

A software program that helps you carry out a particular task, such as word processing or financial planning.

ASCII

American Standard Code for Information Interchange. A standardized coding system for assigning numerical codes to letters and symbols.

banding

The horizontal lines that sometimes appear when printing graphics. This occurs when the print head carriage return is misaligned. See also *MicroWeave*.

bidirectional printing

Printing in which the print heads print in both directions. This increases the speed of printing.

bit

A binary digit (0 or 1), which is the smallest unit of information used by a printer or computer.

brightness

The lightness or darkness of an image.

buffer

The portion of the printer's memory used to store data before printing it.

byte

A unit of information consisting of eight bits.

CMYK

Cyan (blue-green), magenta, yellow, and black. These colored inks are used to create the subtractive system array of printed colors.

ColorSync

Macintosh software that is designed to help you get WYSIWYG (what you see is what you get) color output. This software prints colors as you see them on your screen.

default

A value or setting that takes effect when the equipment is turned on, reset, or initialized.

dithering

A halftoning method in which dots are arranged in an orderly pattern. Dithering works best for printing images with solid colors, such as charts and graphs. See also *Halftoning*.

dot matrix

A method of printing in which each letter or symbol is formed by a pattern (matrix) of individual dots.

dpi

Dots per inch. The dpi measures the resolution. See also *resolution*.

driver

A software program that sends instructions to a computer peripheral to tell it what to do. For example, your printer driver accepts print data from your word processing application and sends instructions to the printer on how to print this data.

economy printing

Printing in which images are printed with fewer dots to save ink.

EPSON PhotoEnhance or PhotoEnhance2

An advanced image enhancement feature developed by EPSON. Selecting PhotoEnhance in your printer driver produces sharper images and more vivid colors by automatically adjusting the contrast, saturation, and brightness of the original image data.

Error Diffusion

This halftoning setting smooths out edges by randomly placing dots of varying colors. This has the opposite effect of the Finest Detail setting.

ESC/P

Abbreviation for Epson Standard Code for Printers. This system of commands gives you control of your printer from your computer. It is standard for all EPSON printers and supported by most application programs for personal computers.

ESC/P Raster

A command language that gives you control of your printer from your computer. Commands in this language produce laser-like features, such as enhanced graphics printing.

Finest Detail

This printer driver setting automatically makes your printed images sharper and clearer. This has the opposite effect of the Error Diffusion setting. Be aware that this may increase the time required for printing.

grayscale

A scale of shades of gray from black to white. Grayscale is used to represent colors when printing with black ink only.

halftones

Patterns of black or colored dots used to reproduce an image.

halftoning

A method of using dot patterns to represent an image. Halftoning makes it possible to produce varying shades of gray using only black dots, or a nearly infinite array of colors using only a few colors of dots.

high speed printing

Printing in which images are printed in both directions. This provides faster printing. This is also called bidirectional printing.

ICM

Image Color Matching. This setting uses the Windows 95 color matching method to match the colors in your printout automatically with the colors displayed on your screen.

initialization

Returns the printer to its defaults (fixed set of conditions). This happens every time you turn on the printer or reset the printer.

ink jet

A method of printing in which each letter or symbol is formed by precisely spraying ink onto paper.

interface

The connection between the computer and a peripheral such as a printer. Generally, printers have two interfaces, parallel and serial. A parallel interface transmits data one byte, or eight bits, at a time. A serial interface transmits data one bit at a time.

IPS

Inches per second. This scale is used to measure the print head speed.

media

Materials upon which data is printed, such as envelopes, plain paper, special paper, and transparency film.

MicroWeave

Printing in which images are printed in finer increments to reduce the possibility of banding and to produce laser-like images. See also *banding*.

monochrome

This means printing with only one color of ink, which is generally black ink.

parallel interface

See *interface*.

power-on functions

These are special functions, such as a printer operation check, that you can perform by holding down a control panel button while turning on the printer.

printable area

The area of a page on which the printer can print. It is smaller than the physical size of the page due to margins.

printer driver

A software program that sends commands for using the features of a particular printer. Often shortened to "driver." See also *driver*.

printer operation check

A method for checking the operation of the printer. When you perform a printer operation check, the printer prints the ROM version, code page, ink counter code, and a nozzle check pattern.

print head alignment

A maintenance procedure you should perform when the black and color inks on your printout are misaligned or the printout seems fuzzy.

print server

The print server acts as a post office for all print jobs sent over a network. It receives the jobs and then distributes them to the assigned printer. It also holds extra print jobs while the printer is busy. See also *print queue*.

print queue

When your printer is busy printing a print job, any additional print jobs sent to the printer are placed in a waiting line, or print queue, until they can be printed. The print queue may be on a network print server, or on your local computer, depending on the computer to which the printer is connected.

RAM

Random Access Memory. The portion of the printer's memory used as a buffer. All data stored in RAM is lost when the printer is turned off.

reset

To return a printer to its defaults either by sending a command, an $\overline{\text{INIT}}$ signal, or by turning the printer off and then back on.

resolution

The number of dots per inch used to represent an image.

ROM

Read Only Memory. A portion of memory that can only be read and cannot be used for data storage. ROM retains its contents when you turn off the printer.

RGB

Red, green, and blue. These colors, in phosphors irradiated by the computer monitor's electron gun, are used to create the additive array of screen colors.

screen pattern

This feature prints shaded areas as they appear on screen, instead of printing them as halftones.

serial interface

See *interface*.

spool

The process by which the printer driver converts the print data into codes that your printer understands. This data is then sent to the printer directly or to the print server.

spool manager

A software program that converts print data into codes that your printer understands. See also *spool*.

status monitor

A software program that allows you to check the printer's status, such as the amount of ink remaining before printing.

subtractive colors

Colors produced by pigments that absorb some colors of light and reflect others. See also *CMYK*.

unidirectional printing

Printing in which the print head prints in one direction only. Unidirectional printing is useful for printing graphics because it allows more precise vertical alignment than bidirectional printing.

WYSIWYG



What-you-see-is-what-you-get. This term is used to describe printout that looks exactly like it appears on screen.

Index

A

- Adjust lever, 1-2, 6-6-7
- Advanced setting
 - Macintosh, 5-6, 5-9, 5-17
 - Windows, 4-6, 4-8. *See also online help*
- Advanced photo setting
 - Macintosh, 5-7
 - Windows. *See online help*
- Alignment, print head, 4-17, 5-25, 8-34. *See also Utilities*
- AppleTalk*, 2-30
- Automatic setting
 - Macintosh, 3-9, 5-2-5
 - Windows, 3-6, 4-2, 4-5-6

B

- Brightness, A-2
- Brightness setting
 - Macintosh, 5-13
 - Windows. *See online help*
- Buttons, 1-2-3
 -  cleaning, 1-3, 8-33
 -  load/eject, 1-3
 -  power, 1-3

C

- Cables. *See Interface cables*
- Cartridges. *See Ink cartridges*
- Chooser*, selecting printer with, 2-29-31
- Cleaning
 - printer, 7-8
 - print head, 8-30-33

- Cleaning sheets, 6-4
- Coated paper, 6-2-3. *See also Special paper*
- Color, tips on using, A-2-8
- Color Adjustment settings
 - Macintosh, 5-12-13
 - Windows. *See online help*
- Colorimetric setting*, 5-15
- Color settings
 - Macintosh, 5-5, 5-12-16
 - Windows, 4-7. *See also online help*
- Color slide bars
 - Macintosh, 5-13
 - Windows. *See online help*
- ColorSync setting*, 5-8, 5-14-16
- Computer requirements, 1-4-6
- Connecting the printer
 - to a Macintosh, 2-25
 - to a PC, 2-11
- Consumable products, 1-6-8
- Contrast setting
 - Macintosh, 5-13
 - Windows. *See online help*
- Control panel, 1-2, 1-3
- Current Settings display
 - Macintosh, 5-6
 - Windows, 4-6
- Customer support, 8-39-44
- Customizing paper size
 - Macintosh, 5-19
 - Windows, 3-7. *See also online help*
- Customizing print settings
 - Macintosh, 5-9-16
 - Windows, 4-8-9

*Macintosh only

†Windows only

Cyan, Magenta, Yellow setting
Macintosh, 5-13
Windows. *See online help*

D

Despooler[†], 4-22. *See also online help*
Dithering, A-4. *See also* Halftoning settings
Driver. *See* Printer driver
Driver disk creation[†], 2-13, 2-19

E

Economy setting
Macintosh, 5-8, 5-10
Windows, 4-7. *See also online help*
See also Print Quality settings
Edge guides, 1-2, 3-3-4
Envelopes
loading, 6-7
printable area, B-5
specifications, B-3
EPSON Answers[†], 2-12
system requirements for, 1-4
EPSON Despooler[†], 4-22
EPSON Monitor3*, 5-25
EPSON PhotoEnhance
Macintosh, 5-14
Windows, 4-7
EPSON Photo Paper, 1-8, 6-5
EPSON special media, 1-7. *See also* Special paper
EPSON Spool Manager[†], 4-23
EPSON Status Monitor
Macintosh, 5-23
Windows, 4-16
EPSON Stylus Printer Driver
Package*, 2-28-29
Error diffusion, A-4

Error Diffusion setting
Macintosh, 5-11
Windows. *See online help*
Error indicators, 8-2-3

F

Fine-720 dpi setting
Macintosh, 5-9
Windows. *See online help*
See also Print Quality settings
Fine Dithering setting
Macintosh, 5-11
Windows. *See online help*
Finest Detail setting
Macintosh, 5-12
Windows. *See online help*
Flip Horizontal* setting, 5-12

G

Glossy film, 1-7, 6-3, 6-5. *See also* Special paper
Glossy paper, 1-7, 6-3, 6-5. *See also* Special paper

H

Halftoning settings
Macintosh, 5-10-11
Windows. *See online help*
Head. *See* Print head
Head Cleaning utility. *See* Utilities
Help, online, 2-12, 4-30
High Speed setting
Macintosh, 5-12
Windows. *See online help*
Hue, A-2

*Macintosh only

[†]Windows only

I

- ICM setting[†], 4-7. *See also online help*
- Image resolution and size, A-5
- Index cards, 1-7, 6-3, 6-5
 - printable area, B-5
 - specifications, B-4*See also Special paper*
- Ink cartridges, 1-7
 - installing, 2-5-10
 - problems with, 8-34-38
 - replacing, 7-2-7
 - specifications, B-6-7
- Ink jet paper, 1-7, 6-4. *See also Special paper*
- Ink low, 1-3, 7-2, 8-3
- Ink out, 1-3, 7-2-3, 8-3
- Ink setting
 - Macintosh, 5-5
 - Windows. *See online help*
- Installing
 - ink cartridges, 2-5-10
 - Macintosh printer software, 2-26-31
 - paper support, 2-4
 - Windows printer software, 2-12-19
- Interface
 - cables, 1-6, 2-11, 2-25
 - parallel, B-11
 - serial, B-12
 - specifications, B-11-12

L

- Lights, 1-2, 1-3
 - black ink out, 1-3, 7-2-3, 8-3
 - color ink out, 1-3, 7-2-3, 8-3
 - 📄 paper out, 1-3, 8-3
 - ⏻ power, 1-3, 8-3
- Loading paper. *See Paper loading*

*Macintosh only

†Windows only

M

- Main menu[†], 4-3-4. *See also online help*
- Maintenance, Chapter 7
- Matching, color, A-2-4
 - Macintosh, 5-12-16
 - Windows, 4-7. *See also online help*
- Media Type settings
 - Macintosh, 5-4-5
 - Windows, 4-10-11. *See also online help*
- MicroWeave setting
 - Macintosh, 5-11
 - Windows. *See online help*
- More Settings dialog box
 - Macintosh, 5-6, 5-9-17
 - Windows, 4-8. *See also online help*

N

- Network printing[†], 2-20-24
- No Halftoning setting
 - Macintosh, 5-10
 - Windows. *See online help*
 - See also Halftoning settings*
- Normal-360 dpi setting
 - Macintosh, 5-10
 - Windows. *See online help*
 - See also Print Quality settings*
- Nozzle Check utility
 - Macintosh, 5-24, 8-30
 - Windows, 4-16, 8-30

O

- Online help[†], 2-12, 4-30
- Options, 1-6
- Orientation setting
 - Macintosh, 5-18
 - Windows. *See online help*
- Output tray, 1-2, 3-2

P

- Page Setup dialog box*, 3-8-9, 5-17-18
- Paper
 - jam, 1-3, 8-3
 - out, 1-3, 8-3
 - specifications, B-2-5
 - support, 2-3, 6-8
 - See also* Special paper
- Paper, matching with Media Type setting
 - Macintosh, 5-4-5
 - Windows, 4-10-11
- Paper loading, 3-2-4
 - See also* Special Paper
- Paper menu[†], 3-6-7, 4-3-4. *See also online help*
- Paper Size settings
 - Macintosh, 5-17-20
 - Windows, 3-6-7. *See also online help*
- Parallel interface. *See Interface*
- Perceptual setting*, 5-15
- PhotoEnhance
 - Macintosh, 5-14
 - Windows, 4-7
- PhotoEnhance setting
 - Macintosh, 5-6
 - Windows. *See online help*
- Photo quality paper, 1-7, 6-4-5. *See also* Special paper

- Photo setting
 - Macintosh, 5-7
 - Windows, 4-7. *See also online help*
- Predefined settings
 - Macintosh, 5-6-8
 - Windows, 4-6-7. *See also online help*
- Print
 - quality, 8-17-23, 8-30-34
 - speed, 8-25-29
- Printable Area setting
 - Macintosh, 5-18
 - Windows. *See online help*
- Printable area specifications, B-5
- Print dialog box*, 3-9, 5-3
- Printer
 - cleaning, 7-8
 - operation check, 8-4-6
 - parts, 1-2
 - stand, 2-4
 - transporting, 7-9
 - unpacking, 2-2
- Printer driver
 - Macintosh, 2-26-29, 5-2-22. *See also* Printer software for Macintosh
 - Windows, 2-12-19, 4-2-14. *See also online help and* Printer software for Windows
- Printer software for Macintosh
 - accessing, 3-8, 5-3
 - advanced setting, 5-2, 5-6, 5-9
 - automatic setting, 5-2-5
 - customized settings, 5-2, 5-9-17
 - installing, 2-26-27
 - predefined settings, 5-2, 5-6-8

*Macintosh only

[†]Windows only

Printer software for Windows
 accessing, 3-5, 4-2-4
 Advanced setting, 4-2, 4-6, 4-8.
 See also online help
 Automatic setting, 4-2, 4-5-6
 customized settings, 4-2, 4-8-9
 installing, 2-12-19
 predefined settings, 4-2, 4-6-7
 See also online help

Printer utilities. *See* Utilities

Print head
 alignment, 8-34-38
 cleaning, 8-30-33

Printing, basics
 Macintosh, 3-8-9
 Windows, 3-5-7

Printing problems. *See*
 Troubleshooting

Print Quality settings
 Macintosh, 5-9-10
 Windows. *See online help*

Print settings
 Macintosh, 5-2-22. *See also*
 Printer software for
 Macintosh
 Windows, 4-2-14. *See also online*
 help and Printer software for
 Windows

Profile setting*, 5-15
Progress meter, 4-21

Q

Quality vs. Speed slide bar
 Macintosh, 5-3
 Windows, 4-5-6. *See also online*
 help

R

Reduce or Enlarge setting*, 5-18
Rendering Intent setting*, 5-15
Replacing an ink cartridge. *See* Ink
 cartridges
Resolution
 image, A-5-6
 printing, B-2
 See also Print Quality settings

S

Safety
 approvals, B-10
 instructions, 1-5
Serial Interface. *See* Interface
Saturation setting
 Macintosh, 5-13, 5-15
 Windows. *See online help*
Self adhesive sheets, 1-7, 6-5
Special media, 1-7. *See also* Special
 paper
Special paper, 1-7, 6-2-3
 cleaning sheets, 6-3
 loading, 6-4-8
Specifications, B-2-12
 electrical, B-8
 environmental, B-8
 ink cartridges, B-6-7
 initialization, B-9
 interface, B-11-12
 mechanical, B-7
 paper, B-2-4
 printable area, B-5
 safety approvals, B-10
Spool Manager[†], 4-23

*Macintosh only

†Windows only

- Status Monitor
 - Macintosh, 5-23
 - Windows, 4-24–29
- SuperFine-1440 dpi setting
 - Macintosh, 5-9
 - Windows. *See online help*
- Super MicroWeave setting*, 5-11
- Super setting (MicroWeave)†. *See online help*
- System requirements, 1-4–5

T

- Text/Graph setting
 - Macintosh, 5-7
 - Windows, 4-7. *See also online help*
- Text setting
 - Macintosh, 5-8
 - Windows, 4-7. *See also online help*
- Transparencies, 1-7, 6-3, 6-5
- Transporting the printer, 7-9
- Troubleshooting, Chapter 8
 - ink cartridges, 8-34–38
 - operation, 8-8–13
 - paper handling, 8-14–16
 - power supply, 8-7–8
 - printing quality, 8-17–23
 - printer utilities, 8-24

U

- Unpacking the printer, 2-2
- User Defined Paper Size dialog box†.
See online help
- Utilities
 - Driver disk creation†, 2-13, 2-19
 - Macintosh, 5-22–25
 - Windows, 4-15–20
- Utility menu†, 4-3–4, 4-15. *See also online help*

*Macintosh only

†Windows only

EPSON OVERSEAS MARKETING LOCATIONS

EPSON AMERICA, INC.

20770 Madrona Ave.
P.O. Box 2842
Torrance, CA 90509-2842
Phone: (800) 922-8911
Fax: (310) 782-5220

EPSON UK LTD.

Campus 100, Maylands Avenue,
Hemel Hempstead, Herts,
HP2 7TJ, U.K.
Phone: (+44) 01442 61144
Fax: (+44) 01442 227227

EPSON DEUTSCHLAND GmbH

Zülpicher Straße 6,
40549 Düsseldorf Germany
Phone: (0211) 56030
Telex: 8584786

EPSON FRANCE S.A.

68 bis, rue Marjolin
92300, Levallois-Perret, France
Phone: 33.1.40.87.37.37
Telex: 610657

EPSON AUSTRALIA PTY. LTD.

70 GIBBES STREET, CHATSWOOD 2067 NSW.
Phone: 2-9903-9000
Fax: 2-9903-9177

EPSON SINGAPORE PTE. LTD.

No. 1 Temasek Avenue #36-00
Millenia Tower, Singapore 039192
Phone: (065) 33 77 911
Fax: (065) 33 41 185

EPSON HONG KONG LTD.

Rooms 4706-10, 47/F,
China Resources Bldg.,
26 Harbour Road, Wanchai, Hong Kong
Phone: 2585-4300
Fax: 2827-7083

EPSON TAIWAN TECHNOLOGY & TRADING LTD.

10F, No. 287 Nanking E. Road, Sec. 3,
Taipei, Taiwan, R.O.C.
Phone: (02) 717-7360
Fax: (02) 712-9164

EPSON ITALIA S.p.A.

V.le F.lli Casiraghi 427
20099 Sesto S.Giovanni
MI, Italy
Phone: 2-262331
Fax: 2-2440750

EPSON IBERICA S.A.

Av. de Roma, 18-26
08290 Cerdanyola del Valles
Barcelona, Spain
Phone: 582. 15.00
Fax: 582. 15.55

SEIKO EPSON CORPORATION**(Hirooka Office)**

80 Harashinden, Hirooka
Shiojiri-shi, Nagano-ken
399-07 Japan

EPSON PORTUGAL, S.A.

R. do Progresso, 471, 1º Perafita
4460 Matosinhos, Portugal
Phone: (02) 996 14 02
Fax: (02) 996 14 11



Color Ink Jet Printer

EPSON
STYLUS™

PHOTO EX

User's Guide