

# EPSON®

Home Theatre Projector

## User's Guide

# EMP-TS10



# About The Manuals and Notations Used

## Types of Manual

The documentation for your EPSON projector is divided into the following four manuals. Refer to the manuals in the order given below.

### ① Unpacking and Installation Guide

This manual contains information on the procedures from unpacking the projector through to starting to use the projector, and also describes the included accessories.

### ② Safety Instructions/ World-Wide Warranty Terms

This manual contains information on using the projector safely, and also includes safety instructions, world-wide warranty terms and a troubleshooting check sheet.

Be sure to read this manual thoroughly before using the projector.

### ③ Setup Guide





This manual describes the preparations required in order to start using the projector (such as remote control preparation and connecting video equipment or a computer).

### ④ User's Guide (this manual)

This *User's Guide* contains information on basic operation, using the projector menus, troubleshooting and maintenance.

## Notations used in this User's Guide

### General information

	Indicates procedures where personal injury or damage to the projector may occur if the procedures are not followed correctly.
	Indicates additional information and points which may be useful to know regarding a topic.
	Indicates that an explanation of the underlined word or words in front of this symbol appears in the glossary of terms. Refer to the Glossary in the Appendix. (p.63)
	Indicates operating methods and the order of operations. The procedure indicated should be carried out in the order of the numbers.

### Meaning of "unit" and "projector"

When "unit" or "projector" appears in the text of this *User's Guide*, they may refer to items which are accessories or optional equipment in addition to the main projector unit itself.

# Contents

Features of the Projector .....	2
<b>Basic Operations</b>	
Turning On the Projector.....	6
Connecting the Power Cord.....	6
Turning On the Power and Projecting Images.....	7
Turning Off the Projector.....	9
Adjusting the Screen Image.....	11
Adjusting the Image Size.....	11
Adjusting the Image Angle.....	11
Correcting Keystone Distortion.....	12
Adjusting the Image Quality.....	14
Focusing the Screen Image.....	14
Selecting the Color Mode.....	14
Selecting the Image Aspect Ratio.....	15
Adjusting Computer Images.....	16
Adjusting the Volume.....	18
<b>Settings and Useful Functions</b>	
Environment Setting Menu Functions and Operations .....	20
Video Menu.....	20
Audio Menu.....	23
Setting Menu.....	23
User's Logo Menu.....	24
Advanced Menu.....	25
About Menu.....	26
Reset All Menu.....	27
Using the Menus.....	28
Useful Functions When a Computer is Connected.....	30
A/V Mute.....	30
Freeze.....	30
E-Zoom.....	31
P in P (Picture in Picture).....	32
<b>Troubleshooting</b>	
Using the Help.....	36
When Having Some Trouble.....	37
When the Indicators Provide No Help.....	39
<b>Appendices</b>	
Maintenance.....	46
Cleaning.....	46
Replacing Consumables.....	47
Saving a User's Logo.....	51
Optional Accessories.....	53
List of Supported Signal Resolutions.....	54
Component Video Input/ RGB Video Input.....	54
Composite Video/ S-Video Input.....	54
Computer.....	55
Specifications.....	56
Appearance.....	58
Part Names and Functions.....	59
Front/ Top.....	59
Control Panel.....	60
Rear.....	61
Base.....	61
Remote Control.....	62
Glossary.....	63
Index.....	65

Basic Operations



Settings and Useful Functions



Troubleshooting



Appendices



# Features of the Projector

## Includes horizontal and vertical keystone correction functions for projecting at an angle

Keystone distortion in the projected image can be easily corrected, not only vertically but horizontally also.

This allows images to be projected correctly even if the projector is not set up directly perpendicular to the screen. (p. 12)

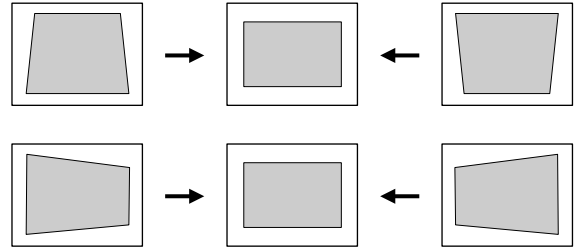

## Compact and lightweight

The projector has a compact body with a footprint the size of an A4 page (274 (D) x 348 (W) x 104 (H) mm (10.79 (D) x 13.7 (W) x 4.09 (H) inches) and is light in weight (approximately 4.2kg (9.3 lbs)).

## Equipped with five color modes

The optimum images can be projected simply by selecting the desired color mode from the following five preset modes in accordance with the images being projected. No complex color adjustments are required.

- Dynamic
- Theatre
- Natural
- PC
- sRGB<sup>™</sup>

(p. 14)

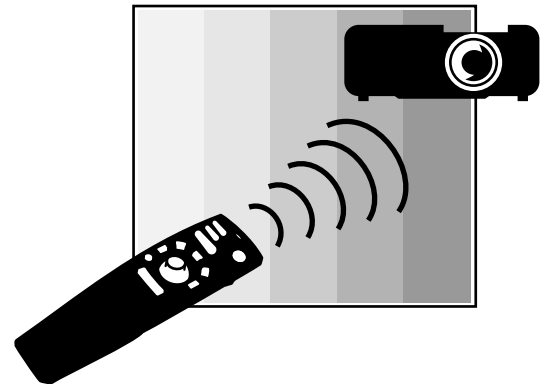

## Brilliant, Attractive Images

Despite its compact size, the projector can display images at high resolutions with a high degree of luminance, providing beautifully clear images even in bright environments.

## Adoption of a short focal-length lens that can project onto 80-inch screens at distances of 2.5m (8.2 ft.)

This lens is ideal for projecting onto large indoor screens. The projector can also project onto 100-inch screens in rooms with an area of about 10 m<sup>2</sup>. (Setup Guide)

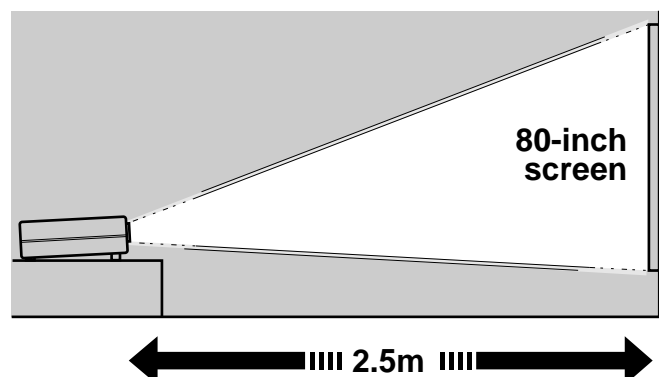





---

# Basic Operations

---

This chapter describes basic operations such as turning projection on and off and adjusting the projected images.

<b>Turning On the Projector .....</b>	<b>6</b>
• Connecting the Power Cord .....	6
• Turning On the Power and Projecting Images.....	7
<b>Turning Off the Projector .....</b>	<b>9</b>
<b>Adjusting the Screen Image.....</b>	<b>11</b>
• Adjusting the Image Size .....	11
• Adjusting the Image Angle .....	11
• Correcting Keystone Distortion .....	12
<b>Adjusting the Image Quality.....</b>	<b>14</b>
• Focusing the Screen Image .....	14
• Selecting the Color Mode.....	14
• Selecting the Image Aspect Ratio.....	15
• For SDTV .....	15
• For HDTV .....	15
• Changing the display position for 16:9 display .....	15
• <b>Adjusting Computer Images .....</b>	<b>16</b>
• Automatic adjustment .....	16
• Adjusting the tracking.....	16
• Adjusting the sync .....	17
• <b>Adjusting the Volume.....</b>	<b>18</b>

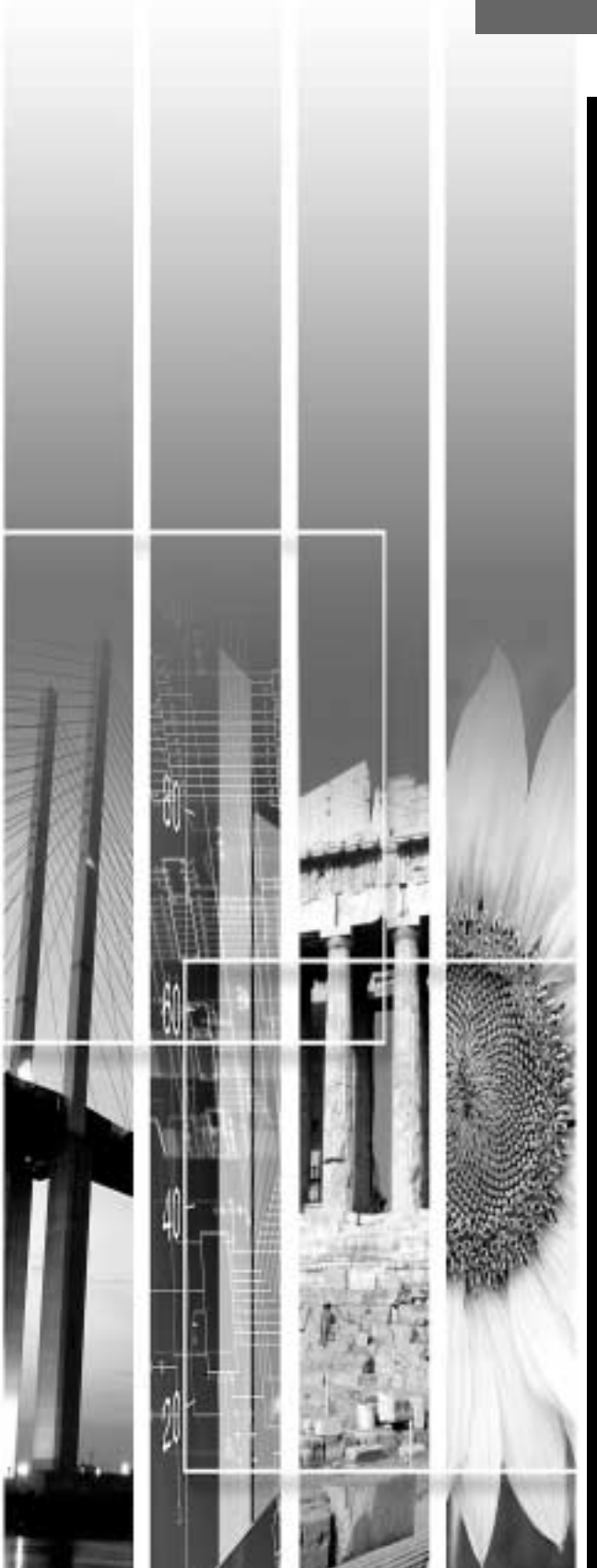

# Turning On the Projector

This section describes the procedure from turning on the power to projecting images.



Be sure to read the separate *Safety Instructions/ World-Wide Warranty Terms* and check the points that must be noted before using the projector to project images.

## Connecting the Power Cord

### Procedure

1

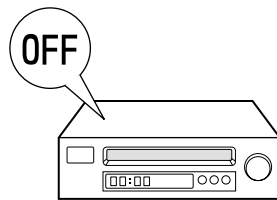

Check that the power is turned off for all components connected to the projector.

2

Connect the computer or other video source to the projector.

(*Setup Guide*).

3

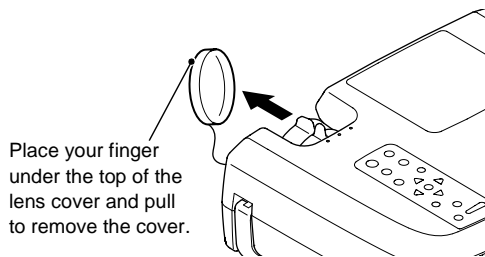

Remove the lens cover.

4

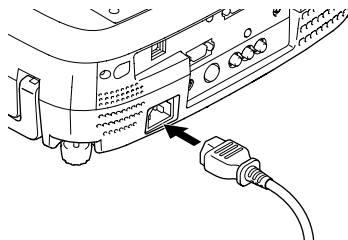

Connect the accessory power cord to the projector.

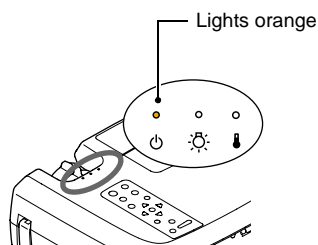

Check that the power cord connector is facing the same way as the power inlet on the projector, and then insert the power cord connector securely into the projector.

5



Connect the other end of the power cord to a grounded electrical outlet.

Wait until the  indicator lights orange.

 The buttons on the projector's control panel and remote control cannot be operated while the  indicator is flashing orange. Wait until it lights steadily.



## Turning On the Power and Projecting Images

### Procedure

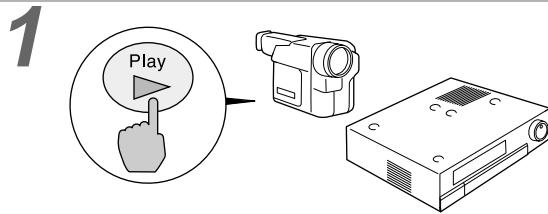

**1 Turn on the power for all equipment connected to the projector.**

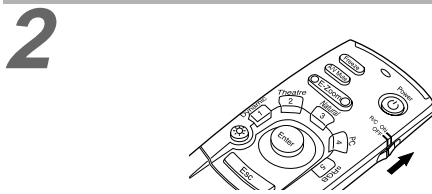

For a video source, press the [Play] button at the video source to start playback if necessary. Check that the  indicator on the projector has stopped flashing and lights orange.

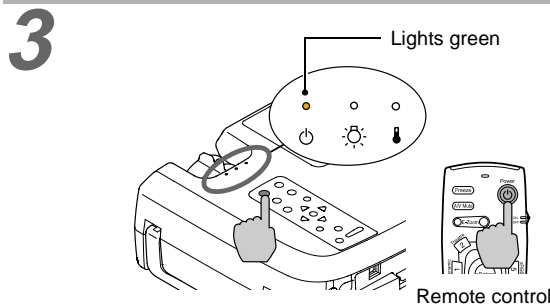

**2 When using the remote control, set the R/C switch on the remote control to ON.**



**3 Press the [Power] button on either the remote control or the projector's control panel to turn on the power for the projector.**

The  indicator flashes green, and after a short period projection starts. Check that the  indicator has stopped flashing and lights green. (This takes approximately 30 seconds.)



The buttons on the remote control and the projector's control panel cannot be operated while the  indicator is flashing green. Wait until it lights steadily. The message "No-Signal." may appear depending on the projector's menu settings. (p.24)

**4 If more than one signal source has been connected, use the remote control or control panel buttons to select the port which the signal source that you would like to use is connected to, while referring to the following table.**

Port	Button to press		Display at bottom-left of screen *
	Control panel	Remote control	
Computer1	[Computer/YCbCr▶▶]	[Comp1]	Computer1(Digital-RGB) Computer1(Analog-RGB) Computer1(RGB-Video)
Computer2/Component Video		[Comp2/YCbCr]	Computer2(Analog-RGB) Computer2(RGB-Video) Computer2(YCbCr) Computer2(YPbPr▶▶)
S-Video	[Video]	[S-Video]	S Video
Video		[Video]	Video

\*The display disappears after 3 seconds.



- If only one signal source has been connected, the signals from that source will be projected without needing to press one of the buttons from the previous table.
  - If the "No-Signal." message does not disappear, check the connections again.
  - If a laptop computer or a computer with an LCD screen has been connected to the projector, the images may not be projected straight away. After making the connections, check that the computer has been set up to output signals.
- The following table shows examples of how to toggle output settings. For details, refer to the section of the documentation provided with your computer under a heading such as "External output", "Connecting an external monitor" or similar.

NEC	Panasonic	Toshiba	IBM	Sony	Fujitsu	Macintosh
[Fn]+[F3]	[Fn]+[F3]	[Fn]+[F5]	[Fn]+[F7]	[Fn]+[F7]	[Fn]+[F10]	After startup, change the Control Panel adjustments so that Mirroring is active.

# Turning Off the Projector

Follow the procedure below to turn off the power of the projector.

## Procedure

1

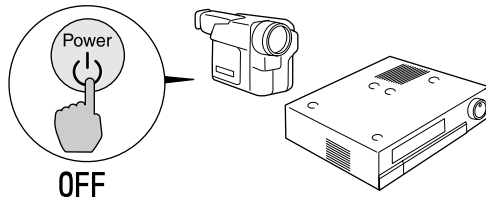

**Turn off the power for the signal sources that are connected to the projector.**

Check that the power for all connected components has been tuned off.

2

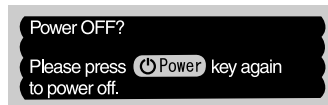

**Press the [Power] button on either the remote control or the projector's control panel.**

The confirmation message shown left will appear. If you do not wish to turn off the power, press any other button.

If you do not press any button, the message will disappear automatically after 7 seconds (the power will not turn off).

3

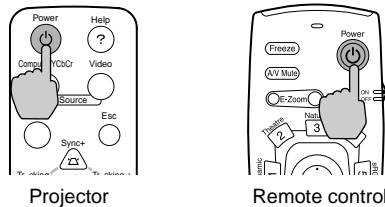

**Press the [Power] button once more.**

The lamp unit will turn off and the  indicator will flash orange as the cool-down period starts.

4

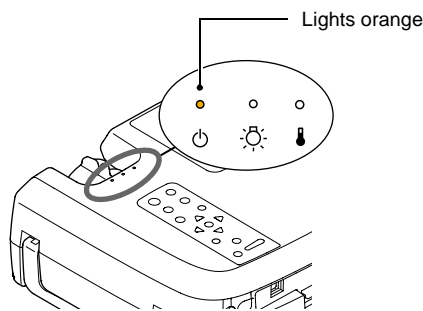

**Check that the  indicator has changed to light orange.**

When the  indicator lights orange, cool-down is complete.

The cool-down period lasts for approximately 2 minutes. (This varies depending on factors such as the ambient air temperature.)



The buttons on the projector's control panel and remote control cannot be operated while the  indicator is flashing orange. Wait until it lights steadily.

5

**If not using the projector for long periods of time, disconnect the power plug from the electrical outlet.**



Do not disconnect the power cord from the outlet while the  indicator is still flashing orange. If you disconnect the power cord while the indicator is still flashing, it may result in errors in projector operation and reduce the lamp unit operating life.

6

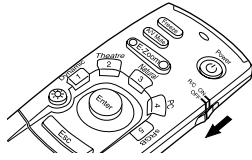

**Set the R/C switch on the remote control to the OFF position.**



If you leave the R/C switch at the ON position, the remote control will continue to consume battery power. Move the R/C switch to the OFF position when not using the remote control.

7

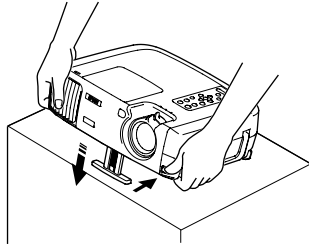

**Retract the front adjustable foot if it is extended.**

Gently push down on the projector while pressing the foot adjust button.

8

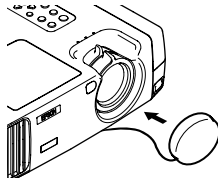

**Attach the lens cover.**

Attach the lens cover to the lens when not using the projector, in order to stop the lens from getting dusty or dirty.

# Adjusting the Screen Image

You can adjust the screen image in order to obtain the best possible picture.

## Adjusting the Image Size

The size of the projected image is basically determined by the distance from the projector to the screen. (*Setup Guide*)

The following procedures explain how to adjust the screen image once the projector itself has been set up.

### Procedure

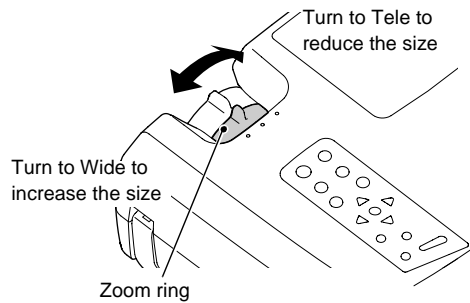

### Turn the zoom ring on the projector to adjust the image.

The image can be enlarged in this way to 1.35 times the normal size.

If you would like to enlarge the image further, move the projector further away from the screen. (*Setup Guide*)



If a computer is connected, you can press the [Resize] button on the projector's control panel or on the remote control to switch between the real display and resized display.

- Resized display (default):  
The images are processed so that they automatically fill the whole of the projection area, regardless of the resolution setting.
- Normal sized display (window display):  
The images are projected at the same resolution that they are input. The image size and the projection area may be different depending on the resolution.

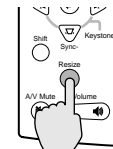

Projector

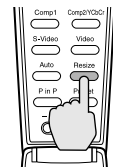

Remote control

## Adjusting the Image Angle

The projector should be as perpendicular to the screen as possible.

Seen from the side

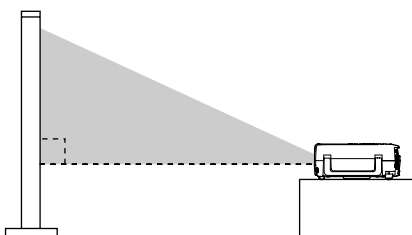

Seen from above

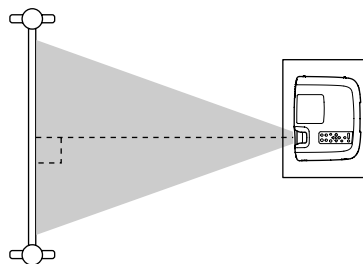

If the projector cannot be set up so that it is exactly perpendicular to the screen, it can be set up so that it is tilting slightly horizontally or vertically. To tilt the projector upward, adjust the front adjustable foot to tilt the projector at an angle of up to a maximum 12°.

### Procedure

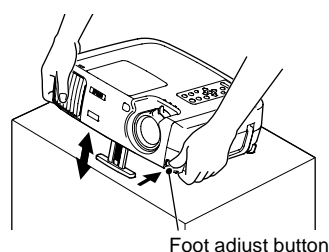

### While pressing the foot adjust button, lift up the front of the projector so that the front adjustable foot can extend.

Extend the front adjustable foot until the desired angle is obtained, and then release the foot adjust button.

To retract the foot, press and hold the foot adjust button and gently lower the projector.

 • When the foot is adjusted, it may cause the projected images to become distorted. Use the keystone correction function to adjust this distortion.

• If the projector is tilted horizontally, turn the rear adjustable foot to adjust the angle.

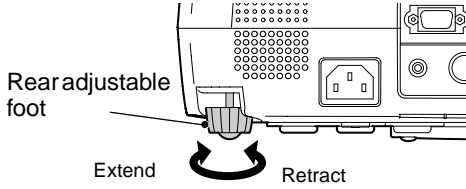

Rearadjustable foot

Extend Retract

### Correcting Keystone Distortion

When the projector is set up at an angle, keystone distortion may appear in the projected images. If the projector is adjusted to within a range of approximately 30° vertically or 10° horizontally, the keystone correction function can be used to adjust this keystone distortion.

The values given here are for when the image is at the smallest zoom setting (telephoto). The maximum angles will be smaller if the zoom setting has been increased in the wide angle direction. Furthermore, if the projector has been tilted both vertically and horizontally, the maximum adjustable angle will again be smaller than the maximum angle if the projector had been tilted in only one direction.

- When tilted vertically

Approx. 30° above

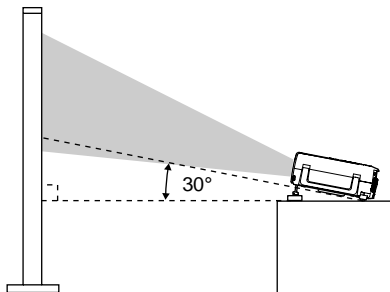

Approx. 30° below

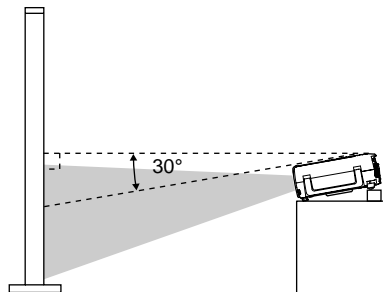

- When tilted horizontally

Approx. 10° to the right

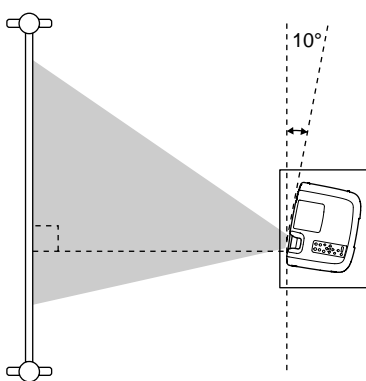

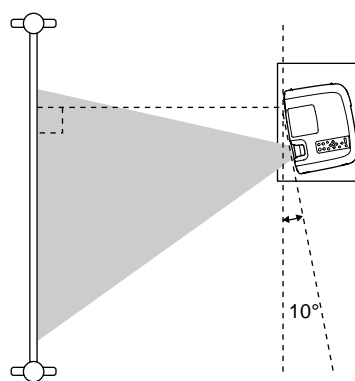

Approx. 10° to the left

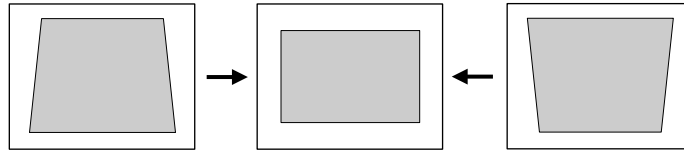

**Procedure**

## Correcting vertical keystone distortion



Press the  or  button on the projector's control panel to adjust.

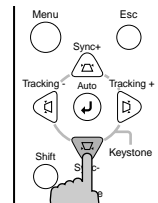

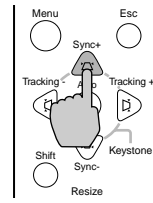

Projector

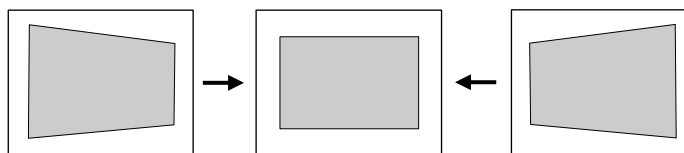

Projector

## Correcting horizontal keystone distortion



Press the  or  button on the projector's control panel to adjust.

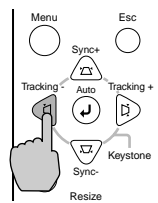

Projector

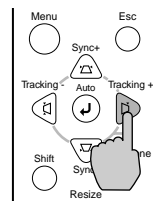





Projector

Procedure to follow if using both horizontal and vertical keystone correction:

1. With the front adjustable foot retracted, set the projector so that it is fully horizontal.
2. Extend the front adjustable foot to adjust the angle as necessary.
3. Adjust the vertical keystone distortion until both sides of the picture are vertical.
4. Adjust the horizontal keystone distortion until the top and bottom edges of the picture are both horizontal.



- When keystone correction is carried out, the projected image will become smaller.
- The keystone correction settings are memorized, so that if you change the position or angle of the projector, you may need to readjust the keystone correction settings.  
To return a previous keystone correction to the initial setting, carry out the following operations.  
To initialize vertical keystone correction: While holding down the  button, press the  button for 1 second or more.  
To initialize horizontal keystone correction: While holding down the  button, press the  button for 1 second or more.
- If there is any noticeable irregularity in the projected images after keystone correction has been carried out, reduce the sharpness. (p.21, 22)
- Keystone correction can also be carried out using the projector's environment setting menu. (p.23)
- If you carry out both horizontal and vertical keystone correction, the correction range will become smaller than it would be if only one type of correction was carried out.
- If the value displayed in the gauge on the screen stops changing when horizontal or vertical keystone correction is being carried out, it indicates that the limit for horizontal or vertical keystone correction has been exceeded. Check that the projector has not been set up at an angle which exceeds the proper limit. (p.12)
- If the horizontal (or vertical) keystone correction function is used at the same time that the E-Zoom or P in P function is being used, the keystone correction amount may change when the E-Zoom or P in P function is operated while the keystone correction amount is near the limit value.
- The limit value for keystone correction will vary depending on the image signal being input.

# Adjusting the Image Quality

The quality of the screen images can be adjusted as follows.

## Focusing the Screen Image

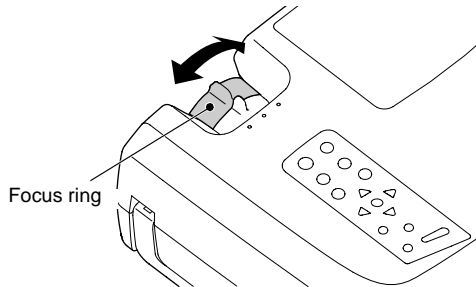

Turn the focus ring to adjust the image focus.



- If the surface of the lens is dirty or misted over as a result of condensation, it may not be possible to adjust the focus correctly. If this happens, clean or de-mist the lens. (p.46)
- If the distance from the projector to the screen is less than 0.9 m (3.0 ft.), the focus will not be correct. Check the distance between the projector and the screen.

## Selecting the Color Mode

The following five color modes have been preset for use with images with varying characteristics. You can use these color modes to obtain the optimum image quality easily, just by selecting whichever color mode best suits the images. The brightness of the projected images will vary depending on the mode.

Mode name	Use
Dynamic	Ideal for projecting images with greater modulation and intensity.
Theatre	Ideal for enjoying presentations such as movies which have large numbers of dark scenes.
Natural	Ideal for enjoying presentations in a natural atmosphere.
PC	Ideal for use in making images as bright as possible when projecting computer images.
sRGB ▶	Images conform to the sRGB standard. If the connected video source has an sRGB mode, set both the projector and the video source to sRGB.

### Procedure

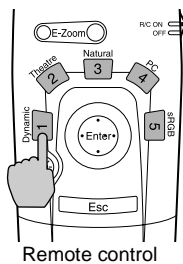

Press buttons [1] to [5] on the remote control to select the color mode.



The color mode setting can also be changed using the Color Mode command of the projector's Video menu. (p.21, 22)



## Selecting the Image Aspect Ratio

This function changes the aspect ratio of video images from 4:3 to 16:9 when video images are being projected. Images which have been recorded in digital video or onto DVDs can be viewed in 16:9 wide-screen format.

### Procedure

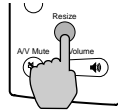

Projector

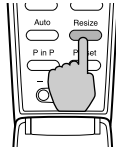

Remote control

The aspect ratio changes each time the [Resize] button on either the remote control or the projector's control panel is pressed.

### For SDTV

4:3 display



16:9 display



When 16:9 output (squeeze mode) images are displayed with an aspect ratio of 4:3, the images are compressed horizontally and elongated vertically.

### For HDTV

16:9 display



4:3 display



When 16:9 output (squeeze mode) images are displayed with an aspect ratio of 4:3, the center portion of the image is displayed in the whole of the screen.

### Changing the display position for 16:9 display

Center



Top



Bottom



While holding down the [Shift] button on the projector's control panel, press the [Resize] button. The display position changes as shown left each time the [Resize] button is pressed in this way.

## Adjusting Computer Images

### Automatic adjustment

Computer images can be adjusted automatically to the optimum images.

Automatic adjustment involves adjustment of the following three items: Tracking, Display position and Sync (synchronization).

#### Procedure

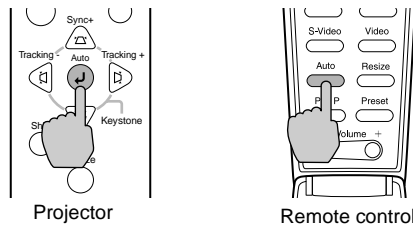

**While an image is being projected from the computer, press the [Auto] button on either the remote control or the projector's control panel.**

The screen will appear black while the adjustment is being made.

- While a menu or help screen is being displayed, the [Auto] button on the projector's control panel can be used to select and accept menu items. In such cases, press the [Auto] button of the remote control, or exit the menu or help screen before using the [Auto] button on the projector's control panel.
- If you use the remote control to activate the automatic adjustment function while the E-Zoom, A/V Mute or P in P functions are in use, the functions being used will be cancelled before automatic adjustment is carried out. If the [Auto] button on the projector's control panel is pressed, automatic adjustment will not be carried out if the E-Zoom or P in P function is being used.
- Automatic adjustment may not work properly with some types of signals which are output by computers. In such cases, you may need to adjust the tracking and sync manually.

### Adjusting the tracking

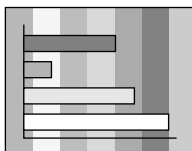

If vertical stripes appear in the projected images, and this cannot be fixed using automatic adjustment, you will need to adjust the tracking manually using the following procedure.

#### Procedure

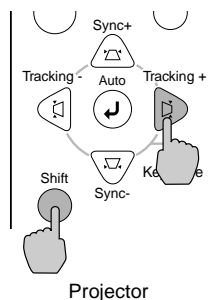

**While holding down the [Shift] button on the projector's control panel, press the [Tracking +] button.**

The tracking value increases each time the button is pressed.

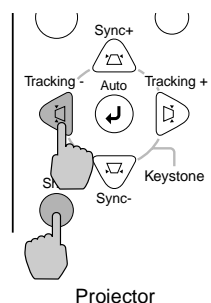

**While holding down the [Shift] button on the projector's control panel, press the [Tracking -] button.**

The tracking value decreases each time the button is pressed.

The image will flash when continuous tracking adjustment is carried out, but this is normal.

## Adjusting the sync

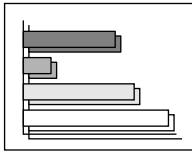

If flickering, fuzziness or interference appear in images that are input from the computer, and this cannot be fixed using automatic adjustment, you will need to adjust the sync(synchronization) manually using the following projection.

### Procedure

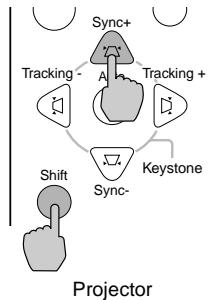

Projector

While holding down the [Shift] button on the projector's control panel, press the [Sync +] button.

The sync value increases each time the button is pressed.

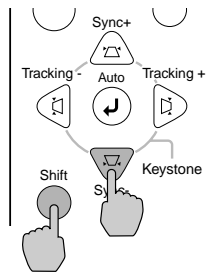

Projector

While holding down the [Shift] button on the projector's control panel, press the [Sync -] button.

The sync value decreases each time the button is pressed.



- If you do not adjust the tracking first and then adjust the sync, it will not be possible to get the best adjustment results. Incorrect tracking adjustment may not be noticeable with some types of picture. However, pictures with lots of lines and shading will tend to show incorrect tracking adjustments more clearly, so be sure to check the tracking adjustment first.
- It may also be possible to fix flickering and fuzziness by adjusting the brightness, contrast, sharpness and keystone correction settings.

# Adjusting the Volume

You can adjust the volume of the sound coming from the projector's built-in speaker.

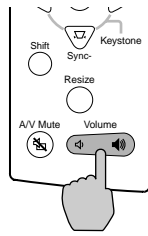

## Procedure



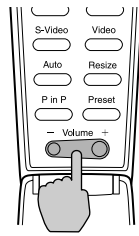

Projector



Remote control

**Press the [Volume  ,  ] button on the projector's control panel or the [Volume +/-] button on the remote control.**

If you press the [  ] or [+ ] side, the volume increases, and if you press the [  ] side or [- ] side, the volume decreases. While the volume is being changed, the volume value appears in the volume gauge.

---

# Settings and Useful Functions

---

This chapter describes the environment setting menus and useful functions that can be used when a computer is connected.

<b>Environment Setting Menu Functions and Operations .....</b>	<b>20</b>
• <b>Video Menu .....</b>	<b>20</b>
• Video .....	20
• Computer .....	22
• <b>Audio Menu .....</b>	<b>23</b>
• <b>Setting Menu .....</b>	<b>23</b>
• <b>User's Logo Menu .....</b>	<b>24</b>
• <b>Advanced Menu .....</b>	<b>25</b>
• <b>About Menu .....</b>	<b>26</b>
• Composite Video, S-Video .....	26
• Component Video, Computer .....	26
• <b>Reset All Menu .....</b>	<b>27</b>
• <b>Using the Menus .....</b>	<b>28</b>
<b>Useful Functions When a Computer is Connected .....</b>	<b>30</b>
• <b>A/V Mute .....</b>	<b>30</b>
• <b>Freeze .....</b>	<b>30</b>
• <b>E-Zoom .....</b>	<b>31</b>
• <b>P in P (Picture in Picture) .....</b>	<b>32</b>

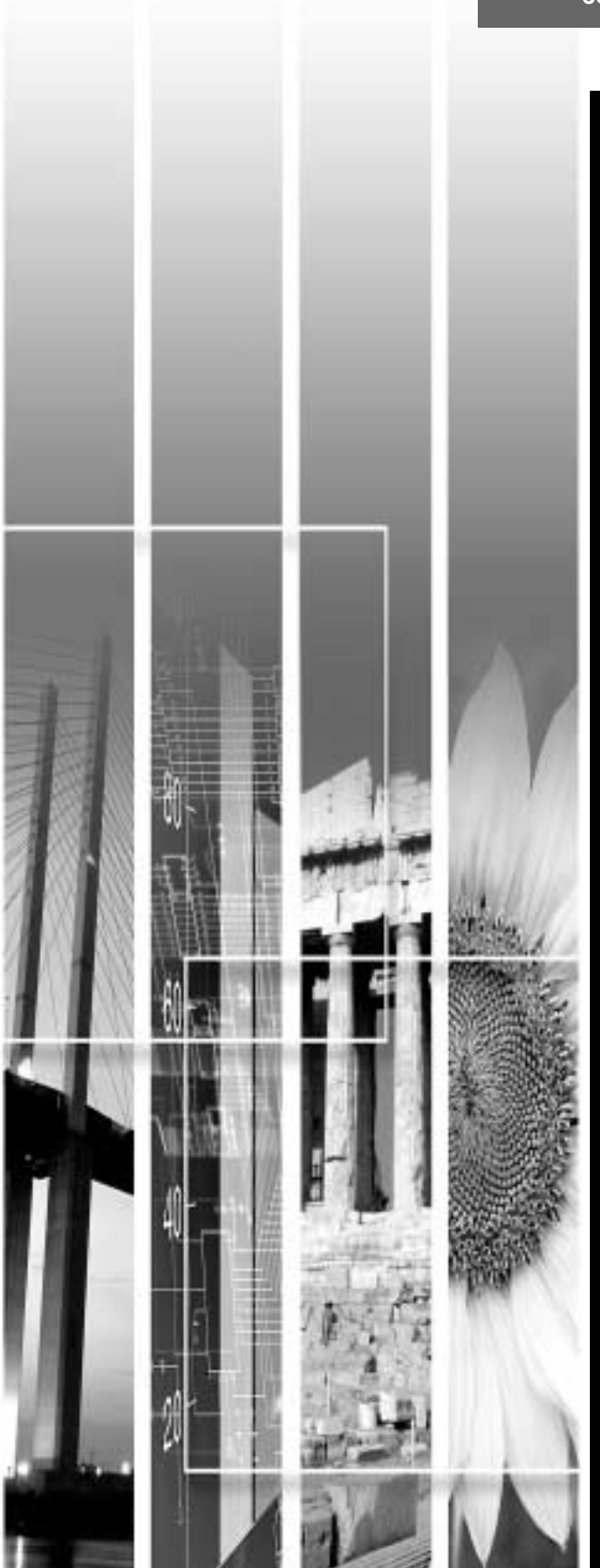

# Environment Setting Menu Functions and Operations

The setting menus can be used to carry out a variety of settings and adjustments.

The menus have a hierarchical structure, with a main menu that is divided into sub-menus, which are further divided into other sub-menus.

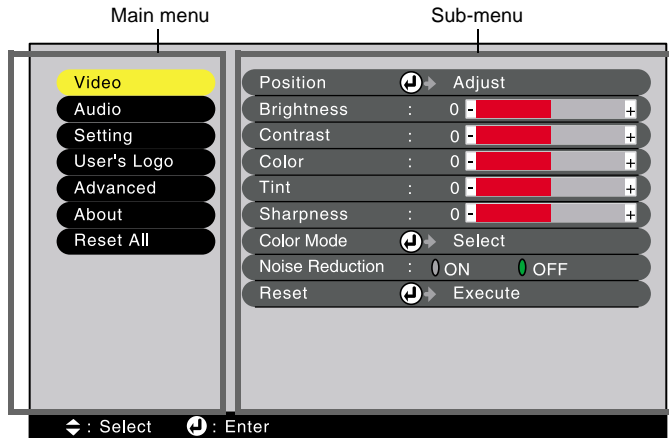

## Video Menu

- The functions in the Video menu cannot be adjusted while no image signal is being input.
- The items appearing in the Video menu will vary depending on the input signal that is being projected. Items in menus other than the menu for the signal currently being input cannot be adjusted.

### Video (RGB-Video, YCbCr, YPbPr, S-Video, Video)

RGB-Video

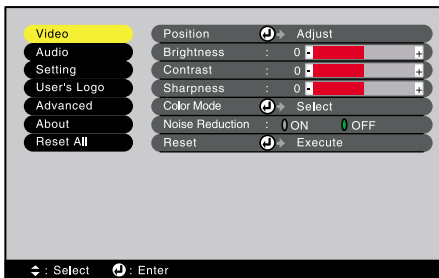

Component (YCbCr, YPbPr)

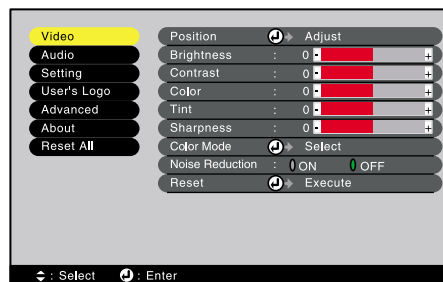

S-Video, Video

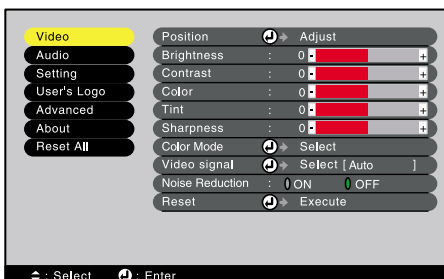

Main menu	Sub-menu	Function	Default setting
Video	Position	Moves the image display position vertically and horizontally. <ul style="list-style-type: none"> <li>Press the  button on the projector's control panel or the [Enter] button on the remote control, and make the adjustment using the display position adjustment screen that appears.</li> </ul>	Depends on connection
	Brightness	Adjusts the image brightness.	Median value (0)
	<u>Contrast</u> ▶▶	Adjusts the difference between light and shade in the images.	Median value (0)
	Color	(Not available for RGB-Video) Adjusts the color intensity for the images.	Median value (0)
	Tint	(Not available for RGB-Video) Adjust the image tint. Can only be adjusted when NTSC signals are being input.	Median value (0)
	Sharpness	Adjusts the image sharpness.	Median value (0)
	Color Mode	Corrects the vividness of the image color. You can select from five different quality settings depending on the surroundings. <ul style="list-style-type: none"> <li><b>Dynamic</b> :Ideal for projecting images with greater modulation and intensity.</li> <li><b>Theatre</b> :Ideal for enjoying presentations such as movies which have large numbers of dark scenes.</li> <li><b>Natural</b> :Ideal for enjoying presentations in a natural atmosphere.</li> <li><b>PC</b> :Ideal for use in making images as bright as possible when projecting computer images.</li> <li><b>sRGB</b>▶▶ :Images conform to the sRGB standard.</li> </ul>	Dynamic
	Video Signal	(S-Video and Video only) Sets the video signal format. <ul style="list-style-type: none"> <li>Press the  button on the projector's control panel or the [Enter] button on the remote control, and select the video signal format from the menu that appears.</li> <li>When set to Auto, the video signal format is set automatically, but if projecting signals in PAL (60 Hz) format, the setting needs to be made manually.</li> </ul>	Auto
	Noise Reduction	Turns the noise reduction function on and off. When set to ON , noise is reduced. Ignored when a menu or help screen is being displayed, even when set to ON. The setting becomes effective from the point where the menu or help screen is closed.	OFF
Reset	Resets all adjustment values for the Video menu functions to their default settings. <ul style="list-style-type: none"> <li>Press the  button on the projector's control panel or the [Enter] button on the remote control to display the confirmation screen, and select Yes.</li> <li>Select Reset All to return all menu settings to their default settings. (p.27)</li> </ul>	-	

\* If set to sRGB, the color temperature for the Color Adjustment command in the Advanced menu will be set to 6500K.

## Computer (Analog-RGB, Digital-RGB)

Analog-RGB

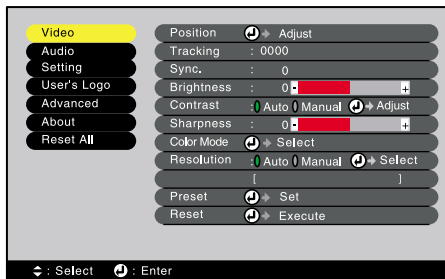

Digital-RGB

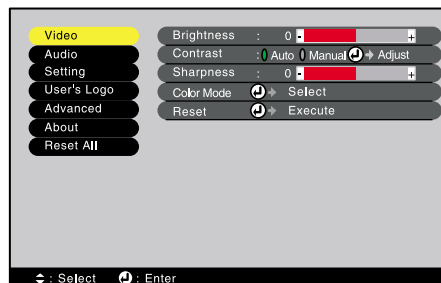

Main menu	Sub-menu	Function	Default setting
Video	Position	(Analog-RGB only) Moves the image display position vertically and horizontally. • Press the  button on the projector's control panel or the [Enter] button on the remote control, and make the adjustment using the display position adjustment screen that appears.	Depends on connection
	<u>Tracking</u>	(Analog-RGB only) Adjusts computer images when vertical stripes appear in the images.	Depends on connection
	<u>Sync.</u>	(Analog-RGB only) Adjusts computer images when flickering, fuzziness or interference appear in the images. • Flickering and fuzziness may also appear when the brightness, <u>contrast</u> , sharpness or keystone settings are adjusted. • You can obtain the best results if you adjust the tracking first and then adjust the synchronization.	0
	Brightness	Adjusts the image brightness.	Median value (0)
	<u>Contrast</u>	Adjusts the difference between light and shade in the images. • If Auto is selected, contrast adjustment is carried out at periodical intervals.	Auto
	Sharpness	Adjusts the image sharpness.	Median value (0)
	Color Mode	Corrects the vividness of the image color. The settings are saved separately for each source. You can select from five different quality settings depending on the surroundings. • <b>Dynamic</b> :Ideal for projecting images with greater modulation and intensity. • <b>Theatre</b> :Ideal for enjoying presentations such as movies which have large numbers of dark scenes. • <b>Natural</b> :Ideal for enjoying presentations in a natural atmosphere. • <b>PC</b> :Ideal for use in making images as bright as possible when projecting computer images. • <u>sRGB</u> :Images conform to the sRGB standard.	PC
	Resolution	(Analog-RGB only) Select Auto or Manual. • If Auto is selected, automatic setup is carried out. • If Manual is selected, you can select the image resolution for adjustment from a list.	Auto
	Preset	(Analog-RGB only) Saves the current input resolution to the preset list.	-
Reset	Resets all adjustment values for the Video menu functions to their default settings. • Press the  button on the projector's control panel or the [Enter] button on the remote control to display the confirmation screen, and select Yes. • Select Reset All to return all menu settings to their default settings. (p.27)	-	

\* If set to sRGB, the color temperature for the Color Adjustment command in the Advanced menu will be set to 6500K.



## Audio Menu

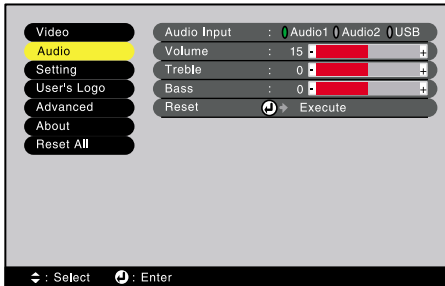

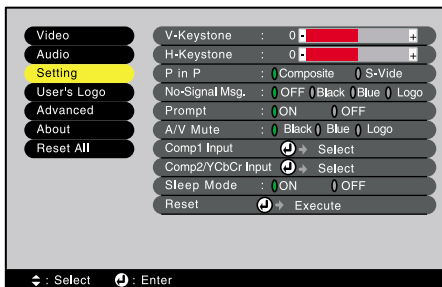

Main menu	Sub-menu	Function	Default setting
Audio	Audio Input	Sets the audio input port from Audio1, Audio2 or USB to match the current video source.	Depends on connection
	Volume	Adjusts the volume.	15
	Treble	Adjusts the treble setting.	Median value (0)
	Bass	Adjusts the bass setting.	Median value (0)
	Reset	Resets all adjustment values for the Audio menu functions to their default settings. <ul style="list-style-type: none"> <li>Press the  button on the projector's control panel or the [Enter] button on the remote control to display the confirmation screen, and select Yes.</li> <li>Select Reset All to return all menu settings to their default settings. (p.27)</li> </ul>	-

## Setting Menu



Main menu	Sub-menu	Function	Default setting
Setting	V-Keystone	<p>Corrects vertical keystone distortion in images.</p> <ul style="list-style-type: none"> <li>When keystone correction is carried out, the projected image will become smaller.</li> <li>If using both horizontal and vertical keystone correction, first make the vertical correction and then make the horizontal correction in that order.</li> <li>The keystone correction settings are memorized, so that if you change the position or angle of the projector, you may need to readjust the keystone correction settings.</li> <li>If the images become uneven in appearance after keystone correction is carried out, decrease the sharpness setting.</li> <li>If you carry out both horizontal and vertical keystone correction, the correction range will become smaller than it would be if only one type of correction was carried out.</li> </ul>	Median value (0)

Main menu	Sub-menu	Function	Default setting
Setting	H-Keystone	<p>Corrects horizontal keystone distortion in images.</p> <ul style="list-style-type: none"> <li>•When keystone correction is carried out, the image becomes smaller.</li> <li>•If using both horizontal and vertical keystone correction, first make the vertical correction and then make the horizontal correction in that order.</li> <li>•The keystone correction settings are memorized, so that if you change the position or angle of the projector, you may need to readjust the keystone correction settings.</li> <li>•If the images become uneven in appearance after keystone correction is carried out, decrease the sharpness setting.</li> <li>•If you carry out both horizontal and vertical keystone correction, the correction range will become smaller than it would be if only one type of correction was carried out.</li> </ul>	Median value (0)
	P in P	<p>Sets the input source for the sub-screen of the Picture in Picture function to either Composite Video or S-Video.</p> <ul style="list-style-type: none"> <li>•The Picture in Picture function can be used by pressing the [P in P] button. (p.32)</li> </ul>	Composite
	No-Signal Msg.	<p>Sets the message status and background color at times such as when no image signal is being input.</p> <ul style="list-style-type: none"> <li>•To change the user's logo, you need to record and set your own logo. (p.51)</li> </ul>	Blue
	Prompt	<p>Sets whether the source prompt for the input image is displayed on the screen or not.</p>	ON
	<u>A/V Mute</u> ▶▶	<p>Sets the screen status when the [A/V Mute] button is pressed.</p> <ul style="list-style-type: none"> <li>•To change the user's logo, you need to record and set your own logo.</li> </ul>	Black
	Comp1 Input	<p>Sets the image signal for Computer 1 input.</p>	Digital-RGB/ Analog-RGB
	Comp2/ <u>YCbCr</u> ▶▶ Input	<p>Sets the image signal for Computer 2 input.</p>	YCbCr
	Sleep Mode	<p>Sets the energy saving operation when no image signal is being input.</p> <ul style="list-style-type: none"> <li>•When set to ON, projection stops automatically and the projector changes to sleep mode if no operations are carried out for 30 minutes while the "No-Signal." message is being displayed. (The  indicator lights orange.)</li> <li>•Projection starts again when the [Power] button is pressed.</li> </ul>	ON
Reset	<p>Returns the adjustment values for the Setting menu to their default settings.</p> <ul style="list-style-type: none"> <li>•Press the  button on the projector's control panel or the [Enter] button on the remote control to display the confirmation screen, and select Yes.</li> <li>•Select Reset All to return all menu settings to their default settings. (p.27)</li> </ul>	-	

## User's Logo Menu

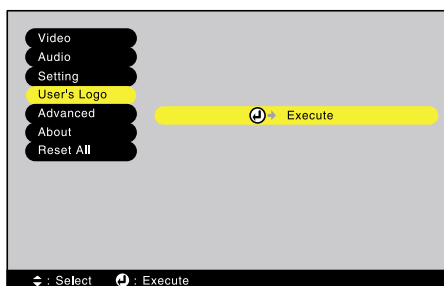

Main menu	Sub-menu	Function	Default setting
User's Logo	Execute	<p>Records a user's logo. (p.51)</p> <ul style="list-style-type: none"> <li>•Press the  button on the projector's control panel or the [Enter] button on the remote control, and follow the operations given in the screen that appears.</li> </ul>	EPSON logo

## Advanced Menu

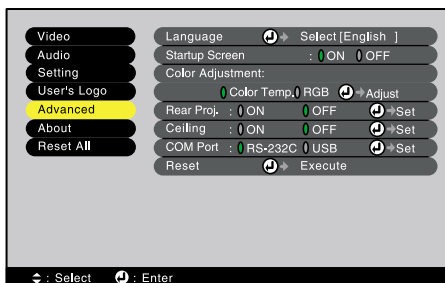

Main menu	Sub-menu	Function	Default setting
Advanced	Language	Sets the language for message displays. • Press the (⊕) button on the projector's control panel or the [Enter] button on the remote control, and select the language from the selection menu that appears.	English
	Startup Screen	Sets whether the startup screen is displayed or not. • To change the user's logo, you need to record and set your own logo.	ON
	Color Adjustment	Adjusts the <u>color temperature</u> and intensity of each RGB color in the image. Absolute color temperature: Lighter colors are adjusted so that they range from having a red tinge to having a blue tinge. When the color temperature is lower, the red content is greater and color tones appear softer. When the color temperature is higher, the blue content is greater and color tones appear fresher. • Press the (⊕) button on the projector's control panel or the [Enter] button on the remote control, and make the setting using the color temperature menu that appears. RGB: Sets the intensity of each color (red, green and blue). • Press the (⊕) button on the projector's control panel or the [Enter] button on the remote control, select R (red), G (green) or B (blue) from the color definition menu that appears, and then make the adjustment. • You can adjust the colors while viewing the results on the screen. (This item cannot be selected if sRGB has been selected as the Color Mode setting in the Video menu.)	Color Temp : Depends on connection
	Rear Proj.	Use when projecting images from behind a translucent screen. When set to ON, the projected images are horizontally reversed.	OFF
	Ceiling	Use when installing the projector to a ceiling or when using the projector upside down. When set to ON, the projected images are horizontally and vertically reversed.	OFF
	COM Port	Switches between Control (RS-232C) and USB serial communication.	RS-232C
	Reset	Resets all adjustment values for the Advanced menu functions to their default settings. • Press the (⊕) button on the projector's control panel or the [Enter] button on the remote control to display the confirmation screen, and select Yes. • Select Reset All to return all menu settings to their default settings. (p.27)	-

## About Menu

- The About menu shows the status of the current image source.
- The Lamp item appears as 0H for 0 – 10 hours, after that, it appears in units of 1 hour.

### Composite Video», S-Video»

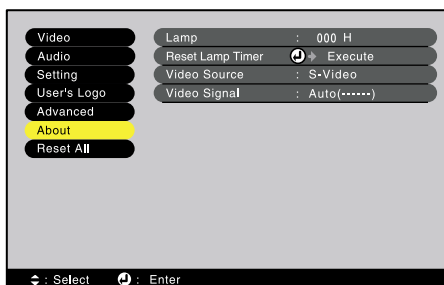

Main menu	Sub-menu	Function	Default setting
About	Lamp	Displays the cumulative lamp operating time. • When the lamp warning period is reached, the display characters appear in red.	0H
	Reset Lamp Timer	Initializes the lamp operating time. When this command is selected, the cumulative lamp operating time is reset to the initial default value. (p.49)	-
	Video Source	Displays the input source which is currently being projected.	
	Video Signal	Displays the video signal format.	Auto

### Component Video», Computer

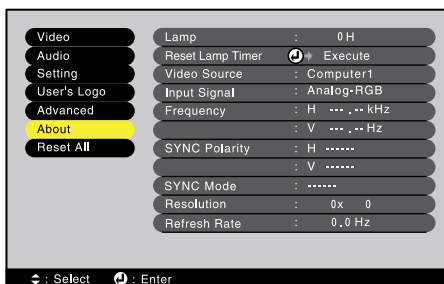

Main menu	Sub-menu	Function	Default setting
About	Lamp	Displays the cumulative lamp operating time. • When the lamp warning period is reached, the display characters appear in red.	0H
	Reset Lamp Timer	Initializes the lamp operating time. When this command is selected, the cumulative lamp operating time is reset to the initial default value. (p.49)	-
	Video Source	Displays the input source which is currently being projected.	-
	Input Signal	Displays the input signal settings.	-
	Frequency	Shows the horizontal and vertical scanning frequencies.	-
	SYNC Polarity	Displays the <u>sync(synchronization)</u> polarity.	-
	SYNC Mode	Displays the sync attributes.	-
	Resolution	Displays the input resolution.	-
	<u>Refresh Rate</u>	Displays the refresh rate.	-



## Reset All Menu

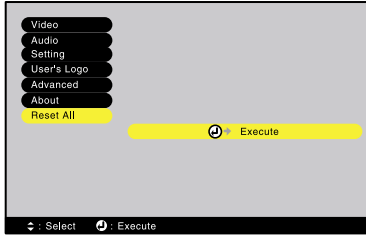

Main menu	Sub-menu	Function	Default setting
Reset All	Execute	<p>Resets all items in all environment setting menus to their default settings.</p> <ul style="list-style-type: none"> <li>• Press the  button on the projector's control panel or the [Enter] button on the remote control to display the confirmation screen, and select Yes.</li> <li>• Select Reset in an individual menu to reset only the settings for the items in each sub-menu.</li> <li>• The User's Logo, Lamp and Language settings will not return to their default settings.</li> </ul>	-

## Using the Menu

The menus can be operated using either the remote control or the projector's control panel.

### Procedure

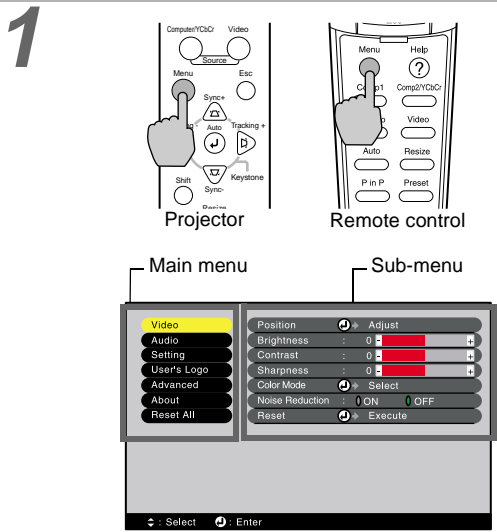

**Press the [Menu] button on either the remote control or the projector's control panel.**

The environment setting menu appears. The environment setting menu consists of a main menu and sub-menus. The sub-menu that corresponds to the currently-selected item in the main menu (displayed in yellow) appears.

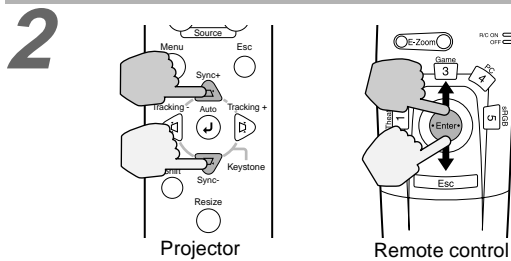

**Select a menu item.**

If using the projector's control panel, press the  $\Delta$  or  $\nabla$  button.  
If using the remote control, press the top or bottom of the [Enter] button.

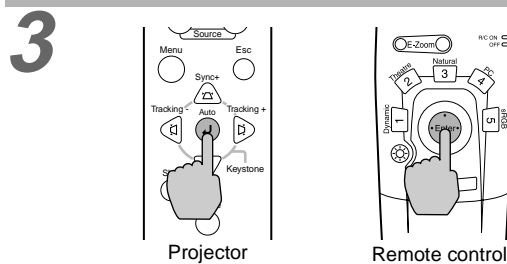

**Confirm the selection.**

Press the  $\odot$  button on the projector's control panel or the [Enter] button on the remote control to accept a selection.  
The sub-menu that corresponds to the currently-selected item in the main menu appears.

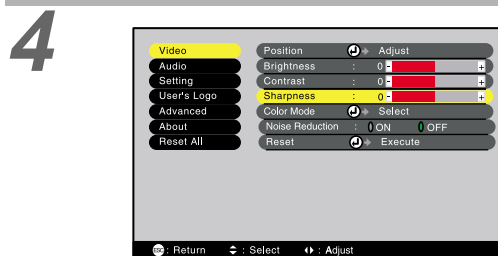

**Select the setting item in the sub-menu.**

If using the projector's control panel, press the  $\Delta$  or  $\nabla$  button.  
If using the remote control, press the top or bottom of the [Enter] button.  
The commands appearing in the Video menu and About menu will vary depending on the input signal that is being projected.

## 5

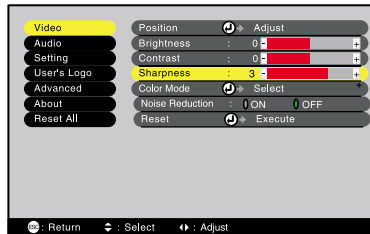
**Select a setting value.**

If using the projector's control panel, press the ◀ or ▶ button.

If using the remote control, press the left or right edge of the [Enter] button.



- If a setting is executed or a sub-menu item continues to another level, "⏪ Execute" or "⏩ Select" appears after the item name. In such cases, press the ⏪ button the projector's control panel or the [Enter] button on the remote control to select a setting value in the displayed menu.
- Refer to list of functions for details on the functions of each menu item. (p.20)

## 6

**Select other menu items in the same way.**

Repeat steps 2 to 5 to change the setting for other menu items. To return to a previous menu, press the [Esc] button.

## 7

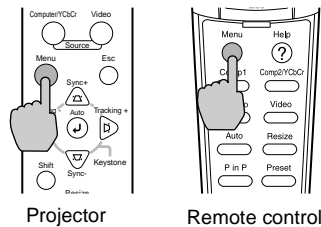

Projector

Remote control

**Close the menu.**

Press the [Menu] button on either the projector's control panel or the remote control.

# Useful Functions When a Computer is Connected

This section describes some of the useful functions that can be used when a computer is connected to the projector.

## A/V Mute

This function momentarily pauses the image and sound.

For example, it can be used when you do not want to show viewers details of operations such as selecting different files while computer images are being projected.

However, if you use this function when projecting moving images, the images and sound will still continue to be played back by the source, and you cannot return to the point where the mute function was activated.

### Procedure

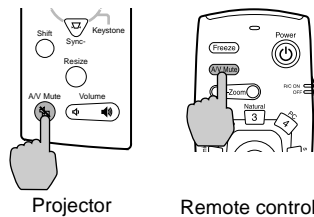

**Press the [A/V Mute] button on either the remote control or the projector's control panel.**

The image and sound will then be paused.

Press the [A/V Mute] button on either the remote control or the projector's control panel to continue normal projection.

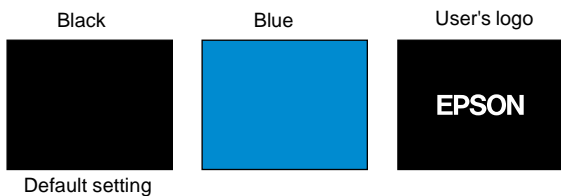

You can use the A/V Mute function in the Setting menu to set the screen appearance when the images and sound have been paused to any one of the following three settings.



The default user's logo is the EPSON logo. You can change the user's logo by recording and setting your own logo. (p.51)

## Freeze

This function pauses only the projected images. The sound keeps playing without pausing.

Furthermore, for moving pictures, the playback signal continues to be input even while the picture is paused, so playback will not resume from the point from where it was paused.

### Procedure

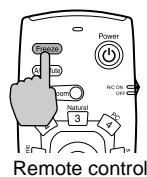

**Press the [Freeze] button on the remote control.**

The images will then be paused.

To continue projecting the images, either press the [Freeze] button again or press the [Esc] button.



- When the [Freeze] button is pressed, the menu or help message disappears.
- If you press the [Freeze] button while using the E-Zoom function or after a P in P sub-screen has been set, all of the screen displays will be paused.



## E-Zoom

This function lets you enlarge or reduce selected areas of images.

### Procedure

# 1

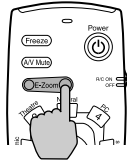

Remote control

**Press the [E-Zoom] button on the remote control.**

A cursor (cross) indicating the center point for the area to be enlarged will appear on the screen.

# 2

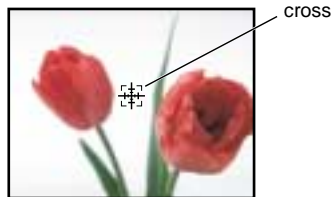

**Move the cross to the area of the image that is to be enlarged or reduced.**

Tilt the [Enter] button on the remote control to move the cross.

# 3

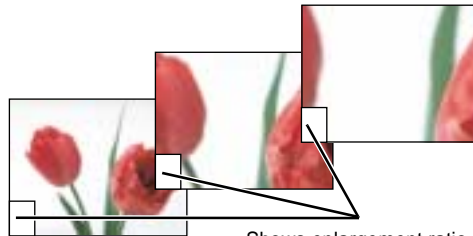
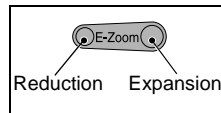

Shows enlargement ratio

**If you press the right side of the [E-Zoom] button, the image will be enlarged centering around the cross. If you press the left side of the [E-Zoom] button, the area of the image that was enlarged will then be reduced in size again.**

You can scroll around the image by tilting the [Enter] button.

To cancel the zoom, press the [Esc] button.



- The selected area can be enlarged to between 1 – 4 times, in 25 steps of x 0.125.
- If a sub-screen has been set using the P in P function, the enlargement function is applied to both the main screen and the sub-screen.
- If the E-Zoom function is in use, the projector's buttons cannot be used to perform adjustments such as keystone correction, tracking adjustment and sync adjustment.
- If the E-Zoom function is used while the keystone correction amount is near the limit value, the keystone correction amount may change.

## P in P (Picture in Picture)

This function lets you project computer images or component video images in the main screen, and a video image (Video or S-Video) in a sub-screen.

The video image in the sub-screen can be set using the P in P command in the Setting menu. (p.24)



- The P in P function cannot be used if the refresh rate for the computer images is set to interlaced.
- The P in P function cannot be used when TV (525i) component video images are being projected.

### Procedure

1

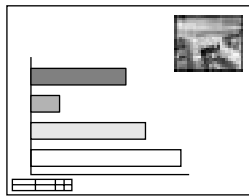

**Connect all components, set the type of sub-screen using the Setting menu, and then press the [P in P] button on the remote control.**

The sub-screen will appear at the top-right of the screen, and the operation guide will appear at the bottom-left of the screen.

2

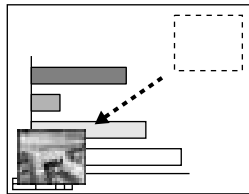

**Tilt the [Enter] button on the remote control to change the position of the sub-screen.**

3

**Press the [E-Zoom] button on the remote control to change the size of the sub-screen.**

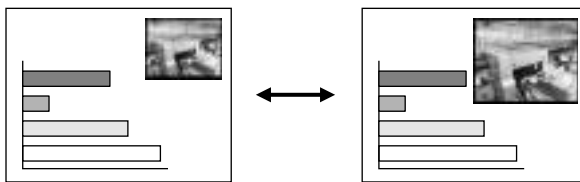

- The size of the sub-screen can be changed to one of five different sizes. The following values are the ratios for the vertical and horizontal lengths of the sub-screens to those of the main screen when the lengths of the main screen sides are 1.

Size 1 Approx. 1/3.2 ↔ Size 2 Approx. 1/2.8 ↔ Size 3 Approx. 1/2.5 ↔ Size 4 Approx. 1/2.3 ↔ Size 5 Approx. 1/2.1

- When the [P in P] button is pressed, the initial sub-screen appears in size 2.

# 4

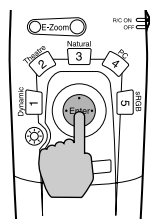

Remote control

**Press the [Enter] button on the remote control to accept the display position and size for the sub-screen.**

If you press the [P in P] button once more, the sub-screen will disappear.



- If you change and set the position of the sub-screen, the sub-screen will appear in the last position which was set using the P in P function.
- The E-Zoom function can be used at the same time that the P in P function is being used.
- If the audio input ports for the main screen and sub-screen are preset using the Audio Input command in the Audio menu, you can change the selected audio source by pressing buttons [1] or [2] on the remote control.  
 Button [1]: Main screen audio  
 Button [2]: Sub-screen audio  
 (Buttons [3] to [5] do not work at this time.)
- If the P in P function is used while the keystone correction amount is near the limit value, the keystone correction amount may change.



---

# Troubleshooting

---

This chapter describes troubleshooting procedures for the projector.

<b>Using the Help .....</b>	<b>36</b>
<b>When Having Some Trouble .....</b>	<b>37</b>
<b>When the Indicators Provide No Help .....</b>	<b>39</b>

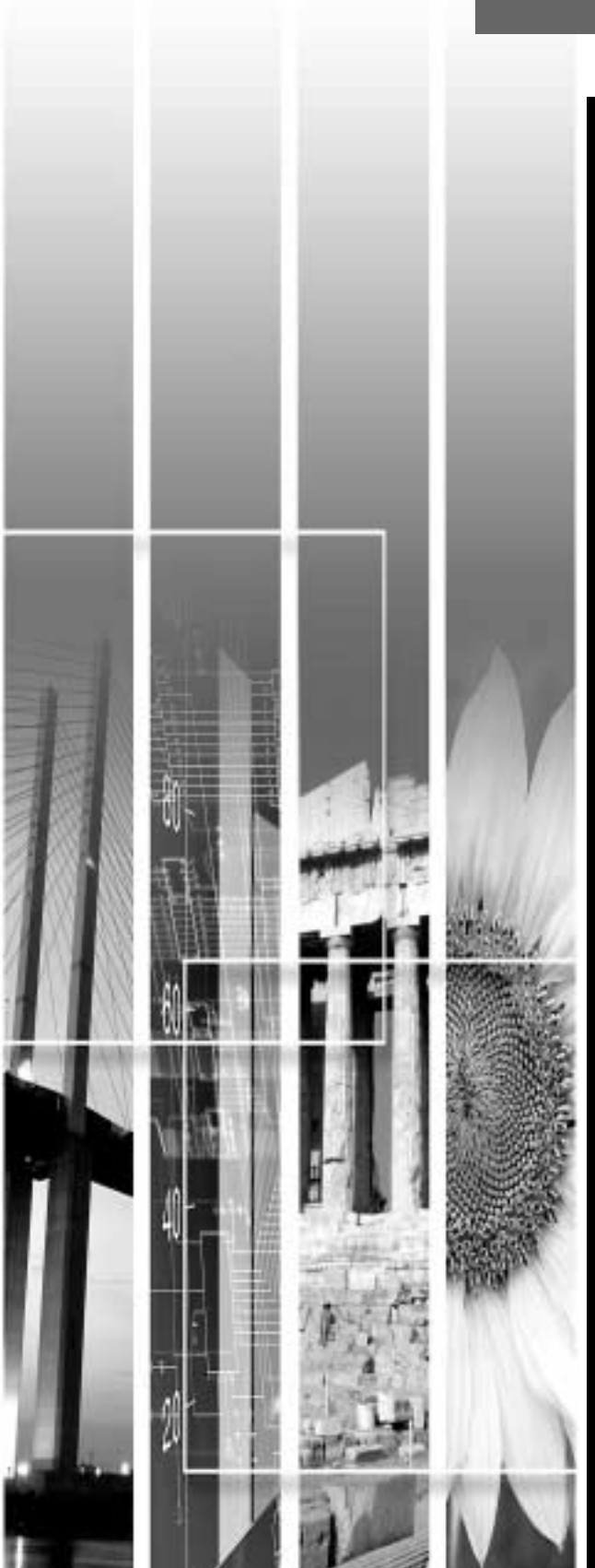

# Using the Help

If a problem occurs with the projector, the Help function uses on-screen displays to assist you in solving the problem. It uses a series of menus in a question and answer format. The questions vary depending on the type of image source.

## Procedure

1

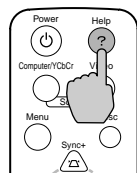

Projector

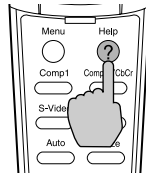

Remote control

**Press the [Help] button on either the remote control or the projector's control panel.**

The Help menu will be displayed.

2

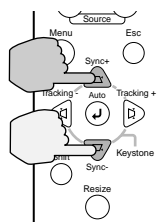

Projector

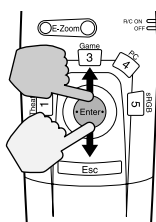

Remote control

**Select a menu item.**

If using the projector's control panel, the and buttons function as the up and down keys.

If using the remote control, press the top or bottom of the [Enter] button.

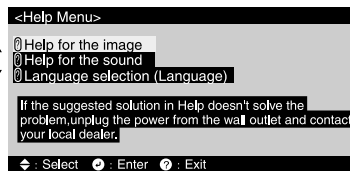

3

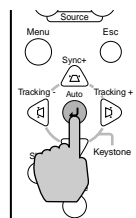

Projector

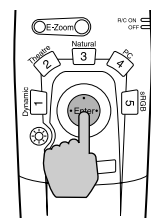

Remote control

**Confirm the selection.**

Press the button on the projector's control panel or the [Enter] button on the remote control to accept a selection.

The sub-menu appears.

4

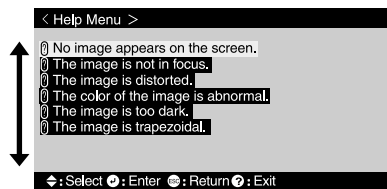

**Repeat the operations in steps 2 and 3 to proceed through the menu to more detailed items.**

To return to the previous menu, press the [Esc] button on either the remote control or the projector's control panel.

You can exit the Help menu at any time by pressing the [Help] button on either the projector's control panel or the remote control.



If the Help function does not provide a solution to the problem, refer to "When Having Some Trouble" (p.37) or "When the Indicators Provide No Help" (p.39).

# When Having Some Trouble



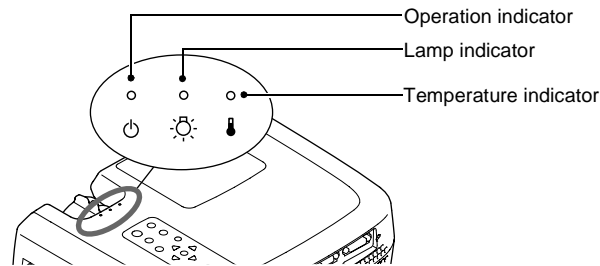





If you are having a problem with the projector, first check the projector's indicators. The projector is provided with the following three indicators. These indicators alert you to problems with projector operation.

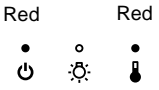
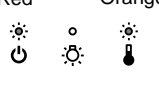

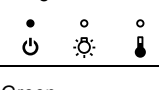
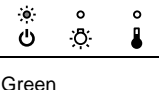
The following tables show what the indicators mean and how to remedy problems that they indicate.

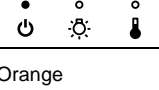
● : lit   ✨ : flashing   ○ : off

Indicator status	Projector status	Problem and remedy	Reference page
Red   Red   Red ●   ✨   ✨ ⏻   ✨   🌡	Internal problem	Stop using the projector, disconnect the power cord from the electrical outlet, and contact your dealer or the nearest address provided at "International Warranty Conditions" in <i>Safety Instructions/ World-Wide Warranty Terms</i> included in the package.	
Red   ○   Red ●   ✨   ✨ ⏻   ✨   🌡	Fan problem/Sensor problem	Stop using the projector, disconnect the power cord from the electrical outlet, and contact your dealer or the nearest address provided at "International Warranty Conditions" in <i>Safety Instructions/ World-Wide Warranty Terms</i> included in the package.	
Red   Red ●   ●   ○ ⏻   ✨   🌡	Lamp problem	Replace the lamp with a new one. When replacing the lamp, check that the lamp and the lamp cover are securely installed. If the lamp or lamp cover is not securely installed, the lamp will not turn on.	p.48
Red   Red ●   ✨   ○ ⏻   ✨   🌡	Lamp operating error	If the power cord plug is disconnected before the <b>cool-down</b> ▶ had not completely finished before, this may happen the next time you try to turn on the lamp. Wait for about 2 minutes without operating the projector. After about 2 minutes, the cooling fan will stop. When the cooling fan stops, disconnect the power plug and then re-insert it. When the power cord is plugged back in, the projector will return to its previous state, so press the [Power] button on either the remote control or the projector's control panel to turn it back on. If the lamp operating error happens again when the power is turned back on, remove the lamp and check if the lamp is broken. If it is not broken, reinstall it. If it is broken, replace it. Then press the [Power] button on either the remote control or the projector's control panel. If the indicators still show a problem, stop using the projector, disconnect the power cord from the electrical outlet, and contact your dealer or the nearest address provided at "International Warranty Conditions" in <i>Safety Instructions/ World-Wide Warranty Terms</i> included in the package.	p.48

Indicator status	Projector status	Problem and remedy	Reference page
<p>Red                      Red</p> 	High temperature inside projector (overheating)	<p>The lamp will turn off automatically and projection will stop. Wait for about 5 minutes without operating the projector. After 5 minutes have elapsed, the projector's cooling fan will stop. Once the cooling fan has stopped, unplug the power cord and then plug it back in again.</p> <p>If the projector overheats, check the following two points.</p> <ul style="list-style-type: none"> <li>• Is the setting-up location well ventilated? Check that the air inlet and air outlet are clear, and that the projector is not positioned against a wall.</li> <li>• Is the air filter blocked with dust? If the air filter is dirty, it should be cleaned.</li> </ul> <p>When the power cord is plugged back in, the projector will return to its previous state, so press the [Power] button on either the remote control or the projector's control panel to turn it back on. If the projector continues to overheat even after the above points have been checked, or if the indicators show a problem when the power is turned back on, stop using the projector, disconnect the power cord from the electrical outlet, and contact your dealer or the nearest address provided at "International Warranty Conditions" in <i>Safety Instructions/ World-Wide Warranty Terms</i> included in the package.</p>	<p><i>Setup Guide</i> p.46</p>
<p>Red                      Orange</p> 	High-speed cooling in progress	<p>(This is not an abnormality, but if the temperature rises too high again, projection will stop automatically.)</p> <ul style="list-style-type: none"> <li>• Set the projector up in a place which is well-ventilated, and so that the air inlet and exhaust vents are clear.</li> <li>• Clean the air filter.</li> </ul>	<p><i>Setup Guide</i> p.46</p>
<p>Orange</p> 	Lamp will soon need to be replaced.	<p>(No abnormality) Have a new replacement lamp ready. The lamp service life can become shorter than normal as a result of the usage conditions, and so the lamp should be replaced as soon as possible. * The appearance of the  indicator at this time will vary depending on the status of the projector.</p>	p.47
<p>Orange</p> 	Standby condition	<p>(No abnormality) Projection starts when the [Power] button is pressed.</p>	p.6
<p>Green</p> 	Warm-up in progress	<p>(No abnormality) Wait for a short while. The  indicator will stop flashing and light with a green color.</p>	p.7
<p>Green</p> 	Projecting in progress	<p>(No abnormality)</p>	p.7
<p>Orange</p> 	Cool-down in progress	<p>(No abnormality)</p> <ul style="list-style-type: none"> <li>• Wait for a short while. The <u>cool-down</u>  (lamp cooling operation) period lasts for about 2 minutes. The actual time will vary depending on the external air temperature.</li> <li>• The [Power] button will not operate during the cool-down period. When cool-down is complete, the  indicator will stop flashing and light orange. You can then use the [Power] button.</li> </ul>	p.9

 • If the projector is not operating properly even though the indicators are all showing normal, refer to "When the Indicators Provide No Help" on the following page.

• If an indicator is showing a status which does not appear in the previous tables, contact your dealer or the nearest address provided at "International Warranty Conditions" in *Safety Instructions/ World-Wide Warranty Terms* included in the package.





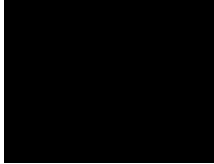

# When the Indicators Provide No Help

If any of the following problems occur and the indicators do not offer a solution, refer to the pages given for each problem.

No images appear	p.39, 40	Images appear dark	p.42
Poor image quality	p.40	Images appear green	p.43
Only part of the image is displayed (Large/small)	p.41	No sound can be heard	p.43
The image colors are not right	p.42	The remote control does not work	p.44
		The power does not turn off	p.44

	Condition  No images appear (Nothing at all appears)
---	--

Probable cause	Remedy
Is the lens cover still attached?	→ Remove the lens cover. (p.6)
Is the power cord disconnected?	→ Check the power cord connection at the power inlet of the projector and at the wall outlet. (p.6)
Was the power turned off and then straight back on again? While the  indicator is flashing orange (during cool-down  ), the [Power] button on either the remote control or the projector's control panel will not operate.	→ Wait until cool-down has finished. You can then use the [Power] button on either the remote control or the projector's control panel. (p.9)
Have you pressed the [Power] button on either the remote control or the projector's control panel?	→ Press the [Power] button on either the remote control or the projector's control panel. (p.7)
Is sleep mode active? When sleep mode has been set to ON, the lamp turns off automatically if no operations are carried out for 30 minutes while no video signal is being input. The  indicator lights orange at this time.	→ Turn the projector power back on. To cancel the sleep mode setting, set Sleep Mode in the Setting environment setting menu to OFF. Setting - Sleep Mode (p.24)
Has the image brightness been adjusted correctly?	→ Adjust using the Brightness environment setting menu. Video - Brightness (p.21, 22)
Is A/V Mute mode active?	→ Press the [A/V Mute] button on either the remote control or the projector's control panel to cancel the <u>A/V Mute</u>  mode. (p.30)
Is the projected image completely black? Some input images, such as screen savers, may be completely black.	→ Cancel the screen saver, or re-check the images being input.
Is an image signal being input? If No-Signal Msg. in the Setting menu has been set to OFF, no messages will be displayed.	→ Change the No-Signal Msg. setting to Black or Blue for messages to be displayed. Setting - No-Signal Msg. (p.24) If a message is displayed, refer to the item indicated.
Try resetting all of the current settings.	→ Reset All - Execute (p.27)

	<p><b>Condition</b></p> <p>No images appear (Messages do appear)          “Not Supported.” message appears on the screen.          “No-Signal.” message appears on the screen.</p>
---	--

Probable cause	Remedy
Does the input signal setting match the connected source?	<p>➔ Use the Comp1 Input or Comp2/YCbCr Input commands in the Setting menu to select the signal format that matches the connected source.</p> <p>For Comp1 :Digital-RGB, Analog-RGB, RGB-Video</p> <p>For Comp2/YCbCr :Analog-RGB, RGB-Video, <u>YCbCr</u>, <u>YPbPr</u></p> <p>(p.24)</p>
Is the connection port for the input source selected correctly?	<p>➔ Press the [Computer/YCbCr] or [Video] button on the projector's control panel or the [Comp1], [Comp2/YCbCr], [Video] or [S-Video] button on the remote control to change the image source. (p.7)</p>
Is the power for the computer or video source turned on?	<p>➔ Turn on the power. (p.7)</p>
Check the mode which corresponds to the frequency of the image signals being output from the computer.	<p>➔ Refer to the documentation provided with your computer for details on changing the resolution and frequency of the image signals being output from the computer. (p.55)</p>
If a laptop computer or a computer with a LCD screen has been connected to the projector, it is necessary to output the image signals to the projector rather than to the screen.	<p>➔ Normally image signals are output to only the computer's LCD screen, so you need to change the output to an external destination. For some computer models, when the image signals are output externally, they no longer appear on the LCD screen. For details, refer to the section of the documentation provided with your computer under a heading such as "External output", "Connecting an external monitor" or similar. (p.8)</p>

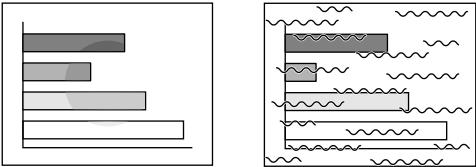
	<p><b>Condition</b></p> <p>Poor image quality</p> <ul style="list-style-type: none"> <li>• The image is fuzzy</li> <li>• Part of the image is out of focus</li> <li>• The whole image is out of focus</li> <li>• The image is distorted</li> <li>• The image contains interference</li> </ul>
---	---

Probable cause	Remedy
Has the focus been adjusted correctly?	<p>➔ Adjust the focus. (p.14)</p>
Has the front adjustable foot been adjusted so that the projection angle is too big? If the projection angle is too big, the image will be out of focus vertically.	<p>➔ Adjust the projection angle. (p.11)</p>
Is the projector at the correct distance?	<p>➔ The recommended distance from the projector to the screen is within 0.9 - 12.4 m (3.0 - 40.7 ft.). Set up the projector so that the projection distance is within this range. (<i>Setup Guide</i>)</p>
Is the projector beam perpendicular to the screen?	<p>➔ Adjust the projection angle so that the projector beam is perpendicular to the screen. (p.11)</p>

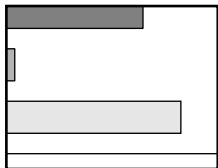
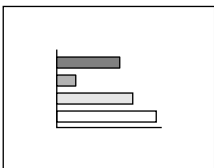

Probable cause	Remedy
Is the lens dirty?	→ Clean the lens. (p.46)
Has condensation formed on the lens? If the projector is suddenly taken from a cold environment to a warm environment, condensation may form on the lens, and this may cause the images to appear fuzzy.	→ Turn off the power and wait for the condensation to disappear.
Does the signal format setting match the format of the input signal?	→ Use the Video Signal command in the Video menu to select the video signal format. The projector may not be able to automatically identify some types of video signal that are input. (p.21)
Does the input signal setting match the connected source?	→ Use the Comp1 Input or Comp2/YCbCr Input commands in the Setting menu to select the signal format that matches the connected source. For Comp1 :Digital-RGB, Analog-RGB, RGB-Video For Comp2/YCbCr :Analog-RGB, RGB-Video, YCbCr <sup>▶▶</sup> , YPbPr <sup>▶▶</sup> (p.24)
Are the cables connected correctly?	→ Check that all cables that are required for projection are connected correctly. (Setup Guide)
Is an extension cable being used? If an extension cable is used, electrical interference may increase.	→ Connect an amplifier and check.
Have the sync(synchronization) <sup>▶▶</sup> , tracking <sup>▶▶</sup> and display position been adjusted correctly? (When connected to a computer)	→ Press the [Auto] button on either the remote control or the projector's control panel to adjust these settings. You can also use the environment setting menus to make the adjustment. (p.16, 22)
Has the correct resolution been selected? (When connected to a computer)	→ Set the computer so that the signals that are output are compatible with this projector. Refer to the documentation provided with your computer for details on changing the settings. (p.55)

		<p>Condition</p> <ul style="list-style-type: none"> <li>• Image is too large (Only part of the image is displayed)</li> <li>• Image is too small</li> </ul>
---	---	---

Probable cause	Remedy
The <u>aspect ratio</u> <sup>▶▶</sup> may not be selected correctly.	→ Press the [Resize] button. (p.15)
Has the Position setting been adjusted correctly?	→ Use the Position command in the Video menu to adjust. (p.21, 22)
Has the correct resolution been selected? (When connected to a computer)	→ Set the computer so that the signals that are output are compatible with this projector. Refer to the documentation provided with your computer for details on changing the settings. (p.55)
Change the resolution for the laptop computer or computer with a LCD screen. (When connected to a computer)	→ Change the resolution so that the image is displayed in the whole of the projection area, or set the video signal to external output only. (p.8, 11)

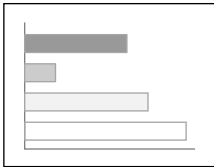

Probable cause	Remedy
Has the computer been set for dual display? (When connected to a computer)	→ If dual display has been activated in the Display Properties of the computer's Control Panel, the projector will only project about half of the image on the computer screen. To display the whole of the image on the computer screen, turn off the dual display setting. Refer to the video driver manual for the computer's monitor for further details.

	<p>Condition</p> <p>The image colors are not right</p>
---	--

Probable cause	Remedy
Has the image brightness been adjusted correctly?	→ Adjust using the Brightness environment setting menu. Video - Brightness (p.21, 22)
Are the cables connected correctly?	→ Check that all cables that are required for projection are connected correctly. ( <i>Setup Guide</i> )
Has the image <u>contrast</u> ▶▶ been adjusted correctly?	→ Adjust using the Contrast environment setting menu. Video - Contrast (p.21, 22)
Has the color been adjusted correctly?	→ Use the Color Adjustment command in the Advanced menu to adjust the contrast. Advanced - Color Adjustment (p.25)
Have the color intensity and tint been adjusted correctly? (The colors may not exactly match the colors in the image on the computer screen or LCD screen, but this is normal and is not the sign of a problem.)	→ Use the Video menu to adjust the Color and Tint settings. Video - Color, Tint (p.21)
Is the lamp due for replacement? If the  indicator is flashing orange, it means that the lamp will soon be due for replacement. When the lamp is nearly due for replacement, the image will become darker and the tint will become poorer.	→ Replace the lamp with a new one. (p.47, 48)
Does the input signal setting match the connected source?	→ Use the Comp1 Input or Comp2/YCbCr Input commands in the Setting menu to select the signal format that matches the connected source. For Comp1 :Digital-RGB, Analog-RGB, RGB-Video For Comp2/YCbCr :Analog-RGB, RGB-Video, <u>YCbCr</u> ▶▶, <u>YPbPr</u> ▶▶ (p.24)

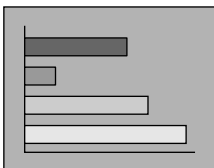
	<p>Condition</p> <p>Images appear dark</p>
---	--

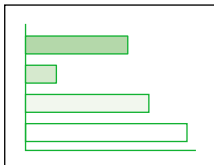

Probable cause	Remedy
<p>Is the lamp due for replacement?</p> <p>If the  indicator is flashing orange, it means that the lamp will soon be due for replacement. When the lamp is nearly due for replacement, the image will become darker and the tint will become poorer.</p>	<p>→ Replace the lamp with a new one. (p.47, 48)</p>
<p>Has the image brightness been adjusted correctly?</p>	<p>→ Adjust using the Brightness environment setting menu. Video - Brightness (p.21, 22)</p>
<p>Has the image <u>contrast</u>▶▶ been adjusted correctly?</p>	<p>→ Adjust using the Contrast environment setting menu. Video - Contrast (p.21, 22)</p>

	<p>Condition</p> <p>Images appear green</p>
---	---

Probable cause	Remedy
<p>Do the settings for <u>component video</u>▶▶ input signals match the signals from the connected device?</p> <p>If the YCbCr or YPbPr settings are incorrect, the images may appear greenish.</p>	<p>→ Use the Comp2/YCbCr Input commands in the Setting menu to select the signal format that matches the connected source. Setting - Comp2/YCbCr Input (p.24)</p>

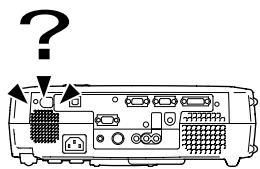



	<p>Condition</p> <p>No sound can be heard</p>
---	---

Probable cause	Remedy
<p>Is the audio source connected correctly?</p>	<p>→ Check that the cable being used matches the input port. (Setup Guide)</p>
<p>Has the correct audio input port been selected?</p>	<p>→ Use the Audio Input command in the Audio menu to set the port for audio signal input. (p.23)</p>
<p>Is sound being output from the audio source?</p>	<p>→ Check the volume for the audio source.</p>
<p>Has the volume been adjusted to the minimum setting?</p>	<p>→ Adjust the volume so that the sound is audible. (p.18)</p>
<p>Has the A/V Mute function been turned on?</p>	<p>→ The projector may be in A/V Mute mode. Press the [A/V Mute] button on the projector's control panel or the remote control to cancel the <u>A/V Mute</u>▶▶ mode. (p.30)</p>
<p>Have the correct USB audio settings for this projector been made at the computer? (When connected to a computer)</p>	<p>→ If using a USB cable to output sound from the computer, you need to select USB audio for the projector in the audio properties for the computer.</p>

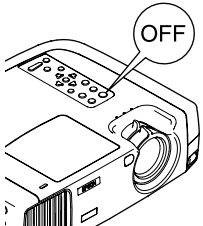
	<p>Condition</p> <p>The remote control does not work</p>
---	--

Probable cause	Remedy
Is the R/C switch on the remote control set to OFF?	➔ Set the R/C switch on the remote control to ON. (p.7)
Is the remote control being pointed at the right angle?	➔ The operating angle for the remote control is approximately 30° horizontally and approximately 15° vertically. Use the remote control within these ranges. ( <i>Setup Guide</i> )
Is the remote control too far from the projector?	➔ The operating distance for the remote control is approximately 10 m (30 ft.). Use the remote control within this distance. ( <i>Setup Guide</i> )
Is the remote control being pointed at the projector when a remote control receiver has been connected?	➔ If the remote control receiver is connected, point the remote control toward the remote control receiver instead of toward the projector.
Is direct sunlight or strong light from fluorescent lamps shining onto the remote control light-receiving area ?	➔ Avoid using projector in places where the remote control light-receiving area is exposed to strong light.
Are there batteries in the remote control?	➔ Insert batteries into the remote control. ( <i>Setup Guide</i> )
Are the batteries dead?	➔ Replace the batteries with new ones. ( <i>Setup Guide</i> )
Have the batteries been inserted correctly?	➔ Insert the batteries so that they face in the correct direction. ( <i>Setup Guide</i> )

	<p>Condition</p> <p>The power does not turn off (after the [Power] button is pressed)</p>
---	---

Probable cause	Remedy
<p>Is the  indicator still orange?</p> <p>This projector is designed so that the  indicator remains lit even when after the power has been turned off.</p>	➔ The  indicator will switch off when the power cord is disconnected from the electrical outlet.
<p>Is the fan still operating?</p> <p>After the [Power] button on either the remote control or the projector's control panel is pressed to turn off the power, the <u>cool-down</u>  period starts.</p>	<p>➔ After the cool-down period is complete, the  indicator changes to a steady orange, and you can then turn off the power switch at the rear of the projector.</p> <p>* The cool-down period lasts for about 2 minutes. The actual time will vary depending on factors such as the ambient air temperature.</p>

---

# Appendices

---

This chapter provides information on maintenance procedures to ensure the best level of performance for the projector for a long time.

<b>Maintenance .....</b>	<b>46</b>
• <b>Cleaning.....</b>	<b>46</b>
• Cleaning the Projector Case.....	46
• Cleaning the Lens .....	46
• Cleaning the Air Filter .....	46
• <b>Replacing Consumables .....</b>	<b>47</b>
• Lamp Replacement Period.....	47
• Replacing the Lamp .....	48
• Resetting the Lamp Operating Time.....	49
• Replacing the Air Filter .....	50
<b>Saving a User's Logo.....</b>	<b>51</b>
<b>Optional Accessories .....</b>	<b>53</b>
<b>List of Supported Signal Resolutions .....</b>	<b>54</b>
• Component Video Input/ RGB Video Input .....	54
• Composite Video/ S-Video Input.....	54
• Computer .....	55
<b>Specifications.....</b>	<b>56</b>
<b>Appearance .....</b>	<b>58</b>
<b>Part Names and Functions.....</b>	<b>59</b>
• <b>Front/ Top.....</b>	<b>59</b>
• <b>Control Panel .....</b>	<b>60</b>
• <b>Rear.....</b>	<b>61</b>
• <b>Base .....</b>	<b>61</b>
• <b>Remote Control.....</b>	<b>62</b>
• Underneath cover .....	62
<b>Glossary.....</b>	<b>63</b>
<b>Index.....</b>	<b>65</b>

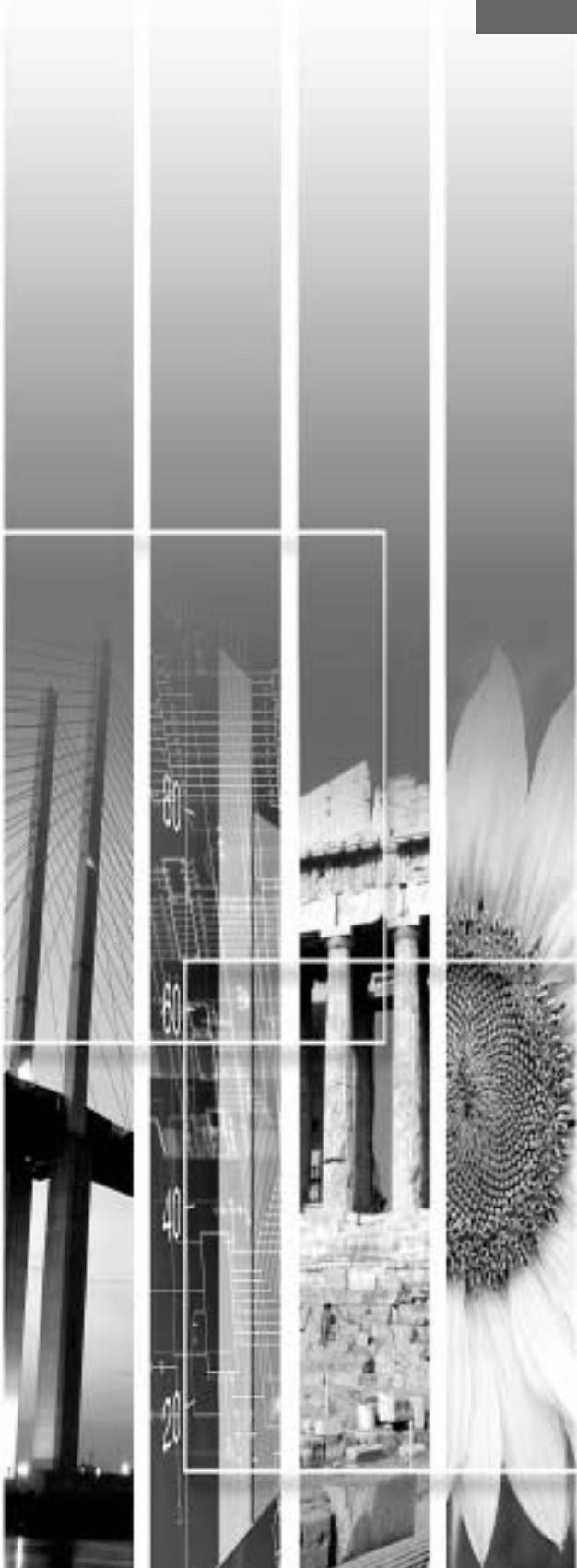

# Maintenance

This section describes maintenance tasks such as cleaning the projector and replacing consumable parts.

## Cleaning

You should clean the projector if it becomes dirty or if the quality of projected images starts to deteriorate.



Be sure to read the separate *Safety Instructions/ World-Wide Warranty Terms* for details on safe handling of the projector during cleaning.

### Cleaning the Projector Case

Clean the projector case by wiping it gently with a soft cloth.

If the projector is particularly dirty, moisten the cloth with water containing a small amount of neutral detergent, and then firmly wring the cloth dry before using it to wipe the projector case. Then wipe the case again with a soft, dry cloth.



Do not use volatile substances such as wax, alcohol or thinner to clean the projector case. These can cause the case to warp and make the coating finish peel off.

### Cleaning the Lens

Use a commercially-available air blower, or use a lens cleaning paper to gently wipe the lens.



Do not rub the lens with harsh materials or subject the lens to shocks, as it can easily become damaged.

### Cleaning the Air Filter

If the air filter becomes clogged with dust, it can cause overheating and damage the projector.

Stand up the projector in order to prevent dust getting inside the projector, and then use a vacuum cleaner to clean away the dust from the air filter.

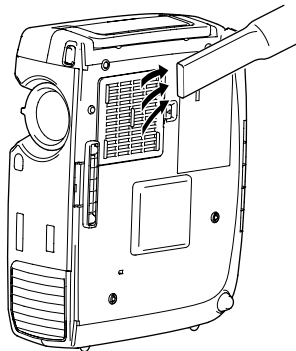

- If the air filter is difficult to clean or if it is broken, it should be replaced. Contact your dealer for a spare air filter.
- Replacement lamps are provided with a spare air filter. The air filter should also be replaced when the lamp is replaced.



## Replacing Consumables

This section describes how to replace the lamp and the air filter.

### Lamp Replacement Period

It is time to replace the lamp when:

- The message "Lamp Replace" appears on the screen when projection starts.

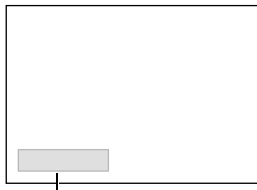

A message will be displayed.

The message appears for 30 seconds, and disappears again after 30 seconds have passed.

- The  indicator flashes orange or lights red.

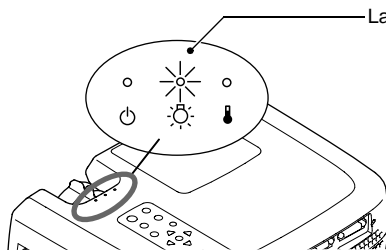

Lamp indicator flashes orange or lights red.

- The projected image gets darker or starts to deteriorate.



- In order to maintain the brightness and quality of the projected images, replace the lamp as soon as possible after the warning message appears.
- The replacement warning message is set to appear after 2900 hours of lamp use in order to maintain the brightness and quality of the projected images. If you continue to use the lamp after this period, the possibility of the lamp breaking becomes greater. When the lamp replacement message appears, replace the lamp with a new one as soon as possible, even if it is still working.
- The warning message appears after 2900 hours of use, but the actual life of each individual lamp will vary depending on the characteristics of the lamp and on the way it has been used. Some lamps may stop operating before 2900 hours of use, so you should always have a spare lamp ready in case.
- When the lamp replacement warning message appears, the user's logo will not appear even if the start-up screen setting is ON.
- Contact your dealer for a spare lamp.

## Replacing the Lamp



- If the lamp stops working and needs to be replaced, there is the danger that the lamp may break when handled. If replacing the lamp of a projector which has been installed to the ceiling, you should remove the projector from the ceiling before replacing the lamp. If the projector cannot be removed from the ceiling, you should always assume that the lamp is broken and handle it with extreme care during removal. Furthermore, you should stand to the side of the projector, not underneath it.
- Wait until the lamp has cooled down sufficiently before opening the lamp cover. After the **cool-down** period has finished, it takes approximately a further 30 minutes for the lamp to be cool enough.

### Procedure

1

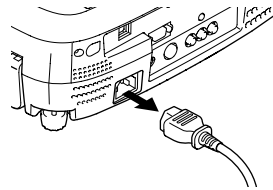

**Turn off the projector power, wait for the cool-down period to end, and then disconnect the power cord. (p.9)**

The cool-down period lasts for about 2 minutes. The actual time will vary depending on the external air temperature.

2

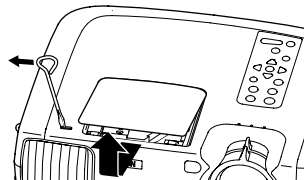

**Wait until the lamp has cooled down, and then remove the lamp cover.**

It takes approximately 30 minutes for the lamp to cool down by itself. Use the screwdriver that is provided with the spare lamp to slide the lamp cover opening switch so that the lamp cover lifts up. Hold the raised section of the lamp cover and then slide it forward to remove it from the projector.

3

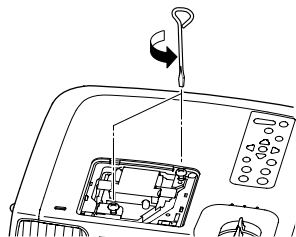

**Loosen the two lamp fixing screws.**

Use the screwdriver that is supplied with the spare lamp to loosen the two lamp fixing screws that are securing the lamp to the projector.

4

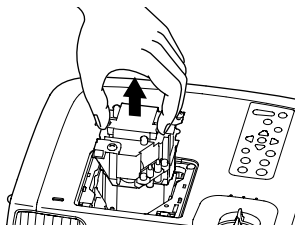

**Take out the lamp.**

Hold the lamp by the two recesses on the side to lift it up and out from the projector.

5

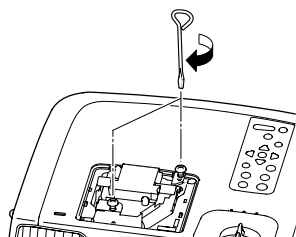

**Install the new lamp.**

Hold the lamp so that it faces the correct way to fit into the projector, and then insert the lamp until it clicks into place and tighten the two fixing screws.

6

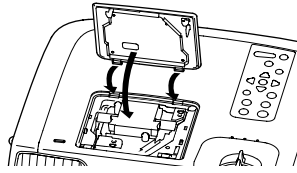
**Install the lamp cover.**

Insert the two cover tabs into the projector, and then press the other side of the lamp cover until it clicks into place.



- Install the lamp securely. If the lamp cover is removed, the lamp turns off automatically as a safety precaution. Moreover, the lamp will not turn on if the lamp or the lamp cover is not installed correctly.
- Spare lamps are provided with a spare air filter. The air filter should also be replaced when the lamp is replaced.
- Dispose of used lamps properly in accordance with your local regulations.

**Resetting the Lamp Operating Time**

The projector has a built-in counter which keeps track of the lamp operating time. When the cumulative operating time reaches a certain point, it causes the replacement warning message to be displayed. Therefore, the counter needs to be reset after the lamp has been replaced with a new one. You can do this using the projector menu.



Do not reset the lamp operating time except after the lamp has been replaced, otherwise the lamp replacement period will not be indicated correctly.

**Procedure**

1

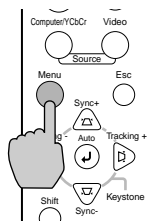

Projector

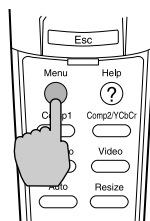

Remote control

Press the [Menu] button on either the remote control or the projector's control panel.

The environment setting menu will be displayed.

2

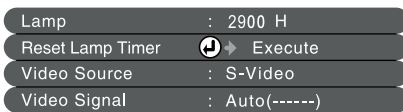

Select **Reset Lamp Timer** from the **About** menu.

Press the  button on the projector's control panel or the [Enter] button on the remote control.

3

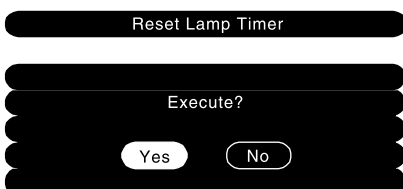

**Reset the lamp operating time.**

Select **Yes**, and then press the  button on the projector's control panel or the [Enter] button on the remote control.

## Replacing the Air Filter

### Procedure

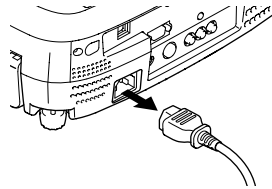
**1**

Turn off the projector power, wait for the **cool-down** period to end, and then **disconnect the power cord.** (p.9)

The cool-down period lasts for about 2 minutes. The actual time will vary depending on the external air temperature.

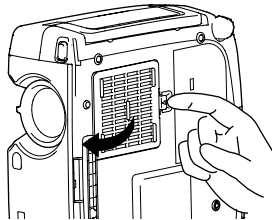
**2**

**Put your finger into the recess in the air filter hook, and lift up the air filter to remove it.**

In order to prevent any dust on the air filter from getting into the projector, be sure to stand up the projector so that the handle is at the top.

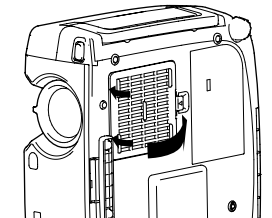
**3**

**Install the new air filter.**

First insert the tabs, and then press down on the opposite side until it clicks into place.



Dispose of used air filters properly in accordance with your local regulations.

# Saving a User's Logo

You can record the image that is currently being projected as a user's logo.



When you record a user's logo, any user's logo that has already been recorded will be erased.

## Procedure

1

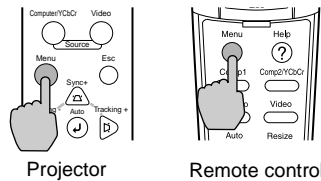

Project the image that you would like to use as a user's logo, and then press the [Menu] button on the projector's control panel or the remote control.

2

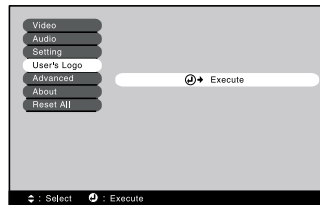

Select the User's Logo menu, and then press the [Enter] button on the projector's control panel or the [Enter] button on the remote control.



If keystone correction has been carried out, it will be cancelled when the User's Logo menu is selected.

3

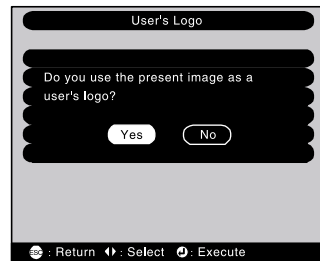

Select Yes in the sub-menu, and then press the [Enter] button on the projector's control panel or the [Enter] button on the remote control.

4

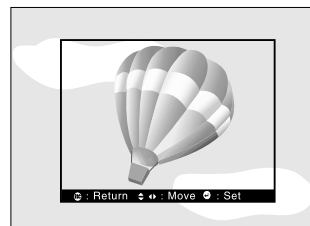

The image to be recorded and a selection marquee box will be displayed. Move the marquee box to select the part of the image to use.

Tilt the [Enter] button on the remote control to select the part of the image to use as the user's logo, and then press the [Enter] button on the projector's control panel or the [Enter] button on the remote control.



If the video signal being input is a YCbCr or YPbPr signal, the selection marquee box can only be moved around the middle of the image.

5

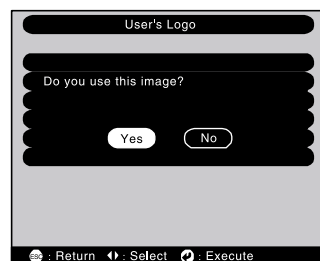

Select Yes at the confirmation screen, and then press the [Enter] button on the projector's control panel or the [Enter] button on the remote control.

6



Select the zoom rate in the Zoom rate setting screen, and then press the  button on the projector's control panel or the [Enter] button on the remote control.

7



Select Yes at the confirmation screen, and then press the  button on the projector's control panel or the [Enter] button on the remote control.

The image will then be saved. Once the image has been saved, the message "Saving the user's logo is completed." will be displayed.



- Saving the user's logo may take a few moments (about 40 seconds). Do not use the projector or any other sources which are connected to the projector while the user's logo is being saved, otherwise it may result in errors in projector operation.
- User's logos can be saved at up to 400 x 300 dots in size.
- If the image resolution is not XGA , or if a video image is being projected, the display size will be changed.

# Optional Accessories

The following optional accessories are available for purchase if required. This list of optional accessories is current as of February 2002. Details of accessories are subject to change without notice.

Spare lamp Use as a replacement for spent lamps.	ELPLP17	Digital video cable (3 m (9.8 ft.) - for DVI-D/DFP 20-pin) DFP cable for connecting the projector to a computer with a digital RGB output interface.	ELPKC21
Portable screen A compact screen which can be carried easily.	ELPSC06	DVI analog cable (3 m (9.8 ft.) - for DVI-I/mini D-Sub 15-pin) Use to connect the projector to connect two computers with analog RGB output to the projector.	ELPKC25
60-inch screen	ELPSC07	Remote control receiver Use to control the projector with the remote control from a distance.	ELPST04
80-inch screen	ELPSC08	Ceiling mount * Use when installing the projector to a ceiling.	ELPMB07
Computer cable (1.8 m (6 ft.) - for mini D-Sub 15-pin/mini D-Sub 15-pin)	ELPKC02	Ceiling plate * Pipe 370 (370 mm (14.57 inches)/silver)* ELPFP04	ELPFC03
Computer cable (3 m (9.8 ft.) - for mini D-Sub 15-pin/mini D-Sub 15-pin)	ELPKC09	Pipe 570 (570 mm (22.44 inches)/silver)* ELPFP05	ELPKC11
Computer cable (20 m (65.6 ft.) - for mini D-Sub 15-pin/mini D-Sub 15-pin) Use when connecting the projector to a computer.	ELPKC10	Pipe 770 (770 mm (30.31 inches)/silver)* ELPFP06	ELPKC19
Computer cable (1.8 m (6 ft.) - for mini D-Sub 15-pin/5BNC)	ELPKC11	Use when installing the projector to a high ceiling or a ceiling with veneer panels.	ELPKC19
Use to connect the projector to a workstation.	ELPKC11	Image presentation camera Use when projecting books, OHP films and slides.	ELPDC02 ELPDC03
Component video cable (3 m (9.8 ft.) - for mini D-Sub 15-pin/RCA x 3) Use to connect a component video source.	ELPKC19	Hard travel case Use this case if you need to carry the projector by hand.	ELPKC19
Digital video cable (3 m (9.8 ft.) - DVI-D male-male) DVI cable for connecting the projector to a computer with a digital RGB output interface.	ELPKC20	Soft carrying case Use this case if you need to carry the projector by hand.	ELPKS26 ELPKS27

\* A special method of installation is required in order to suspend the projector from the ceiling. Please contact the place of purchase if you would like to use this installation method.

# List of Supported Signal Resolutions

## Component Video Input/ RGB Video Input

Signal	Refresh rate (Hz)	Resolutions for resized display (dots)	
<u>SDTV</u> (525i) (D1)	60	800 × 600 (4:3 aspect)	800 × 450 (16:9 aspect)
SDTV (625i)	50	800 × 600 (4:3 aspect)	800 × 450 (16:9 aspect)
SDTV (525p) (D2)		800 × 600 (4:3 aspect)	800 × 450 (16:9 aspect)
<u>HDTV</u> (750p) 16:9 (D4)		800 × 450 (16:9 aspect)	800 × 600 (4:3 aspect ratio with zoom)
HDTV(1125i)16:9 (D3)		800 × 450 (16:9 aspect)	800 × 600 (4:3 aspect ratio with zoom)

## Composite Video/ S-Video Input

Signal	Refresh rate (Hz)	Resolutions for resized display (dots)	
TV (NTSC)		800 × 600 (4:3 aspect)	800 × 450 (16:9 aspect)
TV (PAL, SECAM)		800 × 600 (4:3 aspect)	800 × 450 (16:9 aspect)



**Computer**

Signal	Refresh rate (Hz)	Resolution (dots)	Resolutions for resized display (resizing ON) (dots)	Resolutions for normal display (resizing OFF) (dots)
PC98		640 × 400	800 × 500	640 × 400
EGA		640 × 350	800 × 438	640 × 350
<u>VGA</u> ▶▶	60	640 × 480	800 × 600	640 × 480
VGACGA		640 × 400	800 × 500	640 × 400
VGAEGA		640 × 350	800 × 438	640 × 350
VGA text		720 × 400	800 × 444	720 × 400
		720 × 350	800 × 388	720 × 350
VESA	72/75/85/120, iMac*2	640 × 480	800 × 600	640 × 480
<u>SVGA</u> ▶▶	56/60/72/75/85/120, iMac*2	800 × 600	800 × 600	800 × 600
<u>XGA</u> ▶▶	43i/60/70/75/85/120, iMac*2	1024 × 768	800 × 600	1024 × 768 *1
<u>SXGA</u> ▶▶	70/75/85/100	1152 × 864	800 × 600	1152 × 864 *1
SXGA	60/70/85	1280 × 960	800 × 600	1280 × 960 *1
SXGA	43i/60/75/85	1280 × 1024	750 × 600	1280 × 1024 *1
SXGA+	60/75/85	1400 × 1050	800 × 600	1400 × 1050 *1
MAC13"		640 × 480	800 × 600	640 × 480
MAC16"		832 × 624	800 × 600	832 × 624 *1
MAC19"		1024 × 768	800 × 600	1024 × 768 *1
MAC21"		1152 × 870	794 × 600	1152 × 870 *1
TV (525i)	60	640 × 480	800 × 600	640 × 480
TV (625i)	50	720 × 540	800 × 600	720 × 540
<u>SDTV</u> ▶▶ (525p)		640 × 480	800 × 600	640 × 480
<u>HDTV</u> ▶▶ (750p)		1280 × 720	800 × 450	
HDTV(1125i, 1125p)		1920 × 1080	800 × 450	

\*1 Virtual (window) display

\*2 Connection is not possible if the equipment does not have a VGA output port.

# Specifications

Product name	Home Theatre Projector EMP-TS10		
Dimensions	348 (W) x 104 (H) x 274 (D) mm (13.7 (W) x 4.09 (H) x 10.79 (D) inches) (not including protruding parts)		
Panel size	0.9 inches		
Display method	Polysilicon TFT active matrix		
Drive method	Full-line 12-phase block sequential writing		
Resolution	SVGA 480,000 pixels (800 (W) x 600 (H) dots) x 3		
Focus adjustment	Manual		
Zoom adjustment	Manual (approx. 1:1.35)		
Lamp (light source)	UHE lamp, 150 W, Model No.: ELPLP17		
Max. audio output	5W monaural		
Speaker	1		
Power supply	100 – 120 VAC, 2.7A 200 – 240 VAC, 1.3A 50/60 Hz		
Operating temperature	+5°C – +35°C (No condensation)		
Storage temperature	-10°C – +60°C (No condensation)		
Weight	Approx. 4.2 kg (9.3 lbs)		
Connectors	Computer 1:	1	DVI-I
	Computer 2/Component Video:	1	Mini D-Sub 15-pin (female)
	Audio 1:	1	Stereo mini jack
	Video:	1	RCA pin jack
	S-Video:	1	Mini DIN 4-pin
	Audio 2:	1	RCA pin jack x 2 (L, R)
	USB:	1	USB connectors (B series)
	Control (RS-232C):	1	D-Sub 9-pin (male)
	Monitor Out:	1	Mini D-Sub 15-pin (female)
Remote:	1	Stereo mini jack	

---

## Safety

### USA

UL1950 3<sup>rd</sup> Edition

### Canada

CSA C22.2 No.950 -95 (cUL)

### European Community

The Low Voltage Directive (73/23/EEC)

IEC60950 2<sup>nd</sup> Edition, +Amd.1, +Amd.2, +Amd.3, +Amd.4

## EMC

### USA

FCC 47CFR Part15B Class B (DoC)

### Canada

ICES-003 Class B

### European Community

The EMC Directive (89/336/EEC)

EN55022, 1998 Class B

EN55024, 1998

IEC61000-4-2, IEC61000-4-3, IEC61000-4-4, IEC61000-4-5,

IEC61000-4-6, IEC61000-4-8, IEC61000-4-11,

IEC61000-3-2, IEC61000-3-3

### Australia/New Zealand

AS/NZS 3548:1995, A1:1997, A2:1997 Class B

CISPR Pub.22:1993, A1:1995, A2:1996, Class B

# Appearance

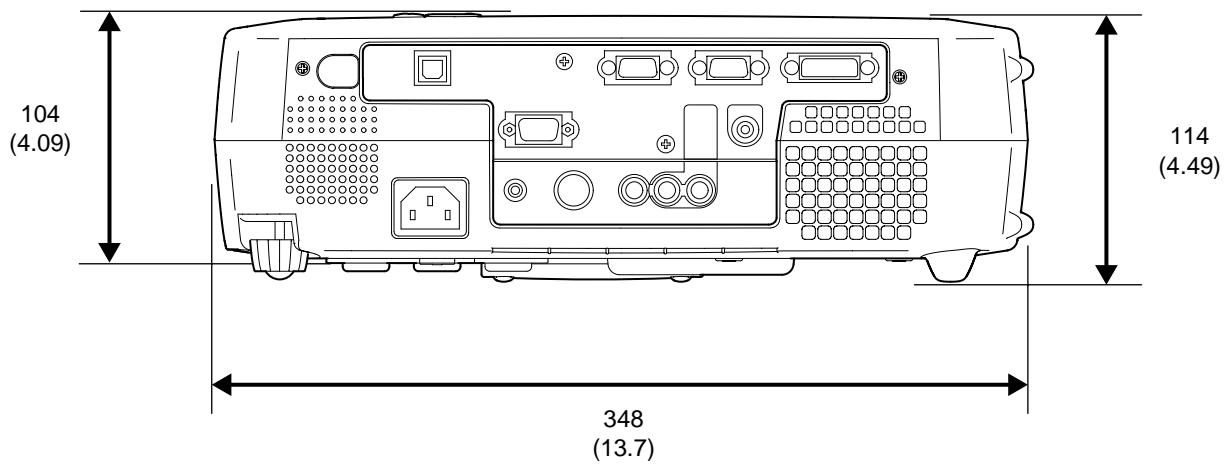
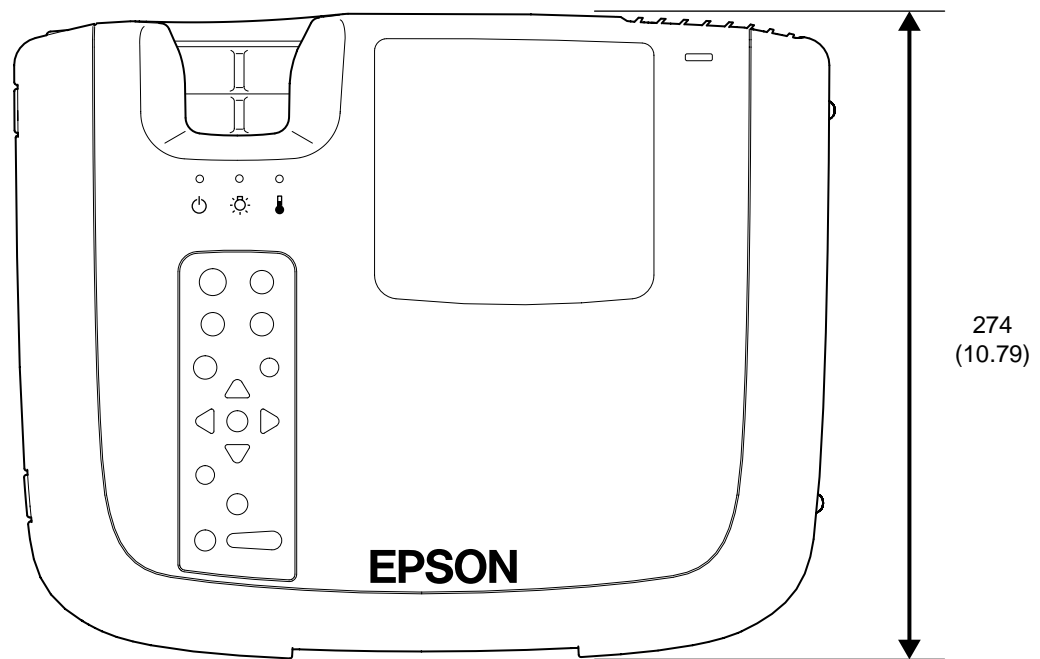
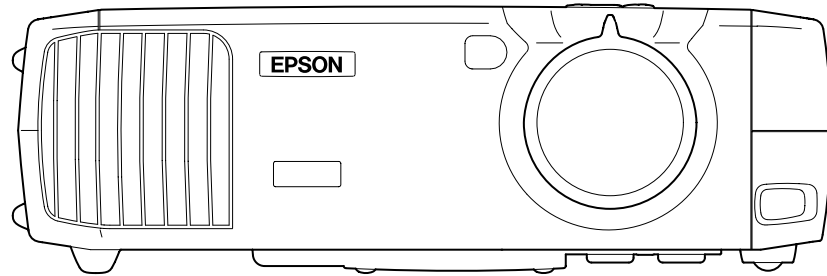



Units: mm (inch)

# Part Names and Functions

Front/ Top    Rear    Remote control  
Control panel    Base

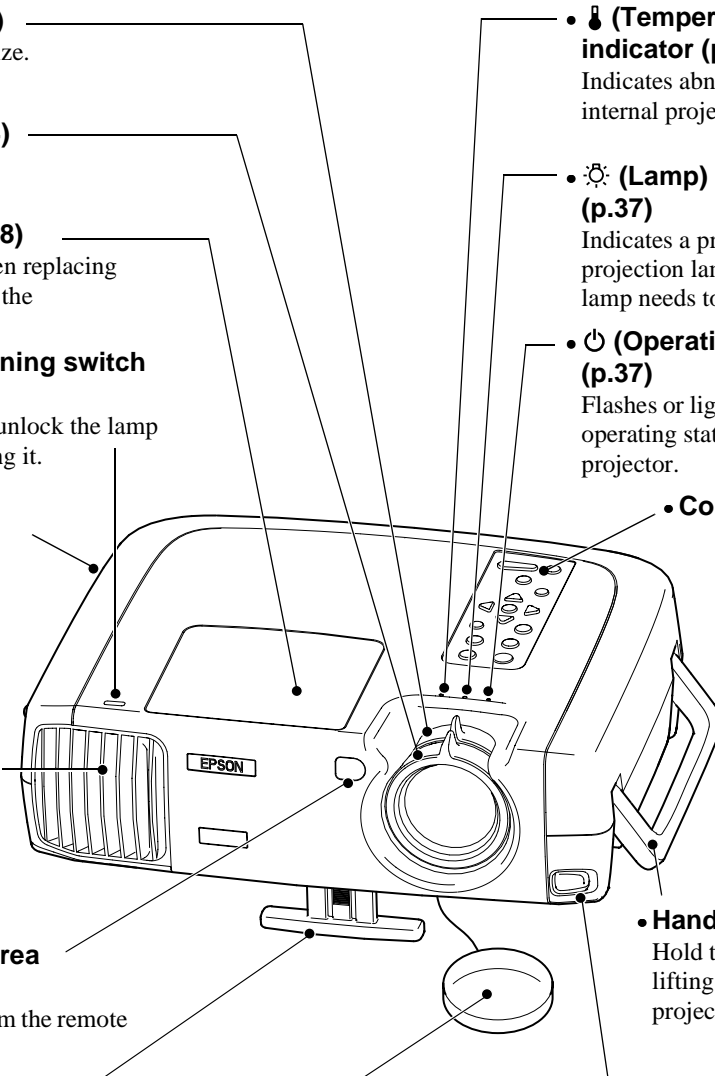
## Front/ Top

- 
- **Zoom ring (p.11)**  
Adjusts the image size.
- **Focus ring (p.14)**  
Adjusts the image focus.
- **Lamp cover (p.48)**  
Open this cover when replacing the lamp unit inside the projector.
- **Lamp cover opening switch (p.48)**  
Slide this switch to unlock the lamp cover when removing it.
- **Security lock** (p.64)  
(  ) (p.64)
- **Air exhaust vent**
- **Remote control light-receiving area (Setup Guide)**  
Receives signals from the remote control.
- **Front adjustable foot (p.11)**  
Extend and retract to adjust the projection angle.
- **Lens cover**  
Attach when not using the projector to prevent the lens from becoming dirty or damaged.
- **Foot adjust button (p.11)**  
Press this button while lifting up the projector in order to make fine adjustments to the adjustable foot or to retract it.
- **(Temperature) indicator (p.37)**  
Indicates abnormalities in the internal projector temperature.
- **(Lamp) indicator (p.37)**  
Indicates a problem with the projection lamp or that the lamp needs to be replaced.
- **(Operation) indicator (p.37)**  
Flashes or lights to indicate the operating status of the projector.
- **Control panel (p.60)**
- **Handle**  
Hold this handle when lifting and transporting the projector.

## Control Panel

- 
- **[Power] button (p.7)**  
Turns the projector power on and off.
  - **[Computer/YCbCr] button (p.7)**  
Changes the image source between the Computer 1 port and the Computer 2/Component Video port.
  - **[Menu] button (p.28)**  
Displays or hides the menus.
  - **[V-Keystone] button (p.13)**  
Press this button if the projected image has vertical keystone distortion.  
If you press and hold the [Shift] button while pressing this button, you can adjust the synchronization of computer images.
  - **[Shift] button (p.16, 17)**  
This button does not function by itself. Press and hold this button while pressing either [Keystone] button to activate the function that is printed in orange on the control panel (**Sync** or **Tracking**).
  - **[A/V Mute] button (p.30)**  
Turns off the audio and video.
  - **[Help] button (p.36)**  
Displays the online help menu to assist you if you have a problem.
  - **[Video] button (p.7)**  
Changes the image source between the Video port and the S-Video port.
  - **[Esc] button (p.29, 36)**  
Press to cancel the function currently being used. Pressing [Esc] while viewing an environment setting menu or the online help displays the previous screen or menu.
  - **[Auto] button (p.16, 28, 36)**  
Automatically adjusts the computer image to the optimum image.  
Functions as an  button when an environment setting menu or help screen is being displayed. Press to select an item and proceed to the next screen.
  - **[H-Keystone] button (p.13)**  
Press this button if the projected image has horizontal keystone distortion.  
If you press and hold the [Shift] button while pressing this button, you can adjust the tracking of computer images.
  - **[Resize] button (p.11, 15)**  
Changes the aspect ratio.
  - **[Volume] button (p.18)**  
Adjusts the volume of the built-in speaker.

## Rear

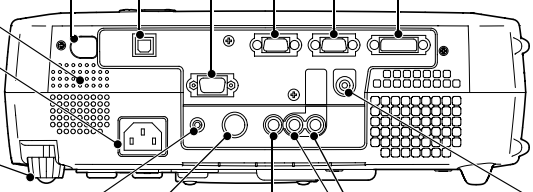
- 
- Control (RS-232C) port**  
 Connects the projector to a computer using an RS-232C cable. This port is for service use, and should not normally be used.
  - USB port (Setup Guide)**  
 Connects the projector to a computer using a USB cable.
  - Remote control light-receiving area (Setup Guide)**  
 Receives signals from the remote control.
  - Speaker**
  - Power inlet (p.6)**  
 Connects the power cord.
  - Rear adjustable foot (p.12)**  
 Extend and retract to adjust the horizontal projection angle.
  - Remote port**  
 Connects an optional remote control receiver to the projector.
  - S-Video port (Setup Guide)**  
 Inputs an S-Video signal to the projector from other video sources.
  - Video port (Setup Guide)**  
 Inputs composite video signals to the projector from other video sources.
  - Monitor Out port (Setup Guide)**  
 Outputs the projected analog image signal from a computer to an external monitor. This is not available for digital image signals being input to the Computer 1 port or signals from other video sources. Remove the cover when using this port.
  - Computer 2/ Component Video port (Setup Guide)**  
 Inputs component video images from a video source or analog video signals from a computer.
  - Computer 1 port (Setup Guide)**  
 Inputs digital/analog RGB image signals from a computer.
  - Audio 1 port (Setup Guide)**  
 Inputs audio signals. Connects using a stereo mini jack.
  - Audio 2 port (Setup Guide)**  
 Inputs audio signals.

## Base

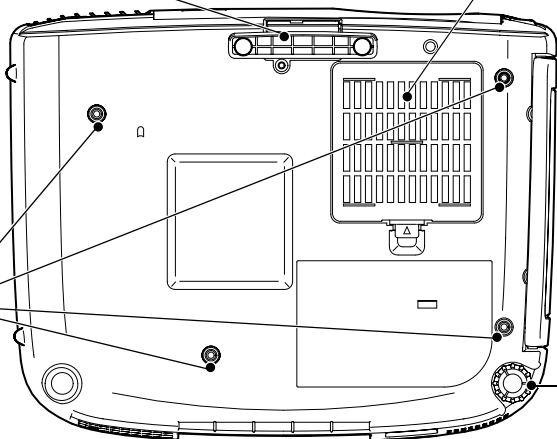
- 
- Front adjustable foot**
  - Air filter (air inlet) (p.46, 50)**  
 Prevents dust and other foreign particles from being drawn into the projector. When replacing the lamp, replace the air filter also.
  - Suspension bracket fixing points (4 points) (p.53, Setup Guide)**  
 Install the optional ceiling mount here when suspending the projector from the ceiling.
  - Rear adjustable foot**

## Remote Control

### • Remote control light-emitting area (*Setup Guide*)



Outputs infrared remote control signals.

- **[Freeze] button (p.30)**  
Keeps the current computer or video image on the screen.

- **[A/V Mute] button (p.30)**  
Turns off the audio and video.

- **[E-Zoom] button (p.31)**  
Enlarges or reduces the size of the image without changing the size of the projection area.

- **Colortune button (p.14)**  
Changes the color mode in accordance with the button pressed.

- **[ (Illumination) ] button (*Setup Guide*)**  
All buttons other than the [Enter], [Esc] and  buttons illuminate for 10 seconds each time this button is pressed.

- **Cover**  
Open to use the buttons that are underneath the cover.

### • Indicator

Lights when a remote control signal is being output.

### • [Power] button (p.7)

Turns the projector power on and off.

### • R/C switch (p.7)

Turns the remote control power on and off.

### • [Enter] button (p.28, 36, *Setup Guide*)

If pressed when an environment setting menu or help screen is being displayed, the menu item is selected and the next menu screen appears.

If a computer is connected and the remote control is being used as a wireless mouse, the button can be tilted up, down and to the left or right to move the pointer in the tilted direction. When pressed, it functions in the same way as a left mouse button.

### • [Esc] button (p.29, 36, *Setup Guide*)

Press to cancel the function currently being used. Pressing [Esc] while viewing an environment setting menu or the online help displays the previous screen or menu. If a computer is connected and the remote control is being used as a wireless mouse, it functions as a right mouse button.

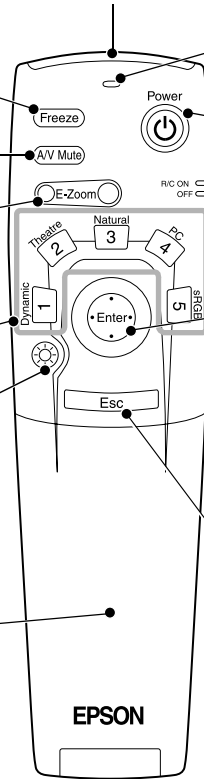

## Underneath cover

- **[Menu] button (p.28)**  
Displays or hides the environment setting menus.

- **[Comp1] button (p.7)**  
Changes the image source to the signals being input to the Computer 1 port.

- **[S-Video] button (p.7)**  
Switches to the images input from the S-Video port.

- **[Auto] button (p.16)**  
Automatically adjusts computer images to the optimum images.

- **[P in P] button (p.32)**  
Activates the P in P (Picture in Picture) function.

- **[Volume] button (p.18)**  
Adjusts the volume of the built-in speaker.

### • [Help] button (p.36)

Displays the online help menu.

### • [Comp2/YCbCr] button (p.7)

Changes the image source to the signals being input to the Computer 2/Component Video port.

### • [Video] button (p.7)

Switches to the images input from the Video port.

### • [Resize] button (p.11, 15)

Changes the aspect ratio .

### • [Preset] button (p.22)

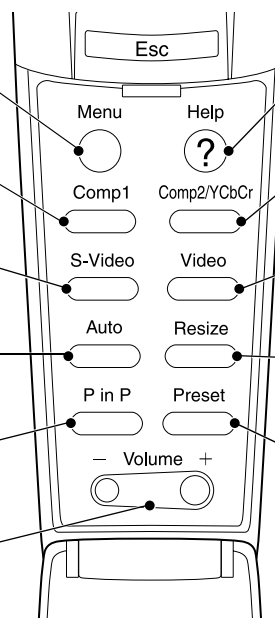

Selects one of the computer image resolutions that have been preset.





# Glossary

Following is an explanation of some of the terms used in this guide which may be unfamiliar or which were not explained in the manual itself. Further information can be obtained by referring to other commercially-available publications.

5BNC	A port used to input analog video signals.
A/V Mute	The momentary canceling of audio and video output. This projector has an [A/V Mute] button which you can press to momentarily stop the projection of pictures and sound. The picture and sound can be restored by pressing the [A/V Mute] button on the projector's control panel or the remote control once more.
Aspect ratio	The ratio between an image's length and its height. HDTV images have an aspect ratio of 16:9 and appear elongated. The aspect ratio for standard images is 4:3.
Color difference signal (component)	A type of video signal output by video equipment which actually consists of three separate signals: a red + luminance signal (R-Y), a luminance signal (Y) and a blue + luminance signal (B-Y). Each signal is transmitted along a separate cable. Color difference signals generally result in a better image than composite signals (in which the red, green and blue signals and the luminance signal are all transmitted along a single cable).
Color temperature	The temperature of an object which is emitting light. If the color temperature is high, the colors tend to take on a bluish tinge. If the color temperature is lower, the colors tend to take on a reddish tinge.
Component video	Video signals which have the video brightness signals and color signals separated, in order to provide better image quality. In high-definition TV (HDTV), it refers to images which consist of three independent signals: Y (luminance signal), and Pb and Pr (color difference signals  ).
Composite video	Video signals which have the video brightness signals and color signals mixed together. The type of signals commonly used by household video equipment (NTSC format). The signals consist of the carrier signal Y (luminance signal) and the chroma (color) signal which are contained in the color bar signal.
Contrast	The relative brightness of the light and dark areas of an image can be increased or decreased in order to make text and graphics stand out more clearly, or to make them appear softer.
Cool-down	The cooling process for the projector's lamp unit continues even after the [Power] button has been pressed to turn off the lamp. After the lamp turns off, the cooling fan continues operating, but all button operations are disabled. The length of time that this is happening is called the "cool-down period". The cool-down period lasts for about 2 minutes. The actual time will vary depending on the external air temperature.
DFP	Abbreviation for Digital Flat Panel. Refers to a standard method for digital transmission of video signals.
Dolby Digital	A proprietary sound format developed by Dolby Laboratories. Normal stereo is a 2-channel format that uses two speakers. Dolby Digital is a 6-channel (5.1 channel) format that adds to this a center speaker, two rear speakers and a sub-woofer.
DVI	Abbreviation for Digital Visual Interface. Refers to a standard method for digital transmission of video signals. DVI is a standard which has also been applied to digital household electronic equipment other than computers. It allows images to be transmitted at higher resolutions than for DFP.
Freeze	The momentary pausing of image playback only. When the [Freeze] button is pressed, the image playback only can be paused. When the [Freeze] button is pressed again, playback resumes.
HDTV	An abbreviation for High-Definition Television. It refers to high-definition systems which satisfy the following conditions. Vertical resolution of 750p or 1125i or greater (p = progressive scanning, i = <u>interlaced scanning</u>  ) Screen aspect ratio of 16:9 <u>Dolby Digital</u>  audio reception and playback (or output)
Interlaced scanning	A method of image scanning whereby the signal bandwidth used is approximately half that required for sequential scanning when images with the same still picture resolution are broadcast.
Refresh Rate	The light-emitting element of a display maintains the same luminosity and color for an extremely short time. Because of this, the image must be scanned many times per second in order to refresh the light emitting element. The number of refresh operations per second is called the "refresh rate", and is expressed in hertz (Hz).

S-Video	A video signal which has the luminance component and color component separated in order to provide better image quality. It refers to images which consist of two independent signals: Y (luminance signal), and C (color signal).
SDTV	An abbreviation for Standard Definition Television. It refers to standard television systems which do not satisfy the conditions for High-Definition Television.
Security lock	A device consisting of a projector case with a hole in it that a commercially-available theft-prevention cable can be passed through in order to secure the device to a table or pillar. This projector is compatible with the Microsaver Security System manufactured by Kensington.
sRGB	An international standard for color intervals that was formulated so that colors which are reproduced by video equipment can be handled easily by computer operating systems (OS) and the Internet.
SVGA	A type of video signal with a resolution of 800 (horizontal) x 600 (vertical) dots which is used by IBM PC/AT-compatible computers (DOS/V computers).
SXGA	A type of video signal with a resolution of 1,280 (horizontal) x 1,024 (vertical) dots which is used by IBM PC/AT-compatible computers (DOS/V computers).
Sync (synchronization)	The signals output from computers have a specific frequency. If the projector frequency does not match this frequency, the resulting images will not be of a good quality. The process of matching the phases of these signals (the relative position of the crests and troughs in the signal) is called "synchronization". If the signals are not synchronized, problems such as flickering, blurriness and horizontal interference can occur.
Tracking	The signals output from computers have a specific frequency. If the projector frequency does not match this frequency, the resulting images will not be of a good quality. The process of matching the frequency of these signals (the number of crests in the signal) is called "tracking". If tracking is not carried out correctly, wide vertical stripes will appear in the projected images.
USB	An abbreviation for Universal Serial Bus. USB is an interface for connecting personal computers to peripheral devices which only support relatively low data transmission speeds.
VGA	A type of video signal with a resolution of 640 (horizontal) x 480 (vertical) dots which is used by IBM PC/AT-compatible computers (DOS/V computers).
XGA	A type of video signal with a resolution of 1,024 (horizontal) x 768 (vertical) dots which is used by IBM PC/AT-compatible computers (DOS/V computers).
YCbCr	The carrier signal which is contained in the color bar signal used in modern TV transmissions (NTSC format). The name comes from the Y (luminance) signal and the CbCr (chroma [color]) signals.
YPbPr	The carrier signal which is contained in the color bar signal used in high-definition TV (HDTV) transmissions. The name comes from the Y (luminance) signal and the PbPr (color difference) signals ▶.



## General Terms

### A

A/V Mute function .....	24, 30
About menu .....	26
Advanced menu .....	25
Air filter cleaning .....	46
Air filter replacement .....	50
Appearance .....	58
Aspect ratio .....	15
Audio input .....	23
Audio menu .....	23
Audio1 port .....	61, Setup Guide
Audio2 port .....	61, Setup Guide
Automatic adjustment .....	16

### B

Bass .....	23
Battery compartment cover (Remote control) .....	Setup Guide
Battery Replacement Period and Cautions (Remote control) .....	Setup Guide
Brightness .....	21, 22

### C

Ceiling .....	25, 53, 61, Setup Guide
Cleaning .....	46
Color adjustment .....	25
Color mode .....	14, 21, 22
Color temperature .....	25
Color .....	21
COM port .....	25
Component video .....	54, 61, Setup Guide
Composite video .....	54, 61, Setup Guide
Computer connections .....	Setup Guide
Computer1 port .....	7, 61, Setup Guide
Computer2/ Component Video port .....	7, 61, Setup Guide
Connectors .....	56, 61
Contrast .....	21, 22
Control (RS-232C) port .....	61
Control panel .....	60
Cool-down .....	9, 37
Cross .....	31

### D

DFP .....	53
Digital video cable .....	53
Digital-RGB .....	53, 61, Setup Guide

DVI .....	53
-----------	----

### E

Environment Setting Menu Functions .....	20
External monitor .....	Setup Guide
E-Zoom function .....	31

### F

Focus ring .....	14, 59
Focus .....	14
Foot adjust button .....	11, 59
Foot adjustment .....	11
Freeze function .....	30
Frequency .....	26
Front adjustable foot .....	13, 59, 61

### G

Glossary .....	63
----------------	----

### H

Handle .....	59
HDTV .....	15, 54
Horizontal keystone .....	13, 24

### I

Image adjustment .....	14
Indicators .....	37, 59
Input signal .....	26
Inserting batteries (Remote control) .....	Setup Guide
Installation .....	Setup Guide

### K

Keystone correction .....	12
---------------------------	----

### L

Lamp cover .....	48, 59
Lamp indicator .....	37, 59
Lamp replacement period .....	47
Lamp replacement .....	48
Lamp resetting .....	26, 49
Lamp .....	26, 49
Language .....	25
Lens cleaning .....	46
Lens cover .....	59

### M

Main menu .....	20
Menus .....	20
Monitor out port .....	61, Setup Guide

**N**

- Noise reduction..... 21
- No-Signal..... 24

**O**

- Operating temperature..... 56
- Operation indicator..... 37, 59
- Optional accessories..... 53
- Overheating..... 38

**P**

- P in P function..... 24, 32
- Part Names and Functions..... 59
- Picture in Picture..... 24, 32
- Position..... 16, 21, 22
- Power cord..... 6
- Power inlet..... 6, 61
- Preset..... 22
- Projection angle..... 11
- Projection distance..... Setup Guide
- Prompt..... 24

**R**

- R/C switch..... 7, 62
- Rear adjustable foot..... 12, 61
- Refresh Rate..... 26
- Remote port..... 61
- Remote control light-receiving area  
.....59, 61, Setup Guide
- Remote control light-emitting area.....62, Setup Guide
- Remote control.....62, Setup Guide
- Reset All menu..... 27
- Resized display..... 11, 15, 54
- Resolution..... 22, 26, 55
- RGB..... 25
- RGB video.....20, 54, Setup Guide

**S**

- Screen size..... Setup Guide
- SDTV..... 15, 54
- Security lock..... 59
- Setting menu..... 23
- Sharpness..... 21, 22
- Sleep mode..... 24
- Speaker..... 61
- Specifications..... 56
- sRGB..... 14, 21, 22
- Startup screen..... 25

- Storage temperature..... 56
- Sub-menu..... 20
- Supported Signal Resolutions..... 54
- S-Video..... 54, 64, Setup Guide
- S-Video port..... 7, 61, Setup Guide
- SYNC Mode..... 26
- SYNC Polarity..... 26
- Sync..... 17, 22
- Synchronization..... 17, 22

**T**

- Temperature indicator..... 37, 59
- Tint..... 21
- Tracking..... 17, 22
- Treble..... 23
- Turning off..... 9

**U**

- USB port..... 61, Setup Guide
- USB mouse..... Setup Guide
- User's Logo menu..... 24
- User's Logo saving..... 51
- Using the Help..... 36
- Using the Menus..... 28

**V**

- Vertical keystone..... 13, 23
- Video port..... 7, 61, Setup Guide
- Video menu..... 20
- Video Signal..... 21, 26
- Video source connection..... Setup Guide
- Video Source..... 26
- Volume..... 18, 23

**W**

- Wide-screen..... 15
- Window display..... 11
- Wireless mouse..... Setup Guide

**Y**

- YCbCr..... 20, 24
- YPbPr..... 20

**Z**

- Zoom ring..... 11, 59

## **DECLARATION of CONFORMITY**

According to 47CFR, Part 2 and 15  
Class B Personal Computers and Peripherals; and/or  
CPU Boards and Power Supplies used with Class B  
Personal Computers

We : EPSON AMERICA, INC.  
Located at : 3840 Kilroy Airport Way  
MS: 3-13  
Long Beach, CA 90806  
Tel : 562-290-5254

Declare under sole responsibility that the product identified herein, complies with 47CFR Part 2 and 15 of the FCC rules as a Class B digital device. Each product marketed, is identical to the representative unit tested and found to be compliant with the standards. Records maintained continue to reflect the equipment being produced can be expected to be within the variation accepted, due to quantity production and testing on a statistical basis as required by 47CFR 2.909. Operation is subject to the following two conditions : (1) this device may not cause harmful interference, and (2) this device must accept any interference received, including interference that may cause undesired operation.

Trade Name : EPSON  
Type of Product : Projector  
Model : EMP-TS10 / ELP-TS10

## **FCC Compliance Statement For United States Users**

This equipment has been tested and found to comply with the limits for a Class B digital device, pursuant to Part 15 of the FCC Rules. These limits are designed to provide reasonable protection against harmful interference in a residential installation. This equipment generates, uses, and can radiate radio frequency energy and, if not installed and used in accordance with the instructions, may cause harmful interference to radio or television reception. However, there is no guarantee that interference will not occur in a particular installation. If this equipment does cause interference to radio and television reception, which can be determined by turning the equipment off and on, the user is encouraged to try to correct the interference by one or more of the following measures.

- Reorient or relocate the receiving antenna.
- Increase the separation between the equipment and receiver.
- Connect the equipment into an outlet on a circuit different from that to which the receiver is connected.
- Consult the dealer or an experienced radio/TV technician for help.

### **WARNING**

The connection of a non-shielded equipment interface cable to this equipment will invalidate the FCC Certification or Declaration of this device and may cause interference levels which exceed the limits established by the FCC for this equipment. It is the responsibility of the user to obtain and use a shielded equipment interface cable with this device. If this equipment has more than one interface connector, do not leave cables connected to unused interfaces. Changes or modifications not expressly approved by the manufacturer could void the user's authority to operate the equipment.

All rights reserved. No part of this publication may be reproduced, stored in a retrieval system, or transmitted in any form or by any means, electronic, mechanical, photocopying, recording, or otherwise, without the prior written permission of SEIKO EPSON CORPORATION. No patent liability is assumed with respect to the use of the information contained herein. Neither is any liability assumed for damages resulting from the use of the information contained herein.

Neither SEIKO EPSON CORPORATION nor its affiliates shall be liable to the purchaser of this product or third parties for damages, losses, costs, or expenses incurred by purchaser or third parties as a result of: accident, misuse, or abuse of this product or unauthorized modifications, repairs, or alterations to this product, or (excluding the U.S.) failure to strictly comply with SEIKO EPSON CORPORATION's operating and maintenance instructions.

SEIKO EPSON CORPORATION shall not be liable against any damages or problems arising from the use of any options or any consumable products other than those designated as Original EPSON Products or EPSON Approved Products by SEIKO EPSON CORPORATION.

EPSON is a registered trademark and PowerLite is a trademark of SEIKO EPSON CORPORATION.

**General Notice:** The following trademarks and registered trademarks are the property of their respective owners and are used in this publication for identification purposes only.

- EPSON/Seiko Epson Corp.
- Macintosh, PowerBook/Apple Computer Inc.
- IBM/International Business Machine Corp.
- Windows/Microsoft Corp.

Other product names used herein are also for identification purposes only and may be trademarks of their respective owners. EPSON disclaims any and all rights in those marks.

**EPSON®**

E



Printed on 100% recycled paper.



Printed in Japan  
402171700  
(9002556)  
02.01-.\*A(C05)