

EPSON AcuLaser™ 8500

COLOR COPY STATION

All rights reserved. No part of this publication may be reproduced, stored in a retrieval system, or transmitted in any form or by any means, mechanical, photocopying, recording, or otherwise, without the prior written permission of SEIKO EPSON CORPORATION. No patent liability is assumed with respect to the use of the information contained herein. Neither is any liability assumed for damages resulting from the use of the information contained herein.

Neither SEIKO EPSON CORPORATION nor its affiliates shall be liable to the purchaser of this product or third parties for damages, losses, costs, or expenses incurred by purchaser as a result of: accident, misuse, or abuse of this product or unauthorized modifications, repairs, or alterations to this product, or (excluding the U.S.) failure to strictly comply with SEIKO EPSON corporation's operating and maintenance instructions.

SEIKO EPSON CORPORATION shall not be liable against any damages or problems arising from the use of any options or any consumable products other than those designated as Original EPSON Approved Products by SEIKO EPSON CORPORATION.

EPSON is a registered trademark of SEIKO EPSON CORPORATION.

General Notice: Other product names used herein are for identification purposes only and may be trademarks of their respective owners. EPSON disclaims any and all rights in those marks.

Copyright © 2000 by SEIKO EPSON CORPORATION, Nagano, Japan

Reference Guide

DECLARATION of CONFORMITY

According to 47CFR, Part 2 and 15 for Class B Personal Computers and Peripherals;
and/or CPU Boards and Power Supplies used with Class B Personal Computers:

We: EPSON AMERICA, INC.
Located at: MS 6-43
3840 Kilroy Airport Way
Long Beach, CA 90806-2469
Telephone: (562)290-5254

Declare under sole responsibility that the product identified herein, complies with 47CFR Part 2 and 15 of the FCC rules as a Class B digital device. Each product marketed, is identical to the representative unit tested and found to be compliant with the standards. Records maintained continue to reflect the equipment being produced can be expected to be within the variation accepted, due to quantity production and testing on a statistical basis as required by 47CFR §2.909 Operation is subject to the following two conditions: (1) this device may not cause harmful interference, and (2) this device must accept any interference received, including interference that may cause undesired operation.

Trade Name: EPSON
Type of Product: Color Copy Station
Model: EU-42

Contents

Introduction

Safety Precautions	1
Warnings, Cautions, and Notes.	3
Restrictions on Copying	3

Chapter 1 Getting to Know Your Copy Station

Copy Station Parts	1-2
Control panel.	1-3
LCD touch screen	1-5
Options and Consumable Products	1-7
Printer options (EPSON AcuLaser C8500)	1-7
Scanner options.	1-8
Consumable products	1-9

Chapter 2 Basic Copying

Making Simple Copies	2-2
Getting ready to copy	2-2
Making copies	2-4

Chapter 3 Paper Handling

Available Paper	3-2
EPSON special media	3-2
General paper	3-3
Paper that should not be used	3-4
Paper Sources	3-5
MP tray.	3-5
Standard lower cassette	3-6
Large Capacity Paper Unit	3-6

Output Trays	3-7
Face-down tray	3-7
Face-up tray	3-9
Loading Paper	3-10
Loading the MP tray	3-10
Loading the lower cassette and the Large Capacity Paper Unit	3-13
Printing on Special Media	3-17
EPSON Color Laser Paper	3-17
EPSON Color Laser Transparencies	3-17
EPSON Color Laser Coated Paper	3-18

Chapter 4 Basic Settings Using the Control Panel

Changing MP Tray Settings	4-2
Making Zoom Settings	4-5
Selecting a fixed zoom ratio	4-5
Specifying a zoom ratio	4-7
Using the Fit-to-Page option	4-9
Using 1-Sided and 2-Sided Copy Modes	4-10
Making Document Type Settings	4-12
Adjusting Brightness and Color	4-14
Adjusting brightness	4-14
Adjusting color	4-15
Storing Your Settings	4-23
Storing settings	4-23
Selecting stored settings	4-25
Deleting stored settings	4-27

Chapter 5 Using Advanced Copy Modes

Advanced Copy Mode Introduction	5-2
Using the Join Pages Mode	5-3
Setting the Binding Margin	5-7
Using the Split Pages Mode	5-11
Using the Remove Shadows Mode	5-15
Using the Collate Mode	5-19

Chapter 6 Using the Administrator Mode

Checking Copy Station Status	6-2
Making Administrator Mode Settings	6-3
Key Tone	6-4
Standby Control	6-4
Auto Feed	6-5
Set Defaults Copy Job	6-5
Color Calibration	6-6
Select Language	6-10
Copy Unit Restore Defaults	6-11

Chapter 7 Maintenance and Transportation

Cleaning the Copy Station	7-2
Transporting the Copy Station	7-2

Chapter 8 Troubleshooting

Copying Problems	8-2
Printing problems	8-2
The edges of a document are not copied	8-3
The copy is too light or too dark	8-4
Copied colors differ from the original	8-4
Error Messages	8-5
Printer errors	8-5
Scanner errors	8-15
Copy system errors	8-18

Appendix A Technical Specifications

Supported Printer and Scanner	A-2
Printer Interface Board Specifications	A-2
Scanner Interface Board Specifications	A-2
EMC Conformity	A-3
Control Panel Dimensions	A-3

Environmental Conditions A-3
Service Life A-4
Control Panel. A-4

Glossary

Index

Introduction

Safety Precautions

Read all of these instructions and save them for later reference.

- Follow all warnings and instructions marked on the copy station.
- Do not place the product on an unstable surface or near a radiator or heat source.
- Place the product on a flat surface. The product will not operate properly if it is tilted or at an angle.
- Before moving the copy station, unplug the scanner and printer and remove them from the cabinet.
- Do not block or cover the openings in the printer or the scanner.
- Do not insert objects through the slots in the printer or the scanner.
- Use only the type of power source indicated on the printer and scanner labels.
- Connect all equipment to properly grounded power outlets. Avoid using outlets on the same circuit as photocopiers or air control systems that regularly switch on and off.
- Do not use a damaged or frayed power cord.

- ❑ If you use an extension cord with the copy station, make sure the total ampere rating of all devices plugged into the extension cord does not exceed the cord's ampere rating. Also, make sure the total of all devices plugged into the wall outlet does not exceed the wall outlet's ampere rating.
- ❑ Unplug the product before cleaning, and clean it with a damp cloth only.
- ❑ Do not spill liquid on the copy station.
- ❑ Unless otherwise explained in this guide, do not attempt to service this product yourself.
- ❑ Unplug the copy station and refer servicing to qualified service personnel under the following conditions:

If a power cord or plug is damaged; if liquid has entered the copy station; if any copy station component has been dropped or the cabinet damaged; or if the copy station does not operate normally or exhibits a distinct change in performance. Adjust only those controls that are covered by the operating instructions.

- ❑ For European users:

Warning: This is a Class A product. In a domestic environment this product may cause radio interference in which case the user may be required to take adequate measures.

Warnings, Cautions, and Notes



Warnings must be followed carefully to avoid bodily injury.



Cautions must be observed to avoid damage to your equipment.

Notes contain important information and useful tips on the operation of your copy station.

Restrictions on Copying

Operators of this copy system must observe the following restrictions in order to ensure the responsible and legal use of this product.

Copying of the following items is prohibited by law

- Bank bills, coins, government-issued marketable securities, government bond securities, and municipal securities
- Unused postage stamps, pre-stamped postcards, and other official postal items bearing valid postage
- Government-issued revenue stamps, and securities issued according to legal procedure

Exercise caution when copying the following items

- Private marketable securities (stock certificates, negotiable notes, checks, etc.), monthly passes, concession tickets, etc.
- Passports, driver's licenses, warrants of fitness, road passes, food stamps, tickets, etc.

Responsible use of copyrighted materials

Copy systems can be misused by improperly copying copyrighted materials. Unless acting on the advice of a knowledgeable attorney, be responsible and respectful by obtaining the permission of the copyright holder before copying published material.

Getting to Know Your Copy Station

Copy Station Parts	1-2
Control panel	1-3
LCD touch screen	1-5
Options and Consumable Products.....	1-7
Printer options (EPSON AcuLaser C8500)	1-7
Scanner options	1-8
Consumable products.....	1-9

Copy Station Parts

The copy station consists of the following components.

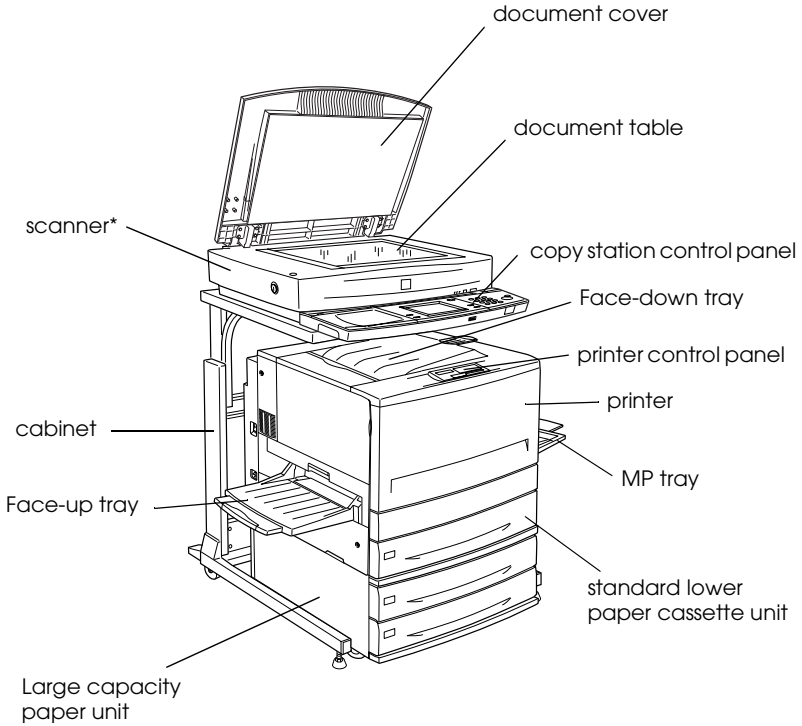

* EPSON GT-10000+ or EPSON EXPRESSION 1640XL

Control panel

The control panel consists of buttons, indicator lights, and an LCD touch screen. For explanations of control panel functions, match the letters in the following figure with those in the table below.

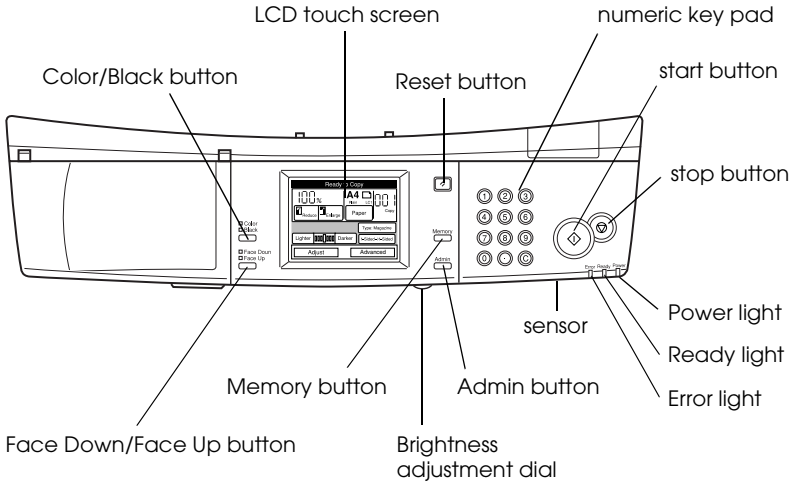

Name	Function
FaceDown/FaceUp button	Switches between the face-down tray and face-up tray.
Memory button	Selects, saves, or deletes user-defined copy job memories.
Brightness adjustment dial	Adjusts the brightness of the LCD touch screen.
Admin button	Displays the current copy station status and selects background settings such as copy job defaults, auto feed status, and color calibration.

Name	Function
Sensor	Detects the presence of the user and causes the printer to come out of standby mode.
Error light	On when an error has occurred.
Ready light	On when the copy station is ready for copying.
Power light	Lights when the printer power is turned on.
Stop button	Stops copying.
Start button	Starts copying.
Numeric key pad	Used to enter the number of copies, the zoom ratio, and other numeric values.
Reset button	Returns copy job settings to the default values specified in the Admin mode. If default values have not been set, the settings return to the factory defaults.
LCD touch screen	Displays settings, messages, and buttons. Use the buttons to make settings and carry out various copying tasks.
Color/Black button	Switches between color and monochrome copying.

LCD touch screen

The LCD touch screen displays information on current settings and copy station status. Use the touch screen buttons to make copy settings and to access advanced copying modes. For explanations of touch screen button functions, match the numbers in the following figure with those in the table below.

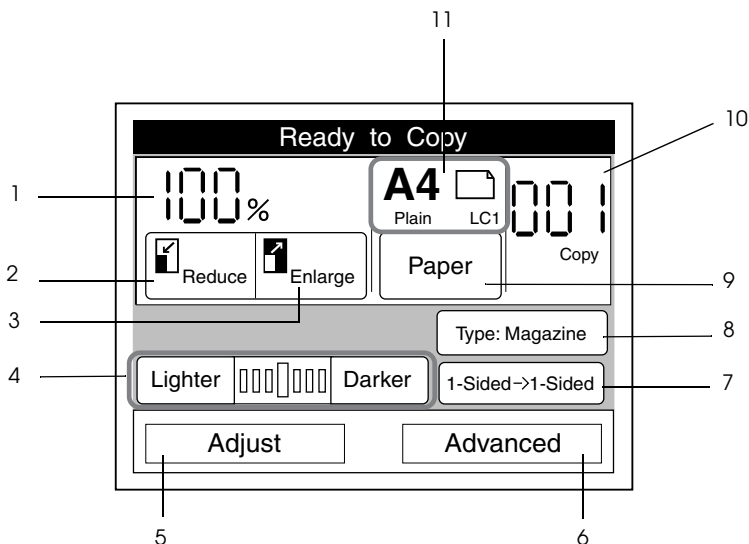

	Function
1	Sets the zoom ratio and displays the current zoom ratio.
2	Reduces the copy size.
3	Enlarges the copy size.
4	Adjusts copy brightness.

	Function
5	<p>Selects a color adjustment mode. The following color adjustment modes are available:</p> <ul style="list-style-type: none"> Contrast RGB Balance Saturation Hue
6	<p>Selects the advanced copy modes. The following modes are available:</p> <ul style="list-style-type: none"> Join Pages Margin Collate Split Pages Remove Shadows
7	Selects single-sided or double-sided copy modes.
8	<p>Selects a document type. The following document types are available:</p> <ul style="list-style-type: none"> Photo Text Magazine Map Detail
9	Sets a paper source, size, and document orientation.
10	Shows the number of copies.
11	Shows the current paper source.

Printer options (EPSON AcuLaser C8500)

You can add to your printer's capabilities by installing any of the following options:

The 250-Sheet Paper Cassette A3W (C813521) accommodates 250 sheets of A3W size paper.

The Large Capacity Paper Unit (C813501) holds two paper cassettes. It increases paper-feeding capacity up to 1,000 sheets of paper.

The Duplex Unit (C813531) provides for automatic printing on both sides of the paper.

The Hard Disk Drive (C823771) expands the printer's capacity by allowing you to print complex and large print jobs at high speed.

EPSON RIP Station 5300 (C85014*)

Note:

The asterisk () is a substitute for the last digit of the product number, which varies by country.*

An optional memory module expands your printer's memory, allowing you to print complex and graphics-intensive documents.

The Adobe® PostScript®3™ ROM Module (C832431) generates crisp PostScript output.

Interface cards provide your printer with serial, parallel, coaxial, twinaxial, or GPIB connections.

Scanner options

EPSON GT-10000+

The following options expand the capability of your scanner. For detailed information on their use, see the documentation included with the GT-10000+.

Automatic Document Feeder (B81321*)

The Automatic Document Feeder allows you to scan and copy up to 100 pages automatically.

EPSON Network Image Express (B80836*)

Enables an EPSON scanner supporting EPSON TWAIN Pro Network to become shareable on a network without the need for a scanner server PC, which allows you to use various scanning methods in a network environment with less power and space.

Note:

The asterisk () is a substitute for the last digit of the product number, which varies by country.*

EPSON EXPRESSION 1640XL

The following optional items are available to expand the versatility of your scanner. For detailed information on the use of these options, see the documentation included with the EPSON EXPRESSION 1640XL.

Automatic Document Feeder (B81321*)

The Automatic Document Feeder allows you to scan and copy up to 100 pages automatically.

Transparency Unit (B81320*)

Allows you to scan transparent materials; primarily 35 mm slides and filmstrips. The Transparency Unit's reading area allows you to scan film up to 290 × 420 mm in size.

EPSON Network Image Express (B80836*)

Enables an EPSON scanner supporting EPSON TWAIN Pro Network to become shareable on a network without the need for a scanner server PC, which allows you to use various scanning methods in a network environment with less power and space.

Note:

The asterisk () is a substitute for the last digit of the product number, which varies by country.*

Consumable products

The life of the following consumable products is monitored by the printer. The printer lets you know when replacements are needed.

Toner Cartridge (Black):	S050038
Toner Cartridge (Yellow):	S050039
Toner Cartridge (Magenta):	S050040
Toner Cartridge (Cyan):	S050041
Photoconductor Unit:	S051073
Waste Toner Collector:	S050020

The EPSON special media listed below provide you with the best-quality printouts.

EPSON Color Laser Paper (A4):	S041215
EPSON Color Laser Paper (A3):	S041216
EPSON Color Laser Paper (A3W):	S041217
EPSON Color Laser Paper (Letter):	S041218

EPSON Color Laser Transparencies (A4): S041175

EPSON Color Laser Transparencies (Letter): S041174

EPSON Color Laser Coated Paper (A4): S041383

EPSON Color Laser Coated Paper (A3): S041384



Caution:

- ❑ *Do not use other EPSON media such as EPSON special media for ink jet printers, as they can cause paper jams and damage the printer.*
- ❑ *Do not use the media listed above in any other printers, except when specified in the documentation.*

Chapter 2

Basic Copying

Making Simple Copies	2-2
Getting ready to copy	2-2
Making copies	2-4

Making Simple Copies

Follow the steps below to make simple copies.

Getting ready to copy

1. Make sure paper is loaded in the printer. See “Loading Paper” on page 3-10 for information on how to load paper.
2. Turn on the scanner by pressing the  OPERATE button.

Note:

Be sure to turn on the scanner power before turning on the printer power. Otherwise, the copy station may not recognize the scanner, and an error message will appear on the touch screen.

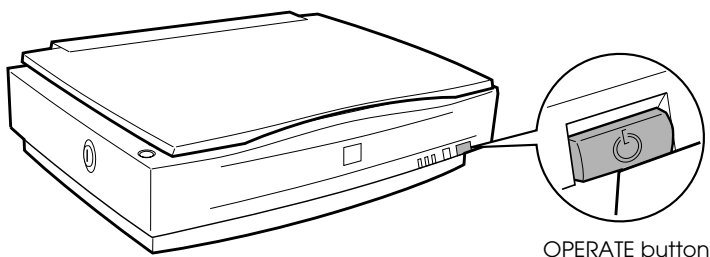

3. Turn on the printer by pressing the (I) side of its power switch.

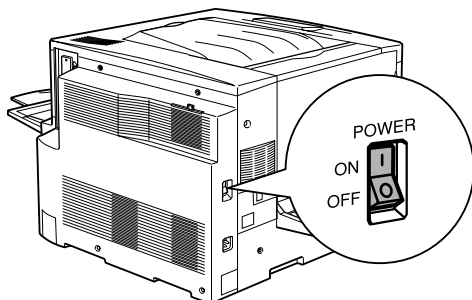

The following screen appears while the copy station is checking the printer and scanner connections.

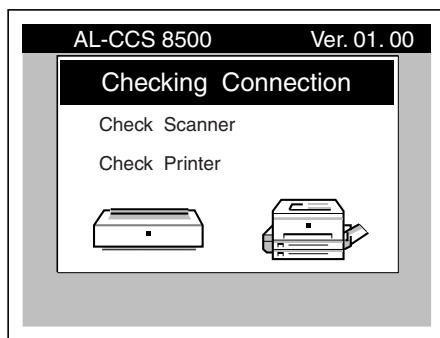

Caution:

Do not turn off the power while the copy station is checking the scanner and printer connections, or while copying is in progress.

When the following screen appears, the copy station is ready for copying.

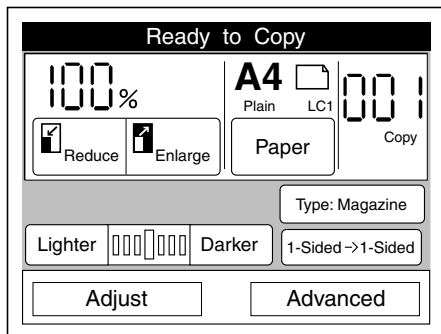

Making copies

1. Place your document on the document table, with the side to be scanned facing down.

You can scan documents up to 297 mm × 432 mm for the EPSON GT-10000+ or 310 mm × 432 mm for the EPSON EXPRESSION 1640XL.

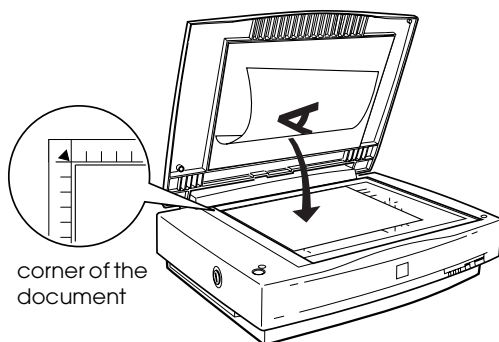

Use the document guide strip to align the horizontal edge of the document.

Note:

An area 2 ± 1.5 mm in from both horizontal and vertical rulers will not be scanned.

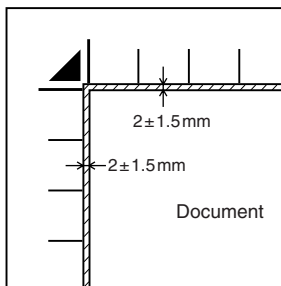

2. Close the document cover gently so that the document does not move.

Note:

Make sure the document is flat against the glass surface, otherwise the image will appear fuzzy and out of focus. Also be sure to close the document cover to prevent interference from external light.

3. Press the Color/Black button to select the color or monochrome copy mode. Select Color to copy in color, or Black to copy in black-and-white or grayscale.

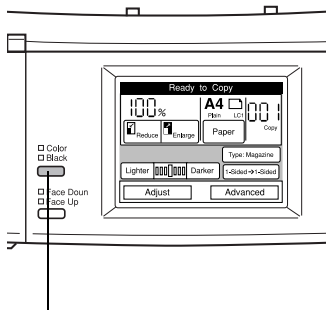

Color/Black button

4. Press the Paper button on the copy station control panel.

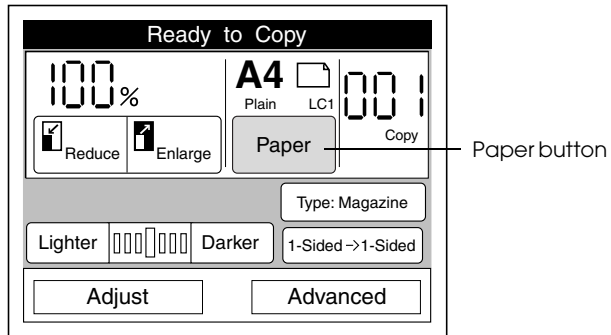

5. Select the paper source containing paper that matches the size and orientation of your document on the document table.

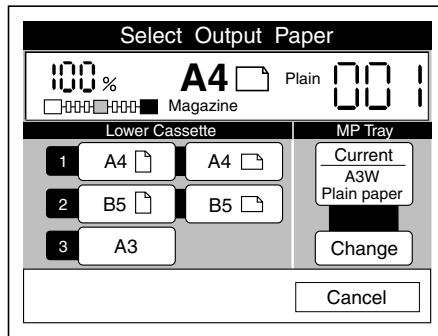

Note:

If you need to change the paper size or type settings for the MP Tray, see "Changing MP Tray Settings" on page 4-2.

6. If you are printing on media other than standard-size plain paper or EPSON Color Laser Paper, select the face-up tray by pressing the Face Up/Face Down button. See “Output Trays” on page 3-7 for more information.

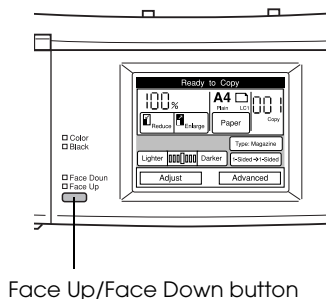

7. Use the key pad to specify the number of copies.
8. Press the  start button on the control panel. The document is scanned and then printed.

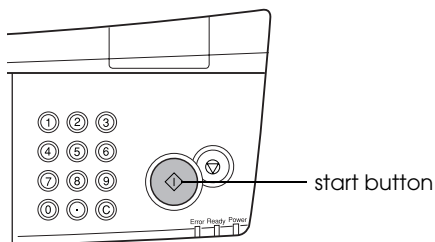

Chapter 3

Paper Handling

Available Paper	3-2
EPSON special media	3-2
General paper	3-3
Paper that should not be used	3-4
Paper Sources	3-5
MP tray	3-5
Standard lower cassette	3-6
Large Capacity Paper Unit	3-6
Output Trays	3-7
Face-down tray	3-7
Face-up tray	3-9
Loading Paper	3-10
Loading the MP tray	3-10
Loading the lower cassette and the Large Capacity Paper Unit	3-13
Printing on Special Media	3-17
EPSON Color Laser Paper	3-17
EPSON Color Laser Transparencies	3-17
EPSON Color Laser Coated Paper	3-18

Available Paper

This section explains what kind of paper you can use with your printer (EPSON AcuLaser C8500) used in this copy station. Avoid using paper not mentioned in this section.

Note:

The printer is extremely sensitive to moisture. Be sure to store your paper in a dry environment.

EPSON special media

EPSON provides special media that are created especially for the EPSON AcuLaser C8500.

EPSON Color Laser Paper

This media is designed specifically for the EPSON AcuLaser C8500. You can load this media from the MP tray, the standard lower cassette, or the Large Capacity Paper Unit.

S041215 (A4)

S041216 (A3)

S041217 (A3W)

S041218 (Letter)

EPSON Color Laser Transparencies

This media is designed specifically for this printer. You can load this media only from the MP tray.

S041175 (A4)

S041174 (Letter)

EPSON Color Laser Coated Paper

This media is designed specifically for high printing quality. You can load this media from the MP tray, the standard lower cassette, or the Large Capacity Paper Unit.

S041383 (A4)

S041384 (A3)



Caution:

Do not use the media listed above for any other printer, except when specified in the documentation.

General paper

You can use the following media in addition to EPSON special media introduced in the previous section.

Paper type	Description
Plain paper	Recycled paper is acceptable* Weight: 64 to 105 g/m ² (17 to 28 lb)
Thick paper	Weight: 106 to 220 g/m ²
Colored paper	Non-coated

* Use recycled paper only under normal temperature and humidity conditions. Poor quality paper may reduce print quality, cause paper jams and other problems.

Note:

- ❑ *Since the quality of any particular brand or type of media may be changed by the manufacturer at any time, EPSON cannot guarantee the quality of any type of media. Always test samples of media stock before purchasing large quantities or printing large jobs.*
- ❑ *You may use paper with preprinted letterheads, provided that the paper and ink are both compatible with laser printers.*

Paper that should not be used

You cannot use the following paper in this printer. Such paper may cause printer damage, paper jams, and poor print quality.

- ❑ Media meant for other color laser printers, black-and-white laser printers, color copiers, black-and-white copiers, or ink jet printers
- ❑ Paper previously printed on by any other printing device, including other color laser printers, black-and-white laser printers, color copiers, black-and-white copiers, ink jet printers, or thermal transfer printers
- ❑ Carbon paper, no-carbon paper, thermal-sensitive paper, pressure-sensitive paper, acid paper, or paper that uses high-temperature-sensitive ink (around 150°C)
- ❑ Coated paper or special surface-colored paper except EPSON Color Laser Coated Paper
- ❑ Paper that has binder holes or is perforated
- ❑ Paper that has glue, staples, paper clips, or tape on it
- ❑ Paper that attracts static electricity
- ❑ Moist or damp paper
- ❑ Paper of uneven thickness
- ❑ Overly thick or thin paper
- ❑ Paper that is too smooth or too rough
- ❑ Paper that is different on the front and back
- ❑ Paper that is folded, curled, wavy, or torn
- ❑ Paper of irregular shape, or paper that does not have right angle corners

Paper Sources

This section describes the combinations of paper sources and paper types that you can use.

MP tray

3

Paper Type	Paper Size	Capacity
Plain paper, EPSON Color Laser Paper	A3W*, A3*, A4, A5, B4*, B5, Letter (LT), Half-Letter (HLT), Legal (LG)*, Executive (EXE), Government Legal (GLG)*, Government Letter (GLT), Leader (B)*, F4* Custom-size paper: 90 × 139.7 mm minimum 328 × 453 mm maximum	Up to 150 sheets (Total thickness: less than 16 mm)
Thick paper	92 × 328 mm minimum 139.7 × 453 mm maximum	Up to 75 sheets
EPSON Color Laser Transparencies	A4, Letter (LT)	Up to 75 sheets
EPSON Color Laser Coated Paper	A3*, A4	Up to 150 sheets

* These sizes should be loaded short edge first.

Note:

Use the MP tray to print on the back of paper that has been printed on previously. The optional Duplex Unit cannot be used for this purpose.

Standard lower cassette

Paper Type	Paper Size	Capacity
Plain paper	A3*, A4, B4*, B5**, Letter (LT), Legal (LG)*, Executive (EXE)**, Ledger (B)*	Up to 250 sheets (Total thickness: less than 25 mm)
EPSON Color Laser Paper	A3*, A4, Letter (LT)	Up to 250 sheets
EPSON Color Laser Coated Paper	A3*, A4	Up to 250 sheets

* These sizes should be loaded short edge first

** Available depending on country of purchase

Large Capacity Paper Unit

This unit has two paper cassettes. Each can be loaded with the following paper sizes:

Paper Type	Paper Size	Capacity
Plain paper	A3*, A4, B4*, B5**, Letter (LT), Legal (LG)*, Executive (EXE)**, Ledger (B)*	Up to 500 sheets for each cassette. (Total thickness: less than 53 mm)
EPSON Color Laser Paper	A3*, A4, Letter (LT)	Up to 500 sheets for each cassette.
EPSON Color Laser Coated Paper	A3*, A4	Up to 500 sheets in each cassette

* These sizes should be loaded short edge first

** Available depending on country of purchase

Output Trays

There are two output trays for printed paper stacks: the face-down tray and the face-up tray.

Note:

The face-down tray is the default output tray. To select the face-up tray as the output tray, press the Face Up/Face Down button on the control panel.

3

Face-down tray

The face-down tray is located on the top of the printer. If you use the face-down tray, your printouts will be stacked facing down. Extend the stopper to prevent your printouts from slipping off the printer.

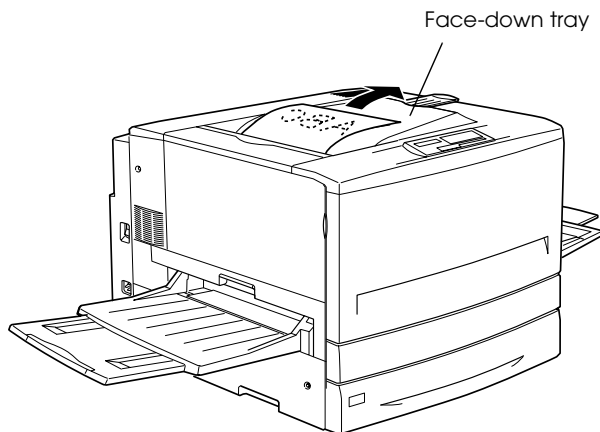

You can use the face-down tray with the following types of paper:

Paper type: Plain paper (minimum 210 mm width × 182 mm length), EPSON Color Laser Paper, EPSON Color Laser Coated Paper

Capacity: Up to 250 sheets



Caution:

The following paper cannot be used with the face-down tray. Use the face-up tray instead.

- Plain paper smaller than 210 × 182 mm, such as A5 or Half-Letter size*
- EPSON Color Laser Transparencies*
- Thick paper*

Face-up tray

The face-up tray stacks your printouts with the printed surface facing up. This tray can be used for all types of paper supported by this printer.

Paper type: All paper types supported by the EPSON AcuLaser C8500.

Capacity: Up to 150 sheets (smaller than A4 size paper)
Up to 50 sheets (A4 or larger size paper)

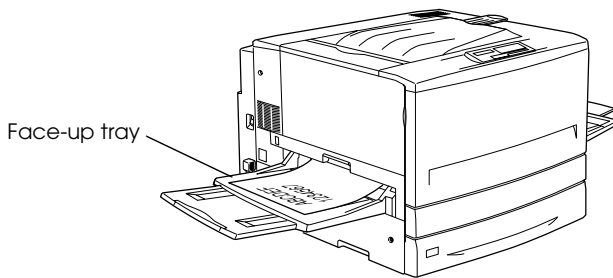

Loading Paper

This section describes how to load paper into the MP tray, the standard lower cassette, and the Large Capacity Paper Unit. If you use special media such as EPSON Color Laser Transparencies, see also “Printing on Special Media” on page 3-17.

Loading the MP tray

The MP tray is the most flexible paper source, accommodating various paper sizes and media types. It is also the paper source for feeding paper manually. See “MP tray” on page 3-5 for a list of the paper sizes and media types you can use in this paper source.

Follow these steps to load paper into the MP tray:

1. Open the MP tray, then extend the expansion tray on the MP tray to accommodate the size of the media you want to load.

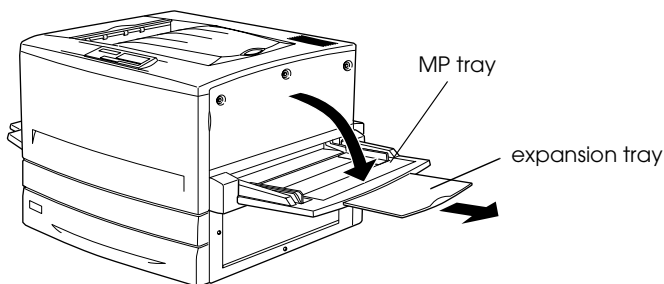

2. If you want to load A3W size paper, lay the left paper guide down. When loading media other than A3W size paper, make sure the guide is standing up.

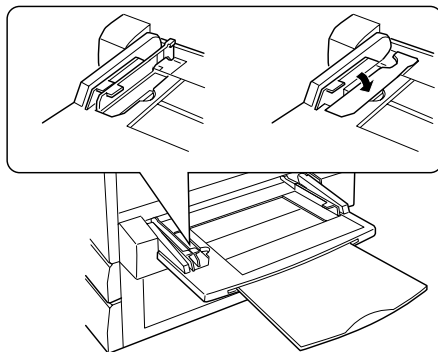

3. Slide the right edge guide all the way outward.

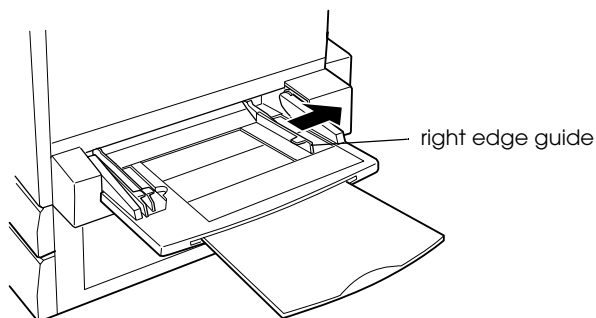

4. Load a stack of the desired media with the printable surface up. Rest the left side of the stack against the left paper guide and slide the right paper guide against the right side of the stack to obtain a snug fit.

All sizes except A3W:

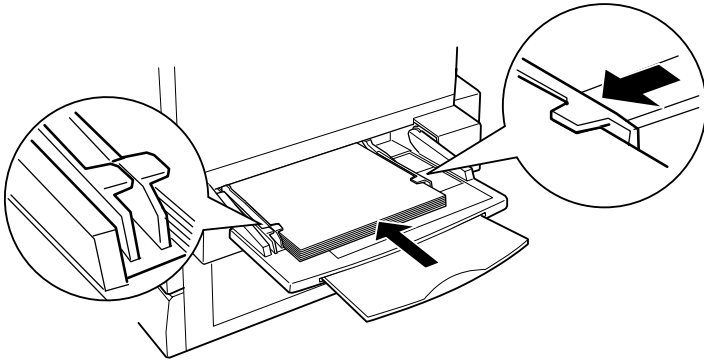

A3W size:

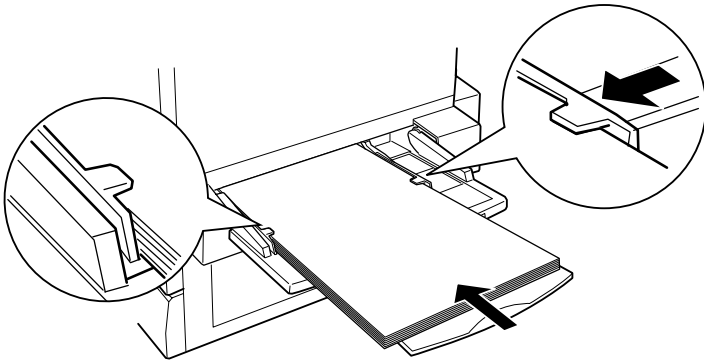

Loading the lower cassette and the Large Capacity Paper Unit

The paper-loading procedure is the same for the standard lower cassette and the Large Capacity Paper Unit.

In addition to plain paper, you can also use special media such as EPSON Color Laser Paper in the standard lower cassette.

3

Note:

Use the included paper size labels to identify the size of paper being used in the cassettes.

Follow these steps to load paper into the standard lower cassette or the Large Capacity Paper Unit. The illustrations are that for the standard lower cassette.

1. Pull the paper cassette out until it stops.

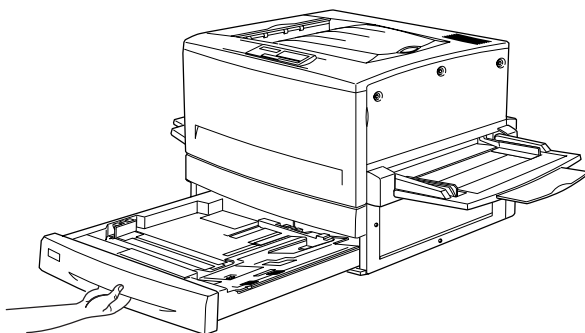

2. Press down on the metal plate in the cassette until it clicks into place.

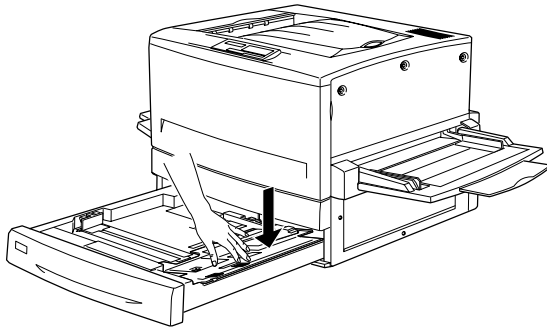

3. Press the side and back paper guides, then slide them outward until they are wide open enough to accommodate the size of paper you want to load.

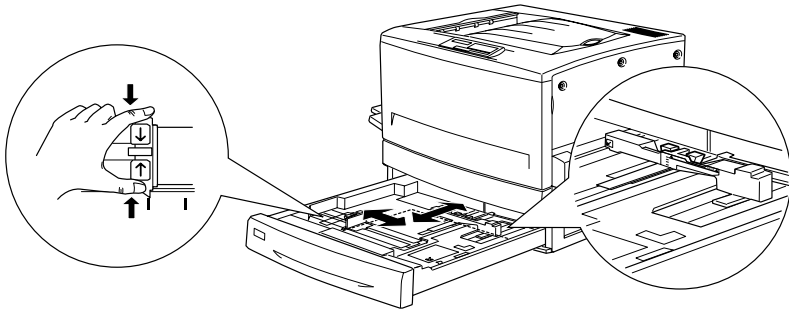

- Fan a stack of paper to prevent the sheets from sticking together, and tap the edge of the stack on a firm surface to line up the edges of the paper.

Note:

If your printouts are curled or do not stack properly when using plain paper, try turning the stack over and reloading it.

- Insert the stack into the cassette, lining it up with the right side of the cassette. Make sure that all the paper is under the metal retaining clip with the printable surface down.

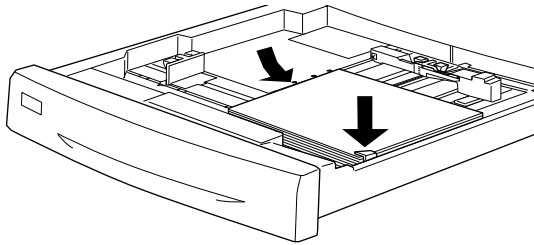

Note:

Loading the cassette with too much paper may cause paper jams.

- Slide the back paper guide until it just touches the edge of the stack of paper.

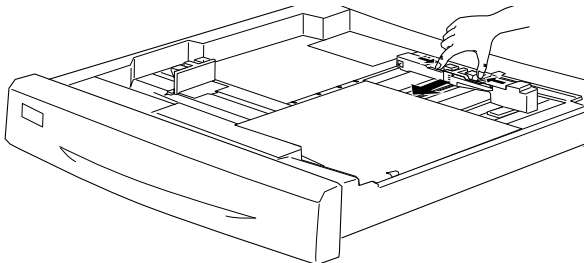

7. Slide the side paper guide so that it points to the size mark that matches the paper loaded.

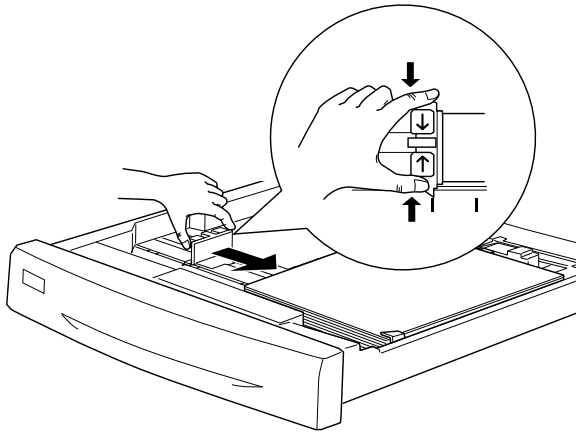

Note:

Make sure you adjust the side paper guide to the correct position because the printer automatically senses the size of paper loaded in the cassette from the position of this paper guide.

8. Push the cassette in all the way.

Printing on Special Media

You can print on special paper stock such as EPSON Color Laser Paper, EPSON Color Laser Transparencies, EPSON Color Laser Coated Paper, and thick paper.

Note:

Since the quality of any particular brand or type of media may be changed by the manufacturer at any time, EPSON cannot guarantee the quality of any type of media. Always test samples of media stock before purchasing large quantities or printing large jobs.

3

EPSON Color Laser Paper

You can use EPSON Color Laser Paper for the following paper sources:

MP tray (up to 150 sheets)

Standard lower cassette (up to 250 sheets)

Large Capacity Paper Unit (up to 500 sheets in each cassette)

EPSON Color Laser Transparencies

EPSON recommends the use of EPSON Color Laser Transparencies. You can load this media only from the MP tray.

Note:

Duplex printing is not available with transparencies.

Please note the following tips for handling this media:

- Hold each sheet by its edges, as oil from your fingers may transfer to the surface and damage the printable side of the sheet.

- ❑ When loading transparencies in the MP tray, insert the edge with the arrows first and the EPSON logo facing up.

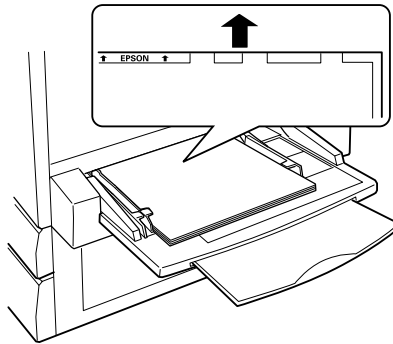

- ❑ If you attempt to load transparencies in any other way or with the wrong side facing up, the printer ejects the transparency without printing on it to prevent damage to the printer.

EPSON Color Laser Coated Paper

You can use EPSON Color Laser Coated Paper for the following paper sources:

- MP tray (up to 150 sheets)
- Standard lower cassette (up to 250 sheets)
- Large Capacity Paper Unit (up to 500 sheets in each cassette)

Chapter 4

Basic Settings Using the Control Panel

Changing MP Tray Settings	4-2
Making Zoom Settings	4-5
Selecting a fixed zoom ratio	4-5
Specifying a zoom ratio	4-7
Using the Fit-to-Page option	4-9
Using 1-Sided and 2-Sided Copy Modes	4-10
Making Document Type Settings	4-12
Adjusting Brightness and Color	4-14
Adjusting brightness	4-14
Adjusting color	4-15
Storing Your Settings	4-23
Storing settings	4-23
Selecting stored settings	4-25
Deleting stored settings	4-27

Changing MP Tray Settings

Follow the steps in this section to specify the type and size of paper loaded in the MP tray, and to select the appropriate orientation for the document to be copied. See “Loading the MP tray” on page 3-10 for information on loading paper into the MP tray.

1. Press the Paper button on the Ready to Copy screen.

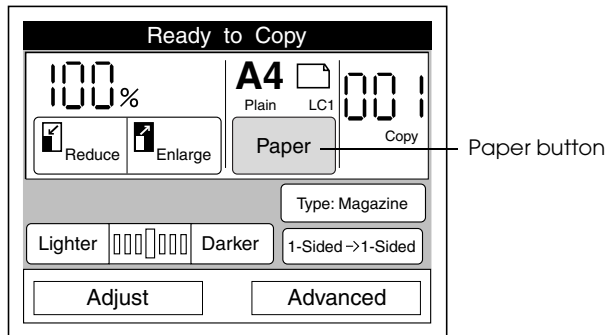

2. Press the Change button.

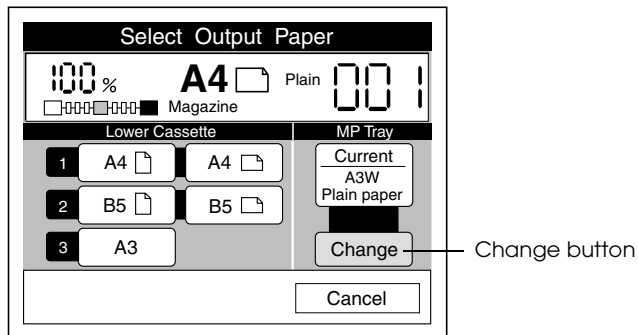

Note:





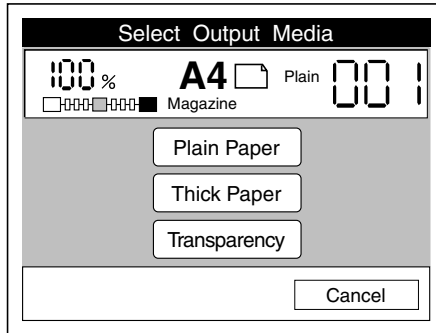



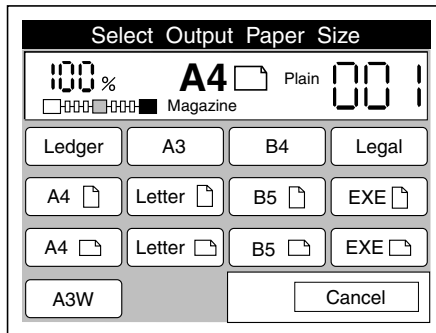

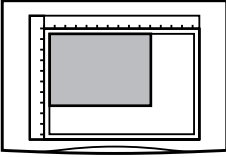

If no button is pressed for more than 30 seconds, any changes made are canceled and the Ready to Copy screen appears with the original settings preserved.

3. Select the type of media loaded in the MP tray.

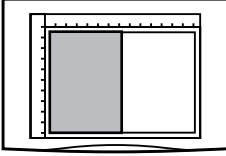

4. Select the paper size. For A4, Letter, Executive, or B5 paper, use the table below to select the correct orientation setting.



Orientation of document on scanner	Orientation of paper loaded in MP tray*	Correct orientation setting
		A4  Letter  Executive  B5 
		A4  Letter  Executive  B5 

* Always load A4, Letter, Executive, and B5 size paper with the long edge first and the printable side facing up.

Making Zoom Settings

You can specify a zoom ratio by selecting from a list of fixed zoom ratios, or by specifying a value from 25% to 400%. The default zoom ratio is 100%.

Selecting a fixed zoom ratio

1. Press the Reduce or Enlarge button on the Ready to Copy screen.

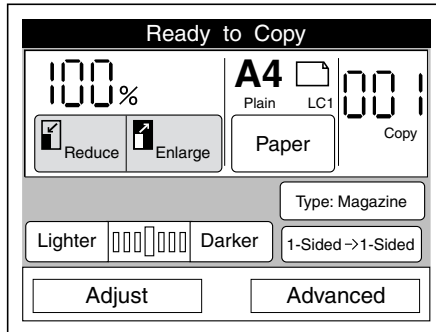

2. Select the ratio from the following screens.

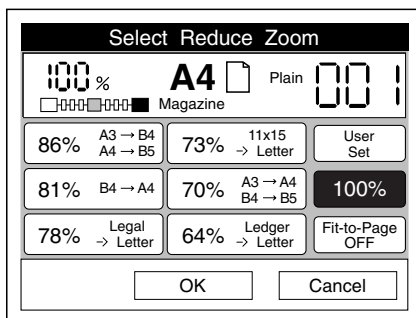

Reduce

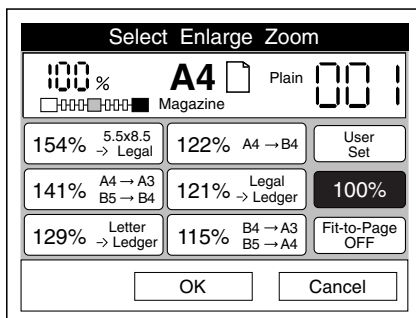

Enlarge

To make sure the entire area of the scanned document is copied, turn on the Fit to Page option. See “Using the Fit-to-Page option” on page 4-9 for more information.

3. Press the OK button. The Ready to Copy screen appears. Press Cancel to return to the Ready to Copy screen without applying the zoom ratio settings.

Note:

If no button is pressed for more than 30 seconds, any changes made are canceled and the Ready to Copy screen appears with the original settings preserved.

Specifying a zoom ratio

You can specify a zoom ratio between 25% and 400%, in increments of 1%.

1. Press the touch screen anywhere within the area shown below.

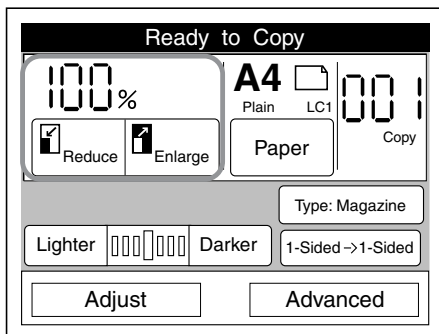

4

2. Press the User Set button on the Select Reduce Zoom or the Select Enlarge Zoom screen.

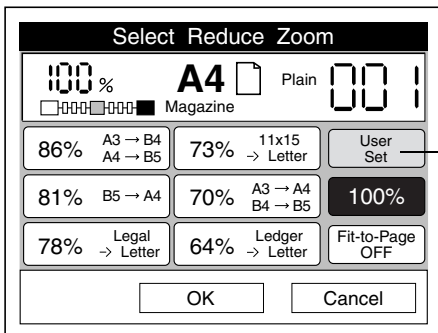

User Set button

The following screen appears.

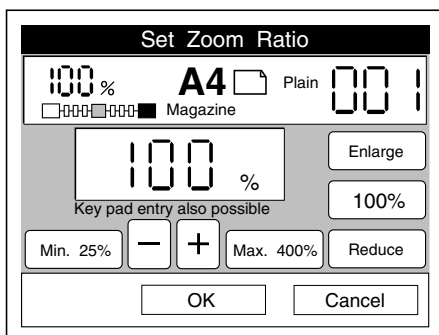

3. Use the key pad to enter a zoom ratio between 25% and 400%, or press the - or + button to change the zoom ratio in 1% increments.
4. Press OK to apply the zoom ratio setting and return to the Ready to Copy screen. Press CANCEL to return to the Ready to Copy screen without applying the zoom ratio settings.

Note:

If no button is pressed for more than 30 seconds, any changes made are canceled and the Ready to Copy screen appears with the original settings preserved.

Using the Fit-to-Page option

The Fit-to-Page option automatically reduces the entire area of the scanned document to fit on the selected paper, as shown below.

Note:

The Fit-to-Page option is not available when specifying a user-defined zoom ratio, and selection of the Fit-to-Page option is canceled when a user-defined ratio is specified.



Original Document

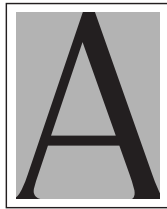

Fit-to-Page mode OFF



Fit-to-Page mode ON

Using 1-Sided and 2-Sided Copy Modes

The copy station provides a variety of 1-sided and 2-sided copy modes for use with the scanner's optional Auto Document Feeder (ADF) and the printer's optional Duplex Unit.

The availability of these copy modes depends on the combination of installed options, as shown below.

	1-sided to 1-sided	1-sided to 2-sided	2-sided to 1-sided	2-sided to 2-sided
Duplex Unit and ADF	Enabled	Enabled	Enabled	Enabled
Duplex Unit Only	Enabled	Enabled	Enabled	Enabled
ADF Only	Enabled	Disabled	Enabled	Disabled
Neither Duplex Unit nor ADF	Enabled	Disabled	Enabled	Disabled

Follow these steps to select the copy mode.

1. Press the 1-sided/2-sided button on the Ready to Copy screen.

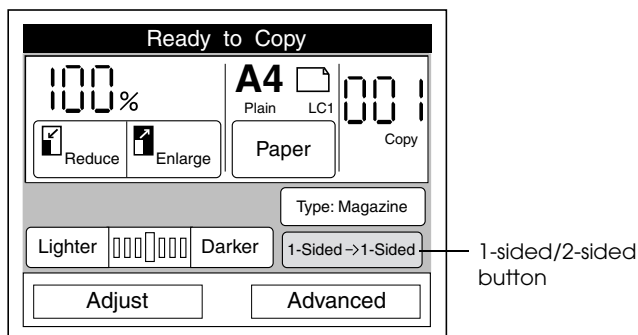

2. Select a mode on the following screen.

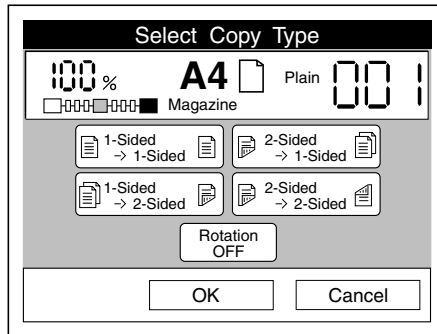

3. Press OK to apply your settings and return to the Ready to Copy screen. Press Cancel to return to the Ready to Copy screen without applying the copy type settings.

If the Rotation option is turned on when a 2-sided printing mode is selected, the image printed on the back of paper is rotated 180 degrees. This is useful when making double-sided copies to be bound at the top or the bottom of the page, such as tablets or calendars.

Note:

The 2-sided printing modes are not available if A3W, Transparency, or Thick Paper is selected.

Making Document Type Settings

The copy station offers the following document type settings suited for various types of documents.

Photo	Good for color photos or other color images. Accurately reproduces fine gradation and subtle tonal variations. If moiré patterns (crisscrossing lines) appear when this setting is used, switch to the Magazine setting.
Text	Good for documents containing black text only. Text in copies appears sharp and easy to read.
Magazine	Good for documents containing both text and color images, such as magazines or brochures. Also, may prevent moiré patterns (crisscrossing lines) from appearing in copies.
Map	Good for documents containing many light-colored objects and thin lines, such as maps.
Detail	Good for documents containing fine detail. While it takes longer to copy, you get higher copy quality (600 dpi).

1. Press the document type button on the Ready to Copy screen.

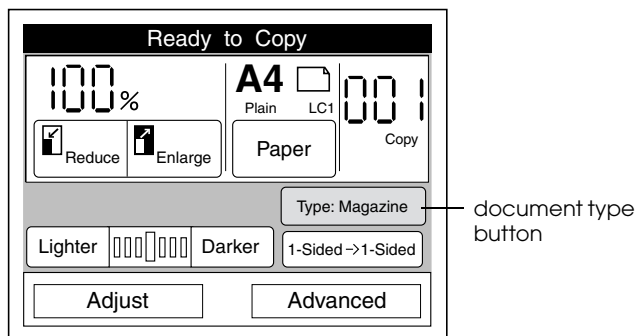

2. Select a document type.

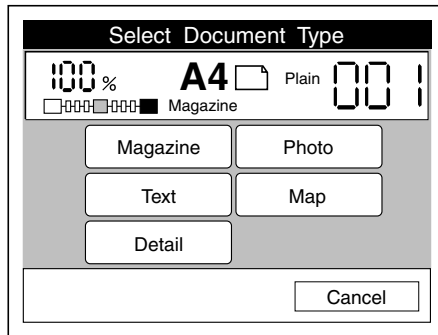

Note:

- ❑ *Press the Cancel button to cancel the document type setting and return to the Ready to Copy screen with the original settings preserved.*
- ❑ *If no button is pressed for more than 30 seconds, any changes made are canceled and the Ready to Copy screen appears with the original settings preserved.*

Adjusting Brightness and Color

Adjusting brightness

You can adjust the brightness of the image by pressing the Lighter and Darker buttons on the Ready to Copy screen.

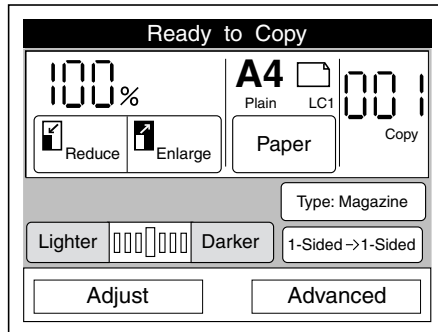

Lighter

Standard

Darker



Adjusting color

You can adjust the copied image's color by pressing the Adjust button on the Ready to Copy screen.

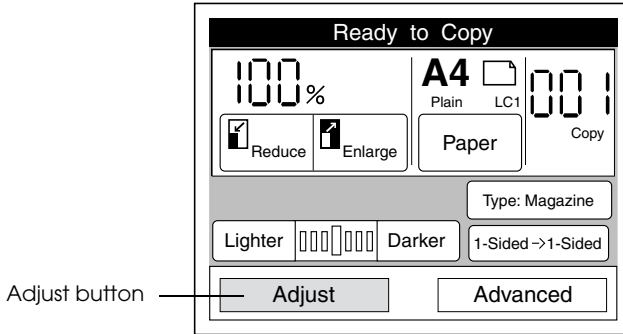

Pressing the Adjust button displays the following screen, from which you can adjust the contrast, color balance, saturation, and hue.

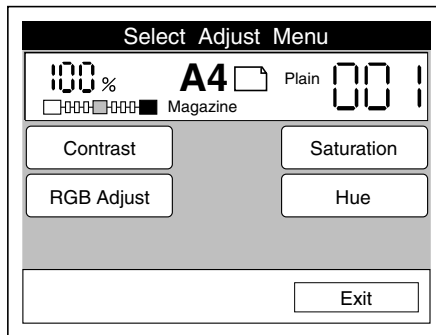

Note:

- ❑ To return to the Ready to Copy screen with the current settings applied, press the Exit button.
- ❑ If no button is pressed for more than 30 seconds in a color adjustment screen, any changes made are canceled and the Ready to Copy screen appears with the original settings preserved.

Contrast

Follow these steps to adjust the contrast.

1. Press the Contrast button on the Select Adjust Menu screen. The following screen appears.

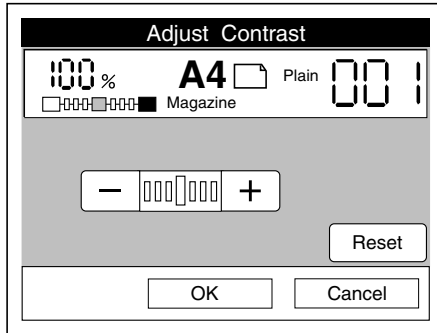

2. Press the + button to increase the contrast, and press the - button to decrease the contrast. Press the Reset button to return the setting to the center position.

Lower Contrast



Standard



Higher Contrast



Note:

If you want to cancel your contrast settings, press Cancel. The Color Adjust Menu appears with the original settings preserved.

3. Press OK. The following screen appears.

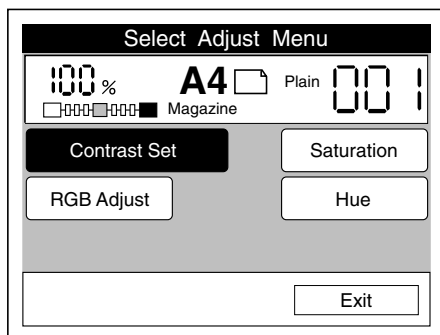

RGB Adjust

You can adjust the color balance by changing the red (R), green (G), and blue (B) color values. Follow these steps.

Note:

RGB adjustment is available only when the Color mode is selected.

1. Press RGB Adjust on the Select Adjust Menu screen. The following screen appears.

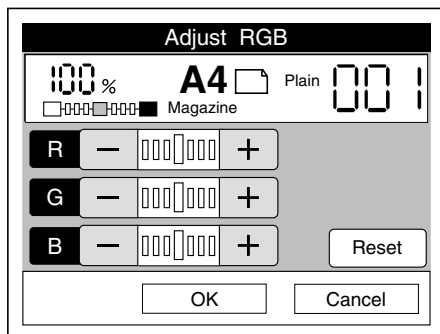

- Press the +/- buttons to adjust the color, as shown below. To return the RGB settings to their center positions, press the Reset button.

Red (R) balance

Press the + button to make red stronger, and press the - button to make red weaker.

Less Red
(More Cyan)

Standard

More Red
(Less Cyan)



Green (G) balance

Press the + button to make green stronger, and press the - button to make green weaker.

Less Green
(More Magenta)

Standard

More Green
(Less Magenta)



Blue (B) balance

Press the + button to make blue stronger, and press the - button to make blue weaker.

Less Blue
(More Yellow)

Standard

More Blue
(Less Yellow)



4

Note:

If you want to cancel the RGB adjustment, press Cancel. The Color Adjust Menu appears with the original settings preserved.

3. Press OK. The following screen appears.

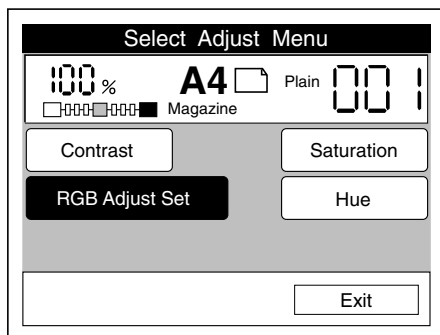

Saturation

Use the Saturation setting to adjust the overall color density of the image. Higher saturation makes color appear richer, while lower saturation makes color appear paler.

Note:

Saturation adjustment is available only when the Color mode is selected.

1. Press Saturation on the Select Adjust Menu screen. The following screen appears.

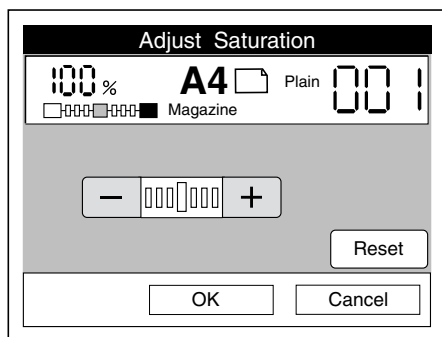

Press the + button to increase saturation, and press the - button to decrease saturation. Press the Reset button to return the setting to the center position.

Lower Saturation

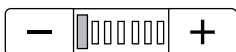

Standard



Higher Saturation



Note:

If you want to cancel your saturation setting, press Cancel. The Color Adjust Menu appears with the original settings preserved.

2. Press OK. The following screen appears.

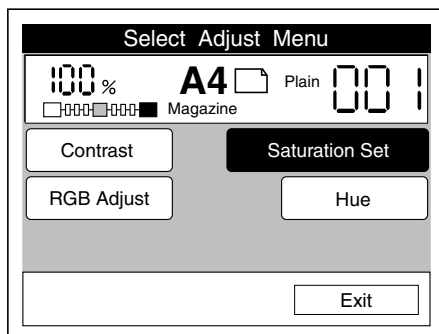

Hue

Use this setting to adjust the hue of the copied image.

Note:

Hue adjustment is available only when the Color mode is selected.

1. Press HUE on the Select Adjust Menu screen. The following screen appears.

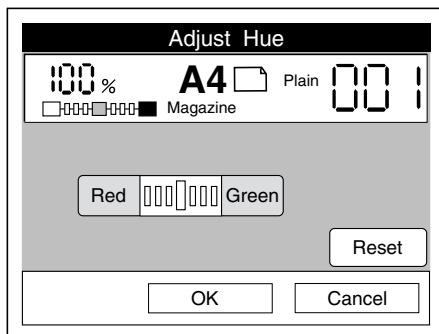

Press the **Red** button to make the whole image appear more red, and press **Green** button to make the whole image appear more green. Press the **Reset** button to return the setting to the center position.

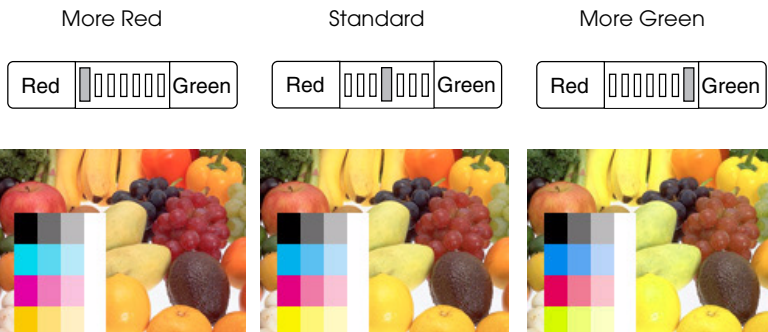

Note:

*If you want to cancel the hue adjustment, press **Cancel**. The **Color Adjust Menu** appears with the original settings preserved.*

2. Press **OK**. The following screen appears.

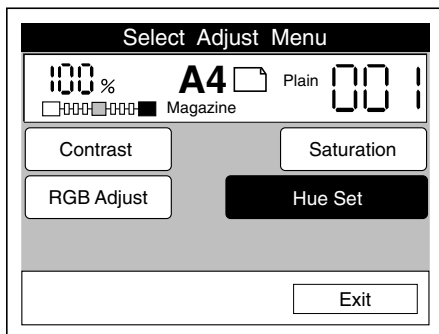

Storing Your Settings

Storing settings

You can save up to eight sets of copy settings in the copy station memory. This feature allows you to apply even the most complex settings to new copy jobs with just a few simple steps.

Follow the steps in this section to store settings. For information on applying stored settings, see “Selecting stored settings” on page 4-25. For information on deleting stored settings, see “Deleting stored settings” on page 4-27.

1. Make all the settings you wish to save as a single set, then press the Memory button on the control panel.

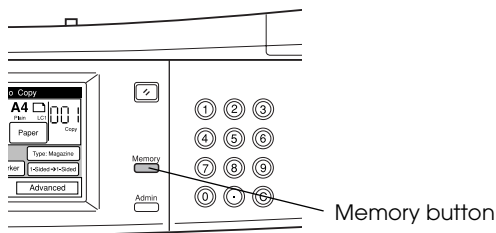

2. Press any available Store button to save the settings. When the settings are completely saved, the Memory button becomes available and the Store button change to a Delete button.

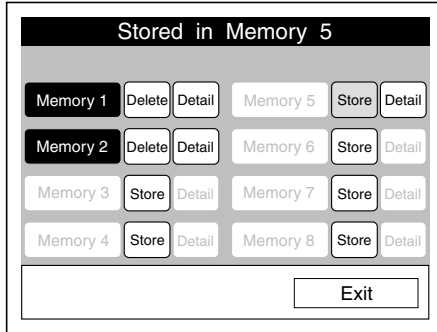

Note:

If no button is pressed for more than 30 seconds, the Ready to Copy screen appears with the original settings preserved.

Selecting stored settings

Follow the steps in this section to apply stored settings to copy jobs.

For information on storing settings, see “Storing settings” on page 4-23. For information on deleting stored settings, see “Deleting stored settings” on page 4-27.

1. Press the Memory button on the control panel.

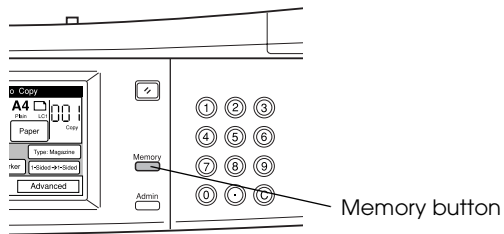

Note:

If no button is pressed for more than 30 seconds, the Memory mode is canceled and the Ready to Copy screen appears with the original settings preserved.

2. Press the Memory button for the settings you want to apply, or press any Detail button to view a complete list of the settings stored in that memory. Press Exit to return to the previous screen.

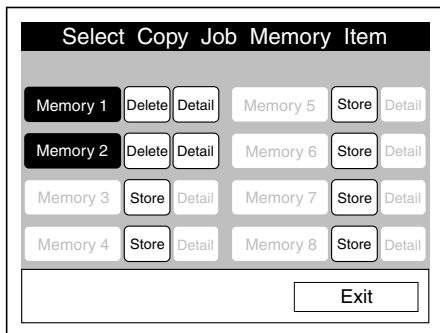

When a memory is selected, the Ready to Copy screen appears with the stored memory settings applied. The currently selected memory appears at the top of the screen.

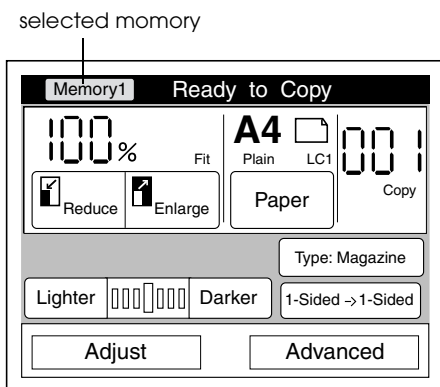

Note:

To cancel the selection of a memory, press the Reset button on the control panel.

Deleting stored settings

Follow the steps in this section to delete stored settings.

For information on storing settings, see “Storing settings” on page 4-23. For information on applying stored settings, see “Selecting stored settings” on page 4-25.

1. Press the Memory button on the control panel.

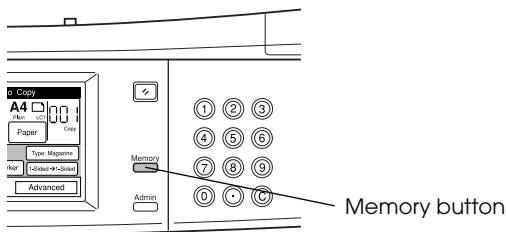

2. Press the Delete button for the memory you want to delete.

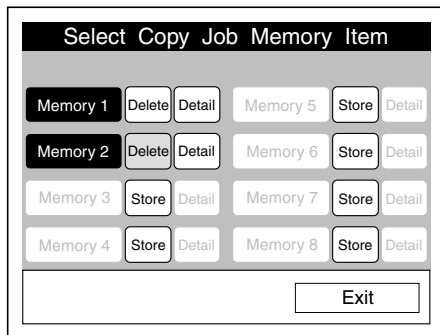

Note:

Press any Detail button to view a complete list of the settings stored in that memory.

3. Press **OK** to delete the memory, or press **Cancel** to return to the previous screen without deleting the memory.

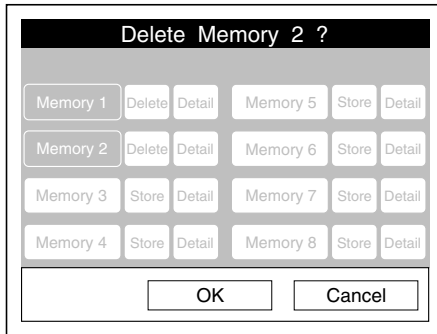

Chapter 5

Using Advanced Copy Modes

Advanced Copy Mode Introduction	5-2
Using the Join Pages Mode	5-3
Setting the Binding Margin	5-7
Using the Split Pages Mode	5-11
Using the Remove Shadows Mode.....	5-15
Using the Collate Mode	5-19

Advanced Copy Mode Introduction

The advanced copy modes enhance your output options when making multiple copies, or when copying bound documents like books. You can use the advanced copy modes to collate pages, copy two pages onto a single sheet, copy facing pages of a bound document onto two separate sheets, remove unwanted shadows from copies of bound documents, and set a binding margin.

To access the advanced copy modes, press the Advanced button on the Ready to Copy screen.

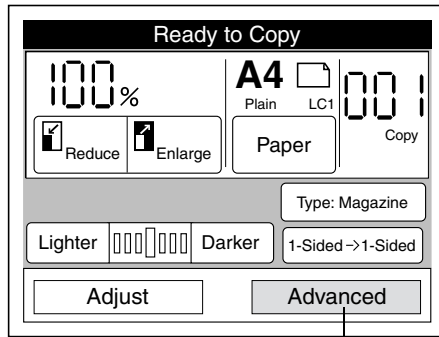

Advanced button

The following screen appears, from which you can select one or a combination of advanced copy modes.

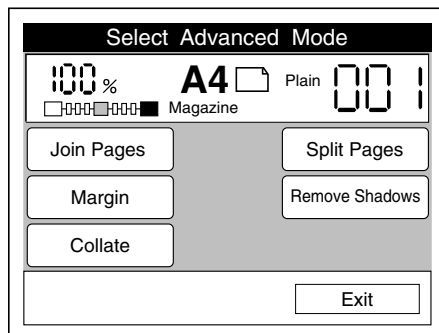

Using the Join Pages Mode

The Join Pages mode allows you to copy two pages onto one sheet of paper. Follow the instructions in this section.

Note:

- ❑ *This mode cannot be used with the Split Pages mode.*
- ❑ *When this mode is selected, you cannot change the zoom ratio or the paper source from the Ready to Copy screen.*
- ❑ *To clear all Join Pages mode settings, press the Join Pages Set button, then press the Clear button.*
- ❑ *To return to the Ready to Copy screen with the current settings applied, press the Exit button.*
- ❑ *If no button is pressed for more than 30 seconds when in Join Pages mode, any changes made are canceled and the Ready to Copy screen appears with the original settings preserved.*

1. Press the Join Pages button on the Select Advanced Mode screen.

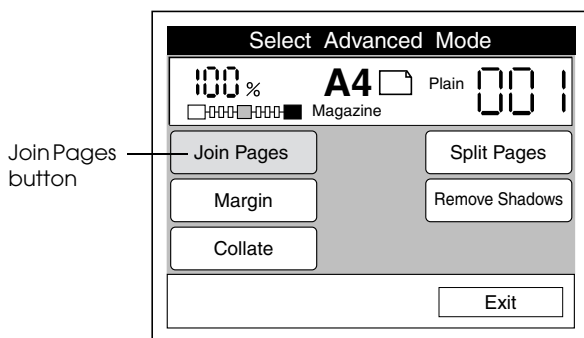

Note:

If Join Pages Set appears instead of the Join Pages button, the Join Pages mode is already selected. Press Join Pages Set, then press the Set Up button and follow the instructions from step 2 below to change the settings.

2. Select the document size and its orientation on the document table.

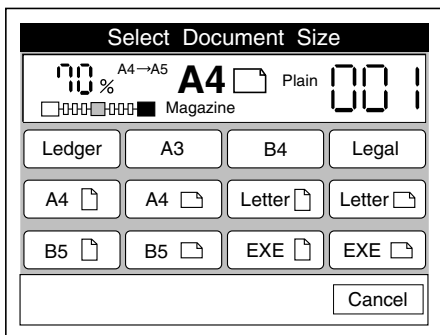

3. Select a paper source. The size of the original document will automatically be reduced or enlarged so that two pages fit onto one sheet of the selected paper. See "Zoom ratios in Join Pages mode" on page 5-6 for details.

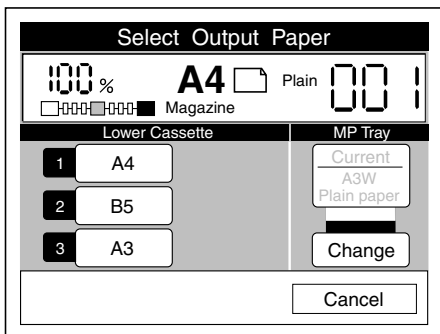

4. Select the page layout that matches the page order of the original document. If the document page order is from left to right or from top to bottom, select the Odd -> Even setting. If the document page order is from right to left or from bottom to top, select the Even -> Odd setting.

When the document is placed horizontally on the document table, the Select Page Layout screen appears as follows:

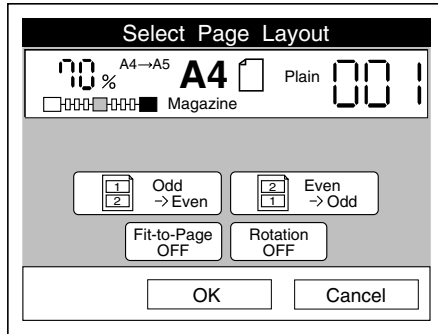

When the document is placed vertically on the document table, the Select Page Layout screen appears as follows:

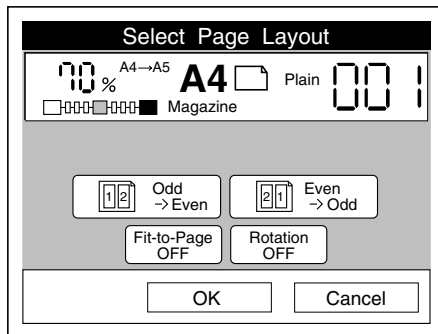

5. Press OK. The Select Advanced Mode screen appears.
6. Place the first page of the document on the scanner and press the \diamond start button. A progress meter appears on the touch screen while the page is being scanned, then instructions for scanning the next page of the document appear.
7. Place the next page of the document on the document table and press the \diamond start button. Repeat this procedure until all the pages have been scanned.

Zoom ratios in Join Pages mode

Output Paper Size	Document Size	Zoom Ratio	Results
A3	A3	A3 -> A4	Two pages of the original document are printed onto one A3 size sheet.
	B4	B4 -> A4	
	A4	100%	
	B5	B5 -> A4	
B4	A3	A3 -> B5	Two pages of the original document are printed onto one B4 size sheet.
	B4	B4 -> B5	
	A4	A4 -> B5	
	B5	100%	
A4	A3	A3 -> A5	Two pages of the original document are printed onto one A4 size sheet.
	B4	B4 -> A5	
	A4	A4 -> A5	
	B5	B5 -> A5	
B5	A3	A3 -> B6	Two pages of the original document are printed onto one B5 size sheet.
	B4	B4 -> B6	
	A4	A4 -> B6	
	B5	B5 -> B6	

Output Paper Size	Document Size	Zoom Ratio	Results
Ledger	Ledger	B -> HB	Two pages of the original document are printed onto one Ledger size sheet.
	Legal	LGL -> H-B	
	Letter	LT -> H-B	
	Executive	EXE -> H-B	
Letter	Ledger	B -> 5.5 x 8.5	Two pages of the original document are printed onto one Letter size sheet.
	Legal	LGL -> 5.5 x 8.5	
	Letter	LT -> 5.5 x 8.5	
	Executive	EXE -> 5.5 x 8.5	
Executive	Ledger	B -> H-EXE	Two pages of the original document are printed onto one Executive size sheet.
	Legal	LGL -> H-EXE	
	Letter	LT -> H-EXE	
	Executive	EXE -> H-EXE	

Setting the Binding Margin

If you want to bind your copies, you can use the Margin mode to select the left, right, bottom, or top edge as the binding margin, and to specify the margin width from 0 to 30 mm.

Note:

- ❑ To clear all Margin mode settings, press the Margin Set button, then press the Clear button.
- ❑ To return to the Ready to Copy screen with the current settings applied, press the Exit button.
- ❑ If no button is pressed for more than 30 seconds when in Margin mode, any changes made are canceled and the Ready to Copy screen appears with the original settings preserved.

1. Press the Margin button on the Select Advanced Mode screen.

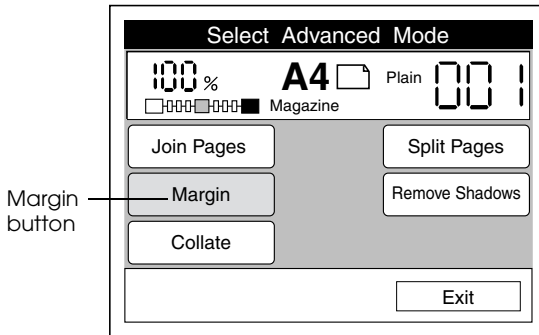

Note:

If Margin Set appears instead of the Margin button, the Margin mode is already selected. Press Margin Set, then press the Set Up button and follow the instructions from step 2 below to change the settings.

2. Select a position for the binding margin. The appearance of the Select Margin Position screen differs depending on whether the document is placed on the document table vertically or horizontally.

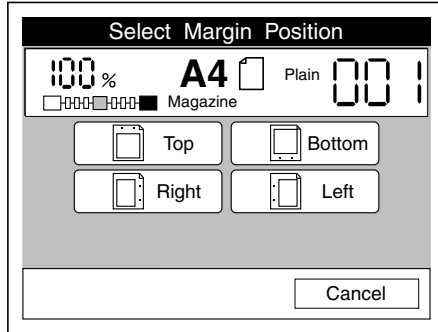

Vertical Document Placement

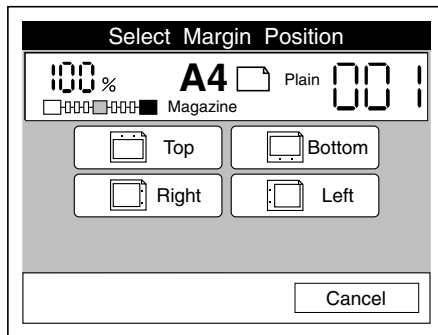

Horizontal Document Placement

- Specify a total margin width between 0 mm and 30 mm. Press the + or - button to increase or decrease the width in 1 mm increments, or enter a value using the numeric key pad.

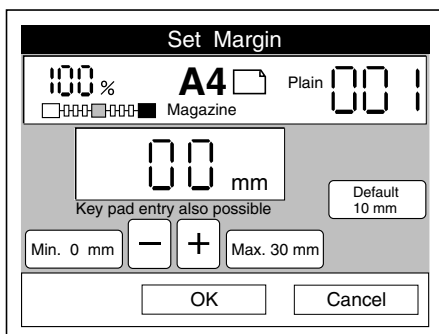

Note:

- The printer cannot print within 4 mm of the edge of the paper, so margin values between 0 mm and 4 mm have no effect on the printed output.
 - If you want to cancel your margin settings, press Cancel. The the Select Advanced Mode screen appears with the original settings preserved.
- Press OK. The Select Advanced Mode screen appears.

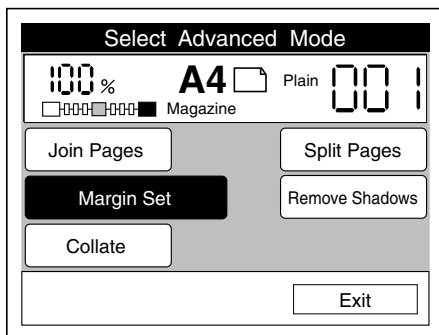

Using the Split Pages Mode

The Split Pages mode allows you to copy two facing pages of a bound document onto separate sheets of paper, as shown below.

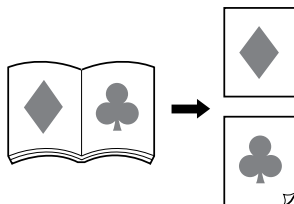

Note:

- This mode cannot be used with the Join Pages mode.
 - To clear all Split Pages mode settings, press the Split Pages Set button, then press the Clear button.
 - To return to the Ready to Copy screen with the current settings applied, press the Exit button.
 - If you want to cancel your settings, press Cancel on any Split Pages screen. The Select Advanced Mode screen appears with the original settings preserved.
 - If no button is pressed for more than 30 seconds when in Split Pages mode, any changes made are canceled and the Ready to Copy screen appears with the original settings preserved.
1. Place the open document face down on the document table with the fold separating the two pages perpendicular to the horizontal ruler.

Note:

The fold separating the two facing pages of an open document must always be perpendicular to the horizontal ruler when using the Split Pages mode.

2. Press the Split Pages button on the Select Advanced Mode screen.

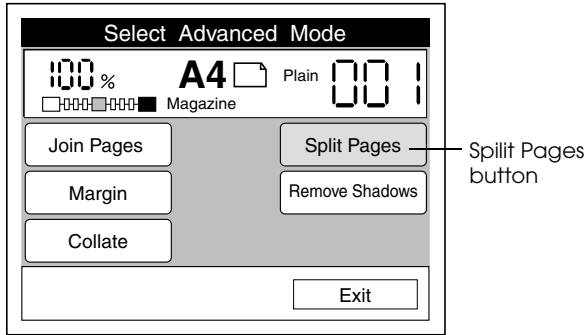

Note:

If Split Pages Set appears instead of the Split Pages button, the Split Pages mode is already selected. Press Split Pages Set, then press the Set Up button and follow the instructions from step 2 below to change the settings.

3. Select the document size that matches the total size of the open document.

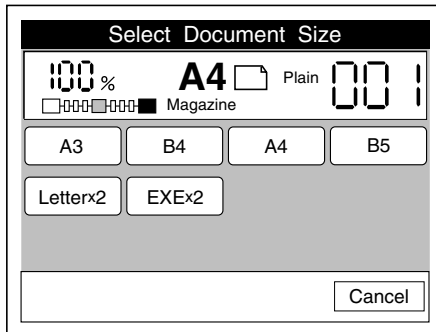

Note:

When using the Split Pages mode in combination with the Remove Shadows mode, the document size settings in the Remove Shadows mode are automatically applied to the Split Pages mode.

4. Select a paper source.

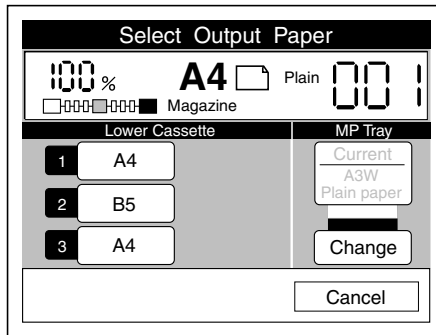

The size of each facing page of the original document will be automatically reduced or enlarged to fit onto the selected paper, as shown in the table below:

Output Paper Size	Document Size	Zoom Ratio
A4	A3 (A4 × 2)	100%
	B4 (B5 × 2)	B5 -> A4
	A4 (A5 × 2)	A5 -> A4
	B5 (B6 × 2)	B6 -> A4
B5	A3 (A4 × 2)	A4 -> B5
	B4 (B5 × 2)	100%
	A4 (A5 × 2)	A5 -> B5
	B5 (B6 × 2)	B6 -> B5
Letter	Letter × 2	100%
	Executive × 2	EXE -> Letter
Executive	Letter × 2	Letter -> EXE
	Executive × 2	100%

5. Select the side on which the document is bound or folded. If the binding or fold is on the left when the document is closed, select Left Bound. If the binding or fold is on the right, select Right Bound.

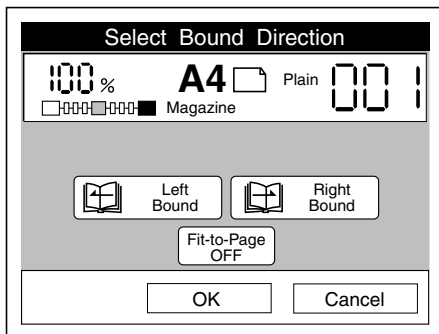

If you want to fit the entire area of each facing page onto the selected paper, press the Fit-to-Page button.

6. Press OK. The Select Advanced Mode screen appears.

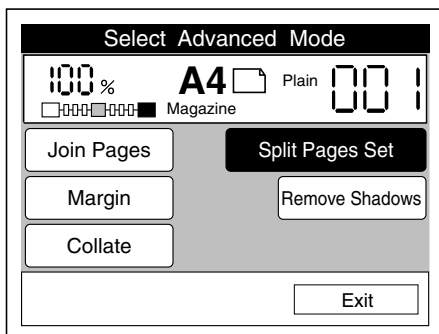

Using the Remove Shadows Mode

The Remove Shadows mode allows you to eliminate unwanted shadows from copies of documents that cannot be laid flat against the scanner glass. For example, you can use this feature to remove the shadows from the center and edges of a thick book, as shown below.

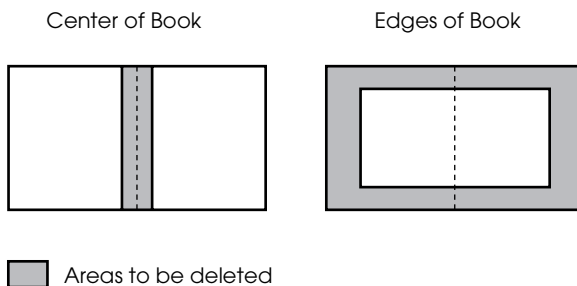

Note:

- To clear all Remove Shadows mode settings, press the Remove Shadows Set button, then press the Clear button.
- To return to the Ready to Copy screen with the current settings applied, press the Exit button.
- If you want to cancel your settings, press Cancel on any Remove Shadows screen. The Select Advanced Mode screen appears with the original settings preserved.
- If no button is pressed for more than 30 seconds when in Remove Shadows mode, any changes made are canceled and the Ready to Copy screen appears with the original settings preserved.

1. Press the Remove Shadows button on the Select Advanced Mode screen.

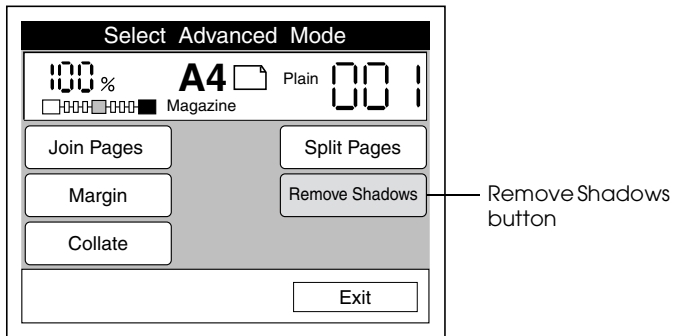

Note:

If Remove Shadows Set appears instead of the Remove Shadows button, the Remove Shadows mode is already selected. Press Remove Shadows Set, then press the Set Up button and follow the instructions from step 2 below to change the settings.

2. To set the width of the area to be removed, press Center or Frame on the Select Erase Position screen.

The appearance of this screen differs depending on whether the Paper setting specifies vertical or horizontal document placement on the document table. Make sure the Paper setting matches the actual document orientation on the document table.

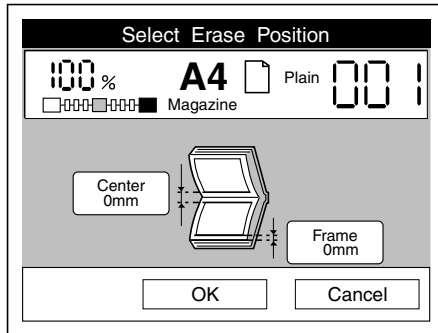

Vertical Document Placement

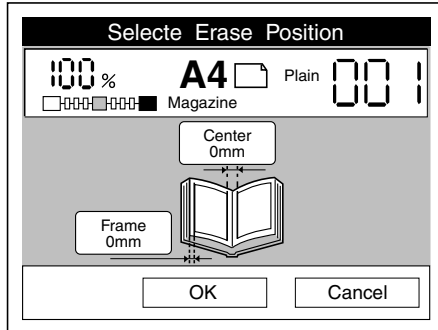

Horizontal Document Placement

- Specify a shadow width between 0 mm and 40 mm. Press the + or - button to increase or decrease the width in 1 mm increments, or enter a value using the numeric key pad.

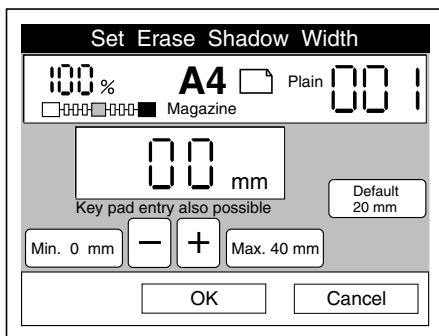

- Press OK to return to the Select Erase Position screen. If necessary, select the other shadow area and specify the width as described above.
- When all settings are complete, press OK. The Select Advanced Mode screen appears.

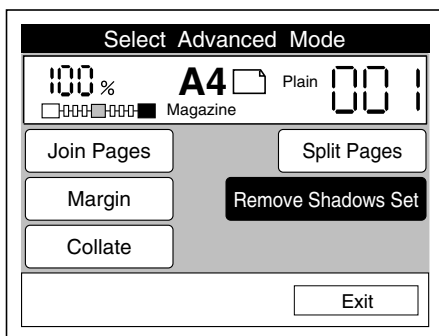

Using the Collate Mode

The Collate Mode allows you to preserve the original page order when copying multiple-page documents.

This mode is only available when the optional Hard Disk Drive is installed in the printer. See the printer's *Setup Guide* for details on Hard Disk Drive installation.

Note:

To return to the Ready to Copy screen with the current settings applied, press the Exit button.

1. Press the Collate button on the Select Advanced Mode screen.

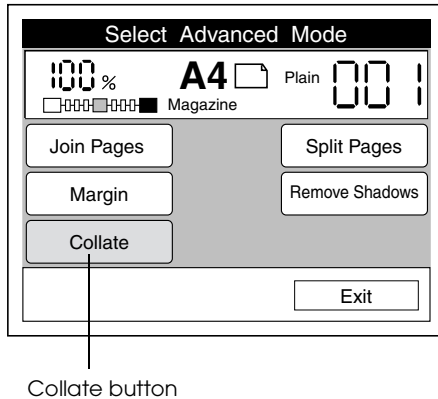

Note:

If Collate Set appears instead of the Collate button, the Collate mode is already selected. If you want to turn off the Collate mode, press Collate Set, then follow the instructions from step 2 below to change the setting.

2. Press Collate ON to activate the Collate mode, or press Collate OFF to cancel this mode.

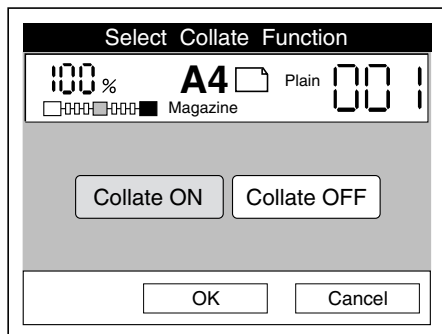

Note:

- ❑ If you want to cancel your settings, press Cancel. The Select Advanced Mode screen appears with the original settings preserved.
 - ❑ If no button is pressed for more than 30 seconds, any changes made are canceled and the Ready to Copy screen appears with the original settings preserved.
3. Press OK. The Select Advanced Mode screen appears.

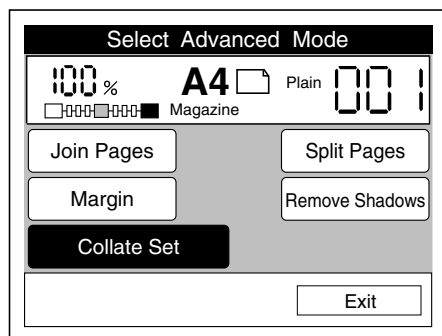

4. If necessary, use the numeric key pad to specify how many sets you want to copy.

Chapter 6

Using the Administrator Mode

Checking Copy Station Status	6-2
Making Administrator Mode Settings	6-3
Key Tone	6-4
Standby Control	6-4
Auto Feed	6-5
Set Defaults Copy Job	6-5
Color Calibration	6-6
Select Language	6-10
Copy Unit Restore Defaults	6-11

Checking Copy Station Status

The Administrator mode allows you to view and to print out the current status of the copy station, the printer, and the scanner. The status information includes the current state of all devices, the amount of paper loaded in the printer, and the amount of toner remaining in the printer's toner cartridge.

Press the Admin button on the control panel to access the Administrator mode.

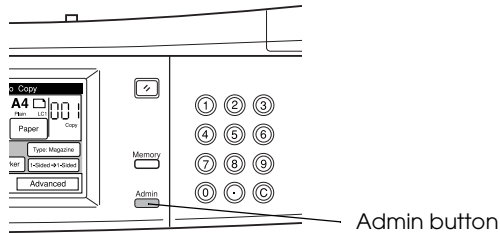

The copy station status appears on the touch screen.

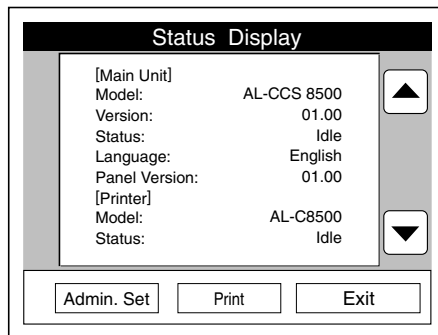

Note:

When the scanner is not connected or while a scanner error occurs, the scanner status is not displayed.

To print a status sheet, press the Print button.

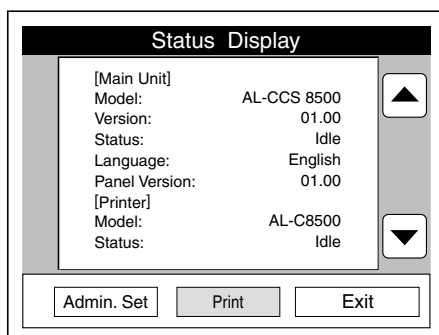

Making Administrator Mode Settings

6

The Administrator mode allows you to make a variety of background settings that affect the overall operation of the copy station. You can also use this mode to perform color calibration and to change or restore default settings. Press the Admin button on the control panel to access the Administrator mode, then press the Admin. Set button to make settings.

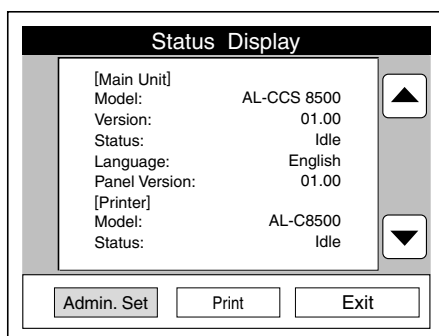

The Select Administrator Items screen appears, from which you can make the settings and perform the operations described in this section.

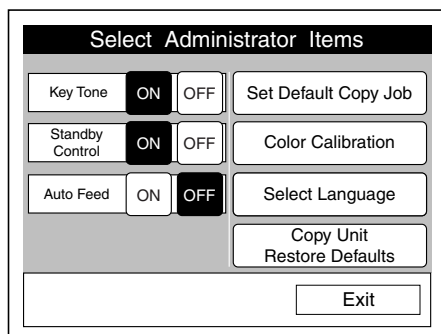

Key Tone

When ON is selected, the copy station produces a soft beep when any buttons or keys are pressed on the touch screen, the control panel, or the numeric key pad. The default value for this setting is ON.

Standby Control

When ON is selected, the copy station automatically comes out of the standby mode when a person stands in front of the copy station. This shortens the amount of time it takes for the printer to warm up after coming out of power-save mode. The default value for this setting is ON.

Auto Feed

Auto Feed enables the printer to automatically switch to a different paper cassette when paper runs out during printing. When paper runs out in the selected paper source, the printer searches for the same size paper in the other paper sources in the following order:

Cassette 1 -> Cassette 2 -> Cassette 3 -> MP tray

If the same size paper is not loaded in any paper source, a paper size error message appears on the touch screen.

The default value for the Auto Feed setting is OFF.

Set Defaults Copy Job

This option allows you to store the current copy station settings as defaults to be used when any Reset button is pressed or when no button is pressed for more than 30 seconds on any screen. Follow the steps below to store default values.

1. Make all the copy station settings you want to store as defaults, then access the Select Administrator Items screen and press Set Defaults Copy Job.

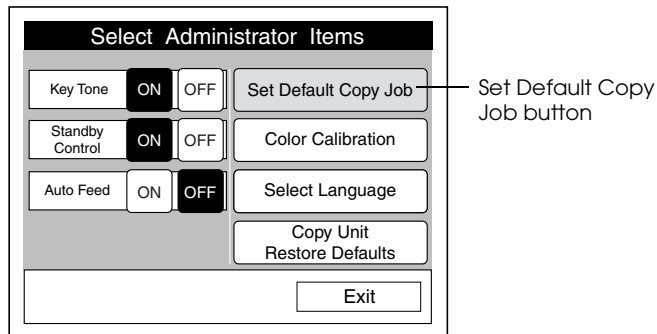

2. Press the **Store** button to make the current settings the copy station defaults. To view a list of the current settings, press **Current**. To return to the previous screen without storing the settings, press **Exit**.

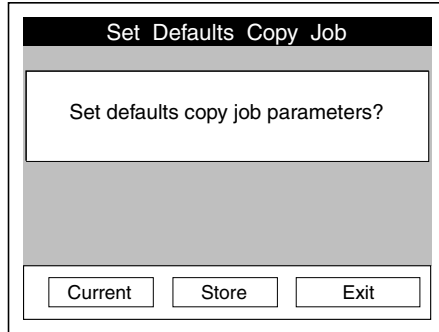

Color Calibration

Use this feature to calibrate colors captured by the scanner with the colors produced by the printer. The calibration process involves printing and then scanning two color charts. Follow the steps below.

1. Press the **Color Calibration** button on the **Select Administrator Items** screen.

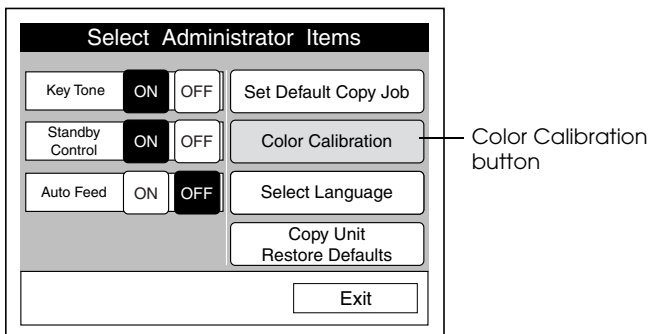

2. Press Start Color Calibration.

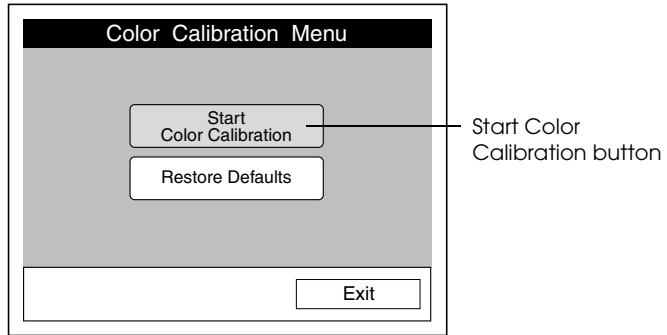

Note:

If you want to reset the calibration settings to the factory defaults, press Restore Defaults, then press OK. The default settings are restored and the Color Calibration Menu screen appears.

3. When the following screen appears, load plain paper into the MP tray and press the \diamond start button on the control panel to print out the first color calibration chart.

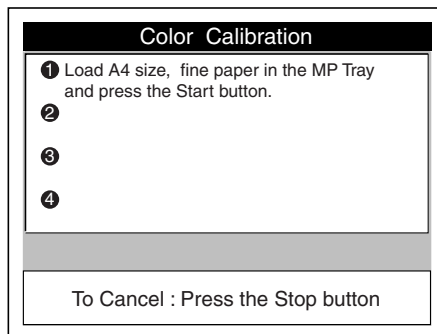

Note:

To cancel calibration, press the \odot stop button. The Color Calibration Menu appears.

4. Place the color chart onto the document table with printed side facing down, as shown below.

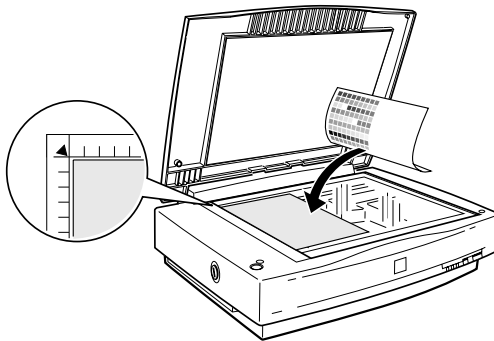

5. Press the \diamond start button on the control panel to begin calibration. The following screen appears during calibration.

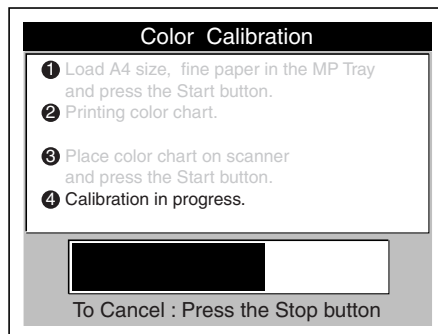

- When the following screen reappears, remove the first color chart from the scanner, make sure paper is loaded in the MP tray, and press the  start button to print the second color chart.

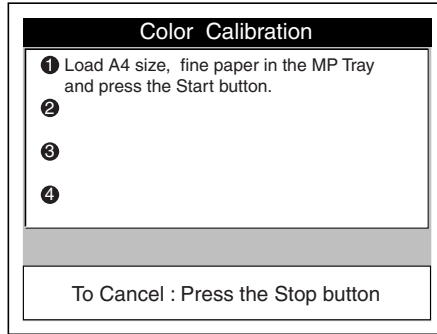

- Place the second color chart on the scanner, then press the  start button to complete the calibration process. When calibration is complete, the Color Calibration Menu screen appears.

Select Language

This option allows you to change the language used for the buttons and messages on the touch screen.

1. Press the Select Language button on the Select Administrator Items screen.

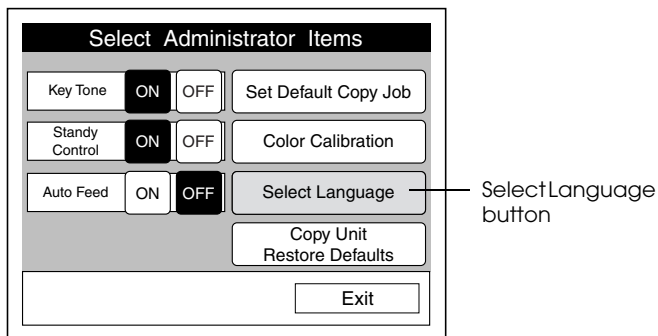

2. Select a language. The Select Administrator Items screen reappears with all items displayed in the selected language.

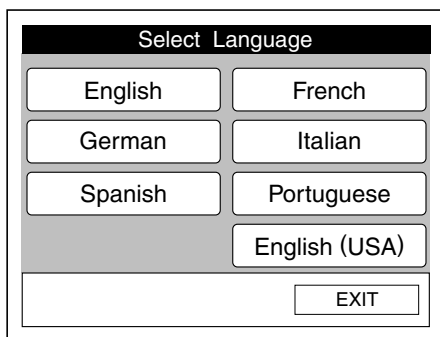

Note:

- ❑ *If you press the Exit button, the Select Administrator Items screen appears with the original settings preserved.*

- ❑ *If no button is pressed for more than 30 seconds, any changes made are canceled and the Ready to Copy screen returns with the original settings preserved.*

Copy Unit Restore Defaults

This option restores all copy station settings and color calibration information to the factory defaults, and deletes all stored settings from the copy station's memory.

1. Press the Copy Unit Restore Defaults button on the Select Administrator Items screen.

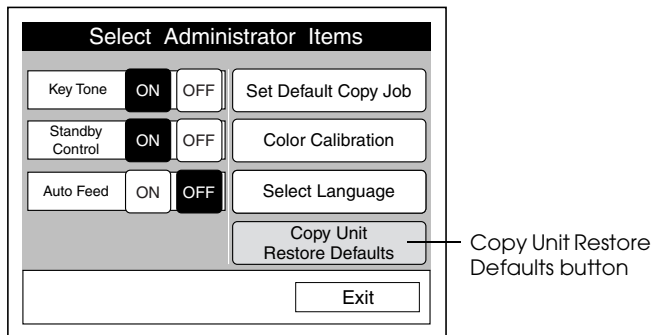

2. Press the OK button to restore defaults and erase copy job memory. Press Cancel to return to the previous screen without restoring defaults.

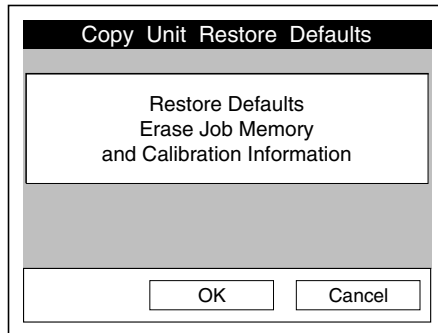

Chapter 7

Maintenance and Transportation

Cleaning the Copy Station7-2

Transporting the Copy Station7-2

Cleaning the Copy Station

The copy station should be cleaned periodically to maintain top performance.

Use a soft cloth to wipe away dirt on the copy station cabinet. To remove stubborn stains, soak the cloth in a mild detergent solution and wring it thoroughly before use. Then wipe with a soft, dry cloth.

See the printer and scanner manuals for details on cleaning these devices.



Caution:

- Do not use volatile solvents such as benzine or thinner to clean the cabinet; these chemicals can damage the cabinet or copy station components.*

- Be careful not to spill water into the system.*

Transporting the Copy Station

Before transporting the copy station, it should be carefully disassembled and repacked, as explained below. See the printer and scanner manuals for more details on packing and transporting these devices.

1. Turn off the scanner by pressing the OPERATE button.
2. Turn off the printer by pressing the (O) side of its power switch.
3. Unplug the scanner and the printer.

4. Turn the scanner's transportation lock to the locked position using a coin or a similar object, as shown below.

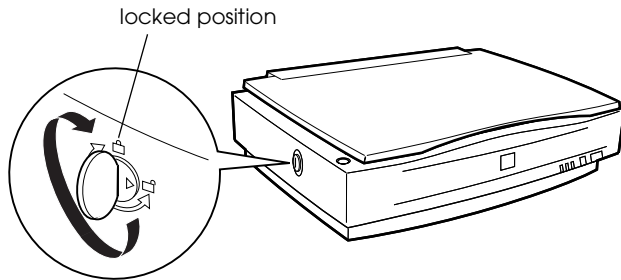

5. Disconnect and remove all cables, then remove the control panel from the cabinet.
6. Remove the scanner and the printer from the cabinet, and then disassemble the cabinet.
7. Repack the control panel, the scanner, the printer, the Large Capacity Paper Unit, and the cabinet. Be sure to use the original boxes and packing materials to avoid damage during transportation.

Troubleshooting

Copying Problems	8-2
Printing problems	8-2
The edges of a document are not copied.	8-3
The copy is too light or too dark	8-4
Copied colors differ from the original.	8-4
Error Messages	8-5
Printer errors	8-5
Scanner errors	8-15
Copy system errors	8-18

Copying Problems

If you experience problems with printing or with copy quality, see this section for solutions.

Printing problems

If any of the following problems occur when printing out copies, see the troubleshooting section of the *EPSON AcuLaser C8500 Reference Guide* for solutions.

- Paper jams.
- Multiple sheets are fed.
- The background is dark or dirty.
- Black or white bands appear in the printout.
- Print quality is uneven.
- Toner smudges.
- Some areas of the printout are missing.
- Completely blank pages are printed.
- The printed image is light or faint.
- The non-printed side of the page is dirty.

The edges of a document are not copied

Due to mechanical limitations, the printer cannot print within 4 mm of the edge of the paper. Because of this, a small portion of the image may be cut off when copying onto paper that is the same size as the original document. If this happens, try the following solutions.

If you do not mind reducing the size of the image slightly

Select the Fit-to-Page option on the Reduce or Enlarge zoom screen, then set the zoom ratio to 100% and select paper that is the same size as the original document.

If you do not want to change the size of the original image

Copy the document onto slightly larger paper. For example, if your document is Executive size, try copying it onto A4 size paper.

The copy is too light or too dark

Adjust the brightness setting on the touch screen, then try copying again.

Copied colors differ from the original

The copy system scanner interprets the colors of the original document as combinations of red (R), green (G), and blue (B). However, the printer represents these colors as combinations of cyan (C), magenta (M), yellow (Y), and black (K). Not all colors captured using the RGB system can be expressed or printed using the CMYK system, so the color of your printed output may not exactly match color of the original document.

Try using the color adjustments on the touch screen to improve your color output. If you often copy documents that require similar adjustments, you can save your color adjustment settings in the copy station's memory. For more information on adjusting the color, see "Adjusting color" on page 4-15. For information on storing settings, see "Storing settings" on page 4-23.

If you often experience color-matching problems, you may need to carry out color calibration for the copy station. See "Color Calibration" on page 6-6 for instructions.

Error Messages

Printer errors

Printer error messages are displayed on both the copy station's touch screen and on the printer's LCD panel. On the touch screen, these messages are divided into two groups: Printer Alert messages and Printer Error messages. When an error occurs, find the error message in the tables below, then try the solutions provided.

Alert messages

Touch Screen Message	Printer LCD Panel Message	Solution
Printer Alert ROM module Press the Stop button Job will Continue	Format Error ROM A or Format Error ROM B	An unformatted ROM module has been inserted. Press the Ⓞ stop button to clear the error message. Format the ROM module, then try again. If the problem persists, take the ROM module to your dealer for repair or replacement.
Printer Alert Insufficient Memory Press the Stop button Job will Continue	Image Optimum	Due to insufficient memory, printing cannot be performed at the specified resolution. Printing will continue at a lower resolution. Press the Ⓞ stop button to clear the error message.
Printer Alert Insufficient Memory Press the Stop button Job will Continue	Need Memory	The printer has insufficient memory to execute the current task. Printing will continue at a slower rate. Press the Ⓞ stop button to clear the error message.

Touch Screen Message	Printer LCD Panel Message	Solution
Printer Alert Paper Type Error Press the Stop button Job will Continue	Check Paper Type	The selected paper size is not loaded in any paper source. Load the correct paper, or change the paper size selection. Printing will then continue. Press the Ⓢ stop button to clear the message.
Printer Alert Paper Size Error Press the Stop button Job will Continue	Check Paper Size	Because the paper size setting is different from the size of paper loaded in the printer, the document is printed on another size of paper. Check to see if the correct size of paper is loaded in the specified paper source, then press the Ⓢ stop button to clear the message.
Printer Alert Paper Type Error Press the Stop button Job will Continue	Outbin Select Error	Printouts cannot be output to the face-up tray. Printing continues and printouts are output to the face-down tray.
Printer Alert Photoconductor Press the Stop button Job will Continue	Worn Photoconductor	The photoconductor unit nearing the end of its service life. Replace the photoconductor unit with a new one.
Printer Alert Waste Toner Box Press the Stop button Job will Continue	Waste T Box Nearfull	The waste toner box is nearly full. Replace the waste toner box with a new one.

Touch Screen Message	Printer LCD Panel Message	Solution
Printer Alert Collate disabled Press the Stop button Job will Continue	Collate was disabled	The printer has insufficient memory to collate the print job. Only one copy of the document will be printed.
Printer Alert Toner Cartridge Press the Stop button Job will Continue	XXXX Toner Low	The toner cartridge of the color indicated by XXXX is low in toner. Replace the toner cartridge of the color indicated by XXXX with a new toner cartridge.
Printer Alert Pre-feed Error Press the Stop button Job will Continue	Time Exceeded	Although the printer has started feeding paper, the print data is not available within the time interval required by the engine. As a result, a blank page is ejected, then the printer attempts to continue the print job.

Error messages

Touch Screen Message	Printer LCD Panel Message	Solution
Printer Error Printer Overrun After Error Recovery Job will Continue	Print Overrun	The required time to process the print data exceeds the print engine speed because the current page is too complex. Press the Continue button on the printer to resume printing.
Printer Error Insufficient Memory After Error Recovery Press the Stop button	Mem Overflow	The printer has insufficient memory to execute the current task. Press the Continue button on the printer, then press the ⏹ stop button to clear the error message.
Printer Error Paper Size Error After Error Recovery Press the Stop button	Paper Set XXX YYY	The paper loaded in the specified paper source (XXX) does not match the required paper size (YYY). Press the ⏹ stop button to stop the operation.
Printer Error Can't Print Duplex After Error Recovery Press the Stop button	Can't Print Duplex	The printer cannot print on both sides of the paper. Make sure you are using a paper type and size supported by the Duplex Unit.
Printer Error Cover Open After Error Recovery Job will Continue	Front Cover Open	The front cover of the printer is open. Close the cover to clear the error.
Printer Error ROM Module Restart System	Invalid ROM A or Invalid ROM B	The printer cannot read the installed ROM module. Turn off the printer and remove the ROM module.

Touch Screen Message	Printer LCD Panel Message	Solution
Printer Error ROM Module After Error Recovery Press the Stop button	Write Error ROM A or Write Error ROM P	Cannot write to the ROM module, or no module is installed. Press the ⏹ stop button and check the ROM module. If this error persists, contact your dealer.
Printer Error Paper Jam B After Error Recovery Job will Continue	Jam B	Paper is jammed at the paper feed area or paper transport unit of the printer. Remove the jammed paper.
Printer Error Paper Jam C, D, or E After Error Recovery Job will Continue	Jam C or Jam D or Jam E	Paper is jammed inside the printer in an area other than the excluding the paper feed area. Remove the jammed paper.
Printer Error Paper Out After Error Recovery Job will Continue	Paper Out XXX YYY	There is no paper in the specified paper source (XXX). Load paper of the indicated size (YYY) into the paper source.
Printer Error Paper Jam A After Error Recovery Job will Continue	Jam A	Paper is jammed inside the output path cover. Remove the jammed paper.
Printer Error Turn paper After Error Recovery Job will Continue	Turn Paper XXX	Paper is loaded in the wrong orientation in the cassette indicated by XXX. Remove the paper stack from the cassette, turn it by 90 degrees, and reload it with the long edge first.

Touch Screen Message	Printer LCD Panel Message	Solution
Printer Error Aux I/F Error Restart System	Invalid AUX I/F Card	The installed interface card cannot be used with this printer. (1) Press the ⏹ stop button to stop the operation. (2) Turn off the printer power and remove the interface card.
Printer Error Paper Type Error After Error Recovery Job will Continue	Check Transparency	(a) A transparency is loaded in the wrong direction. Remove the transparency jammed at the paper feed area and reload it in the correct direction. Open and then close the paper transport unit to clear the error. Printing will continue. (b) A transparency that cannot be used with this printer is loaded. Use only transparencies designated for use with this printer.
Printer Error Photoconductor Restart System	Install Photoconductor	No photoconductor unit is installed, or the photoconductor unit is not installed correctly. Turn off the power of the printer, and then install the photoconductor unit correctly.
Printer Error Waste Toner Box After Error Recovery Job will Continue	Install Waste T Box	No waste toner box is installed. Install a waste toner box and close the front cover of the printer. The error will clear and printing will continue.

Touch Screen Message	Printer LCD Panel Message	Solution
Printer Error Photoconductor Restart System	Replace Photoconductr	The photoconductor unit has reached the end of its service life. Turn off the printer power and replace the photoconductor with a new one.
Printer Error Waste Toner Box After Error Recovery Job will Continue	Replace Waste T Box	The waste toner collector is full. Replace it with a new waste toner collector the close the front cover of the unit. The error will clear and printing will continue.
Printer Error Irregular Density Restart System	Irregular Density	Printing is canceled because the color density on the current page is too high to be processed by the printer. Remove all paper from the paper path, then turn the printer off and on to clear this error.
Printer Error Photoconductor Restart System	Wrong Photocondctor	The installed photoconductor unit cannot be used with this printer. Turn off the printer power and install the correct photoconductor unit.
Printer Error Photoconductor Restart System	Photocondctr Trouble	The installed photoconductor unit is malfunctioning. Turn off the printer power and install a usable photoconductor unit.
Printer Error Cover A Open After Error Recovery Job will Continue	Cover A Open	The cover on the left side of the copy station is open. Close the cover to clear this error. Printing will continue.

Touch Screen Message	Printer LCD Panel Message	Solution
Printer Error Cover D Open After Error Recovery Job will Continue	Cover D Open	The cover on the right side of the copy station is open. Close the cover to clear this error. Printing will continue.
Printer Error Cover E Open After Error Recovered Job will Continue	Cover E Open	The cover on the right side of the large capacity paper unit is open. Close the cover to clear this error. Printing will continue.
Printer Error Cover F Open After Error Recovered Job will Continue	Cover F Open	The cover on the left side of the Duplex Unit is open. Close the cover to clear this error. Printing will continue.
Printer Error Toner Cartridge After Error Recovery Job will Continue	XXXX Toner Crtg Out	The toner cartridge of the color indicated by XXXX is not installed. Install the toner cartridge of the color indicated by XXXX, and then close the front cover. The error will clear and printing will continue.
Printer Error Toner Cartridge After Error Recovery Job will Continue	XXXX Toner Out	The toner cartridge of the color indicated by XXXX is empty. Replace the toner cartridge of the color indicated by XXXX with a new toner cartridge, and then close the front cover. The error will clear and printing will continue.
Printer Error Paper Jam G After Error Recovery Job will Continue	Jam G	Paper is jammed at the both-side tray (unit G). Remove the jammed paper.



Touch Screen Message	Printer LCD Panel Message	Solution
Printer Error Paper Jam F After Error Recovery Job will Continue	Jam F	Paper is jammed at the cover on the left side of the printer (unit F). Remove the jammed paper.
Printer Error HDD Error Restart System	Invalid HDD	Turn off the power of the printer, and then check the printer's optional Hard Disk Unit to make sure it is connected correctly.
Printer Error Unit B Open After Error Recovery Job will Continue	Unit B Open	The Fuser unit on the left side of the printer is open. Close the unit to clear this error. Printing will continue.
Printer Error Unit C Open After Error Recovery Job will Continue	Unit C Open	The paper feed unit on the right side of the printer is open. Close the unit to clear this error. Printing will continue.
Printer Error Unit G Open After Error Recovery Job will Continue	Unit G Open	The Duplex unit is open. Close the unit to clear this error. Printing will continue.
Printer Error Service Required Restart System	Service Req efff	An error has occurred which requires servicing by your dealer. Write down the error number indicated by efff and contact your dealer.

Other error messages

Touch Screen Message	Solution
Printer Error Communication Error After Error Recovery Press the Stop button	A communication error has occurred. Make sure the printer power is on. Also check that the printer is connected to the copy station. Press the ⏹ stop button, then try copying again.
Printer Error Offline After Error Recovery Job will Continue	Press the On Line button on the printer.
Printer Busy After Recovery Job will Continue	The printer is printing data through another interface. When printing is finished, copying will continue.
Printer Error Model Error After Error Recovery Press the Stop button	The connected printer is not the EPSON AcuLaser C8500. The copy station can only be used with the EPSON AcuLaser C8500. If this error occurs even though the EPSON AcuLaser C8500 is connected, press the Retry button on the copy station control panel.

Scanner errors

Touch Screen Message	Solution
Scanner Error Communication Error After Error Recovery Press the Stop button	The scanner is not connected. Make sure the scanner power is on, and check that the copy server and the scanner are connected with a SCSI cable. Press the ⏹ stop button, then try copying again.
Scanner Error ADF Error After Error Recovery Press the Stop button	A problem has occurred in the ADF unit. Turn off the power of the scanner, and then turn it back on again. If the scanner returns to normal operation, press the ⏹ stop button, then try copying again. If the error persists, this may indicate a problem with the scanner. Contact your dealer.
Scanner Error Paper Jam After Error Recovery Press the Stop button	Paper is jammed in the ADF unit. Remove the paper jammed from the Auto Document Feeder. Then press the ⏹ stop button and try copying again.
Scanner Error Cover Open After Error Recovery Press the Stop button	The ADF unit is open. Close the Auto Document Feeder firmly. Then press the ⏹ stop button and try copying again.
Scanner Error Option Error After Error Recovery Press the Stop button	Make sure the ADF unit is completely closed and that there is no paper jammed inside the ADF. Then press the ⏹ stop button and try copying again.

Touch Screen Message	Solution
Scanner Error Model Error After Error Recovery Press the Stop button	<p>A scanner other than the EPSON GT-10000+ or EPSON EXPRESSION 1640XL is connected to the copy station. Confirm the scanner model, then press the  stop button and try copying again.</p> <p>If this error occurs even though a correct scanner model is connected, press the Retry button on the copy station control panel.</p>
Scanner Error Fatal Error After Error Recovery Press the Stop button	<p>An undefined error has occurred. Turn off the power of the scanner, and then turn it back on again.</p> <p>If the scanner returns to normal operation, press the  stop button, then try copying again.</p> <p>If the error persists, this may indicate a problem with the scanner. Contact your dealer.</p>
Scanner Error Page Size Error After Error Recovery Press the Stop button	<p>The size or direction of the document loaded in the ADF unit is not correct. Reload the document correctly, then press the  stop button and try copying again.</p>

Calibration adjustment errors

Display on the control panel	Solution
Calibration Error Calibration Failed Press the Stop button	Calibration was not completed successfully. Press the Ⓞ stop button, then press the Start Color Calibration button again.
Calibration Error Calibration Failed After Error Recovery Press the Stop button	
Calibration Error Scanned page is slanted Adjust paper position Press the Stop button Job will Continue	Document (color chart) is not placed onto the document table properly. (1) Open the document cover and position the color chart correctly. (2) Press the Ⓞ stop button to resume color calibration.
Calibration Error Scanned page position Adjust paper position Press the Stop button Job will Continue	
Calibration Error Calibration Failed Press the Stop button Job will Continue	

Copy system errors

Display on the control panel	Details and Solution
System Error Internal Error Restart System	Restart System. (1) Turn off the scanner and the printer. (2) Wait for approximately three minutes, and then turn the devices back on. (3) If the same message reappears, this may indicate malfunctioning interface boards.
System Error Fatal Error Restart System	In this case, contact your dealer.
System Error Paper Error Press the Stop button	A document that cannot be scanned is placed on the scanner. Press the ⏹ stop button, and check the document type.
System Error HDD Full Press the Stop button	In the Collate mode, scanning cannot be completed because the optional Hard Disk Unit is full. Press the ⏹ stop button to cancel the copy job.

Appendix A

Technical Specifications

Supported Printer and Scanner	A-2
Printer Interface Board Specifications	A-2
Scanner Interface Board Specifications	A-2
EMC Conformity	A-3
Control Panel Dimensions	A-3
Environmental Conditions	A-3
Service Life	A-4
Control Panel	A-4



Supported Printer and Scanner

Printer:	EPSON AcuLaser C8500
Scanner:	EPSON GT-10000+ EPSON EXPRESSION 1640XL

Printer Interface Board Specifications

Rated voltage:	DC 5 V \pm 5%
Rated current:	1.8 A or less (including 1.0 A for the control panel)

Scanner Interface Board Specifications

Rated voltage:	DC 5 V \pm 5%
Rated current:	0.2 A or less

Service Life

15,000 hours

Control Panel

LCD and touch screen with white CCFT backlight:

Display pixels	320 × 240
Display area	115.2 × 86.4 mm
Pixel pitch	0.36 × 0.36 mm
Display pixel size	0.33 × 0.33 mm
Touch screen	8 × 6 matrix

Special key: Start, Stop, Reset, Color/Black, Face Up/Face Down, Memory, Admin, and numeric keypad

Indicator lights: Power, Ready, Error, Color/Black, and Face Up/Face Down

LCD brightness adjustment: Adjustment dial

Glossary

bit/pixel

The unit that indicates the number of bits allocated for a pixel. The larger the bit value, the more detail of a pixel will be reproduced.

color calibration

A method of adjusting the color image data for a particular type of device so that the reproduction results are as close as possible to the original colors.

default

A value or setting that takes effect when the printer is turned on, reset, or initialized.

document

The item, such as a sheet of paper or a book, that is placed on the document table for the scanner to read.

dots per inch (dpi)

The number of dots per inch is a measure of scanner and printer resolution. The higher the number of dots, the higher the resolution. See also resolution.

dpi

See dots per inch (dpi).

ink jet printer

A printer that transfers ink onto the paper by spraying the ink through a number of small nozzles.

interface

A piece of hardware, a method, or a standard used for connection between or among computer devices.

laser printer

A printer that uses a laser and the electrophotographic method to print a full page at a time. The laser is used to “paint” a charged drum with light, to which toner is applied and then transferred onto paper.

memory

The part of the printer’s electronic system that is used to store information. Some information is fixed and is used to control how the printer operates. See also ROM.

monochrome

Black and white images, or images represented only by the intensity of luminosity.

photoconductor unit

A component of the printer that contains a photosensitive print drum.

pixel

Short for picture element. Each image is composed of a number of pixels. Pixels are also counted in units of dots. Monitor resolution is generally measured in pixels.

resolution

A measure of the fineness and clarity of images captured by the scanner and reproduced by the printer or monitor. See also dots per inch (dpi) and pixel.

ROM

Read Only Memory (ROM) is where permanent information is stored.

scan

A scanner operation performed by the sensor and the carriage. The image is divided into pixels during scanning. See also pixel.

Index

Numerics

1-sided and 2-sided copy modes, 4-10

A

Administrator mode, 6-2, 6-3

Advanced copy modes, 5-2, 5-3, 5-7, 5-11, 5-15, 5-19

Auto feed, 6-5

Automatic Document Feeder, 1-8

B

Binding margin, 5-7

C

Changing default settings, 6-5

Collate, 5-19

Color adjust, 4-14, 4-15

Color calibration, 6-6

Consumable products, 1-9

Contacting EPSON, B-2

Contrast, 4-16

Controlling standby operation, 6-4

Control panel, parts, 1-3

Control panel, specifications, A-4

Copy system errors, 8-18

D

Document types, 4-12

E

EPSON Network Image Express, 1-8

EPSON special media, 3-2

Error messages, 8-5, 8-15, 8-18

F

Fit-to-Page option, 4-9

H

Hue, 4-21

J

Join Pages, 5-3

K

Key tones, 6-4

L

Language, selecting, 6-10

Large Capacity Paper Unit, 3-6

Loading paper, 3-10, 3-13, 3-18

M

Memory, 4-23, 4-25, 4-27

Moving, 7-2

O

Options, 1-7, 1-8

Output trays, 3-7, 3-9

P

Paper, 3-2, 3-4, 3-10

Paper sources, 3-5, 3-6, 3-17, 3-18

Parts, 1-2

R

Ready to Copy screen, 1-5

Remove Shadows, 5-15

Repacking, 7-2
Restoring default settings, 6-11
RGB, 4-17

S

Saturation, 4-20
Sensor control, 6-4
Split Pages, 5-11

T

Technical specifications, A-1
Technical support, B-2
Touch screen, 1-5
Transparencies, 3-17
Transparency Unit, 1-8
Transporting, 7-2
Troubleshooting, 8-2

Z

Zoom, 4-5, 4-7

Where to Find Information

Before using the EPSON AcuLaser Color Copy Station 8500, be sure to follow the instructions in the following manuals.

EPSON AcuLaser Color Copy Station 8500 Setup Guide

Explains how to assemble the copy station's components and test basic copying operation.

EPSON AcuLaser Color Copy Station 8500 Quick Reference

Gives you quick access to information needed for daily copying, including explanations of control panel functions and touch screen messages. This guide can be hung on the printer with the hook provided.

EPSON AcuLaser Color Copy Station 8500 Reference Guide (this manual)

Provides you with detailed information on the copy station, from general maintenance and troubleshooting to technical specifications.

For information on assembling and using the printer and the scanner, refer to the documentation included with each device.