

ROBOT CONTROLLER

RC700 Series

Maintenance Manual

Rev.3

ENM226C5418F

Original instructions

Control Unit RC700

RC700-A

Drive Unit RC700DU

RC700DU-A

ROBOT CONTROLLER RC700 / RC Series Maintenance Manual Rev.3

ROBOT CONTROLLER

RC700 Series Maintenance Manual

Rev.3

©Seiko Epson Corporation 2021-2022

FOREWORD

Thank you for purchasing our robot products.

This manual contains the information necessary for the correct use of the robot controller. Please carefully read this manual and other related manuals before installing the robot system.

Keep this manual handy for easy access at all times.

The robot system and its optional parts are shipped to our customers only after being subjected to the strictest quality controls, tests, and inspections to certify its compliance with our high performance standards. Please note that the basic performance of the product will not be exhibited if our robot system is used outside of the usage conditions and product specifications described in the manuals.

This manual describes possible dangers and consequences that we can foresee. Be sure to comply with safety precautions on this manual to use our robot system safely and correctly.

TRADEMARKS

Microsoft, Windows, and Windows logo are either registered trademarks or trademarks of Microsoft Corporation in the United States and/or other countries. Other brand and product names are trademarks or registered trademarks of the respective holders.

TRADEMARK NOTATION IN THIS MANUAL

Microsoft® Windows® 8 Operating system

Microsoft® Windows® 10 Operating system

Throughout this manual, Windows 8, and Windows 10 refer to above respective operating systems. In some cases, Windows refers generically to Windows 8, and Windows 10.

NOTICE

No part of this manual may be copied or reproduced without authorization.

The contents of this manual are subject to change without notice.

Please notify us if you should find any errors in this manual or if you have any comments regarding its contents.

MANUFACTURER

SEIKO EPSON CORPORATION

CONTACT INFORMATION

Contact information is described in “SUPPLIERS” in the first pages of the following manual:

Robot System Safety Manual Read this manual first

DISPOSAL

When disposing this product, dispose in accordance with the laws and regulations of each country.

Regarding battery disposal

The battery removal/replacement procedure is described in the following manuals:
Maintenance Manual

For European Union customers only



The crossed out wheeled bin label that can be found on your product indicates that this product and incorporated batteries should not be disposed of via the normal household waste stream. To prevent possible harm to the environment or human health please separate this product and its batteries from other waste streams to ensure that it can be recycled in an environmentally sound manner. For more details on available collection facilities please contact your local government office or the retailer where you purchased this product. Use of the chemical symbols Pb, Cd or Hg indicates if these metals are used in the battery.

This information only applies to customers in the European Union, according to DIRECTIVE 2006/66/EC OF THE EUROPEAN PARLIAMENT AND OF THE COUNCIL OF 6 September 2006 on batteries and accumulators and waste batteries and accumulators and repealing Directive 91/157/EEC and legislation transposing and implementing it into the various national legal systems.

For other countries, please contact your local government to investigate the possibility of recycling your product.

For Taiwanese customers only



Please separate used batteries from other waste streams to ensure that it can be recycled in an environmentally sound manner. For more details on available collection facilities please contact your local government office or the retailer where you purchased this product.

For California customers only

The lithium batteries in this product contain
Perchlorate Material - special handling may apply,
See www.dtsc.ca.gov/hazardouswaste/perchlorate

Before Reading This Manual

NOTE  Do not connect the followings to the TP/OP port of RC700 / RC700-A. Connecting to the followings may result in malfunction of the device since the pin assignments are different.

OPTIONAL DEVICE dummy plug

Operation Pendant OP500

Operator Pendant OP500RC

Jog Pad JP500

Teaching Pendant TP-3**

Operator Panel OP1

NOTE  For RC700 / RC700-A, be sure to install the EPSON RC+7.0 to the development PC first, then connect the development PC and RC700 / RC700-A with the USB cable.

If RC700 / RC700-A and the development PC are connected without installing the EPSON RC+7.0 to the development PC, [Add New Hardware Wizard] appears. If this wizard appears, click the <Cancel> button.

NOTE  Concerning the security support for the network connection:

The network connecting function (Ethernet) on our products assumes the use in the local network such as the factory LAN network. Do not connect to the external network such as Internet.

In addition, please take security measure such as for the virus from the network connection by installing the antivirus software.

NOTE  Security support for the USB memory:

Make sure the USB memory is not infected with virus when connecting to the Controller.

NOTE



In this manual, the control unit and drive unit may be collectively referred to as “controller”.

Structure of Robot System

The Drive Unit RC700DU can be used with the following version.

EPSON RC+ 7.0 Ver.7.1.0 or later

Control Unit RC700-A

Drive Unit RC700DU-A can be used with the following version.

EPSON RC+ 7.0 Ver.7.1.2 or later

Each manipulator can be used with the following version.

C4 Series	: EPSON RC+ 7.0 Ver.7.0.0
C8 Series (C8XL)	: EPSON RC+ 7.0 Ver.7.1.3
C8 Series (C8, C8L)	: EPSON RC+ 7.0 Ver.7.1.4
C8 Series (wall mounting)	: EPSON RC+ 7.0 Ver.7.2.0
C12 Series	: EPSON RC+ 7.0 Ver.7.4.6
N2 Series	: EPSON RC+ 7.0 Ver.7.2.0
N6 Series (N6-A1000**)	: EPSON RC+ 7.0 Ver.7.3.4
N6 Series (N6-A850**R)	: EPSON RC+ 7.0 Ver.7.4.1
G1, G3, G6, G10, G20, RS Series	: EPSON RC+ 7.0 Ver.7.1.2

The Manuals of This Product

The following are typical manual types for this product and an outline of the descriptions.

Safety Manual (book, PDF)

This manual contains safety information for all people who handle this product. The manual also describes the process from unpacking to operation and the manual you should look at next.

Read this manual first.

- Safety precautions regarding robot system and residual risk
- Declaration of conformity
- Training
- Flow from unpacking to operation

RC700 series Manual (PDF)

This manual explains the installation of the entire robot system and the specifications and functions of the controller. The manual is primarily intended for people who design robot systems.

- The installation procedure of the robot system (specific details from unpacking to operation)
- Daily inspection of the controller
- Controller specifications and basic functions

xx series Manual (PDF)

(xx: Manipulator series name)

This manual describes the specifications and functions of the Manipulator. The manual is primarily intended for people who design robot systems.

- Technical information, functions, specifications, etc. required for the Manipulator installation and design
- Daily inspection of the Manipulator

Status Code/Error Code List (PDF)

This manual contains a list of code numbers displayed on the controller and messages displayed in the software message area. The manual is primarily intended for people who design robot systems or do programming.

RC700 series Maintenance Manual (PDF)

xx series Maintenance Manual (PDF)

(xx: Manipulator series name)

This manual describes the details of maintenance etc. The manual is intended for people who perform maintenance.

- Daily inspection
- Replacement and repair of maintenance parts
- The method of firmware update and controller setting backup etc.

EPSON RC+ 7.0 User's Guide (PDF)

This manual describes general information about program development software.

EPSON RC+ 7.0 SPEL+ Language Reference (PDF)

This manual describes the robot programming language "SPEL+".

Other Manual (PDF)

Manuals for each option are available.

Maintenance

1. Safety Precautions on Maintenance	3
2. Regular Maintenance Inspection	5
2.1 Inspection Point and Frequency	5
2.2 Timing of Replacement.....	5
3. Controller Structure	6
3.1 Location of Parts	6
3.1.1 RC700	6
3.1.2 RC700-A.....	6
3.1.3 RC700DU	7
3.1.4 RC700DU-A	7
3.2 Diagram of Cable Connections.....	8
3.2.1 RC700	8
3.2.2 RC700-A.....	9
3.2.3 RC700DU	10
3.2.4 RC700DU-A	11
4. Backup and Restore	12
4.1 What is the Backup Controller Function?	12
4.2 Backup Data Types	12
4.3 Backup	13
4.4 Restore.....	14
5. Firmware Update	17
5.1 Updating Firmware.....	17
5.2 Firmware Upgrade Procedure	17
5.3 Controller Recovery	20
5.4 Firmware Initialization Procedure	21
5.5 Adding Confirmation Steps by Strengthening Security of EtherNet Connection	23

6. Alarm	27
6.1 Before Controller Firmware Ver.7.1.8.x.....	28
6.1.1 Alarm Configuration	28
6.1.2 How to View the Alarm Information	29
6.1.3 How to Edit the Alarm Information.....	30
6.1.4 Alarm Notifying Method.....	30
6.1.5 How to Cancel the Alarm	31
6.2 Controller Firmware Ver.7.2.0.x or later	32
6.2.1 Maintenance.....	32
6.2.2 How to View the Maintenance Information.....	33
6.2.3 How to Edit the Maintenance Information.....	35
6.2.4 Alarm Notifying Method.....	36
6.2.5 How to Cancel the Alarm	36
7. Option Parts Replacement Procedures	37
7.1 Option Board.....	37
7.2 EUROMAP67 Board.....	38
7.3 Wall Mounting Option	40
8. Maintenance Parts Replacement Procedures	45
8.1 Fan Filter.....	45
8.2 Fan.....	46
8.2.1 Front Fan.....	46
8.2.2 Fan 2 (RC700-A, RC700DU-A)	47
8.3 Battery.....	49
8.4 CF (Compact Flash)	51
8.5 MDB	52
8.6 DMB	56
8.6.1 DMB for Control Unit.....	56
8.6.2 DMB for Drive Unit.....	60
8.7 DMB-SUB Board.....	62
8.8 DMB-LED Board.....	64
7.8.1 DMB-LED Board (RC700, RC700DU).....	64
7.8.2 DMB-LED Board (RC700-A, RC700DU-A).....	65
8.9 DPB.....	66
9. Verifying Robot System Operation	68

10. Troubleshooting	69
10.1 Error Code Table	69
10.2 Cannot Connect the Development PC and the Controller using the USB cable	69
10.2.1 Confirmation Using Windows Device Manager	70
10.2.2 When recognized under “Other devices” in Windows Device Manager.....	72
11. Maintenance Parts List	73
12. Option Parts List	75



RC700 Series Maintenance

This section contains maintenance procedures for the Control Unit RC700 / RC700-A and Drive Unit RC700DU / RC700DU-A.

1. Safety Precautions on Maintenance

NOTE

Important safety considerations are indicated throughout the manual by the following symbols. Be sure to read the descriptions shown with each symbol.

 WARNING	This symbol indicates that a danger of possible serious injury or death exists if the associated instructions are not followed properly.
 WARNING	This symbol indicates that a danger of possible harm to people caused by electric shock exists if the associated instructions are not followed properly.
 CAUTION	This symbol indicates that a danger of possible harm to people or physical damage to equipment and facilities exists if the associated instructions are not followed properly.

 WARNING	<ul style="list-style-type: none"> ■ Teaching robot system shall be performed by personnel who has taken robot system training held by us and suppliers ■ Maintenance of robot system shall be performed by personnel who has taken robot system training held by us and suppliers. ■ Make sure to use only dedicated/specified maintenance parts especially for the optional boards or any other parts in the Controller to be replaced. Using non-specified parts may cause serious damage to the robot system and/or serious safety problems. ■ Do not remove any parts that are not covered in this manual. Follow the maintenance procedure strictly as described in this manual. Do not proceed using any methods other than described in this manual when you do replace a part or maintain the equipment. Improper removal of parts or improper maintenance may cause not only improper function of the robot system but also serious safety problems.
--	--

 WARNING	<ul style="list-style-type: none"> ■ Before performing any maintenance procedure, always make sure that the main power of the Controller is turned OFF, disconnect the power supply, and that the high voltage charged area is completely discharged. Performing any maintenance procedure while the main power is ON or the high voltage charged area isn't discharged completely is extremely hazardous and may result in electric shock and/or cause serious safety problems.
--	---

 CAUTION	<ul style="list-style-type: none"> ■ Do not touch the Motor Driver modules and Switching Power Supply directly in the Controller. The metal resistance of these can become very hot and may result in a burn. If you maintain them, examine the surface temperatures and wear protective gloves if necessary. ■ Do not shock, shake, or drop any parts during maintenance. When the parts related with data are shocked physically, they may be damaged and may also cause data loss during data loading/saving. ■ Do not lose the screws removed at maintenance. When the screw is dropped into the Controller, be sure to take it out. Leaving the screw in the Controller may cause short circuit and may result in equipment damage to the parts and/or robot system. ■ Make sure that the power rating (wattage) of a new Motor Driver module is correct. Using a Motor Driver module with improper power rating (wattage) in the Controller may cause improper function of the robot system and errors. ■ The serial number of the Manipulator that should be connected is indicated on the Connection Check Label on the Controller. Connect the Controller and the Manipulator correctly. Improper connection between the Controller and the Manipulator may cause not only improper function of the robot system but also serious safety problems.
--	--

NOTE  Before performing maintenance on the Controller, all the data must be copied as a backup. The details of data backup/restore are described in the 4. *Backup and Restore*.

2. Regular Maintenance Inspection

Performing regular maintenance inspection properly is essential for preventing trouble and maintaining safety. This chapter describes the schedules for maintenance inspection and procedures.

Be sure to perform the maintenance inspections in accordance with the schedules.

You will need following tools for maintenance inspection.

Phillips screwdriver Nipper
 Slotted head screwdriver Tester
 Nut driver

2.1 Inspection Point and Frequency

Inspection Point	Frequency	Method	Check Item
Controller	12 months	Turn ON/OFF motor and Restart	Activates without any error
Emergency Stop Button	12 months	When the motor turned on, activate the emergency stop button	Turns off the motor
Safeguard	12 months	When the motor turned on, turn on the safeguard	Turns off the motor
Fan Filter	1 months	Visual inspection and cleaning	No stain
Fan (Front)	1 months	Checking the operating sound	No noise
Fan (Rear)	1 months	Checking the operating sound	No noise
Battery	12 months	Visual inspection of seven-segment and LED	No alarm occurred

2.2 Timing of Replacement

Part	Frequency	Parts Code	Working Time (Rough)	Reference
Fan Filter	4 years or deteriorated	2195106	5 min.	8.1 Fan Filter
Fan (Front)	Error 515 occurred or noise	2157260	20 min.	8.2.1 Front Fan
Fan (Rear)	Error 515 occurred or noise	2157260	15 min.	8.2.2 Fan 2 (only RC700-A)
Battery	Every 5 years or error 511 occurred	2113554	5 min.	8.3 Battery

3. Controller Structure

3.1 Location of Parts

3.1.1 RC700

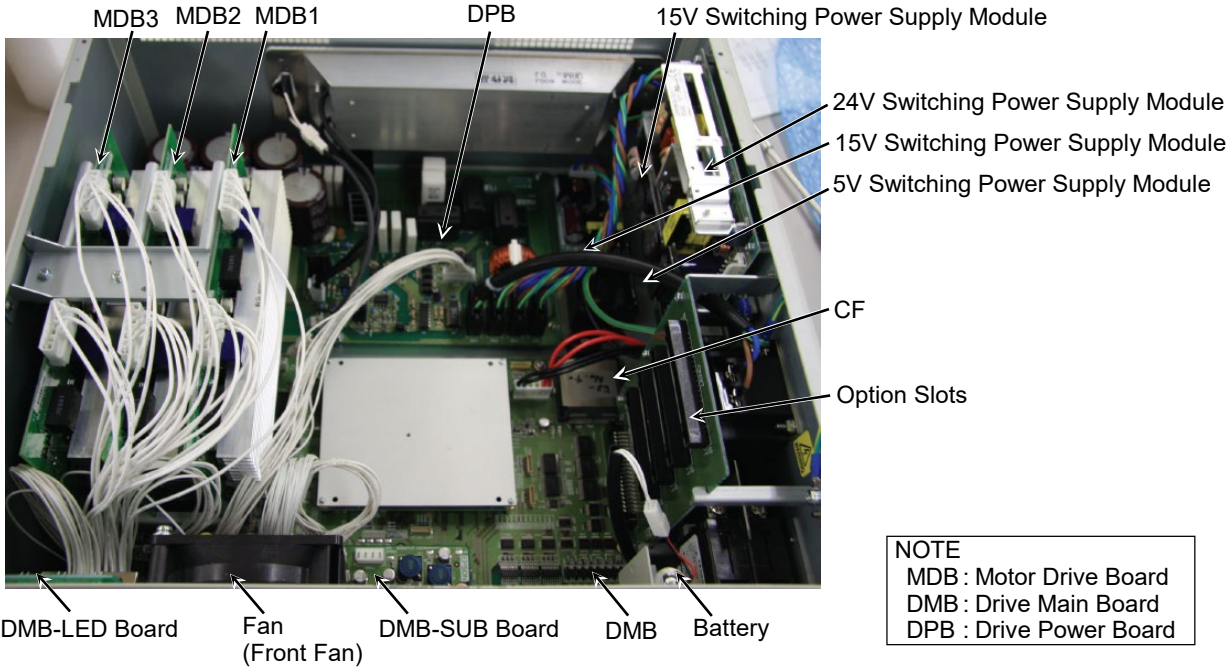

3.1.2 RC700-A

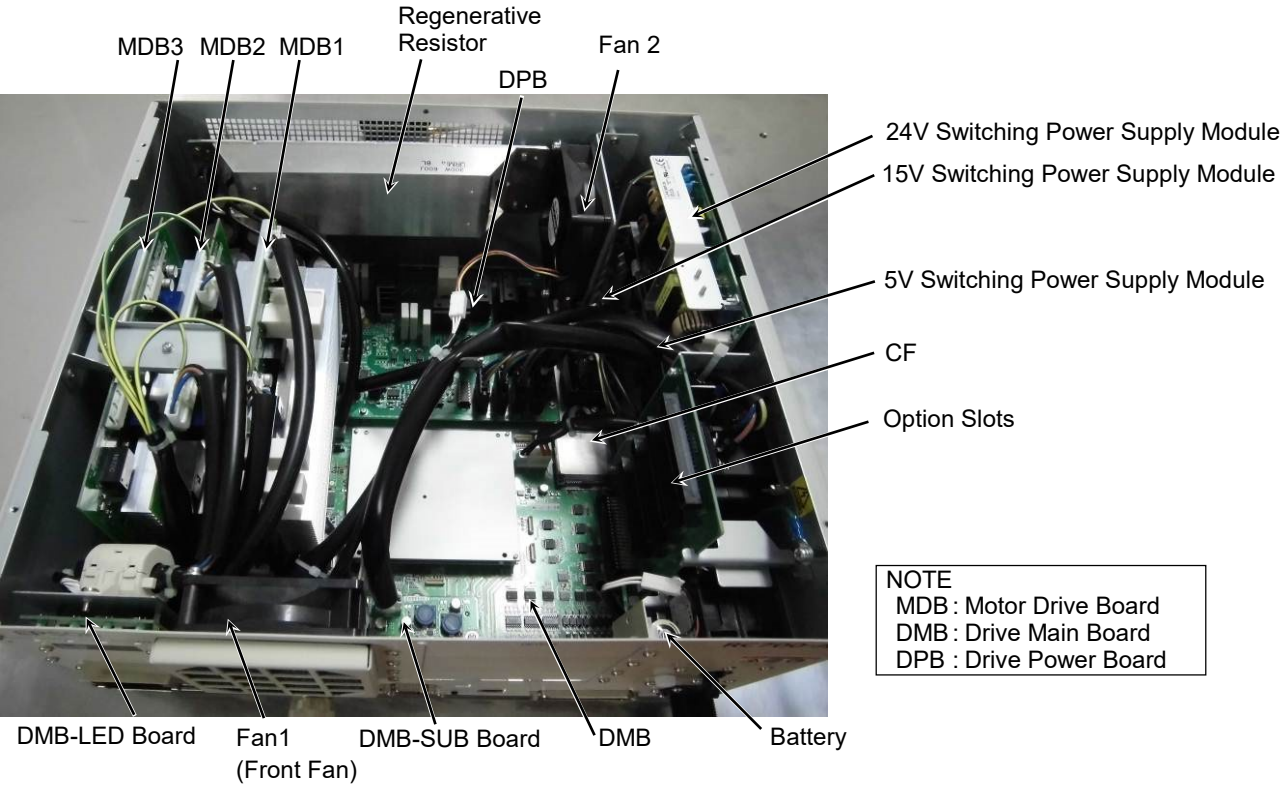

* MDB3 is not supplied for G1, G3, G6, G10, G20, and RS.

3.1.3 RC700DU

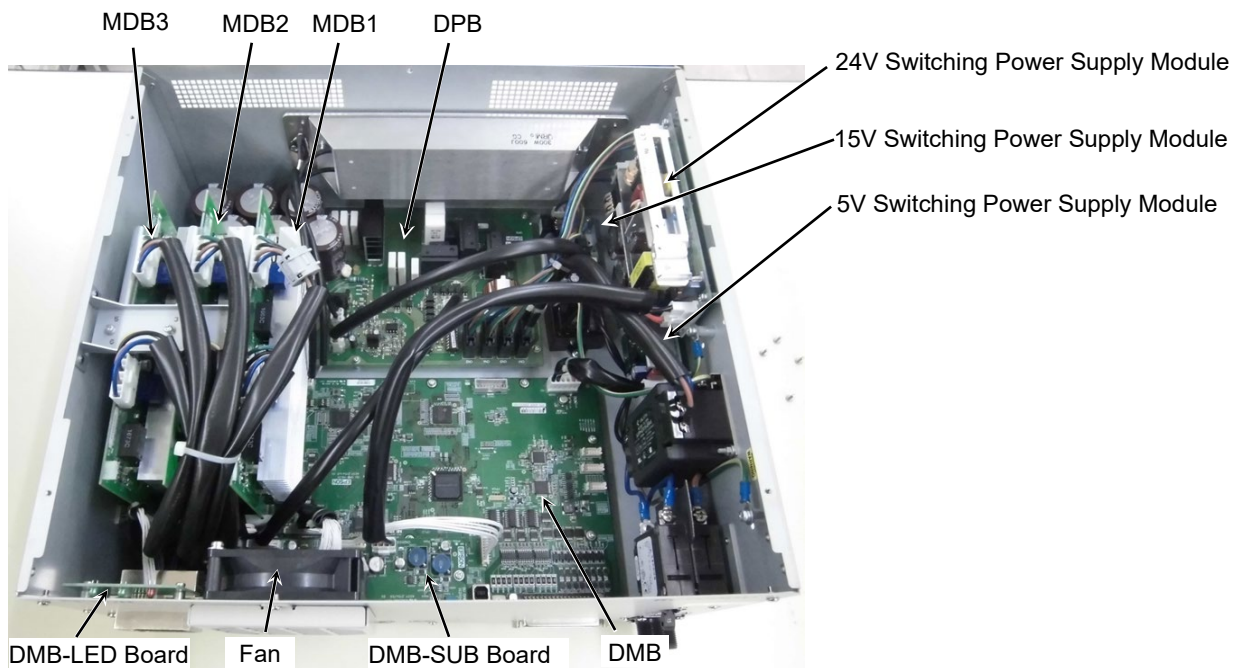

3.1.4 RC700DU-A

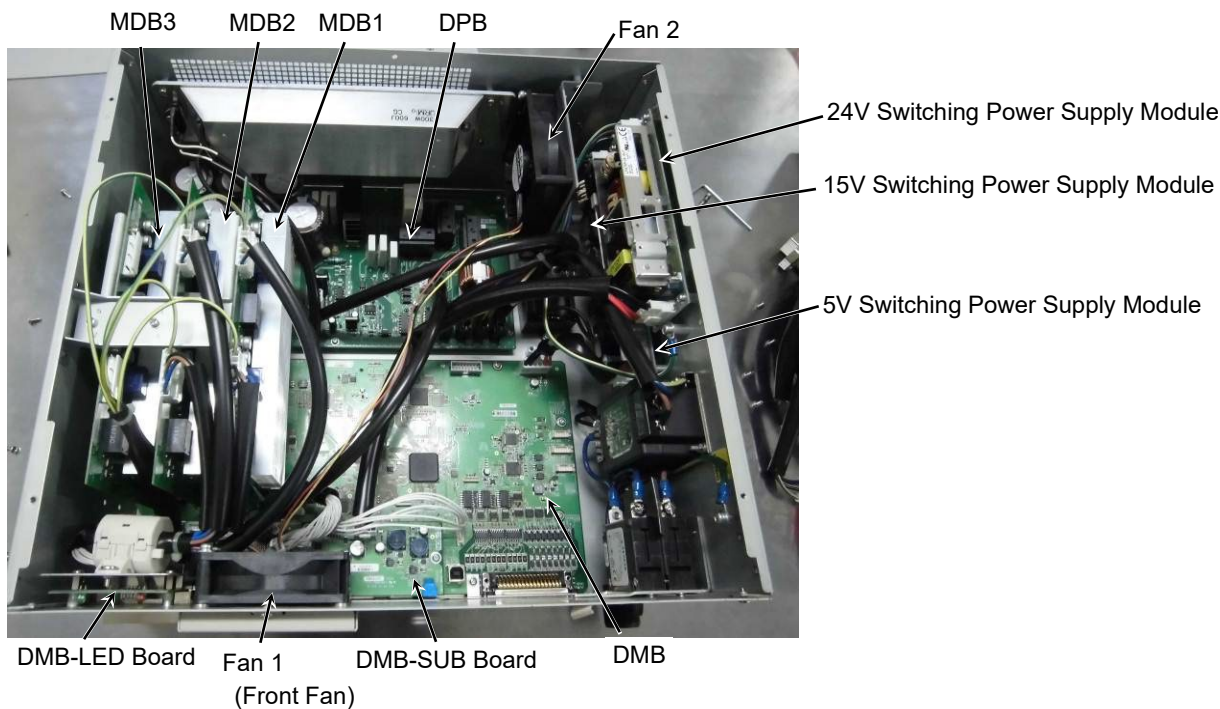

(There is no MDB3 for G1, G3, G6, G10, G20, RS.)

3.2 Diagram of Cable Connections

3.2.1 RC700

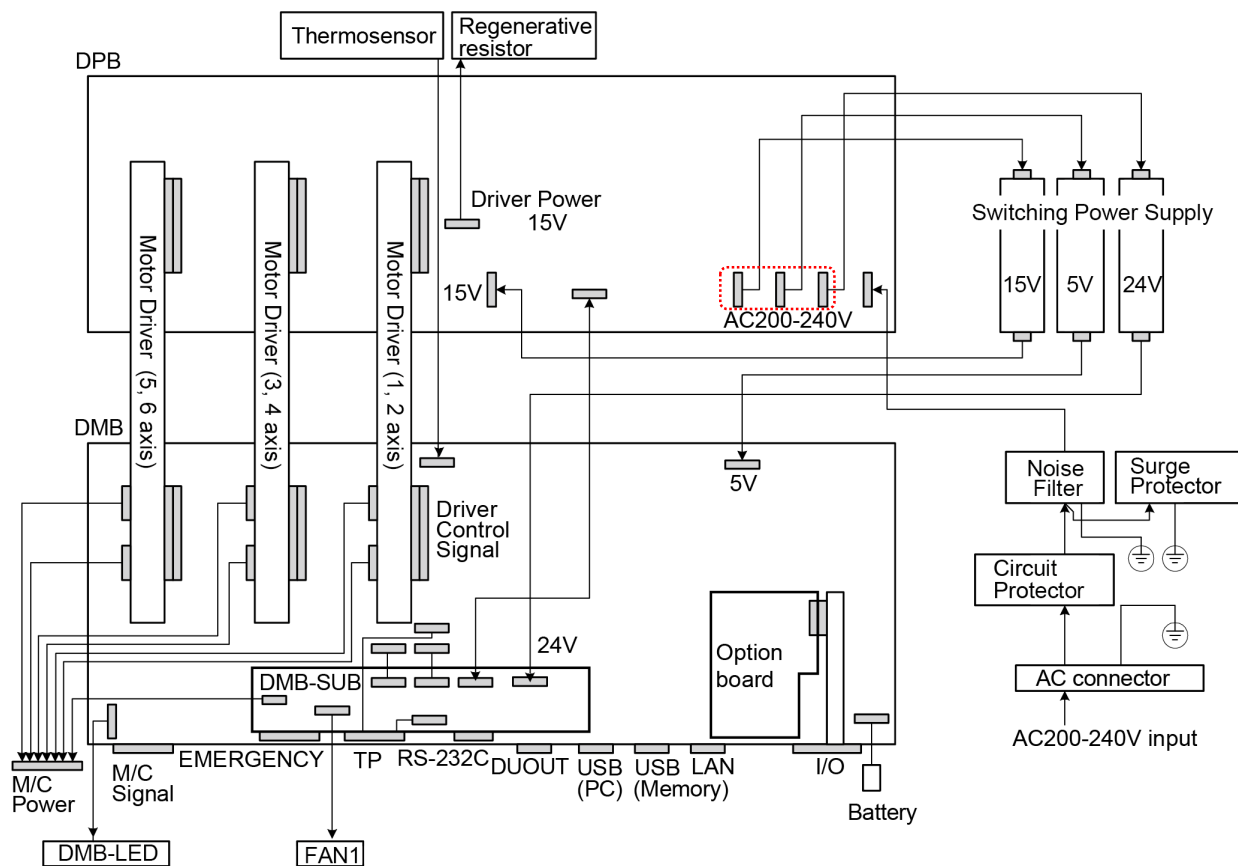

(Connectors in the red dotted line work properly in any order.)

3.2.2 RC700-A

C4, C8, C12, G1, G3, G6, G10, G20, RS

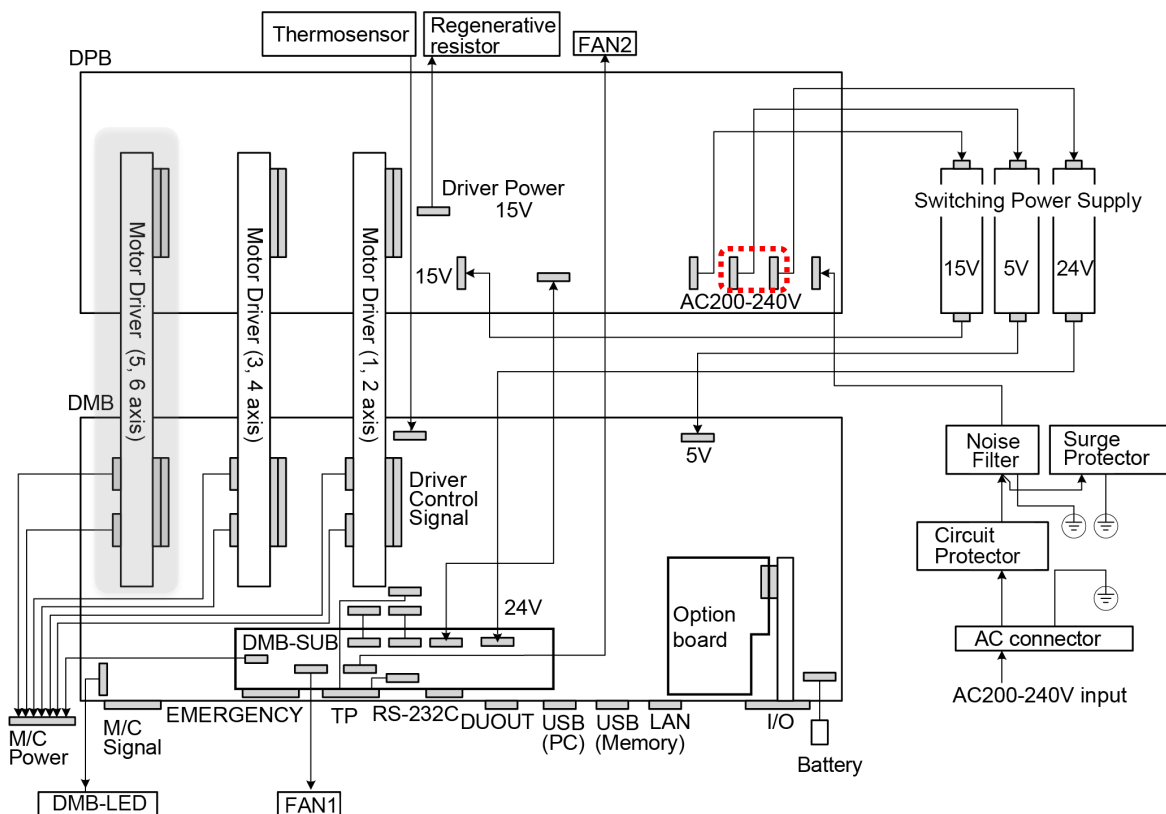

(Motor Driver (5, 6 axis) is not supplied for G1, G3, G6, G10, G20, and RS.)

(Connecters in the red dotted line work properly in any order.)

N2, N6

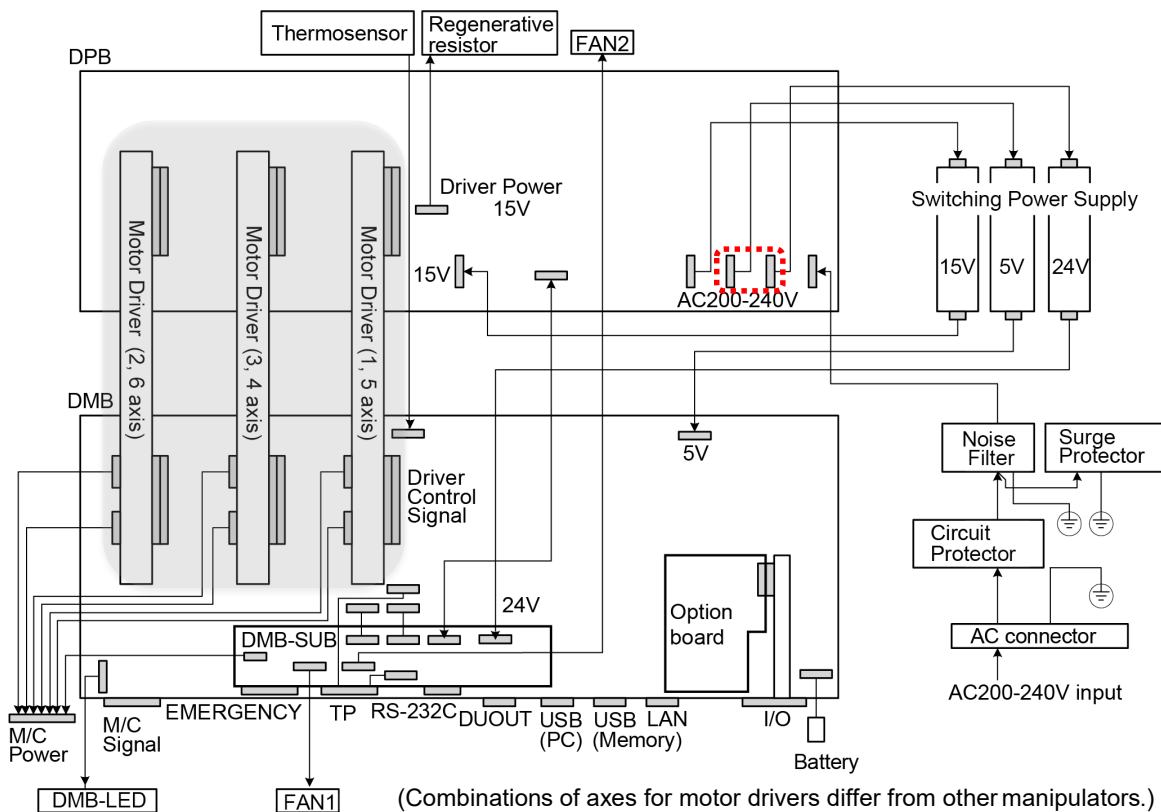

(Combinations of axes for motor drivers differ from other manipulators.)

(Connecters in the red dotted line work properly in any order.)

3.2.3 RC700DU

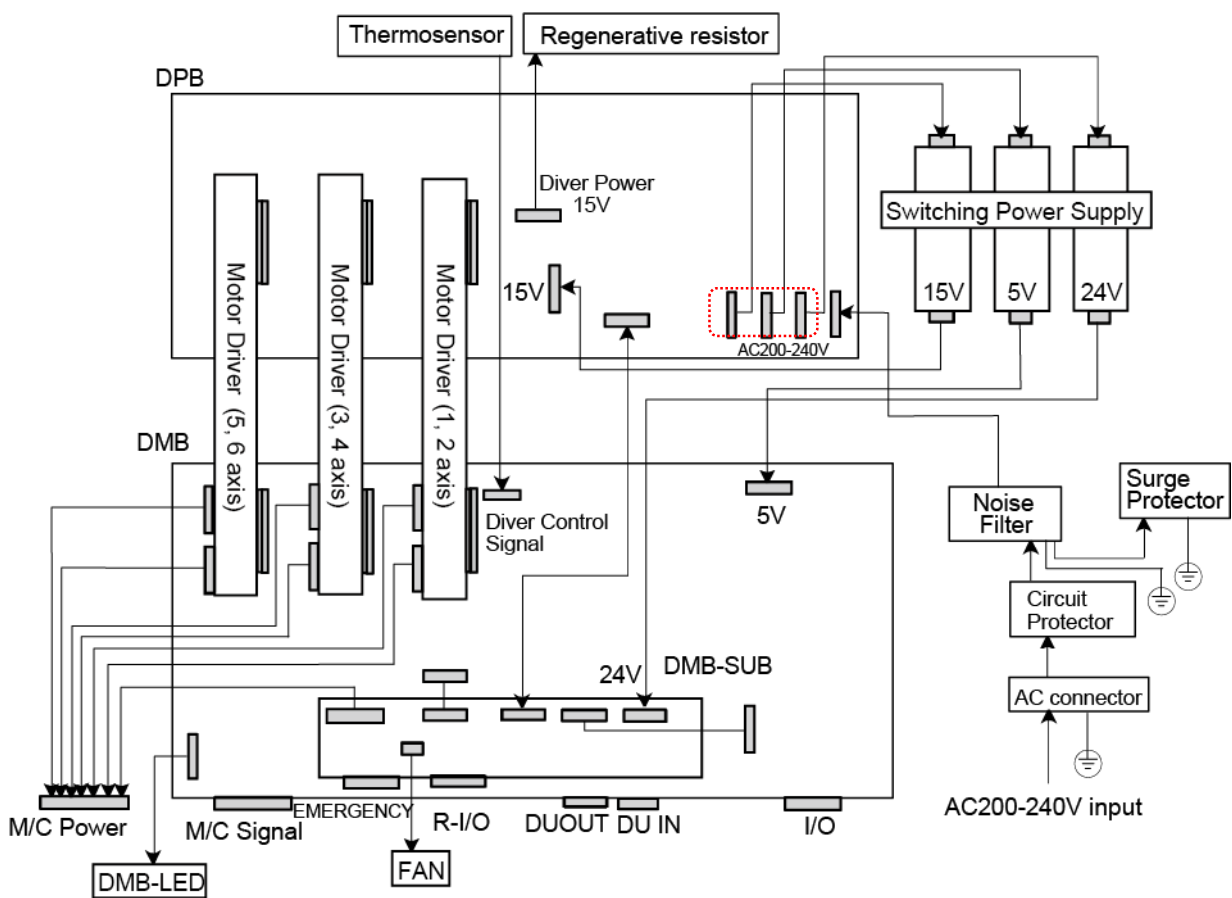

(Connectors in the red dotted line work properly in any order.)

3.2.4 RC700DU-A

C4, C8, C12, G1, G3, G6, G10, G20, RS

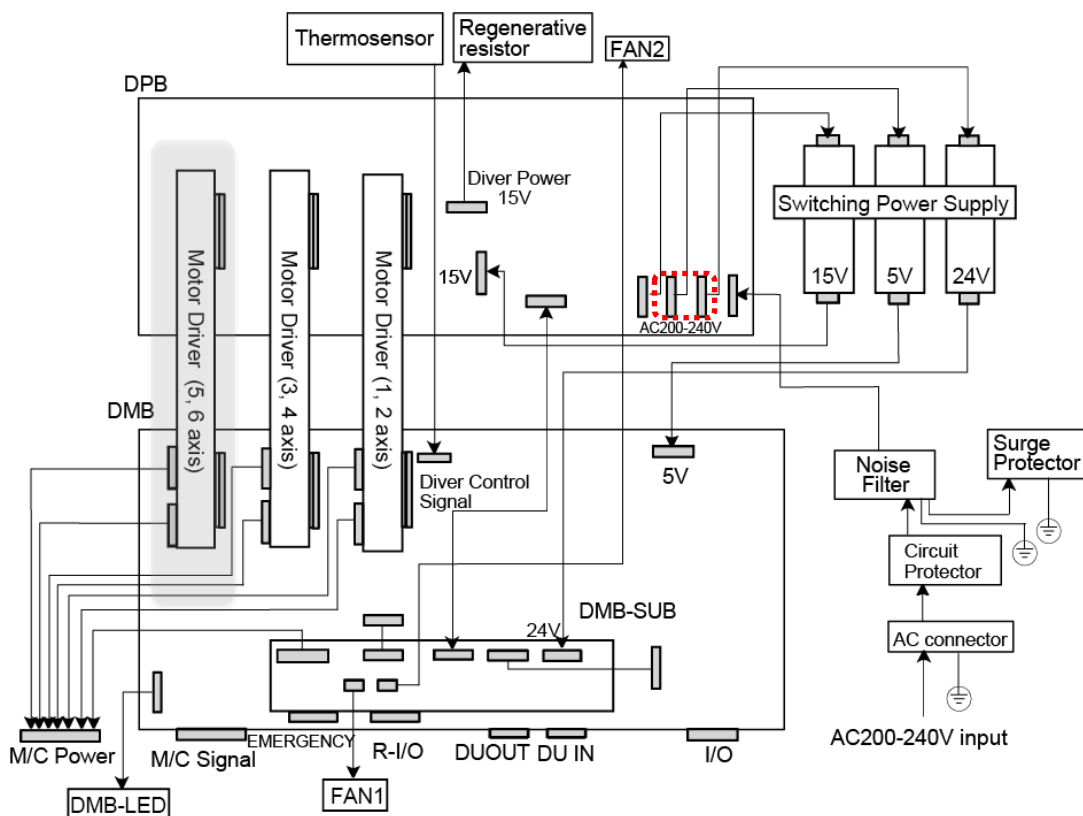

(Motor Driver (5, 6 axis) is not supplied for G1, G3, G6, G10, G20, and RS.)
 (Connectors in the red dotted line work properly in any order.)

N6

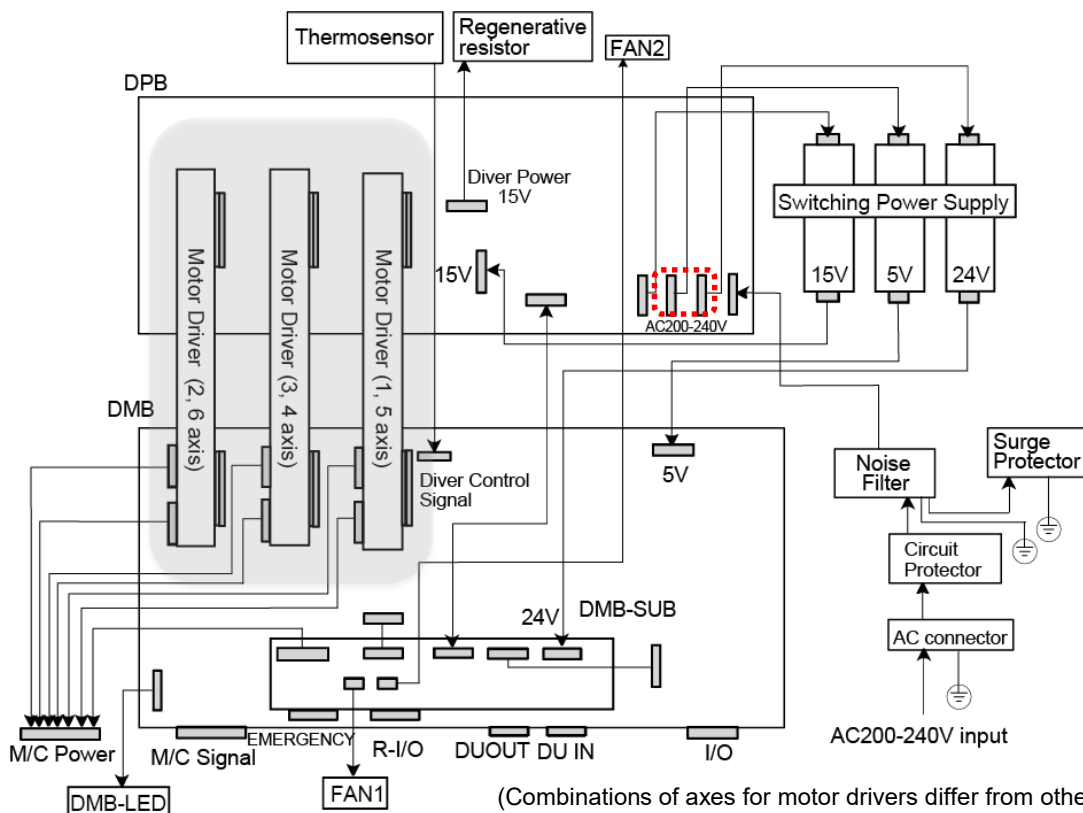

(Combinations of axes for motor drivers differ from other manipulators.)
 (Connectors in the red dotted line work properly in any order.)

4. Backup and Restore

4.1 What is the Backup Controller Function?

The Controller configuration set by EPSON RC+ 7.0 can be stored with the “Backup Controller” function.

The Controller settings can be restored easily using the data previously stored with “Backup Controller” after a configuration mistake or Controller problem.

Be sure to execute “Backup Controller” before changing the Controller setup, before maintenance, or after teaching.

For some problems, backup may not be available before maintenance has to be performed. Be sure to backup the data after making changes, before problems occur.

NOTE  “Controller status storage function” is one of the RC700 / RC700-A functions. It saves the Controller setup data same as “Backup Controller.”

There data can be used as the backup data at restoring.

The methods for “Controller Status Storage” are as follows:

A : “Controller backup to the USB memory”

For details, refer to *RC700 Series Manual Functions 8. Memory Port*.

B : “Export Controller backup function” in EPSON RC+ 7.0.

For details, refer to *EPSON RC+ 7.0 User’s Guide 5.9.10 [Import] Command (Project Menu)*.

4.2 Backup Data Types

The table below shows the files created with “Backup Controller”.

File Name	Overview	
Backup.txt	Information file for restore	File including information for restoring the Controller.
CurrentMnp01.PRM	Robot parameters	Stores information such as TISet.
InitFileSrc.txt	Initial configuration	Stores various Controller parameters.
MCSys01.MCD	Robot configuration	Stores connected Robot information.
All the files related to Project	Project related	All the project files transferred to the Controller. Includes program files when EPSON RC+ 7.0 is configured to transfer source code to the Controller.
GlobalPreserves.dat	Global Preserve variables	Saves values of Global Preserve variables.
WorkQueues.dat	WorkQue information	Saves information of Queues information of the WorkQue.

4.3 Backup

Backup the Controller status from the EPSON RC+ 7.0.

- (1) Select EPSON RC+ 7.0 menu-[Tools]-[Controller] to display the [Controller Tools] dialog.

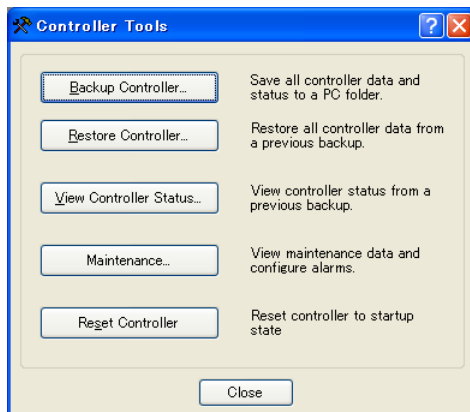

- (2) Click the <Backup Controller...> button to display the [Browse For Folder] dialog.



- (3) Specify the folder to save the backup data. Create a new folder if desired.
- (4) Click the <OK> button. A folder is created in the specified folder containing the backup data with a name in the following format.

B_ RC700_ serial number_ date status was saved
 → Example: B_RC700_12345_2013-10-29-092951



CAUTION

- Do not edit the backup files. Otherwise, operation of the robot system after data restoration to the Controller is not assured.

4.4 Restore

Restore the Controller status from the EPSON RC+ 7.0.

 CAUTION	<ul style="list-style-type: none"> ■ Make sure that the data used for restore was saved previously for same Controller. ■ Do not edit the backup files. Otherwise, operation of the robot system after data restoration to the Controller is not assured.
---	---

- (1) Select the EPSON RC+ 7.0 menu-[Tools]-[Controller] to display the [Controller Tools] dialog.

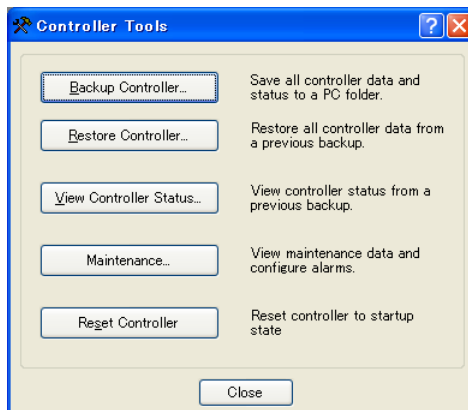

- (2) Click the <Restore Controller...> button to display the [Browse For Folder] dialog.

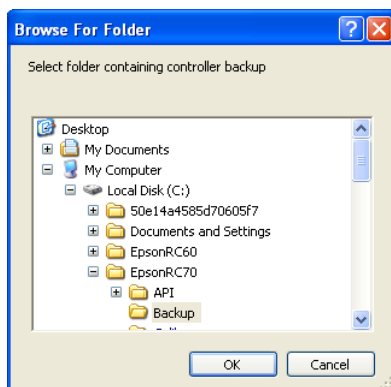

- (3) Specify the folder that contains the backup data. Backup data folders are named using the following format:

B_ RC700_ serial number_ date status was saved
 → Example: B_ RC700_ 12345_ 2011-04-03_ 092941



Data saved to the USB memory by the Backup Controller function can also be specified for restore.

- (4) Click the <OK> button to display the dialog to select the restore data.

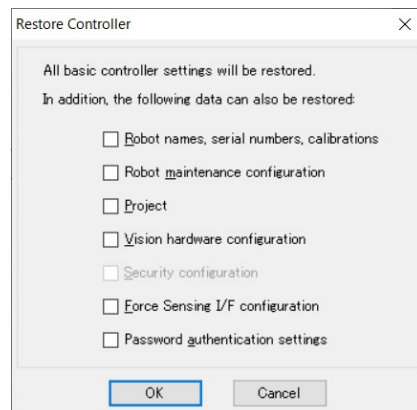

Robot name, serial #, calibration

This checkbox allows you to restore the robot name, robot serial number, Hofs data, and CalPIs data. Make sure that the correct Hofs data is restored. If the wrong Hofs data is restored, the robot may move to wrong positions.

This is not selected by the default setting.

Robot maintenance configuration

This checkbox allows you to restore the robot alarm related files.

For details, refer to *6 Alarm*.

This is not selected by the default setting.

Restoring saved backup data when check box EPSON RC+ 7.0 Menu- [Setup]- [System Configuration]- [Controller]- [Preferences]- [Enable robot maintenance data] is checked, the robot maintenance data is not applied if the box is not checked. So be careful.

Project

This checkbox allows you to restore the files related to projects.

The default is unchecked.

When a project is restored, the values of Global Preserve variables are loaded.

For details about Global Preserve variable backup, refer to *EPSON RC+ 7.0 User's Guide 5.10.10 [Display Variables] Command (Run Menu)*.

Vision hardware configuration

This checkbox allows you to restore the vision hardware configuration.

For details, refer to *EPSON RC+ 7.0 option Vision Guide 7.0*.

This is not selected by the default setting.

Security configuration checkbox

This checkbox allows you to restore the security configuration.

For details, refer to *EPSON RC+ 7.0 User's Guide 15. Security*.

This is not selected by the default setting.

Force Sensing I/F configuration

This checkbox allows you to restore the Force Sensing I/F configuration.

For details, refer to *EPSON RC+ 7.0 option Force Guide 7.0*.

This is not selected by the default setting.

Password authentication settings

This checkbox allows you to restore the setting of authentication for PC connection.

The authentication password for PC connection and the setting to disable connection authentication are restored.

This is not selected by the default setting.

- (5) Click the <OK> button to restore the system information.

NOTE

Restore the system configuration saved using Backup Controller only for the same system.

When different system information is restored, the following warning message appears.

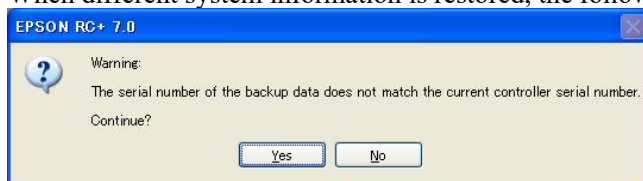

Click the <No> button (do not restore data) except for special situations such as Controller replacement.

NOTE

When restoring the backup which includes the data of the robot configured to the Drive Unit, be sure to restore the data while the Drive Unit is connected and turned ON.

NOTE

When restoring the backup including unsupported robot information to the target Controller, an error occurs.

5. Firmware Update

This chapter describes the firmware upgrade procedure and data file initialization when firmware or Robot configuration errors cause Controller startup or operation failure.

5.1 Updating Firmware

Firmware (software stored in non-volatile memory) and data files necessary to control the Controller and the Robot are preinstalled in the Controller. Controller configuration set from EPSON RC+ 7.0 is always saved in the Controller.

Controller firmware is supplied by CD-ROM as needed. Please contact the supplier of your region for information.

You must use a PC running EPSON RC+ 7.0 connected to a Controller with USB to update the Controller firmware. Firmware cannot be updated with an Ethernet connection.



When installing the firmware Ver.7.5.0.x or later, be sure to use the PC which EPSON RC+ 7.0 Ver.7.5.0 or later is installed.

5.2 Firmware Upgrade Procedure

The firmware upgrade procedure is described as follows:

- (1) Connect the development PC and the Controller with a USB cable (the firmware cannot be changed with an Ethernet connection).
- (2) Turn ON the Controller. (Do not start the development software EPSON RC+ 7.0 until the firmware upgrade is completed.)
- (3) Insert the “firmware CD-ROM” in the development PC CD-ROM drive.
- (4) Execute “Ctrlsetup70.exe”. The following dialog appears.
- (5) Select the <Upgrade> option button and click the <Next> button.

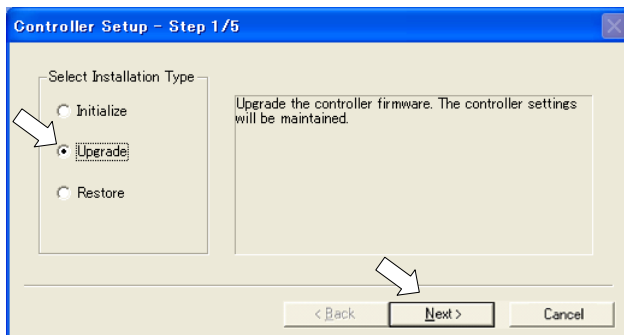

- (6) Make sure that the development PC is connected to the Controller with a USB cable and Click the <Next> button.

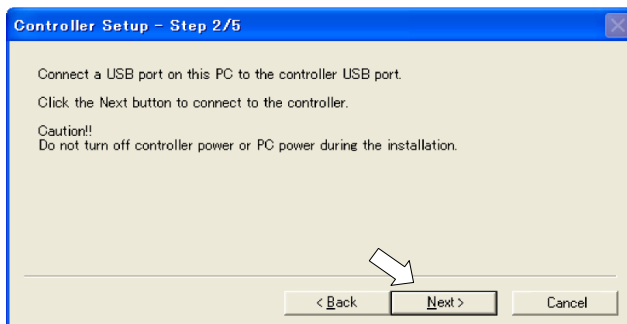

- (7) Check the current firmware version and the new firmware version and click the <Install> button.



NOTE

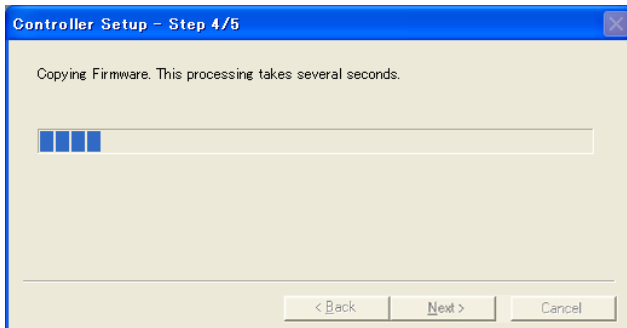

- (8) The firmware upgrade starts. It takes several minutes to complete. Do not disconnect the USB cable during transfer or turn OFF the Controller or the development PC.

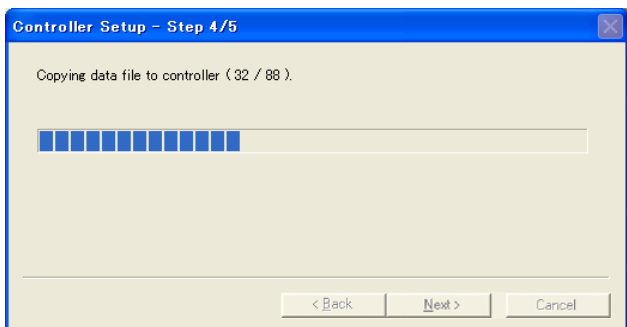

- (9) Continuous data file transfer starts.

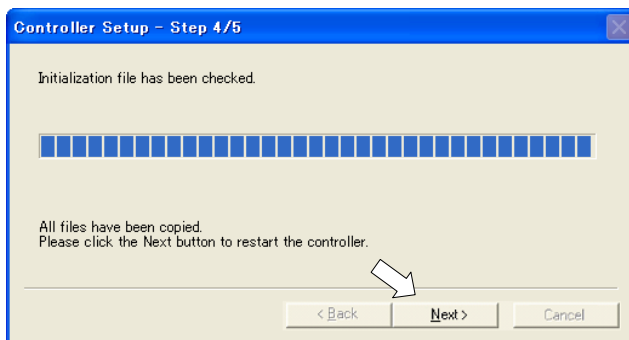

(10) The following dialog appears when transfer has completed. Click the <Next> button to reboot the Controller.



(11) The following dialog appears after the Controller reboot. Click the <Finish> button.

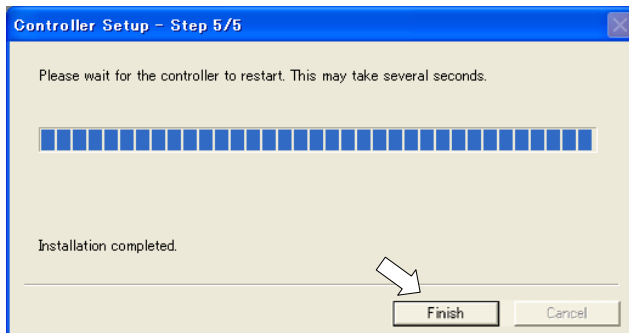

The firmware upgrade is complete.

NOTE

When you install the firmware (Ver.7.4.0.2 or later) on the Controller which the firmware (before Ver.7.4.0.2) has been installed, the following message is displayed.

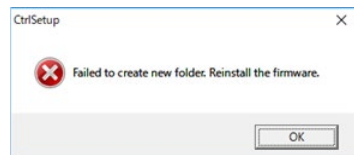

When the message is displayed, re-install the firmware.

5.3 Controller Recovery

If the Controller becomes inoperable, use the procedures described in this section to recover.



Controller Backup is recommended for easy recovery of the Controller operation. For details of Controller Backup, refer to 4. *Backup and Restore*.

The following two conditions describe the Controller error status after turning ON the Controller.

Condition A The Controller automatically changes to Recovery mode and the LED of ERROR, TEACH, and PROGRAM are lighting. You are able to communicate with the development PC though the Controller does not operate properly.

Condition B The LED of TEACH, AUTO, and PROGRAM do not blink.
Cannot communicate with the Controller using the development PC.

Countermeasure for the error status is as follows.

Condition A Follow 5.4 *Firmware Initialization Procedure* to initialize the firmware.

Condition B Execute the following steps:

- (1) Turn OFF the Controller.
- (2) Push the trigger button located on the front side of the Controller and while holding the button in, turn ON the Controller. Continue to hold in the trigger button for 30 seconds. This will cause the Controller to start in Recovery mode.
- (3) Make sure that the LED of ERROR, TEACH, and PROGRAM are lighting.
- (4) Follow the procedure in 5.4 *Firmware Initialization Procedure* from step (3) to initialize the firmware.

5.4 Firmware Initialization Procedure

The firmware initialization procedure described in this section.

- (1) Connect the development PC to the Controller with a USB cable (the firmware cannot be changed with an Ethernet connection).
- (2) Turn ON the Controller. Do not start the development software EPSON RC+ 7.0 until firmware initialization is complete.
- (3) Insert the “firmware CD-ROM” in the development PC CD-ROM drive.
- (4) Execute “Ctrlsetup.exe”.
- (5) Select the <Initialize> option button and click the <Next> button.

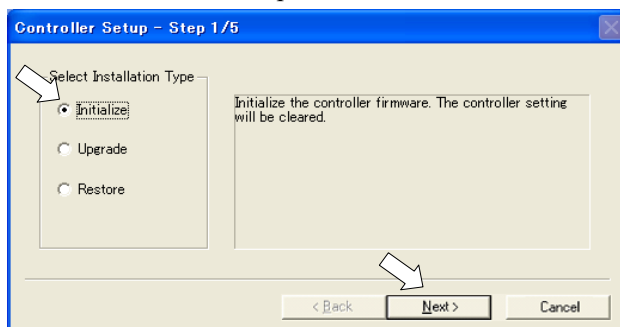

- (6) Make sure that the development PC is connected to the Controller with a USB cable and Click the <Next> button.

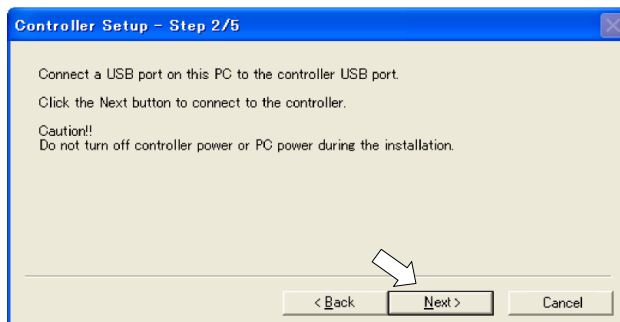

- (7) Check the version information and click the <Install> button.

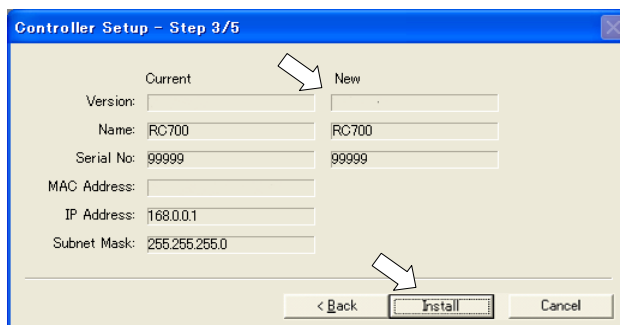

Firmware and data file transfer starts. It takes several minutes to complete.

NOTE

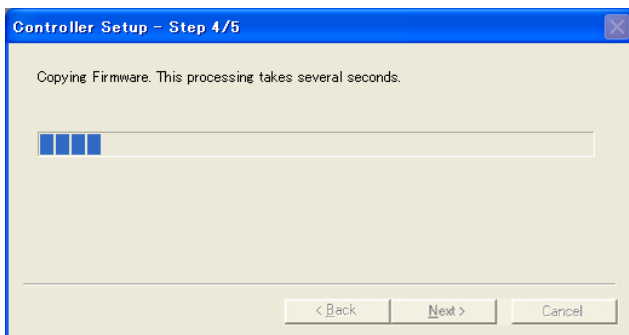

Do not disconnect the USB cable during transfer or turn OFF the Controller or the development PC.

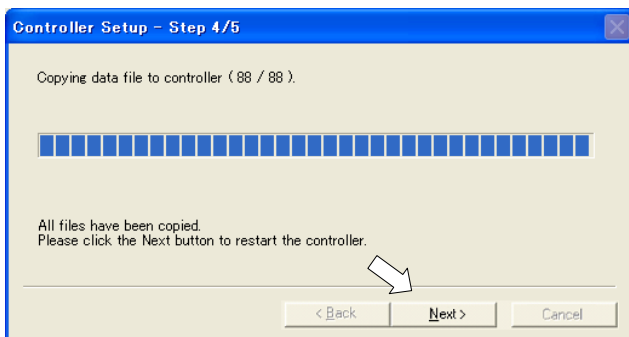

- (8) The following dialog appears when transfer is completed. Click the <Next> button to reboot the Controller.

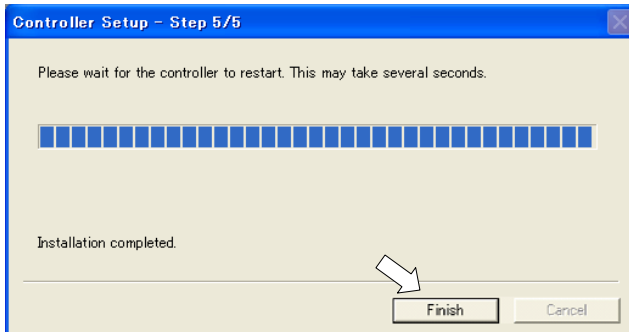

- (9) The following dialog appears after the Controller reboot. Click the <Finish> button.



The firmware upgrade is completed.

Start EPSON RC+ 7.0 and restore the Controller settings.

For details of restoring the operating system, refer to 4. *Backup and Restore*.

NOTE

When you install the firmware (Ver.7.4.0.2 or later) on the Controller which the firmware (before Ver.7.4.0.2) has been installed, the following message is displayed.

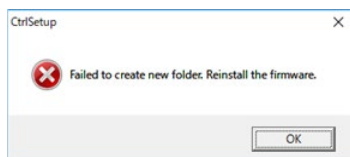

When the message is displayed, re-install the firmware.

5.5 Adding Confirmation Steps by Strengthening Security of EtherNet Connection

From the following firmware version password authentication is required when connecting Controllers and PCs to a global accessible network.

F/W : Ver.7.4.8.x

In the following cases, connections of EtherNet (PC) connector and Remote Ethernet are not available.

Controller IP address is set to global IP address

Firmware version is 7.4.8.x or later

EPSON RC+7.0 is Ver.7.4.7 or before

When the Controller firmware is updated under the following conditions, additional steps to confirm whether to continue the firmware update may be execute depending on the configuration settings of the Controller. (step 3 or later shown below)

Controller IP address is set to global IP address

Firmware version to be installed is 7.4.8.x or later

The following describes the steps to confirm whether to continue the firmware update.

- (1) Insert “Firmware CD-ROM” to be installed into the CD-ROM driver of the development PC.
- (2) Execute “CtrlSetup70.exe”.
- (3) Controller Setup window is displayed.

Select the <Upgrade> button and click the <Next> button.

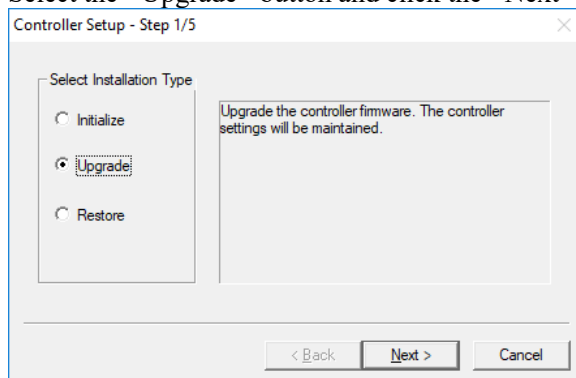

(4) Step 2 window is displayed.

Click the <Next> button.

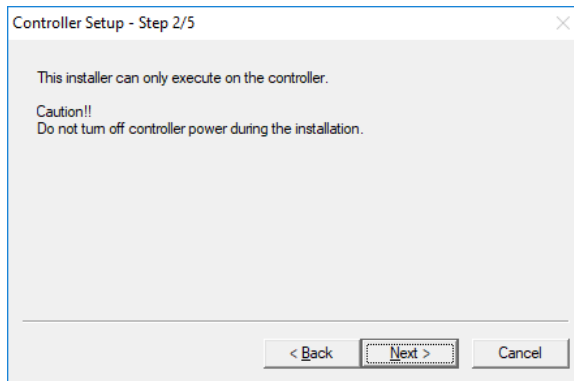

(5) Step 3 window is displayed.

(5)-1 When the steps to confirm whether to continue the firmware update is not executed:

Step 3 window is displayed.

Follow the instructions on the window and install the firmware.

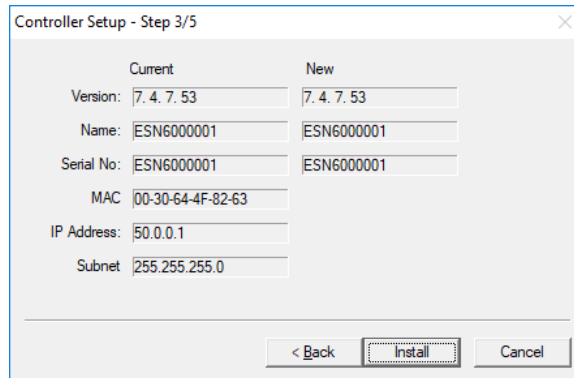

(5)-2 When the steps to confirm whether to continue the firmware update is executed:

The following window is displayed.

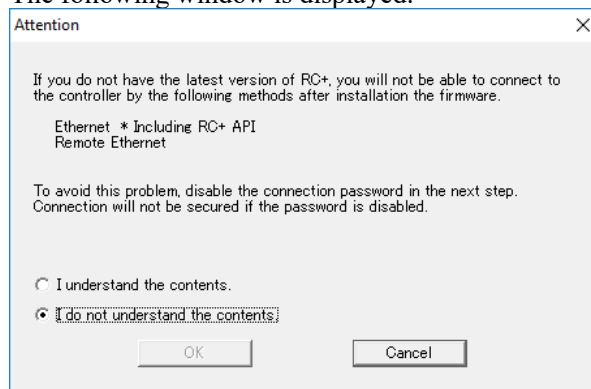

When the <I understand the contents> button is selected, the <OK> button will be enabled.

When the <OK> button is clicked, Step3 window is displayed. Go to the step (6).

When the <Cancel> button is clicked, Step3 window is displayed. The [Disable connection password] checkbox and the <Install> button will be grayed out and cannot be selected.

(6) Step 3 window is displayed.

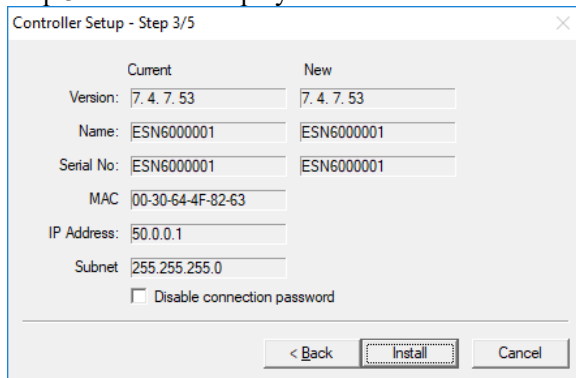

(6)-1 If the [Disable connection password] checkbox is selected, connection authentication after updating the firmware is disabled.

(6)-2 If the <Install> button is clicked, the confirmation window is displayed.

When the [Disable connection password] checkbox is selected:

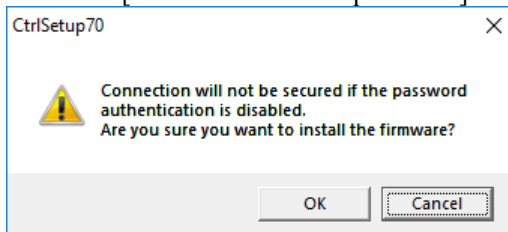

When the [Disable connection password] checkbox is not selected:

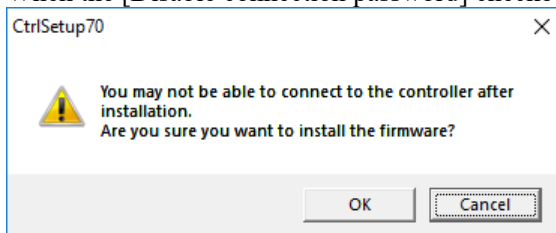

When the <OK> button is clicked, Step 4 window is displayed. Go to the step (7).

When the <Cancel> button is clicked, the window is closed.

(7) Firmware installation starts.

When the firmware is installed, click the <Next> button. Reboot the Controller.

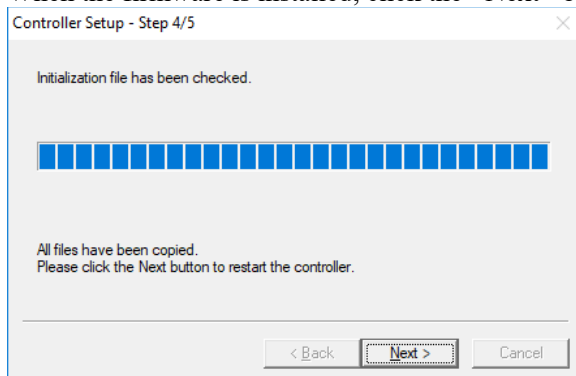

- (8) When the Controller is rebooted, the following window is displayed.
Confirm that the firmware is installed.
Click the <Finish> button.

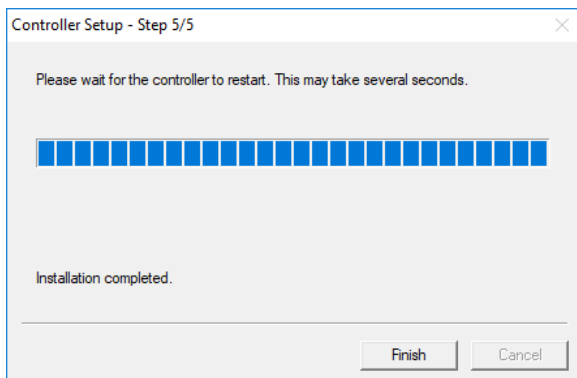

6. Alarm

When the batteries (lithium batteries) for the Controller and the Manipulator drain, an alarm warning voltage reduction occurs. However, the alarm does not guarantee the battery lives until replacement, and it is necessary to replace the batteries immediately. If you run out the batteries, the robot parameters will be lost and recalibration of the robot will be required.

In addition, the parts for the Manipulator joints may cause accuracy decline or malfunction due to deterioration of the parts resulting from long term use. If the robot breaks down due to deterioration of the parts, it will take significant time and cost for repair.

The following sections describe the alarm function which announces the following maintenance timings in order to perform maintenance well ahead of time before the warning error.

The maintenance timings to be announced differ depending on the Controller firmware version.

Refer to the section according to the firmware version of your Controller.

Controller firmware Ver.	Maintenance items
Before Ver.7.1.8.x	<ul style="list-style-type: none"> - Controller battery replacement - Robot battery replacement - Grease up
Ver.7.2.0.x or later	<ul style="list-style-type: none"> - Controller battery replacement - Robot battery replacement - Grease up - Replacement of the timing belt - Replacement of the motor - Replacement of the reduction gear unit - Replacement of the ball screw spline unit

6.1 Before Controller Firmware Ver.7.1.8.x

6.1.1 Alarm Configuration

The alarm can be configured to announce the maintenance timings of robot battery/grease, and Controller battery. Expiration time of the alarm is set one month prior to the maintenance timing if setting the parts replacement date or grease up timing.

 CAUTION	<ul style="list-style-type: none"> ■ Make sure that the date and time on the Controller are set correctly. The alarm cannot function properly with improper date and time setting. ■ If the CPU board or CF is replaced, the alarm information may be lost. When you replaced these parts, confirm the date and time of the Controller and alarm information.
--	---

6.1.1.1 Robot Battery and Grease Up

When the robot is configured or changed, an alarm for the battery replacement and grease up will be configured automatically.

The following parts are subject to grease up:

6-axis robot: Bevel gear on the Joint #6

SCARA (including RS series): Ball screw spline unit on the Joint # 3

When the robot is deleted from the configuration, the alarm will also be automatically deleted.

For details on the robot configuration, refer to *the EPSON RC+ 7.0 User's Guide 10.1 Setting the Robot Model*.

 CAUTION	<ul style="list-style-type: none"> ■ Changing of the robot should be done carefully. The alarm setting will be reset when the robot is changed.
--	--

NOTE  The first alarm for the robot battery replacement and grease up after purchase may occur earlier than originally scheduled.

NOTE  If you are using the Controller with the firmware version before 7.1.0.x, the alarm information is not configured. In such case, edit the alarm information.
For details on the alarm information editing, refer to *6.1.3 How to Edit the Alarm Information*.

NOTE  The alarm information for the robot battery replacement and grease up depends on the Controller where the robot is configured to. If the robot is replaced with the other robot with a different serial number, the alarm will not function properly. When you replace the robot, edit the alarm information.
For details on the alarm information editing, refer to *6.1.3 How to Edit the Alarm Information*.

6.1.1.2 Controller Battery

The Controller battery is automatically configured at the first connection with the EPSON RC+7.0 after upgrading to the firmware version 7.1.0.x and later.



If you are using the Controller before the version upgrade, there may be a difference in the alarm information. In such case, edit the alarm information. For details on the alarm information editing, refer to 6.1.3 *How to Edit the Alarm Information*.

6.1.2 How to View the Alarm Information

The configured alarm information can be checked in the EPSON RC+ 7.0.

- (1) Select the EPSON RC+ 7.0 menu-[Tools]-[Maintenance] to display the [Controller Tools] dialog box.

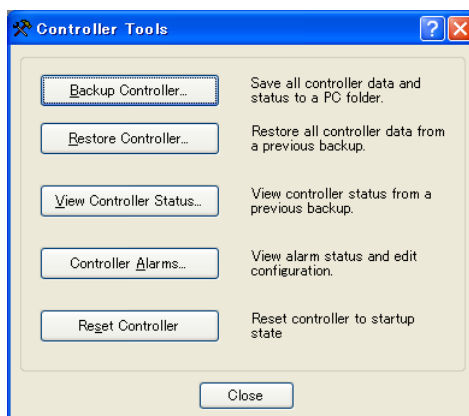

- (2) Click the <Controller Alarms> button and display the [Controller Alarms] dialog box.

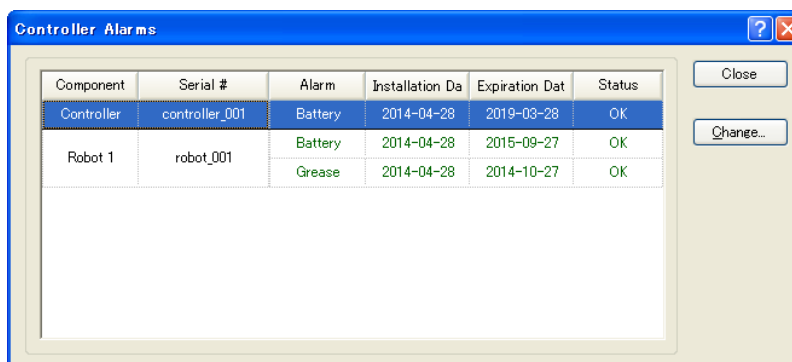

There are three states of the alarm.

Display	Status
OK	An alarm is configured. An alarm is not occurring.
Expired	An alarm is occurring. Replacement is required.
Not set	An alarm is not configured.

6.1.3 How to Edit the Alarm Information

The configured alarm information can be edited in the EPSON RC+ 7.0.

- (1) Select EPSON RC+ 7.0 menu-[Tools]-[Maintenance] to display the [Controller Tools] dialog box.
- (2) Select the alarm to be changed and click the <Change> button.
- (3) Display the [Change Alarm] dialog box and enter any of the followings.
 - Purchase or replacement date of the battery
 - Date of grease up



- (4) Click the <OK> button and change the specified alarm information.

6.1.4 Alarm Notifying Method

The alarm notifying method needs to be configured by the output bit of the Remote I/O.

The Remote I/O can be configured in the EPSON RC+ 7.0- [Setup] - [System Configuration] - [Controller] - [Remote Control].

For details, refer to *the EPSON RC+ 7.0 User's Guide 12.1 Remote I/O*.

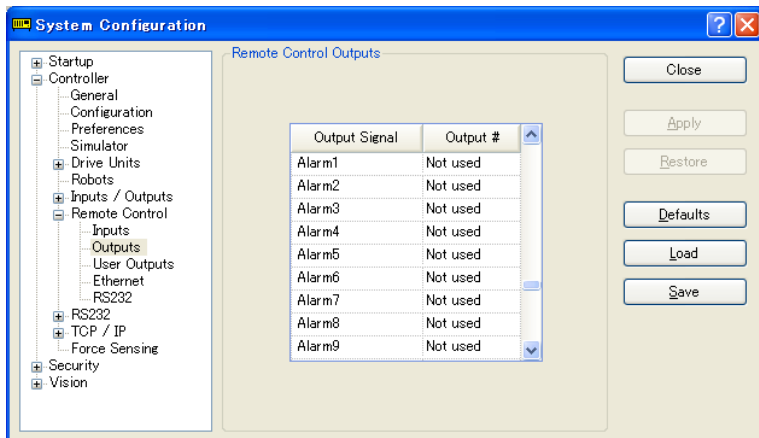

NOTE The Controller does not enter the error or warning state even if an alarm occurs.

6.1.5 How to Cancel the Alarm

An alarm occurs when it reaches the set expiration time.

There are following two methods to cancel the alarm.

- From the [Change Alarm] dialog box
- By the input bit of the Remote I/O



The alarm cannot be canceled by executing the Reset command or restarting the Controller.

6.1.5.1 Alarm Cancellation Dialog

The alarm can be canceled from the EPSON RC+ 7.0.

By referring to 6.1.3 *How to Edit the Alarm*, change the alarm information in the same steps.



6.1.5.2 Remote Input

The alarm can be canceled by the input bit of the Remote I/O.

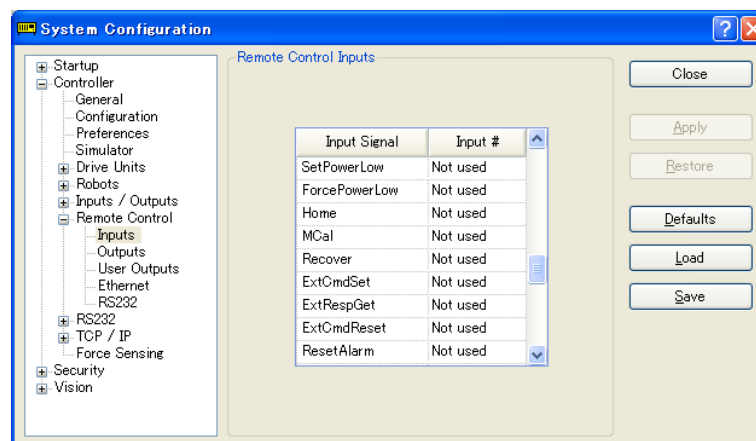

For details, refer to the EPSON RC+ 7.0 *User's Guide 12.1 Remote I/O*.

6.2 Controller Firmware Ver.7.2.0.x or later

6.2.1 Maintenance

The recommended replacement time can be configured for the Controller batteries, robot batteries/grease, timing belts, motors, reduction gear units, and ball screw spline units.

 CAUTION	<ul style="list-style-type: none"> ■ Make sure that the date and time on the Controller are set correctly. The maintenance cannot function properly with improper date and time setting. ■ If the CPU board or CF is replaced, the maintenance information may be lost. When you replaced these parts, confirm the date and time of the Controller and the maintenance information.
--	---



Setting of the maintenance vary depending on installation methods to update from the firmware version 7.1.0.x or earlier to 7.2.0.x or later.

Initial installation : Maintenance is enabled.

Upgrade : Maintenance inherits the previous data.
(Disables as default)

For details for enabling or disabling the maintenance, refer to the *EPSON RC+ 7.0 User's Guide 5.12.2 [System Configuration] Command (Setup Menu) - [Setup]-[System Configuration]-[Controller]-[Preferences] Page.*



Maintenance is enabled at shipment.

6.2.1.1 Robot Maintenance Information

If enabled, the maintenance information for the battery, timing belts, motors, reduction gear units, ball screw spline unit, and grease up will be configured automatically when the robot is configured or changed.

The following parts are subject to grease up:

SCARA (including RS series): Ball screw spline unit on the Joint # 3

When the robot is deleted from the configuration, the maintenance information will also be automatically deleted.

For details on the robot configuration, refer to *the EPSON RC+ 7.0 User's Guide 10.1 Setting the Robot Model.*

 CAUTION	<ul style="list-style-type: none"> ■ Changing of the robot should be done carefully. The alarm setting will be reset when the robot is changed.
--	--



If you are using the Controller with the firmware version before 7.1.0.x, the maintenance information is not configured. In such case, edit the information.

For details on the maintenance information editing, refer to *6.2.3 How to Edit the Maintenance Information.*

NOTE  The robot maintenance information depends on the Controller where the robot is configured to. If the robot is replaced with the other robot with a different serial number, the maintenance information will not function properly. When you replace the robot, edit the maintenance information.

For details on the maintenance information editing, refer to *6.2.3 How to Edit the Maintenance Information*.

6.2.1.2 Controller Maintenance Information

If the maintenance is enabled, the Controller battery is automatically configured at the first connection with the EPSON RC+7.0 after upgrading to the firmware version 7.2.0.x and later.

NOTE  If you are using the Controller before the version upgrade, there may be a difference in the maintenance information. In such case, edit the information. For details on the maintenance information editing, refer to *6.2.3 How to Edit the Maintenance Information*.

6.2.2 How to View the Maintenance Information

The configured maintenance information can be checked in the EPSON RC+ 7.0 Ver.7.2.x or later.

- (1) Select the EPSON RC+ 7.0 menu-[Tools]-[Maintenance] to display the [Controller Tools] dialog box.

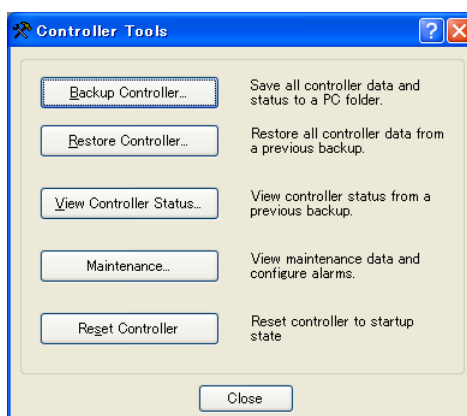

- (2) To check the Controller maintenance information, click the <Maintenance> button and display the [Maintenance] dialog box.

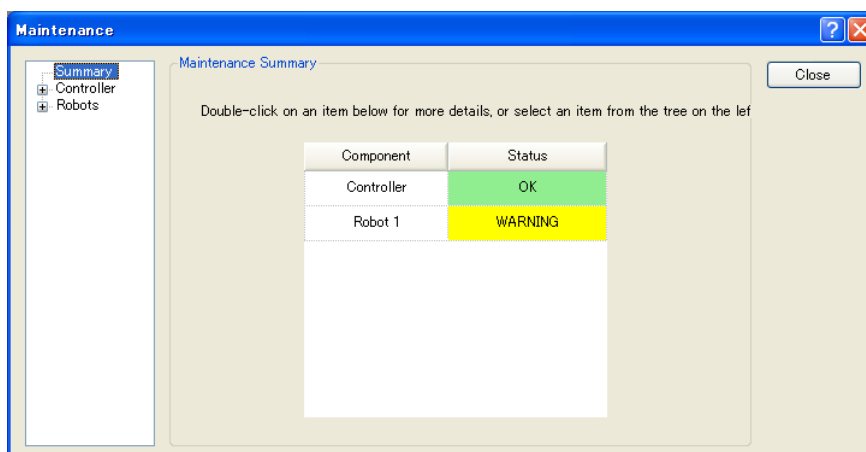

- (3) Select "General" or specify the axis from the tree to display information of the target

parts.

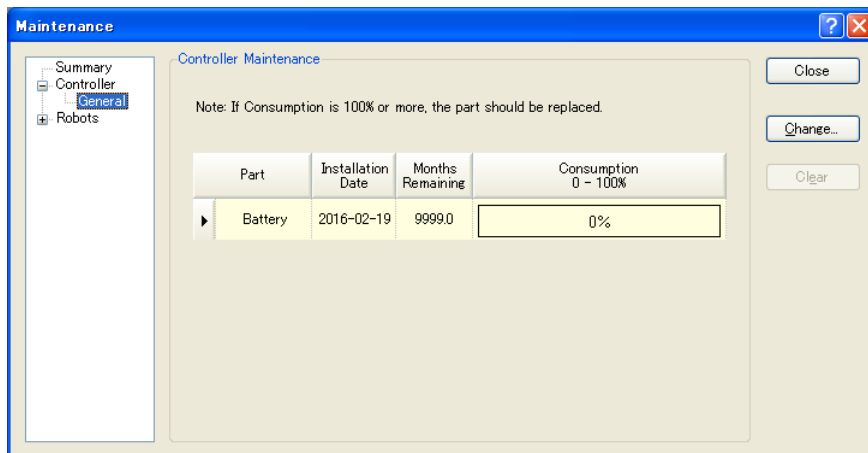

NOTE

The recommended replacement time for the battery is calculated based on the battery capacity and the Controller ON time. The battery may run out if it passes the recommended replacement time.

The recommended replacement time for the grease is calculated based on the elapsed days since date of grease up. The replacement time may be shorter or longer depending on usage condition, such the load applied on the robot.

The recommended replacement time for the parts (timing belts, motors, reduction gear units, and ball screw spline unit) is when it reaches the L10 life (time until 10% failure probability). In the dialog window, the L10 life is displayed as 100%.

Remaining months is calculated based on the past operation conditions.

Enable to set the period for calculation by “HealthCalcPeriod” command. (Default: seven days of the Controller ON time)

Remaining months may not be calculated properly until the period for the calculation passed.

6.2.3 How to Edit the Maintenance Information

The configured maintenance information can be edited in the EPSON RC+ 7.0 Ver.7.2.x or later.

- (1) Select the EPSON RC+ 7.0 menu-[Tools]-[Maintenance] to display the [Controller Tools] dialog box.
- (2) To edit the maintenance information, display the [Maintenance] dialog box.
- (3) Select “General” or specify the axis from the tree to display information of the target parts.
- (4) Select the alarm to be changed and click the <Change> button.
- (5) Display the [Change Alarm] dialog box and enter any of the followings.



Purchase or replacement date of the battery

Date of grease up

Purchase or replacement date of the timing belt

Purchase or replacement date of the motor

Purchase or replacement date of the reduction gear unit

Purchase or replacement date of the ball screw spline unit

- (6) Click the <OK> button and change the specified alarm information.



The offset can be set for the consumption rate of already installed parts.

Follow the steps below to calculate a rough offset setting value.

1. Measure the usable months for the past operation by HealthRBAAnalysis.
2. Confirm the past Motor ON time in the Controller status viewer.
3. Calculate a rough offset value with the following formula.

$$\text{Offset} = 100 \times \frac{\text{Motor On time}}{24 \times 30.4375 \times \text{Usable months}}$$

For details, refer to the following manual.

EPSON RC+ 7.0 SPEL+ Language Reference

6.2.4 Alarm Notifying Method

The Controller status becomes warning and displays warning message if any parts required to perform replacement or grease up.

For details, refer to the following manual.

Status Code / Error Code List

The alarm notifying method can be configured by the output bit of the Remote I/O.

The Remote I/O can be configured in the EPSON RC+ 7.0- [Setup] - [System Configuration] - [Controller] - [Remote Control].

For details, refer to *EPSON RC+ 7.0 User's Guide 12.1 Remote I/O*.

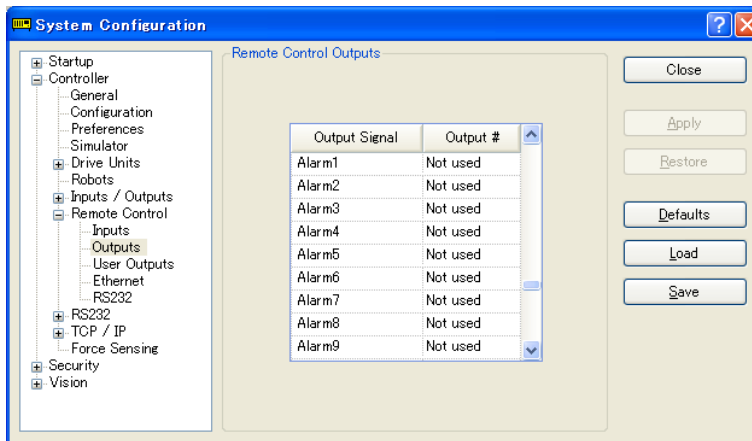

NOTE



The Controller enters the warning state if an alarm occurs.

Set Alarm1 to Alarm 9 in Output bit of remote I/O is checking of warning occurrence in every 5 minutes.

The output timing is different from the alarm occurrence of the controller. It may be output to the remote I / O up to 5 minutes after the alarm is occurred on the controller.

6.2.5 How to Cancel the Alarm

An alarm occurs when the consumption rate of the parts reaches 100%.

NOTE



The alarm cannot be canceled by executing the Reset command or restarting the Controller.

The alarm can be canceled by following methods.

EPSON RC+ 7.0 [Maintenance] dialog box.

HealthCtrlReset Command

HealthRBReset Command

Refer to 6.2.3 *How to Edit the Maintenance Information* to change the alarm information in the same steps.

7. Option Parts Replacement Procedures

7.1 Option Board

RC700

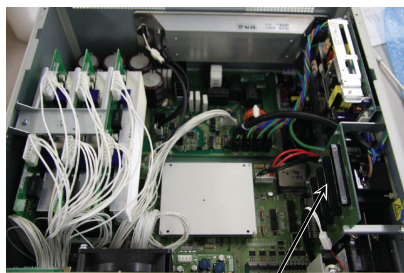

Option Slot

RC700-A

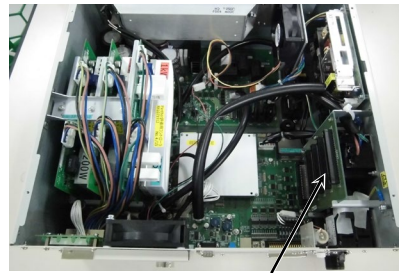

Option Slot

Option Board Addition

- (1) Turn OFF the Controller.
- (2) Disconnect the power plug.
- (3) Remove the Top Panel. (Mounting screw ×6)
- (4) Remove the screws of the Option Slot Panels.
Remove as many Option Panels as the Option Boards to add.



- (5) Mount the L-shaped plate to the Option Board.

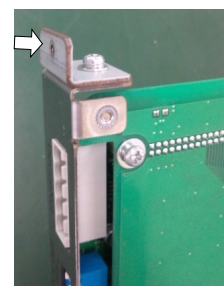

- (6) Install the Option Board as shown in the picture.
Insert the board to the Option Slot.
(in the direction of an arrow)

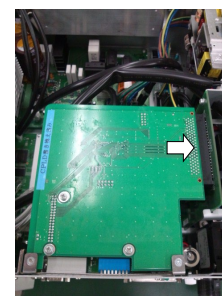

- (7) Mount the attachment L-shaped plate with a screw from the front side.
At this point, one screw for the Option Slot Panel is left unused.



- (8) Mount the Top Panel. (Mounting screws ×6)

- (9) After connecting the power plug, turn ON the Controller and check it works normally without vibration and abnormal sound.

7.2 EUROMAP67 Board

For the detail of the board, refer to the *RC700 Series manual*.

- (1) Turn OFF the Controller.
- (2) Disconnect the power plug.
- (3) Remove the Top Panel. (Mounting screw ×6)
- (4) Insert the EUROMAP67 board into either slots 1, 2 or 3. (Slot 4 cannot be used.)
- (5) Use four screws to fix the EUROMAP67 board in place.

First, temporarily fasten the four screws in place. Next, fully tighten screws located diagonally opposite each other.

Take care not to damage the thread holes when doing so.

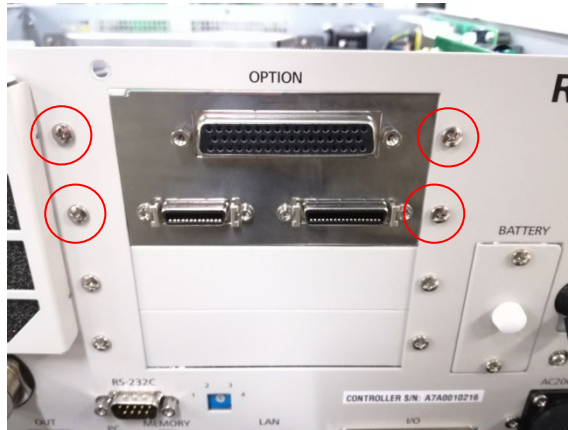

- (6) Connect "Cable1 CN2".
Use a cross-point screwdriver to fasten the connector (CN2).

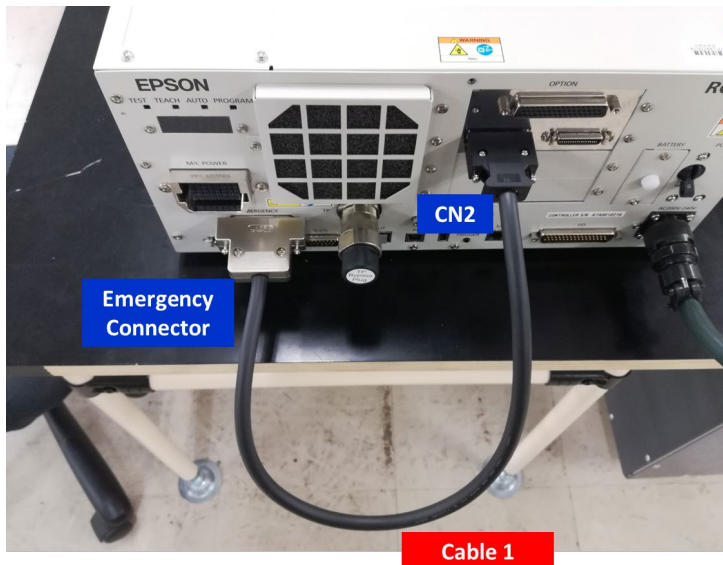

- (7) Refer to the following to connect CN3 to the emergency stop switch (emergency stop,

safety door, latch).

RC700 Series Manual 11. EMERGENCY

- (8) Connect “CN3”.

Use a cross-point screwdriver to fasten the connector (CN3).

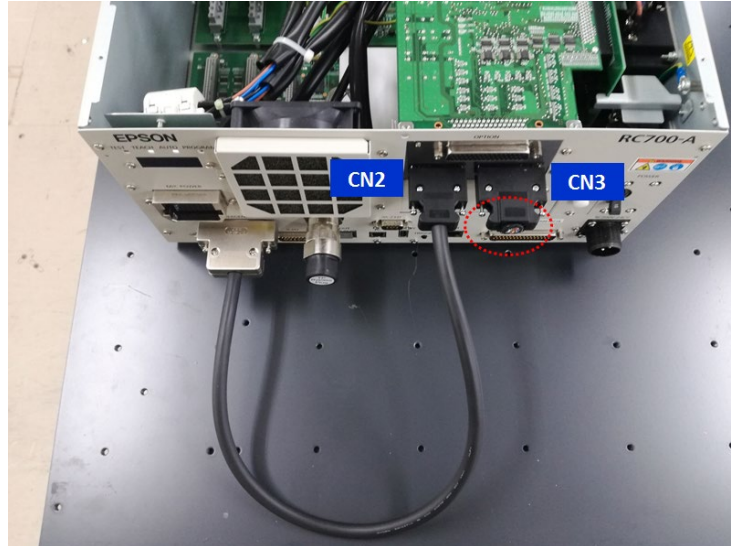

- (9) Connect “Cable2 CN1”.

Use a cross-point screwdriver to fasten the connector (CN1).

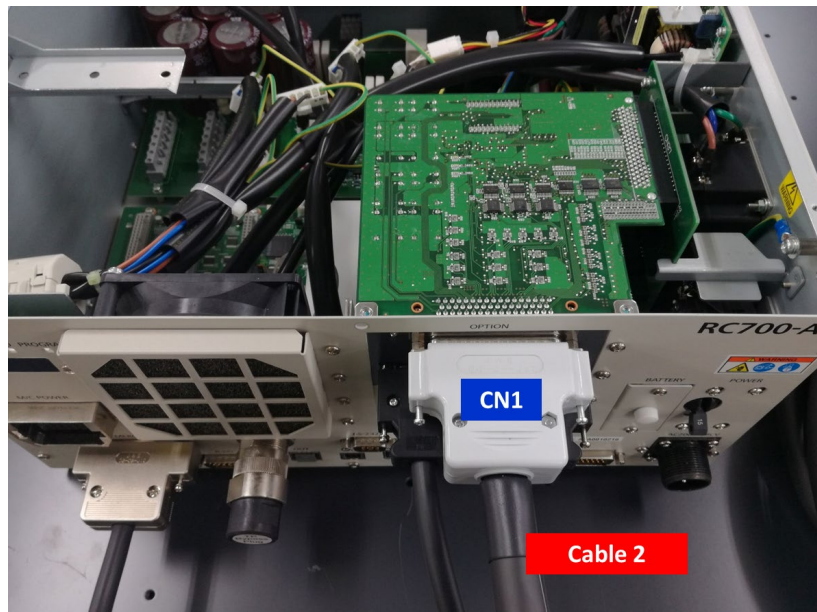

- (10) Mount the Top Panel. (Mounting screw ×6)

- (11) Connect “Cable2 CN4” to the IMM.

- (12) Connect the power plug. Turn ON the Controller and make sure that the Controller starts properly without any vibration or abnormal noise.

7.3 Wall Mounting Option

The Control unit and Drive unit have a wall mounting option. This section describes mounting procedure.

(Figure/Picture: RC700)

Wall mounting with the front side down

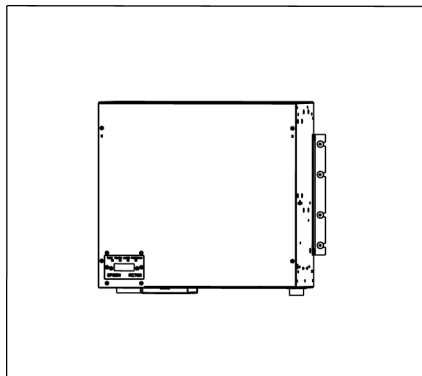

Wall mounting with the front side up

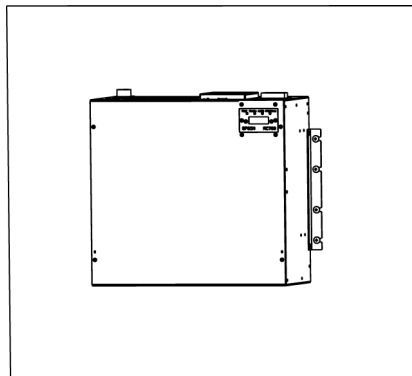

Controller outer dimensions when using the wall mounting option

Dimensions of the mounting holes for the wall

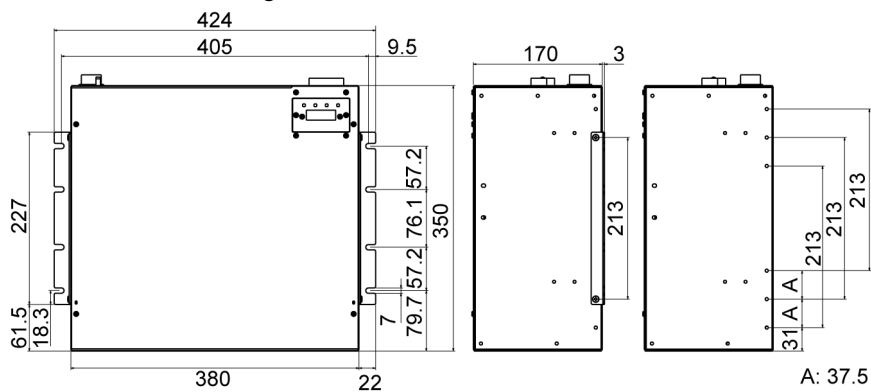

(Unit: mm)

Ensure the air flow around the supply and exhaust ports, and install the Controller while leaving space from other equipment or walls as below.

* Keep the space about 200 mm or more on the top to maintenance.

Wall mounting with the front side down Wall mounting with the front side up

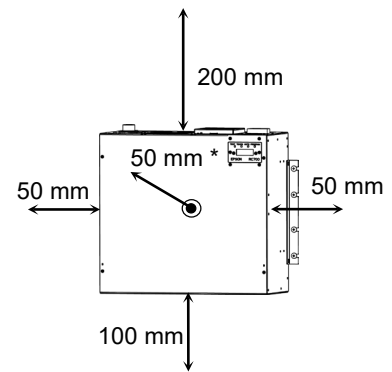
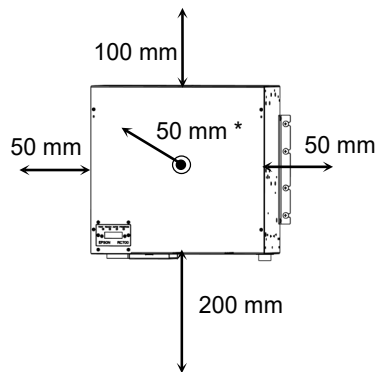

Included items of the wall mounting option

WALL FIXING BRACKET	2 brackets
LED DISPLAY FIXING PLATE	1 plate
LED DISPLAY PLATE	1 plate
Screw (M3 × 6 mm)	4 screws
Screw (M4 × 8 mm)	4 screws



WARNING

- Before installing the Control Unit or Drive Unit with this option, always make sure that the main power of the Controller is turned OFF and that the power plug is disconnected. Performing any installation procedure while the main power is ON or the high voltage charged area is not discharged completely is extremely hazardous and may result in electric shock and/or cause serious safety problems.
- When opening the front side, make sure to disconnect the power plug. Touching the power supply terminal block inside the Control Unit or Drive Unit while the power supply is ON is extremely hazardous and may result in electric shock and/or cause serious safety problems.

NOTE



- Be careful not to damage the cables.
- Be careful not to drop any screws into the Controller.

- (1) Remove the Top Cover Mounting screws of the Controller
(Mounting screw×6)
- (2) Remove the Top Cover.

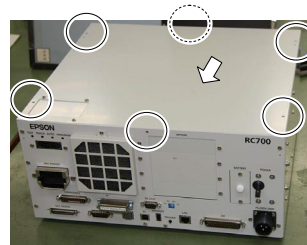

- (3) Remove the screws fixing the seven segment display.
(Controller front side: Mounting screw×2)



- (4) Remove the LED/7 segment board from the Controller.

NOTE



For RC700-A:

The LED/7 segment board has the ferrite code
(Reference: 8.8.2 DMB-LED Board (RC700-A))

If the LED DISPLAY PLATE is installed with “wall mounting with the front side up” described in the step (7) below, the cable which passes the ferrite core will be an opposite direction.

Remove the latch of the ferrite core and change the cable direction, and then install the ferrite core again.

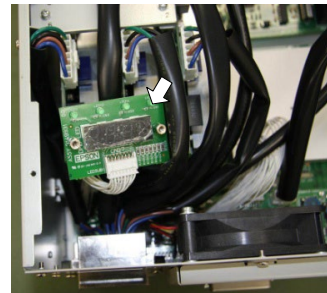

- (5) Mount the LED DISPLAY PLATE to the LED/7 segment board. (Mounting screw×2)

NOTE

When installing the LED DISPLAY PLATE, be careful not to drop any screw inside the Controller.



- (6) Mount the LED DISPLAY FIXING PLATE to the Controller. (Mounting screw×2)

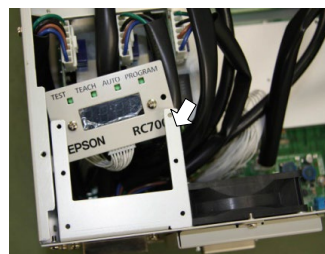

- (7) Mount the LED DISPLAY PLATE to the LED DISPLAY FIXING PLATE. (Mounting screw×2)

There are two installation methods.

Turn the LED DISPLAY PLATE horizontally to the Top Cover in the direction indicated by a red arrow.

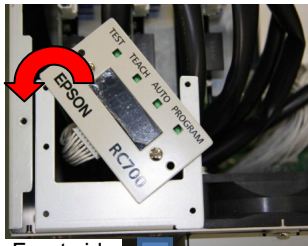
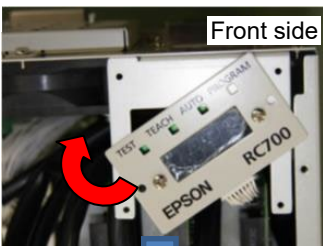
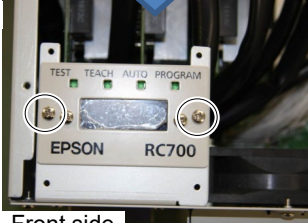
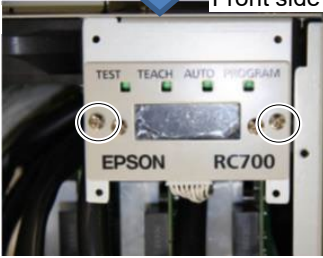
Wall mounting with the front side down	Wall mounting with the front side up
<p>(1) </p> <p>Front side</p>	<p>(1) </p> <p>Front side</p>
<p>(2) </p> <p>Front side</p>	<p>(2) </p> <p>Front side</p>

NOTE

Be careful not to pull the cable.

- (8) Remove the plate from the Top Cover.
(Mounting screw×4)



NOTE

The removed plate is not necessary when using this option.
The plate may be needed when the installation type is changed.
Please keep the plate for future use.

- (9) Mount the Top Cover.
(Mounting screw×6)
- (10) Fix the Top Cover to the LED DISPLAY FIXING PLATE.
(Mounting screw×4)

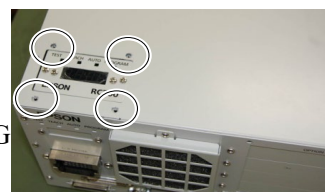

- (11) Mount the WALL FIXING BRACKET.
(Mounting screw×2 on both sides)



NOTE

The bracket has 6 screw holes.
There are three ways of installation.



- (12) Remove the rubber foot on the Controller's back side.
(Mounting screw×4)



NOTE

The removed rubber foot is not necessary when using this option.
The rubber foot may be needed when the installation type is changed.
Please keep the rubber foot for future use.

- (13) Mount the Controller to the wall. (Mounting screw×8 M5 × 8 mm or longer)
Tightening torque 80 to 110 N·cm

8. Maintenance Parts Replacement Procedures

 <p>WARNING</p>	<ul style="list-style-type: none"> ■ Before performing any maintenance procedure, always make sure that the main power of the Controller is turned OFF and that the high voltage charged area is completely discharged. Performing any maintenance procedure while the main power is ON or the high voltage charged area is not discharged completely is extremely hazardous and may result in electric shock and/or cause serious safety problems. ■ When opening or closing the front side, make sure that the 200 V power supply for the Controller is OFF. Performing procedure to the power supply terminal block inside the Controller while the power supply is ON is extremely hazardous and may result in electric shock and/or cause serious safety problems.
--	---

NOTE



- Be careful not to damage cables. Be sure not to drop any screws into the Controller.
- Installing the front cover using the wrong screws may result in a cable being damaged and/or malfunction of the Controller.
- Dispose maintenance parts that are no longer needed in accordance with all national and local codes.

8.1 Fan Filter

Inspect the fan filter periodically and clean it when needed. The temperature inside the Controller may get too high and the Controller may not operate properly if the filter is not kept clean.

Fan Filter Removal

- (1) Turn OFF the Controller.
- (2) Remove one screw of the fan filter.



RC700DU, RC700DU-A

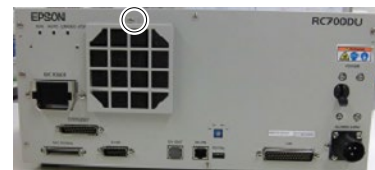

- (3) Remove the fan filter cover.
- (4) Detach the fan filter.

Clean the fan filter as needed.

Fan Filter Installation

- (1) Set the fan filter to the fan filter cover.
- (2) Mount the fan filter cover with the screw.
- (3) Connect the power plug. Turn ON the Controller and make sure that the Controller starts properly without any vibration or abnormal noise.

8.2 Fan

8.2.1 Front Fan

Front Fan Removal

- (1) Turn OFF the Controller.
- (2) Disconnect the power plug.
- (3) Remove the Top Cover. (Mounting screw ×6)

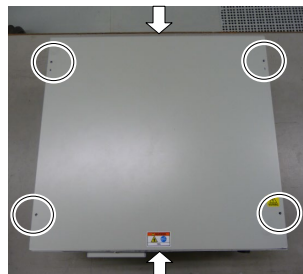

- (4) Remove the fan cable from the DMB-SUB.
Connector: CN22



- (5) Remove the screws of the fan (×2).
- (6) Remove the fan.



Front Fan Installation

- (1) Mount a new fan with two screws.
At this point, tighten the screws diagonally. Be careful of the mounting direction.
- (2) Connect the fan cables to the DMB-SUB.
Connector: CN22
- (3) Mount the Top Panel. (Mounting screw ×6)
- (4) Connect the power plug. Turn ON the Controller and make sure that the Controller starts properly without any vibration or abnormal noise.

* Pay attention to the right and wrong sides of the fan when installing it.

8.2.2 Fan 2 (RC700-A, RC700DU-A)

The fan 2 is installed only in RC700-A and RC700DU-A.

Fan 2
removal
(RC700-A,
RC700DU-A)

- (1) Turn OFF the Controller.
- (2) Disconnect the power plug.
- (3) Remove the Top Cover. (Mounting screw ×6)

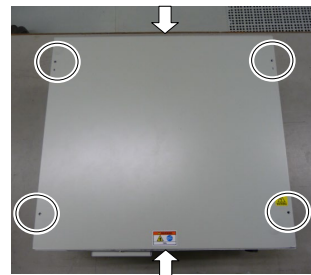

- (4) Remove the cable tie binding the 15 V power supply cable and fan cable.
- (5) Remove the fan extension connector.



- (6) Remove the regenerative module connector from the DMB.
- (7) Remove the regenerative module connector from the DPB.

- (8) Remove the rear plate from the body.
(Mounting screw ×5)



- (9) Remove the regenerative resistance from the rear plate.
(Mounting screw ×4)

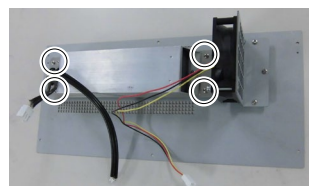

- (10) Remove the fan from the fan fixing plate.
(Mounting screw ×2)

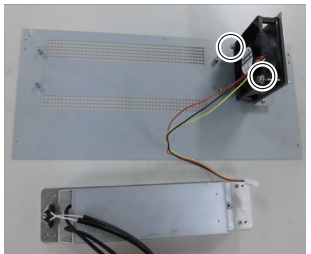

Fan 2
Installation
(RC700-A,
RC700DU-A)

- (1) Fix the new fan to the fan fixing plate. (Mounting screw ×2)
At this point, tighten the screws diagonally. Be careful of the mounting direction.
- (2) Mount the regenerative resistance to the rear plate. (Mounting screw ×2)
Be careful of the mounting direction.
- (3) Mount the rear plate to the body. (Mounting screw ×5)
- (4) Connect the regenerative module connector to the DMB.
- (5) Connect the regenerative module connector to the DPB.
- (6) Connect the fan extension connector.
- (7) Bind the 15 V power supply cable and fan cable. by the cable tie (AB150).
Leave 110 mm from the end of the cable tie in order not to tighten the cables too much.
Cut the excess part of the tie.
- (8) Mount the Top Panel. (Mounting screw ×6)
- (9) Connect the power plug. Turn ON the Controller and make sure that the Controller starts properly without any vibration or abnormal noise.

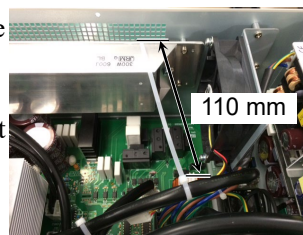

* Pay attention to the right and wrong sides of the fan when installing it.



8.3 Battery

 CAUTION	<ul style="list-style-type: none"> ■ Use meticulous care when handling the lithium battery. Improper handling of the lithium battery as mentioned below is extremely hazardous, may result in heat generation, leakage, explosion, or inflammation, and may cause serious safety problems. <ul style="list-style-type: none"> • Battery Charge • Disassembly • Incorrect Installation • Exposing to Fire • Forced Discharge • Deformation by Pressure • Short-circuit (Polarity; Positive/Negative) • Heating (85°C or more) • Soldering the terminal of the lithium battery directly ■ Be sure to use the battery supplied as maintenance part from EPSON (Refer to 11. Maintenance Parts List). ■ When disposing of the battery, consult with the professional disposal services or comply with the local regulation. Spent battery or not, make sure the battery terminal is insulated. If the terminal contacts with the other metals, it may short and result in heat generation, leakage, explosion, or inflammation.
---	--

NOTE



Turn ON the Controller for approximately one minute before replacing the battery.

Finish the replacement within 10 minutes to prevent data loss.

Battery Removal

- (1) Backup the Controller data.
Refer to 4. *Backup and Restore*.
- (2) Turn OFF the Controller.
- (3) Disconnect the power plug.
- (4) Remove the battery bracket. (Mounting screw ×2)



- (5) Pull out the battery bracket.
- (6) Disconnect the battery cable.
- (7) Remove the battery straight upward.



Battery

- (1) Set a new battery.

Installation

NOTE



Secure the battery with the mounting tab.

- (2) Connect the battery cables.
- (3) Insert the battery bracket and secure it with the screws. (Mounting screw ×2)
- (4) Connect the power plug. Turn ON the Controller and make sure that the Controller starts properly without any vibration or abnormal noise.

8.4 CF (Compact Flash)

- CF Removal**
- (1) Turn OFF the Controller.
 - (2) Disconnect the power plug.
 - (3) Remove the Top Panel. (Mounting screw ×6)
 - (4) Remove the connector (CN39).
 - (5) Remove the CF mounting screw and the rubber.
 - (6) Pull the CF toward the direction of the arrow in the picture.

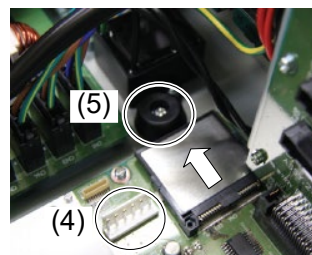
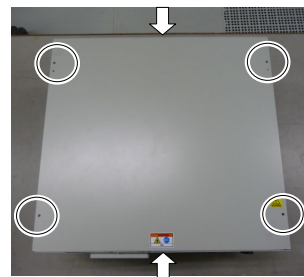

- CF Installation**
- (1) Insert a new CF toward the opposite direction of the arrow in the picture above.
 - (2) Tighten the CF mounting screw (×1) and the rubber.
 - (3) Connect the connector (CN39).
 - (4) Mount the Top Panel. (Mounting screw ×6)
 - (5) Connect the power plug. Turn ON the Controller and make sure that the Controller starts properly without any vibration or abnormal noise.

8.5 MDB

MDB identification method There are types of the MDB and it can be identified by “Assy. No.” or “MDB type” printed on the board.

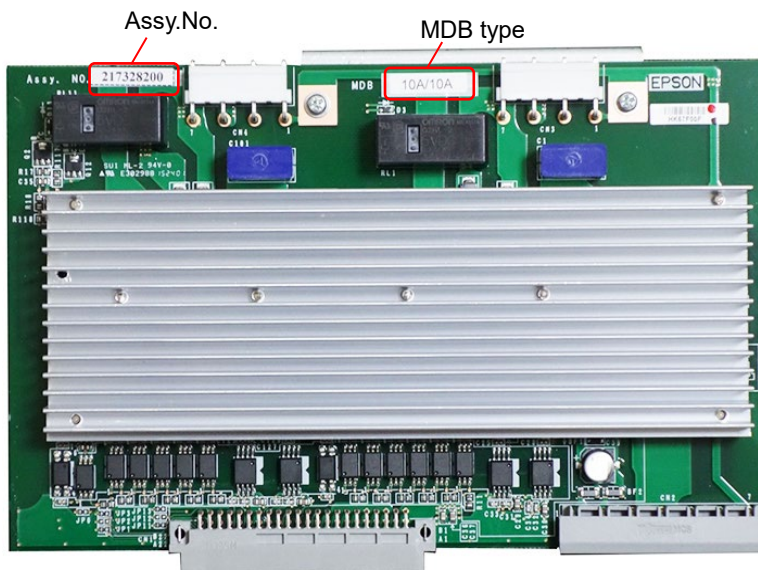

Control Unit Drive Unit	Manipulator	Joint #1, #2	Joint #3, #4	Joint #5, #6	Remarks	
RC700 RC700DU	C4	15A/15A	10A/10A		MDB type	
		2149935** 2171247**	2145517** 2157372** 2172039**		Assy. No.	
RC700-A RC700DU-A	C4	15A/15A-2	10A/10A		MDB type	
		2166640** 2171936** 2172974** 2175538** 2194708** 2168582** 2194709**	2145517** 2157372** 2172973** 2175537** 2195535** 2172039** 2195537**		Assy. No.	
		50A/30A	15A/15A-2	10A/10A	MDB type	
		2169285** 2205667** 2205668**	2166640** 2171936** 2194708** 2194709**	2145517** 2157372** 2195535** 2195537**	Assy. No.	
		* No support for Drive Unit				

Control Unit Drive Unit	Manipulator	Joint #1, #5	Joint #3, #4	Joint #2, #6	Remarks
RC700-A RC700DU-A	N2 *	5A/5A			MDB type
		2175610** 2176557**			Assy. No.
	N6	30A/5A	15A/5A	30A/5A	MDB type
		2186906** 2188814**	2186907** 2188815**	2186906** 2188814**	Assy. No.
* No support for Drive Unit					

Control Unit Drive Unit	Manipulator	Joint #1, #2	Joint #3, #4	Remarks
RC700-A RC700DU-A	G1 G3	10A/10A		MDB type
		2145517** 2157372** 2172039**		Assy. No.
	G6 RS	15A/15A-2	10A/10A	MDB type
		2166640** 2171936** 2168582**	2145517** 2157372** 2172039**	Assy. No.
	G10 G20	30A/30A	15A/15A-2	MDB type
		2146123** 2153723** 2171456**	2166640** 2171936** 2168582**	Assy. No.

MDB Removal

- (1) Turn OFF the Controller.
- (2) Disconnect the power plug.
- (3) Remove the Top Panel. (Mounting screw ×6)

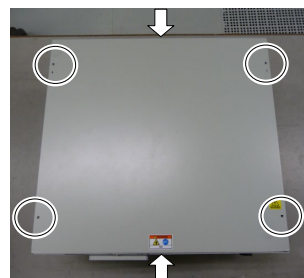

- (4) Remove the output cables of each axis of the MDB.

NOTE

Before removing the cables, check positions of the boards and the cables. Install them to the same positions after the replacement.

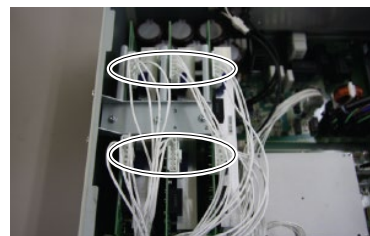

- (5) Remove the MDB clamp 1. (Mounting screw ×5)

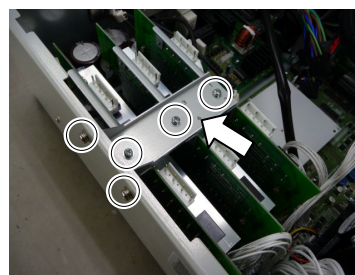

- (6) Remove the MDB clamp 2. (Mounting screw ×2)



- (7) Pull out the MDBs in the direction shown in the picture.

NOTE

When removing the MDBs, make sure to remember the position of each board. Install the boards to the same positions after replacement.



- (8) Remove the MDB clamp 3. (Mounting screw ×2)



MDB Installation

- (1) Install the MDB clamp 3. (Mounting screw ×2)



- (2) Insert the MDBs in the direction shown in the picture.

NOTE

Be careful not to misplace the boards.

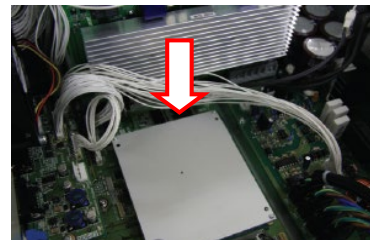

- (3) Install the MDB clamp 2. (Mounting screw ×2)

Set the MDB clamp so that the grooves fit to MDBs.



- (4) Mount the MDB clamp 1. (Mounting screw ×5)

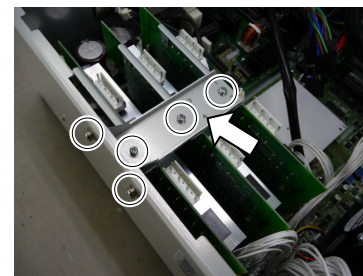

- (5) Mount the output cable of each axis of the MDBs.

NOTE

When mounting the output cables, make sure that the numbers on the MDB clamp 1 and on the connectors are the same.



- (6) Mount the Top Panel. (Mounting screw ×6)

- (7) Connect the power plug. Turn ON the Controller and make sure that the Controller starts properly without any vibration or abnormal noise.

8.6 DMB

8.6.1 DMB for Control Unit

DMB Removal

- (1) Turn OFF the Control Unit.
- (2) Disconnect the power plug.
- (3) Remove the Top Panel. (Mounting screw ×6)

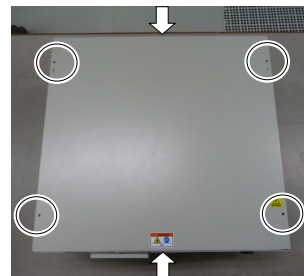

- (4) Remove the cables connected to the following connectors.

M/C Signal Connector	EMERGENCY Connector
TP Connector	USB Connector
USB Memory	Ethernet Connector
I/O Connector	RS-232C Connector
R-I/O Connector	DU OUT Connector

- (5) Remove the MDBs.
Refer to 8.5 MDB.

- (6) Remove the DMB-OPTION board.
(Mounting screw ×3)

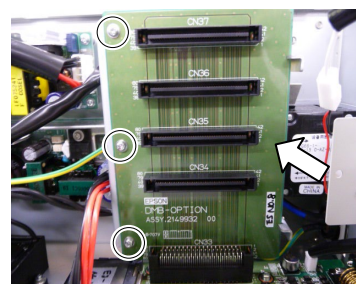

- (7) Remove five screws on the side of the chassis.



- (8) Remove the fixing plate of the DMB-OPTION board.

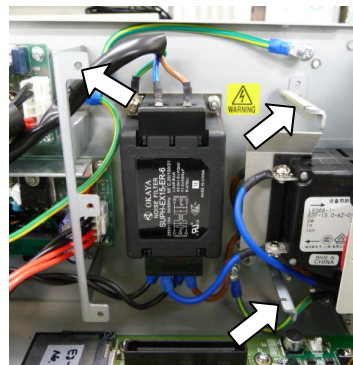

(9) RC700: Remove the five connectors from the DMB.

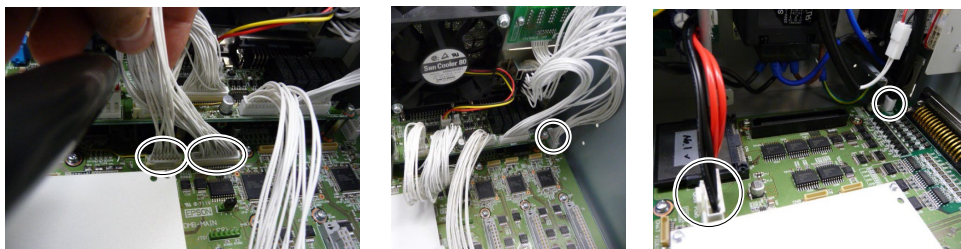

RC700-A: Remove the twelve connectors from the DMB.

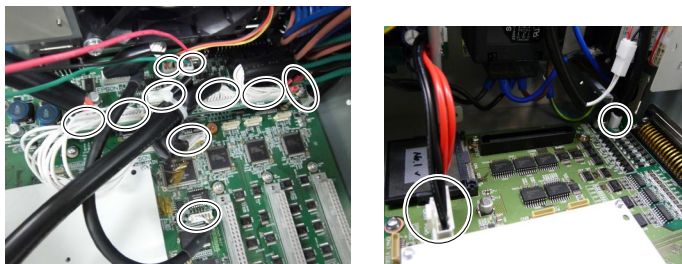

(10) Remove the DMB mounting screws (×14).

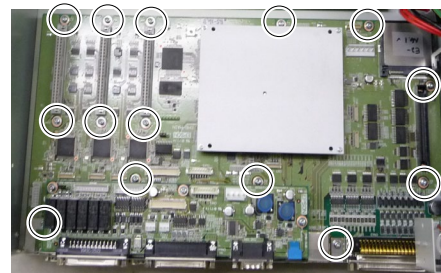

(11) Remove the fan.
Refer to 8.2 Fan.

(12) Remove the DMB from the chassis.

At this point, be careful not to touch the chassis and other parts.

(13) Remove the plate fixing the connectors on the front side from the DMB and the DMB-SUB boards.

RC700



RC700-A



(14) Remove the DMB-SUB board from the DMB.
(Mounting screw ×3)

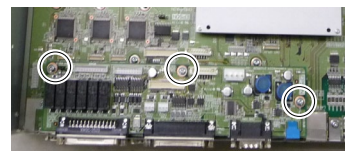

DMB
Installation

- (1) Install the DMB-SUB board to the new DMB. (Mounting screw ×3)
- (2) Install the plate that secures the connectors on the front side to the DMB and the DMB-SUB boards.
- (3) Insert the DMB into the chassis.
At this point, be careful not to touch the chassis and other parts.

- (4) Mount the fan.
Refer to 8.2 Fan.

- (5) Tighten the DMB mounting screw (×14).

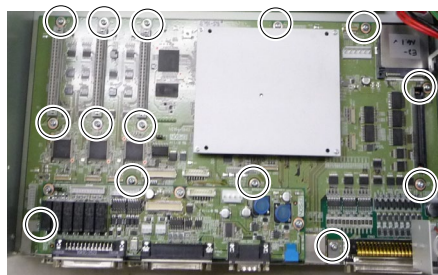

- (6) RC700: Connect the five connectors to the DMB.

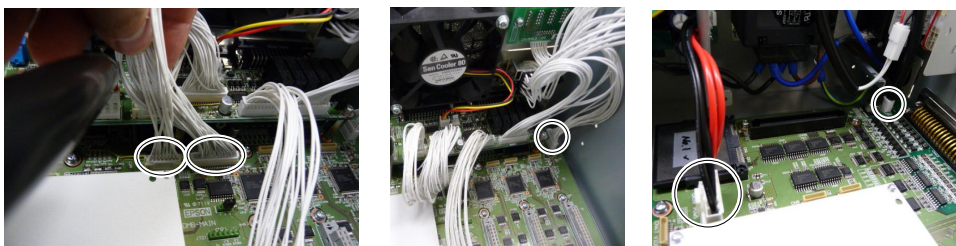

RC700-A: Connect the twelve connectors to the DMB.

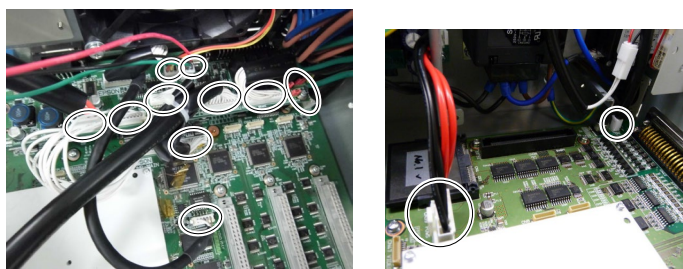

- (7) Mount the fixing plate of the DMB-OPTION board.

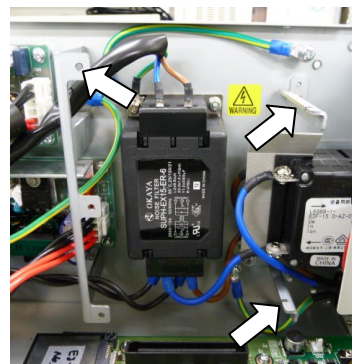

(8) Mount the five screws on the side of the chassis.



(9) Mount the DMB-OPTION board.
(Mounting screw ×3)

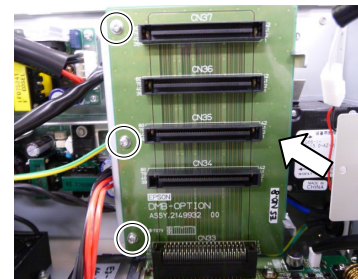

(10) Mount the MDB.

Refer to 8.5 *MDB*.

(11) Install the cables to the following connectors.

M/C Signal Connector	EMERGENCY Connector
TP Connector	USB Connector
USB Memory	Ethernet Connector
I/O Connector	RS-232C Connector
R-I/O Connector	DU OUT Connector

(12) Mount the Top Panel. (Mounting screw ×6)

(13) Connect the power plug. Turn ON the Control Unit and make sure that the Controller starts properly without any vibration or abnormal noise.

8.6.2 DMB for Drive Unit

DMB Removal

- (1) Turn OFF the Drive Unit.
- (2) Remove the power plug.
- (3) Remove the Top Panel. (Mounting screw ×6)

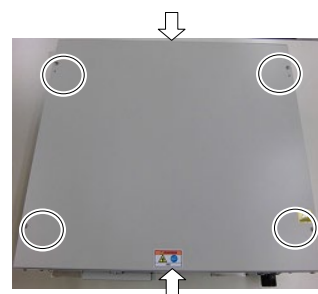

- (4) Remove the cables connected to the following connectors.

M/C Signal Connector	EMERGENCY Connector
R-I/O Connector	DU OUT Connector
DU IN Connector	I/O Connector

- (5) Remove the MDBs.
Refer to 8.5 MDB.

- (6) Remove the five connectors from the DMB.

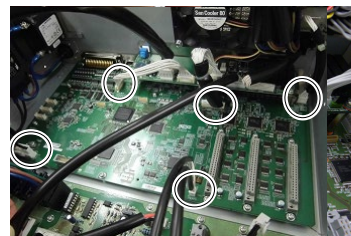

- (7) Remove the DMB mounting screws (×15).

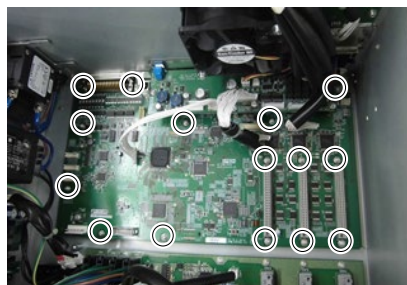

- (8) Remove the fan.
Refer to 8.2 Fan.

- (9) Remove the DMB from the chassis.

At this point, be careful not to touch the chassis and other parts.

- (10) Remove the plate fixing the connectors on the front side from the DMB and the DMB-SUB boards.

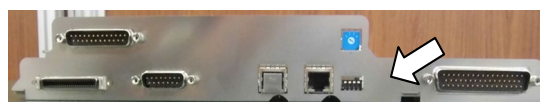

- (11) Remove the DMB-SUB board from the DMB.
(Mounting screw × 3)



DMB
Installation

- (1) Install the DMB-SUB board to the new DMB. (Mounting screw × 3)
- (2) Install the plate that secures the connectors on the front side to the DMB and the DMB-SUB boards.
- (3) Insert the DMB into the chassis.

At this point, be careful not to touch the chassis and other parts.

- (4) Mount the fan.
Refer to 8.2 *Fan*.
- (5) Tighten the DMB mounting screw (×15).

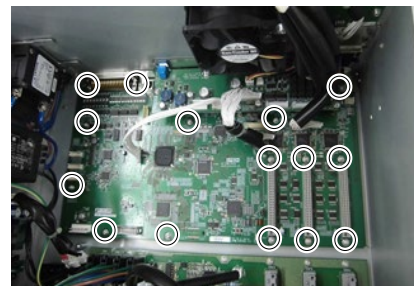

- (6) Mount the five connectors to the DMB.

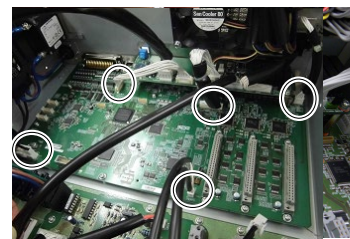

- (7) Mount the MDB.
Refer to 8.5 *MDB*.
- (8) Install the cables to the following connectors.

M/C Signal Connector	EMERGENCY Connector
R-I/O Connector	DU OUT Connector
DU IN Connector	I/O Connector

- (9) Mount the Top Panel. (Mounting screw ×6)
- (10) Plug in the power plug. Turn ON the Drive Unit and make sure that the Drive Unit starts properly without any vibration or abnormal noise.

8.7 DMB-SUB Board

DMB-Sub Board
Removal

- (1) Turn OFF the Controller.
- (2) Disconnect the power plug.
- (3) Remove the Top Panel. (Mounting screw ×6)

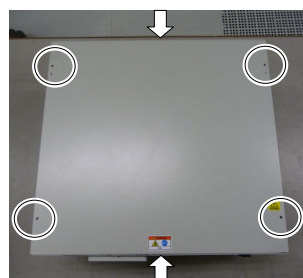

- (4) Remove the cables from the DMB-SUB board.

RC700

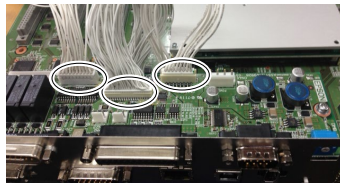

RC700-A

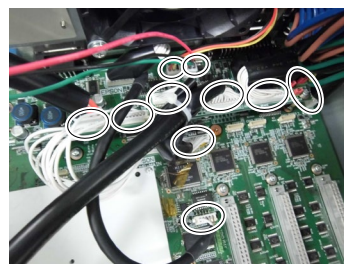

RC700DU
RC700-DU-A



- (5) Remove the screws fixing the DMB-SUB board to the front side plate.

RC700



RC700-A



RC700DU
RC700-DU-A



- (6) Remove the DMB-SUB Board from the DMB.
(Mounting screws ×3)

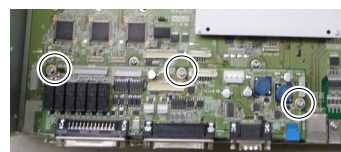

- DMB-Sub Board Installation
- (1) Mount the plate that secures the connectors on the front side to the DMB-SUB board.
 - (2) Mount the DMB-SUB Board to the DMB. (Mounting screws ×3)
 - (3) Connect the cables to the DMB-SUB Board.
 - (4) Mount the Top Panel. (Mounting screw ×6)
 - (5) Set the Encoder Voltage Adjustment Switch.

Set the Encoder Voltage Adjustment Switch according to the length of the M/C cable.

Switch	Length of M/C Cable
1	3 m
2	5 m
3	10 m
4	15, 20 m

- (6) Connect the power plug. Turn ON the Controller and make sure that the Controller starts properly without any vibration or abnormal noise.

8.8 DMB-LED Board

7.8.1 DMB-LED Board (RC700, RC700DU)

DMB-LED Board
Removal
(RC700,
RC700DU)

- (1) Turn OFF the Controller.
- (2) Disconnect the power plug.
- (3) Remove the Top Panel. (Mounting screw ×6)

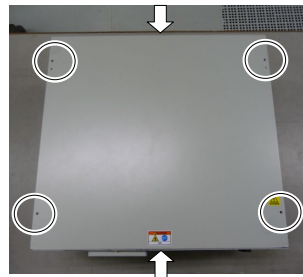

- (4) Disconnect the cables connected to the DMB-LED board.
- (5) Remove the DMB-LED board. (Mounting screw ×2)

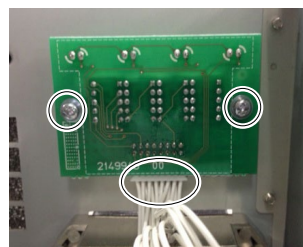

DMB-LED Board
Installation
(RC700,
RC700DU)

- (1) Mount the DMB-LED board. (Mounting screw ×2)
- (2) Connect the cables to the DMB-LED board.
- (3) Mount the Top Panel. (Mounting screw ×6)
- (4) After connecting the power plug, turn ON the Controller and check it works normally without vibration and abnormal sound.

7.8.2 DMB-LED Board (RC700-A, RC700DU-A)

DMB-LED Board Removal
(RC700-A,
RC700DU-A)

- (1) Turn OFF the Controller.
- (2) Disconnect the power plug.
- (3) Remove the Top Panel. (Mounting screw ×6)
- (4) Remove the DMB-LED board from the front panel. (Mounting screw ×2)
- (5) Remove the ferrite core from the Support plate. (Mounting screw ×1)
- (6) Disconnect the cables connected to the DMB-LED board.
- (7) Remove the DMB-LED board from the support plate. (Nut ×2)
- (8) Remove the stud bolt from the DMB-LED board. (Stud bolt ×4)

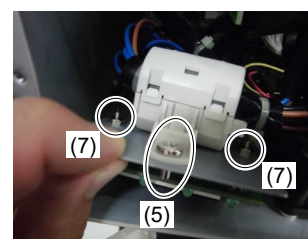
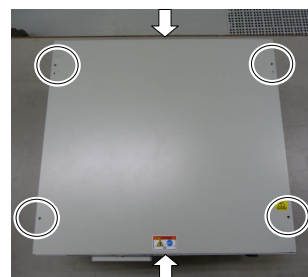

DMB-LED Board Installation
(RC700-A,
RC700DU-A)

- (1) Mount the stud bolt to the DMB-LED board. (Stud bolt ×4)
- (2) Mount the DMB-LED board to the support plate. (Nut ×2)
- (3) Connect the cable to the DMB-LED board.
- (4) Mount the ferrite core to the support plate. (Mounting screw ×1)
- (5) Mount the DMB-LED board to the front panel. (Mounting screw ×4)
- (6) Mount the Top Panel. (Mounting screw ×6)
- (7) After connecting the power plug, turn ON the Controller and check it works normally without vibration and abnormal sound.

8.9 DPB

DPB
Removal

- (1) Turn OFF the Controller.
- (2) Disconnect the power plug.
- (3) Remove the Top Panel. (Mounting screw ×6)
- (4) Remove the MDB.
Refer to 8.5 MDB

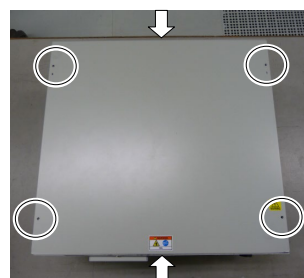

- (5) Remove the MDB clamp 3.
(Mounting screw ×2)

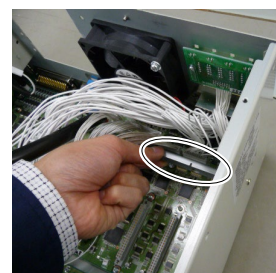

- (6) Remove eight connectors from the DPB.

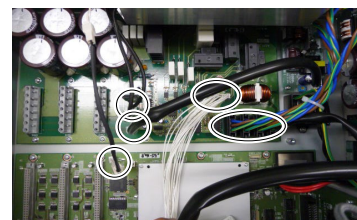

- (7) RC700-A, RC700DU-A
Remove the fan 2 extension connector.

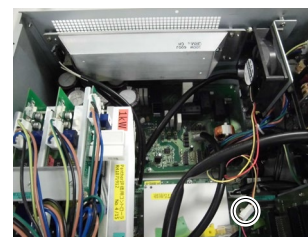

- (8) RC700-A, RC700DU-A
Remove the rear plate from the body.
(Mounting screw ×5)



- (9) Remove the DPB mounting screws.
(Mounting screw ×12)

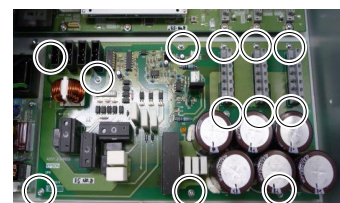

- (10) Remove the DPB from the chassis.

DPB
Installation

- (1) Insert the DPB to the chassis.
- (2) Fix the DPB with screws. (Mounting screw ×12)
- (3) RC700-A, RC700DU-A: Mount the rear plate. (Mounting screw ×5)
- (4) RC700-A, RC700DU-A: Connect the fan 2 extension connector.
- (5) Connect the eight connectors to the DPB.
- (6) Mount the MDB clamp 3. (Mounting screw ×2)
- (7) Mount the DMB.
Refer to 8.6 DMB
- (8) Mount the top plate. (Mounting screw ×6)
- (9) After connecting the power plug, turn ON the Controller and check it works normally without vibration and abnormal sound.

9. Verifying Robot System Operation

This section describes procedure to check proper operation of robot system after maintenance has been performed for either the Manipulator or the Controller.



Check the LED status of Control Unit by referring the procedure below.

- (1) Connect all the necessary cables for the system.

 WARNING	<ul style="list-style-type: none"> ■ When verifying the robot system operation, prepare for failures with initial settings or wiring. If the Manipulator operates abnormally because of incorrect initial settings or wiring, press the Emergency Stop switch immediately to stop the Manipulator. <p>Verify the robot system operation in the restricted mode (low speeds and low power) status. Verifying the robot system operation at high speeds may damage the robot system and/or cause serious safety problems as the Manipulator cannot stop operating immediately in case of abnormal operation of the Manipulator.</p>
--	--

 CAUTION	<ul style="list-style-type: none"> ■ The serial number of the Manipulator that should be connected is indicated on the Connection Check Label on the Controller. Connect the Controller and the Manipulator correctly. Improper connection between the Controller and the Manipulator may cause not only improper function of the robot system but also serious safety problems.
--	---

- (2) Check the LED status during the time from the Controller is turned ON until the Controller boots up by referring to the list below.

		From power-on to boot	While running	
LED	All blink	LED for current operation mode (TEST, TEACH, AUTO, PROGRAM) turns ON.		
7 segment	All lights out			READY (Normal)
				Emergency Stop
				Safeguard
		Four digits		Error

For details of the display, refer to *RC700 Series Manual Functions 2.1.1 LED and Seven-segment LED Display*.

For error numbers, refer to *Status Code / Error Code List Manual*.

- (3) Execute MOTOR ON and check the following:
 - No error is displayed.
 - There is servo excitation and the Manipulator operates normally.
- (4) Execute various motion commands (such as JUMP, etc.). The Manipulator must operate accordingly and normally without vibration or unusual sounds.

10. Troubleshooting

10.1 Error Code Table

For Error Code, refer to the following manual.
Status Code / Error Code List Manual

10.2 Cannot Connect the Development PC and the Controller using the USB cable



CAUTION

- Do not connect the USB cable to a PC or a Controller without installing Program Development Software EPSON RC+ 7.0 to the PC.
 You must install EPSON RC+ 7.0 to control the Controller.
 If the USB cable is connected to a PC or a Controller without installing Program Development Software EPSON RC+ 7.0, the [Add New Hardware] wizard appears. Click the <Cancel> button to close the [Add New Hardware] wizard.

- If the following error message appears when connecting the development PC and Controller with the USB cable and connecting the Controller to EPSON RC+ 7.0, Windows may not recognize the Controller properly. Refer to *10.2.1 Confirmation Using Windows Device Manager* to check the connection of the Controller.

“Cannot connect to controller
 !! Error: 1805, Connection Failure. Check the controller startup and connection of the communication cable.”

10.2.1 Confirmation Using Windows Device Manager

(1) Make sure that the development PC and the Controller is connected to the USB cable.

NOTE
☞

When checking the Controller connection using the Windows device manager, the development PC and the Controller must be connected with the USB cable.

(2) Open Control Panel and click [Hardware and Sound].

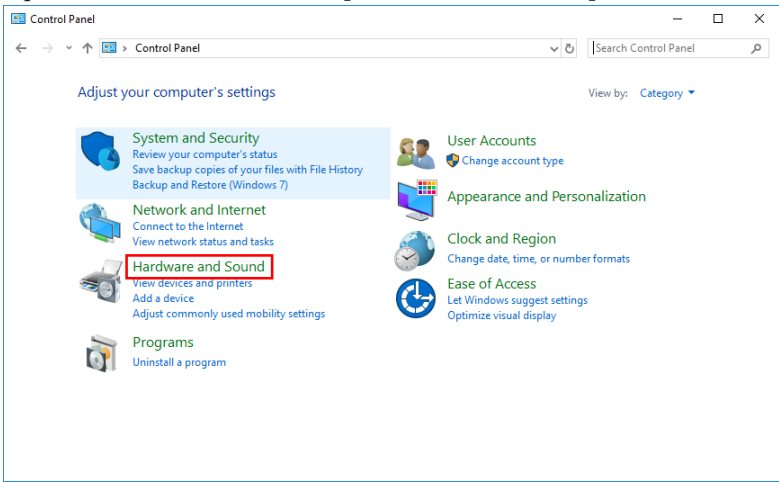

(3) The [Hardware and Sound] dialog appears.
Click <Device Manager>.

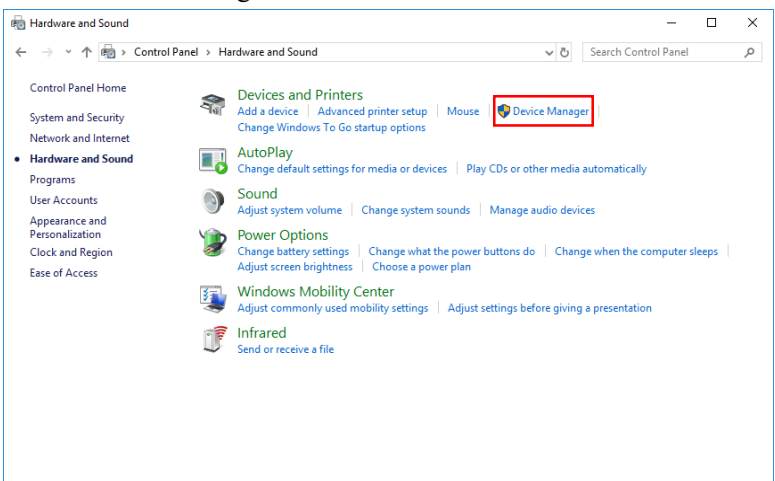

(4) The [Device Manager] dialog appears.

Click <Universal Serial Bus controllers> and make sure that “EPSON Robot Controller” is registered.

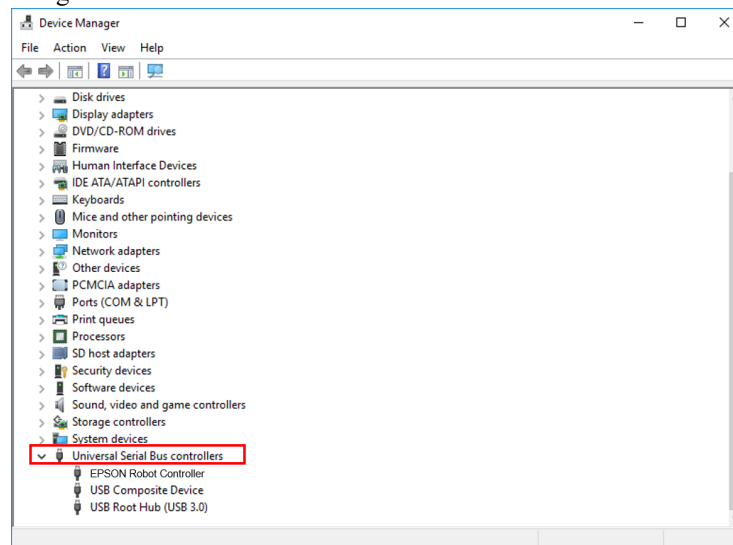

When “EPSON Robot Controller” is registered and located under “Universal Serial Bus controllers” as shown above, the development PC and the Controller connect properly.

If the following error message appears, please contact the supplier of your region.

“Cannot connect to controller.

!! Error: 1805, Connection failure, check the controller startup and connection of the communication cable.”

If “EPSON Robot Controller” is not located under “Universal Serial Bus controllers” but located under “Other devices” in step (4), refer to *10.2.2 When recognized under “Other devices” in Windows Device Manager.*

10.2.2 When recognized under “Other devices” in Windows Device Manager

If “EPSON Robot Controller” is recognized under “Other devices” in the Windows device manager as shown in the following dialog, delete “EPSON Robot Controller” from the device manager and connect the USB cable again to correct the problem.

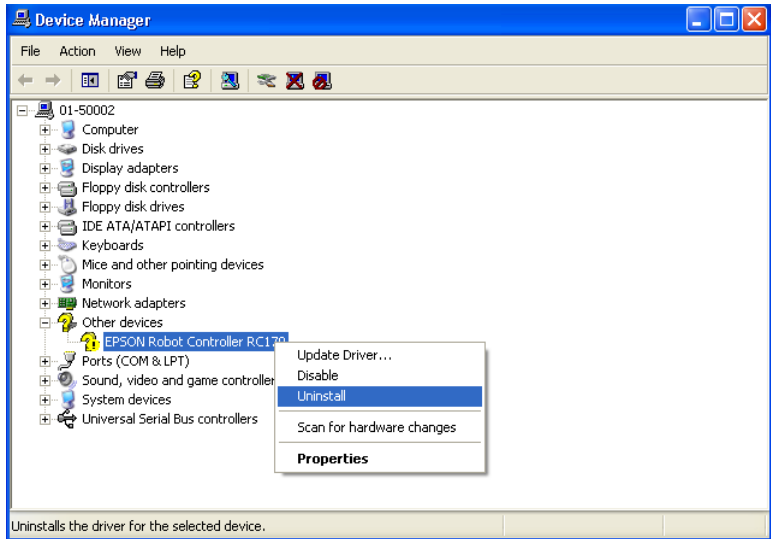

- (1) Select and right click “EPSON Robot Controller” in the [Device Manager] dialog.
- (2) Select [Uninstall].
- (3) The [Uninstall Device] dialog appears.
Click the <Uninstall> button.

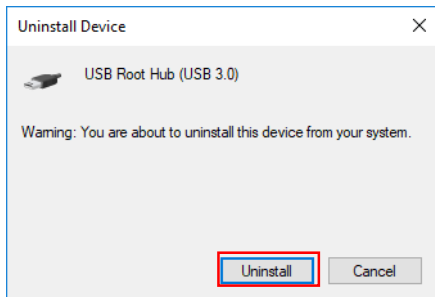

- (4) Remove the USB cable and connect the USB cable again.
The message, “Install EPSON Robot Controller”, will be displayed at the bottom right of the window screen.
- (5) Controller is installed automatically.
When the message, “EPSON Robot Controller is installed and ready to use.”, is displayed at the bottom right of the window screen, communication is available.

NOTE



If the problem is not corrected, please contact the supplier of your region.

11. Maintenance Parts List

Part Name		Code	Old Code	Note
Fan		2157260	R13B060510	
Fan Filter		1596688	R13N865021	Black (While stock lasts)
		2195106	–	White
Battery		2113554	R13B060003	
Motor Driver	5A/5A *	2176557	–	See the table below for motor selection
	10A/10A	2172039	R13N874011	
		2195537	–	
	15A/5A	2188815	–	
	15A/15A	2171247	R13N874021	
	15A/15A-2	2168582	–	
		2194709	–	
	30A/5A	2188814	–	
30A/30A	2171456	R13NZ90002		
50A/30A	2205668	–		

* Not supported for Drive Unit

Motor driver (** A / ** A)

Control Unit Drive Unit	Manipulator	Joint #1, #2	Joint #3, #4	Joint #5, #6	Remarks
RC700 RC700DU	C4	15A/15A	10A/10A		MDB type
		2171247	2172039		Code
		R13N874021	R13N874011		Old Code
RC700-A RC700DU-A	C4	15A/15A-2	10A/10A		MDB type
		2194709	2195537		Code
	C8 C12 *	50A/30A	15A/15A-2	10A/10A	MDB type
		2205668	2194709	2195537	Code
	N2 *	5A/5A			MDB type
		2176557			Code
	N6	30A/5A	15A/5A	30A/5A	MDB type
		2188814	2188815	2188814	Code

* Not supported for Drive Unit

Control Unit Drive Unit	Manipulator	Joint #1, #2	Joint #3, #4	Remarks	
RC700-A RC700DU-A	G1 G3	10A/10A		MDB type	
		2172039		Code	
		R13N874011		Old Code	
	G6 RS	15A/15A-2	10A/10A		MDB type
		2168582	2172039		Code
		–	R13N874011		Old Code
	G10 G20	30A/30A	15A/15A-2		MDB type
		2171456	2168582		Code
		R13NZ90002	–		Old Code

The code of the following parts differs depending on the Controller.
 Also, the code of RC700-A differs depending on the serial number (Note: R7*****).
 If you need the parts, please confirm the Controller type and serial number before contact us.

Part Name		Code	Old Code	Note	
For RC700	DMB-MAIN	2180932	—		
	DMB-SUB	2151349	R13N842021		
	DMB-LED	2151351	R13N842031		
	DPB	2171246	R13N844011		
	TP Bypass Plug	2111451	R13B060705		
	CF (Compact Flash)	1605920	R13N8B6011		
For RC700-A	DMB-MAIN	C series	2182346	—	R7**00****
		G series			R7**01****
	DMB-MAIN	RS series	2189444	—	R7**02****
		N series			R7**03**** or later
	DMB-SUB	C, N series	2171261	—	
		G, RS series	2171816	—	
	DMB-LED		2171262	—	
	DPB		2171263	—	
	TP Bypass Plug		2171258	—	
CF(Compact Flash)		1605920	R13N8B6011	R7**00**** R7**01**** R7**02****	
		2195736	—	R7**03**** or later	
For RC700DU	DMB-MAIN		2157193	R13NZ90003	
	DMB-SUB	C4, C8 series	2157195	R13NZ90004	Same as RC700DU-A
		G series	2171817	—	Same as RC700DU-A
	RS series				
	DMB-LED		2157209	R13NZ90005	Same as RC700DU-A
DPB		2171246	R13N844011	Same as RC700	
For RC700DU-A	DMB-MAIN		2204998	—	
	DMB-SUB	C4, C8 series	2157195	R13NZ90004	Same as RC700DU
		G series	2171817	—	Same as RC700DU
	RS series				
	DMB-LED		2157209	R13NZ90005	Same as RC700DU
DPB		2171263	—	Same as RC700-A	

12. Option Parts List

Part Name	Code	Old Code	Note
Expansion I/O Board (Source type)	R12NZ9003P	R12B040302	
Expansion I/O Board (Sink type)	R12NZ9003Q	R12B040303	
RS-232C Board	R12NZ9004E	R12B040726	
DeviceNet Board	R12NZ9004F	R12B040727	DeviceNet module is mounted on the Fieldbus Board.
PROFIBUS Board	R12NZ9004H	R12B040729	PROFIBUS-DP module is mounted on the Fieldbus Board.
CC-Link Board	R12NZ9004J	R12B040730	CC-Link module is mounted on the Fieldbus Board.
PROFINET Board	R12NZ900A6	R12N747051	PROFINET module is mounted on the Fieldbus Board.
EtherNet/IP Board	R12NZ900A7	R12N747061	EtherNet/IP module is mounted on the Fieldbus Board.
EtherCAT Board	R12NZ900CL	–	EtherCAT module is mounted on the Fieldbus Board.
PG Board	R12NZ900A8	R12N748011	
Analog I/O Board (1CH)	R12NZ900WZ	–	
Analog I/O Board (4CH)	R12NZ900X1	–	
Force Sensor I/F Board (FS2)	2184536	–	
EUROMAP67 Board	R12NZ90104	–	
EUROMAP67 Board (without IMM connection cable)	R12NZ9010A	–	EUROMAP67 without Cable2
EUROMAP67 Cable1	2194667	–	For EUROMAP67 Board Emergency Stop cable
EUROMAP67 Cable2	2194668	–	For EUROMAP67 Board IMM Connection cable
EUROMAP67 Emergency Connector Plug	2165789	–	For EUROMAP67 Board Soldering plug
EUROMAP67 Emergency Connector Shell	2194882	–	For EUROMAP67 Board Shell kit

