

EPSON

ROBOT CONTROLLER

RC700 / RC700-A

Rev.27

EM208C4453F

ROBOT CONTROLLER RC700 / RC700-A Rev.27

ROBOT CONTROLLER

RC700 / RC700-A

Rev.27

Copyright © 2012-2020 SEIKO EPSON CORPORATION. All rights reserved.

FOREWORD

Thank you for purchasing our robot products.

This manual contains the information necessary for the correct use of the robot controller.

Please carefully read this manual and other related manuals before installing the robot system.

Keep this manual handy for easy access at all times.

WARRANTY

The robot system and its optional parts are shipped to our customers only after being subjected to the strictest quality controls, tests, and inspections to certify its compliance with our high performance standards.

Product malfunctions resulting from normal handling or operation will be repaired free of charge during the normal warranty period. (Please contact the supplier of your region for warranty period information.)

However, customers will be charged for repairs in the following cases (even if they occur during the warranty period):

1. Damage or malfunction caused by improper use which is not described in the manual, or careless use.
2. Malfunctions caused by customers' unauthorized disassembly.
3. Damage due to improper adjustments or unauthorized repair attempts.
4. Damage caused by natural disasters such as earthquake, flood, etc.

Warnings, Cautions, Usage:

1. If the robot system associated equipment is used outside of the usage conditions and product specifications described in the manuals, this warranty is void.
2. If you do not follow the WARNINGS and CAUTIONS in this manual, we cannot be responsible for any malfunction or accident, even if the result is injury or death.
3. We cannot foresee all possible dangers and consequences. Therefore, this manual cannot warn the user of all possible hazards.

TRADEMARKS

Microsoft, Windows, and Windows logo are either registered trademarks or trademarks of Microsoft Corporation in the United States and/or other countries. Other brand and product names are trademarks or registered trademarks of the respective holders.

TRADEMARK NOTATION IN THIS MANUAL

Microsoft® Windows® 8 Operating system

Microsoft® Windows® 10 Operating system

Throughout this manual, Windows 8, and Windows 10 refer to above respective operating systems. In some cases, Windows refers generically to Windows 8, and Windows 10.

NOTICE

No part of this manual may be copied or reproduced without authorization.

The contents of this manual are subject to change without notice.

Please notify us if you should find any errors in this manual or if you have any comments regarding its contents.

MANUFACTURER

SEIKO EPSON CORPORATION

CONTACT INFORMATION

Contact information is described in “SUPPLIERS” in the first pages of the following manual:

Robot System Safety and Installation Read this manual first

Before Reading This Manual

NOTE



Do not connect the followings to the TP/OP port of RC700 / RC700-A. Connecting to the followings may result in malfunction of the device since the pin assignments are different.

OPTIONAL DEVICE dummy plug

Operation Pendant OP500

Operator Pendant OP500RC

Jog Pad JP500

Teaching Pendant TP-3**

Operator Panel OP1

NOTE



For RC700 / RC700-A, be sure to install the EPSON RC+7.0 to the development PC first, then connect the development PC and RC700 / RC700-A with the USB cable.

If RC700 / RC700-A and the development PC are connected without installing the EPSON RC+7.0 to the development PC, [Add New Hardware Wizard] appears. If this wizard appears, click the <Cancel> button.

NOTE



Concerning the security support for the network connection:

The network connecting function (Ethernet) on our products assumes the use in the local network such as the factory LAN network. Do not connect to the external network such as Internet.

In addition, please take security measure such as for the virus from the network connection by installing the antivirus software.

NOTE



Security support for the USB memory:

Make sure the USB memory is not infected with virus when connecting to the Controller.

Safety

1. Safety	3
2. Conventions	3
3. Safety Precautions	4

Setup & Operation

1. Specifications	9
1.1 System Example	9
1.2 Standard Specifications	11
1.3 Outer Dimensions	13
2. Part Names and Functions	14
2.1 LED and Seven-segment LED	18
2.1.1 LED and Seven-segment LED Display	18
2.1.2 Particular Status Display	19
2.2 Safety Features	20
3. Installation	22
3.1 Unpacking	22
3.2 Environmental Requirements	22
3.2.1 Environment	22
3.2.2 Installation	23
3.2.3 Wall Mounting Option	24
3.3 Power Supply	28
3.3.1 Specifications	28
3.3.2 AC Power Cable	29
3.4 Cable Connection	30
3.4.1 Typical Cable Connection	31
3.4.2 Connecting Manipulator to Controller	33
3.5 Noise Countermeasures	34

4. Operation Mode (TEACH/AUTO/TEST)	35
4.1 Overview	35
4.2 Switch Operation Mode	36
4.3 Program Mode (AUTO)	37
4.3.1 What is Program Mode (AUTO)?.....	37
4.3.2 Setup from EPSON RC+	37
4.4 Auto Mode (AUTO).....	38
4.4.1 What is Auto mode (AUTO)?	38
4.4.2 Setup from EPSON RC+	38
4.4.3 Setup from Control Device.....	39
5. Development PC Connection USB Port	40
5.1 About Development PC Connection USB Port	40
5.2 Precaution.....	40
5.3 PC and Controller Connection Using Development PC Connection USB Port	41
5.4 Disconnection of Development PC and Controller.....	42
5.5 How to Fix USB Cable.....	42
6. Memory Port	43
6.1 What is Backup Controller Function?.....	43
6.2 Before Using Backup Controller Function	43
6.2.1 Precautions	43
6.2.2 Adoptable USB Memory	43
6.3 Backup Controller Function	44
6.3.1 Backup Controller with Trigger Button.....	44
6.3.2 Load Data with EPSON RC+ 7.0.....	44
6.3.3 Transfer with E-mail	44
6.4 Details of Data	45
7. LAN (Ethernet Communication) Port	46
7.1 About the LAN (Ethernet Communication) Port.....	46
7.2 IP Address	46
7.3 Changing Controller IP Address.....	47
7.4 Connection of Development PC and Controller with Ethernet.....	48
7.5 Disconnection of Development PC and Controller with Ethernet	49

8. TP Port	50
8.1 What is the TP Port?.....	50
8.2 Teach Pendant Connection	51
9. EMERGENCY	52
9.1 Safety Door Switch and Latch Release Switch	52
9.1.1 Safety Door Switch.....	53
9.1.2 Latch Release Switch.....	53
9.1.3 Checking Latch Release Switch Operation	54
9.2 Emergency Stop Switch Connection	55
9.2.1 Emergency Stop Switch.....	55
9.2.2 Checking Emergency Stop Switch Operation.....	55
9.2.3 Recovery from Emergency Stop	55
9.3 Pin Assignments	56
9.4 Circuit Diagrams	57
9.4.1 Example 1: External emergency stop switch typical application	57
9.4.2 Example 2: External safety relay typical application.....	58
10. Standard RS-232C Port	59
10.1 RS-232C Port.....	59
10.2 Confirmation with EPSON RC+ 7.0 (RS-232C)	59
10.3 RS-232C Software Communication Setup (RS-232C).....	60
10.4 Communication Cable (RS-232C).....	60
11. I/O Connector	61
11.1 Input Circuit.....	61
Typical Input Circuit Application 1.....	62
Typical Input Circuit Application 2.....	63
11.2 Output Circuit.....	64
Typical Output Circuit Application 1: Sink Type	64
Typical Output Circuit Application 2: Source Type	65
11.3 Pin Assignments	66

12. I/O Remote Settings	67
12.1 I/O Signal Description.....	68
12.1.1 Remote Input Signals	68
12.1.2 Remote Output Signals.....	72
12.2 Timing Specifications.....	75
12.2.1 Design Notes for Remote Input Signals	75
12.2.2 Timing Diagram for Operation Execution Sequence.....	75
12.2.3 Timing Diagram for Program Execution Sequence.....	75
12.2.4 Timing Diagram for Safety Door Input Sequence.....	76
12.2.5 Timing Diagram for Emergency Stop Sequence.....	76
13. R-I/O Connector	77
13.1 Input Circuit.....	77
Typical Input Circuit Application 1	77
Typical Input Circuit Application 2	78
13.2 Pin Assignments.....	78
14. Option Slots	79
14.1 About Option Slots.....	79
14.2 Expansion I/O Board	80
14.2.1 Expansion I/O Board.....	80
14.2.2 Board Configuration (Expansion I/O Board).....	80
14.2.3 Confirmation with EPSON RC+ 7.0 (Expansion I/O Board).....	80
14.2.4 Input Circuit.....	81
14.2.5 Output Circuit.....	83
Typical Output Circuit Application 1: Sink Type	84
Typical Output Circuit Application 2: Source Type.....	85
14.2.6 Pin Assignments (Expansion I/O Board).....	86
14.3 Fieldbus I/O Board.....	90
14.4 RS-232C Board	91
14.4.1 About the RS-232C Board	91
14.4.2 Board Setup (RS-232C).....	91
14.4.3 Confirmation with EPSON RC+ (RS-232C).....	92
14.4.4 RS-232C Software Communication Setup (RS-232C).....	92
14.4.5 Communication Cable (RS-232C)	93
14.5 PG Board	94

14.6	Analog I/O Board	95
14.6.1	About Analog I/O Board	95
14.6.2	Board Configuration (Analog I/O Board).....	96
14.6.3	Confirmation with EPSON RC+ (Analog I/O Board).....	99
14.6.4	Input Circuit (Analog I/O Board).....	100
14.6.5	Output Circuit (Analog I/O Board).....	100
14.6.6	Pin Assignments (Analog I/O Board).....	101
14.7	Force Sensor I/F Board	102
14.7.1	About Force Sensor I/F Board	102
14.7.2	Board Configuration (Force Sensor I/F Board).....	102
14.7.3	Confirmation with EPSON RC+ (Force Sensor I/F Board).....	103
14.8	EUROMAP67 Board	104
14.8.1	Notes on the EUROMAP67 Board.....	106
14.8.2	Board Settings (EUROMAP67 Board).....	108
14.8.3	Installation (EUROMAP67 Board).....	108
14.8.4	Confirming with EPSON RC+ 7.0 (EUROMAP67 Board).....	111
14.8.5	Sample Project (EUROMAP67 Board).....	111
14.8.6	Circuit Overview (EUROMAP67 Board)	112
14.8.7	Input Circuit (EUROMAP67 Board)	113
14.8.8	Output Circuit (EUROMAP67 Board).....	113
14.8.9	Emergency Stop, Safeguard (EUROMAP67 Board).....	114
14.8.10	I/O Pin Assignments (EUROMAP67 Board).....	115
14.8.11	Emergency stop connecter Pin Assignments (EUROMAP67 Board).....	117

Maintenance

1.	Safety Precautions on Maintenance	121
2.	Regular Maintenance Inspection	123
3.	Controller Structure	124
3.1	Location of Parts	124
3.1.1	RC700	124
3.1.2	RC700-A.....	124
3.2	Diagram of Cable Connections.....	125
3.2.1	RC700	125
3.2.2	RC700-A.....	126

4. Backup and Restore	127
4.1 What is the Backup Controller Function?.....	127
4.2 Backup Data Types	127
4.3 Backup.....	128
4.4 Restore	129
5. Firmware Update	132
5.1 Updating Firmware	132
5.2 Firmware Upgrade Procedure	132
5.3 Controller Recovery.....	135
5.4 Firmware Initialization Procedure	136
5.5 Adding Confirmation Steps by Strengthening Security of EtherNet Connection.....	138
6. Alarm	142
6.1 Before Controller Firmware Ver.7.1.8.x.....	143
6.1.1 Alarm Configuration	143
6.1.2 How to View the Alarm Information	144
6.1.3 How to Edit the Alarm Information.....	145
6.1.4 Alarm Notifying Method.....	145
6.1.5 How to Cancel the Alarm	146
6.2 Controller Firmware Ver.7.2.0.x or later	147
6.2.1 Maintenance.....	147
6.2.2 How to View the Maintenance Information.....	148
6.2.3 How to Edit the Maintenance Information.....	150
6.2.4 Alarm Notifying Method.....	151
6.2.5 How to Cancel the Alarm	151
7. Maintenance Parts Replacement Procedures	152
7.1 Fan Filter.....	152
7.2 Fan.....	153
7.2.1 Front Fan.....	153
7.2.2 Fan2 (RC700-A only).....	154
7.3 Battery.....	156
7.4 CF (Compact Flash)	158
7.5 MDB	159
7.6 DMB	163
7.7 DMB-SUB Board.....	167

7.8	DMB-LED Board	168
7.8.1	DMB-LED Board (RC700).....	168
7.8.2	DMB-LED Board (RC700-A).....	169
7.9	DPB.....	170
7.10	Option Board.....	172
8. Verifying Robot System Operation		173
9. Troubleshooting		174
9.1	Error Code Table	174
9.2	Cannot Connect the Development PC and the Controllerusing the USB cable	307
9.2.1	Confirmation Using Windows Device Manager	308
9.2.2	When recognized under “Other devices” in Windows Device Manager	310
10. Maintenance Parts List		311
11. Option Parts List		313

Safety

This section contains information for safety of the Robot System.



1. Safety

Installation and transportation of Manipulators and robotic equipment shall be performed by qualified personnel and should conform to all national and local codes.

Please read this manual and other related manuals before installing the robot system or before connecting cables. Keep this manual in a handy location for easy access at all times.

2. Conventions

Important safety considerations are indicated throughout the manual by the following symbols. Be sure to read the descriptions shown with each symbol.

 WARNING	This symbol indicates that a danger of possible serious injury or death exists if the associated instructions are not followed properly.
 WARNING	This symbol indicates that a danger of possible harm to people caused by electric shock exists if the associated instructions are not followed properly.
 CAUTION	This symbol indicates that a danger of possible harm to people or physical damage to equipment and facilities exists if the associated instructions are not followed properly.

3. Safety Precautions

Only trained personnel should design and install the robot system.

Trained personnel are defined as those who have taken robot system training class held by the manufacturer, dealer, or local representative company, or those who understand the manuals thoroughly and have the same knowledge and skill level as those who have completed the training courses.

The following items are safety precautions for qualified design or installation personnel:



WARNING



- Personnel who design and/or construct the robot system with this product must read the Safety chapter in User's Guide to understand the safety requirements before designing and/or constructing the robot system. Designing and/or constructing the robot system without understanding the safety requirements is extremely hazardous, may result in serious bodily injury and/or severe equipment damage to the robot system, and may cause serious safety problems.
- The Manipulator and the Controller must be used within the environmental conditions described in their respective manuals. This product has been designed and manufactured strictly for use in a normal indoor environment. Using the product in an environment that exceeds the specified environmental conditions may not only shorten the life cycle of the product but may also cause serious safety problems.
- The robot system must be used within the installation requirements described in the manuals. Using the robot system outside of the installation requirements may not only shorten the life cycle of the product but also cause serious safety problems.
- The interlock of the Safety Door must be functioning when the robot system is operated. Do not operate the system under the condition that the switch cannot be turned ON/OFF. (I.E. the condition where the switch is disabled) (Example: Tape is put around the switch to hold it closed.) Operating the robot system when the switch is not functioning properly is extremely hazardous and may cause serious safety problems as the Safety Door input cannot fulfill its intended function.
- Connect input signal wires for Emergency Stop and Safety Door to the EMERGENCY connector so that the Emergency Stop switch in the Teach Pendant connected to the TP port always functions. (Refer to the typical application diagram in Setup & Operation 9.4 Circuit Diagrams.)

The following items are safety precautions for qualified design or installation personnel: (cont.)

 WARNING	<ul style="list-style-type: none"> ■ Do not open the cover(s) of the Controller except while maintaining it. Opening the cover(s) of the Controller is extremely hazardous and may result in electric shock even when its main power is OFF because of the high voltage charge inside the Controller. ■ Make sure that the power to the Controller is turned OFF before connecting or disconnecting any cables. Connecting or disconnecting any cables with the power ON is extremely hazardous and may result in electric shock and/or malfunction of the Controller. ■ Be sure to connect the cables properly. Do not allow unnecessary strain on the cables. (Do not put heavy objects on the cables. Do not bend or pull the cables forcibly.) The unnecessary strain on the cables may result in damage to the cables, disconnection, and/or contact failure. Damaged cables, disconnection, or a contact failure is extremely hazardous and may result in electric shock and/or improper function of the system. ■ When connecting the plug to fit the outlet in your factory, make sure that it is done by qualified personnel. When connecting the plug, be sure to connect the earth wire of the AC power cable colored green/yellow on the Controller to the earth terminal of the factory power supply. The equipment must be grounded properly at all times to avoid the risk of electric shock. Always use a power plug and receptacle. Never connect the Controller directly to the factory power supply. (Field wiring)
--	--

 CAUTION	<ul style="list-style-type: none"> ■ The serial number of the Manipulator that should be connected is indicated on the Connection Check Label on the Controller. Connect the Controller and the Manipulator correctly. Improper connection between the Controller and the Manipulator may cause improper function of the robot system and also safety problems. ■ When using remote I/O, always make sure of the following. Using the robot system under unsatisfactory conditions may cause malfunction of the system and/or safety problems. <ul style="list-style-type: none"> - Assign remote functions to inputs/outputs correctly and wire correctly when setting up remote I/O signals. - Make sure that the functions correspond to the correct input/output signals before turning ON the system. - When verifying the robot system operation, prepare for failures with initial settings or wiring. If the Manipulator functions unusually by the failures with initial settings or wiring, press the Emergency Stop switch immediately to stop the Manipulator.
--	--

The following items are safety precautions for qualified operator personnel:

 WARNING	<ul style="list-style-type: none">■ The interlock of the Safety Door must be functioning when the robot system is operated. Do not operate the system under the condition that the switch cannot be turned ON/OFF. (I.E. the condition where the switch is disabled) (Example: Tape is put around the switch to hold it closed.) Operating the robot system when the switch is not functioning properly is extremely hazardous and may cause serious safety problems as the Safety Door input cannot fulfill its intended function.
 WARNING	<ul style="list-style-type: none">■ Do not open the cover(s) of the Controller except while maintaining it. Opening the cover(s) of the Controller is extremely hazardous and may result in electric shock even when its main power is OFF because of the high voltage charge inside the Controller.

Setup & Operation

This section contains information for setup and operation of the Robot Controller.

1. Specifications

1.1 System Example

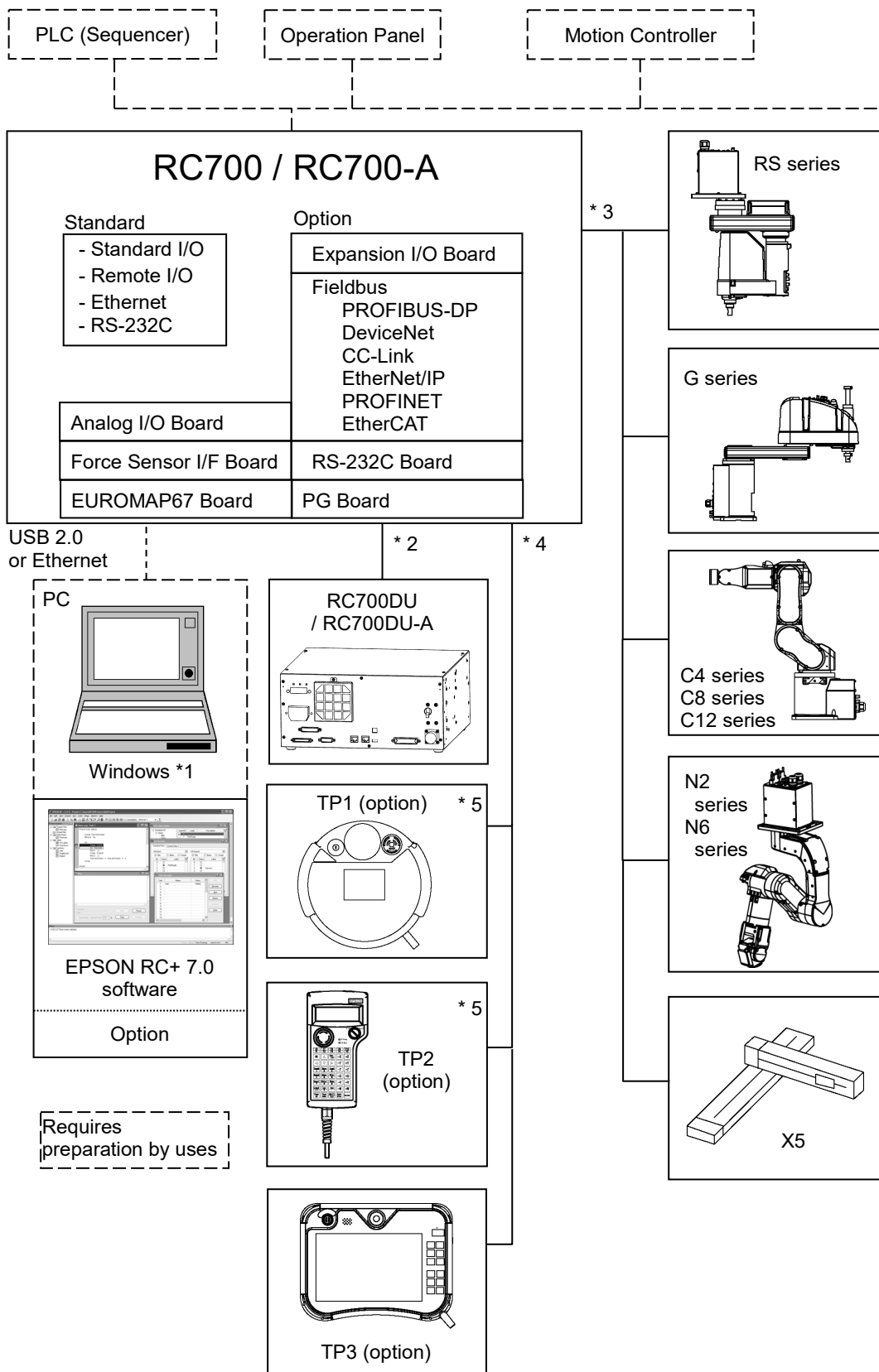

*1 EPSON RC+ 7.0 supports the following OS.
 Windows 8.1 Pro (EPSON RC+ 7.0 Ver.7.1.0 or later)
 Windows 10 Pro (EPSON RC+ 7.0 Ver.7.2.0 or later)

*2 Up to three Drive Units can be connected.

For details, refer to following manual.

Robot Controller / Drive Unit RC700DU / RC700DU-A

*3 Any one of the Manipulators can be controlled.

Available combinations are as follows. (✓: connectable)

	C4	C8	C12	G	RS	N2	N6	X5
RC700	✓	-	-	-	-	-	-	-
RC700-A	✓	✓	✓	✓	✓	✓	✓	✓

*4 Any one of the Teach pendant can be controlled.

TP3 cannot be connected to RC700.

*5 When connecting to RC700-A, a dedicated conversion cable is required.

1.2 Standard Specifications

Item	Specification		
Model	Robot Controller RC700 / RC700-A		
CPU	32 bits Micro Processor		
Controllable axes	6 AC servo motors		
Robot Manipulator control	Programming language and Robot control software	EPSON RC+ 7.0 (a multi-tasking robot language)	
	Joint Control	Up to 6 joints simultaneous control Software AC servo control	
	Speed Control	PTP motion : Programmable in the range of 1 to 100% CP motion : Programmable (Actual value to be manually entered.)	
	Acceleration/ deceleration control	PTP motion : Programmable in the range of 1 to 100%; Automatic CP motion : Programmable (Actual value to be manually entered.)	
Positioning control	PTP (Point-To-Point control) CP (Continuous Path control)		
Memory capacity	Maximum Object Size : 4 MB Point data area : 1000 points (per file) Backup variable area : Max. 100 KB (Includes the memory area for the management table.) Approx. 1000 variables (Depends on the size of array variables.)		
Teaching method	Remote Direct MDI (Manual Data Input)		
External input/output signals (standard)	Standard I/O	Input : 24 Output : 16	Including 8 inputs, 8 outputs with remote function assigned Assignment change allowed
	R I/O	Input : 2 Output : 2	-
	Standard I/O (Drive Unit)	Input : 24 Output : 16	Per 1 Drive Unit
Communication interface (standard)	Ethernet	1 channel	
RS-232C port	1 port		

Item	Specification		
Options (Max. 4 slots)	Expansion I/O	Input : 24 per board Output : 16 per board	Addition of 4 boards allowed
	Communication interface	RS-232C : 2ch per board	Addition of 2 boards allowed *2
		Fieldbus I/O : 1ch per board PROFIBUS-DP, DeviceNet, CC-Link, EtherNet/IP, PROFINET EtherCAT	Addition of 1 board from the left allowed
		Force Sensor I/F: 1ch/port	Addition of 1 board allows
	PG	Controllable joints 4 joints/board	Addition of 4 boards allowed
	Analog I/O	SKU1 Output: 1ch	Addition of 4 board from the left allowed
		SKU2 Output: 2ch Input: 2ch	
EUROMAP67	Input : 15 Output : 16	Addition of 2 boards allowed	
Safety features	<ul style="list-style-type: none"> - Emergency stop switch - Safety door input - Low power mode - Dynamic brake - Motor overload detection - Irregular motor torque (out-of-control Manipulator) detection - Motor speed error detection - Positioning overflow - servo error - detection - Speed overflow - servo error - detection - CPU irregularity detection - Memory check-sum error detection - Overheat detection at the Motor Driver Module - Relay welding detection - Over-voltage detection - AC power supply voltage reduction detection - Temperature error detection - Fan error detection 		
Power Source	200 VAC to 240 VAC Single phase 50/60 Hz		
Maximum Rated Capacity	2.5 kVA (Depending on the Manipulator model)		
Insulation Resistance	100 MΩ or more		
Rated Ambient Temperature	5 to 40 °C		
Rated Relative Humidity	20% to 80% (with no condensation)		
Weight *1	11 kg		
Degree of protection	IP20		

*1 Weight of the unit is indicated on the Controller itself.

Make sure to check the weight before units transfer or relocation and prevent throwing out your back at holding the unit.

Also, make sure to keep your hands, fingers, and feet safe from being caught or serious injury.

*2 When using the Force Sensor I/F board, a maximum of one board/two ports expansion is available for RS-232C board.

1.3 Outer Dimensions

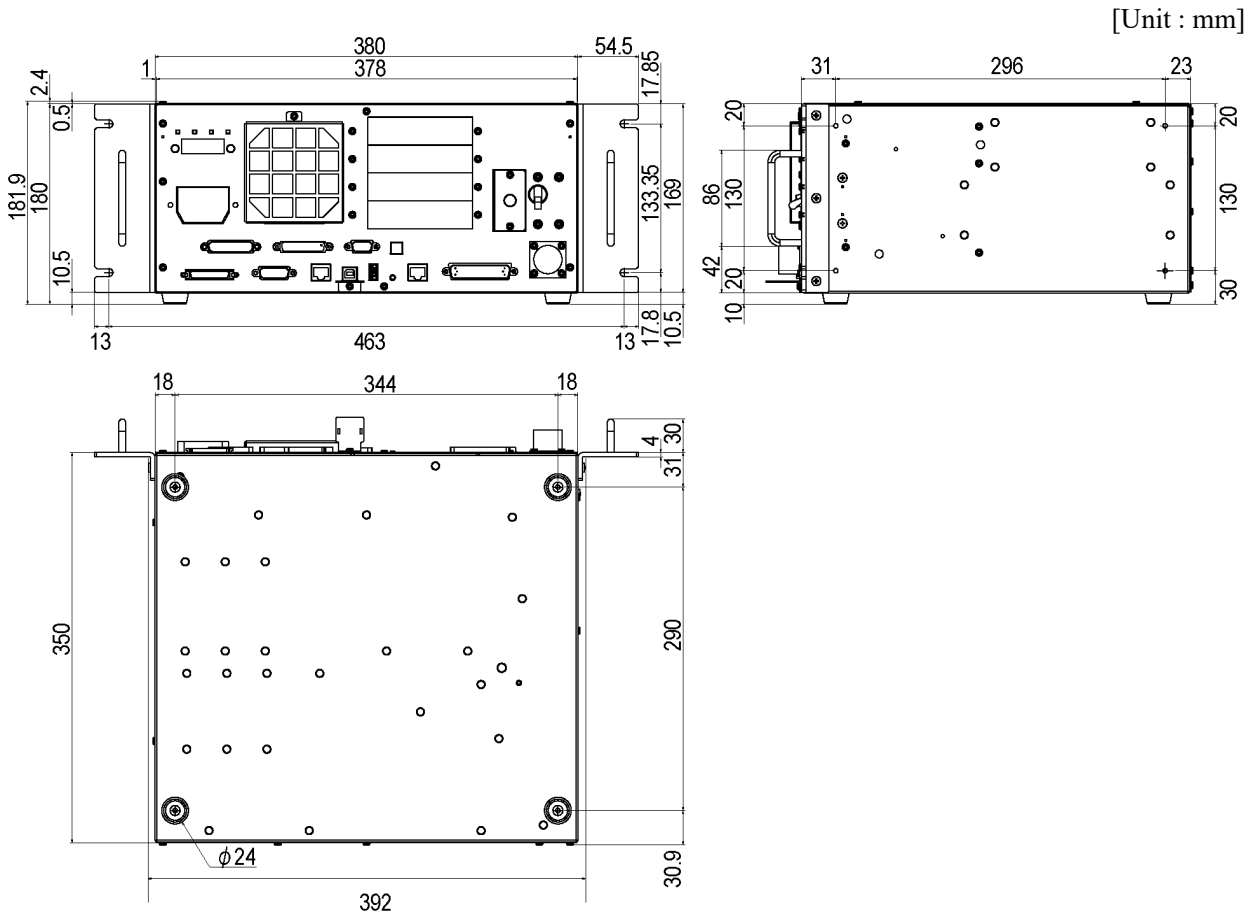

(Figure: RC700)

2. Part Names and Functions

RC700

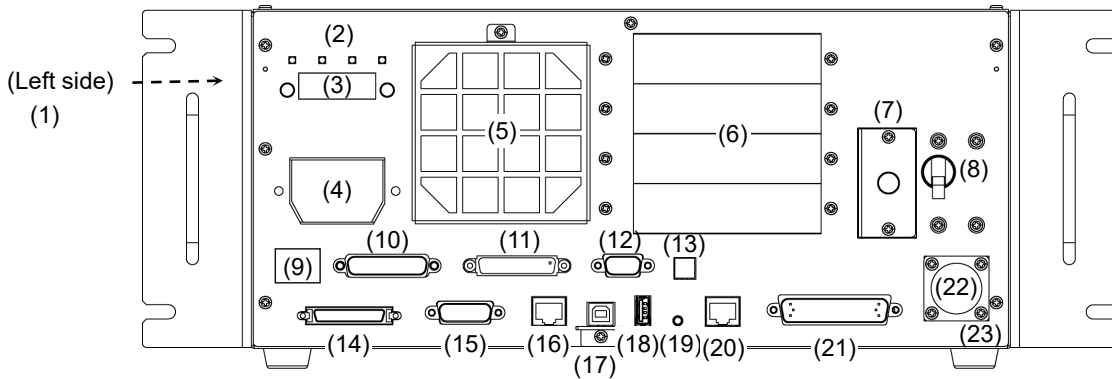

RC700-A

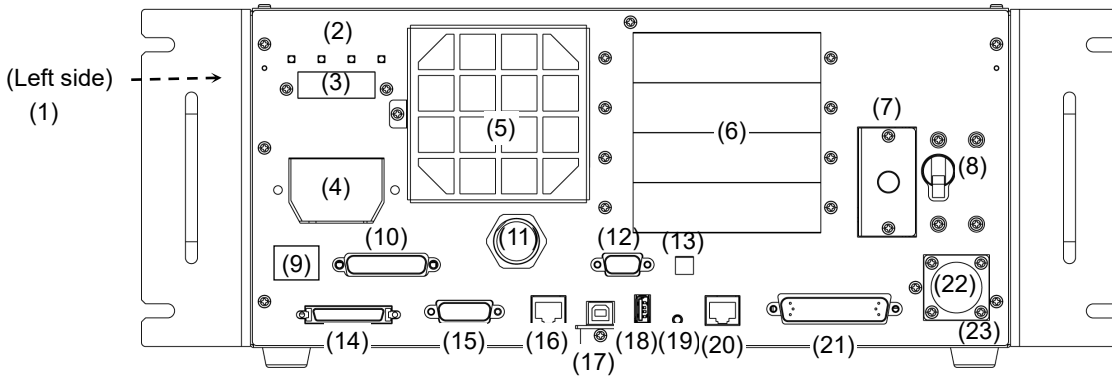

- (1) **Controller Number label**
The serial number of the Controller is indicated.
- (2) **LED**
The LED indicates current operation mode (TEST, TEACH, AUTO, or PROGRAM mode).
For details, refer to *Setup & Operation 2.1 LED and Seven-segment LED*.
- (3) **Seven-segment Display**
Four-digit seven-segment LED displays the line number and the status of the Controller (error number, warning number, status of Emergency Stop and Safety Door). For details, refer to *Setup & Operation 2.1 LED and Seven-segment LED*.
- (4) **M/C POWER connector**
A connector for the Manipulator power source.
Connect the dedicated power cable attached to the Manipulator.
- (5) **Fan Filter**
A protective filter is installed in front of the fan to filter out dust.
Check the condition of the filter regularly and clean it when necessary. A dirty filter may result in malfunction of the robot system due to temperature rise of the Controller.

(6) Option slot

Option boards such as expansion I/O board, Fieldbus I/O board, RS-232C board, PG board, Analog I/O board, and Force Sensor I/F board can be installed. Four slots are available.

For details, refer to *Setup & Operation 13. Option Slots*.

(7) Battery

A lithium battery for data backup.

(8) POWER switch

Turns ON or OFF the Controller.

(9) Connection Check label

The details of the Manipulator to be connected are recorded on the label as shown in the right. The label indicates the Manipulator model and Manipulator serial number.

MANIPULATOR	
C4-A600S	00001

(10) EMERGENCY connector

This connector is used for input/output from/to Emergency Stop and Safety Door switches. For details, refer to the *Setup & Operation 9. EMERGENCY*.

(11) TP port

Connects Teach Pendant TP1, TP2, TP3 (Option) and TP bypass plug. Note that the shape of the TP port differs between RC700 and RC700-A.

For details, refer to *Setup & Operation 8. TP Port*.



Do not connect the following to the TP port of RC700/RC700-A. It may result in malfunction of the device since the pin assignments are different.

- OPTIONAL DEVICE dummy plug
- Operation Pendant OP500
- Operator Pendant OP500RC
- Jog Pad JP500
- Teaching Pendant TP-3**
- Operator Panel OP1

(12) Standard RS-232C port

This port is used for the RS-232C communication with external devices.

For details, refer to *Setup & Operation 10. Standard RS-232C Port*.

(13) Encoder Voltage Adjustment Switch

Use this switch to adjust voltage according to length of M/C cable. (adjusted as a factory default)

Wrong setting may result in Robot system malfunction.

Switch	M/C Cable Length
1	3 m
2	5 m
3	10 m
4	15, 20 m

(14) M/C SIGNAL connector

This connector is used for signals such as the Manipulator's motor position detector, etc. Connect the Manipulator's dedicated signal cable.

(15) R-I/O connector

This connector is for the input signals used for the real time I/O function.

(16) RC700: DU OUT connector / RC700-A: OUT connector

The connector for Drive Unit.

(17) Development PC connection USB port

This port connects the Controller and the Development PC using a USB cable.

Do not connect other devices except the Development PC.

For details, refer to *Setup & Operation 5. Development PC Connection USB Port*.

(18) Memory port

This port connects the common USB memory for Controller backup function. Do not connect other USB devices except the USB memory.

For details, refer to *Setup & Operation 6. Memory Port*.

(19) Trigger Switch

This switch is for Controller backup function using the USB memory.

For details, refer to *Setup & Operation 6. Memory Port*.

(20) LAN (Ethernet communication) port

This port connects the Controller and the Development PC using an Ethernet cable.

100BASE-TX / 10BASE-T communication are available.

For details, refer to *Setup & Operation 7. LAN (Ethernet communication) Port*.

(21) I/O connector

This connector is used for input/output device. There are 24 inputs and 16 outputs.

For details, refer to *Setup & Operation 11. I/O Connector*.

(22) AC IN

The connector for 200VAC power input.

For details, refer to *Setup & Operation 3.3.2 AC Power Cable*.

(23) Signature label

The serial number of the Controller and other information are shown.

RC700-A-UL

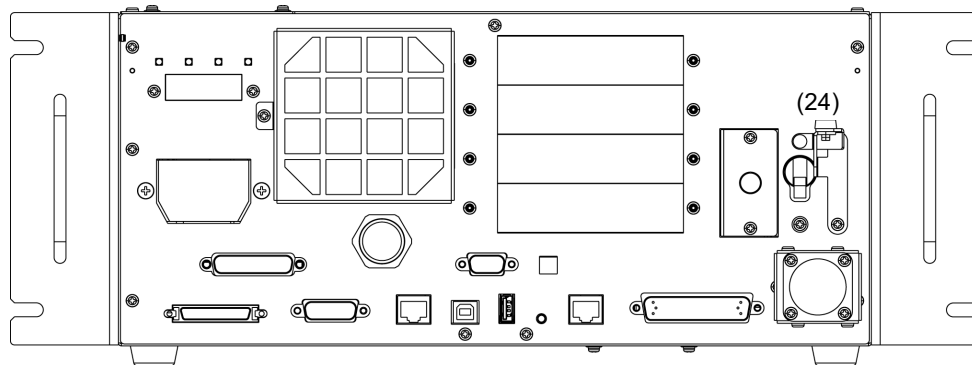

UL-Compliant Controller (RC700-A-UL):

(24) Lock out feature

This feature is used to lock out the power switch when working with the power off such as maintenance.

A padlock for lockout should be prepared by users.

Applicable shackle diameter: 4.0 to 6.5 mm

Perform lockout using the following procedure.

- (1) Remove a fixing screw of lockout bracket A by hand.

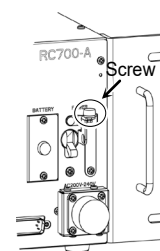

- (2) Rotate the lockout bracket A.

- (3) Set the screw removed in the step (1) to the lockout bracket B so as not to lose it.

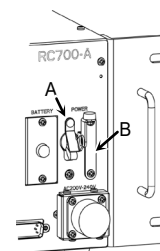

- (4) Put a padlock through the holes of the lockout brackets A and B to lock.

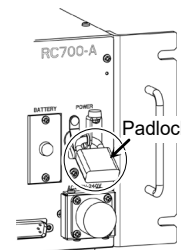

2.1 LED and Seven-segment LED

2.1.1 LED and Seven-segment LED Display

There are four LEDs and a four-digit seven-segment LED display located on the front panel of the Controller.

LED : LED (TEST, TEACH, AUTO, PROGRAM) turns ON according to the current operation mode (TEST, TEACH, Auto, Program).

Seven-segment : Indicates the line number and Controller status (error number, warning number, Emergency Stop or Safeguard status).

From turning ON the Controller to completing startup

LED : All four LEDs blink.









Seven-segment : All four LED digits turn OFF the lights.

After Controller Startup

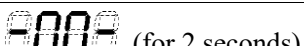
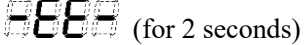
LED : LED (TEST, TEACH, AUTO, PROGRAM) turns ON according to the current operation mode (TEST, TEACH, Auto, Program).

Seven-segment : Display changes according to the Controller status.

When several Controller statuses occurred at one time, the status indicated earlier on the following table is displayed. For an example, when both Emergency Stop and Safeguard statuses occurred at one time,  is displayed.

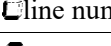
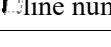
Controller status	Display of seven-segment
Execute Controller status storage function to the USB memory	Displays  and  repeatedly.
Complete Controller status storage to USB memory	Displays  (for 2 seconds)
Failure of Controller status storage to USB memory	Displays  (for 2 seconds)
Error	Displays four-digit error number (0.5 sec) and  (0.5 sec) repeatedly. *1
Warning	Displays four-digit warning number (0.5 sec) and  (0.5 sec) repeatedly. *1
Emergency Stop	 Blink
Safety Door	 Blink
READY	 Blink
START	 line number Blink *2
PAUSE	 line number Blink *2

*1 For error numbers, refer to *EPSON RC+ 7.0 SPEL+ Language Reference*, or *Online Help*.





*2 In initial status, execution line of task number 1 is displayed in three-digit.

Use Ton statement to change the displayed task number.

For details, refer to *EPSON RC+ 7.0 SPEL+ Language Reference*, or *Online Help*.

2.1.2 Particular Status Display

When particular status occurs, seven-segment displays the followings.

Seven-segment	Controller status
	Controller startup failure *1
	Controller startup failure
	Controller in Recovery mode Refer to <i>Maintenance 4. Backup and Restore.</i>
	AC power supply drop is detected and software shut down.
	Software shut down is specified from the EPSON RC+ 7.0 (software) or the Teach Pendant (option).

*1 When the Initialize Error occurs, reboot the Controller. If the Initialize Error is displayed again after the Controller is rebooted, please contact the supplier of your region.

2.2 Safety Features

The robot control system supports safety features described below. However, it is recommended to strictly follow the proper usage of the robot system by thoroughly reading the attached manuals before using the system. Failure to read and understand the proper usage of the safety functions is highly dangerous.

Among the following safety features, the Emergency Stop Switch and Safety Door Input are particularly important. Make sure that these and other features function properly before operating the robot system.

For details, refer to *Setup & Operation 9. EMERGENCY*.

Emergency Stop Switch

The EMERGENCY connector on the Controller has expansion Emergency Stop input terminals used for connecting the Emergency Stop switches.

Pressing any Emergency Stop switch can shut off the motor power immediately and the robot system will enter the Emergency Stop condition.

Stop category of Emergency Stop input: Category 0 (refer to Safety Standard IEC60204-1)

Safety Door Input

In order to activate this feature, make sure that the Safety Door Input switch is connected to the EMERGENCY connector at the Controller.

When the safety door is opened, normally the Manipulator immediately stops the current operation, and the status of Manipulator power is operation-prohibited until the safety door is closed and the latched condition is released. In order to execute the Manipulator operation while the safety door is open, you must change the mode selector key switch on the Teach Pendant to the “Teach” mode. Manipulator operation is available only when the enable switch is on. In this case, the Manipulator is operated in low power status.

Stop category of Safety door input: Category 1 (refer to Safety Standard IEC60204-1)

Low Power Mode

The motor power is reduced in this mode.

Executing a power status change instruction will change to the restricted (low power) status regardless of conditions of the safety door or operation mode. The restricted (low power) status ensures the safety of the operator and reduces the possibility of peripheral equipment destruction or damage caused by careless operation.

Dynamic Brake

The dynamic brake circuit includes relays that short the motor armatures. The dynamic brake circuit is activated when there is an Emergency Stop input or when any of the following errors is detected: encoder cable disconnection, motor overload, irregular motor torque, motor speed error, servo error (positioning or speed overflow), irregular CPU, memory check-sum error and overheat condition inside the Motor Driver Module.

Overload Detection

The dynamic brake circuit is activated when the system detects the overload status of the motor.

Irregular Torque (out-of-control Manipulator) Detection

The dynamic brake circuit is activated when irregular motor torque (motor output) is detected.

Motor Speed Error Detection

The dynamic brake circuit is activated when the system detects that the motor is running at incorrect speed.

Positioning Overflow –Servo Error- Detection

The dynamic brake circuit is activated when the system detects that the difference between the Manipulator's actual position and commanded position exceeds the margin of error allowed.

Speed Overflow –Servo Error- Detection

The dynamic brake circuit is activated when the Manipulator's actual speed is detected to mark an overflow (the actual speed is outside the nominal range) error.

CPU Irregularity Detection

Irregularity of CPU that controls the motor is detected by the watchdog timer. The system CPU and the motor controlling CPU inside the Controller are also designed to constantly check each other for any discrepancies. If a discrepancy is detected, the dynamic brake circuit is activated.

Memory Check-sum Error Detection

The dynamic brake circuit is activated when a memory check-sum error is detected.

Overheat Detection at the Motor Driver Module

The dynamic brake circuit is activated when the temperature of the power device inside the Motor Driver module is above the nominal limit.

Relay Deposition Detection

The dynamic brake circuit is activated when relay deposition, junction error, or open fault is detected.

Over-Voltage Detection

The dynamic brake circuit is activated when the voltage of the Controller is above the normal limit.

AC Power Supply Voltage Drop Detection

The dynamic brake circuit is activated when the drop of the power supply voltage is detected.

Temperature Anomaly Detection

The temperature anomaly is detected.

Fan Malfunction Detection

Malfunction of the fan rotation speed is detected.

3. Installation

3.1 Unpacking

TP/OP Bypass Plug	1 unit
EMERGENCY Port Connector	1 set
I/O Connector	1 set
Rack-Mount Plate	1 set
Power Cable	1 cable
USB Cable Clamp	1 set

3.2 Environmental Requirements

 WARNING	<ul style="list-style-type: none"> ■ The Manipulator and the Controller must be used within the environmental conditions described in their manuals. This product has been designed and manufactured strictly for use in a normal indoor environment. Using the product in the environment that exceeds the conditions may not only shorten the life cycle of the product but also cause serious safety problems.
---	--

3.2.1 Environment

In order to optimize the robot system's performance for safety, the Controller must be placed in an environment that satisfies the following conditions:

NOTE

- The Controller is not designed for clean-room specification. If it must be installed in a clean room, be sure to install it in a proper enclosure with adequate ventilation and cooling.
- Install Controller in a location that allows easy connection / disconnection of cables.

Item	Condition
Ambient temperature	5 to 40 °C (with minimal variation)
Ambient relative humidity	20% to 80% (with no condensation)
Fast transient burst noise	2 kV or less (Power supply wire) 1 kV or less (Signal wire)
Electrostatic noise	4 kV or less
Base table	Use a base table that is at least 100 mm off the floor. Placing the Controller directly on the floor could allow dust penetration leading to malfunction.

If the Controller must be used in an environment that does not fulfill the conditions mentioned above, take adequate countermeasures. For example, the Controller may be enclosed in a cabinet with adequate ventilation and cooling.

- Install indoors only.
- Place in a well-ventilated area.
- Keep away from direct sunlight and radiation heat.
- Keep away from dust, oily mist, oil, salinity, metal powder or other contaminants.
- Keep away from water.
- Keep away from shocks or vibrations.
- Keep away from sources of electronic noise
- Keep away from strong electric or magnetic fields.

3.2.2 Installation

Install the Controller on a flat surface such as wall, floor, and Controller box in the direction shown from (A) to (C).

(A) Flat Mounting

(Figure: RC700)

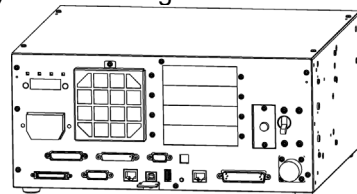

(B) Upright Mounting

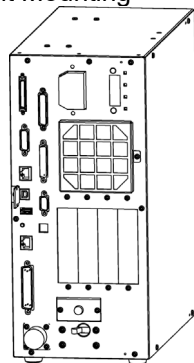

(C) Rack Mounting

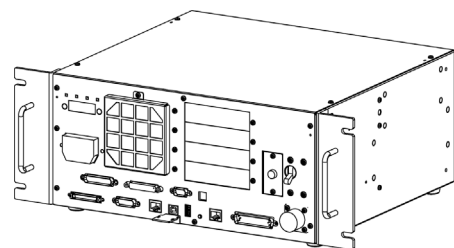

* A plate for rack mounting is required.

* The rubber foot needs to be replaced.

NOTE For Controller installation to the Controller box or the base table, process screw holes as follows.

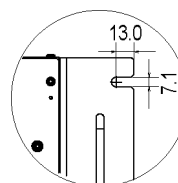
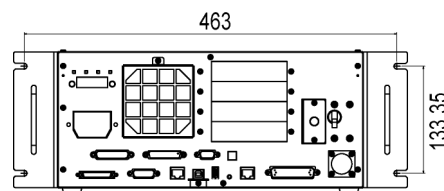

- Ensure the draft around the in/out and prevent the other equipment, walls and install the Controller by keeping the distance as follows for maintenance.

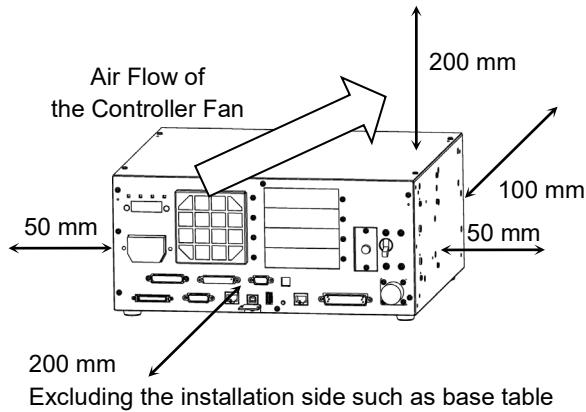

- Hot air with higher temperature than the ambient temperature (about 10 °C) comes out from the Controller. Make sure that heat sensitive devices are not placed near the outlet.
- Arrange the cables in front of the Controller so that you can pull the Controller forward.

3.2.3 Wall Mounting Option

The control unit has a wall mounting option. This section describes the installation procedure.

(Figure/Picture: RC700)

Wall mounting with the front side down

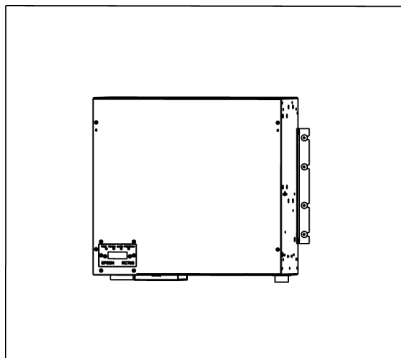

Wall mounting with the front side up

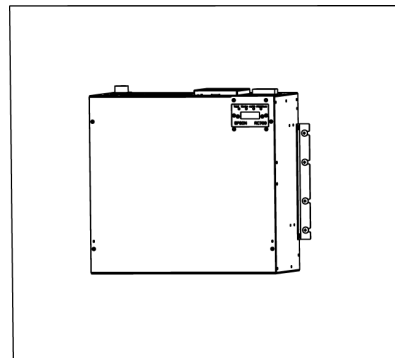

Controller outer dimensions when using the wall mounting option

Dimensions of the mounting holes for the wall

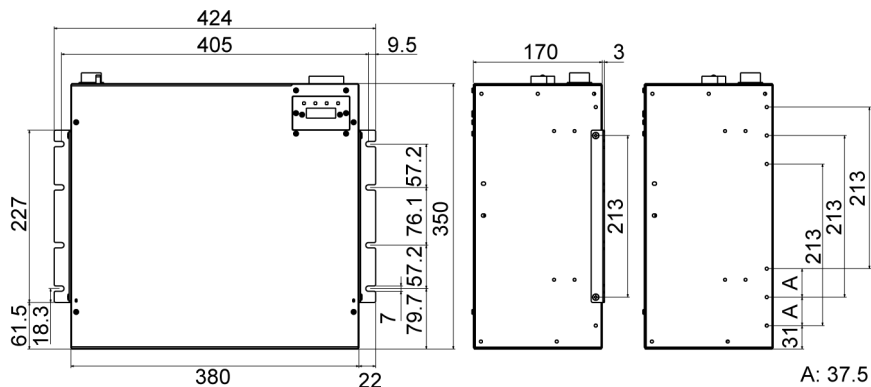

(Unit: mm)

Included items of the wall mounting option

WALL FIXING BRACKET	2 brackets
LED DISPLAY FIXING PLATE	1 plate
LED DISPLAY PLATE	1 plate
Screw (M3 × 6 mm)	4 screws
Screw (M4 × 8 mm)	4 screws

 WARNING	<ul style="list-style-type: none"> ■ Before installing the Controller with this option, always make sure that the main power of the Controller is turned OFF and that the power plug is disconnected. Performing any installation procedure while the main power is ON or the high voltage charged area is not discharged completely is extremely hazardous and may result in electric shock and/or cause serious safety problems. ■ When opening the front side, make sure to disconnect the power plug. Touching the power supply terminal block inside the Controller while the power supply is ON is extremely hazardous and may result in electric shock and/or cause serious safety problems.
---	---

- NOTE
- Be careful not to damage the cables.
 - Be careful not to drop any screws into the Controller.

(1) Remove the Top Cover Mounting screws of the Controller
(Mounting screw×6)

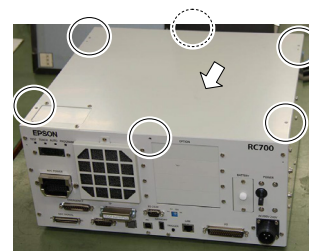

(2) Remove the Top Cover.

(3) Remove the screws fixing the seven segment display.
(Controller front side: Mounting screw×2)



(4) Remove the LED/7 segment board from the Controller.

NOTE

For RC700-A:
 The LED/7 segment board has the ferrite code
 (Reference: *Maintenance*
 7.8.2 *DMB-LED Board (RC700-A)*)
 If the LED DISPLAY PLATE is installed with
 “wall mounting with the front side up” described
 in the step (7) below, the cable which passes the
 ferrite core will be an opposite direction.
 Remove the latch of the ferrite core and change
 the cable direction, and then install the ferrite
 core again.

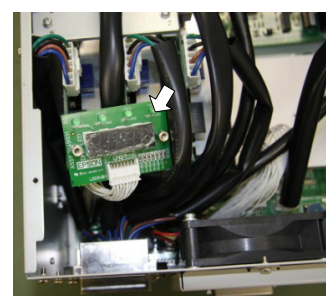

- (5) Mount the LED DISPLAY PLATE to the LED/7 segment board. (Mounting screw×2)



When installing the LED DISPLAY PLATE, be careful not to drop any screw inside the Controller.



- (6) Mount the LED DISPLAY FIXING PLATE to the Controller. (Mounting screw×2)

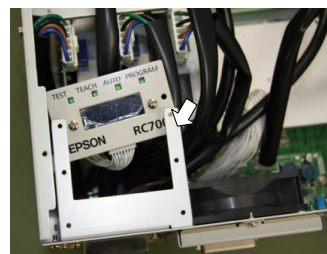

- (7) Mount the LED DISPLAY PLATE to the LED DISPLAY FIXING PLATE. (Mounting screw×2)

There are two installation methods.

Turn the LED DISPLAY PLATE horizontally to the Top Cover in the direction indicated by a red arrow.

<p>Wall mounting with the front side down</p> <p>(1) Front side</p> <p>(2) Front side</p>	<p>Wall mounting with the front side up</p> <p>(1) Front side</p> <p>(2) Front side</p>
---	---



Be careful not to pull the cable.

- (8) Remove the plate from the Top Cover.
(Mounting screw×4)



The removed plate is not necessary when using this option.
The plate may be needed when the installation type is changed.
Please keep the plate for future use.

- (9) Mount the Top Cover.
(Mounting screw×6)

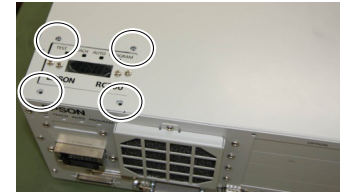

- (10) Fix the Top Cover to the LED DISPLAY FIXING PLATE.
(Mounting screw×4)

- (11) Mount the WALL FIXING BRACKET.
(Mounting screw×2 on both sides)

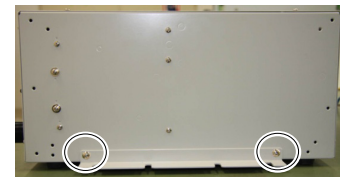

The bracket has 6 screw holes.
There are three ways of installation.



- (12) Remove the rubber hoot on the Controller's back side.
(Mounting screw×4)



The removed rubber foot is not necessary when using this option.
The rubber foot may be needed when the installation type is changed.
Please keep the rubber foot for future use.

- (13) Mount the Controller to the wall. (Mounting screw×8 M5 × 8 mm or longer)
Tightening torque 80 to 110 N·cm

3.3 Power Supply

3.3.1 Specifications

Ensure that the available power meets following specifications.

Item	Specification
Voltage	200 to 240 VAC (Input voltage should be within $\pm 10\%$ of the rated voltage.)
Phase	Single phase
Frequency	50/60 Hz
Momentary Power Interrupt	10 ms or less
Rated Capacity	<p>Maximum : 2.5 kVA Actual power consumption depends on the model, motion, and load of the Manipulator. For approximate power consumption of each model, refer to the following values.</p> <ul style="list-style-type: none"> C4 : 1.7 kVA C8 : 2.5 kVA C12 : 2.5 kVA N2 : 0.6 kVA N6 : 2.2 kVA G1 : 0.5 kVA G3 : 1.1 kVA G6 : 1.5 kVA G10 : 2.4 kVA G20 : 2.4 kVA RS3 : 1.2 kVA RS4 : 1.4 kVA <p>Refer to the Manipulator manual for rated capacity of the Manipulator motor. Rated capacity of X5 varies depending on the Manipulator model. For details, please contact the supplier of your region.</p>
Peak Current	<p>When power is turned ON : approximately 85 A (2 ms.) When motor is ON : approximately 75 A (2 ms.)</p>
Leakage Current	Max. 10 mA
Ground Resistance	100 Ω or less

Install an earth leakage circuit breaker in the AC power cable line at 15 A or less rated. Both should be a two-pole disconnect type. If you install an earth leakage circuit breaker, make sure to use an inverter type that does not operate by induction of a 10 kHz or more leakage current. If you install a circuit breaker, please select one that will handle the above mentioned "peak current".

The power receptacle shall be installed near the equipment and shall be easily accessible.

3.3.2 AC Power Cable

 WARNING	<ul style="list-style-type: none"> ■ Make sure that operations are done by a qualified personal. ■ Be sure to connect the earth wire (green/yellow) of the AC power cable to the earth terminal of the factory power supply. The equipment must be grounded properly at all times to avoid the risk of electric shock. ■ Always use a power plug or a disconnecting device for power connecting cable. Never connect the Controller directly to the factory power supply. ■ Select the plug or a disconnecting device which conform safety standards for nations.
---	---

Make sure to insert the plug of the AC power cable firmly when connecting to the Controller.

Item	Specification
AC power wire (2 cables)	Black, Black or Black, White
Ground wire	Green / Yellow
Cable length	3 m
Terminal	M4 round solderless terminal

3.4 Cable Connection



- Make sure that the power to the Controller is turned OFF and the power plug is disconnected before connecting or disconnecting any cables. Connecting or disconnecting any cables with the power ON is extremely hazardous and may result in electric shock and malfunction of the Controller.
- Be sure to connect the cables properly. Do not allow unnecessary strain on the cables. (Do not put heavy objects on the cables. Do not bend or pull the cables forcibly.) The unnecessary strain on the cables may result in damage to the cables, disconnection, and/or contact failure. Damaged cables, disconnection, or contact failure is extremely hazardous and may result in electric shock and/or improper function of the system.



- The serial number of the Manipulator that should be connected is indicated on the Connection Check Label on the Controller. Connect the Controller and the Manipulator correctly. Improper connection between the Controller and the Manipulator may cause not only improper function of the robot system but also safety problems.
- Before connecting the connector, make sure that the pins are not bent. Connecting with the pins bent may damage the connector and result in malfunction of the robot system.

3.4.1 Typical Cable Connection

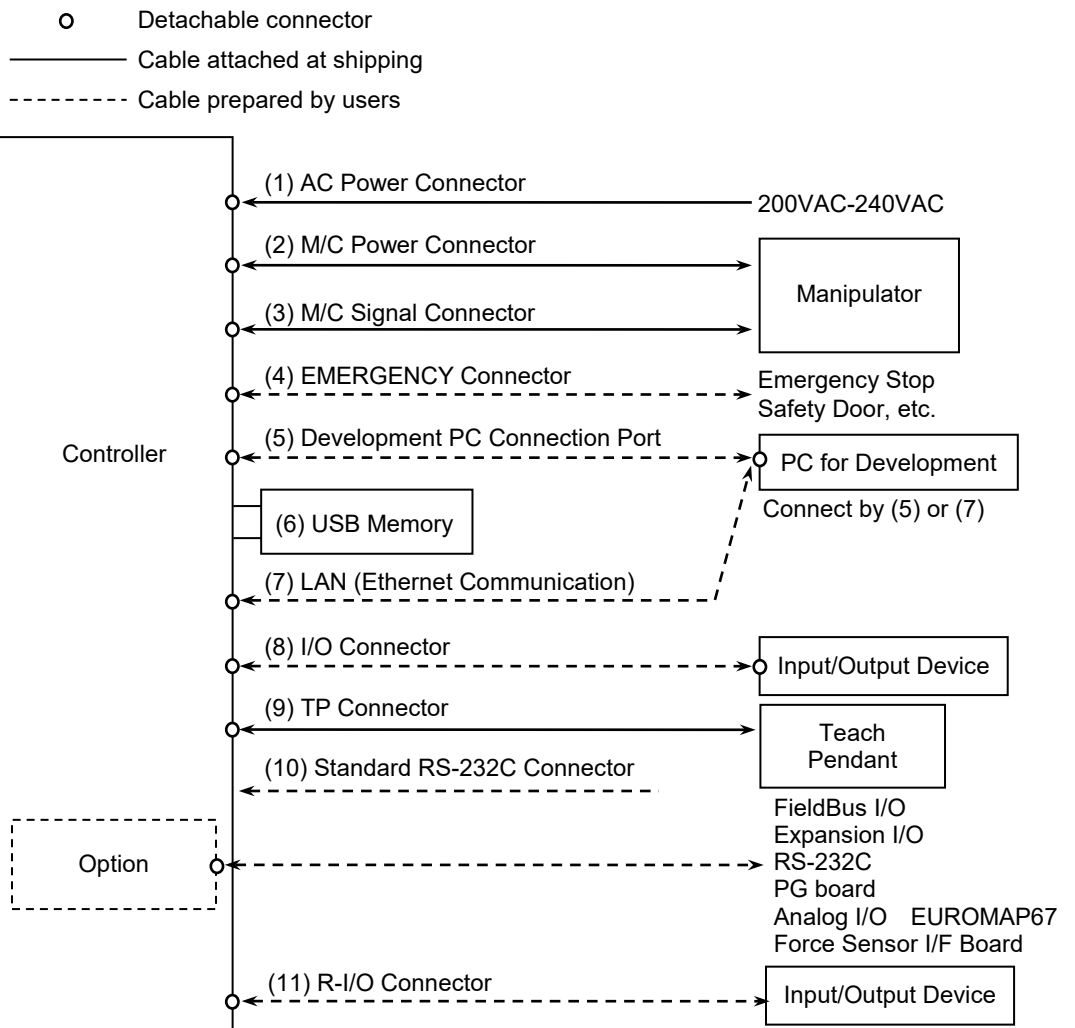

- (1) **AC Power Connector**
Connector for 200VAC power input to the Controller.
- (2) **M/C Power cable**
The cable with connector on the Controller side.
Connect the Manipulator and the M/C POWER connector on the Controller.
Insert the connectors until you hear a “click”.
- (3) **M/C Signal cable**
The cable with connector on the Controller side.
Connect the Manipulator and the M/C SIGNAL connector on the Controller.
- (4) **EMERGENCY**
The EMERGENCY connector has inputs to connect the Emergency Stop switch and the Safety Door switch. For safety reasons, connect proper switches for these input devices.
For details, refer to the *Setup & Operation 9. EMERGENCY*.
- (5) **PC for development**
Connect the PC for development.
For details, refer to the *Setup & Operation 5. Development PC Connection USB Port*.
- (6) **USB memory**
Connect the USB memory.
For details, refer to the *Setup & Operation 6. Memory Port*.
- (7) **LAN (EtherNet Communication)**
Connect the EtherNet cable.
For details, refer to the *Setup & Operation 7. LAN (Ethernet Communication) Port*.
- (8) **I/O connector**
This connector is used for input/output devices of the user.
When there are input/output devices, use this connector.
There are I/O cable (option) and terminal block (option) for the I/O connector.
For details, refer to the *Setup & Operation 11. I/O Connector*.
- (9) **TP cable**
Connect the option Teach Pendant.
For details, refer to the *Setup & Operation 8. TP Port*.
- (10) **Standard RS-232C port**
This port is used for the RS-232C communication with external devices.
For details, refer to *Setup & Operation 10. Standard RS-232C Port*.
- (11) **R-I/O Connector**
This connector is used for connecting with input signals necessary for real time I/O function.
For details, refer to the *Setup & Operation 13. R-I/O Connector*.

3.4.2 Connecting Manipulator to Controller

Connect the Manipulator to the Controller by using the Power cable and the Signal cable.

 WARNING	<ul style="list-style-type: none"> ■ Make sure that the power to the Controller is turned OFF before connecting or disconnecting any cables. Connecting or disconnecting any cables with the power ON is extremely hazardous and may result in electric shock and malfunction of the Controller. ■ Be sure to connect the cables properly. Do not allow unnecessary strain on the cables. (Do not put heavy objects on the cables. Do not bend or pull the cables forcibly.) The unnecessary strain on the cables may result in damage to the cables, disconnection, and/or contact failure. Damaged cables, disconnection, or contact failure is extremely hazardous and may result in electric shock and/or improper function of the system.
---	--

 CAUTION	<ul style="list-style-type: none"> ■ The serial number of the Manipulator that should be connected is indicated on the Connection Check Label on the Controller. Connect the Controller and the Manipulator correctly. Improper connection between the Controller and the Manipulator may cause not only improper function of the robot system but also safety problems. ■ When connecting the Manipulator to the Controller, make sure that the serial numbers on each equipment match. Improper connection between the Manipulator and Controller may not only cause improper function of the robot system but also serious safety problems. The connection method varies with the Controller used. For details on the connection, refer to the Controller manual.
---	--

The configuration data for the Manipulator and Manipulator model are stored in the Controller. Therefore the Controller should be connected to the Manipulator whose serial number is specified in the Connection Check label attached on the front of the Controller.



The Manipulator's serial number is indicated on the signature label on the back of the Manipulator.

3.5 Noise Countermeasures

To minimize electrical noise conditions, the following items must be observed in the system's cable wiring:

To minimize electrical noise condition, be sure of followings for wiring.

- The earth wire of the power supply should be grounded. (Ground resistance: 100 Ω or less) It is important to ground the frame of Controller not only for prevention from electric shock, but also for reducing the influence of electric noise around the Controller. Therefore, be sure to connect the earth wire (yellow/green) of the Controller's power cable to the ground terminal of the factory power supply. For details about the plug and AC power cable, refer to the *Setup & Operation 3.3 Power Supply*.
- Do not tap power from a power line that connects to any equipment which may cause noise.
- When you tap power for the Controller and the single-phase AC motor from the same power line, change the phase of one or the other. Ensure that they will not be the same phase.
- Use a twisted pair motor power line.
- Do not run AC power lines and DC power lines in the same wiring duct, and separate them as far as possible. For example, separate the AC motor power line and the Controller power line as far as possible from the sensor or valve I/O lines; and do not bundle both sets of wiring with the same cable tie. If more than one duct/cable must cross each other, they should cross perpendicularly. The preferable example is shown in the right figure.
- Wire as short as possible to the I/O connector and EMERGENCY connector. Use a shielded cable and clamp the shield to the attached connector interior. Make sure to keep away from the peripheral noise source as far as possible.
- Make sure that the induction elements used to connect to the Controller's I/O (such as relays and solenoid valves) are noise suppression parts. If an induction element without protection against noise is used, make sure to connect a noise suppression part such as a diode located at the induction element in parallel with it. In selecting noise suppression parts, make sure that they can handle the voltage and current incurred by the induction load.
- To start and change revolutions of the conveyer's (or the like's) AC motor (ex: an induction motor or three-phase induction motor) regularly or abruptly, make sure to install a spark suppressor between the wires. The spark suppressor is more effective when placed closer to the motor.
- As they are easily influenced by noise, keep cable such as USB, Ethernet, RS-232C, or fieldbus away from peripheral noise sources.

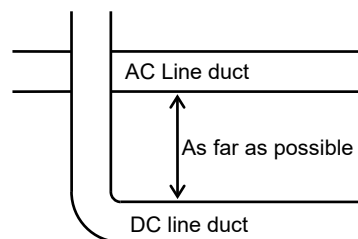

4. Operation Mode (TEACH/AUTO/TEST)

4.1 Overview

The Robot system has three operation modes.

TEACH mode This mode enables point data teaching and checking close to the Robot using the Teach Pendant.
In this mode the Robot operates in Low power status.

AUTO mode This mode enables automatic operation (program execution) of the Robot system for the manufacturing operation, and also programming, debug, adjustment, and maintenance of the Robot system.
This mode cannot operate the Robots or run programs with the Safety Door open.

TEST mode

(T1) This mode enables program verification while the Enable Switch is held down and the safeguard is open.
This is a low speed program verification function (T1: manual deceleration mode) which is defined in Safety Standards.
This mode can operate the specified Function with multi-task / single-task, multi-Manipulator / single-Manipulator at low speed.

(T2) This mode enables program verification while the Enable Switch is held down and the safeguard (including the safety door) is open.
Unlike the TEST/T1, the program verification in a high speed is available in this mode.
In this mode, the specified Function can be executed with multi-task / single-task, multi-Manipulator / single-Manipulator at high speed.

NOTE



T2 mode cannot be used on RC700-A Controllers complying with the UL standards.

4.2 Switch Operation Mode

Change the operation mode using the mode selector key switch on the Teach Pendant.

To change to TEST operation mode:

TP1, TP2 : Push the function key in TEACH mode.

TP3 : Tap the [Test] tab on the touch panel in TEACH mode.

TEACH mode Turn the mode selector key switch to “TEACH” for TEACH mode.
 Pauses the executing program when operation mode is switched to TEACH mode.
 The operating Robot stops by Quick Pause.

AUTO mode Turn the mode selector key switch to “AUTO” and change the latch release input signal to ON position for AUTO mode.

TEST mode

TP1, TP2 Turn the mode selector key switch to “TEACH” for “TEACH” mode.
 Push <F1> key-[Test Mode] in [Jog & Teach] dialog of TEACH mode. The mode will be changed to TEST.

TP3 T1 Turn the mode selector key switch to “TEACH/T1” for “TEACH” mode. Tap the [Test] tab to change the mode to T1.
 T2 Turn the mode selector key switch to “TEACH/T2” for “TEACH” mode. Tap the [Test] tab to change the mode to T2.

NOTE



The TEACH mode status is latched by software.

To switch the mode from TEACH to AUTO, release the latched condition using the latch release input.

For details on how to release latch, refer to *Setup & Operation 9.1 Safety Door Switch and Latch Release Switch*.

NOTE



T2 mode cannot be used on RC700-A Controllers complying with the UL standards.

4.3 Program Mode (AUTO)

4.3.1 What is Program Mode (AUTO)?

Program mode is for programming, debug, adjustment, and maintenance of the Robot system.

Follow the procedures below to switch to the Program mode.

4.3.2 Setup from EPSON RC+

Switch the mode to Program mode from the EPSON RC+.

- (1) Select EPSON RC+ menu-[Setup]-[System Configuration] to display the [System Configuration] dialog.

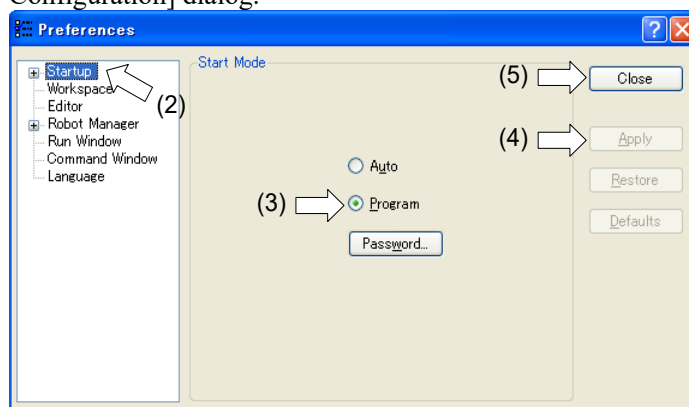

- (2) Select [Startup]-[Start mode].
- (3) Select <Program> button.
- (4) Click the <Apply> button.
- (5) Click the <Close> button.

4.4 Auto Mode (AUTO)

4.4.1 What is Auto mode (AUTO)?

Auto mode (AUTO) is for automatic operation of the Robot system.

Procedures for switching to the Auto mode (AUTO) are the followings.

A : Set the start mode of the EPSON RC+ to “Auto” and start the EPSON RC+.

(Refer to *Setup & Operation 4.4.2 Setup from EPSON RC+.*)

B : Offline the EPSON RC+.



Execute and stop the program from the control device specified by the EPSON RC+.
 (Refer to *Setup & Operation 4.4.3 Setup Control Device.*)

4.4.2 Setup from EPSON RC+

Switch the mode to Auto mode (AUTO) from the EPSON RC+.

- (1) Select EPSON RC+ menu-[Setup]-[System Configuration] to display the [System Configuration] dialog.

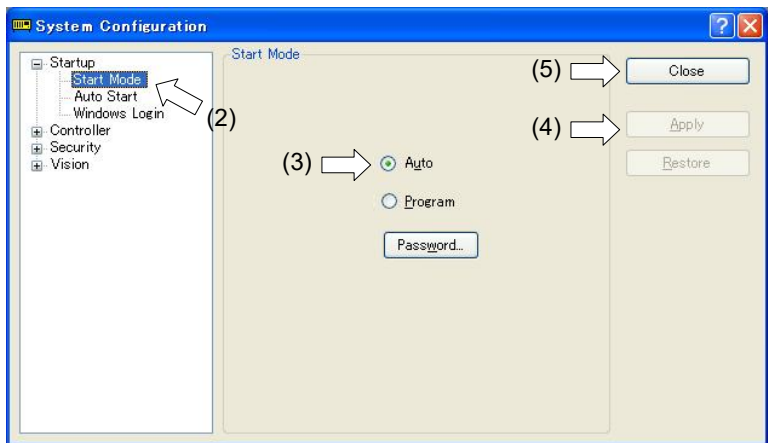

- (2) Select [Startup]-[Start Mode].
- (3) Select <Auto> button.
- (4) Click the <Apply> button.
- (5) Click the <Close> button.

4.4.3 Setup from Control Device

Set the control device from EPSON RC+.

- (1) Select EPSON RC+ menu-[Setup]-[System Configuration] to display the [System Configuration] dialog.

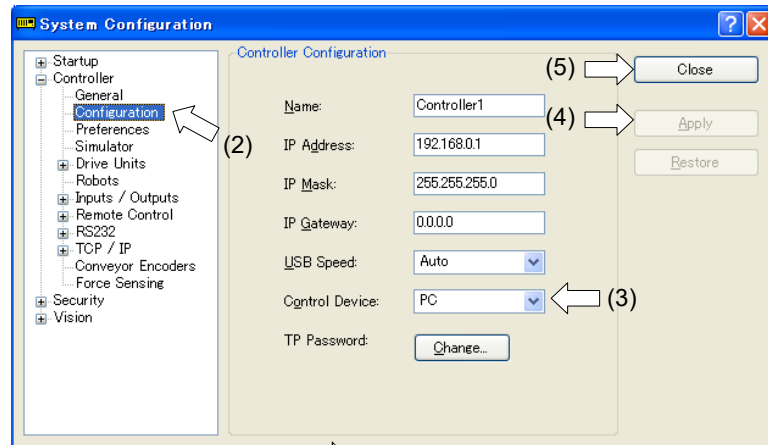

- (2) Select [Controller]-[Configuration].
- (3) Select [Setup Controller]-[Control Device] to select the control device from the following two types.
 - PC
 - Remote (I/O)
- (4) Click the <Apply> button.
- (5) Click the <Close> button.

5. Development PC Connection USB Port

Development PC connection USB port (USB B series connector)

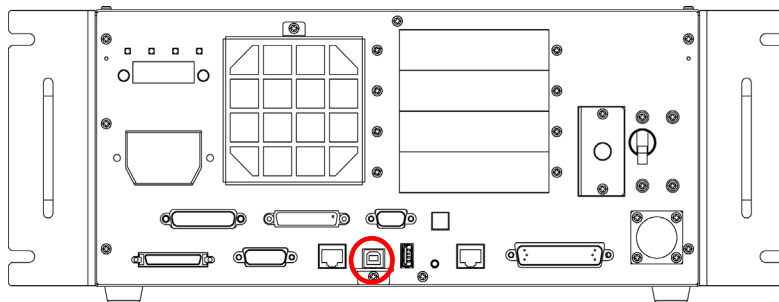

Development PC connection USB Port

(Figure: RC700)



For other details of development PC and Controller connection, refer to *EPSON RC+ 7.0 User's Guide 5.12.1 PC to Controller Communications Command*.

For RC700 / RC700-A, be sure to install the EPSON RC+ 7.0 to the development PC first, then connect the development PC and RC700 / RC700-A with the USB cable.

If RC700 / RC700-A and the development PC are connected without installing the EPSON RC+ 7.0 to the development PC, [Add New Hardware Wizard] appears. If this wizard appears, click the <Cancel> button.

5.1 About Development PC Connection USB Port

The development PC connection port supports the following USB types.

- USB2.0 HighSpeed/FullSpeed (Speed auto selection, or FullSpeed mode)
- USB1.1 FullSpeed

Interface Standard: USB specification Ver.2.0 compliant
 (USB Ver.1.1 upward compatible)

Connect the Controller and development PC by a USB cable to develop the robot system or set the Controller configuration with the EPSON RC+ 7.0 software installed in the development PC.

Development PC connection port supports hot plug feature. Cables insert and remove from the development PC and the Controller is available when the power is ON.

However, stop occurs when USB cable is removed from the Controller or the development PC during connection.

5.2 Precaution

When connecting the development PC and the Controller, make sure of the following:

- Connect the development PC and the Controller with a 5 m or less USB cable.
Do not use the USB hub or extension cable.
- Make sure that no other devices except the development PC are used for development PC connection port.
- Use a PC and USB cable that supports USB2.0 HighSpeed mode to operate in USB2.0 HighSpeed mode.
- Do not pull or bend the cable strongly.
- Do not allow unnecessary strain on the cable.

- When the development PC and the Controller are connected, do not insert or remove other USB devices from the development PC. Connection with the Controller may be lost.

5.3 PC and Controller Connection Using Development PC Connection USB Port

Connection of the development PC and the Controller is indicated.

- (1) Make sure that software EPSON RC+ 7.0 is installed to the Controller connected to the development PC.
(Install the software when it is not installed.)
- (2) Connect the development PC and the Controller using a USB cable.
- (3) Turn ON the Controller.
- (4) Start EPSON RC+ 7.0.
- (5) Select the EPSON RC+ 7.0 menu-[Setup]-[PC to Controller Communications] to display the [PC to Controller Communications] dialog.

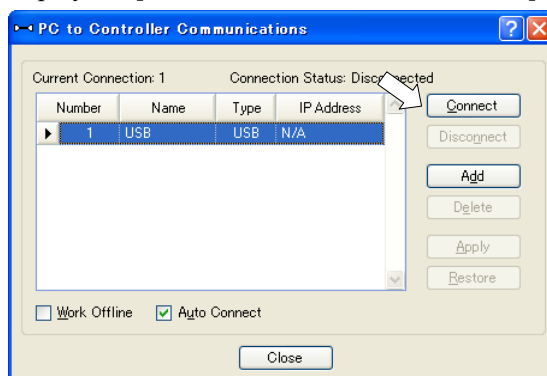

- (6) Select “No.1 USB” and click the <Connect> button.
- (7) After the development PC and the Controller connection has completed, “Connected” is displayed at [Connection status]. Make sure that “Connected” is displayed and click the <Close> button to close the [PC to Controller Communications] dialog.

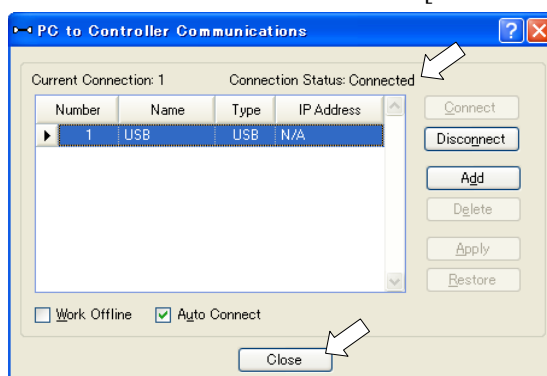

The connection between the development PC and the Controller is completed. Now the robot system can be used from EPSON RC+ 7.0.

5.4 Disconnection of Development PC and Controller

This section describes how to disconnect the development PC and the Controller communication.

- (1) Select the EPSON RC+ 7.0 menu-[Setup]-[PC to Controller Communications] to display the [PC to Controller Communications] dialog.
- (2) Click the <Disconnect> button.
Communication between the Controller and the development PC is disconnected and the USB cable can be removed.

NOTE  If the USB cable is removed when the Controller and the development PC are connected, the Robot will stop. Be sure to click the <Disconnect> button in the [PC to Controller Communications] dialog before USB cable is removed.

5.5 How to Fix USB Cable

This section describes how to fix USB cables.

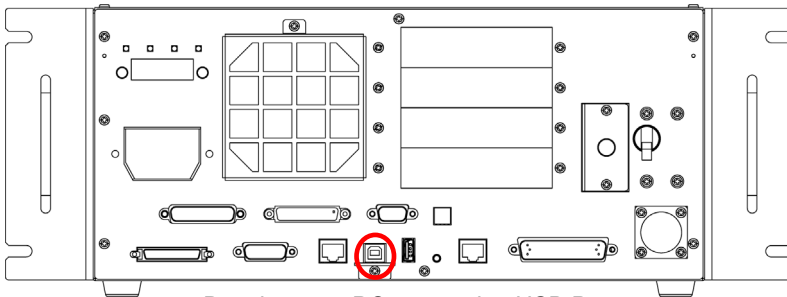

(Figure: RC700)

- (1) Unscrew the screw below the USB port.
- (2) Secure the fixing clamp (attached) using the screw in Step (1).
- (3) Connect the USB cable to the USB port.
- (4) Get an attached cable tie through a hole of the fixing clamp in Step (2) and fix the USB cable.
- (5) Adjust the length of the cable tie by cutting it.

6. Memory Port

Connect a commercial USB memory to the Controller memory port to use the Controller backup function to the USB memory.

6.1 What is Backup Controller Function?

This function saves various kinds of Controller data to the USB memory with one push. Data saved in the USB memory is loaded to EPSON RC+ 7.0 to get the status of the Controller and the program simply and accurately. The saved data can also be used for restoring the Controller.

6.2 Before Using Backup Controller Function

6.2.1 Precautions



CAUTION

- Backup Controller function is available at any time and in any Controller status after starting the Controller. However, operations from the console including stop and pause are not available while executing this function. Also, this function influences the robot cycle time and the communication with EPSON RC+ 7.0. Other than only when it is necessary, do not execute this function when operating the robot.

- Make sure that the USB port is used only for USB memory even though the port on the Controller is a universal USB port.
- Insert the USB memory directly into the Controller memory port. Connection with cables or hubs between the Controller and the USB memory is not assured.
- Insert and remove the USB memory slowly and surely.
- Do not edit the saved files by the editor. Operation of the robot system after data restoration to the Controller is not assured.

6.2.2 Adoptable USB Memory

Use USB memory that meets following conditions.

- USB2.0 supported
- Without security function
USB memory with password input function cannot be used.
- No installation of a driver or software is necessary for Windows 8, or Windows 10.
(For supported operating systems for the EPSON RC+ 7.0, refer to *Setup & Operation 1.1 System Example*.)

6.3 Backup Controller Function

6.3.1 Backup Controller with Trigger Button



- Controller status storage function is available at any time and in any Controller status after starting the Controller.
However, operations from the console including stop and pause are not available when executing this function.
Also, this function influences the robot cycle time and the communication with the EPSON RC+ 7.0. Do not execute this function while operating the robot except when it is necessary.

Use the following procedure to backup the Controller settings to USB memory.

- (1) Insert the USB memory into the memory port.
- (2) Wait approximately 10 seconds for USB memory recognition.
- (3) Press the trigger button on the Controller.

The seven-segment displays and repeatedly during the data transfer. Wait until the display returns back to the former display. (Transfer time differs depending on the amount of data, such as the project size.)

- (4) When the storage has been completed, is displayed on the seven-segment for two seconds.

When the storage has failed, is displayed on the seven-segment for two seconds.

- (5) Remove the USB memory from the Controller.



USB memory with LED is recommended to check the status changes in procedure (2).

When storage is executed during Motor ON status, it may fail to store the status. Use another USB memory or execute the storage during Motor OFF status.

6.3.2 Load Data with EPSON RC+ 7.0

The procedure to read the data stored in the USB memory by EPSON RC+ 7.0 and display the Controller status is described in the following manual.

EPSON RC+ 7.0 User's Guide 5.11.8 [Controller] Command (Tools Menu)

6.3.3 Transfer with E-mail

Follow this procedure to transfer the data by e-mail that was saved to the USB memory.

- (1) Insert the USB memory to a PC that supports sending of e-mail.
- (2) Make sure that the USB memory has following folders.
B_Controller type_serial number_backup date
→ Example: B_RC700_12345_2013-10-29-092951
- (3) Compress the folders checked in Step (2), then send them by e-mail.



Delete files that do not relate to the project before transfer.

This function is used to send the data to the system director and EPSON from the end users for problem analysis.

6.4 Details of Data

The following data files are created by the Controller backup function.

File Name	Outline	
Backup.txt	Information file for restore	File with information for Controller restore.
CurrentMnp01.PRM	Robot parameter	Saves information such as ToolSet.
CurrentStatus.txt	Save status	Saves program and I/O status.
ErrorHistory.csv	Error history	
InitFileSrc.txt	Initial setting	Saves various settings of the Controller.
MCSys01.MCD	Robot setting	Saves information of connected robot.
SrcmcStat.txt	Hardware information	Saves installation information of hardware.
ProjectName.obj	OBJ file	Result of project build. Prg file is not included.
GlobalPreserves.dat	Global Preserve variables	Saves values of Global Preserve variables.
MCSRAM.bin MCSYSTEMIO.bin MCTABLE.bin MDATA.bin SERVOSRAM.bin VXDWORK.bin	Inner information of Robot operation	
WorkQueues.dat	WorkQue information	Saves information of Queues information of the WorkQue.
All files related to project except ProjectName.obj *1	Project	Select EPSON RC+ 7.0 menu-[Setup]-[System Configuration] to display the [System Configuration] dialog. When [Include project files when status exported] check box is checked in [Controller]-[Preferences], the project file is stored. Includes program files.

*1 Storage of “All files related to project except ProjectName.obj” can be specified by a setting.

7. LAN (Ethernet Communication) Port

- NOTE  - Refer to *EPSON RC+ 7.0 User's Guide 5.12.1 PC to Controller Communications Command (Setup Menu)* for other details for the development PC and Controller connection.
- For Ethernet (TCP/IP) communication with robot application software, refer to *EPSON RC+ 7.0 Online Help* or *User's Guide 14. TCP/IP Communications*.

7.1 About the LAN (Ethernet Communication) Port

Ethernet communication port supports 100BASE-TX / 10 BASE-T.

This port is used for two different purposes.

Connection with development PC

LAN (Ethernet communication) port is used for connection of the Controller and the development PC.

Equivalent operation is available to connect between the Controller and the development PC with the development PC connection port.

(Refer to *Setup & Operation 5. Development PC Connection USB Port*)

Connection with other Controller or PC

The LAN (Ethernet communication) port can be used as an Ethernet (TCP/IP) communication port to communicate between multiple controllers from robot application software.



CAUTION

■ RC700: DUOUT connector / RC700-A: OUT connector is not a LAN (Ethernet communication) port. Do not connect a cable.

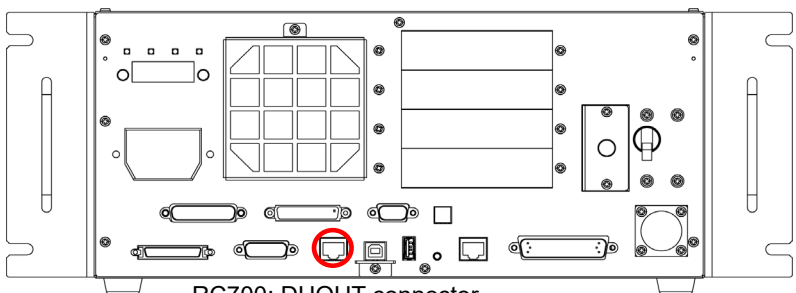

RC700: DUOUT connector
RC700-A: OUT connector

(Figure: RC700)

7.2 IP Address

From the following firmware version password authentication is required when connecting Controllers and PCs to a global accessible network.

F/W : Ver.7.4.8.x

Our robot system is provided on the assumption that customers use it in the closed local area networks. We considered the setting of the global IP address is access to the Internet and changed the specification to perform password authentication in order to secure the connections.

Password authentication is not performed in case of USB connections.

Be sure to use the following private IP addresses.

Private Address List

10.0.0.1	to	10.255.255.254
172.16.0.1	to	172.31.255.254
192.168.0.1	to	192.168.255.254

The following is the configuration of the Controller at delivery.

IP Address : 192.168.0.1
 IP Mask : 255.255.255.0
 IP Gateway : 0.0.0.0

Set separate IP addresses in the same subnet for PC and the Controller.

PC : 192.168.0.10
 Controller : 192.168.0.1

7.3 Changing Controller IP Address

This section describes the procedure to change the Controller IP address.

- (1) Connect between the development PC and the Controller using the USB cable by referring to *Setup & Operation 5. Development PC Connection USB Port*.
- (2) Select the EPSON RC+ 7.0 menu-[Setup]-[Controller] to display the following dialog.

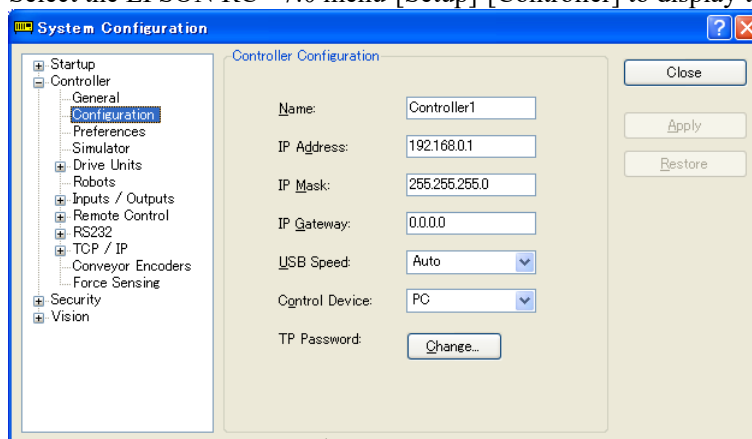

- (3) Select [Controller]-[Configuration].
- (4) Enter the proper IP address and subnet mask and click the <Apply> button.
- (5) Click the <Close> button. The Controller reboots automatically.
 IP address configuration is completed and the Controller reboot dialog disappears.

7.4 Connection of Development PC and Controller with Ethernet

Connection between the development PC and the Controller is shown below.

- (1) Connect the development PC and the Controller using the Ethernet cable.
- (2) Turn ON the Controller.
- (3) Start EPSON RC+ 7.0.
- (4) Display the [PC to Controller Communication] dialog from [Setup] in EPSON RC+ 7.0 menu.
- (5) Click the <Add> button.

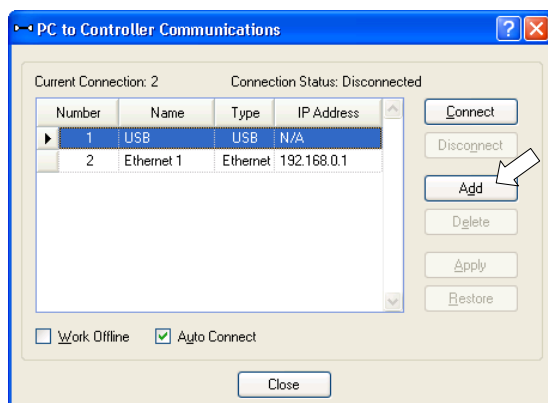

- (6) Connection “No.2” is added. Set the following and click the <Apply> button.
 Name : Valid value to identify the Controller to connect
 IP Address : IP address for Controller to connect

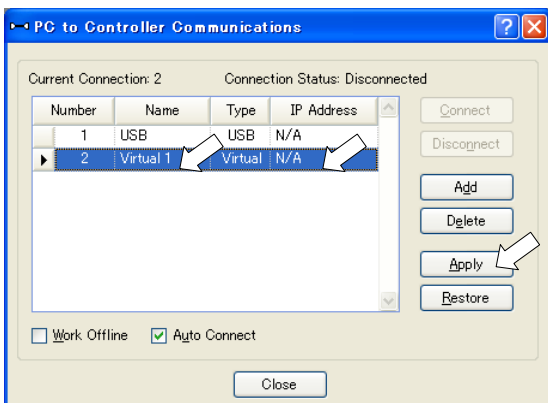

- (7) [Name] and [IP Address] specified in procedure (6) is displayed.

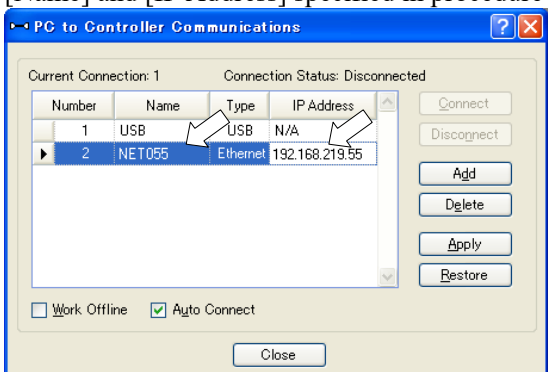

- (8) Make sure that “No.2” is selected, and click the <Connect> button.

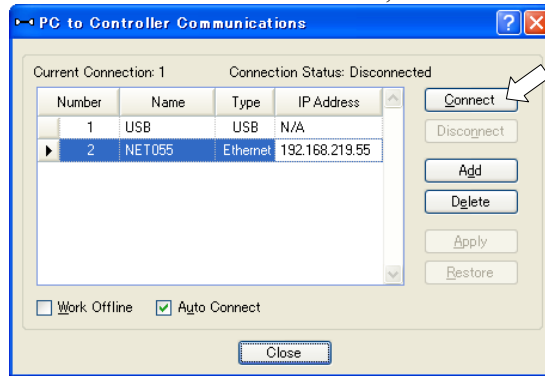

- (9) After the development PC and Controller connection is completed, “Connected” is displayed in the [Connection status:]. Make sure that “Connected” is displayed and click the <Close> button to close the [PC to Controller Communications] dialog.

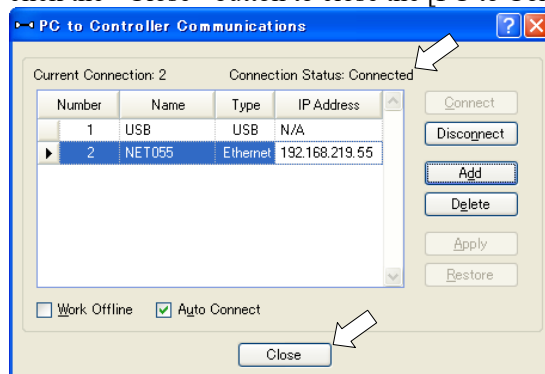

Connection between the development PC and the Controller is complete. Now the robot system can be used via an Ethernet connection from EPSON RC+ 7.0.

7.5 Disconnection of Development PC and Controller with Ethernet

Disconnection of the development PC and the Controller is shown below.

- (1) Display [PC-Controller Connection] dialog from [Setup] in EPSON RC+ 7.0 menu.
- (2) Click the <Disconnect> button.

Communication between the Controller and the development PC is disconnected and the Ethernet cable can be removed.



If the Ethernet cable is removed when the Controller and the development PC is connected, Emergency Stop occurs and the Robot stops. Be sure to click the <Disconnect> button in the [PC to Controller Communications] dialog before the Ethernet cable is removed.

8. TP Port

8.1 What is the TP Port?

The TP port connects the Teach Pendant TP1, TP2, and TP3* to the Controller.

When connecting TP1 and TP2 to RC700-A, the RC700-A conversion cable is necessary.

If you need the conversion cable, please contact the supplier of your region.

* RC700-A TP Exchange Cable : R12NZ900L6

TP3 cannot be connected to RC700.

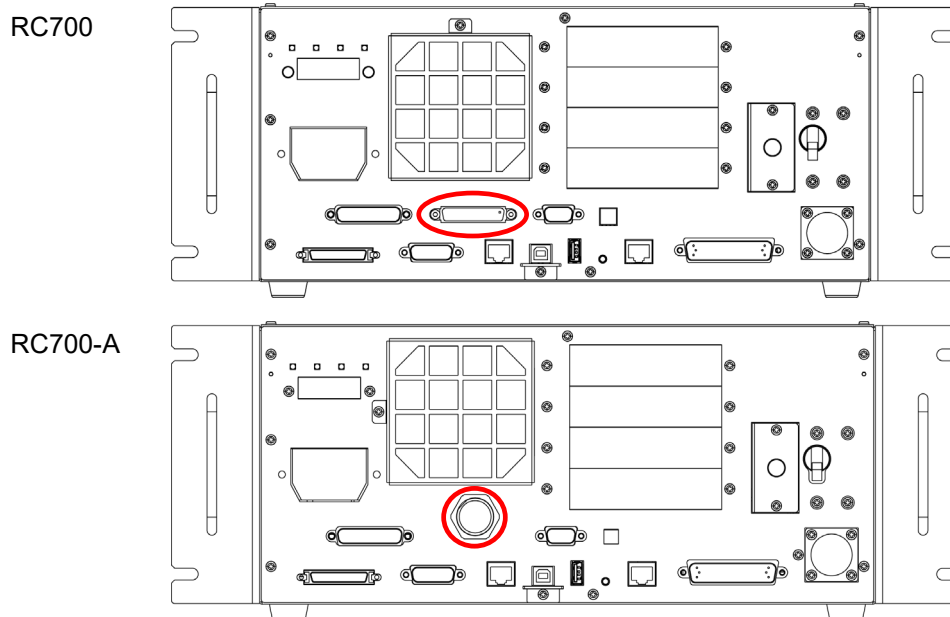

When nothing is connected to the TP port, Emergency Stop status occurs in the Controller.
 When the Teach Pendant is not connected, connect the TP bypass plug.

Do not connect the following devices to the TP port of / RC700-A. Connecting these devices may result in malfunction of the device since the pin assignments are different.

- OPTIONAL DEVICE dummy plug
- Operation Pendant OP500
- Operator Pendant OP500RC
- Jog Pad JP500
- Teaching Pendant TP-3**
- Operator Panel OP1

8.2 Teach Pendant Connection

A cable for connection to the RC700 / RC700-A Controller is attached to the Teach Pendant. Connect this cable connector to the TP/OP port.

Communication is set automatically. Enable the Teach Pendant by one of the following procedures.

- Insert the Teach Pendant connector to the Controller and turn ON the Controller.
- Insert the Teach Pendant connector while the Controller is turned ON.

NOTE



Teach Pendant connection and disconnection from the Controller are allowed when the Controller power is ON.

When the Teach Pendant connector is removed from the Controller with the mode selector key switch of the Teach Pendant in the “Teach” position, the operation mode will remain in the TEACH mode. The operation mode cannot be switched to AUTO mode. Be sure to remove the Teach Pendant after switching the operation mode to “Auto” mode.

For details, refer to the following manuals:

Robot Controller RC700/RC90 Option Teach Pendant TP1

Robot Controller RC700/RC90 Option Teach Pendant TP2

Robot Controller RC700-A Option Teach Pendant TP3

9. EMERGENCY

NOTE  The details of safety requirements for this section are described in the *User's Guide 2. Safety*. Please refer to them to keep the robot system safe.

 CAUTION	<ul style="list-style-type: none"> ■ Make sure that the emergency stop and safety door work properly before using the system, not only when setting up the system, but also when the use environment is changed.
---	---

Connect a safeguard switch or Emergency Stop switch to the Controller EMERGENCY connector for safety.

When nothing is connected to the EMERGENCY connector, the robot system does not operate normally.

 CAUTION	<ul style="list-style-type: none"> ■ Before connecting the connector, make sure that the pins are not bent. Connecting with the pins bent may damage the connector and result in malfunction of the robot system.
---	--

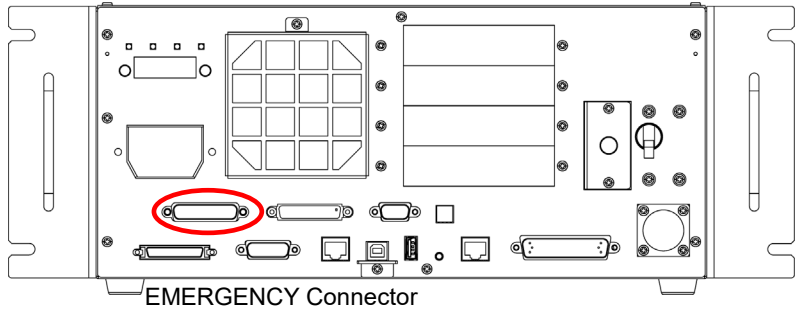

(Figure: RC700)

9.1 Safety Door Switch and Latch Release Switch

The EMERGENCY connector has input terminals for the Safety Door switch and the Emergency Stop switch. Be sure to use these input terminals to keep the system safe.

Connector	Standard
EMERGENCY connector (Controller side)	D-sub 25 male pin Screwlock #4 - 40

* The E-STOP BOX, EMERGENCY connector cable, terminal block, and EMERGENCY connector kit are offered as options.

9.1.1 Safety Door Switch

 WARNING	<ul style="list-style-type: none"> ■ The interlock of the Safety Door must be functioning when the robot system is operated. Do not operate the system under the condition that the switch cannot be turned ON/OFF (e.g. The tape is put around the switch.). Operating the robot system when the switch is not functioning properly is extremely hazardous and may cause serious safety problems as the Safety Door input cannot fulfill its intended function.
---	---

In order to maintain a safe working zone, a safeguard must be erected around the Manipulator. The safeguard must have an interlock switch at the entrance to the working zone. The Safety Door that is described in this manual is one of the safeguards and an interlock of the Safety Door is called a Safety Door switch. Connect the Safety Door switch to the Safety Door input terminal on the EMERGENCY connector.

The Safety Door switch has safety features such as temporary hold-up of the program or the operation-prohibited status that are activated whenever the Safety Door is opened.

Observe the followings in designing the Safety Door switch and the Safety Door.

- For the Safety Door switch, select a switch that opens as the Safety Door opens, and not by the spring of the switch itself.
- The signal from the Safety Door (Safety Door input) is designed to input to two redundant signals. If the signals at the two inputs differ by two seconds or more, the system recognizes it to be a critical error. Therefore, make sure that the Safety Door switch has two separate redundant circuits and that each connects to the specified pins at the EMERGENCY connector on the Controller.
- The Safety Door must be designed and installed so that it does not close accidentally.

9.1.2 Latch Release Switch

The Controller software latches these conditions:

- The safety door is open.
- The operation mode is set to "TEACH".

The EMERGENCY connector has an input terminal for a latch release switch that cancels the latched conditions.

Open : The latch release switch latches conditions that the safety door is open or the operation mode is "TEACH".

Closed : The latch release switch releases the latched conditions.



When the latched TEACH mode is released while the safety door is open, the status of Manipulator power is operation-prohibited because the safety door is open at that time.

To execute a Manipulator operation, close the safety door again, and then close the latch release input.

9.1.3 Checking Latch Release Switch Operation

After connecting the safety door switch and latch release switch to the EMERGENCY connector, be sure to check the switch operation for safety by following the procedures described below before operating the Manipulator.

- (1) Turn ON the Controller while the safety door is open in order to boot the Controller software.
- (2) Make sure that “Safety” is displayed on the main window status bar.
- (3) Close the safety door, and turn ON the switch connecting to the latch release input. Make sure that the “Safety” is dimmed on the status bar.

The information that the safety door is open can be latched by software based on the latch release input condition. To cancel the condition, close the safety door, and then close the safety door latch release input.

Open : The latch release switch latches the condition that the safety door is open.

Closed : The latch release switch does not latch the condition that the safety door is open.

NOTE



The latch release input also functions to acknowledge the change of to TEACH mode.

In order to change the latched condition of TEACH mode, turn the mode selector key switch on the Teach Pendant to “Auto”. Then, close the latch release input.

9.2 Emergency Stop Switch Connection

9.2.1 Emergency Stop Switch

If it is desired to add an external Emergency Stop switch(es) in addition to the Emergency Stop on the Teach Pendant and Operator Panel, be sure to connect such Emergency Stop switch(es) to the Emergency Stop input terminal on the EMERGENCY connector.

The Emergency Stop switch connected must comply with the related safety standards (such as IEC60947-5-5) and the following:

- It must be a push button switch that is “normally closed”.
- A button that does not automatically return or resume.
- The button must be mushroom-shaped and red.
- The button must have a double contact that is “normally closed”.

NOTE



The signal from the Emergency Stop switch is designed to use two redundant circuits. If the signals at the two circuits differ by two seconds or more, the system recognizes it as a critical error. Therefore, make sure that the Emergency Stop switch has double contacts and that each circuit connects to the specified pins on the EMERGENCY connector at the Controller. Refer to the *Setup & Operation 9.4 Circuit Diagrams*.

9.2.2 Checking Emergency Stop Switch Operation

Once the Emergency Stop switch is connected to the EMERGENCY connector, continue the following procedure to make sure that the switch functions properly. For the safety of the operator, the Manipulator must not be powered ON until the following test is completed.

- (1) Turn ON the Controller to boot the Controller software while pressing the Emergency Stop switch.
- (2) Make sure that E-STOP LED of the Controller is lighting.
- (3) Make sure that “EStop” is displayed on the status bar on the main window.
- (4) Release the Emergency Stop Switch.
- (5) Execute the RESET command.
- (6) Make sure that E-STOP LED is turned OFF and that “EStop” is dimmed on the main window status bar.

9.2.3 Recovery from Emergency Stop

To recover from the emergency stop condition, follow the procedure of safety check as required by the system.

After safety check, the operations below are required to recover from the emergency stop condition.

- Release the Emergency Stop Switch
- Execute the RESET command

9.3 Pin Assignments

The EMERGENCY connector pin assignments are as follows:

Pin No.	Signal	Function	Pin No.	Signal	Function
1	ESW11	Emergency Stop switch contact (1) *3	14	ESW21	Emergency Stop switch contact (2) *3
2	ESW12	Emergency Stop switch contact (1) *3	15	ESW22	Emergency Stop switch contact (2) *3
3	ESTOP1+	Emergency Stop circuit 1 (+) *4	16	ESTOP2+	Emergency Stop circuit 2 (+) *4
4	ESTOP1-	Emergency Stop circuit 1 (-) *4	17	ESTOP2-	Emergency Stop circuit 2 (-) *4
5	Not Used	*1	18	SDLATCH1	Safety Door Latch Release
6	Not Used	*1	19	SDLATCH2	Safety Door Latch Release
7	SD11	Safety Door input (1) *2	20	SD21	Safety Door input (2) *2
8	SD12	Safety Door input (1) *2	21	SD22	Safety Door input (2) *2
9	24V	+24V output	22	24V	+24V output
10	24V	+24V output	23	24V	+24V output
11	24VGND	+24V GND output	24	24VGND	+24V GND output
12	24VGND	+24V GND output	25	24VGND	+24V GND output
13	Not Used				

- *1 Do not connect anything to these pins.
- *2 A critical error occurs if the input values from the Safety Door 1 and Safety Door 2 are different for two or more seconds. They must be connected to the same switch with two sets of contacts.
- *3 A critical error occurs if the input values from the Emergency Stop switch contact 1 and Emergency Stop switch contact 2 are different for two or more seconds. They must be connected the same switch with two sets of contacts.
- *4 Do not apply reverse voltage to the Emergency Stop circuit.

Emergency Stop switch output rated load	+30 V 0.3 A or under	1-2, 14-15 pin
Emergency Stop rated input voltage range Emergency Stop rated input current	+24 V ±10% 37.5 mA ±10% /+24 V input	3-4, 16-17 pin
Safety Door rated input voltage range Safety Door rated input current	+24 V ±10% 10 mA/+24 V input	7-8, 20-21 pin
Latch Release rated input voltage range Latch Release rated input current	+24 V ±10% 10 mA/+24 V input	18-19 pin

NOTE  The total electrical resistance of the Emergency Stop switches and their circuit should be 1 Ω or less.

 CAUTION	<ul style="list-style-type: none"> ■ The 24 V output is for emergency stop. Do not use it for other purposes. Doing so may result in system malfunction. ■ Do not apply reverse voltage to the Emergency Stop circuit. Doing so may result in system malfunction.
---	---

9.4 Circuit Diagrams

9.4.1 Example 1: External emergency stop switch typical application

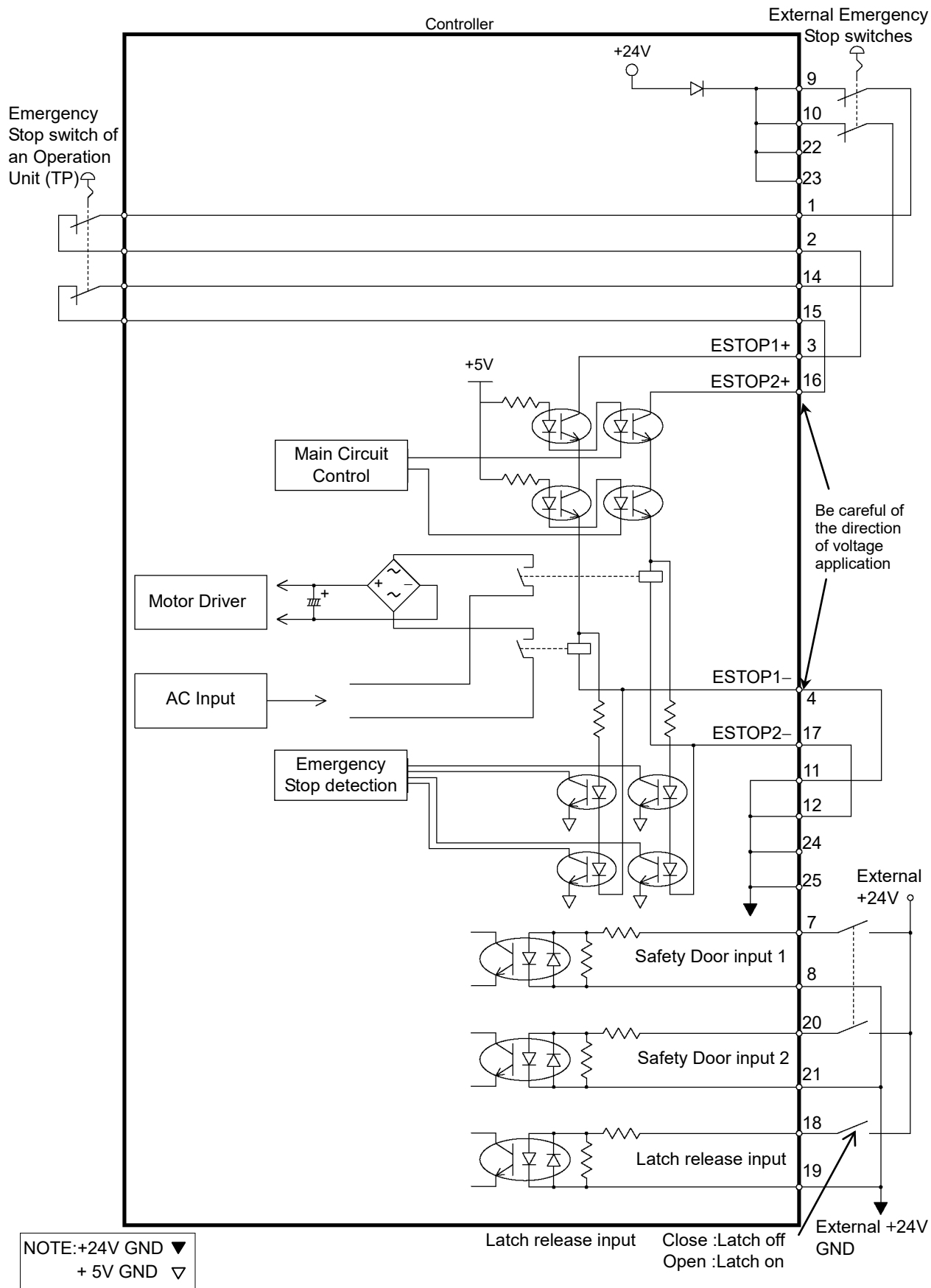

9.4.2 Example 2: External safety relay typical application

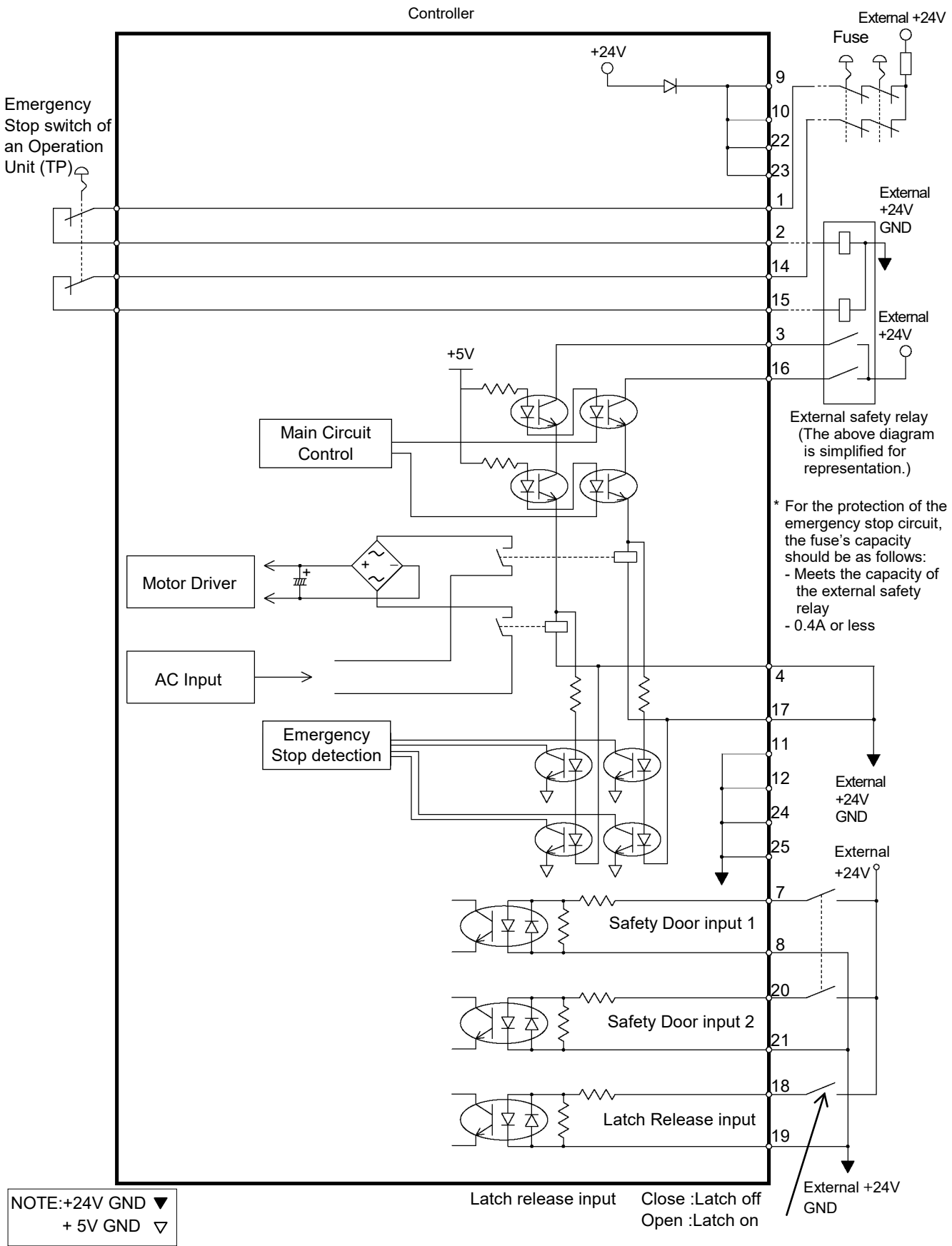

10. Standard RS-232C Port

10.1 RS-232C Port

A standard RS-232C port is available with the Controller.

Mount the RS-232C board(s) in the option slot to communicate with external equipment with two or more RS-232C ports.

For the details of the expansion port, refer to *Setup & Operation 14.4 RS-232C Board*.

Port numbers are assigned as follows.

Port No.	Supported hardware
#1	Standard RS-232C connector
#2	First expansion RS-232C board CH1
#3	First expansion RS-232C board CH2
#4	Second expansion RS-232C board CH1
#5	Second expansion RS-232C board CH2

10.2 Confirmation with EPSON RC+ 7.0 (RS-232C)

When an RS-232C board is mounted in as option unit, the Controller software automatically identifies the RS-232C board. Therefore, no software configuration is needed. Correct identification can be confirmed from EPSON RC+ 7.0.

- (1) Select the EPSON RC+ 7.0 menu-[Setup]-[System Configuration] to display the [System Configuration] dialog.

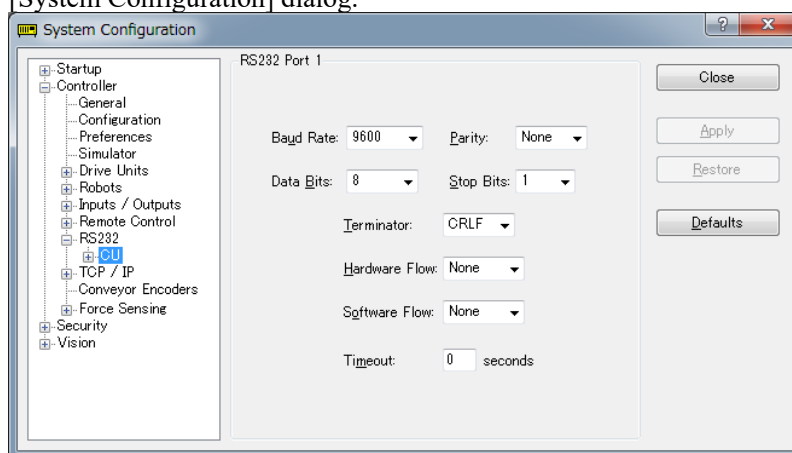

- (2) Select the [RS232]-[CU].

10.3 RS-232C Software Communication Setup (RS-232C)

Available communication settings are as follows.

Item	Specification
Baud Rates	110, 300, 600, 1200, 2400, 4800, 9600, 14400, 19200, 38400, 57600, 115200
Data bit length	7, 8
Stop bit length	1, 2
Parity	Odd, even, NA
Terminator	CR, LF, CRLF

Refer to *EPSON RC+ 7.0 Online Help* or *Users Guide – 13. RS-232C Communications* for RS-232C communication from the Robot application.

10.4 Communication Cable (RS-232C)

Prepare a communication cable as described in this section.

Connector	Standard
RS-232C Connector (Controller side)	D-sub 9 male pin Screwlock #4 - 40

NOTE



Use twisted pair cable for shielded wire.

Clamp the shield to the hood for noise prevention.

Pin assign of the RS-232C connector is as follows.

Pin No	Signal	Function	Signal Direction
1	DCD	Data carrier detect	Input
2	RXD	Receive data	Input
3	TXD	Send data	Output
4	DTR	Terminal ready	Output
5	GND	Signal ground	-
6	DSR	Data set ready	Input
7	RTS	Request to send	Output
8	CTS	Clear to send	Input
9	RI	Ring indicator	Input

11. I/O Connector

The I/O connector is for connecting your input/output equipment to the system.

		Pins	Bit number
Control Unit	Input	24	0 to 23
	Output	16	0 to 15
Drive Unit 1	Input	24	32 to 55
	Output	16	32 to 47
Drive Unit 2	Input	24	256 to 279
	Output	16	256 to 271
Drive Unit 3	Input	24	288 to 311
	Output	16	288 to 303

Refer to *Setup & Operation 14.2. Expansion I/O board.*

For cable wiring, refer to the *Setup & Operation 3.5 Noise Countermeasures* in order to prevent noise.

Remote function is initially assigned to both input and output from 0 to 7. For further details, refer to *Setup & Operation 12. I/O Remote Settings.*

11.1 Input Circuit

Input Voltage Range	: +12 to 24 V \pm 10%
ON Voltage	: +10.8 V (min.)
OFF Voltage	: +5 V (max.)
Input Current	: 10 mA (TYP) at +24 V input

Two types of wiring are available for use with the two-way photo coupler in the input circuit.

Typical Input Circuit Application 1

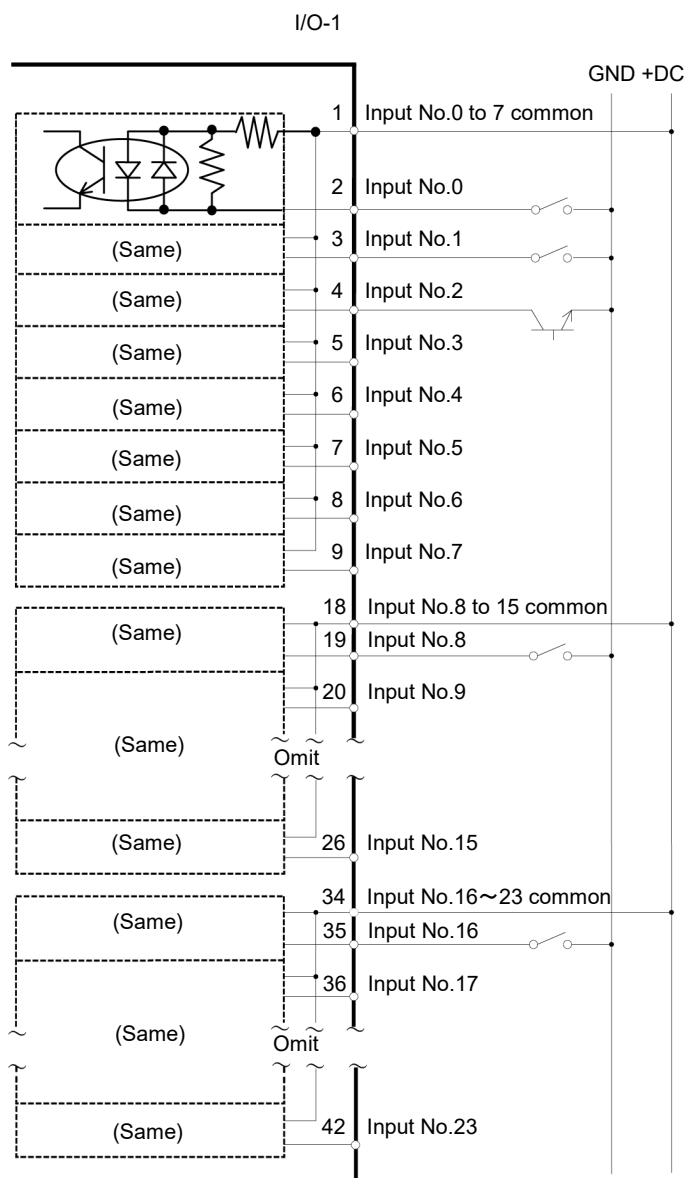

Typical Input Circuit Application 2

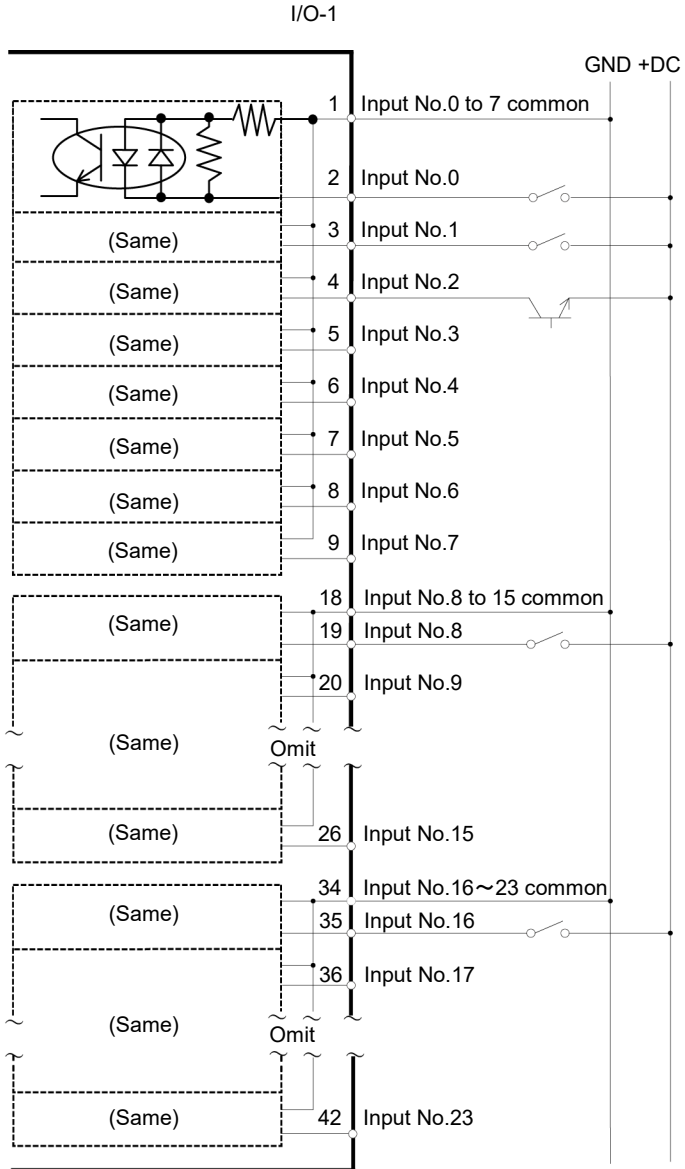

11.2 Output Circuit

Rated Output Voltage : +12 V to 24 V $\pm 10\%$

Maximum Output Current : TYP 100 mA/1 output

Output Driver : PhotoMOS Relay

On-State Resistance (average) : 23.5 Ω or less

Two types of wiring are available for use with the nonpolar PhotoMOS relay in the output circuit.

Typical Output Circuit Application 1: Sink Type (NPN)

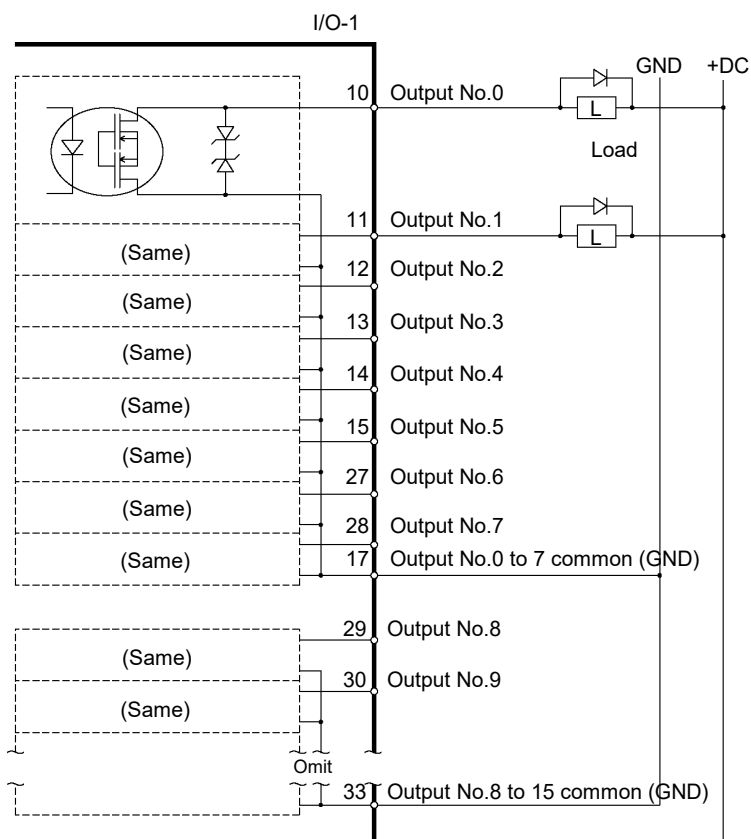

Typical Output Circuit Application 2: Source Type (PNP)

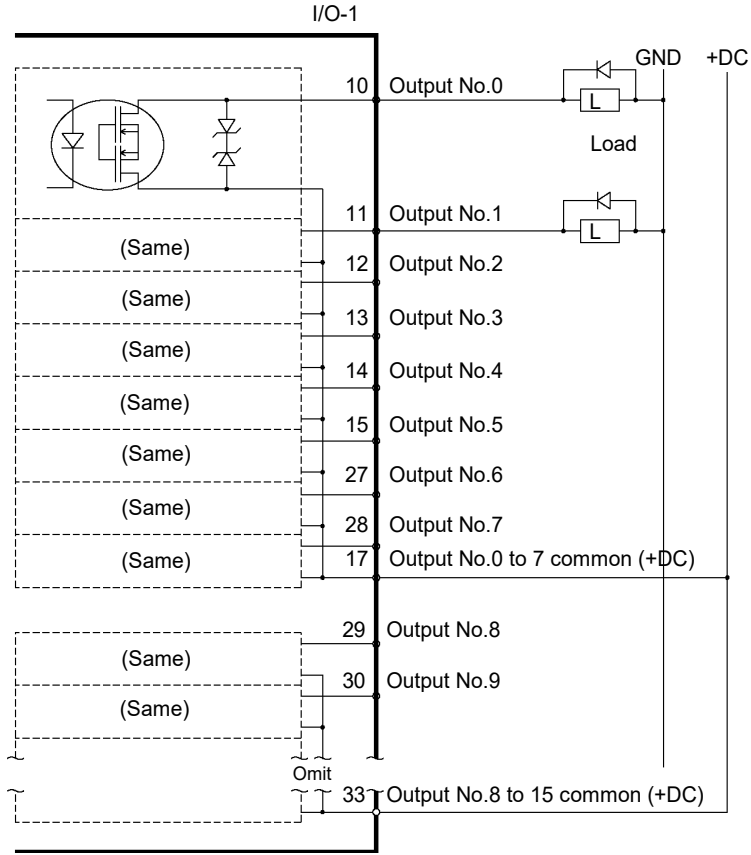

11.3 Pin Assignments

Pin No.	Signal Name	Pin No.	Signal Name	Pin No.	Signal Name
1	Input common No. 0 to 7	18	Input common No. 8 to 15	34	Input common No. 16 to 23
2	Input No. 0 (Start)	19	Input No. 8	35	Input No. 16
3	Input No. 1 (SelProg1)	20	Input No. 9	36	Input No. 17
4	Input No. 2 (SelProg2)	21	Input No. 10	37	Input No. 18
5	Input No. 3 (SelProg4)	22	Input No. 11	38	Input No. 19
6	Input No. 4 (Stop)	23	Input No. 12	39	Input No. 20
7	Input No. 5 (Pause)	24	Input No. 13	40	Input No. 21
8	Input No. 6 (Continue)	25	Input No. 14	41	Input No. 22
9	Input No. 7 (Reset)	26	Input No. 15	42	Input No. 23
10	Output No. 0 (Ready)	27	Output No. 6 (SError)	43	Output No.11
11	Output No. 1 (Running)	28	Output No. 7 (Warning)	44	Output No.12
12	Output No. 2 (Paused)	29	Output No. 8	45	Output No.13
13	Output No. 3 (Error)	30	Output No. 9	46	Output No.14
14	Output No. 4 (EstopOn)	31	Output No.10	47	Output No.15
15	Output No. 5 (SafeguardOn)	32	Not Used	48	Not Used
16	Not Used	33	Output common No. 8 to 15	49	Not Used
17	Output common No. 0 to 7			50	Not Used

Remote function inside () in the table above is initially assigned to both input and output from 0 to 7. For further details, refer to *12. I/O Remote Settings*.

Connector	Standard
I/O Connector (Controller side)	D-sub 50 male pin Screwlock #4 - 40

* The I/O connector, I/O cable, and terminal block are offered as options.

* I/O connector is included with shipment.

12. I/O Remote Settings

This section describes the functions and timings of input and output signals.

The remote functions may be assigned to your standard I/O board(s), expansion I/O board(s), or fieldbus I/O board(s) to enhance robot system control - either from an operational unit of your choice or a sequencer.

Remote function is initially assigned to both input and output from 0 to 7.

To accept external remote inputs, assign the remote function and the control device is remote.

The user defines the I/O number that a remote function is assigned to using software configuration.

For details about communication with external equipment, refer to *EPSON RC+ 7.0 User's Guide – 12. Remote Control*.



- When using remote I/O, always make sure of the followings. Using the robot system under unsatisfactory conditions may cause malfunction of the system and/or safety problems.
 - Assign remote functions to inputs/outputs correctly and wire correctly when setting up remote I/O signals.
 - Make sure that the functions correspond to the correct input/output signals before turning ON the system.
 - When verifying the robot system operation, prepare for failures with initial settings or wiring. If the Manipulator functions unusually by the failures with initial settings or wiring, press the Emergency Stop switch immediately to stop the Manipulator.

NOTE



Remote function is available when virtual I/O is enabled.

When you set up a remote I/O signal, please either keep a written record of the settings or store the data in a file for later reference.

When you set up a fieldbus I/O signal to the remote function, response depends on the baud rate of the fieldbus. For details of fieldbus response, refer to the following manual:

Robot Controller RC700/RC90 option Fieldbus I/O

12.1 I/O Signal Description

Remote function is initially assigned to both input and output from 0 to 7.

To change the function assignment from the initial setting, use EPSON RC+ 7.0.

To use all signals, you will need to add Expansion I/O or Fieldbus I/O board(s).

12.1.1 Remote Input Signals

Remote inputs are used to control the Manipulators and start programs. Certain conditions must be met before inputs are enabled, as shown in the table below.

To accept external remote inputs, assign the remote function and set remote to the control device. When external remote input is available, “AutoMode output” turns ON.

Except “SelProg”, the signals execute each function when the signal starts in input acceptance condition. The function executes automatically. Therefore, no special programming is needed.

NOTE



When an error occurs, you must execute a “Reset” to clear the error condition before any other remote input commands can be executed. Use the “Error output” and “Reset input” to monitor the error status and clear error conditions from the remote device.

Name	Default	Description	Input Acceptance Condition (*1)
Start	0	Execute function selected at SelProg. (*2)	Ready output ON Error output OFF EStopOn output OFF SafeguardOn output OFF Pause input OFF Stop input OFF
SelProg1	1	Specify the executing Main function number. (*2)	
SelProg2	2		
SelProg4	3		
SelProg8	Not Set		
SelProg16	Not Set		
SelProg32	Not Set		
Stop	4	All tasks and commands are stopped.	
Pause	5	All tasks are paused. (*3)	Running output ON
Continue	6	Continue the paused task.	Paused output ON Pause input OFF Stop input OFF
Reset	7	Reset emergency stop and error. (*4)	Ready output ON
Shutdown	Not Set	Terminates the system.	
ForcePowerLow	Not Set	Operates as the forced low power function. The robot is operated in the low power mode. Power High control from the command is not accepted. Executes the following according to the Controller preferences. Stops or temporarily stops all the tasks and commands. (*12)	Any time This input is acceptable even AutoMode output is OFF.

Name	Default	Description	Input Acceptance Condition (*1)
SelRobot	Not Set	Changes the output condition of MotorsOn, AtHome, PowerHigh, and MCalReqd. (*9)	
SelRobot1 SelRobot2 SelRobot4 SelRobot8 SelRobot16	Not Set	Specify the number of robot which executes a command. (*5)	
SetMotorOn	Not Set	Turn ON robot motors. (*5) (*6)	Ready output ON EStopOn output OFF SafeguardOn output OFF SetMotorOff input OFF
SetMotorOff	Not Set	Turn OFF robot motors. (*5)	Ready output ON
SetPowerHigh	Not Set	Set the robot power mode to High (*5)	Ready output ON EStopOn output OFF SafeguardOn output OFF SetPowerLow input OFF
SetPowerLow	Not Set	Set the robot power mode to Low. (*5)	Ready output ON
Home	Not Set	Move the Robot Arm to the home position defined by the user.	Ready output ON Error output OFF EStopOn output OFF SafeguardOn output OFF MotorsOn output ON Pause input OFF Stop input OFF
MCal	Not Set	Execute MCal (*5) (*7)	Ready output ON Error output OFF EStopOn output OFF SafeguardOn output OFF MotorsOn output ON Pause input OFF Stop input OFF
Recover	Not Set	After the safeguard is closed, recover to the position where the safeguard is open.	Paused output ON Error output OFF EStopOn output OFF SafeguardOn output OFF RecoverReqd output ON Pause input OFF Stop input OFF
ResetAlarm	Not Set	Cancel the alarm (*11)	
SelAlarm1 SelAlarm2 SelAlarm4 SelAlarm8	Not Set	Specify the alarm number to cancel (*10)	
ALIVE	Not Set	Input signal for alive monitoring of the Controller. Same signal as the input will be output to ALIVE output. The master equipment can perform alive monitoring of the Controller by switching the input periodically and checking the output signal.	

(*1) “AutoMode output” ON is omitted from the table. This is an input acceptance condition for all functions.

(*2) “Start input” executes Function specified by the following six bits: SelProg 1, 2, 4, 8, 16, and 32.

Function	SelProg1	SelProg2	SelProg4	SelProg8	SelProg16	SelProg32
Main	0	0	0	0	0	0
Main1	1	0	0	0	0	0
Main2	0	1	0	0	0	0
Main3	1	1	0	0	0	0
⋮						
Main60	0	0	1	1	1	1
Main61	1	0	1	1	1	1
Main62	0	1	1	1	1	1
Main63	1	1	1	1	1	1

0=OFF, 1=ON

(*3) “NoPause task” and “NoEmgAbort task” do not pause.

For details, refer to EPSON RC+ 7.0 *Online Help* or *Pause* in *SPEL+ Language Reference*.

(*4) Turns OFF the I/O output and initializes the robot parameter.

For details, refer to EPSON RC+ 7.0 *Online Help* or *Reset* in *SPEL+ Language Reference*.

(*5) The values specified by “SelRobot1, 2, 4, 8, and 16” correspond to the robot numbers.

Robot number	SelRobot1	SelRobot2	SelRobot4	SelRobot8	SelRobot16
0(All)	0	0	0	0	0
1	1	0	0	0	0
2	0	1	0	0	0
3	1	1	0	0	0
⋮					
13	1	0	1	1	0
14	0	1	1	1	0
15	1	1	1	1	0
16	0	0	0	0	1

0=OFF, 1=ON

(*6) Initializes the robot parameter.

For details, refer to EPSON RC+ 7.0 *Online Help* or *Motor* in *SPEL+ Language Reference*.

(*7) For details, refer to EPSON RC+ 7.0 *Online Help* or *MCal* in *SPEL+ Language Reference*.

(*8) This is for experienced users only. Make sure that you fully understand the input specification before using.

CmdRunning output and CmdError output will not change for this input.

“NoEmgAbort task” will not stop by this input.

When the input changes from ON to OFF, all tasks and commands will stop.

(*9) This function changes the output condition of MotorsOn, AtHome, PowerHigh, and MCalReqd.

By setting this signal with the condition selected using SelRobot1 - SelRobot16, you can switch the output condition.

Once you select the condition, it will be kept until you change it or turn OFF / restart the Controller.

All Manipulators are selected as default.

(*10) The values specified by “SelAlarm1, 2, 4, and 8” correspond to the alarm numbers.

Alarm #	Target	SelAlarm1	SelAlarm2	SelAlarm4	SelAlarm8
1	Controller battery	1	0	0	0
2	Battery of the robot connected to CU	0	1	0	0
3	Grease of the robot connected to CU	1	1	0	0
4	Battery of the robot connected to DU1	0	0	1	0
5	Grease of the robot connected to DU1	1	0	1	0
6	Battery of the robot connected to DU2	0	1	1	0
7	Grease of the robot connected to DU2	1	1	1	0
8	Battery of the robot connected to DU3	0	0	0	1
9	Grease of the robot connected to DU3	1	0	0	1

0=OFF, 1=ON

The following parts are subject to grease up.

6-axis robot: Bevel gear on the Joint #6

SCARA, RS series: Ball screw spline unit on the Joint # 3

(*11) The specified alarm can be canceled by selecting the conditions using SelAlarm1-SelAlarm8 and setting this signal.

(*12) Operation of all tasks and commands, power mode of the robot, and PowerHigh command are executed by the setting value of the controller preferences.

Preferences (1): “Motor power low when ForcePowerLow signal OFF”

Preferences (2): “ForcePowerLow signal change pauses all tasks”

For details of the Controller preferences, refer to *EPSON RC+ 7.0 User's Guide*

[Setup]-[System Configuration]-[Controller]-[Preferences] in 5.12.2 [System Configuration] Command (Setup Menu).

Preferences (1)	Preferences (2)	ForcePowerLow	All tasks and commands	Power mode	PowerHigh
0	0	1→0	Stop	Low only	Accept
0	0	0→1	Stop	Low only	Not accept
0	1	1→0	Continue	High/Low	Accept
0	1	0→1	Temp. stop	Low only	Not accept
1	0	1→0	Stop	Low only	Not accept
1	0	0→1	Stop	Low only	Accept
1	1	1→0	Temp. stop	Low only	Not accept
1	1	0→1	Continue	High/Low	Accept

12.1.2 Remote Output Signals

Remote outputs provide status for the Manipulator and Controller.

Remote outputs provide the assigned function using with any control device. The outputs execute automatically. Therefore, no special programming is needed.

Name	Initial	Description
Ready	0	Turns ON when the Controller startup completes and no task is running.
Running	1	Turns ON when task is running. However, turns OFF when "Paused output" is ON.
Paused	2	Turns ON when pause task exists.
Error	3	Turns ON when an error occurs. Use "Reset input" to recover from the error.
EStopOn	4	Turns ON at Emergency Stop.
SafeguardOn	5	Turns ON when the safeguard is open.
SError	6	Turns ON when critical error occurs. When a critical error occurs, "Reset input" does not function. Reboot the Controller to recover.
Warning	7	Turns ON when warning occurs. The task runs as normal with the warning. However, be sure to eliminate the cause of the warning as soon as possible.
MotorsOn	Not set	Turns ON when the robot motor is ON. (*5)
AtHome	Not set	Turns ON when the robot is in the home position. (*5)
PowerHigh	Not set	Turns ON when the robot's power mode is High. (*5)
MCalReqd	Not set	Turns ON when the robot hasn't executed MCal. (*5)
RecoverReqd	Not set	Turns ON when at least one robot is waiting for Recover after the safeguard is closed.
RecoverInCycle	Not set	Turns ON when at least one robot is executing Recover.
CmdRunning	Not set	Turns ON when an input command is executing.
CmdError	Not set	Turns ON when an input command cannot be accepted.
CurrProg1 CurrProg2 CurrProg4 CurrProg8 CurrProg16 CurrProg32	Not set	Indicates the running or the last main function number (*1)
AutoMode	Not set	Turns ON in remote input acceptable status. (*2)
TeachMode	Not set	Turns ON in TEACH mode.
ErrorCode1 ⋮ ⋮ ErrorCode8192	Not set	Indicates the error number.
InsideBox1 ⋮ ⋮ InsideBox15	Not set	Turns ON when the robot is in the approach check area. (*3)
InsidePlane1 ⋮ ⋮ InsidePlane15	Not set	Turns ON when the robot is in the approach check plane. (*4)
Alarm	Not set	Turns ON when any of the alarms is occurring. (*9)
Alarm1	Not set	Turns ON when a battery alarm of the Controller is occurring.

Name	Initial	Description
Alarm2	Not set	Turns ON when a battery alarm of the robot connected to CU is occurring.
Alarm3	Not set	Turns ON when a grease alarm of the robot connected to CU is occurring. (*10)
Alarm4	Not set	Turns ON when a battery alarm of the robot connected to DU1 is occurring.
Alarm5	Not set	Turns ON when a grease alarm of the robot connected to DU1 is occurring. (*10)
Alarm6	Not set	Turns ON when a battery alarm of the robot connected to DU2 is occurring.
Alarm7	Not set	Turns ON when a grease alarm of the robot connected to DU2 is occurring. (*10)
Alarm8	Not set	Turns ON when a battery alarm of the robot connected to DU3 is occurring.
Alarm9	Not set	Turns ON when a grease alarm of the robot connected to DU3 is occurring. (*10)
PositionX	Not set	Outputs current X coordinate in the World coordinate system (*6) (*7)
PositionY	Not set	Outputs current Y coordinate in the World coordinate system (*6) (*7)
PositionZ	Not set	Outputs current Z coordinate in the World coordinate system (*6) (*7)
PositionU	Not set	Outputs current U coordinate in the World coordinate system (*6) (*7)
PositionV	Not set	Outputs current V coordinate in the World coordinate system (*6) (*7)
PositionW	Not set	Outputs current W coordinate in the World coordinate system (*6) (*7)
Torque1	Not set	Outputs the current torque value of Joint #1 (*6) (*7)
Torque2	Not set	Outputs the current torque value of Joint #2 (*6) (*7)
Torque3	Not set	Outputs the current torque value of Joint #3 (*6) (*7)
Torque4	Not set	Outputs the current torque value of Joint #4 (*6) (*7)
Torque5	Not set	Outputs the current torque value of Joint #5 (*6) (*7)
Torque6	Not set	Outputs the current torque value of Joint #6 (*6) (*7)
CPU	Not set	Outputs the CPU load factor of the user program (*8)
ESTOP	Not set	Outputs how many times emergency stops have been executed.
ALIVE	Not set	Output signal for alive monitoring of the Controller. The signal input by ALIVE input will be output. The master equipment can perform alive monitoring of the Controller by switching the input periodically and checking the output signal.

(*1) Outputs the current or the last function number of CurrProg1, 2, 4, 8, 16, or 32.

Function	CurrProg1	CurrProg2	CurrProg4	CurrProg8	CurrProg16	CurrProg32
Main	0	0	0	0	0	0
Main1	1	0	0	0	0	0
Main2	0	1	0	0	0	0
Main3	1	1	0	0	0	0
				⋮		
Main60	0	0	1	1	1	1
Main61	1	0	1	1	1	1
Main62	0	1	1	1	1	1
Main63	1	1	1	1	1	1

0=OFF, 1=ON

(*2) Remote function is available in the followings conditions.

- The setting is Auto mode and the control device is remote.
- The setting is Program mode and Remote I/O is enabled.

(*3) For details, refer to EPSON RC+ 7.0 *Online Help* or *Box* in *SPEL+ Language Reference*.

(*4) For details, refer to EPSON RC+ 7.0 *Online Help* or *Plane* in *SPEL+ Language Reference*.

(*5) Manipulator status is output as follows, according to the condition selected in SelRobot.

Wait at least 40 ms before inputting the signal after changing the condition in SelRobot.

Name	(SelRobot1- SelRobot16) condition when inputting SelRobot	
	0: All robots are selected	1 - 16: Particular robot number is selected
MotorsOn	Turns ON when at least one motor is ON.	Turns ON when the motor of the selected robot is ON.
AtHome	Turns ON when all robots are in the home position.	Turns ON when the selected robot is in the home position.
PowerHigh	Turns ON when at least one robot's power mode is High.	Turns ON when the selected robot's power mode is High.
MCalReqd	Turns ON when at least one robot hasn't executed MCal	Turns ON when the selected robot hasn't executed MCal.

(*6) Outputs information of the selected robot when SelRobot1, SelRobot2, SelRobot4, SelRobot8, and SelRobot16 are set. If not, information of Robot 1 will be output.

(*7) Outputs information in Real format.

(*8) Outputs the total load factor of the user created tasks. For details on the CPU load factor, refer to the task manager.

(*9) The signal turns ON when the alarm occurs either in the Controller alarm information or the robot alarm information.

(*10) The following parts are subject to grease up.

6-axis robot: Bevel gear on the Joint #6

SCARA, RS series: Ball screw spline unit on the Joint # 3

12.2 Timing Specifications

12.2.1 Design Notes for Remote Input Signals

The following charts indicate the timing sequences for the primary operations of the Controller.

The indicated time lapses (time durations) should be referred to only as reference values since the actual timing values vary depending on the number of tasks running, as well as CPU speed of the Controller. Check carefully and refer to the following charts for the timing interrelation when you enter an input signal.

During system design, make sure that you actuate only one remote input operation at a time, otherwise an error will occur.

The pulse width of an input signal must be 25 or more milliseconds to be detected.

12.2.2 Timing Diagram for Operation Execution Sequence

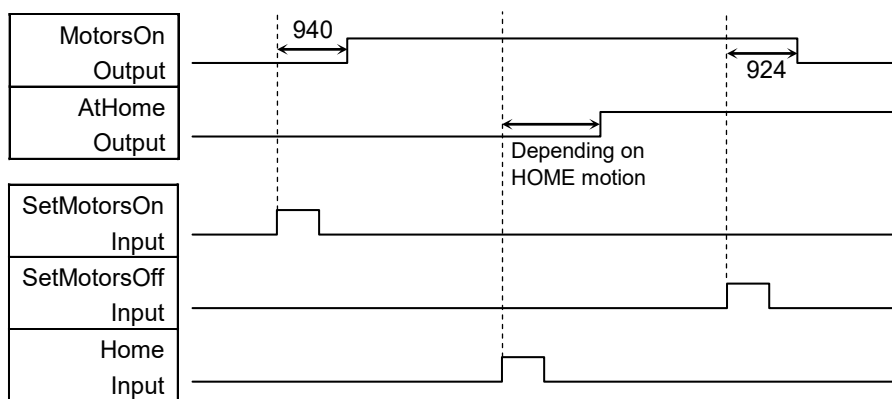

[Unit: msec]

12.2.3 Timing Diagram for Program Execution Sequence

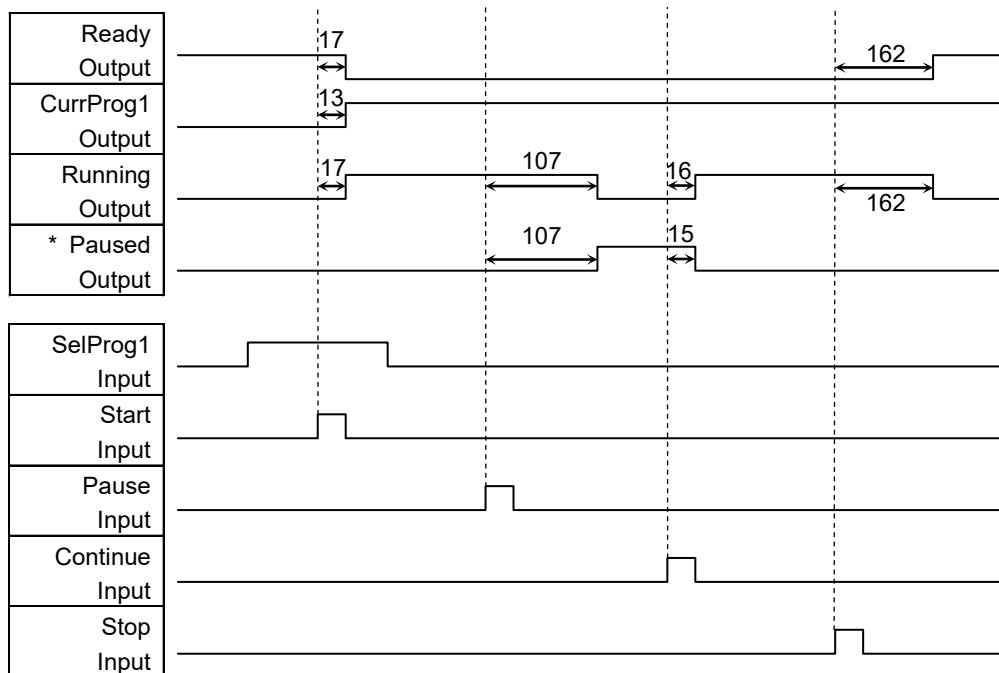

* The duration varies depending on the Quick Pause (QP) setting and the program's operating status at the time of Pause input [Unit: msec]

12.2.4 Timing Diagram for Safety Door Input Sequence

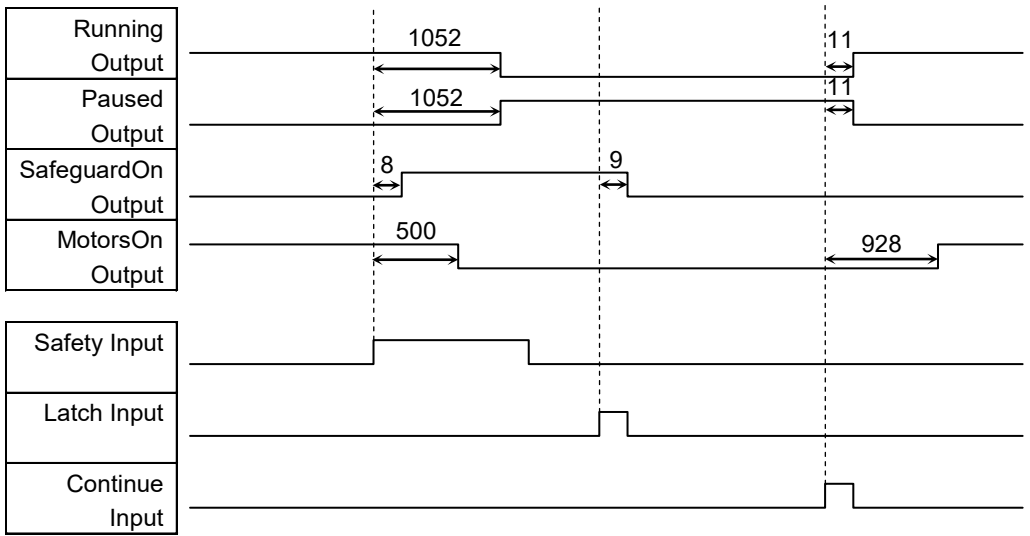

[Unit: msec]

12.2.5 Timing Diagram for Emergency Stop Sequence

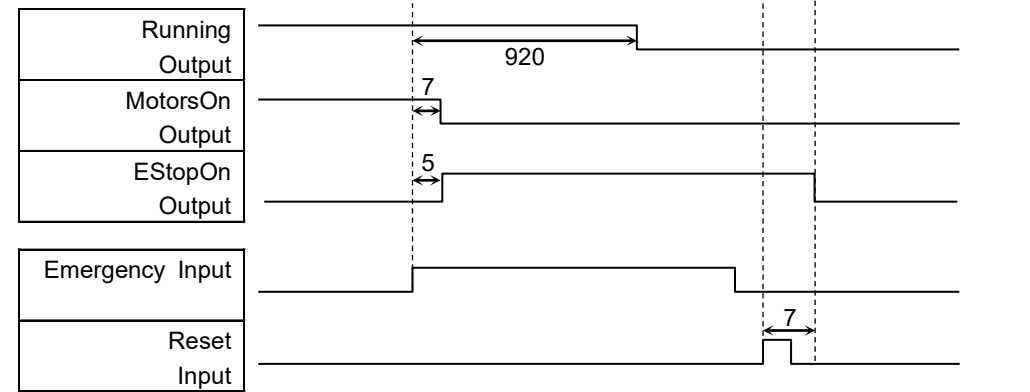

[Unit: msec]

13. R-I/O Connector

The R-I/O connector is for connecting the input signals of the real time I/O function.

		Pins	Bit number
Control Unit	Input	2	24, 25
Drive Unit 1	Input	2	56, 57
Drive Unit 2	Input	2	280, 281
Drive Unit 3	Input	2	312, 313

By inputting trigger signals to the R-I/O, you can keep and get the operating robot position when trigger is detected. If you use this function with Vision, you can create an application of parts pickup, alignment, and assembly by robots without stopping.

For details, refer to *EPSON RC+7.0 Users Guide – 20. Real time I/O*.

13.1 Input Circuit

Input Voltage Range : +24 V \pm 10%

Input Current : 10 mA (TYP) at +24 V input

The following two types of wiring are available in the input circuit.

Typical Input Circuit Application 1

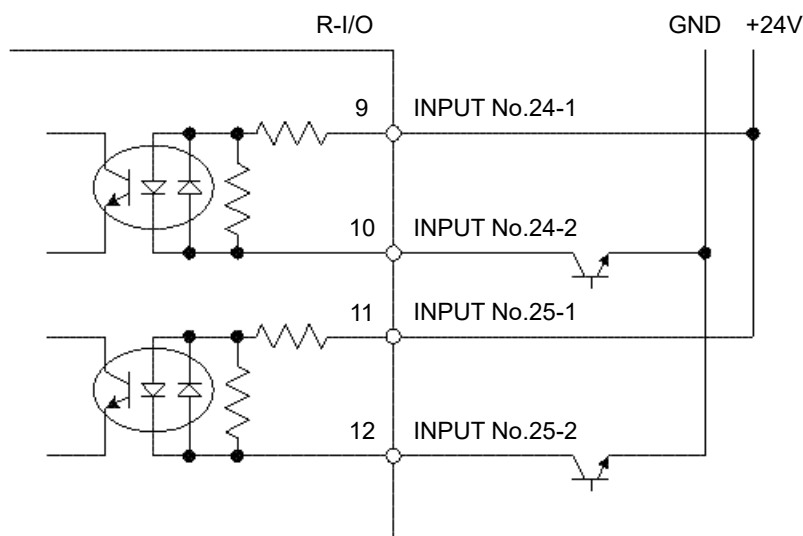

Typical Input Circuit Application 2

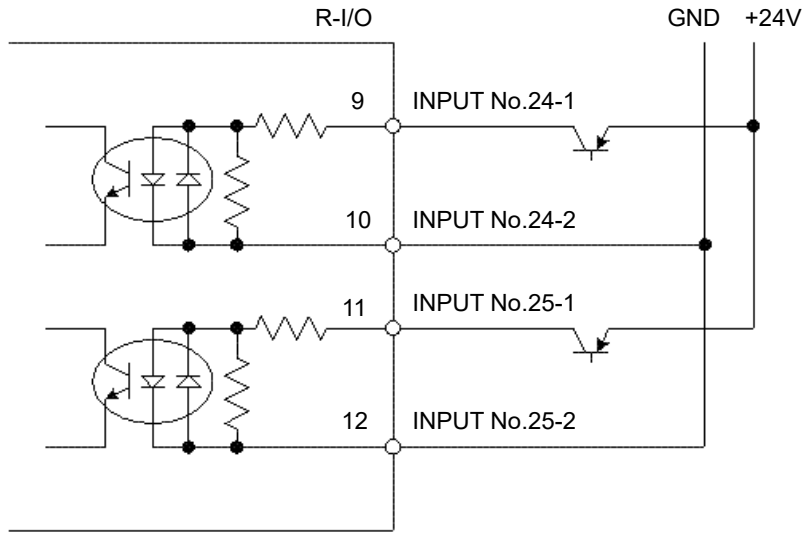

13.2 Pin Assignments

Pin No.	Signal Name
9	INPUT No24-1
10	INPUT No24-2
11	INPUT No25-1
12	INPUT No25-2
1 to 8, 13 to 15*	Not Used

* For the pins 1 to 8 and 13 to 15, do not connect anything.

Connector	Standard
R-I/O Connector (Controller side)	D-sub 15 male pin Screwlock #4 - 40



- When using R-I/O connector, be careful of the following points. If you use the R-I/O connector without meeting the necessary conditions, it may cause the system failure and/or safety problems.
 - Use a shielded cable and route the cables as far from the surrounding noise sources as possible.
For details, refer to *Setup & Operation: 3.5 Noise Countermeasures*.
 - Make sure to check the cable routing before turning ON the power supply.

14. Option Slots

14.1 About Option Slots

Use the Option Slot to install the optional boards of RC700 / RC700-A Controller.

Up to four option boards can be installed in the Controller. The types of the option boards are as follows:

- 14.2 Expansion I/O Board
- 14.3 Fieldbus I/O Board
- 14.4 RS-232C Board
- 14.5 PG Board
- 14.6 Analog I/O Board
- 14.7 Force Sensor I/F Board
- 14.8 EUROMAP67 Board

14.2 Expansion I/O Board

14.2.1 Expansion I/O Board

Each additional expansion I/O board provides 24 inputs and 16 outputs.

You can install up to four expansion I/O boards in the Controller.

The input and output bit numbers are assigned as follows. (Bit number is assigned from CN1.)

Input Bit #	Output Bit #	Applicable Hardware
0 to 23	0 to 15	STANDARD I/O
64 to 87	64 to 79	The 1 st Expansion I/O board
96 to 119	96 to 111	The 2 nd Expansion I/O board
128 to 151	128 to 143	The 3 rd Expansion I/O board
160 to 183	160 to 175	The 4 th Expansion I/O board

14.2.2 Board Configuration (Expansion I/O Board)

Board Appearance

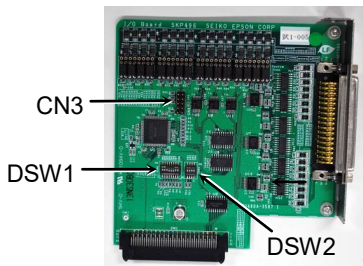

Switch and Jumper Configuration

Setup the DSW1 and DSW2. CN3 is all open.

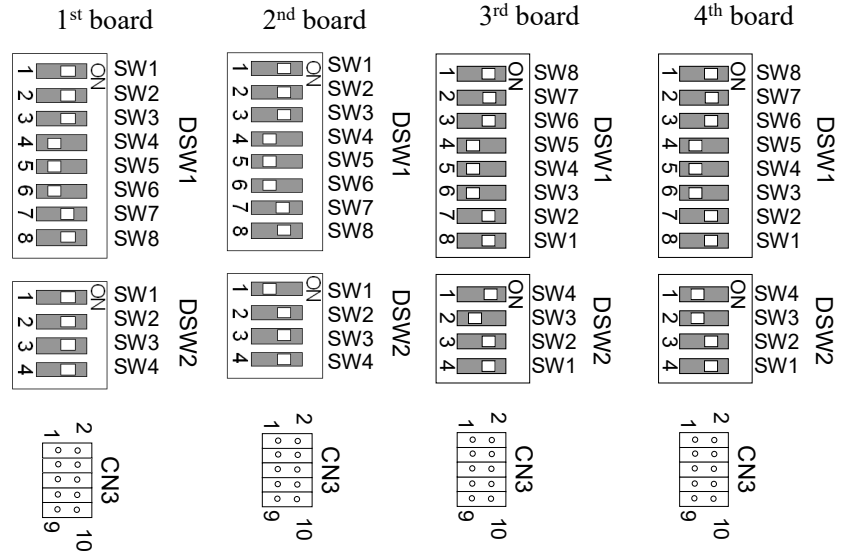

14.2.3 Confirmation with EPSON RC+ 7.0 (Expansion I/O Board)

When an expansion I/O board is mounted to the option unit, the Controller software automatically identifies the expansion I/O board. Therefore, no software configuration is needed.

Correct identification can be confirmed from EPSON RC+ 7.0.

- (1) Select the EPSON RC+ 7.0 menu-[Setup]-[System Configuration] to display the [System Configuration] dialog.

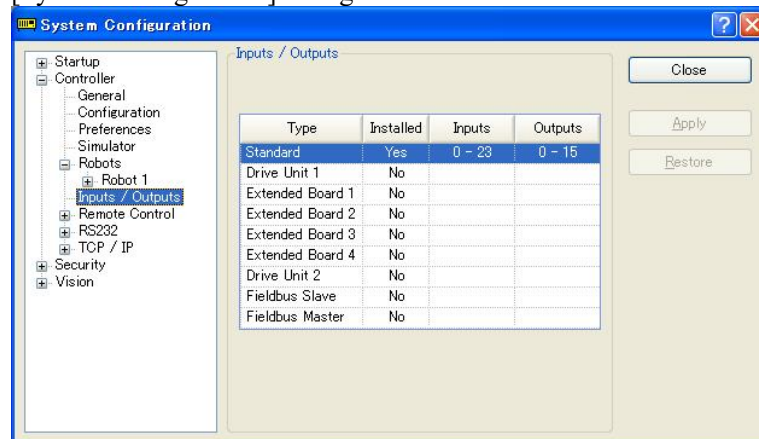

- (2) Select [Controller]-[Inputs / Outputs].
- (3) Make sure that “Yes” is displayed in the Installed column.
The expansion I/O board is identified by the Controller software. Corresponding Input and Output is available.

14.2.4 Input Circuit

Input Voltage Range	: + 12 V to 24 V \pm 10%
ON Voltage	: + 10.8 V (Min.)
OFF Voltage	: + 5 V (Max.)
Input Current	: 10 mA (TYP) at + 24 V input

Two types of wiring are available for use with the two-way photo coupler in the input circuit.

Protected Expansion I/O Board Typical Input Circuit Application 1

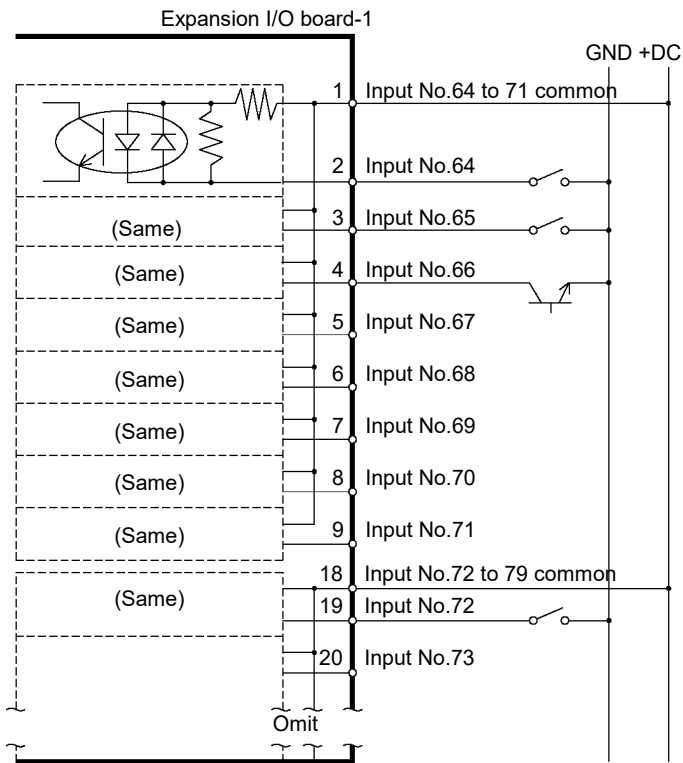

Protected Expansion I/O Board Typical Input Circuit Application 2

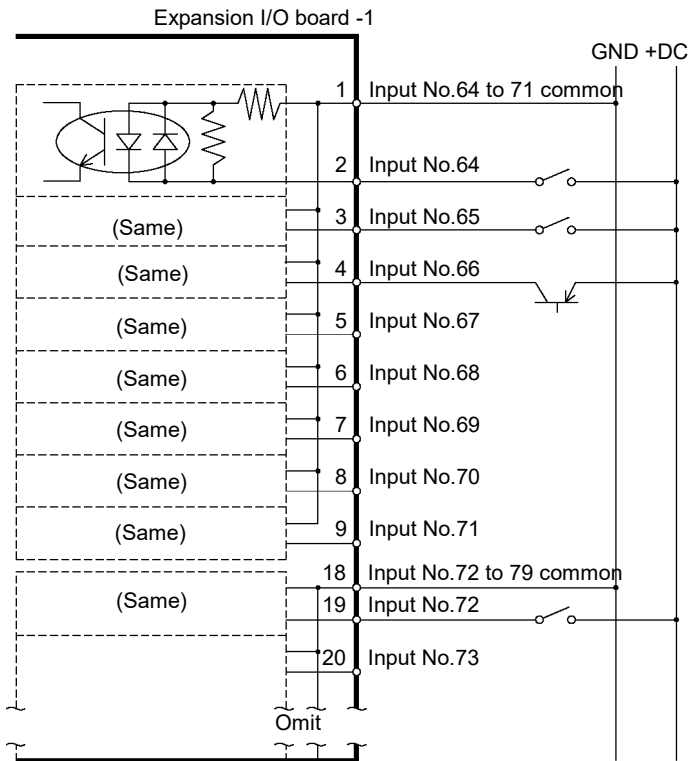

14.2.5 Output Circuit

Rated Output Voltage	: +12 V to 24 V \pm 10%
Maximum Output Current	: TYP 100 mA/1 output
Output Driver	: Photo coupler



- The output circuit has two types: Sink type and Source type. The either type has been configured in the Controller before the shipment. Before routing the cables, make sure that the I/O output type of your Controller conforms to the external connection devices.
If you route the cables with wrong output type, the parts on the board will be broken and the robot system won't operate normally.
- Use the wiring diagram of 2: *Source Type* for CE conformance. Be sure to wire correctly. Improper wiring may cause safety problems as it may make the Manipulator move unusually.
- Be sure to wire the output circuit properly because it has no protection circuitry for short-circuit and reverse-connection. Improper wiring may cause malfunction of the parts on the board and then improper function of the robot system.

Typical Output Circuit Application 1: Sink Type (NPN)

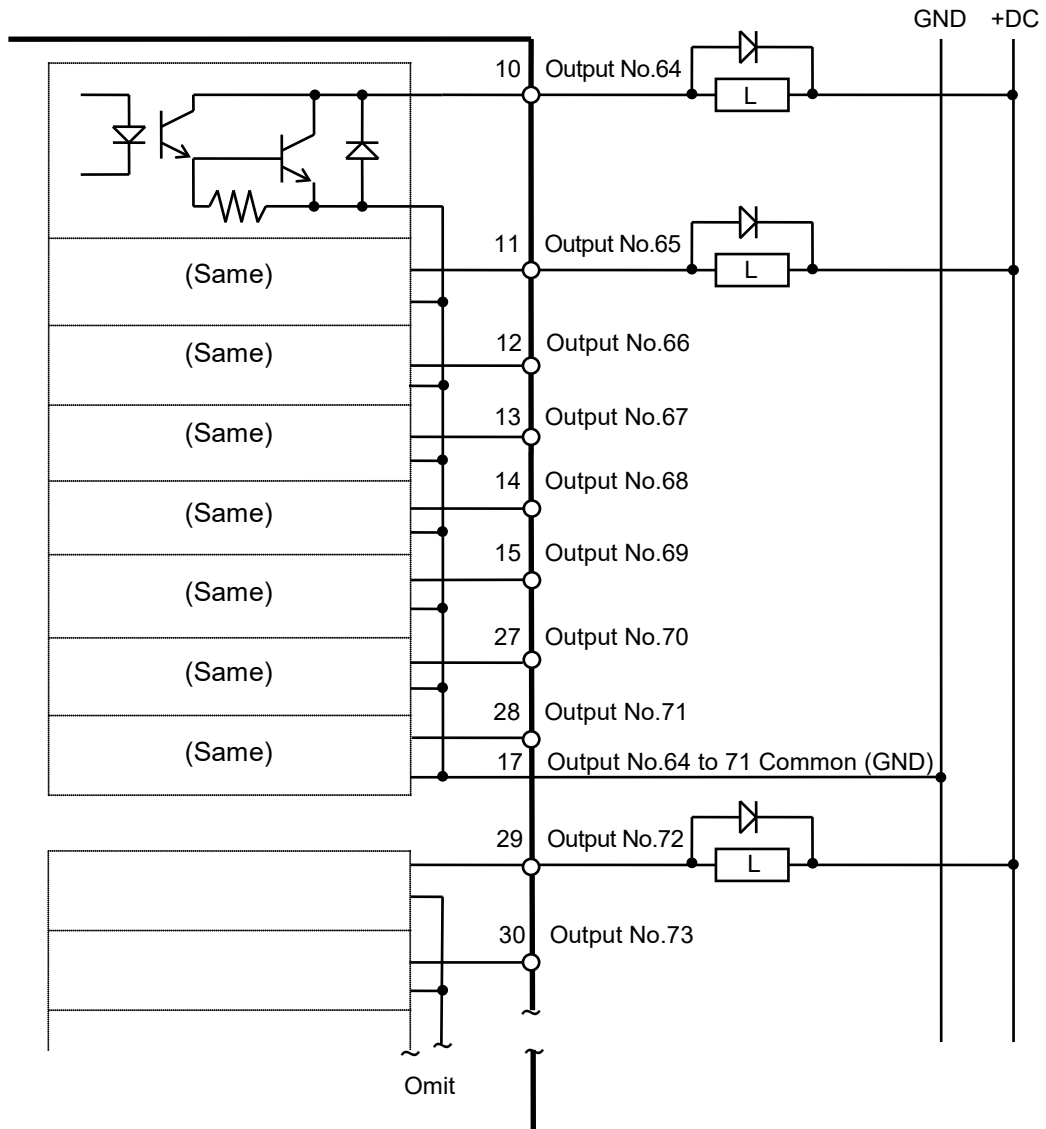

Typical Output Circuit Application 2: Source Type (PNP)

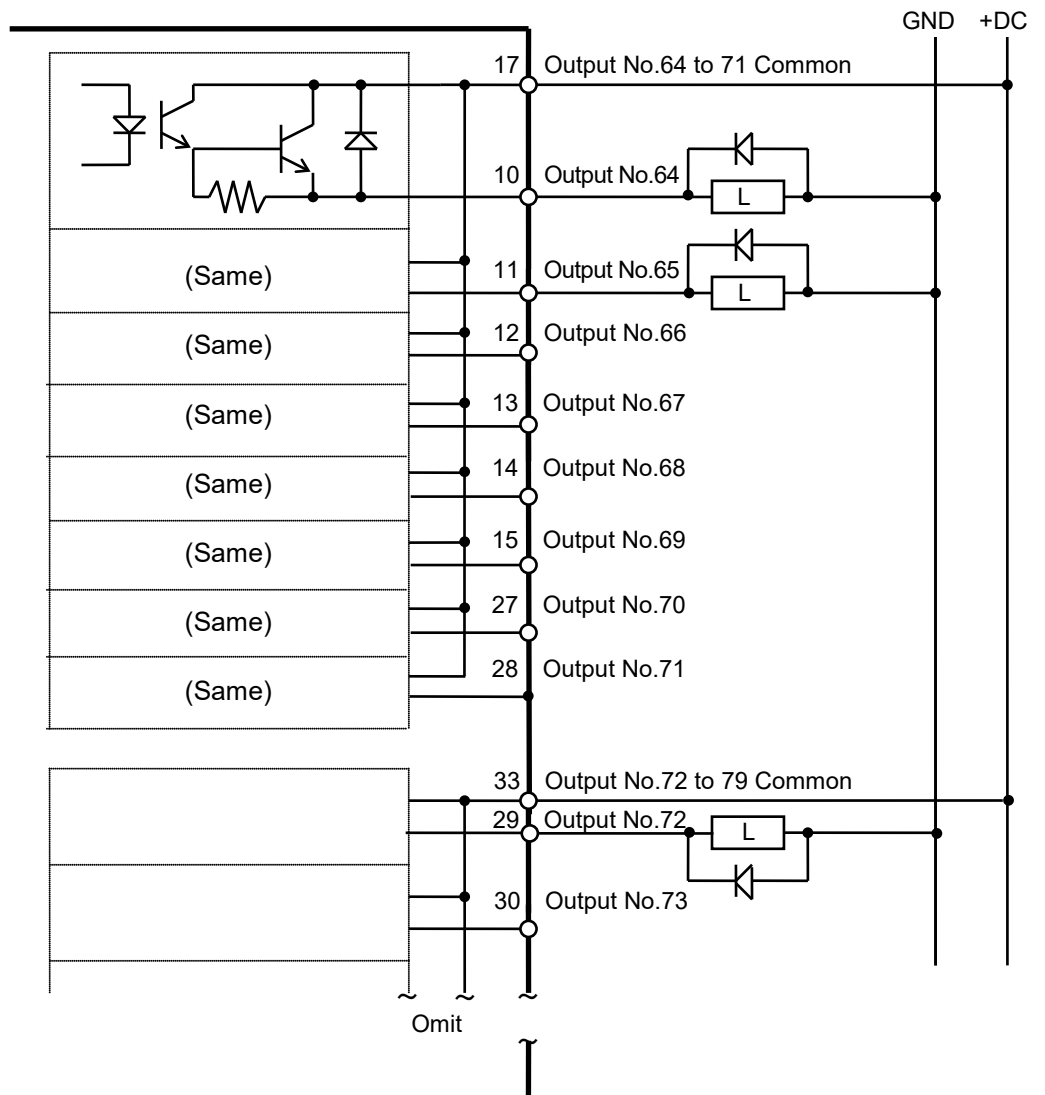

14.2.6 Pin Assignments (Expansion I/O Board)

Pin Assignment table of the 1st Expansion I/O board.

Connector 1 Pin Assignments

Pin No.	Signal Name	Pin No.	Signal Name	Pin No.	Signal Name
1	Input common No.64 to 71	18	Input common No.72 to 79	34	Input common No.80 to 87
2	Input No.64	19	Input No.72	35	Input No.80
3	Input No.65	20	Input No.73	36	Input No.81
4	Input No.66	21	Input No.74	37	Input No.82
5	Input No.67	22	Input No.75	38	Input No.83
6	Input No.68	23	Input No.76	39	Input No.84
7	Input No.69	24	Input No.77	40	Input No.85
8	Input No.70	25	Input No.78	41	Input No.86
9	Input No.71	26	Input No.79	42	Input No.87
10	Output No.64	27	Output No.70	43	Output No.75
11	Output No.65	28	Output No.71	44	Output No.76
12	Output No.66	29	Output No.72	45	Output No.77
13	Output No.67	30	Output No.73	46	Output No.78
14	Output No.68	31	Output No.74	47	Output No.79
15	Output No.69	32	Not Used	48	Not Used
16	Not Used	33	Output common No.72 to 79	49	Not Used
17	Output common No.64 to 71			50	Not Used

Connector	Standard
I/O Connector (Controller side)	D-sub 50 male pin Screwlock #4 - 40

* The I/O connector, I/O connector cable, terminal block, and I/O connector kit are offered as options.

Pin Assignment table of the 2nd Expansion I/O board.

Connector 1 Pin Assignments

Pin No.	Signal Name	Pin No.	Signal Name	Pin No.	Signal Name
1	Input common No.96 to 103	18	Input common No.104 to 111	34	Input common No.112 to 119
2	Input No.96	19	Input No.104	35	Input No.112
3	Input No.97	20	Input No.105	36	Input No.113
4	Input No.98	21	Input No.106	37	Input No.114
5	Input No.99	22	Input No.107	38	Input No.115
6	Input No.100	23	Input No.108	39	Input No.116
7	Input No.101	24	Input No.109	40	Input No.117
8	Input No.102	25	Input No.110	41	Input No.118
9	Input No.103	26	Input No.111	42	Input No.119
10	Output No.96	27	Output No.102	43	Output No.107
11	Output No.97	28	Output No.103	44	Output No.108
12	Output No.98	29	Output No.104	45	Output No.109
13	Output No.99	30	Output No.105	46	Output No.110
14	Output No.100	31	Output No.106	47	Output No.111
15	Output No.101	32	Not Used	48	Not Used
16	Not Used	33	Output common No.104 to 111	49	Not Used
17	Output common No.96 to 103			50	Not Used

Connector	Standard
I/O Connector (Controller side)	D-sub 50 male pin Screwlock #4 - 40

* The I/O connector, I/O connector cable, terminal block, and I/O connector kit are offered as options.

Pin Assignment table of the 3rd Expansion I/O board.

Connector 1 Pin Assignments

Pin No.	Signal Name	Pin No.	Signal Name	Pin No.	Signal Name
1	Input common No.128 to 135	18	Input common No.136 to 143	34	Input common No.144 to 151
2	Input No.128	19	Input No.136	35	Input No.144
3	Input No.129	20	Input No.137	36	Input No.145
4	Input No.130	21	Input No.138	37	Input No.146
5	Input No.131	22	Input No.139	38	Input No.147
6	Input No.132	23	Input No.140	39	Input No.148
7	Input No.133	24	Input No.141	40	Input No.149
8	Input No.134	25	Input No.142	41	Input No.150
9	Input No.135	26	Input No.143	42	Input No.151
10	Output No.128	27	Output No.134	43	Output No.139
11	Output No.129	28	Output No.135	44	Output No.140
12	Output No.130	29	Output No.136	45	Output No.141
13	Output No.131	30	Output No.137	46	Output No.142
14	Output No.132	31	Output No.138	47	Output No.143
15	Output No.133	32	Not Used	48	Not Used
16	Not Used	33	Output common No.136 to 143	49	Not Used
17	Output common No.128 to 135			50	Not Used

Connector	Standard
I/O Connector (Controller side)	D-sub 50 male pin Screwlock #4 - 40

* The I/O connector, I/O connector cable, terminal block, and I/O connector kit are offered as options.

Pin Assignment table of the 4th Expansion I/O board.

Connector 1 Pin Assignments

Pin No.	Signal Name	Pin No.	Signal Name	Pin No.	Signal Name
1	Input common No.160 to 167	18	Input common No.168 to 175	34	Input common No.176 to 183
2	Input No.160	19	Input No.168	35	Input No.176
3	Input No.161	20	Input No.169	36	Input No.177
4	Input No.162	21	Input No.170	37	Input No.178
5	Input No.163	22	Input No.171	38	Input No.179
6	Input No.164	23	Input No.172	39	Input No.180
7	Input No.165	24	Input No.173	40	Input No.181
8	Input No.166	25	Input No.174	41	Input No.182
9	Input No.167	26	Input No.175	42	Input No.183
10	Output No.160	27	Output No.166	43	Output No.171
11	Output No.161	28	Output No.167	44	Output No.172
12	Output No.162	29	Output No.168	45	Output No.173
13	Output No.163	30	Output No.169	46	Output No.174
14	Output No.164	31	Output No.170	47	Output No.175
15	Output No.165	32	Not Used	48	Not Used
16	Not Used	33	Output common No.168 to 175	49	Not Used
17	Output common No.160 to 167			50	Not Used

Connector	Standard
I/O Connector (Controller side)	D-sub 50 male pin Screwlock #4 - 40

* The I/O connector, I/O connector cable, terminal block, and I/O connector kit are offered as options.

14.3 Fieldbus I/O Board

Fieldbus I/O supports the following models.

- DeviceNet™
- PROFIBUS-DP
- PROFINET
- CC-LINK
- EtherNet/IP™
- EtherCAT®
- Modbus (This is not optional but a standard feature.)

Refer to the following manuals.

Robot Controller RC700/RC90 option Fieldbus I/O

EPSON RC+ 7.0 User's Guide 11.7 Fieldbus Slave I/O

14.4 RS-232C Board

14.4.1 About the RS-232C Board

One standard RS-232C port is not available with the Controller.

You need to mount the RS-232C board in the Option Slot to communicate with external equipment using two or more port RS-232C.

The RS-232C board accepts two ports expansion per board. A maximum of two boards/four ports expansion is available for RS-232C board.

When using the Force Sensor I/F board, a maximum of one board/two ports expansion is available for RS-232C board.

Port Number

Port numbers are assigned as follows.

Port No.	Supported hardware
#2, #3	First RS-232C board
#4, #5	Second RS-232C board

14.4.2 Board Setup (RS-232C)

Board Appearance

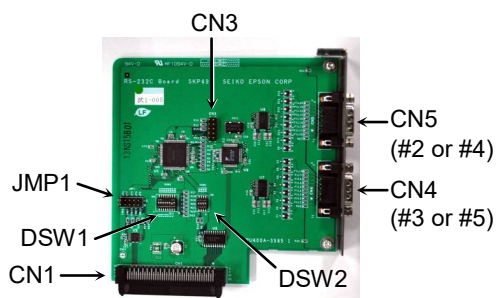

Switch and Jumper Configuration

Set DSW1, DSW2 and JMP1.

CN3 is all open.

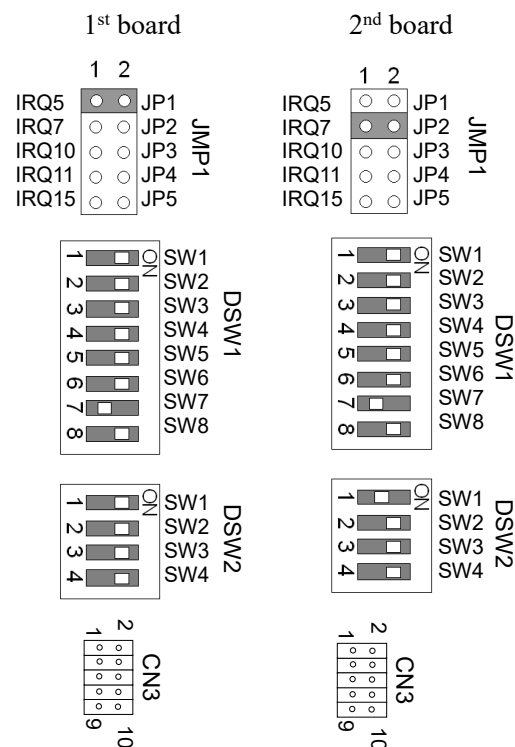

14.4.3 Confirmation with EPSON RC+ (RS-232C)

When an RS-232C board is mounted in as option unit, the Controller software automatically identifies the RS-232C board. Therefore, no software configuration is needed. Correct identification can be confirmed from EPSON RC+.

- (1) Select the EPSON RC+ 7.0 menu-[Setup]-[System Configuration] to display the [System Configuration] dialog.

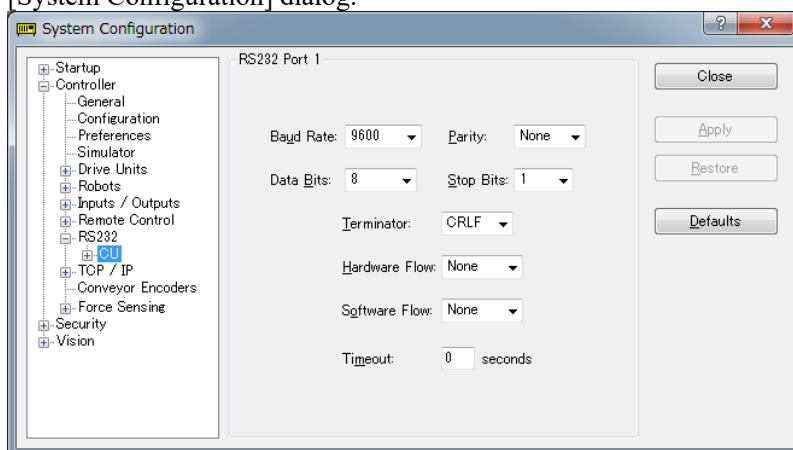

- (2) Select the [RS232]-[CU].

14.4.4 RS-232C Software Communication Setup (RS-232C)

Available communication settings are as follows.

Item	Specification
Baud Rates	110, 300, 600, 1200, 2400, 4800, 9600, 14400, 19200, 38400, 57600, 115200
Data bit length	7, 8
Stop bit length	1, 2
Parity	Odd, even, NA
Terminator	CR, LF, CRLF

Refer to *EPSON RC+ 7.0 Online Help* or *Users Guide – 13. RS-232C Communications* for RS-232C communication from the Robot application.

14.4.5 Communication Cable (RS-232C)

Prepare a communication cable as described in this section.

Connector	Standard
RS-232C Connector (Controller side)	D-sub 9 male pin Screwlock #4 - 40

NOTE



Use twisted pair cable for shielded wire.

Clamp the shield to the hood for noise prevention.

Pin assign of the RS-232C connector is as follows.

Pin No	Signal	Function	Signal Direction
1	DCD	Data carrier detect	Input
2	RXD	Receive data	Input
3	TXD	Send data	Output
4	DTR	Terminal ready	Output
5	GND	Signal ground	-
6	DSR	Data set ready	Input
7	RTS	Request to send	Output
8	CTS	Clear to send	Input
9	RI	Ring indicator	Input

14.5 PG Board

The PG board has the following two types of usage. For details, refer to the related manuals.

When using as the conveyor encoder:

Refer to *EPSON RC+ 7.0 User's Guide 16. Conveyor Tracking*

When using as a PG motion system:

Refer to *Robot Controller RC700/RC90 option PG Motion System*

14.6 Analog I/O Board

14.6.1 About Analog I/O Board

Analog input/output function is available when mounting analog I/O board to the option slot. You can install a maximum of four analog I/O boards in the option slot.

Analog I/O Board (1CH): “DAC: 1ch” is available for one board.

Analog I/O Board (4CH): “DAC: 2ch, ADC: 2ch” is available for one board.

DAC: Analog signal output (voltage/current)

ADC: Analog signal input (voltage/current)

Connection Example of Analog I/O Board (4CH)

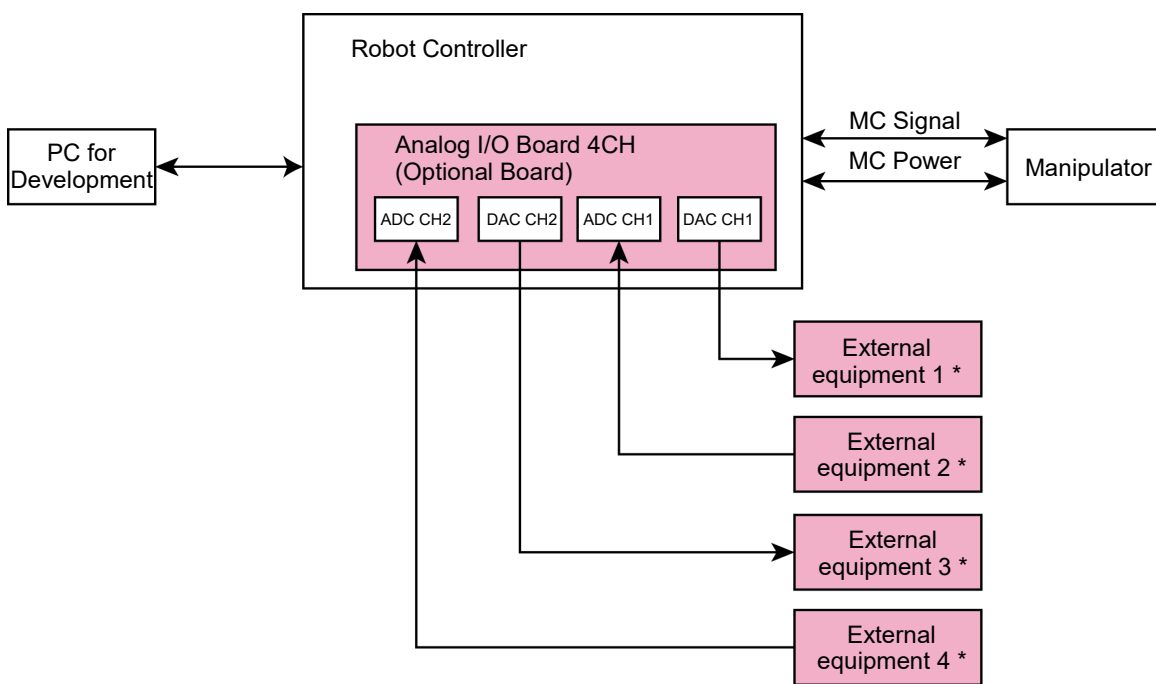

*: Voltage/Current Input

Overview of Analog I/O Board Circuit

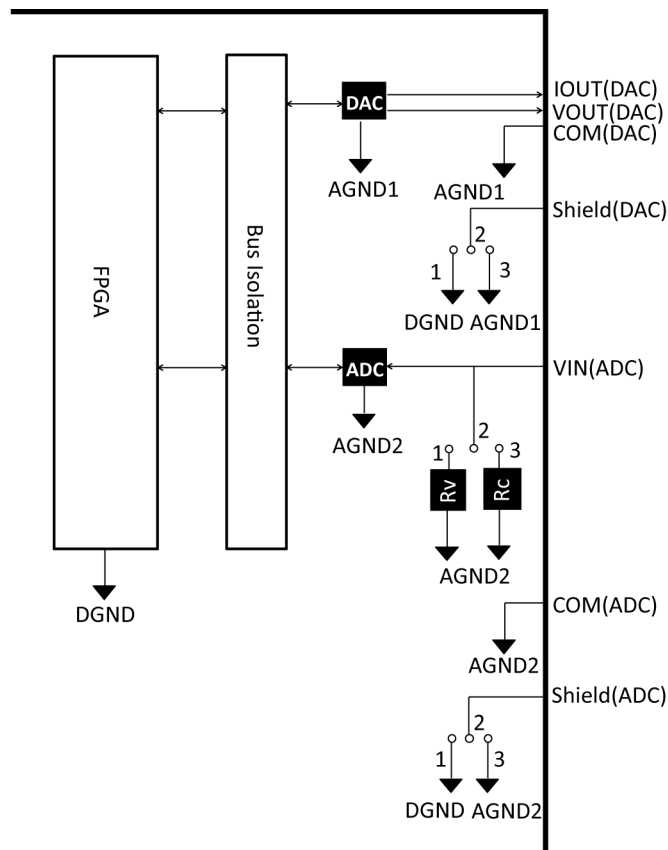

Rv: Voltage Input Terminating Resistance (100kΩ),
 Rc: Current Input Terminating Resistance

14.6.2 Board Configuration (Analog I/O Board)

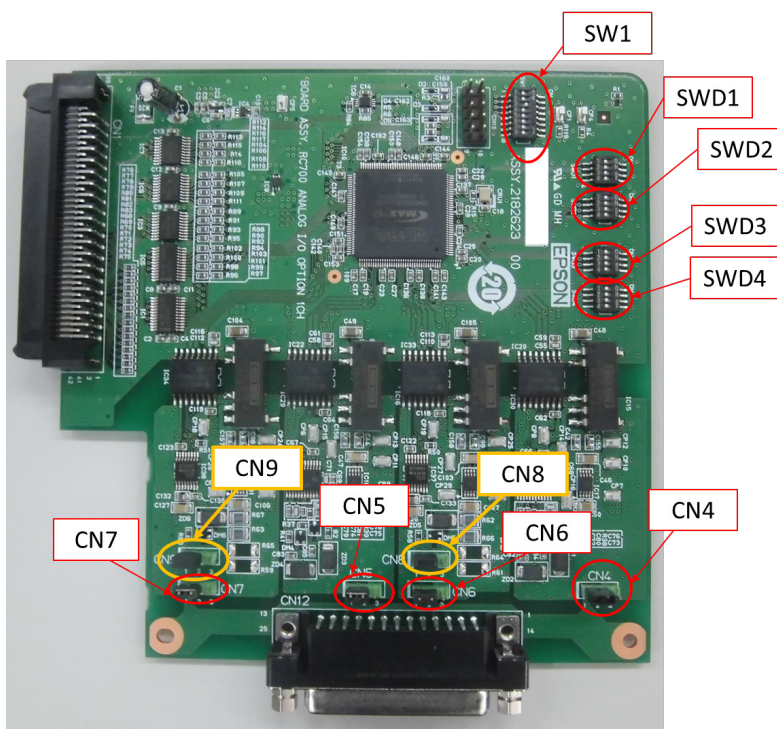

Configuration of Switch and Jumper

(1) Address Configuration (SW1): Address of the option board

Configuration	S1	S2	S3	S4	S5	S6	S7	S8
The first board	Off	Off	On	Off	Off	Off	Off	Off
The second board	Off	On	Off	Off	Off	Off	Off	Off
The third board	On	Off	Off	Off	Off	Off	Off	Off
The fourth board	Off	Off	Off	Off	Off	Off	Off	Off

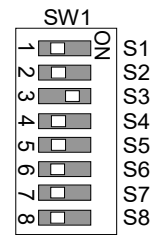

S5 to S8: Not used. Please turn them OFF.

(2) Analog Output: Configuration

Voltage Current Switching Switch (SWD1): Voltage/current output

Range Switching Switch (SWD2): Output range

Channel	Output Mode	Range Configuration	SWD1 (voltage current switching)				SWD2 (range switching)			
			S1	S2	S3	S4	S1	S2	S3	S4
DAC 1ch	Voltage output mode	±5V	On	Not Use	Not Use	Not Use	On	On	Not Use	Not Use
		±10V	On				On	Off		
		0~5V	On				Off	On		
		0~10V *	On				Off	Off		
	Current output mode	0~20mA	Off				On	On		
		4~20mA	Off				Off	Off		
DAC 2ch	Voltage output mode	±5V	Not Use	On	Not Use	Not Use	Not Use	Not Use	On	On
		±10V		On					On	Off
		0~5V		On					Off	On
		0~10V *		On					Off	Off
	Current output mode	0~20mA		Off					On	On
		4~20mA		Off					Off	Off

*: Default: DAC default configuration (voltage output: 0 to 10V)

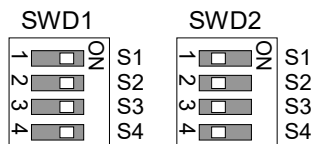

(3) Analog Input: Configuration

Voltage Current Switching Jumper (CN8/CN9): Current input/voltage input

1-2 pin short: Voltage input configuration

2-3 pin short: Current input configuration

Voltage Current Switching Switch (SWD1): Voltage/current input

Range Switching Switch (SWD3): Input range

Channel	Input Mode	Range Configuration	SWD1(voltage current switching)				CN8 (voltage current switching)	CN9 (voltage current switching)
			S1	S2	S3	S4		
ADC 1ch	Voltage Input Mode	±5.12V	Not Use	Not Use	On	Not Use	1-2 short	Not Use
		±10.24V			On		1-2 short	
		0 to 5.12V			On		1-2 short	
		0 to 10.24V *			On		1-2 short	
	Current Input Mode	0 to 24mA			Off		2-3 short	
ADC 2ch	Voltage Input Mode	±5.12V	Not Use	Not Use	Not Use	On	Not Use	1-2 short
		±10.24V				On		1-2 short
		0 to 5.12V				On		1-2 short
		0 to 10.24V *				On		1-2 short
		Current Input Mode	0 to 24mA			Off		2-3 short

Channel	Input Mode	Range Configuration	SWD3 (range switching)				SWD4
			S1	S2	S3	S4	
ADC 1ch	Voltage Input Mode	±5.12V	On	On	Not Use	Not Use	Off
		±10.24V	On	Off			
		0 to 5.12V	Off	On			
		0 to 10.24V *	Off	Off			
	Current Input Mode	0 to 24mA	Off	On			
ADC 2ch	Voltage Input Mode	±5.12V	Not Use	Not Use	On	On	Off
		±10.24V			On	Off	
		0 to 5.12V			Off	On	
		0 to 10.24V *			Off	Off	
		Current Input Mode	0 to 24mA			Off	On

SWD4: Not used. Please turn them OFF.

*: Default: ADC default configuration (voltage input: 0 to 10.24V)

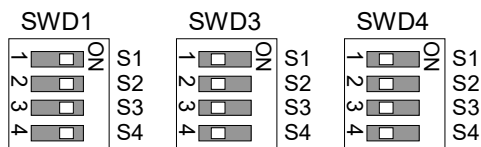

(4) Shield Configuration

“Frame Ground” and “User Ground” of the shield: CN4, CN5, CN6, and CN7

1-2 pin short : Frame ground (FG) shield configuration.
When you want to spread the shield noise to the robot Controller side.

2-3 pin short : User ground (UG) shield configuration.
When you want to insulate the shield by external connection device and robot Controller.
Or when you want to spread the shield noise to the external connection device side.

User Ground (UG): Analog ground (AGND) on the external connection device side.

Frame Ground (FG): Digital ground (DGND) inside the robot Controller.

Channel	Configuration	CN4	CN5	CN6	CN7
DAC1ch	FG Shield*	1-2 short	Not Use	Not Use	Not Use
	UG Shield	2-3 short			
DAC2ch	FG Shield *	Not Use	1-2 short	Not Use	Not Use
	UG Shield		2-3 short		
ADC1ch	FG Shield *	Not Use	Not Use	1-2 short	Not Use
	UG Shield			2-3 short	
ADC2ch	FG Shield *	Not Use	Not Use	Not Use	1-2 short
	UG Shield				2-3 short

*: Default

14.6.3 Confirmation with EPSON RC+ (Analog I/O Board)

The Controller software automatically identifies the analog I/O board when mounting analog I/O board to the optional unit of the Controller. Therefore, no software configuration is needed.

Correct identification can be confirmed from EPSON RC+.

- (1) Select the EPSON RC+ 7.0 menu-[Setup]-[System Configuration] to display the [System Configuration] dialog.
- (2) Select [Controller]-[Inputs / Outputs]-[Analog I/O].

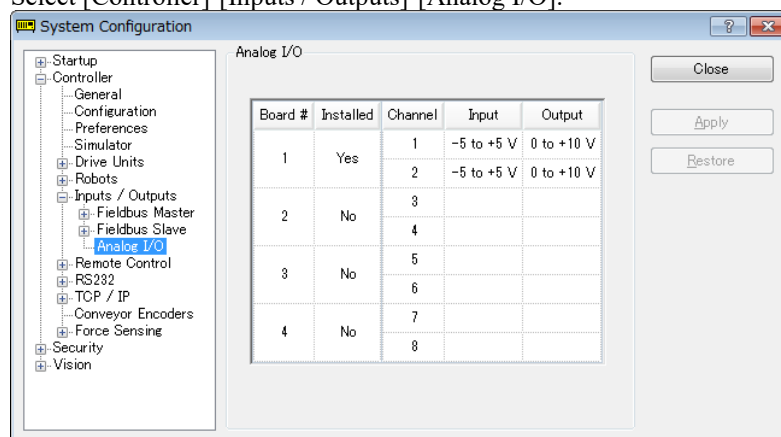

14.6.4 Input Circuit (Analog I/O Board)

Input resolution : 16 bit
 Input range : voltage input: 0 to 5.12V, 0 to 10.24V, ±5.12V, ±10.24V
 current input: 0 to 24mA
 Input impedance (Voltage/Current)
 : Applox.100kΩ/Applox.422Ω
 Absolute rated voltage of input pins
 : ±11V
 Insulation specification : insulation between channels, bus insulation

14.6.5 Output Circuit (Analog I/O Board)

Output resolution : 16 bit
 Output range : voltage output: 0 to 5V, 0 to 10V, ±5V, ±10V
 current output: 0 to 20mA, 4 to 20mA
 Output impedance (Voltage/Current)
 : Applox.17Ω/Applox.50MΩ
 Absolute rated voltage of output pins
 : ±11V
 Load resistance/capacity (@voltage output)
 : 1kΩ or more/5nF or less
 Load resistance /inductance (@voltage output)
 : 300kΩ or more/50mH or less
 Insulation specification : insulation between channels, bus insulation



- Analog input/output may not function properly if performing improper wiring or configuration.
- Operating under external noise may affect to the analog input/output. Make sure the noise environment such as weather the cable is shielded.
- Use the shield/twist cable.
- Never apply a voltage or current which is out of input/output range to the analog input/output pin. Applying a voltage more than ±11V may result in malfunction of the board.
- Improper wiring or short circuit may cause malfunction of the parts on the board and then improper function of the robot system.

14.6.6 Pin Assignments (Analog I/O Board)

1CH Specifications

Signal	Signal	Signal	Signal
1	VOUT (DAC 1ch)	20	Shield (DAC 1ch)
2	COM (DAC 1ch)	21	IOOUT (DAC 1ch)
3	Shield (DAC 1ch)	22	COM (DAC 1ch)
4	Not Used	23	Not Used
5	Not Used	24	Not Used
6	Not Used	25	Not Used
7	Not Used	26	Not Used
8	Not Used	27	Not Used
9	Not Used	28	Not Used
10	Not Used	29	Not Used
11	Not Used	30	Not Used
12	Not Used	31	Not Used
13	Not Used	32	Not Used
14	Not Used	33	Not Used
15	Not Used	34	Not Used
16	Not Used	35	Not Used
17	Not Used	36	Not Used
18	Not Used	37	Not Used
19	Not Used		

4CH Specifications

Signal	Signal	Signal	Signal
1	VOUT (DAC 1ch)	20	Shield (DAC 1ch)
2	COM (DAC 1ch)	21	IOOUT (DAC 1ch)
3	Shield (DAC 1ch)	22	COM (DAC 1ch)
4	Not Used	23	Not Used
5	Not Used	24	Not Used
6	Not Used	25	Not Used
7	VIN (ADC 1ch)	26	Shield (ADC 1ch)
8	COM (ADC 1ch)	27	Not Used
9	Not Used	28	Not Used
10	Not Used	29	Not Used
11	VOUT (DAC 2ch)	30	Shield (DAC 2ch)
12	COM (DAC 2ch)	31	IOOUT (DAC 2ch)
13	Shield (DAC 2ch)	32	COM (DAC 2ch)
14	Not Used	33	Not Used
15	Not Used	34	Not Used
16	Not Used	35	Not Used
17	Not Used	36	Not Used
18	VIN (ADC 2ch)	37	Shield (ADC 2ch)
19	COM (ADC 2ch)		

14.7 Force Sensor I/F Board

14.7.1 About Force Sensor I/F Board

You need to mount the Force Sensor I/F board in the option slot to communicate with the Force Sensor.

Force Sensor I/F board has one port for the connector to connect to Force Sensor and only one board is available.

When using the Force Sensor I/F board, one board expansion is available for RS-232C board.

Force Sensor can connect to all S250 series.

14.7.2 Board Configuration (Force Sensor I/F Board)

Board Appearance

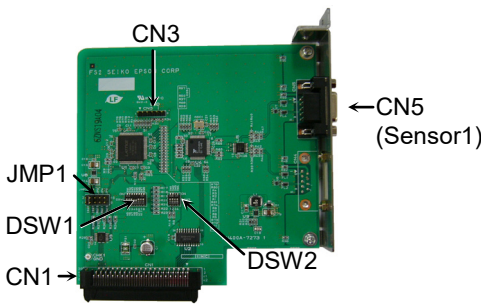

CN3 is all open.

Switch and Jumper Configuration

Do not change the following DSW1, DSW2, and JMP1 configurations.

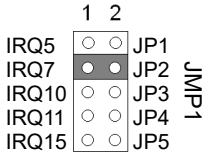

14.7.3 Confirmation with EPSON RC+ (Force Sensor I/F Board)

The Controller software automatically identifies the Force Sensor I/F board when mounting Force Sensor I/F board to the optional slot of the Controller.

Correct identification can be confirmed from EPSON RC+.

- (1) Select the EPSON RC+ 7.0 menu-[Setup]-[System Configuration] to display the [System Configuration] dialog.

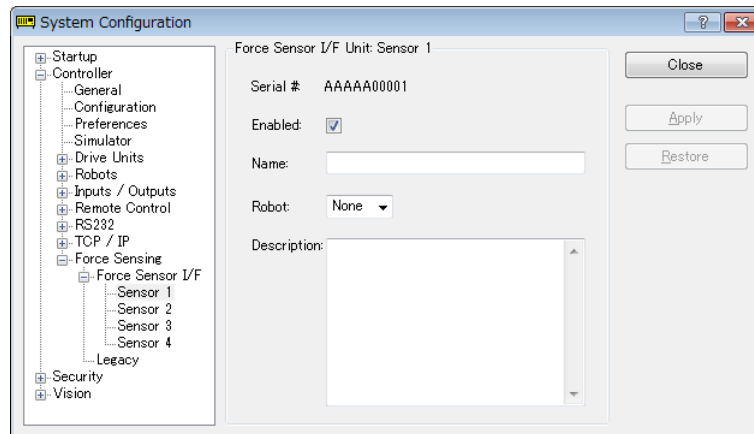

- (2) Select [Force Sensing]-[Force Sensor I/F Unit].

For the setting method of the Force Sensor I/F unit, refer to the following.

EPSON RC+ 7.0 Online Help

EPSON RC+ 7.0 Option Force Guide 7.0 Manual

Software 1.1 *Configuring the Force Sensor I/F Unit*

14.8 EUROMAP67 Board

EUROMAP67 is a standardized interface for communications between Western-manufactured injection molding machines (IMM) and robots.

List of accessories

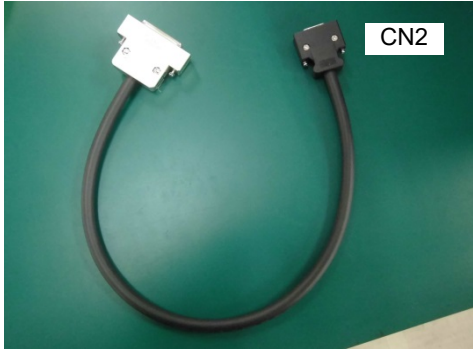
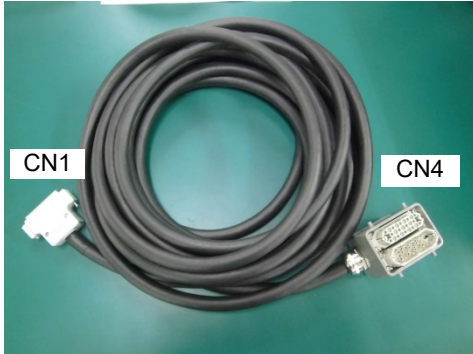
Parts Code	Parts	Note
2194667	EUROMAP67 Cable1 	Emergency Stop cable (CN2)
2194667	EUROMAP67 Cable2 	Connection cable Robot Controller(CN1) - IMM(CN4)
2165789	EUROMAP67Emergency Connector Plug	For emergency stop switch wiring Soldering plug (CN3)
2194882	EUROMAP67Emergency Connector Shell	For emergency stop switch wiring Shell kit (CN3)

Wire the emergency stop switch wiring connector (CN3).

Reference: *Setup & Operation 9. EMERGENCY*

The connector signal placement is described below.

Setup & Operation 14.8.11 Emergency stop connector Pin Assignments

List of connectors used

Connector No.	Manufacturer	Model
CN1	JAE	DD-50PF-N
CN2	3M	10126-3000PE, 10326-52K0-008
CN3 (accessory)	3M	10136-3000PE, 10336-52K0-008
CN4	Tyco	T1319320125-000 / T2020252201-000 / T2020252101-000

Connection outline

(IMM: Injection Molding Machine)

One EUROMAP67 board:

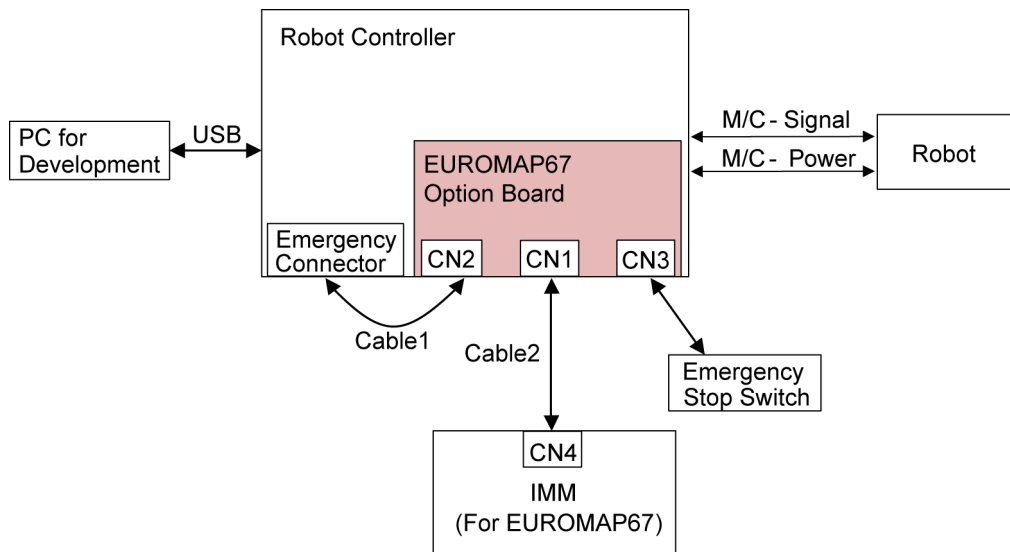

Two EUROMAP67 boards:

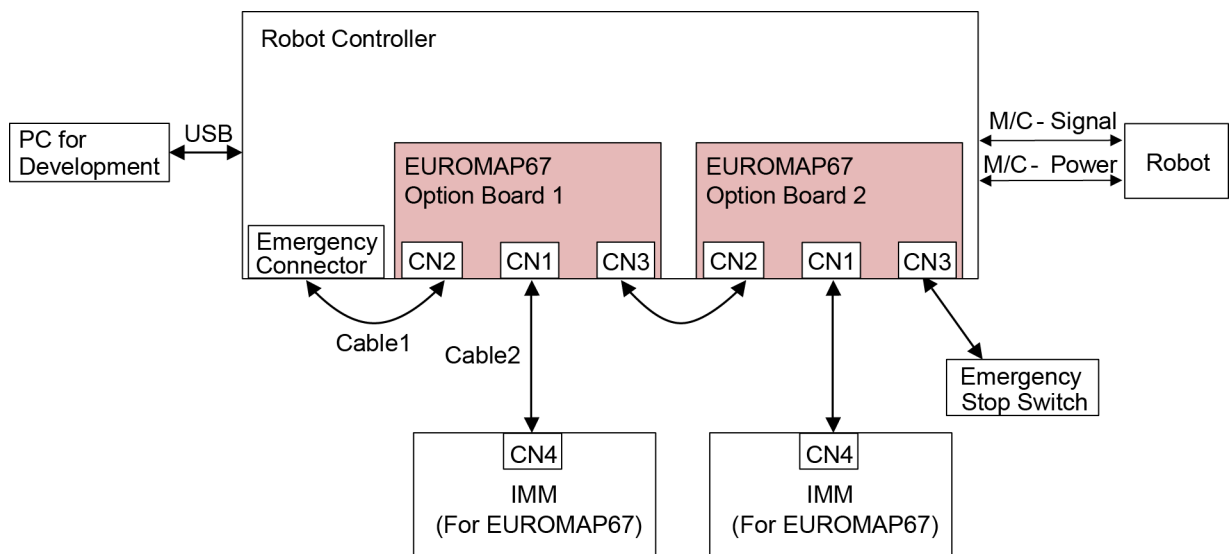

14.8.1 Notes on the EUROMAP67 Board

The EUROMAP67 board contains 15 inputs and 16 outputs on a single substrate.

You can install up to two EUROMAP67 board in the Controller.

The input and output bit numbers are assigned as follows.

Input Bit #	Output Bit #	Supported Hardware
192 to 206	192 to 208	The 1 st EUROMAP67 board
224 to 238	224 to 240	The 2 nd EUROMAP67 board

Outputs No.205 and No.237 are not used. However, the EUROMAP standard describes that they may potentially be used in the future.

EUROMAP67 pin definitions

EUROMAP connector (CN4) Pin No.	Signal Name	Note
ZA1 ZC1	Emergency stop of machine channel1	
ZA2 ZC2	Emergency stop of machine channel2	
ZA3 ZC3	Safety devices of machine channel1	
ZA4 ZC4	Safety devices of machine channel2	
ZA5	Reject	I/O Input (*1)
ZA6	Mold closed	I/O Input (*1)
ZA7	Mold open position	I/O Input (*1)
ZA8	Intermediate mold opening position	I/O Input (*1)
ZA9	Supply from handling device / robot	24V DC (Robot → IMM)
ZB2	Enable operation with handling device / robot	I/O Input (*1)
ZB3	Ejector back position	I/O Input (*1)
ZB4	Ejector forward position	I/O Input (*1)
ZB5	Core pullers 1 in position 1	I/O Input (*1)
ZB6	Core pullers 1 in position 2	I/O Input (*1)
ZB7	Core pullers 2 in position 1	I/O Input (*1)
ZB8	Core pullers 2 in position 2	I/O Input (*1)
ZC5	Reserved for future use by EUROMAP	I/O Input (*1)
ZC6	Reserved for future use by EUROMAP	I/O Input (*1)
ZC7	Reserved for future use by EUROMAP	I/O Input (*1)
ZC8	Not fixed by EUROMAP, manufacturer dependent	I/O Input (*1)
ZC9	Supply from handling device / robot	0V (Robot → IMM)
A1 C1	Emergency stop of robot channel1	
A2 C2	Emergency stop of robot channel2	
A3 C3	Mold area free	
A4 C4	Reserved for future use by EUROMAP	

EUROMAP connector (CN4) Pin No.	Signal Name	Note
A5	Not fixed by EUROMAP, manufacturer dependent	I/O Input (*1)
A6	Enable mold closure	I/O Input (*1)
A7	Enable full mold opening	I/O Input (*1)
A8	Reserved for future use by EUROMAP	I/O Input (*1)
A9	Supply from IMM	24V DC (IMM → Robot) (*1)
B2	Robot operation mode	I/O Input (*1)
B3	Enable ejector back	I/O Input (*1)
B4	Enable ejector forward	I/O Input (*1)
B5	Enable movement of core pullers 1 to position 1	I/O Input (*1)
B6	Enable movement of core pullers 1 to position 2	I/O Input (*1)
B7	Enable movement of core pullers 2 to position 1	I/O Input (*1)
B8	Enable movement of core pullers 2 to position 2	I/O Input (*1)
C5	Not fixed by EUROMAP, manufacturer dependent	I/O Input (*1)
C6	Reserved for future use by EUROMAP	I/O Input (*1)
C7	Reserved for future use by EUROMAP	I/O Input (*1)
C8	Not fixed by EUROMAP, manufacturer dependent	I/O Input (*1)
C9	Supply from IMM	0V (IMM → Robot)

*1: DO NOT input a voltage which exceeds 24V. Board may get damage and burnout.

14.8.2 Board Settings (EUROMAP67 Board)

Configure DIP-Switch (SW1) to enable the robot Controller to recognize the EUROMAP67 board.

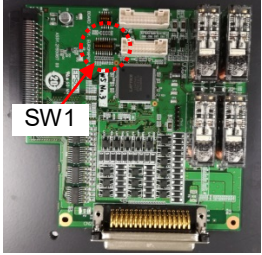
Board Appearance	Switch setting: Setup the DSW1	
	1 st board	2 nd board
	1 <input type="checkbox"/> ON	1 <input type="checkbox"/> ON
	2 <input type="checkbox"/> ON	2 <input type="checkbox"/> ON
	3 <input type="checkbox"/> ON	3 <input type="checkbox"/> ON
	4 <input type="checkbox"/> ON	4 <input type="checkbox"/> ON
	5 <input type="checkbox"/> ON	5 <input type="checkbox"/> ON
	6 <input type="checkbox"/> ON	6 <input type="checkbox"/> ON
	7 <input type="checkbox"/> ON	7 <input type="checkbox"/> ON
	8 <input type="checkbox"/> ON	8 <input type="checkbox"/> ON

14.8.3 Installation (EUROMAP67 Board)

- (1) Turn OFF the Controller.
- (2) Disconnect the power plug.
- (3) Remove the Top Panel. (Mounting screw ×6)
- (4) Insert the EUROMAP67 board into either slots 1, 2 or 3. (Slot 4 cannot be used.)
- (5) Use four screws to fix the EUROMAP67 board in place.

First, temporarily fasten the four screws in place. Next, fully tighten screws located diagonally opposite each other.

Take care not to damage the thread holes when doing so.

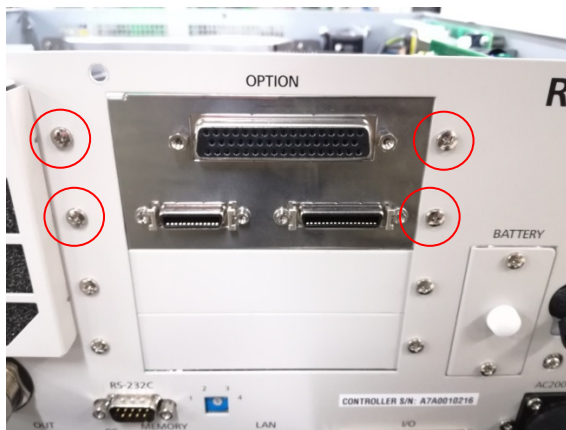

- (6) Connect “Cable1 CN2”.

Use a cross-point screwdriver to fasten the connector (CN2).

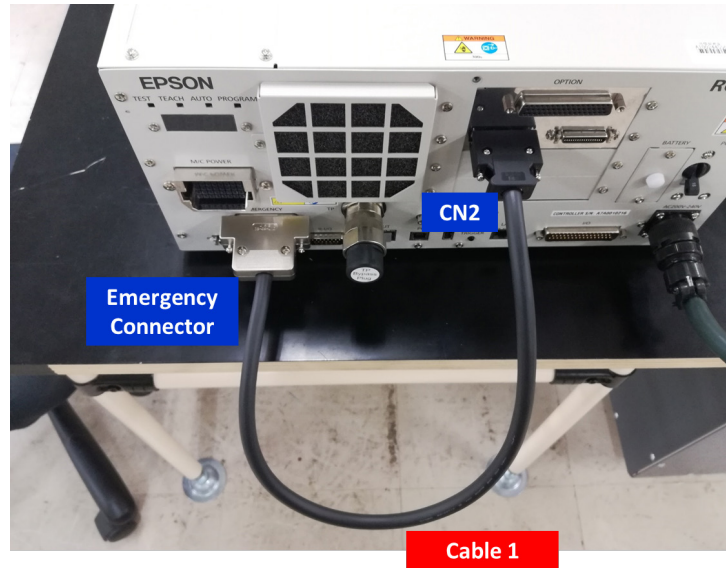

- (7) Refer to the following to connect CN3 to the emergency stop switch (emergency stop, safety door, latch).

Setup & Operation 9. EMERGENCY

- (8) Connect “CN3”.

Use a cross-point screwdriver to fasten the connector (CN3).

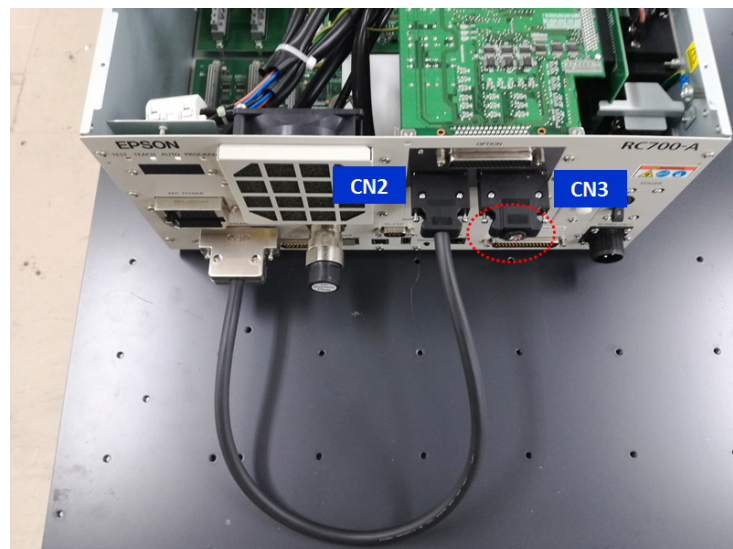

- (9) Connect “Cable2 CN1”.

Use a cross-point screwdriver to fasten the connector (CN1).

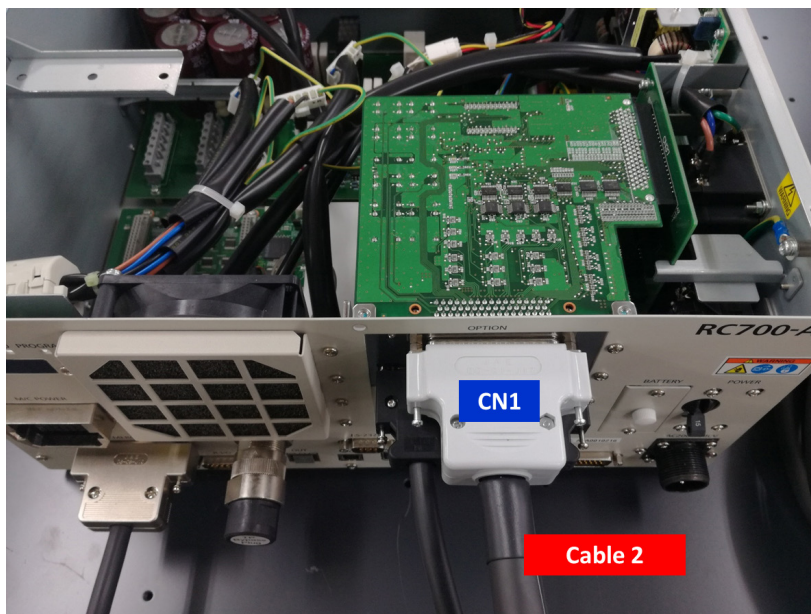

- (10) Mount the Top Panel. (Mounting screw ×6)

- (11) Connect “Cable2 CN4” to the IMM.

- (12) Connect the power plug. Turn ON the Controller and make sure that the Controller starts properly without any vibration or abnormal noise.

14.8.4 Confirming with EPSON RC+ 7.0 (EUROMAP67 Board)

The Controller software will automatically recognize the EUROMAP67 board when attaching it to the optional unit. This eliminates the need to configure software settings.

You can check whether the software has correctly recognized the EUROMAP67 board on the EPSON RC+ 7.0 screen.

- (1) Select EPSON RC+ 7.0 menu - [Setup] - [System Configuration] to display the [System Configuration] dialog box.

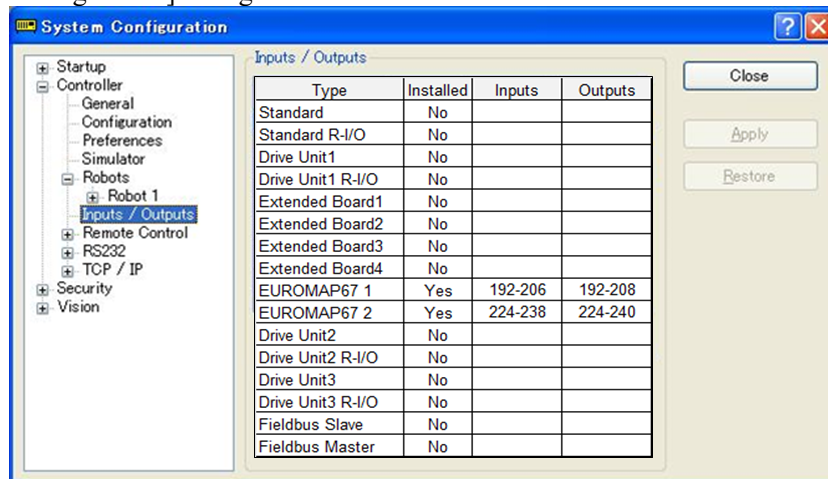

- (2) Select [Controller] - [Input/Output].

- (3) Check that the [Installed] is "Yes".

The EUROMAP67 board has been recognized by the Controller software.

You can now select the compatible inputs and outputs to use.

14.8.5 Sample Project (EUROMAP67 Board)

You can use a sample project of EUROMAP 67 board.

The following describes procedures to use the sample project.

- (1) Select EPSON RC+ 7.0 menu - [Project]-[Open..].
- (2) Select [Projects] - [Samples] - [Euromap67Demo1].
- (3) Click the <Open> button.
- (4) Modify the project depending on the IMM.

14.8.6 Circuit Overview (EUROMAP67 Board)

EUROMAP67 Board: System diagram

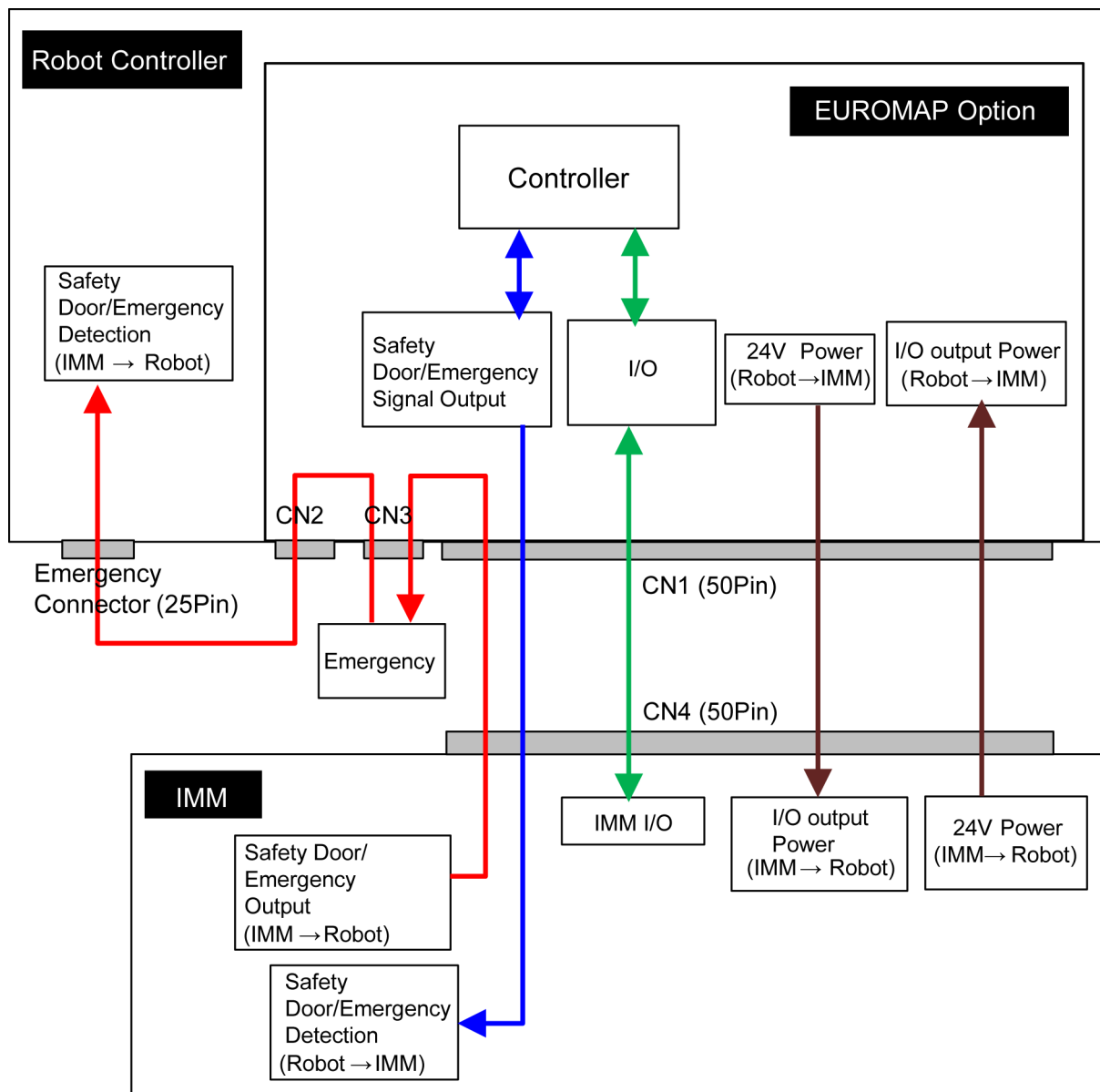

14.8.7 Input Circuit (EUROMAP67 Board)

Input Voltage Range : + 12 to 24 V \pm 10 %
 ON Voltage : + 10.8 V (MIN.)
 OFF Voltage : + 5 V (MAX.)
 Input Current : 10 mA TYP / + 24 V input

14.8.8 Output Circuit (EUROMAP67 Board)

Rated Output Voltage : + 12 V to 24 V \pm 10 %
 Maximum Output Current : TYP 100 mA / 1 output
 Output Driver : PhotoMOS relay
 On-resistance (average) : 23.5 Ω or less

EUROMAP67 board input/output circuit overview

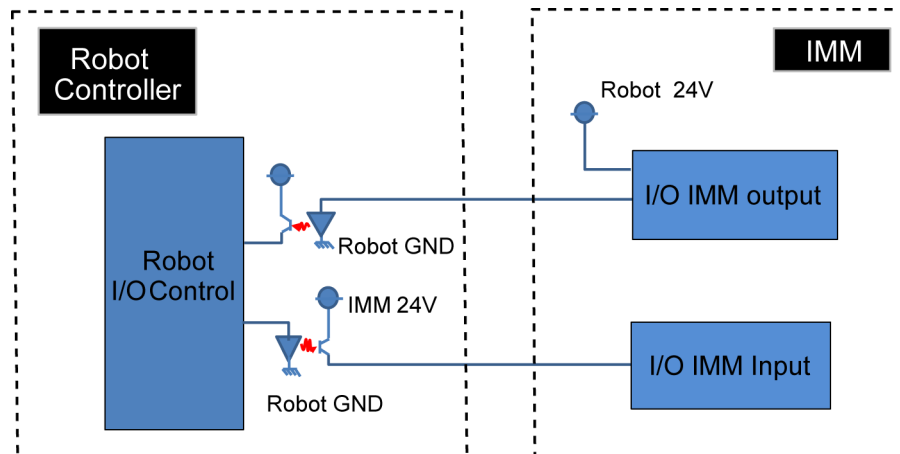

 CAUTION	<ul style="list-style-type: none"> ■ Input/output circuits do not have a built-in protection circuit to prevent short circuits or reverse connections. Take care to avoid wiring mistakes. Wiring mistakes may damage board parts and prevent the robot system from functioning properly. ■ Do not use a higher than rated voltage or current. Doing so may damage board parts and prevent the robot system from functioning properly. ■ Note that the I/O logic for controlling the IMM will vary depending on the molding machine. Confirm the proper logic to use before creating programs.
--	--

14.8.9 Emergency Stop, Safeguard (EUROMAP67 Board)

When the emergency stop switch is held down on the robot Controller:

A function is used to communicate the emergency stop instruction to the IMM.

The emergency stop instruction is communicated using a safety relay. A deposition detection function is also provided.

→ When deposition is detected, the robot Controller will set the emergency stop instruction communicated to the IMM to OPEN.

When an emergency stop occurs on the IMM side:

A function is used to communicate the emergency stop instruction to the robot Controller.

When the safety door has been opened on the IMM side:

A function is used to communicate the open safeguard instruction to the robot Controller.

EUROMAP67 Board: Overview of Emergency stop circuit

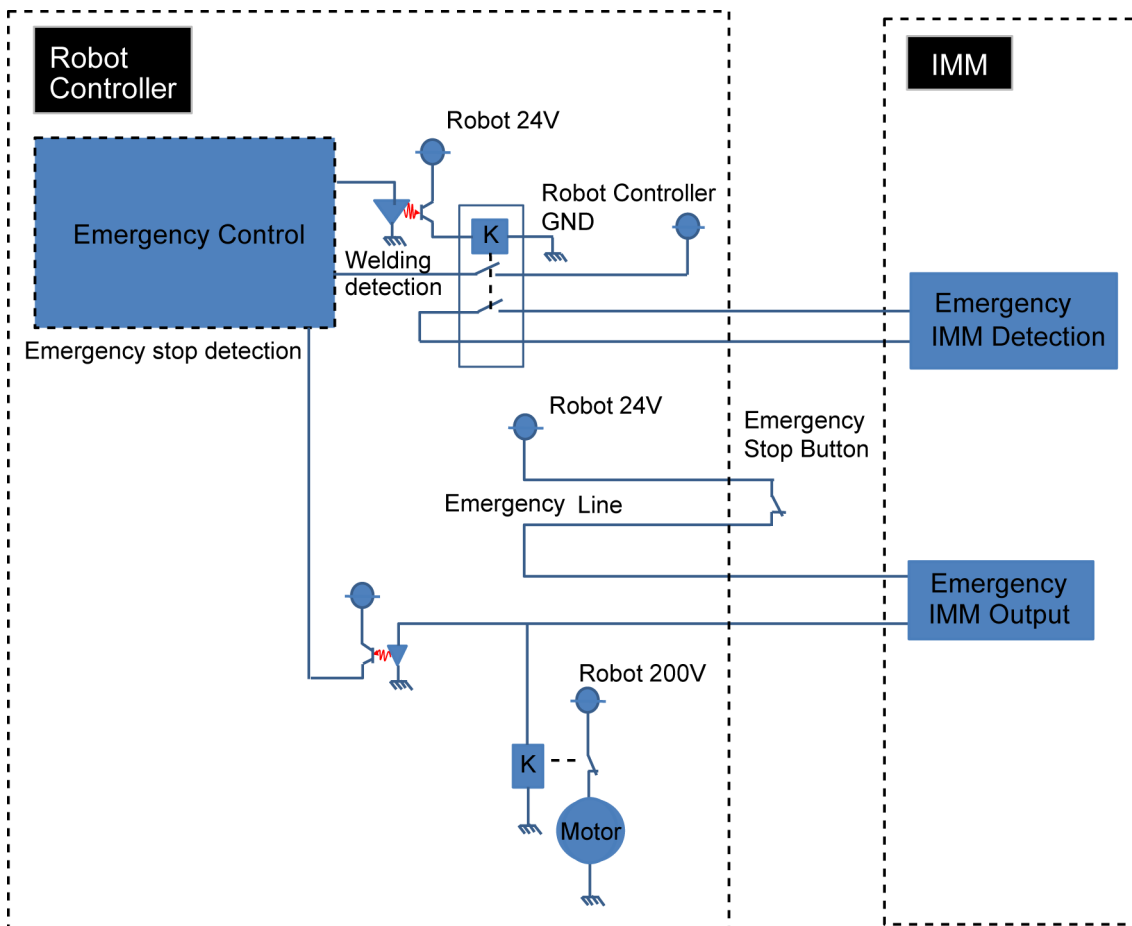

EUROMAP67 Board: Overview of Safety Door circuit

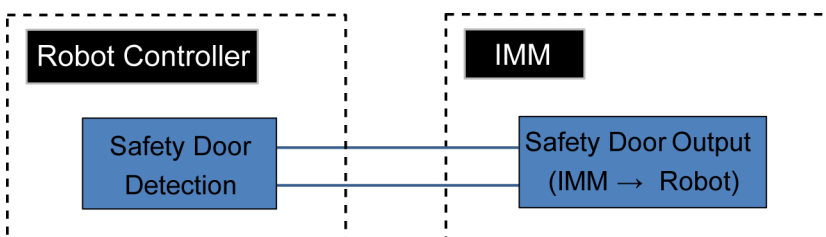

14.8.10 I/O Pin Assignments (EUROMAP67 Board)

I/O Pin Assignment table of the 1st EUROMAP67 board.

Signal Name	D-Sub connector (CN1) Pin No.	EUROMAP67 connector (CN4) Pin No.
Input No.192	33	ZA5 (*1)
Input No.193	32	ZA6 (*1)
Input No.194	50	ZA7 (*1)
Input No.195	49	ZA8 (*1)
Input No.196	48	ZB2 (*1)
Input No.197	47	ZB3 (*1)
Input No.198	31	ZB4 (*1)
Input No.199	30	ZB5 (*1)
Input No.200	15	ZB6 (*1)
Input No.201	14	ZB7 (*1)
Input No.202	46	ZB8 (*1)
Input No.203	45	ZC5 (*1)
Input No.204	29	ZC6 (*1)
Input No.205	28	ZC7 (*1)
Input No.206	13	ZC8 (*1)
Output No.192	41	A6 (*1)
Output No.193	7	A7 (*1)
Output No.194	8	A8 (*1)
Output No.195	24	B2 (*1)
Output No.196	25	B3 (*1)
Output No.197	42	B4 (*1)
Output No.198	43	B5 (*1)
Output No.199	9	B6 (*1)
Output No.200	10	B7 (*1)
Output No.201	26	B8 (*1)
Output No.202	27	C6 (*1)
Output No.203	11	C7 (*1)
Output No.204	4/3	A3/C3 (ModuleArea+/ModuleArea-)
Output No.205 (Not Used)	37/36	A4/C4 (Not Used)
Output No.206	12	C8 (*1)
Output No.207	40	A5 (*1)
Output No.208	44	C5 (*1)
24V (IMM)	1	A9 (*1)
GND (IMM)	2	C9 (*1)
Emergency1 (IMM)	39/38	ZA1/ZC1
Emergency2 (IMM)	21/20	ZA2/ZC2
Safety1 (IMM)	6/5	ZA3/ZC3
Safety2 (IMM)	23/22	ZA4/ZC4
24V (Robot)	17	ZA9
GND (Robot)	16	ZC9
Emergency1 (Robot)	35/34	A1/C1
Emergency2 (Robot)	19/18	A2/C2

*1: DO NOT input a voltage which exceeds 24V. Board may get damage and burnout.

I/O Pin Assignment table of the 2nd EUROMAP67 board.

Signal Name	D-Sub connector (CN1) Pin No.	EUROMAP67 connector (CN4) Pin No.
Input No.224	33	ZA5 (*1)
Input No.225	32	ZA6 (*1)
Input No.226	50	ZA7 (*1)
Input No.227	49	ZA8 (*1)
Input No.228	48	ZB2 (*1)
Input No.229	47	ZB3 (*1)
Input No.230	31	ZB4 (*1)
Input No.231	30	ZB5 (*1)
Input No.232	15	ZB6 (*1)
Input No.233	14	ZB7 (*1)
Input No.234	46	ZB8 (*1)
Input No.235	45	ZC5 (*1)
Input No.236	29	ZC6 (*1)
Input No.237	28	ZC7 (*1)
Input No.238	13	ZC8 (*1)
Output No.224	41	A6 (*1)
Output No.225	7	A7 (*1)
Output No.226	8	A8 (*1)
Output No.227	24	B2 (*1)
Output No.228	25	B3 (*1)
Output No.229	42	B4 (*1)
Output No.230	43	B5 (*1)
Output No.231	9	B6 (*1)
Output No.232	10	B7 (*1)
Output No.233	26	B8 (*1)
Output No.234	27	C6 (*1)
Output No.235	11	C7 (*1)
Output No.236	4/3	A3/C3 (ModuleArea+/ModuleArea-)
Output No.237 (Not Used)	37/36	A4/C4 (Not Used)
Output No.238	12	C8 (*1)
Output No.239	40	A5 (*1)
Output No.240	44	C5 (*1)
24V (IMM)	1	A9 (*1)
GND (IMM)	2	C9 (*1)
Emergency1 (IMM)	39/38	ZA1/ZC1
Emergency2 (IMM)	21/20	ZA2/ZC2
Safety1 (IMM)	6/5	ZA3/ZC3
Safety2 (IMM)	23/22	ZA4/ZC4
24V (Robot)	17	ZA9
GND (Robot)	16	ZC9
Emergency1 (Robot)	35/34	A1/C1
Emergency2 (Robot)	19/18	A2/C2

*1: DO NOT input a voltage which exceeds 24V. Board may get damage and burnout.

14.8.11 Emergency stop connector Pin Assignments (EUROMAP67 Board)

Emergency stop connector (CN2) Pin Assignment table of the EUROMAP67 board.

Emergency stop connector (CN2) Pin No.	Signal Name	Function
1	ESW11	Emergency Stop switch contact
2	ESW12	Emergency Stop switch contact
3	ESTOP1+	Emergency Stop circuit 1+
4	ESTOP1-	Emergency Stop circuit 1-
5	Not Used	-
6	Not Used	-
7	SD11	Safety Door input 1
8	SD12	Safety Door input 1
9	24V	24V output
10	24V	24V output
11	24VGND	24VGND output
12	24VGND	24VGND output
13	Not Used	-
14	ESW21	Emergency Stop switch contact
15	ESW22	Emergency Stop switch contact
16	ESTOP2+	Emergency Stop circuit 2+
17	ESTOP2-	Emergency Stop circuit 2-
18	SDLATCH1	Safety Door Latch Release
19	SDLATCH2	Safety Door Latch Release
20	SD21	Safety Door input 2
21	SD22	Safety Door input 2
22	24V	24V output
23	24V	24V output
24	24VGND	24VGND output
25	24VGND	24VGND output
26	Not Used	-

Emergency stop connector (CN3) Pin Assignment table of the EUROMAP67 board.

Emergency stop connector (CN3) Pin No.	Signal Name	Function
1	ESW11	Emergency Stop switch contact
2	ESW12	Emergency Stop switch contact
3	ESTOP1+	Emergency Stop circuit 1+
4	ESTOP1-	Emergency Stop circuit 1-
5	Not Used	-
6	Not Used	-
7	SD11	Safety Door input 1
8	SD12	Safety Door input 1
9	24V	24V output
10	24V	24V output
11	24VGND	24VGND output
12	24VGND	24VGND output
13	Not Used	-
14	ESW21	Emergency Stop switch contact
15	ESW22	Emergency Stop switch contact
16	ESTOP2+	Emergency Stop circuit 2+
17	ESTOP2-	Emergency Stop circuit 2-
18	SDLATCH1	Safety Door Latch Release
19	SDLATCH2	Safety Door Latch Release
20	SD21	Safety Door input 2
21	SD22	Safety Door input 2
22	24V	24V output
23	24V	24V output
24	24VGND	24VGND output
25	24VGND	24VGND output
26	Not Used	-
27	Not Used	-
28	Not Used	-
29	Not Used	-
30	Not Used	-
31	Not Used	-
32	Not Used	-
33	Not Used	-
34	Not Used	-
35	Not Used	-
36	Not Used	-

Maintenance

This section contains maintenance procedures for the Robot Controller.

1. Safety Precautions on Maintenance

 WARNING	<ul style="list-style-type: none"> ■ Only authorized personnel who have taken the safety training should be allowed to execute teaching or calibration of the robot system. The safety training is the program for industrial robot operator that follows the laws and regulations of each nation. The personnel who have taken the safety training acquire knowledge of industrial robots (operations, teaching, etc.). The personnel who have completed the robot system-training class held by the manufacturer, dealer, or locally-incorporated company are allowed to maintain the robot system. ■ Only authorized personnel who have taken the safety training should be allowed to maintain the robot system. The safety training is the program for industrial robot operator that follows the laws and regulations of each nation. The personnel who have taken the safety training acquire knowledge of industrial robots (operations, teaching, etc.), knowledge of inspections, and knowledge of related rules/regulations. The personnel who have completed the robot system-training and maintenance training classes held by the manufacturer, dealer, or locally-incorporated company are allowed to maintain the robot system. ■ Make sure to use only dedicated/specified maintenance parts especially for the optional boards or any other parts in the Controller to be replaced. Using non-specified parts may cause serious damage to the robot system and/or serious safety problems. ■ Do not remove any parts that are not covered in this manual. Follow the maintenance procedure strictly as described in this manual. Do not proceed using any methods other than described in this manual when you do replace a part or maintain the equipment. Improper removal of parts or improper maintenance may cause not only improper function of the robot system but also serious safety problems.
--	---

 WARNING	<ul style="list-style-type: none"> ■ Before performing any maintenance procedure, always make sure that the main power of the Controller is turned OFF, disconnect the power supply, and that the high voltage charged area is completely discharged. Performing any maintenance procedure while the main power is ON or the high voltage charged area isn't discharged completely is extremely hazardous and may result in electric shock and/or cause serious safety problems.
--	---

 CAUTION	<ul style="list-style-type: none"> ■ Do not touch the Motor Driver modules and Switching Power Supply directly in the Controller. The metal resistance of these can become very hot and may result in a burn. If you maintain them, examine the surface temperatures and wear protective gloves if necessary. ■ Do not shock, shake, or drop any parts during maintenance. When the parts related with data are shocked physically, they may be damaged and may also cause data loss during data loading/saving.
--	--

 <p>CAUTION</p>	<ul style="list-style-type: none">■ Do not lose the screws removed at maintenance. When the screw is dropped into the Controller, be sure to take it out. Leaving the screw in the Controller may cause short circuit and may result in equipment damage to the parts and/or robot system.■ Make sure that the power rating (wattage) of a new Motor Driver module is correct. Using a Motor Driver module with improper power rating (wattage) in the Controller may cause improper function of the robot system and errors.■ The serial number of the Manipulator that should be connected is indicated on the Connection Check Label on the Controller. Connect the Controller and the Manipulator correctly. Improper connection between the Controller and the Manipulator may cause not only improper function of the robot system but also serious safety problems.
--	--

 NOTE Before performing maintenance on the Controller, all the data must be copied as a backup. The details of data backup/restore are described in the *Maintenance 4. Backup and Restore*.

2. Regular Maintenance Inspection

Performing regular maintenance inspection properly is essential for preventing trouble and maintaining safety. This chapter describes the schedules for maintenance inspection and procedures.

Be sure to perform the maintenance inspections in accordance with the schedules.

Part Content	Fan filter		Fan (Front)	Fan (Rear)	Battery
	Cleaning	Replacement	Replacement	Replacement	Replacement
Code	-	2195106	2157260	2157260	2113554
Quantity	-	1	1	1	1
Maintenance interval	More than once a month is recommended	When the filter gets deteriorated	When the error 515 occurs, or when the abnormal noise occurs	When the error 516 occurs, or when the abnormal noise occurs	Every 5 years, or when the error 511 occurs
Possible malfunction if maintenance is not performed	The temperature inside the Controller may get too high and the robot system may not operate properly. The error may occur due to reduction of the fan rotation.	The robot system may not operate properly due to dust or the like.	The error 9015 occurs and the robot system may stop.	The error 9016 occurs and the robot system may stop.	The error 9011 occurs and the robot system may stop.
Duration (reference)	5 minutes	5 minutes	20 minutes	15 minutes	5 minutes
Reference: Maintenance	7.1 <i>Fan Filter</i>	7.1 <i>Fan Filter</i>	7.2.1 <i>Front Fan</i>	7.2.2 <i>Fan2(RC700-A only)</i>	7.3 <i>Battery</i>
Expected product life	-	-	30,000 hours	30,000 hours	-

3. Controller Structure

3.1 Location of Parts

3.1.1 RC700

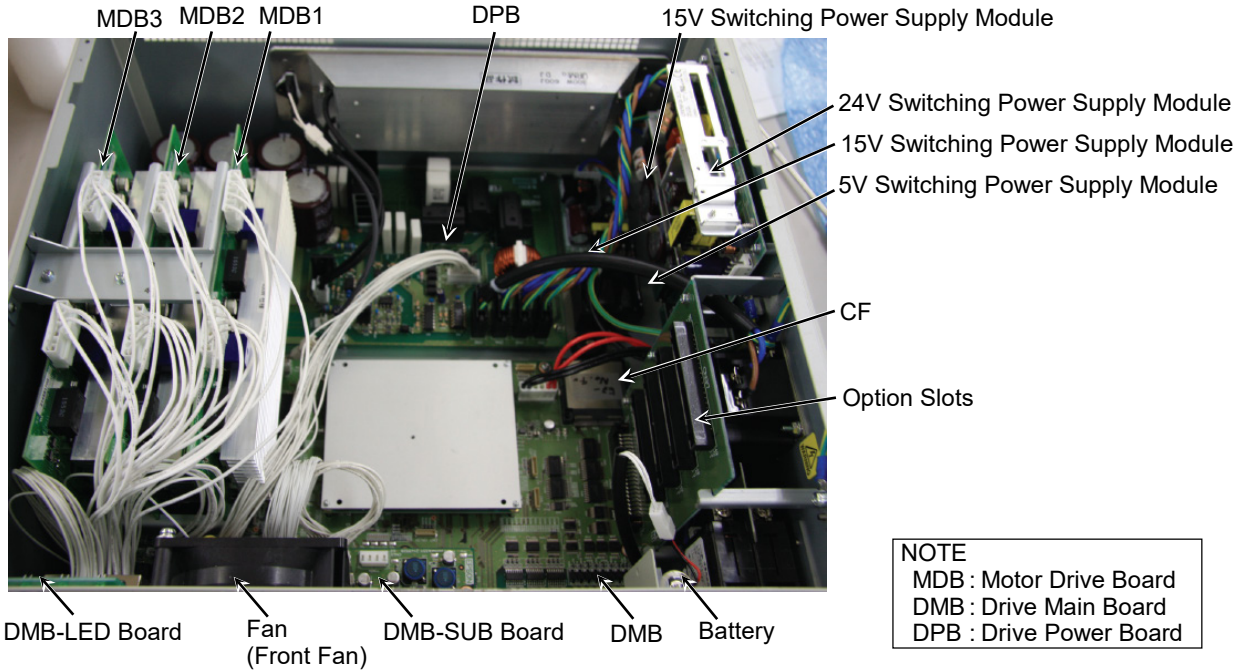

3.1.2 RC700-A

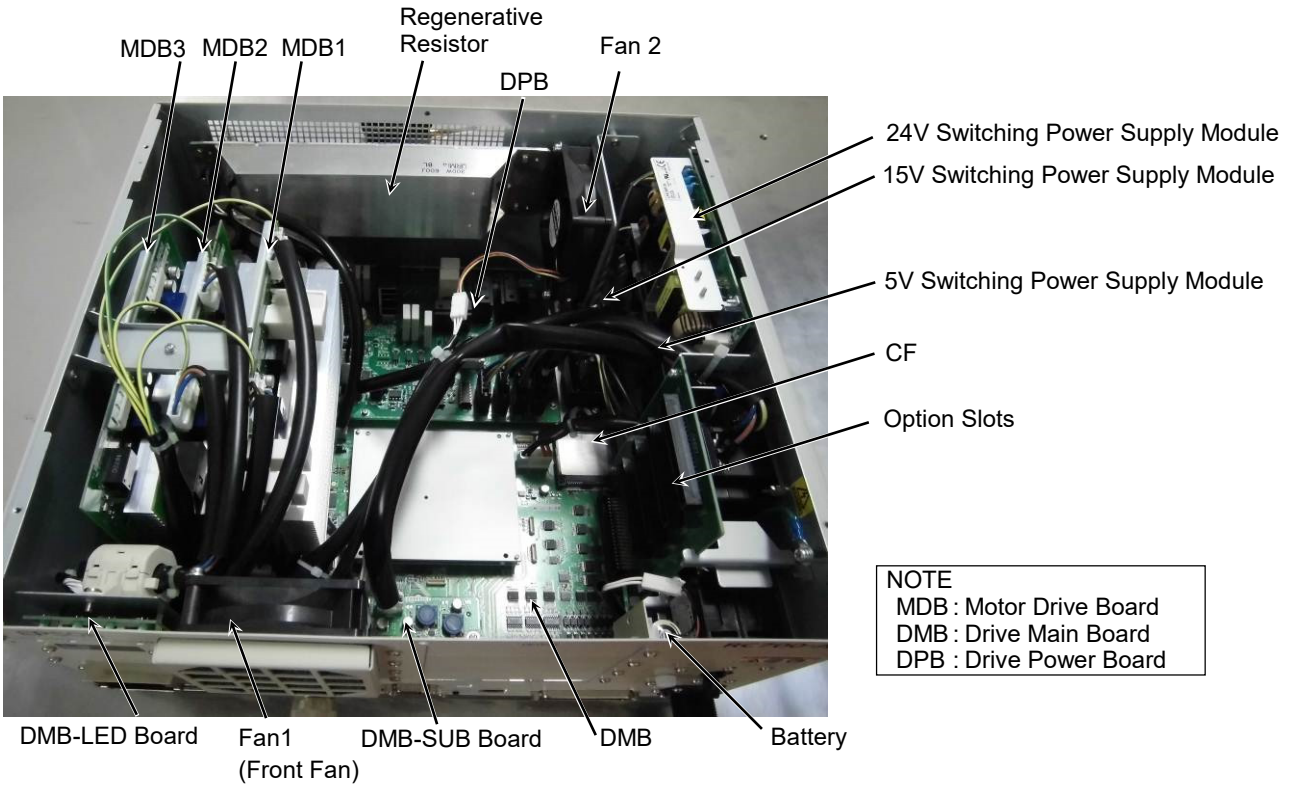

* MDB3 is not supplied for G1, G3, G6, G10, G20, and RS.

3.2 Diagram of Cable Connections

3.2.1 RC700

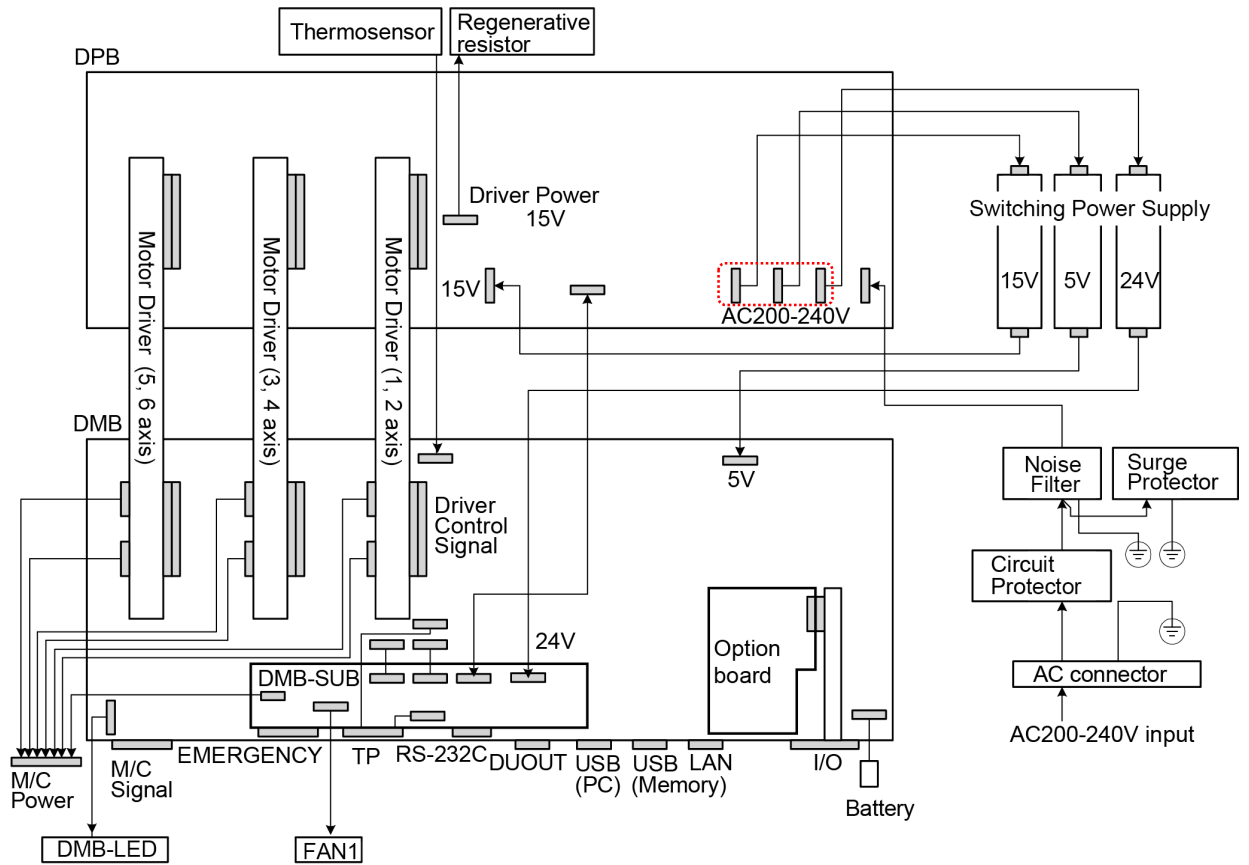

(Connectors in the red dotted line work properly in any order.)

3.2.2 RC700-A

C4, C8, C12, G1, G3, G6, G10, G20, RS, X5

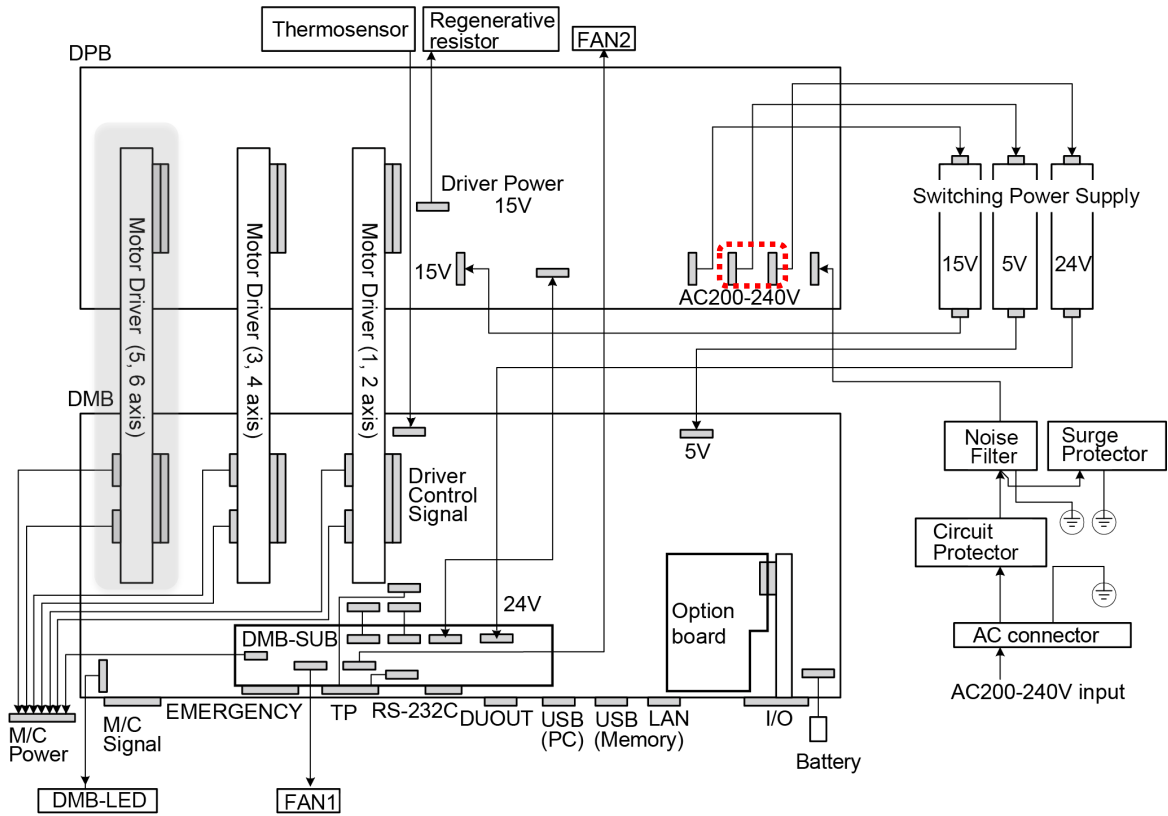

(Motor Driver (5, 6 axis) is not supplied for G1, G3, G6, G10, G20,RS and X5.)
 (Connectors in the red dotted line work properly in any order.)

N2, N6

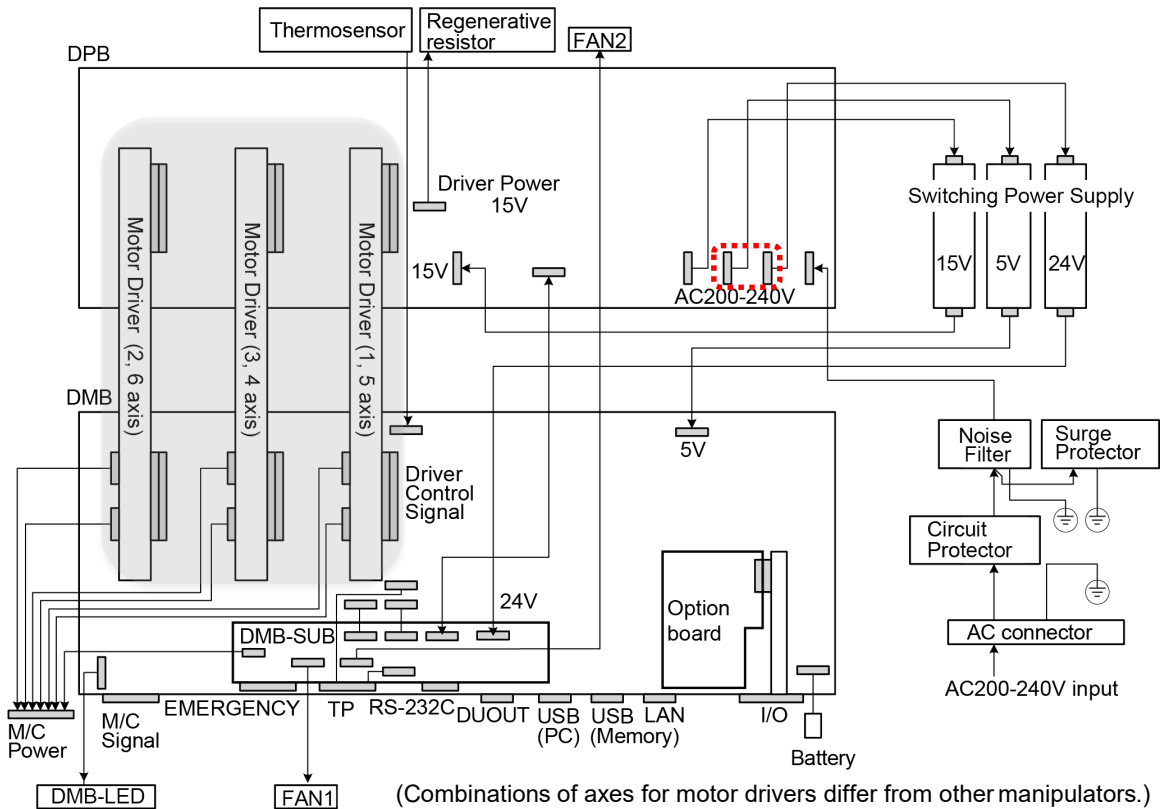

(Combinations of axes for motor drivers differ from other manipulators.)
 (Connectors in the red dotted line work properly in any order.)

4. Backup and Restore

4.1 What is the Backup Controller Function?

The Controller configuration set by EPSON RC+ 7.0 can be stored with the “Backup Controller” function.

The Controller settings can be restored easily using the data previously stored with “Backup Controller” after a configuration mistake or Controller problem.

Be sure to execute “Backup Controller” before changing the Controller setup, before maintenance, or after teaching.

For some problems, backup may not be available before maintenance has to be performed. Be sure to backup the data after making changes, before problems occur.

NOTE  “Controller status storage function” is one of the RC700 / RC700-A functions. It saves the Controller setup data same as “Backup Controller.”

There data can be used as the backup data at restoring.

The methods for “Controller Status Storage” are as follows:

A : “Controller backup to the USB memory”

For details, refer to *Setup & Operation 6. Memory Port*.

B : “Export Controller backup function” in EPSON RC+ 7.0.

For details, refer to *EPSON RC+ 7.0 User’s Guide 5.9.9 Import Command (Project Menu)*.

4.2 Backup Data Types

The table below shows the files created with “Backup Controller”.

File Name	Overview	
Backup.txt	Information file for restore	File including information for restoring the Controller.
CurrentMnp01.PRM	Robot parameters	Stores information such as TlSet.
InitFileSrc.txt	Initial configuration	Stores various Controller parameters.
MCSys01.MCD	Robot configuration	Stores connected Robot information.
All the files related to Project	Project related	All the project files transferred to the Controller. Includes program files when EPSON RC+ 7.0 is configured to transfer source code to the Controller.
GlobalPreserves.dat	Global Preserve variables	Saves values of Global Preserve variables.
WorkQueues.dat	WorkQue information	Saves information of Queues information of the WorkQue.

4.3 Backup

Backup the Controller status from the EPSON RC+ 7.0.

- (1) Select EPSON RC+ 7.0 menu-[Tools]-[Controller] to display the [Controller Tools] dialog.

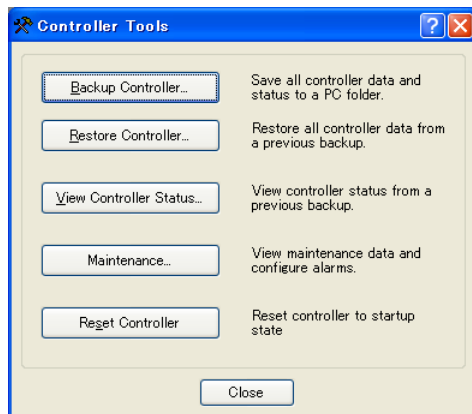

- (2) Click the <Backup Controller...> button to display the [Browse For Folder] dialog.



- (3) Specify the folder to save the backup data. Create a new folder if desired.
- (4) Click the <OK> button. A folder is created in the specified folder containing the backup data with a name in the following format.

B_ RC700_ serial number_ date status was saved
 → Example: B_ RC700_ 12345_ 2013-10-29-092951

 CAUTION	<ul style="list-style-type: none"> Do not edit the backup files. Otherwise, operation of the robot system after data restoration to the Controller is not assured.
---	---

4.4 Restore

Restore the Controller status from the EPSON RC+ 7.0.

 CAUTION	<ul style="list-style-type: none"> ■ Make sure that the data used for restore was saved previously for same Controller. ■ Do not edit the backup files. Otherwise, operation of the robot system after data restoration to the Controller is not assured.
---	---

- (1) Select the EPSON RC+ 7.0 menu-[Tools]-[Controller] to display the [Controller Tools] dialog.

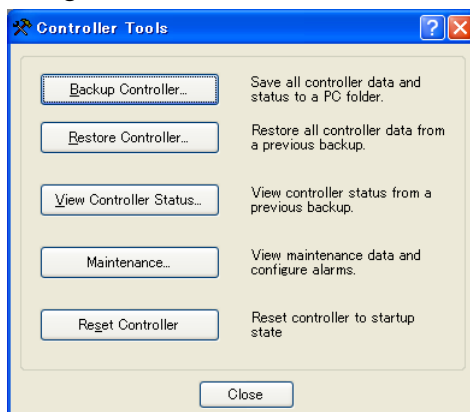

- (2) Click the <Restore Controller...> button to display the [Browse For Folder] dialog.

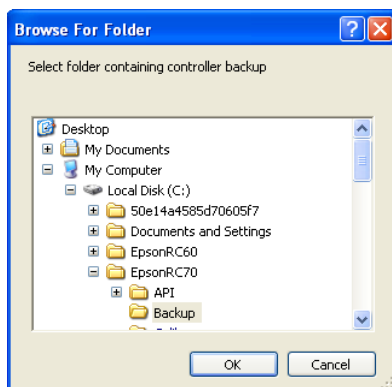

- (3) Specify the folder that contains the backup data. Backup data folders are named using the following format:

B_ RC700_ serial number_ date status was saved

→ Example: B_ RC700_ 12345_ 2011-04-03_ 092941



Data saved to the USB memory by the Backup Controller function can also be specified for restore.

- (4) Click the <OK> button to display the dialog to select the restore data.

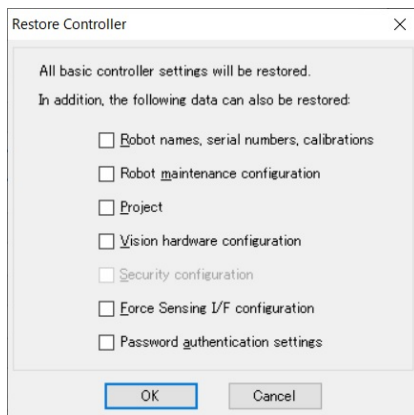

Robot name, serial #, calibration

This checkbox allows you to restore the robot name, robot serial number, Hof's data, and CalPl's data. Make sure that the correct Hof's data is restored. If the wrong Hof's data is restored, the robot may move to wrong positions.

This is not selected by the default setting.

Robot maintenance configuration

This checkbox allows you to restore the robot alarm related files.

For details, refer to *Maintenance 6 Alarm*.

This is not selected by the default setting.

Project

This checkbox allows you to restore the files related to projects.

The default is unchecked.

When a project is restored, the values of Global Preserve variables are loaded.

For details about Global Preserve variable backup, refer to *EPSON RC+ 7.0 User's Guide 5.10.10 Display Variables Command (Run Menu)*.

Vision hardware configuration

This checkbox allows you to restore the vision hardware configuration.

For details, refer to *EPSON RC+ 7.0 option Vision Guide 7.0*.

This is not selected by the default setting.

Security configuration checkbox

This checkbox allows you to restore the security configuration.

For details, refer to *EPSON RC+ 7.0 User's Guide 15. Security*.

This is not selected by the default setting.

Force Sensing I/F configuration

This checkbox allows you to restore the Force Sensing I/F configuration.

For details, refer to *EPSON RC+ 7.0 option Force Guide 7.0*.

This is not selected by the default setting.

Password authentication settings

This checkbox allows you to restore the setting of authentication for PC connection.

The authentication password for PC connection and the setting to disable connection authentication are restored.

This is not selected by the default setting.

- (5) Click the <OK> button to restore the system information.

NOTE

Restore the system configuration saved using Backup Controller only for the same system.

When different system information is restored, the following warning message appears.

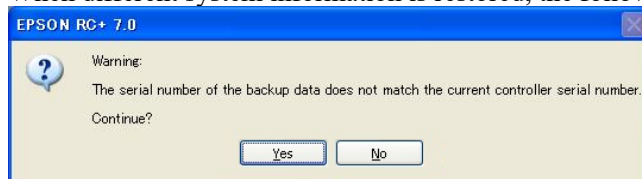

Click the <No> button (do not restore data) except for special situations such as Controller replacement.

NOTE

When restoring the backup which includes the data of the robot configured to the Drive Unit, be sure to restore the data while the Drive Unit is connected and turned ON.

NOTE

When restoring the backup including unsupported robot information to the target Controller, an error occurs.

5. Firmware Update

This chapter describes the firmware upgrade procedure and data file initialization when firmware or Robot configuration errors cause Controller startup or operation failure.

5.1 Updating Firmware

Firmware (software stored in non-volatile memory) and data files necessary to control the Controller and the Robot are preinstalled in the Controller. Controller configuration set from EPSON RC+ 7.0 is always saved in the Controller.

Controller firmware is supplied by CD-ROM as needed. Please contact the supplier of your region for information.

You must use a PC running EPSON RC+ 7.0 connected to a Controller with USB to update the Controller firmware. Firmware cannot be updated with an Ethernet connection.



When installing the firmware Ver.7.5.0.x or later, be sure to use the PC which EPSON RC+ 7.0 Ver.7.5.0 or later is installed.

5.2 Firmware Upgrade Procedure

The firmware upgrade procedure is described as follows:

- (1) Connect the development PC and the Controller with a USB cable (the firmware cannot be changed with an Ethernet connection).
- (2) Turn ON the Controller. (Do not start the development software EPSON RC+ 7.0 until the firmware upgrade is completed.)
- (3) Insert the “firmware CD-ROM” in the development PC CD-ROM drive.
- (4) Execute “Ctrlsetup70.exe”. The following dialog appears.
- (5) Select the <Upgrade> option button and click the <Next> button.

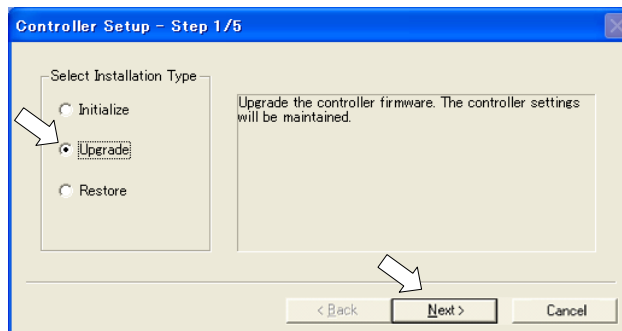

- (6) Make sure that the development PC is connected to the Controller with a USB cable and Click the <Next> button.

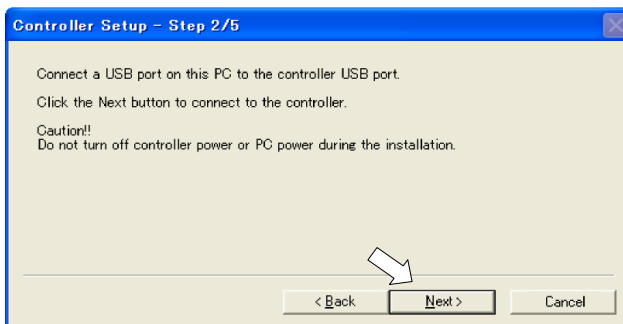

- (7) Check the current firmware version and the new firmware version and click the <Install> button.

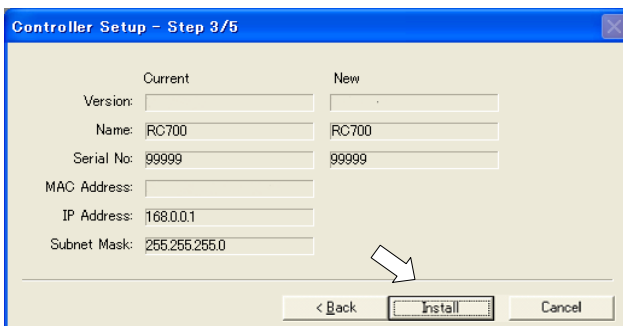

NOTE

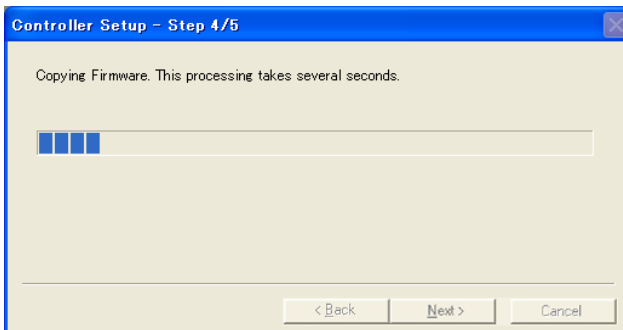

- (8) The firmware upgrade starts. It takes several minutes to complete. Do not disconnect the USB cable during transfer or turn OFF the Controller or the development PC.

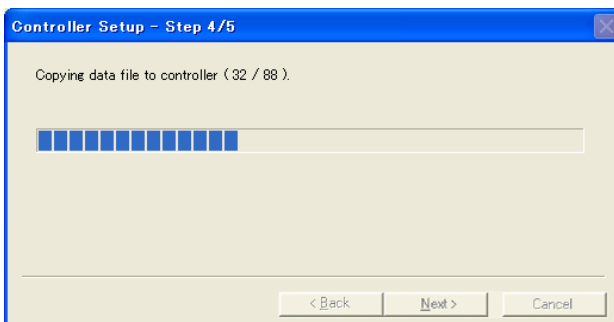

- (9) Continuous data file transfer starts.

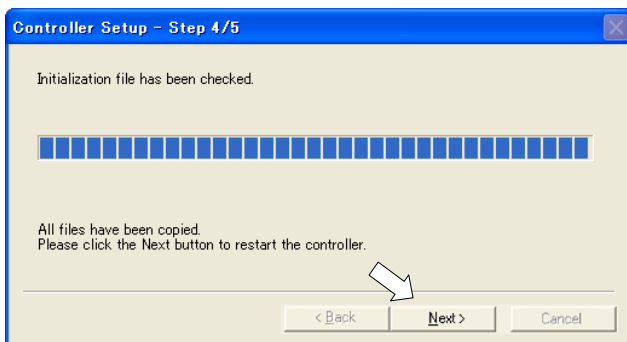

(10) The following dialog appears when transfer has completed. Click the <Next> button to reboot the Controller.



(11) The following dialog appears after the Controller reboot. Click the <Finish> button.

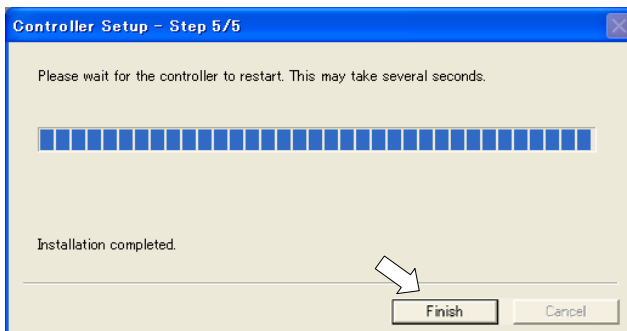

The firmware upgrade is complete.

NOTE

When you install the firmware (Ver.7.4.0.2 or later) on the Controller which the firmware (before Ver.7.4.0.2) has been installed, the following message is displayed.

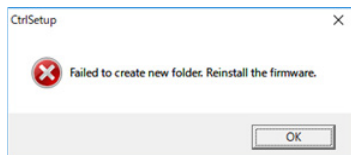

When the message is displayed, re-install the firmware.

5.3 Controller Recovery

If the Controller becomes inoperable, use the procedures described in this section to recover.

NOTE

Controller Backup is recommended for easy recovery of the Controller operation. For details of Controller Backup, refer to *Maintenance 4. Backup and Restore*.

The following two conditions describe the Controller error status after turning ON the Controller.

Condition A The Controller automatically changes to Recovery mode and the LED of ERROR, TEACH, and PROGRAM are lighting. You are able to communicate with the development PC though the Controller does not operate properly.

Condition B The LED of TEACH, AUTO, and PROGRAM do not blink.
Cannot communicate with the Controller using the development PC.

Countermeasure for the error status is as follows.

Condition A Follow *Maintenance 5.4 Firmware Initialization Procedure* to initialize the firmware.

Condition B Execute the following steps:

- (1) Turn OFF the Controller.
- (2) Push the trigger button located on the front side of the Controller and while holding the button in, turn ON the Controller. Continue to hold in the trigger button for 30 seconds. This will cause the Controller to start in Recovery mode.
- (3) Make sure that the LED of ERROR, TEACH, and PROGRAM are lighting.
- (4) Follow the procedure in *Maintenance 5.4 Firmware Initialization Procedure* from step (3) to initialize the firmware.

5.4 Firmware Initialization Procedure

The firmware initialization procedure described in this section.

- (1) Connect the development PC to the Controller with a USB cable (the firmware cannot be changed with an Ethernet connection).
- (2) Turn ON the Controller. Do not start the development software EPSON RC+ 7.0 until firmware initialization is complete.
- (3) Insert the “firmware CD-ROM” in the development PC CD-ROM drive.
- (4) Execute “Ctrlsetup.exe”.
- (5) Select the <Initialize> option button and click the <Next> button.

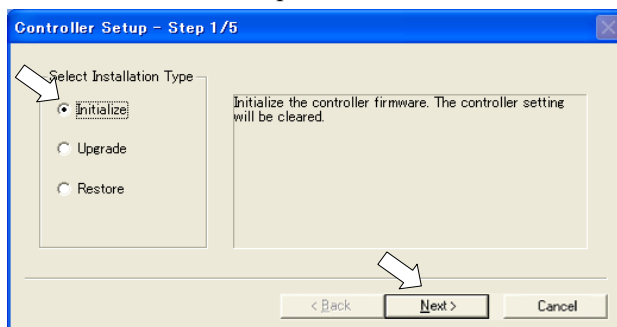

- (6) Make sure that the development PC is connected to the Controller with a USB cable and Click the <Next> button.

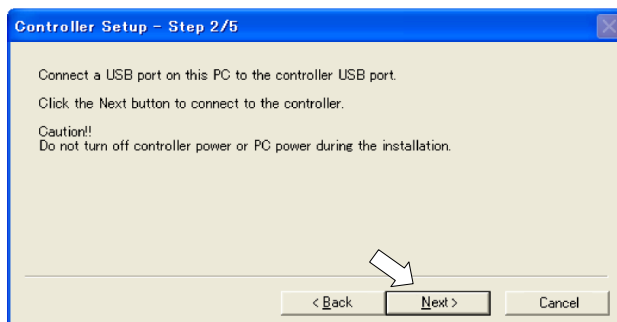

- (7) Check the version information and click the <Install> button.

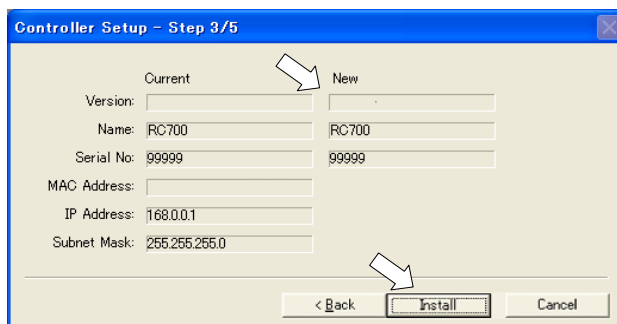

Firmware and data file transfer starts. It takes several minutes to complete.

NOTE

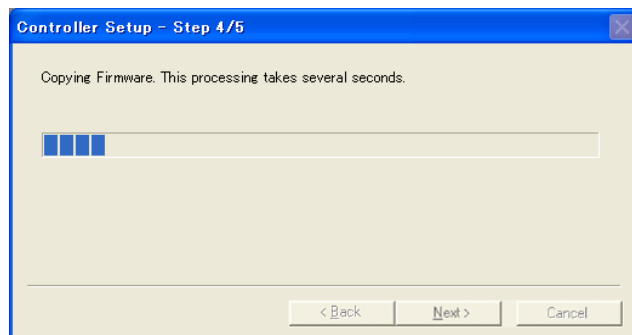

Do not disconnect the USB cable during transfer or turn OFF the Controller or the development PC.

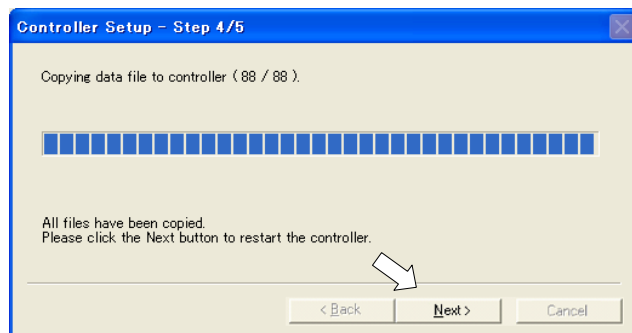

- (8) The following dialog appears when transfer is completed. Click the <Next> button to reboot the Controller.

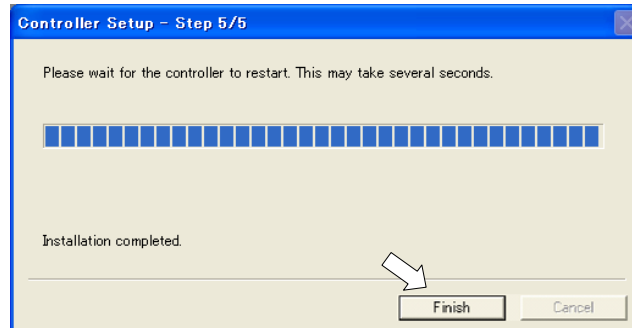

- (9) The following dialog appears after the Controller reboot. Click the <Finish> button.



The firmware upgrade is completed.

Start EPSON RC+ 7.0 and restore the Controller settings.

For details of restoring the operating system, refer to *Maintenance 4. Backup and Restore*.

NOTE

When you install the firmware (Ver.7.4.0.2 or later) on the Controller which the firmware (before Ver.7.4.0.2) has been installed, the following message is displayed.

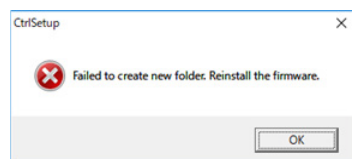

When the message is displayed, re-install the firmware.

5.5 Adding Confirmation Steps by Strengthening Security of EtherNet Connection

From the following firmware version password authentication is required when connecting Controllers and PCs to a global accessible network.

F/W : Ver.7.4.8.x

In the following cases, connections of EtherNet (PC) connector and Remote Ethernet are not available.

- Controller IP address is set to global IP address
- Firmware version is 7.4.8.x or later
- EPSON RC+7.0 is Ver.7.4.7 or before

When the Controller firmware is updated under the following conditions, additional steps to confirm whether to continue the firmware update may be execute depending on the configuration settings of the Controller. (step 3 or later shown below)

- Controller IP address is set to global IP address
- Firmware version to be installed is 7.4.8.x or later

The following describes the steps to confirm whether to continue the firmware update.

- (1) Insert “Firmware CD-ROM” to be installed into the CD-ROM driver of the development PC.
- (2) Execute “CtrlSetup70.exe”.
- (3) Controller Setup window is displayed.

Select the <Upgrade> button and click the <Next> button.

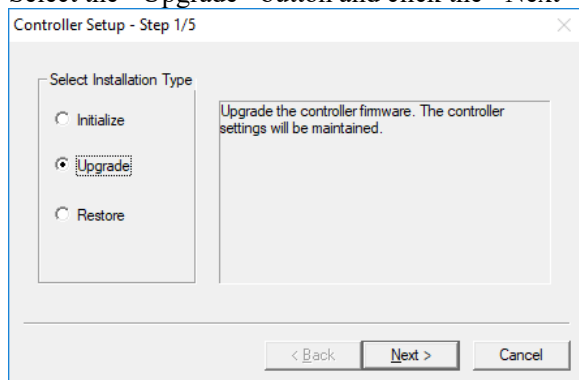

- (4) Step 2 window is displayed.
Click the <Next> button.

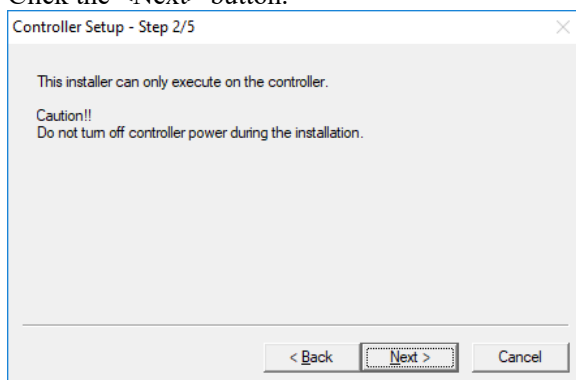

- (5) Step 3 window is displayed.

- (5)-1 When the steps to confirm whether to continue the firmware update is not executed:
Step 3 window is displayed.
Follow the instructions on the window and install the firmware.

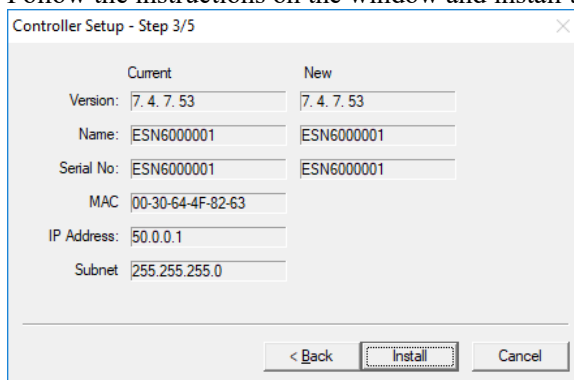

- (5)-2 When the steps to confirm whether to continue the firmware update is executed:
The following window is displayed.

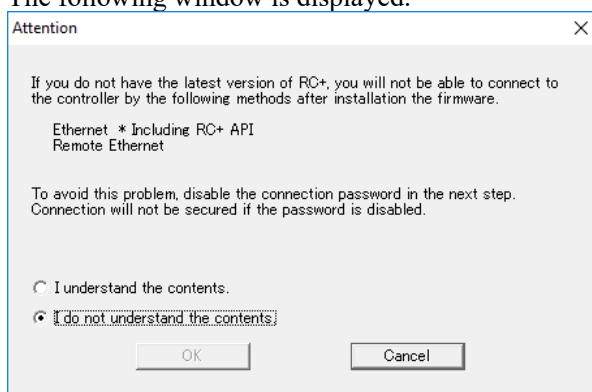

When the <I understand the contents> button is selected, the <OK> button will be enabled.

When the <OK> button is clicked, Step3 window is displayed. Go to the step (6).
When the <Cancel> button is clicked, Step3 window is displayed. The [Disable connection password] checkbox and the <Install> button will be grayed out and cannot be selected.

(6) Step 3 window is displayed.

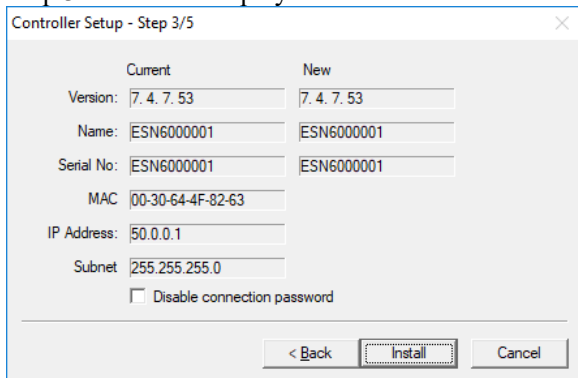

(6)-1 If the [Disable connection password] checkbox is selected, connection authentication after updating the firmware is disabled.

(6)-2 If the <Install> button is clicked, the confirmation window is displayed.

When the [Disable connection password] checkbox is selected:

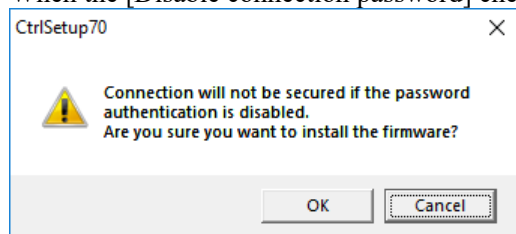

When the [Disable connection password] checkbox is not selected:

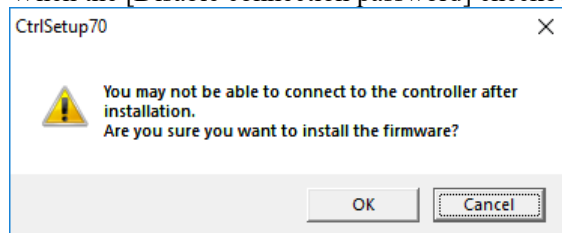

When the <OK> button is clicked, Step 4 window is displayed. Go to the step (7).

When the <Cancel> button is clicked, the window is closed.

(7) Firmware installation starts.

When the firmware is installed, click the <Next> button. Reboot the Controller.

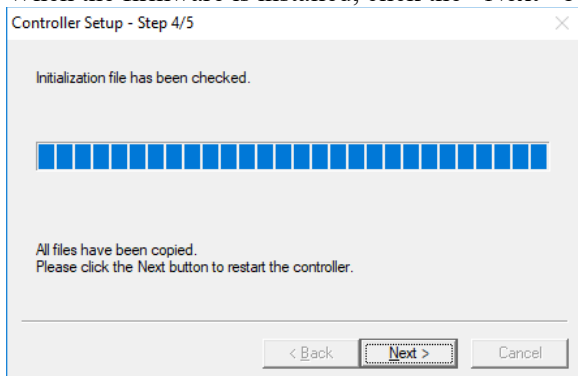

- (8) When the Controller is rebooted, the following window is displayed.
Confirm that the firmware is installed.
Click the <Finish> button.

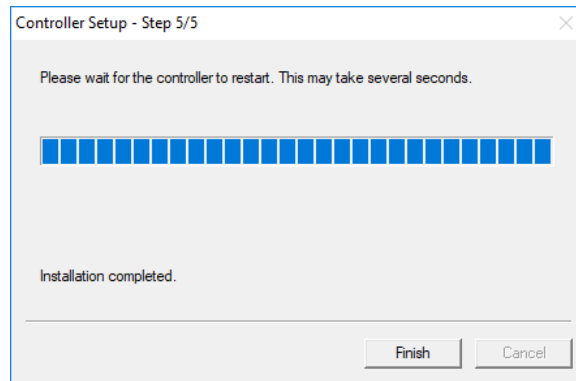

6. Alarm

When the batteries (lithium batteries) for the Controller and the Manipulator drain, an alarm warning voltage reduction occurs. However, the alarm does not guarantee the battery lives until replacement, and it is necessary to replace the batteries immediately. If you run out the batteries, the robot parameters will be lost and recalibration of the robot will be required.

In addition, the parts for the Manipulator joints may cause accuracy decline or malfunction due to deterioration of the parts resulting from long term use. If the robot breaks down due to deterioration of the parts, it will take significant time and cost for repair.

The following sections describe the alarm function which announces the following maintenance timings in order to perform maintenance well ahead of time before the warning error.

The maintenance timings to be announced differ depending on the Controller firmware version.

Refer to the section according to the firmware version of your Controller.

Controller firmware Ver.	Maintenance items
Before Ver.7.1.8.x	<ul style="list-style-type: none"> - Controller battery replacement - Robot battery replacement - Grease up
Ver.7.2.0.x or later	<ul style="list-style-type: none"> - Controller battery replacement - Robot battery replacement - Grease up - Replacement of the timing belt - Replacement of the motor - Replacement of the reduction gear unit - Replacement of the ball screw spline unit

6.1 Before Controller Firmware Ver.7.1.8.x

6.1.1 Alarm Configuration

The alarm can be configured to announce the maintenance timings of robot battery/grease, and Controller battery. Expiration time of the alarm is set one month prior to the maintenance timing if setting the parts replacement date or grease up timing.

 CAUTION	<ul style="list-style-type: none"> ■ Make sure that the date and time on the Controller are set correctly. The alarm cannot function properly with improper date and time setting. ■ If the CPU board or CF is replaced, the alarm information may be lost. When you replaced these parts, confirm the date and time of the Controller and alarm information.
---	---

6.1.1.1 Robot Battery and Grease Up

When the robot is configured or changed, an alarm for the battery replacement and grease up will be configured automatically.

The following parts are subject to grease up:

6-axis robot: Bevel gear on the Joint #6

SCARA (including RS series): Ball screw spline unit on the Joint # 3

When the robot is deleted from the configuration, the alarm will also be automatically deleted.

For details on the robot configuration, refer to *the EPSON RC+ 7.0 User's Guide 10.1 Setting the Robot Model*.

 CAUTION	<ul style="list-style-type: none"> ■ Changing of the robot should be done carefully. The alarm setting will be reset when the robot is changed.
---	--

NOTE  The first alarm for the robot battery replacement and grease up after purchase may occur earlier than originally scheduled.

NOTE  If you are using the Controller with the firmware version before 7.1.0.x, the alarm information is not configured. In such case, edit the alarm information. For details on the alarm information editing, refer to *Maintenance 6.1.3 How to Edit the Alarm Information*.

NOTE  The alarm information for the robot battery replacement and grease up depends on the Controller where the robot is configured to. If the robot is replaced with the other robot with a different serial number, the alarm will not function properly. When you replace the robot, edit the alarm information. For details on the alarm information editing, refer to *Maintenance 6.1.3 How to Edit the Alarm Information*.

6.1.1.2 Controller Battery

The Controller battery is automatically configured at the first connection with the EPSON RC+7.0 after upgrading to the firmware version 7.1.0.x and later.



If you are using the Controller before the version upgrade, there may be a difference in the alarm information. In such case, edit the alarm information. For details on the alarm information editing, refer to *Maintenance 6.1.3 How to Edit the Alarm Information*.

6.1.2 How to View the Alarm Information

The configured alarm information can be checked in the EPSON RC+ 7.0.

- (1) Select the EPSON RC+ 7.0 menu-[Tools]-[Maintenance] to display the [Controller Tools] dialog box.

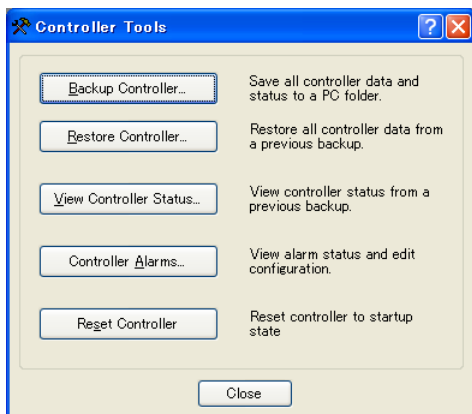

- (2) Click the <Controller Alarms> button and display the [Controller Alarms] dialog box.

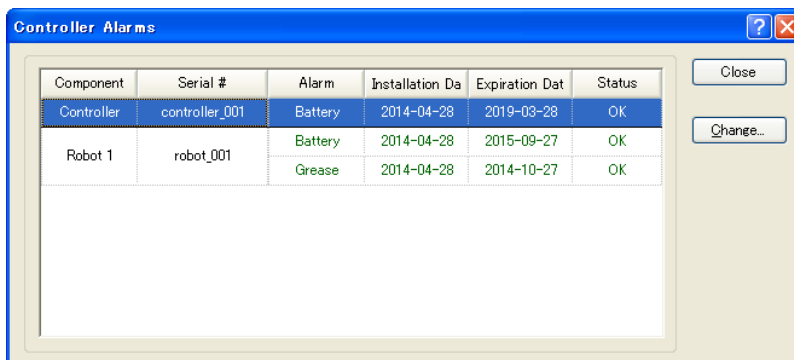

There are three states of the alarm.

Display	Status
OK	An alarm is configured. An alarm is not occurring.
Expired	An alarm is occurring. Replacement is required.
Not set	An alarm is not configured.

6.1.3 How to Edit the Alarm Information

The configured alarm information can be edited in the EPSON RC+ 7.0.

- (1) Select EPSON RC+ 7.0 menu-[Tools]-[Maintenance] to display the [Controller Tools] dialog box.
- (2) Select the alarm to be changed and click the <Change> button.
- (3) Display the [Change Alarm] dialog box and enter any of the followings.
Purchase or replacement date of the battery
Date of grease up



- (4) Click the <OK> button and change the specified alarm information.

6.1.4 Alarm Notifying Method

The alarm notifying method needs to be configured by the output bit of the Remote I/O.

The Remote I/O can be configured in the EPSON RC+ 7.0- [Setup] - [System Configuration] - [Controller] - [Remote Control].

For details, refer to *the EPSON RC+ 7.0 User's Guide 12.1 Remote I/O*.

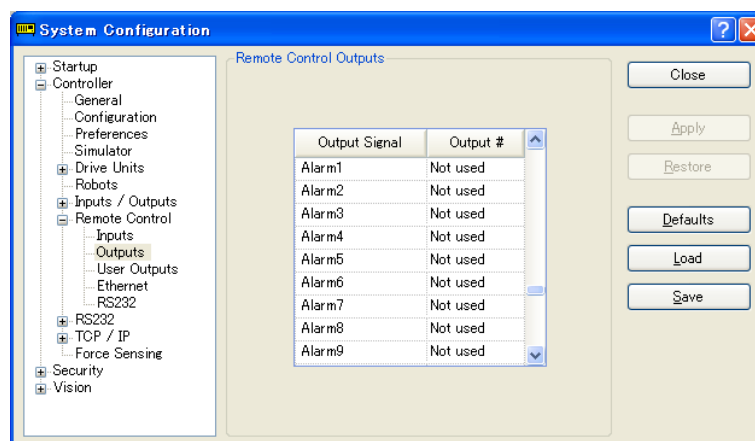

NOTE The Controller does not enter the error or warning state even if an alarm occurs.

6.1.5 How to Cancel the Alarm

An alarm occurs when it reaches the set expiration time.

There are following two methods to cancel the alarm.

- From the [Change Alarm] dialog box
- By the input bit of the Remote I/O



The alarm cannot be canceled by executing the Reset command or restarting the Controller.

6.1.5.1 Alarm Cancellation Dialog

The alarm can be canceled from the EPSON RC+ 7.0.

By referring to *Maintenance 6.1.3 How to Edit the Alarm*, change the alarm information in the same steps.



6.1.5.2 Remote Input

The alarm can be canceled by the input bit of the Remote I/O.

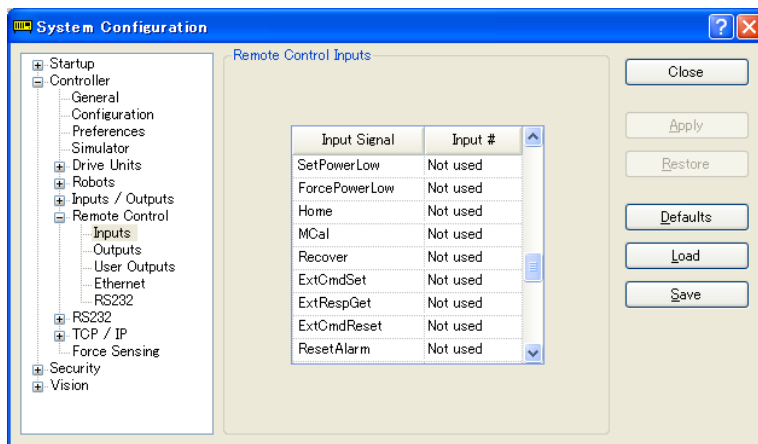

For details, refer to the EPSON RC+ 7.0 *User's Guide 12.1 Remote I/O*.

6.2 Controller Firmware Ver.7.2.0.x or later

NOTE



X5 series cannot use this function.

6.2.1 Maintenance

The recommended replacement time can be configured for the Controller batteries, robot batteries/grease, timing belts, motors, reduction gear units, and ball screw spline units.



- Make sure that the date and time on the Controller are set correctly.
The maintenance cannot function properly with improper date and time setting.
- If the CPU board or CF is replaced, the maintenance information may be lost.
When you replaced these parts, confirm the date and time of the Controller and the maintenance information.

NOTE



Setting of the maintenance vary depending on installation methods to update from the firmware version 7.1.0.x or earlier to 7.2.0.x or later.

Initial installation : Maintenance is enabled.

Upgrade : Maintenance inherits the previous data.
(Disables as default)

For details for enabling or disabling the maintenance, refer to the *EPSON RC+ 7.0 User's Guide 5.12.2 [System Configuration] Command (Setup Menu) - [Setup]-[System Configuration]-[Controller]-[Preferences] Page.*

NOTE



Maintenance is enabled at shipment.

6.2.1.1 Robot Maintenance Information

If enabled, the maintenance information for the battery, timing belts, motors, reduction gear units, ball screw spline unit, and grease up will be configured automatically when the robot is configured or changed.

The following parts are subject to grease up:

SCARA (including RS series): Ball screw spline unit on the Joint # 3

When the robot is deleted from the configuration, the maintenance information will also be automatically deleted.

For details on the robot configuration, refer to *the EPSON RC+ 7.0 User's Guide 10.1 Setting the Robot Model.*



- Changing of the robot should be done carefully. The alarm setting will be reset when the robot is changed.

NOTE



If you are using the Controller with the firmware version before 7.1.0.x, the maintenance information is not configured. In such case, edit the information.

For details on the maintenance information editing, refer to *Maintenance 6.2.3 How to Edit the Maintenance Information.*

NOTE  The robot maintenance information depends on the Controller where the robot is configured to. If the robot is replaced with the other robot with a different serial number, the maintenance information will not function properly. When you replace the robot, edit the maintenance information.

For details on the maintenance information editing, refer to *Maintenance 6.2.3 How to Edit the Maintenance Information*.

6.2.1.2 Controller Maintenance Information

If the maintenance is enabled, the Controller battery is automatically configured at the first connection with the EPSON RC+7.0 after upgrading to the firmware version 7.2.0.x and later.

NOTE  If you are using the Controller before the version upgrade, there may be a difference in the maintenance information. In such case, edit the information. For details on the maintenance information editing, refer to *Maintenance 6.2.3 How to Edit the Maintenance Information*.

6.2.2 How to View the Maintenance Information

The configured maintenance information can be checked in the EPSON RC+ 7.0 Ver.7.2.x or later.

- (1) Select the EPSON RC+ 7.0 menu-[Tools]-[Maintenance] to display the [Controller Tools] dialog box.

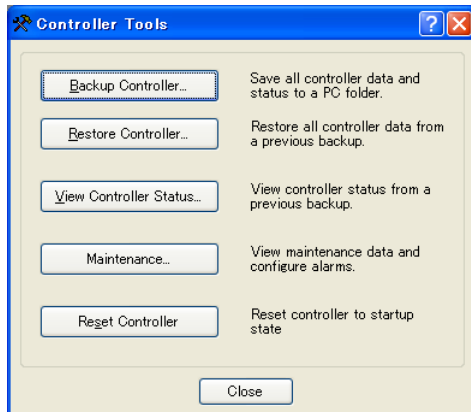

- (2) To check the Controller maintenance information, click the <Maintenance> button and display the [Maintenance] dialog box.

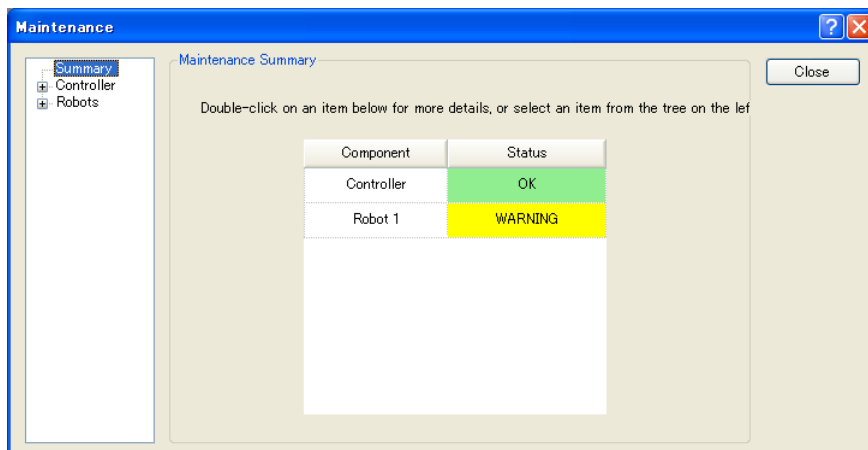

- (3) Select “General” or specify the axis from the tree to display information of the target parts.

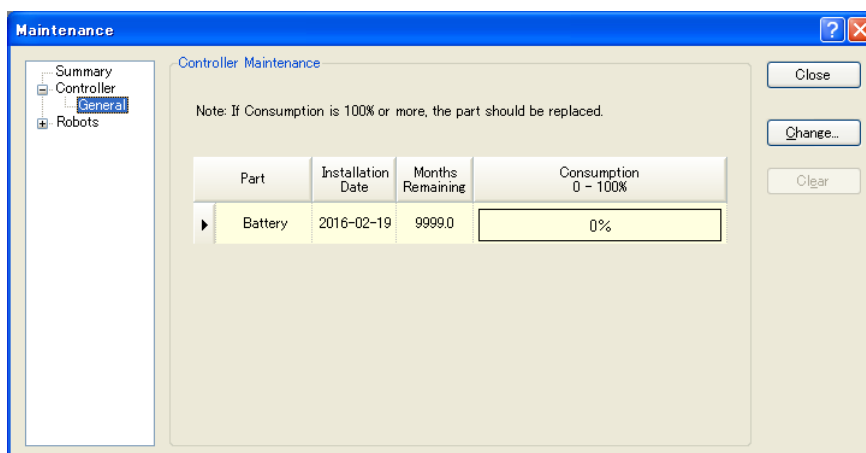

NOTE

The recommended replacement time for the battery is calculated based on the battery capacity and the Controller ON time. The battery may run out if it passes the recommended replacement time.

The recommended replacement time for the grease is calculated based on the elapsed days since date of grease up. The replacement time may be shorter or longer depending on usage condition, such the load applied on the robot.

The recommended replacement time for the parts (timing belts, motors, reduction gear units, and ball screw spline unit) is when it reaches the L10 life (time until 10% failure probability). In the dialog window, the L10 life is displayed as 100%.

Remaining months is calculated based on the past operation conditions. Enable to set the period for calculation by “HealthCalcPeriod” command. (Default: seven days of the Controller ON time)

Remaining months may not be calculated properly until the period for the calculation passed.

6.2.3 How to Edit the Maintenance Information

The configured maintenance information can be edited in the EPSON RC+ 7.0 Ver.7.2.x or later.

- (1) Select the EPSON RC+ 7.0 menu-[Tools]-[Maintenance] to display the [Controller Tools] dialog box.
- (2) To edit the maintenance information, display the [Maintenance] dialog box.
- (3) Select “General” or specify the axis from the tree to display information of the target parts.
- (4) Select the alarm to be changed and click the <Change> button.
- (5) Display the [Change Alarm] dialog box and enter any of the followings.



Purchase or replacement date of the battery

Date of grease up

Purchase or replacement date of the timing belt

Purchase or replacement date of the motor

Purchase or replacement date of the reduction gear unit

Purchase or replacement date of the ball screw spline unit

- (6) Click the <OK> button and change the specified alarm information.



The offset can be set for the consumption rate of already installed parts.

Follow the steps below to calculate a rough offset setting value.

1. Measure the usable months for the past operation by HealthRBA analysis.
2. Confirm the past Motor ON time in the Controller status viewer.
3. Calculate a rough offset value with the following formula.

$$\text{Offset} = 100 \times \frac{\text{Motor On time}}{24 \times 30.4375 \times \text{Usable months}}$$

For details, refer to the following manual.

EPSON RC+ 7.0 SPEL+ Language Reference

6.2.4 Alarm Notifying Method

The Controller status becomes warning and displays warning message if any parts required to perform replacement or grease up.

For details, refer to the following manual.

Maintenance 9.1 Error Code Table

The alarm notifying method can be configured by the output bit of the Remote I/O.

The Remote I/O can be configured in the EPSON RC+ 7.0- [Setup] - [System Configuration] - [Controller] - [Remote Control].

For details, refer to *EPSON RC+ 7.0 User's Guide 12.1 Remote I/O*.

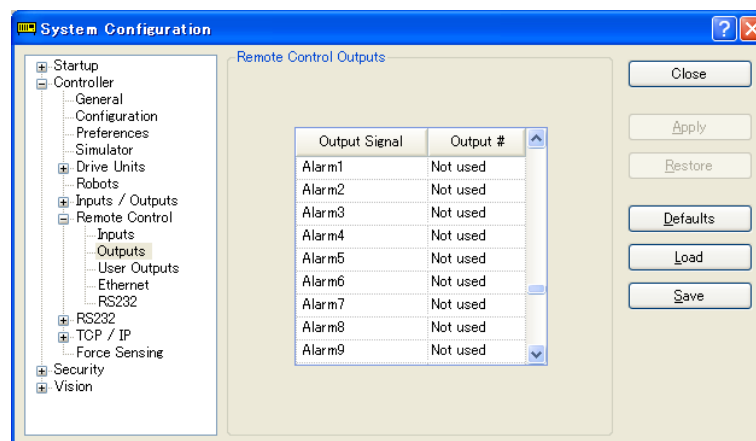

NOTE



The Controller enters the warning state if an alarm occurs.

6.2.5 How to Cancel the Alarm

An alarm occurs when the consumption rate of the parts reaches 100%.

NOTE



The alarm cannot be canceled by executing the Reset command or restarting the Controller.

The alarm can be canceled by following methods.

EPSON RC+ 7.0 [Maintenance] dialog box.

HealthCtrlReset Command

HealthRBReset Command

Refer to *Maintenance 6.2.3 How to Edit the Maintenance Information* to change the alarm information in the same steps.

7. Maintenance Parts Replacement Procedures

 WARNING	<ul style="list-style-type: none"> ■ Before performing any maintenance procedure, always make sure that the main power of the Controller is turned OFF and that the high voltage charged area is completely discharged. Performing any maintenance procedure while the main power is ON or the high voltage charged area is not discharged completely is extremely hazardous and may result in electric shock and/or cause serious safety problems. ■ When opening or closing the front side, make sure that the 200 V power supply for the Controller is OFF. Performing procedure to the power supply terminal block inside the Controller while the power supply is ON is extremely hazardous and may result in electric shock and/or cause serious safety problems.
---	---

- NOTE**
- Be careful not to damage cables. Be sure not to drop any screws into the Controller.
 - Installing the front cover using the wrong screws may result in a cable being damaged and/or malfunction of the Controller.

7.1 Fan Filter

Inspect the fan filter periodically and clean it when needed. The temperature inside the Controller may get too high and the Controller may not operate properly if the filter is not kept clean.

Fan Filter Removal

- (1) Turn OFF the Controller.
- (2) Remove one screw of the fan filter.



- (3) Remove the fan filter cover.
- (4) Detach the fan filter.

Clean the fan filter as needed.

Fan Filter Installation

- (1) Set the fan filter to the fan filter cover.
- (2) Mount the fan filter cover with the screw.
- (3) Connect the power plug. Turn ON the Controller and make sure that the Controller starts properly without any vibration or abnormal noise.

7.2 Fan

7.2.1 Front Fan

Front Fan Removal

- (1) Turn OFF the Controller.
- (2) Disconnect the power plug.
- (3) Remove the Top Cover. (Mounting screw ×6)

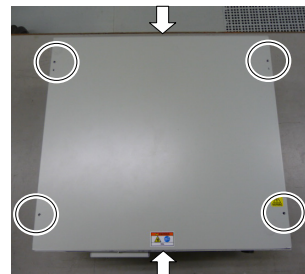

- (4) Remove the fan cable from the DMB-SUB.
Connector: CN22



- (5) Remove the screws of the fan (×2).
- (6) Remove the fan.



Front Fan Installation

- (1) Mount a new fan with two screws.
At this point, tighten the screws diagonally. Be careful of the mounting direction.
- (2) Connect the fan cables to the DMB-SUB.
Connector: CN22
- (3) Mount the Top Panel. (Mounting screw ×6)
- (4) Connect the power plug. Turn ON the Controller and make sure that the Controller starts properly without any vibration or abnormal noise.

* Pay attention to the right and wrong sides of the fan when installing it.

7.2.2 Fan 2 (RC700-A only)

The fan 2 is installed only in RC700-A.

Fan 2
removal
(RC700-A only)

- (1) Turn OFF the Controller.
- (2) Disconnect the power plug.
- (3) Remove the Top Cover. (Mounting screw ×6)

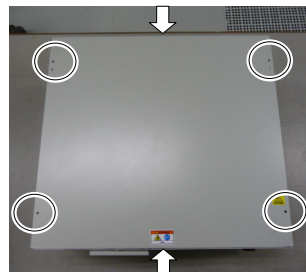

- (4) Remove the cable tie binding the 15 V power supply cable and fan cable.
- (5) Remove the fan extension connector.

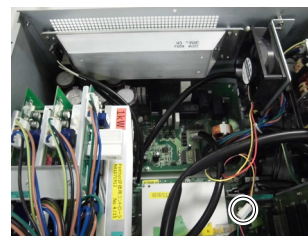

- (6) Remove the regenerative module connector from the DMB.
- (7) Remove the regenerative module connector from the DPB.

- (8) Remove the rear plate from the body.
(Mounting screw ×5)



- (9) Remove the regenerative resistance from the rear plate.
(Mounting screw ×4)

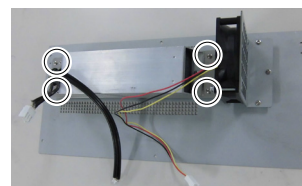

- (10) Remove the fan from the fan fixing plate.
(Mounting screw ×2)

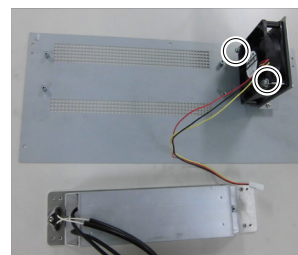

Fan 2
Installation
(RC700-A only)

- (1) Fix the new fan to the fan fixing plate. (Mounting screw ×2)
At this point, tighten the screws diagonally. Be careful of the mounting direction.
- (2) Mount the regenerative resistance to the rear plate. (Mounting screw ×2)
Be careful of the mounting direction.
- (3) Mount the rear plate to the body. (Mounting screw ×5)
- (4) Connect the regenerative module connector to the DMB.
- (5) Connect the regenerative module connector to the DPB.
- (6) Connect the fan extension connector.
- (7) Bind the 15 V power supply cable and fan cable. by the cable tie (AB150).
Leave 110 mm from the end of the cable tie in order not to tighten the cables too much.
Cut the excess part of the tie.
- (8) Mount the Top Panel. (Mounting screw ×6)
- (9) Connect the power plug. Turn ON the Controller and make sure that the Controller starts properly without any vibration or abnormal noise.

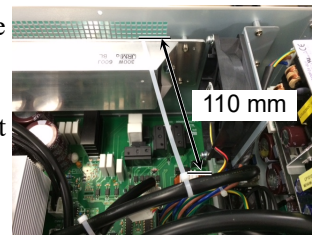

* Pay attention to the right and wrong sides of the fan when installing it.



7.3 Battery

 CAUTION	<ul style="list-style-type: none"> ■ Use meticulous care when handling the lithium battery. Improper handling of the lithium battery as mentioned below is extremely hazardous, may result in heat generation, leakage, explosion, or inflammation, and may cause serious safety problems. <ul style="list-style-type: none"> • Battery Charge • Disassembly • Incorrect Installation • Exposing to Fire • Forced Discharge • Deformation by Pressure • Short-circuit (Polarity; Positive/Negative) • Heating (85°C or more) • Soldering the terminal of the lithium battery directly ■ Be sure to use the battery supplied as maintenance part from EPSON (Refer to 10. Maintenance Parts List). ■ When disposing of the battery, consult with the professional disposal services or comply with the local regulation. Spent battery or not, make sure the battery terminal is insulated. If the terminal contacts with the other metals, it may short and result in heat generation, leakage, explosion, or inflammation.
--	--

NOTE



Turn ON the Controller for approximately one minute before replacing the battery.
Finish the replacement within 10 minutes to prevent data loss.

Battery Removal

- (1) Backup the Controller data.
Refer to *Maintenance 4. Backup and Restore*.
- (2) Turn OFF the Controller.
- (3) Disconnect the power plug.
- (4) Remove the battery bracket. (Mounting screw ×2)

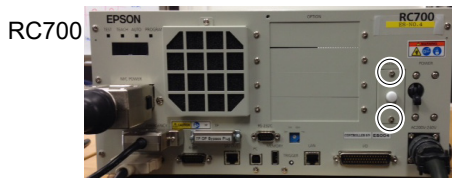

- (5) Pull out the battery bracket.
- (6) Disconnect the battery cable.
- (7) Remove the battery straight upward.



Battery

- (1) Set a new battery.

Installation

NOTE



Secure the battery with the mounting tab.

- (2) Connect the battery cables.
- (3) Insert the battery bracket and secure it with the screws. (Mounting screw ×2)
- (4) Connect the power plug. Turn ON the Controller and make sure that the Controller starts properly without any vibration or abnormal noise.

7.4 CF (Compact Flash)

CF Removal

- (1) Turn OFF the Controller.
- (2) Disconnect the power plug.
- (3) Remove the Top Panel. (Mounting screw ×6)
- (4) Remove the connector (CN39).
- (5) Remove the CF mounting screw and the rubber.
- (6) Pull the CF toward the direction of the arrow in the picture.

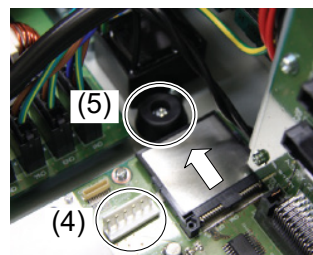
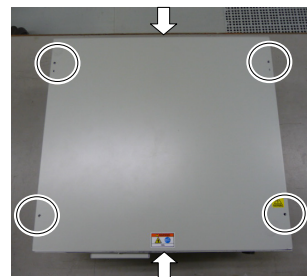

CF Installation

- (1) Insert a new CF toward the opposite direction of the arrow in the picture above.
- (2) Tighten the CF mounting screw (×1) and the rubber.
- (3) Connect the connector (CN39).
- (4) Mount the Top Panel. (Mounting screw ×6)
- (5) Connect the power plug. Turn ON the Controller and make sure that the Controller starts properly without any vibration or abnormal noise.

7.5 MDB

MDB identification method There are types of the MDB and it can be identified by “Assy. No.” or “MDB type” printed on the board.

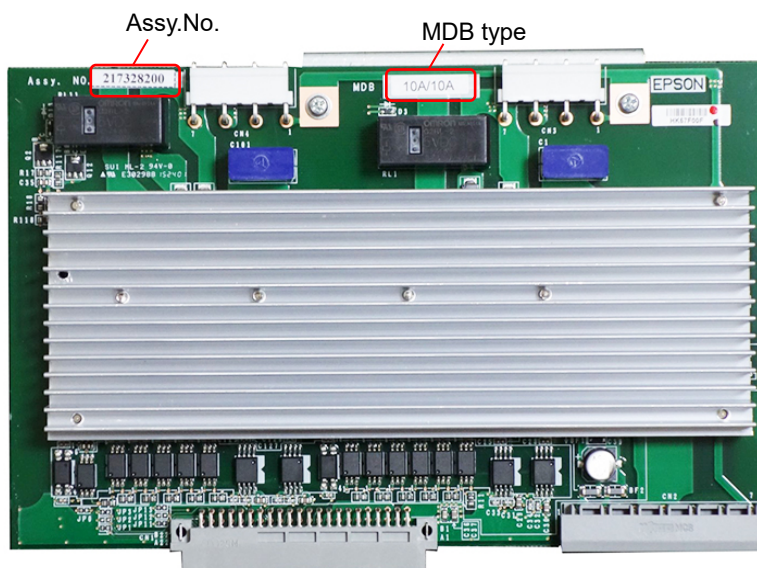

Controller	Manipulator	Joint #1, #2	Joint #3, #4	Joint #5, #6	Remarks
RC700	C4	15A/15A	10A/10A		MDB type
		2149935** 2171247**	2145517** 2157372** 2172039**		Assy. No.
RC700-A	C4	15A/15A-2	10A/10A		MDB type
		2166640** 2171936** 2172974** 2175538** 2194708** 2168582** 2194709**	2145517** 2157372** 2172973** 2175537** 2195535** 2172039** 2195537**		Assy. No.
		50A/30A	15A/15A-2	10A/10A	MDB type
		2169285** 2205667** 2205668**	2166640** 2171936** 2194708** 2194709**	2145517** 2157372** 2195535** 2195537**	Assy. No.

Controller	Manipulator	Joint #1, #5	Joint #3, #4	Joint #2, #6	Remarks
RC700-A	N2	5A/5A			MDB type
		2175610** 2176557**			Assy. No.
	N6	30A/5A	15A/5A	30A/5A	MDB type
		2186906** 2188814**	2186907** 2188815**	2186906** 2188814**	Assy. No.

Maintenance 7. Maintenance Parts Replacement Procedures

Controller	Manipulator	Joint #1, #2	Joint #3, #4	Remarks	
RC700-A	G1 G3	10A/10A		MDB type	
		2145517**		Assy. No.	
		2157372** 2172039**			
	G6 RS X5	15A/15A-2		10A/10A	MDB type
		2166640**		2145517**	Assy. No.
		2171936**		2157372**	
		2168582**		2172039**	
	G10 G20	30A/30A		15A/15A-2	MDB type
		2146123**		2166640**	Assy. No.
		2153723**		2171936**	
		2171456**		2168582**	

MDB
Removal

- (1) Turn OFF the Controller.
- (2) Disconnect the power plug.
- (3) Remove the Top Panel. (Mounting screw ×6)

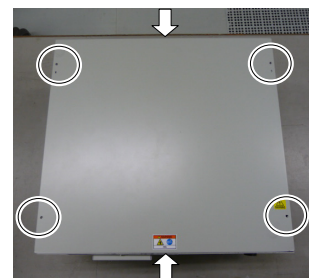

- (4) Remove the output cables of each axis of the MDB.

NOTE

Before removing the cables, check positions of the boards and the cables. Install them to the same positions after the replacement.



- (5) Remove the MDB clamp 1. (Mounting screw ×5)

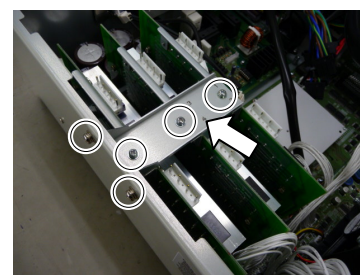

- (6) Remove the MDB clamp 2. (Mounting screw ×2)



- (7) Pull out the MDBs in the direction shown in the picture.

NOTE

When removing the MDBs, make sure to remember the position of each board. Install the boards to the same positions after replacement.

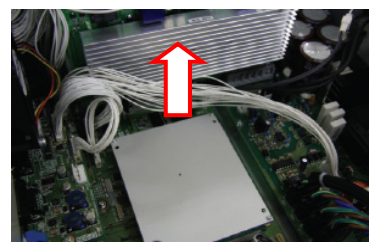

- (8) Remove the MDB clamp 3. (Mounting screw ×2)



MDB
Installation

- (1) Install the MDB clamp 3.
(Mounting screw ×2)



- (2) Insert the MDBs in the direction shown in the picture.

NOTE

Be careful not to misplace the boards.

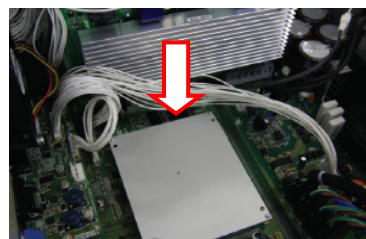

- (3) Install the MDB clamp 2.
(Mounting screw ×2)

Set the MDB clamp so that the grooves fit to MDBs.



- (4) Mount the MDB clamp 1.
(Mounting screw ×5)

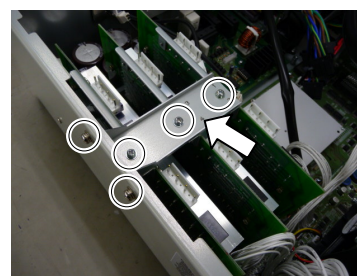

- (5) Mount the output cable of each axis of the MDBs.

NOTE

When mounting the output cables, make sure that the numbers on the MDB clamp 1 and on the connectors are the same.



- (6) Mount the Top Panel. (Mounting screw ×6)
- (7) Connect the power plug. Turn ON the Controller and make sure that the Controller starts properly without any vibration or abnormal noise.

7.6 DMB

DMB Removal

- (1) Turn OFF the Controller.
- (2) Disconnect the power plug.
- (3) Remove the Top Panel. (Mounting screw ×6)
- (4) Remove the cables connected to the following connectors.

M/C Signal Connector	EMERGENCY Connector
TP Connector	USB Connector
USB Memory	Ethernet Connector
I/O Connector	RS-232C Connector
R-I/O Connector	DU OUT Connector

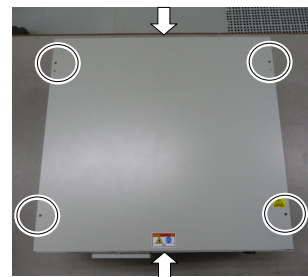

- (5) Remove the MDBs.
Refer to *Maintenance: 7.5 MDB*.
- (6) Remove the DMB-OPTION board.
(Mounting screw ×3)

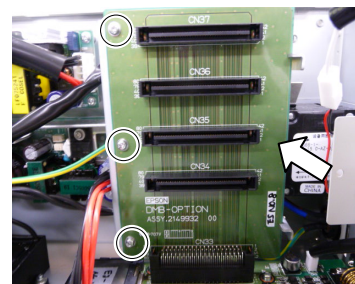

- (7) Remove five screws on the side of the chassis.



- (8) Remove the fixing plate of the DMB-OPTION board.

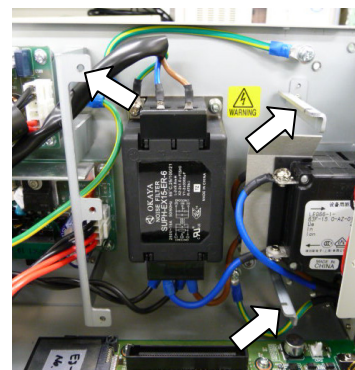

(9) RC700: Remove the five connectors from the DMB.

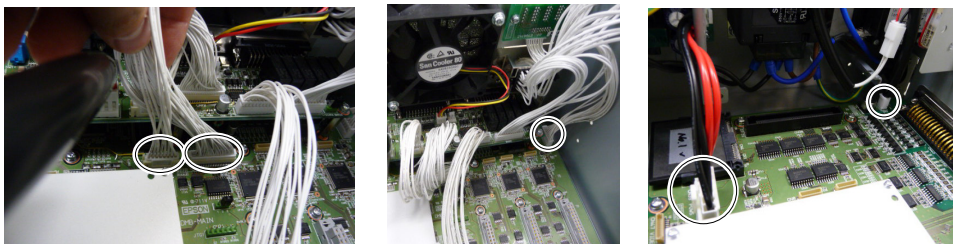

RC700-A: Remove the twelve connectors from the DMB.

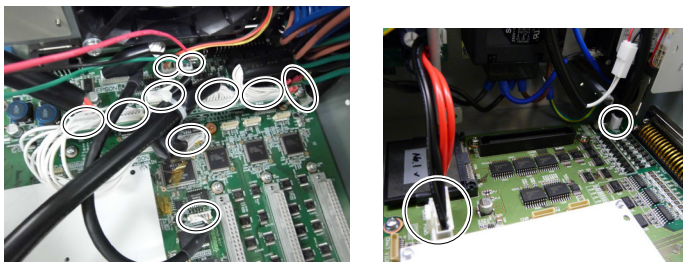

(10) Remove the DMB mounting screws (×14).

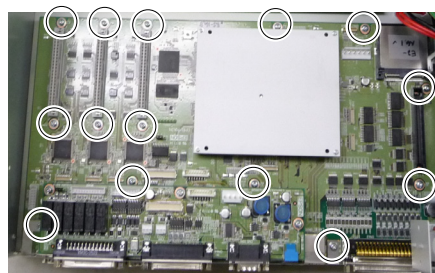

(11) Remove the fan.

Refer to *Maintenance: 7.2 Fan*.

(12) Remove the DMB from the chassis.

At this point, be careful not to touch the chassis and other parts.

(13) Remove the plate fixing the connectors on the front side from the DMB and the DMB-SUB boards.

RC700



RC700-A



(14) Remove the DMB-SUB board from the DMB.
(Mounting screw ×3)

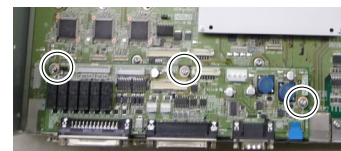

DMB
Installation

- (1) Install the DMB-SUB board to the new DMB. (Mounting screw ×3)
- (2) Install the plate that secures the connectors on the front side to the DMB and the DMB-SUB boards.
- (3) Insert the DMB into the chassis.
At this point, be careful not to touch the chassis and other parts.
- (4) Mount the fan.
Refer to *Maintenance: 7.2 Fan*.
- (5) Tighten the DMB mounting screw (×14).

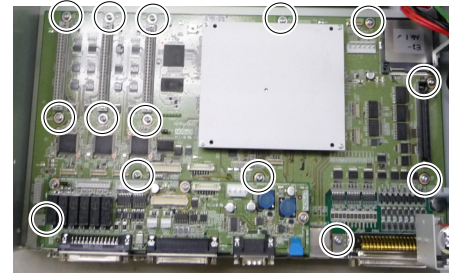

- (6) RC700: Connect the five connectors to the DMB.

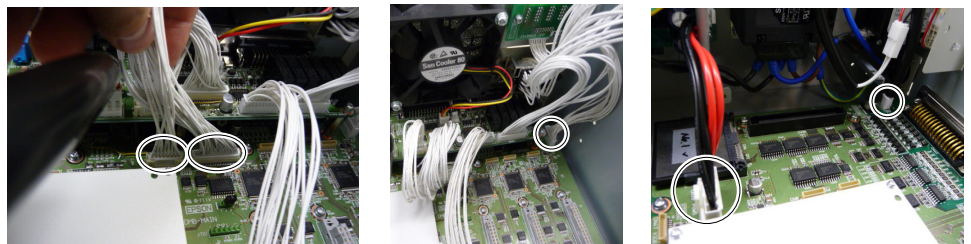

- RC700-A: Connect the twelve connectors to the DMB.

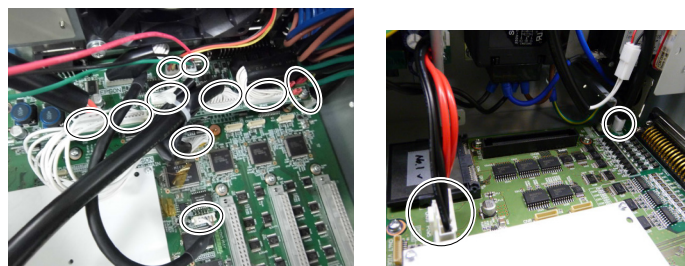

- (7) Mount the fixing plate of the DMB-OPTION board.

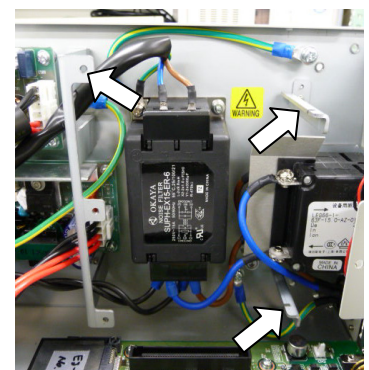

- (8) Mount the five screws on the side of the chassis.



- (9) Mount the DMB-OPTION board.
(Mounting screw ×3)

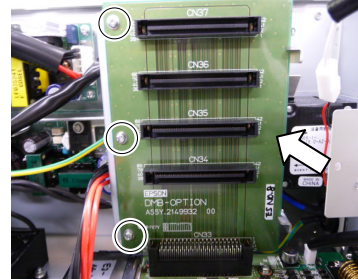

- (10) Mount the MDB.

Refer to *Maintenance: 7.5 MDB*.

- (11) Install the cables to the following connectors.

M/C Signal Connector	EMERGENCY Connector
TP Connector	USB Connector
USB Memory	Ethernet Connector
I/O Connector	RS-232C Connector
R-I/O Connector	DU OUT Connector

- (12) Mount the Top Panel. (Mounting screw ×6)

- (13) Connect the power plug. Turn ON the Controller and make sure that the Controller starts properly without any vibration or abnormal noise.

7.7 DMB-SUB Board

DMB-Sub Board Removal

- (1) Turn OFF the Controller.
- (2) Disconnect the power plug.
- (3) Remove the Top Panel. (Mounting screw ×6)

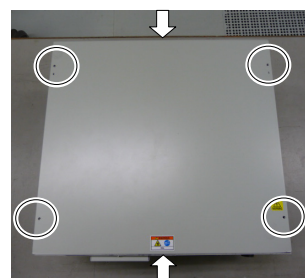

- (4) Remove the cables from the DMB-SUB board.

RC700

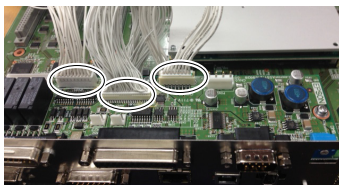

RC700-A

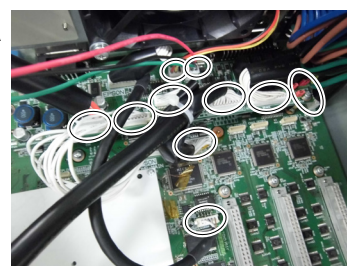

- (5) Remove the screws fixing the DMB-SUB board to the front side plate.

RC700



RC700-A



- (6) Remove the DMB-SUB Board from the DMB.
(Mounting screws ×3)

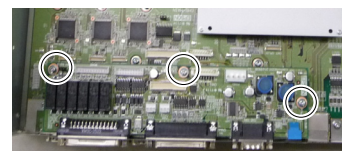

DMB-Sub Board Installation

- (1) Mount the plate that secures the connectors on the front side to the DMB-SUB board.
- (2) Mount the DMB-SUB Board to the DMB. (Mounting screws ×3)
- (3) Connect the cables to the DMB-SUB Board.
- (4) Mount the Top Panel. (Mounting screw ×6)
- (5) Set the Encoder Voltage Adjustment Switch.

Set the Encoder Voltage Adjustment Switch according to the length of the M/C cable.

Refer to: *Setup & Operation 2. Part Names and Functions*

(14) Encoder Voltage Adjustment Switch

- (6) Connect the power plug. Turn ON the Controller and make sure that the Controller starts properly without any vibration or abnormal noise.

7.8 DMB-LED Board

7.8.1 DMB-LED Board (RC700)

DMB-LED Board Removal (RC700)

- (1) Turn OFF the Controller.
- (2) Disconnect the power plug.
- (3) Remove the Top Panel. (Mounting screw ×6)
- (4) Disconnect the cables connected to the DMB-LED board.
- (5) Remove the DMB-LED board. (Mounting screw ×2)

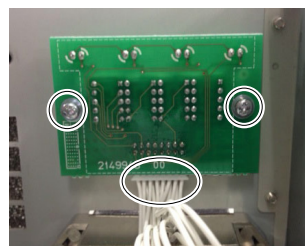
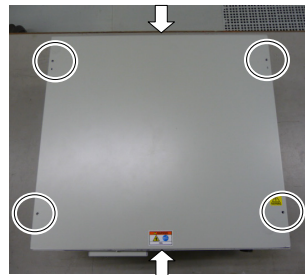

DMB-LED Board Installation (RC700)

- (1) Mount the DMB-LED board. (Mounting screw ×2)
- (2) Connect the cables to the DMB-LED board.
- (3) Mount the Top Panel. (Mounting screw ×6)
- (4) After connecting the power plug, turn ON the Controller and check it works normally without vibration and abnormal sound.

7.8.2 DMB-LED Board (RC700-A)

DMB-LED Board Removal (RC700-A)

- (1) Turn OFF the Controller.
- (2) Disconnect the power plug.
- (3) Remove the Top Panel. (Mounting screw ×6)
- (4) Remove the DMB-LED board from the front panel. (Mounting screw ×2)
- (5) Remove the ferrite core from the Support plate. (Mounting screw ×1)
- (6) Disconnect the cables connected to the DMB-LED board.
- (7) Remove the DMB-LED board from the support plate. (Nut ×2)
- (8) Remove the stud bolt from the DMB-LED board. (Stud bolt ×4)

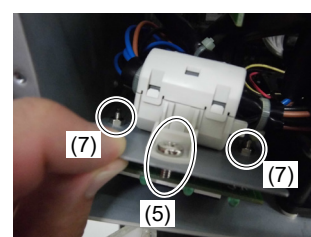
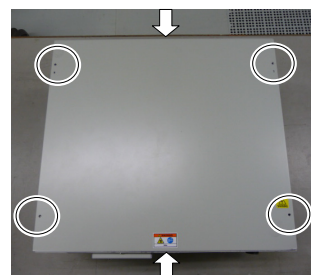

DMB-LED Board Installation (RC700-A)

- (1) Mount the stud bolt to the DMB-LED board. (Stud bolt ×4)
- (2) Mount the DMB-LED board to the support plate. (Nut ×2)
- (3) Connect the cable to the DMB-LED board.
- (4) Mount the ferrite core to the support plate. (Mounting screw ×1)
- (5) Mount the DMB-LED board to the front panel. (Mounting screw ×4)
- (6) Mount the Top Panel. (Mounting screw ×6)
- (7) After connecting the power plug, turn ON the Controller and check it works normally without vibration and abnormal sound.

7.9 DPB

DPB
Removal

- (1) Turn OFF the Controller.
- (2) Disconnect the power plug.
- (3) Remove the Top Panel. (Mounting screw ×6)
- (4) Remove the MDB.
Refer to: Maintenance 7.5 MDB

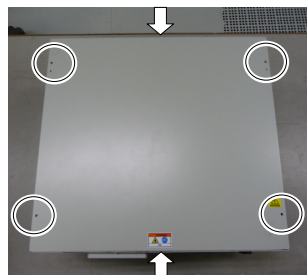

- (5) Remove the MDB clamp 3.
(Mounting screw ×2)

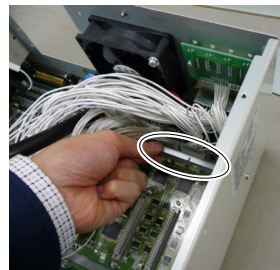

- (6) Remove eight connectors from the DPB.

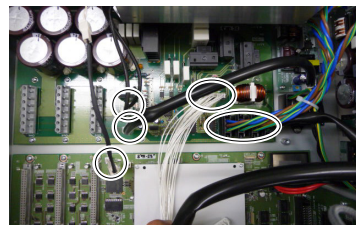

- (7) RC700-A only:
Remove the fan 2 extension connector.

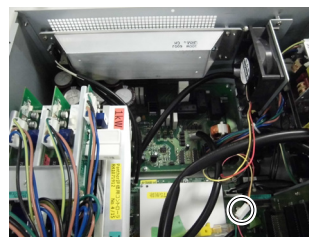

- (8) RC700-A only:
Remove the rear plate from the body.
(Mounting screw ×5)



- (9) Remove the DPB mounting screws.

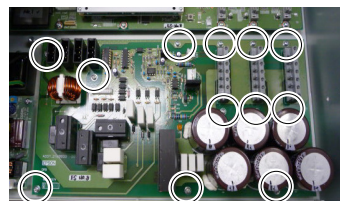

- (10) Remove the DPB from the chassis.

DPB
Installation

- (1) Insert the DPB to the chassis.
- (2) Fix the DPB with screws.
- (3) RC700-A only: Mount the rear plate. (Mounting screw ×5)
- (4) RC700-A only: Connect the fan 2 extension connector.
- (5) Connect the eight connectors to the DPB.
- (6) Mount the MDB clamp 3. (Mounting screw ×2)
- (7) Mount the DMB.
Refer to: Maintenance 7.6 DMB
- (8) Mount the top plate. (Mounting screw ×6)
- (9) After connecting the power plug, turn ON the Controller and check it works normally without vibration and abnormal sound.

7.10 Option Board

RC700

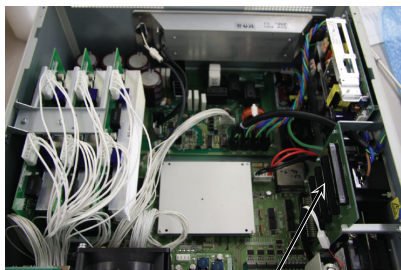

Option Slot

RC700-A

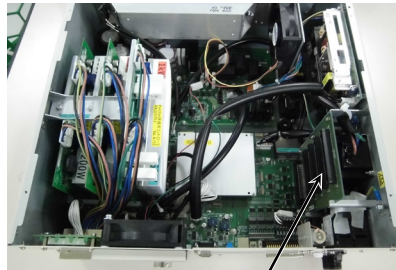

Option Slot

Option Board Addition

- (1) Turn OFF the Controller.
- (2) Disconnect the power plug.
- (3) Remove the Top Panel. (Mounting screw ×6)
- (4) Remove the screws of the Option Slot Panels.
Remove as many Option Panels as the Option Boards to add.

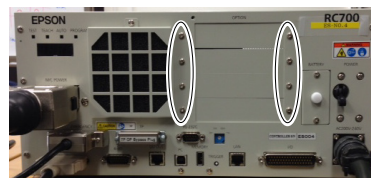

- (5) Mount the L-shaped plate to the Option Board.

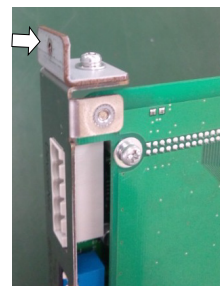

- (6) Install the Option Board as shown in the picture.
Insert the board to the Option Slot.
(in the direction of an arrow)

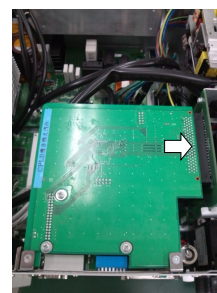

- (7) Mount the attachment L-shaped plate with a screw from the front side.
At this point, one screw for the Option Slot Panel is left unused.





- (8) Mount the Top Panel. (Mounting screws ×6)
- (9) After connecting the power plug, turn ON the Controller and check it works normally without vibration and abnormal sound.

8. Verifying Robot System Operation

When maintenance has been performed for either the Manipulator or the Controller, including replacing any parts in those units, items must be checked according to the procedures in this section to ensure proper operation.

- (1) Connect all the necessary cables for the system.

 WARNING	<ul style="list-style-type: none"> ■ When verifying the robot system operation, prepare for failures with initial settings or wiring. If the Manipulator operates abnormally because of incorrect initial settings or wiring, press the Emergency Stop switch immediately to stop the Manipulator. <p>Verify the robot system operation in the restricted mode (low speeds and low power) status. Verifying the robot system operation at high speeds may damage the robot system and/or cause serious safety problems as the Manipulator cannot stop operating immediately in case of abnormal operation of the Manipulator.</p>
---	--

 CAUTION	<ul style="list-style-type: none"> ■ The serial number of the Manipulator that should be connected is indicated on the Connection Check Label on the Controller. Connect the Controller and the Manipulator correctly. Improper connection between the Controller and the Manipulator may cause not only improper function of the robot system but also serious safety problems.
---	---

- (2) Check the LED status during the time from the Controller is turned ON until the Controller boots up by referring to the list below.

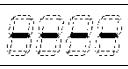
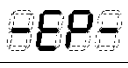
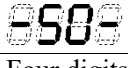
	From power-on to boot	While running	
LED	All blink	LED for current operation mode (TEST, TEACH, AUTO, PROGRAM) turns ON.	
7 segment	All lights out		READY (Normal)
			Emergency Stop
			Safeguard
		Four digits	Error

For details of the display, refer to *Setup & Operation 2.1.1 LED and Seven-segment LED*.

For error numbers, refer to *Maintenance 9.1 Error Code Table*.

- (3) Execute MOTOR ON and check the following:
 - No error is displayed.
 - There is servo excitation and the Manipulator operates normally.
- (4) Execute various motion commands (such as JUMP, etc.). The Manipulator must operate accordingly and normally without vibration or unusual sounds.

9. Troubleshooting

9.1 Error Code Table

No.	Message	Remedy	Note 1	Note 2
1	Controller control program started.	-		
2	Termination due to low voltage of the power supply.	-		
3	Controller control program has completed.	Stores this log when the controller is rebooted from EPSON RC+ or TP1.		
4	Preserve variables save area has been cleaned.	-		
5	Function Main started.	-		
6	Function Main started. Later same logs are skipped.	Skip the log "Function Main started." to prevent system history space run out.		
7	Serial number has been saved.	-		
8	System backup has been executed.	-		
9	System restore has been executed.	-		
10	Robot parameters have been initialized.	-		
11	Offset pulse value between the encoder origin and the home sensor (HOFS) is changed.	-	Value after change	Value before change
17	Message saving mode activated. Uncommon event.	-		
18	Conversion of Robot Parameter file has been executed.	-		
19	DU firmware has been installed.	-		
20	Enable setting in Teach mode has been saved.	-		
21	Enable setting in Teach mode has been changed.	-		
23	EStop has been executed.	-	Robot number executing motion command	Controller status
24	Safeguard has opened.	-	Robot number executing motion command	Controller status
25	Robot setting has changed.	-		Robot number
26	Alarm setting has changed.	-	Alarm number	
50	The battery alarm for the controller was reset.	-		
51	The battery alarm for the robot was reset.	-	Robot number	
52	The grease alarm for the robot was reset.	-	Robot number	
100	Device connected to Controller.	-		
101	Console device has changed.	-	20: TP3 21:RC+ 22:Remote I/O 26: Remote Ethernet 29: Remote RS232	
102	Display device has changed.	-		

No.	Message	Remedy	Note 1	Note 2
103	Working mode has changed.	-		
104	Cooperative mode has changed.	-	0: Independent 1: Cooperative	
110	Controller firmware has been installed.	-	1: Setup 2: Initialize 3: Upgrade 4: Recover	
111	IP address has been restored.	May store this log when the controller firmware is installed.		
112	Controller rebooted	-		
120	RC+ connected to the Controller.	-	1: Ethernet 2: USB	
121	TP connected to the Controller.	-		
123	RC+ disconnected from the Controller.	-		
124	TP disconnected from the Controller.	-		
126	Working mode changed to AUTO.	-		
127	Working mode changed to Program.	-		
128	Working mode changed to Teach.	-		
129	Remote Ethernet connected to the Controller	-		
130	Remote Ethernet disconnected to the Controller	-		
131	Remote Com connected to the Controller	-		
132	Remote Com disconnected to the Controller	-	Logout status 0: Normal 1: Abnormal (Time-out)	
133	Working mode changed to Test.	-		
400	The battery alarm for the controller occurred. Replace the battery and reset the alarm.	Replace the battery and reset the alarm.		
401	The battery alarm for the robot occurred. Replace the battery and reset the alarm.	Replace the battery and reset the alarm.	Robot number	
402	The grease alarm occurred. Grease the robot and reset the alarm.	Grease the robot and reset the alarm.	Robot number	
410	The battery alarm for the controller occurred. Replace the battery and reset the alarm.	Replace the battery. After replacing the battery, reset the alarm in EPSON RC+ 7.0-[Tools]-[Controller]-[Maintenance].	1000 times of consumption rate	1000 times of boundary value
411	The battery alarm for the robot occurred. Replace the battery and reset the alarm.	Replace the battery. After replacing the battery, reset the alarm in EPSON RC+ 7.0-[Tools]-[Controller]-[Maintenance].	1000 times of consumption rate	1000 times of boundary value
412	The belt alarm occurred. Replace the belt and reset the alarm.	Replace the timing belt. After replacing the timing belts, reset the alarm in EPSON RC+ 7.0-[Tools]-[Controller]-[Maintenance].	1000 times of consumption rate	1000 times of boundary value
413	The grease alarm for the ball screw spline occurred. Grease the ball screw spline units and reset the alarm.	Grease up the ball screw spline. After greasing up, reset the alarm in EPSON RC+ 7.0-[Tools]-[Controller]-[Maintenance].	1000 times of consumption rate	1000 times of boundary value

No.	Message	Remedy	Note 1	Note 2
414	The motor alarm occurred. Replace the motor and reset the alarm.	Replace the motor. After replacing the motor, reset the alarm in EPSON RC+ 7.0-[Tools]-[Controller]-[Maintenance].	1000 times of consumption rate	1000 times of boundary value
415	The gear alarm occurred. Replace the gear units and reset the alarm.	Replace the gear units. After replacing the gear units, reset the alarm in EPSON RC+ 7.0-[Tools]-[Controller]-[Maintenance].	1000 times of consumption rate	1000 times of boundary value
416	The ball screw spline alarm occurred. Replace the ball screw spline and reset the alarm.	Replace the ball screw spline. After replacing the ball screw spline, reset the alarm in EPSON RC+ 7.0-[Tools]-[Controller]-[Maintenance].	1000 times of consumption rate	1000 times of boundary value
420	The battery alarm for the controller occurred. Replace the battery and reset the alarm.	Replace the battery. After replacing the battery, reset the alarm in EPSON RC+ 7.0-[Tools]-[Controller]-[Maintenance].	1000 times of consumption rate	1000 times of boundary value
421	The battery alarm for the robot occurred. Replace the battery and reset the alarm.	Replace the battery. After replacing the ball screw spline, reset the alarm in EPSON RC+ 7.0-[Tools]-[Controller]-[Maintenance].	1000 times of consumption rate	1000 times of boundary value
422	The belt alarm occurred. Replace the belt and reset the alarm.	Replace the timing belt. After replacing the timing belts, reset the alarm in EPSON RC+ 7.0-[Tools]-[Controller]-[Maintenance].	1000 times of consumption rate	1000 times of boundary value
423	The grease alarm for the ball screw spline occurred. Grease the ball screw spline and reset the alarm.	Grease up the ball screw spline. After greasing up, reset the alarm in EPSON RC+ 7.0-[Tools]-[Controller]-[Maintenance].	1000 times of consumption rate	1000 times of boundary value
424	The motor alarm occurred. Replace the motor and reset the alarm.	Replace the motor. After replacing the motor, reset the alarm in EPSON RC+ 7.0-[Tools]-[Controller]-[Maintenance].	1000 times of consumption rate	1000 times of boundary value
425	The gear alarm occurred. Replace the gear units and reset the alarm.	Replace the gear units. After replacing the gear units, reset the alarm in EPSON RC+ 7.0-[Tools]-[Controller]-[Maintenance].	1000 times of consumption rate	1000 times of boundary value
426	The ball screw spline alarm occurred. Replace the ball screw spline and reset the alarm.	Replace the ball screw spline. After replacing the ball screw spline, reset the alarm in EPSON RC+ 7.0-[Tools]-[Controller]-[Maintenance].	1000 times of consumption rate	1000 times of boundary value
501	Trace history is active.	Effects system performance if trace history is active.		
502	Memory has been initialized.	When this error occurs, the value of the Global Preserve variable will be initialized. Replace the CPU board battery. Replace the CPU board.		
503	Found Hard disk error. You should replace the hard disk ASAP.	This is a warning of the hard disk failure. Replace the hard disk as soon as possible.		
504	An Error occurred on a Background Task.	Make sure there are no problems in the system and continue the operation.		
505	Controller was rebooted.	-		
507	The controller is started by using the previous initial setting file since the initial setting file is corrupted. Check the settings.	Setting changes from the previous start may not be saved. Please check the settings.		

No.	Message	Remedy	Note 1	Note 2
511	Battery voltage of the CPU board backup is lower than the allowed voltage. Replace the CPU board battery.	Replace the CPU board battery immediately. Keep the power to the controller ON as far as possible until you replace the battery.	100 times of current value	100 times of boundary value
512	5V input voltage for the CPU board is lower than the allowed voltage.	If normal voltage is not generated by a 5V power supply alone, replace the power supply.	100 times of current value	100 times of boundary value
513	24 V input voltage for the motor brake, encoder and fan is lower than the specified voltage.	If normal voltage is not generated by a 24V power supply alone, replace the power supply.	100 times of current value	100 times of boundary value
514	Internal temperature of the Controller is higher than the allowed temperature.	Stop the controller as soon as possible and check whether the ambient temperature of the controller is not high. Check whether the filter is not clogged up.	100 times of current value	100 times of boundary value
515	Rotating speed of the controller fan is below the allowed speed. (FAN1)	Check whether the filter is not clogged up. If the warning is not cleared after the controller is rebooted, replace the fan.	Current value	Boundary value
516	Rotating speed of the controller fan is below the allowed speed. (FAN2)	Check whether the filter is not clogged up. If the warning is not cleared after the controller is rebooted, replace the fan.	Current value	Boundary value
517	Internal temperature of the Controller is higher than the allowed temperature.	Stop the controller as soon as possible and check whether the ambient temperature of the controller is not high. Check whether the filter is not clogged up.	100 times of current value	100 times of boundary value
518	54V input voltage for the CPU board is lower than the allowed voltage.	If normal voltage is not generated by a 54V power supply alone, replace the power supply.	100 times of current value	100 times of boundary value
519	3.3V input voltage for the CPU board is lower than the allowed voltage.	If normal voltage is not generated by a 3.3V power supply alone, replace the power supply.	100 times of current value	100 times of boundary value
520	DC input voltage for the CPU board is lower than or bigger than the allowed voltage.	If normal voltage is not generated by a DC power supply alone, replace the power supply.	100 times of current value	100 times of boundary value
521	DU1 3.3V input voltage for the board is lower than the allowed voltage.	If normal voltage is not generated by 3.3V of Drive Unit 1 power supply alone, replace the power supply.	100 times of current value	100 times of boundary value
522	DU1 5V input voltage for the board is lower than the allowed voltage.	If normal voltage is not generated by 5V of Drive Unit 1 power supply alone, replace the power supply.	100 times of current value	100 times of boundary value
523	DU1 24 V input voltage for the motor brake, encoder and fan is lower than the specified voltage.	If normal voltage is not generated by 24V of Drive Unit 1 power supply alone, replace the power supply.	100 times of current value	100 times of boundary value
524	DU1 Internal temperature of the Controller is higher than the allowed temperature.	Stop Drive Unit 1 as soon as possible and check whether the ambient temperature of Drive Unit 1 is not high. Check whether the filter is not clogged up.	100 times of current value	100 times of boundary value
525	DU1 Rotating speed of the controller fan is below the allowed speed. (FAN1)	Check whether the filter of Drive Unit 1 is not clogged up. If the warning is not cleared after the controller is rebooted, replace the fan.	Current value	Boundary value

No.	Message	Remedy	Note 1	Note 2
526	DU1 Rotating speed of the controller fan is below the allowed speed. (FAN2)	Check whether the filter of Drive Unit 1 is not clogged up. If the warning is not cleared after the controller is rebooted, replace the fan.	Current value	Boundary value
531	DU2 3.3V input voltage for the board is lower than the allowed voltage.	If normal voltage is not generated by 3.3V of Drive Unit 2 power supply alone, replace the power supply.	100 times of current value	100 times of boundary value
532	DU2 5V input voltage for the board is lower than the allowed voltage.	If normal voltage is not generated by 5V of Drive Unit 2 power supply alone, replace the power supply.	100 times of current value	100 times of boundary value
533	DU2 24 V input voltage for the motor brake, encoder and fan is lower than the specified voltage.	If normal voltage is not generated by 24V of Drive Unit 2 power supply alone, replace the power supply.	100 times of current value	100 times of boundary value
534	DU2 Internal temperature of the Controller is higher than the allowed temperature.	Stop Drive Unit 2 as soon as possible and check whether the ambient temperature of Drive Unit 2 is not high. Check whether the filter is not clogged up.	100 times of current value	100 times of boundary value
535	DU2 Rotating speed of the controller fan is below the allowed speed. (FAN1)	Check whether the filter of Drive Unit 2 is not clogged up. If the warning is not cleared after the controller is rebooted, replace the fan.	Current value	Boundary value
536	DU2 Rotating speed of the controller fan is below the allowed speed. (FAN2)	Check whether the filter of Drive Unit 2 is not clogged up. If the warning is not cleared after the controller is rebooted, replace the fan.	Current value	Boundary value
541	DU3 3.3V input voltage for the board is lower than the allowed voltage.	If normal voltage is not generated by 3.3V of Drive Unit 3 power supply alone, replace the power supply.	100 times of current value	100 times of boundary value
542	DU3 5V input voltage for the board is lower than the allowed voltage.	If normal voltage is not generated by 5V of Drive Unit 3 power supply alone, replace the power supply.	100 times of current value	100 times of boundary value
543	DU3 24 V input voltage for the motor brake, encoder and fan is lower than the specified voltage.	If normal voltage is not generated by 24V of Drive Unit 3 power supply alone, replace the power supply.	100 times of current value	100 times of boundary value
544	DU3 Internal temperature of the Controller is higher than the allowed temperature.	Stop Drive Unit 3 as soon as possible and check whether the ambient temperature of Drive Unit 3 is not high. Check whether the filter is not clogged up.	100 times of current value	100 times of boundary value
545	DU3 Rotating speed of the controller fan is below the allowed speed. (FAN1)	Check whether the filter of Drive Unit 3 is not clogged up. If the warning is not cleared after the controller is rebooted, replace the fan.	Current value	Boundary value
546	DU3 Rotating speed of the controller fan is below the allowed speed. (FAN2)	Check whether the filter of Drive Unit 3 is not clogged up. If the warning is not cleared after the controller is rebooted, replace the fan.	Current value	Boundary value
550	Communication with the Compact Vision is disconnected. Check the network wiring.	Check the connection between the controller and the compact vision.	Camera No.	
551	Compact Vision CPU fan RPM has decreased. Clean the fan filter and / or replace the fan.	Check whether the fan filter of the compact vision is not clogged up. If the warning is not cleared after the controller and the compact vision are rebooted, replace the CPU fan.	Camera No.	Current value

No.	Message	Remedy	Note 1	Note 2
552	Compact Vision CPU fan RPM has decreased. Clean the fan filter and / or replace the fan.	Replace the CPU fan of the compact vision.	Camera No.	Current value
553	Compact Vision chassis fan RPM has decreased. Replace the fan.	Check whether the fan filter of the compact vision is not clogged up. If the warning is not cleared after the controller and the compact vision are rebooted, replace the system fan.	Camera No.	Current value
554	Compact Vision chassis fan RPM has decreased. Replace the fan.	Replace the system fan of the compact vision.	Camera No.	Current value
555	Compact Vision CPU temperature is too high. Check the installation environment (ventilation, ambient temperature, etc.)	Check whether the fan filter of the compact vision is not clogged up. If the warning is not cleared after the controller and the compact vision are rebooted, check the installation environment (surrounding space, ambient temperature) of the compact vision.	Camera No.	1000 times of current value
556	Compact Vision CPU temperature is too high. Check the installation environment (ventilation, ambient temperature, etc.)	Check whether the fan filter of the compact vision is not clogged up. If the warning is not cleared after the controller and the compact vision are rebooted, check the installation environment (surrounding space, ambient temperature) of the compact vision.	Camera No.	1000 times of current value
557	Compact Vision backup battery voltage is low. Replace the battery.	Replace the backup battery of the compact vision.	Camera No.	1000 times of current value
558	Compact Vision backup battery voltage is low. Replace the battery.	Replace the backup battery of the compact vision.	Camera No.	1000 times of current value
559	Compact Vision process was terminated abnormally. Restart the Compact Vision unit.	If the warning is not cleared after the controller and the compact vision are rebooted, initialize the compact vision.	Camera No.	
560	Compact Vision available memory is low. Restart the Compact Vision unit.	If the warning is not cleared after the controller and the compact vision are rebooted, initialize the compact vision.	Camera No.	Current value
561	Compact Vision available disk space is low. Reduce the number of objects that use models (Geometric, Correlation, DefectFinder, etc.)	Check the vision sequence if it has unnecessary models which can be reduced. Consider to use the USB memory.	Camera No.	Current value
562	A critical hardware error occurred in the Compact Vision unit. Check the hardware condition such as internal wiring.	If the warning is not cleared after the controller and the compact vision are rebooted, initialize the compact vision.	Camera No.	
563	A critical hardware error occurred in the Compact Vision unit. Check the hardware condition such as internal wiring.	If the warning is not cleared after the controller and the compact vision are rebooted, replace the LED/SW board.	Camera No.	
569	Communication with the Compact Vision recovered.	-	Camera No.	

No.	Message	Remedy	Note 1	Note 2
570	Compact Vision. Password authentication has failed.	Enter the correct Compact Vision connection password in the RC+ Camera page. If the password is unknown, you must do one of the following: a. Enter a new connection password from CV Monitor, then enter the same password in the RC+ Camera page. or b. Perform a factory reset on the Compact Vision unit to clear the password. Rebuild the current RC+ project and check operation.		
597	The PTP motion to avoid the singularity point has completed.	PTP motion for the singularity avoidance was completed. Clicking the same jog button will operate the robot in the normal jog motion.		
598	Robot stopped due to collision detection	Move the manipulator to the direction avoiding collision		
599	Jogging attempted near singularity point.	The robot could not jog in the CP motion (default). Clicking the same jog button will operate the robot in the PTO motion.		
700	Motor driver type does not match the current robot model. Check the robot model. Replace the motor driver.	Check the robot model.		
736	Encoder has been reset. Reboot the controller.	Reboot the controller.		
737	Low voltage from the encoder battery. Replace the battery.	Turn OFF the controller and replace the battery. For the battery replacement procedure, refer to <i>Maintenance</i> in the Manipulator manual.		
752	Servo alarm D.	-		

No.	Message	Remedy	Note 1	Note 2
1001	Operation Failure. Command parameter is invalid.	-		
1002	Requested data cannot be accessed. The data is not set up or the range is invalid.	Check whether the target I/O, variables, and tasks exist.		
1003	The password is invalid	Enter the correct password.		
1004	Cannot execute with unsupported version.	Use the correct version file.		
1005	Cannot execute with invalid serial number.	Use the backup data for the same controller to restore the controller configuration.		
1006	Cannot execute with invalid Robot model.	Use the backup data for the same controller to restore the controller configuration.		
1007	Cannot execute with invalid Controller.	Use the supported installer.		
1010	Remote setup error. Cannot assign R-IO input number to remote input.	Specify the input number excluding the R-IO input number.		
1011	Remote setup error. Cannot assign a bit number which does not exist to a remote I/O signal. Check the fieldbus slave size.	Check the fieldbus slave size.		
1012	Remote setup error. Cannot assign a bit number which does not exist to a remote I/O signal. Check the fieldbus master size.	Check the fieldbus master size.		
1013	Fieldbus slave failure. Cannot change the size because it currently includes a remote I/O signal.	-		
1014	Fieldbus master failure. Cannot change the size because it currently includes a remote I/O signal.	-		
1015	Remote setup error. Cannot assign Hand-IO input/output number to remote input.	-		
1016	Remote setup error. Cannot change assignment because PLC vendor type is set.	Set PLC Vendor to "None" to change IO mapping.		
1020	Cannot execute in recovery mode.	Boot the controller as normal.		
1021	Cannot execute due to controller initialization failure.	Restore the controller configuration.		
1022	Cannot execute without the project being open.	Open a project.		
1023	Cannot execute while the project is open.	Rebuild the project.		
1024	Cannot activate from remote.	Enable the remote input.		
1025	Execution in Teach mode is prohibited.	Change to the AUTO mode.		
1026	Cannot execute in Teach mode except from TP.	Change to the AUTO mode.		
1027	Cannot execute in Auto mode.	Change to the Program mode.		

Maintenance 9. Troubleshooting

No.	Message	Remedy	Note 1	Note 2
1028	Cannot execute in Auto mode except from the main console.	Change to the Program mode.		
1029	Cannot execute from OP.	Enable the OP input.		
1030	Does not allow Operation mode to be changed.	Change to the Auto mode with a console in the Program mode.		
1031	Cannot execute while tasks are executing.	Stop the task and then execute.		
1032	Cannot execute while the maximum number of tasks are executing.	Stop the task and then execute.		
1033	Cannot execute during asynchronous motion command.	Execute after the motion ends.		
1034	Asynchronous command stopped during operation.	The asynchronous command already stopped when the controller received a stop command.		
1035	Cannot execute when Remote I/O enabled except from the remote device.	The command cannot be executed by the console except the remote I/O when AutoMode output of the remote I/O is ON.		
1037	Cannot execute when Remote Ethernet enabled except from the remote Ethernet device.	The command cannot be executed by the console except the remote Ethernet when Auto flag of the remote Ethernet is ON.		
1039	Execution is prohibited.	Prohibited command was executed while executing the program. Stop the program, and then execute the command.		
1041	Cannot execute during Emergency Stop status.	Cancel the Emergency Stop status.		
1042	Cannot execute while the safeguard is open.	Close the safeguard.		
1043	Cannot execute during error condition.	Cancel the error condition.		
1044	Cannot execute when the remote pause input is ON.	Change the remote pause input to OFF.		
1045	Input waiting condition is the only available condition to input.	The controller received an input while it was not in the Input waiting condition.		
1046	Cannot execute during file transfer.	Execute after the file transmission.		
1047	Cannot cancel the command executed from other devices.	Cancel the motion command from the device the command was issued from.		
1048	Cannot execute after low voltage was detected.	Reboot the controller.		
1049	Other devices are in program mode.	Check connection of other devices.		
1050	Password is too long.	Enter the password that is less than 16 characters.		
1051	Export Controller Status failed.	<ol style="list-style-type: none"> 1. Retry using the same USB memory. 2. Retry using another USB memory. 3. Retry after rebooting the controller. 		
1052	Export Controller Status busy.	Execute the command after completing the controller status backup.		

No.	Message	Remedy	Note 1	Note 2
1053	Execution in Test mode is prohibited	Execute in other modes.		
1054	Cannot execute in TEST mode except from TP.	-		
1055	Cannot execute the Background Task.	Confirm that no background task is running. Rebuild the project.		
1056	Cannot execute from OP.	Enable the TP3 input.		
1057	Cannot execute when TP3 enabled except from the TP3.	The command cannot be executed from other consoles when TP3 is enabled.		
1058	Cannot execute excluding T2 mode.	Switch to <Teach/T2> key.		
1059	Cannot change to T2 mode.	T2 mode cannot be used on RC700-A Controllers complying with UL standards.		
1100	File failure. Cannot access the file.	1. Reboot the controller. 2. Reinstall the firmware. 3. Replace the CF.		
1102	File failure. Read and write failure of the registry	1. Reboot the controller. 2. Replace the CF.		
1103	File is not found.	Check whether the file exists.		
1104	Project file was not found.	Rebuild the project.		
1105	Object file was not found.	Rebuild the project.		
1106	Point files were not found.	Rebuild the project.		
1107	The program is using a feature that is not supported by the current controller firmware version.	Check the compiler version in the EPSON RC+ 7.0-[Project]-[Properties]-[Compiler].		
1108	One or more source files are updated. Please build the project.	Rebuild the project.		
1109	Not enough storage capacity.	Increase free space of the USB memory.		
1110	File is not found.	-		
1111	Conveyor file was not found.	-		
1112	Force files were not found. Rebuild the project.	Rebuild the project.		
1114	Cannot create the project in the controller.	There is a possibility that the folder is full or the project name is duplicated. Check it by the application selection.		
1120	File failure. Setting file is corrupt.	Restore the controller configuration.		
1121	File failure. Project file is corrupt.	Rebuild the project.		
1122	File failure. Point file is corrupt.	Rebuild the project.		
1123	File failure. I/O label file is corrupt.	Rebuild the project.		
1124	File failure. User error file is corrupt.	Rebuild the project.		
1126	File failure. Software option information is corrupt.	1. Reboot the controller. 2. Reinstall the firmware. 3. Reconfigure the option.		
1127	File failure. Vision file is corrupt.	Rebuild the project.		

No.	Message	Remedy	Note 1	Note 2
1128	File failure. Backup information file is corrupt.	The specified backup information cannot be restored. Acquire the backup information again, and then restore the file.		
1130	Error message failure. No item is found in the error history.	No error history exists. Reboot the controller.		
1131	Cannot access the USB memory.	Insert the USB memory properly. When this error still occurs after the USB memory is inserted properly, the memory may be unrecognizable to controller. Insert another memory to check the operation.		
1132	File failure. Failed to copy the file.	-		
1133	File failure. Failed to delete the file.	-		
1134	File failure. GUI Builder file is corrupt.	Rebuild the project.		
1138	File failure. Force Guide file is corrupt.	Rebuild the project.		
1140	File failure. Failed to open the object file.	Rebuild the project.		
1141	File failure. Failed to open the project file.	Rebuild the project.		
1142	File failure. Failed to read the project file.	Rebuild the project.		
1143	File failure. Failed to open the condition save file.	1. Retry using the same USB memory. 2. Retry using another USB memory. 3. Retry after rebooting the controller.		
1144	File failure. Failed to write the condition save file.	1. Retry using the same USB memory. 2. Retry using another USB memory. 3. Retry after rebooting the controller.		
1145	File failure. Failed to open the conveyor file.	Rebuild the project.		
1146	File failure. Failed to read the conveyor file.	Rebuild the project.		
1150	File failure. Error history is invalid.	1. Reboot the controller. 2. Replace the CF.		
1151	File failure. Failed to map the error history.	1. Reboot the controller. 2. Replace the CF.		
1152	File failure. Failed to open the error history file.	1. Reboot the controller. 2. Replace the CF.		
1153	File failure. Failed to write the error history file.	1. Reboot the controller. 2. Replace the CF.		
1155	File failure. Failed to open the settings file.	Restore the controller configuration.		
1156	File failure. Failed to save the settings file.	Restore the controller configuration.		
1157	File failure. Failed to read the settings file.	Restore the controller configuration.		

No.	Message	Remedy	Note 1	Note 2
1158	File failure. Failed to write the settings file.	Restore the controller configuration.		
1160	MCD failure. Failed to open the MCD file.	Restore the controller configuration.		
1161	MCD failure. Failed to read the MCD file.	Restore the controller configuration.		
1163	MCD failure. Failed to save the MCD file.	Restore the controller configuration.		
1165	MPD failure. Failed to open the MPD file.	-		
1166	MPD failure. Failed to read the MPD file.	-		
1168	MPD failure. Failed to save the MPD file.	-		
1170	MPL failure. Failed to open the MPL file.	1. Reboot the controller. 2. Reinstall the firmware.		
1181	PRM failure. Failed to replace the PRM file.	1. Reboot the controller. 2. Reconfigure the robot.		
1185	File failure. Failed to open the backup information file.	-		
1186	File failure. Failed to read the backup information file.	-		
1187	File failure. Failed to write the backup information file.	-		
1188	File failure. Failed to save the backup information file.	-		
1189	The backup data was created by an old version.	Cannot restore the controller configuration in the specified procedure for using old backup data. Check the backup data.		
1190	The backup data was created by a newer version.	-		
1191	There is no project in the backup data.	-		
1192	Cannot execute with invalid robot number.	Check that the Backup data is same as current robot number.		
1193	Cannot execute with invalid robot information.	Check that the Backup data is same as current robot number.		
1194	Cannot execute with invalid drive unit number.	-		
1195	File failure. Failed to map the health history.	Reboot the controller.	-	-
1196	File failure. Failed to open the health history file.	Reboot the controller.	-	-
1197	File failure. Failed to write the health history file.	Reboot the controller.	-	-
1198	Restore failure. The project is invalid. Restore the project together if restoring Vision hardware configuration.	Restore the project together if restoring Vision hardware configuration.		

Maintenance 9. Troubleshooting

No.	Message	Remedy	Note 1	Note 2
1200	Compile failure. Check the compile message.	This error occurs during compilation from TP. Correct where the error occurred.		
1201	Link failure. Check the link message.	This error occurs during compilation from TP. Correct where the error occurred.		
1250	User Outputs failure. The Name is empty.	-		
1251	User Outputs failure. The Condition is empty.	-		
1252	User Outputs failure. Robot number is out of the available range.	-		
1260	Alarm Setting failure. Robot does not exist.	-		
1261	Alarm Setting failure. Failed to get the expiration date.	-		
1262	Alarm Setting failure. Failed to set the alarm.	-		
1263	Alarm Setting failure. Specified alarm number is out of the allowable range.	-		
1264	Alarm Setting failure. Specified alarm number is not enabled.	-		
1290	Force monitor number is out of the allowable range. Reboot the controller.	Reboot the controller. Initialize the controller firmware. Replace the controller.		
1291	The force monitor is already used on another device. Close the force monitor on another device, and then run the force monitor.	Check whether another PC is using the force monitor.		
1292	Failed to set/load information of FG sequence and object.			
1400	Force Guide file error.			
1401	Invalid Force Guide file path.			
1402	Failed to open Force Guide file.			
1403	Do not open Force Guide file.			
1404	Invalid Force Guide sequence number.			
1405	Invalid Force Guide object number.			
1406	Invalid Force Guide sequence property.			
1407	Invalid Force Guide object property.			
1408	Invalid Force Guide object type.			
1409	Invalid parameter.			
1410	Invalid Force Guide file version.			
1411	Force Guide Incorrect property is existing. Confirm the property.	Confirm the Force Guide property.		
1412	Cannot set Decision object to top of Force Guide sequence. Confirm Force Guide sequence.	Cannot set Decision object to top of a sequence. Confirm Force Guide sequence.		

No.	Message	Remedy	Note 1	Note 2
1413	Specified Force Guide object as ConditionObject is disabled. Confirm the settings.	Confirm the settings of Force Guide object.		
1420	Failed to convert program. Execute rebuild.			
1421	Initialization failure. Cannot allocate memory.			
1422	Finalization failure. Failed to finalization of controller.			
1423	Invalid conversion file path.			
1424	Invalid Prg file path.			
1425	Invalid Command file path.			
1426	Invalid conversion file.			
1427	Invalid Command file.	Update from Ver.7.4.0.2 or earlier to Ver7.4.0.2 or later may fail. Reinstall the firmware.		
1428	Failed to execute conversion of program. Execute rebuild.	Rebuild the project.		
1429	Failed to write Prg file.			
1500	Communication error.	-		
1501	Command did not complete in time.	Execute the command again after a while. Check the connection between the EPSON RC+7.0 and controller.		
1502	Communication disconnection between RC+ and Controller. Re-establish communication.	Check the connection between the EPSON RC+7.0 and controller.		1: Communication timeout 2: USB cable disconnection 3: USB reception failure 4: USB communication shutdown
1503	Disconnection while executing a task.	Check the connection between the console device and controller.		
1504	Communication disconnection between Remote Ethernet and Controller. Re-establish communication.	Check the connection between the Remote Ethernet device and controller.		
1505	Communication disconnection between Remote RS232 and Controller. Re-establish communication.	Check the connection between the Remote RS232 device and controller.		
1506	Communication disconnection between TP3 and Controller. Re-establish communication.	Check the connection between TP3 and controller.		
1510	Out of IP Address range.	Check the IP address setting of the controller.		
1511	Reserved IP Address.	The IP address is reserved. Set the other IP address.		
1512	Reserved IP Gateway.	The gateway address is reserved. Set the other gateway address.		

Maintenance 9. Troubleshooting

No.	Message	Remedy	Note 1	Note 2
1513	The setting conditions of global address do not match.	Set the password.		
1514	The connection parameters or password are invalid. Check the parameters and the password.	Check the parameters and the password.		
1521	Vision communication. Failed to initialize Ethernet.	Reboot the controller.		
1522	Vision communication. Failed to terminate Ethernet.	-		
1523	Vision communication. Failed to create the socket handle.	Reboot the controller.		
1524	Vision communication. Failed to connect.	Check the connection between the camera and controller.		
1526	Vision communication. Failed to send to the server.	Check the connection between the camera and controller.		
1527	Vision communication. Failed to read from the server.	Check the connection between the camera and controller.		
1528	Vision communication. Failed to set option.	-		
1529	Vision communication. Ethernet has not been initialized yet.	Reboot the controller.		
1530	Vision communication. Connection is not completed.	Check the connection between the camera and controller.		
1531	Vision communication. All sockets are used.	-		
1532	Vision communication. Sending time-out.	Check the connection between the camera and controller.		
1533	Vision communication. Receiving time-out.	Check the connection between the camera and controller.		
1534	Vision communication. Communication error.	Check the connection between the camera and controller.		
1550	Communication failure. Ethernet initialization error.	Reboot the controller. Check the connection of the Ethernet cable.		
1551	Communication failure. USB initialization error.	Reboot the controller. Check the connection of the USB cable.		
1552	Communication failure. Controller internal communication error.	Reboot the controller.		
1553	Communication failure. Invalid data is detected.	-		
1555	Ethernet transmission error.	Check the connection between the EPSON RC+7.0 and controller.		
1556	Ethernet reception error.	Check the connection between the EPSON RC+7.0 and controller. If the router is used between the PC and controller, confirm that the DHCP function is disabled.		
1557	USB transmission error.	Check the connection between the EPSON RC+7.0 and controller.		
1558	USB reception error.	Check the connection between the EPSON RC+7.0 and controller.		
1559	Communication failure. Failed to allocate memory	-		

No.	Message	Remedy	Note 1	Note 2
1580	Parser communication failure. Communication error.	1. Reboot the controller. 2. Upgrade the firmware.		
1581	Parser communication failure. Time-out occurred during communication.	1. Reboot the controller. 2. Reinstall the firmware.		
1582	Parser communication failure. Transmission error.	Reboot the controller. Rebuild the project.		
1583	Parser communication failure. Initialization error.	Reboot the controller.		
1584	Parser communication failure. Connection error.	Reboot the controller.		
1585	Parser communication failure. Parameter is invalid.	Reboot the controller. Rebuild the project.		
1586	Parser communication failure. Busy	-		
1587	Parser communication failure. Invalid data is detected.	Upgrade the firmware.		
1700	Initialization failure. Failed to initialize TP.	-		
1701	Initialization failure. Failed to initialize TP.	-		
1702	Initialization failure. Failed to initialize TP.	-		
1703	File failure. Failed to read the screen data file.	-		
1704	Failed to read the setting file.	-		
1706	Failed to open the TP port.	-		
1708	Failed to read the key table for TP.	-		
1709	Failed to change the language.	-		
1710	Failed to display the screen.	-		
1800	The controller is already connected to RC+.	Only one RC+ 7.0 can be connected to the controller.		
1802	The command was attempted without being connected to a controller.	Connect to the controller.		
1803	Failed to read or write the file on the PC.	-		
1804	Initialization failure. Failed to allocate memory on the PC.	-		
1805	Connection failure. Check the controller startup and connection of the communication cable.	-		
1806	Timeout during connection via Ethernet.	-		
1807	Timeout during connection via USB.	-		
1808	USB driver is not installed.	Failed to install EPSON RC+ 7.0. Install EPSON RC+ 7.0 again.		
1809	Initialization failure. Failed to initialize PC daemon.	Reboot the System.		
1810	PC daemon error. Uncommon error.	1. Reboot the EPSON RC+7.0. 2. Reboot the PC.		

No.	Message	Remedy	Note 1	Note 2
1812	Connection failure. The connected controller is not supported in EPSON RC+ 7.0. Please use EPSON RC+ 5.0.	Connected controller is RC180 or RC90 compatible with EPSON RC+ 5.0. Check the connection between the PC and controller.		
1852	System error. Uncommon error.	1. Reboot the EPSON RC+7.0. 2. Reboot the PC. 3. Reinstall the EPSON RC+ 7.0.		
1861	Initialization failure. Failed to initialize SimulatorMNG.	1. Reboot the EPSON RC+ 7.0. 2. Reboot the PC. 3. Reinstall the EPSON RC+ 7.0.		
1862	Initialization failure. Failed to initialize WBProxy.	1. Reboot the EPSON RC+ 7.0. 2. Reboot the PC. 3. Reinstall the EPSON RC+ 7.0.		
1863	The parameter is invalid.	-		
1864	Initialization failure. Virtual controller does not exist.	Installation of the EPSON RC+ 7.0 failed. Reinstall the software.		
1865	Initialization failure. Failed to start virtual controller.	1. Retry after a while. 2. Reboot the PC.		
1867	Cannot execute because it is not dry run mode.	Dry run mode is invalid. Enable the dry run.		
1868	Initialization failure. Directory cannot be found.	Installation of the EPSON RC+ 7.0 failed. Reinstall the software.		
1872	Connection failure. Files for simulator that used real controller cannot be found.	-		
1873	Connection failure. Files for simulator that used virtual controller cannot be found.	-		
1874	Virtual Controller cannot be added.	Installation of the EPSON RC+ 7.0 failed. Reinstall the software.		
1875	Simulator Object failure. Cannot load data for the simulator object.	-		
1876	Simulator Object failure. Cannot read data for the simulator object.	-		
1877	Simulator Object failure. Cannot remove data from the simulator object.	-		
1878	Simulator Object failure. Cannot update data for the simulator object.	-		
1879	Other virtual controllers are starting.	Other virtual controllers may be used in the EPSON RC+ 5.0. Or, the virtual controller may be already used in another EPSON RC+7.0.		
1880	Cannot execute during controller reset.	-		
1901	Unsupported. Unsupported command was attempted.	Update the firmware.		
1902	Unsupported. Unsupported parameter was specified.	-		

No.	Message	Remedy	Note 1	Note 2
1903	System error.	-		
1910	System error. Failed to write the reboot file.	-		

No.	Message	Remedy	Note 1	Note 2
2000	Unsupported. Unsupported command was attempted.	Rebuild the project.		
2001	Unsupported. Unsupported motion command was attempted.	Rebuild the project.		
2003	Unsupported. Unsupported Function argument was specified.	Rebuild the project.		
2004	Unsupported. Unsupported Function return value was specified.	Rebuild the project.		
2005	Unsupported. Unsupported condition was specified.	Rebuild the project.		
2006	Unsupported. Unsupported I/O command was specified.	Rebuild the project.		
2007	Unsupported condition was specified.	Cannot jog in the CP motion (default).		
2008	Unsupported. Unknown error number.	Clicking the same jog button will operate the robot in the PTP motion.		
2009	Unsupported. Invalid Task number.	Cannot jog in the CP motion (default).		
2010	Object file error. Build the project. Out of internal code range.	Rebuild the project.		
2011	Object file error. Build the project. Function argument error.	Rebuild the project.		
	Invalid function parameter value	Part Feeding: Wrong command format or value settings. Read the description for the corresponding command provided in <i>Part Feeding 7.0 Introduction & Hardware (Common) & Software Software 3. Part Feeding SPEL+ Command Reference</i> and correct the code.		
2012	Object file error. Build the project. Command argument error.	Rebuild the project.		
	Invalid command parameter value	Part Feeding: Wrong command format or value settings. Read the description for the corresponding command provided in <i>Part Feeding 7.0 Introduction & Hardware (Common) & Software Software 3. Part Feeding SPEL+ Command Reference</i> and correct the code.		
2013	Object file error. Build the project. Cannot process the code.	Rebuild the project.		

No.	Message	Remedy	Note 1	Note 2
2014	Object file error. Build the project. Cannot process the variable type code.	Rebuild the project.		
2015	Object file error. Build the project. Cannot process the string type code.	Rebuild the project.		
2016	Object file error. Build the project. Cannot process the variable category code.	Rebuild the project.		
2017	Object file error. Build the project. Cannot process because of improper code.	Rebuild the project.		
2018	Object file error. Build the project. Failed to calculate the variable size.	Rebuild the project.		
2019	Object file error. Cannot process the variable wait. Build the project.	Rebuild the project.		
2020	Stack table number exceeded. Function call or local variable is out of range.	Check whether no function is called infinitely. Reduce the Call function depth.		
2021	Stack area size exceeded. Stack error. Function call or local variable is out of range.	If using many local variables, especially String type, replace them to global variables.		
2022	Stack failure. Required data not found on the stack.	Rebuild the project.		
2023	Stack failure. Unexpected tag found on the stack.	Rebuild the project.		
2024	Stack area size exceeded. Local variable is out of range.	Change the size of the Local variable.		
2031	System failure. Robot number is beyond the maximum count.	Restore the controller configuration.		
2032	System failure. Task number compliance error.	Rebuild the project.		
2033	System failure. Too many errors.	Remedy the errors occurring frequently.		
2040	Thread failure. Failed to create the thread.	Reboot the controller.		
2041	Thread failure. Thread creation timeout.	Reboot the controller.		
2042	Thread failure. Thread termination timeout.	Reboot the controller.		
2043	Thread failure. Thread termination timeout.	Reboot the controller.		
2044	Thread failure. Daemon process timeout.	Reboot the controller.		
2045	Thread failure. Task continuance wait timeout.	Reboot the controller.		
2046	Thread failure. Task stop wait timeout.	Reboot the controller.		
2047	Thread failure. Task startup wait timeout.	Reboot the controller.		

Maintenance 9. Troubleshooting

No.	Message	Remedy	Note 1	Note 2
2050	Object file operation failure. Object file size is beyond the allowable size.	Rebuild the project.		
2051	Object file operation failure. Cannot delete the object file during execution.	Reboot the controller.		
2052	Object file operation failure. Cannot allocate the memory for the object file.	Reboot the controller.		
2053	Object file operation failure. Object file cannot be accessed while it is updating.	Perform the same processing after a while. Rebuild the project.		
2054	Object file operation failure. Function ID failure. Rebuild the project.	Synchronize the files of the project. Rebuild the project.		
2055	Object file operation failure. Local variable ID failure. Rebuild the project.	Synchronize the files of the project. Rebuild the project.		
2056	Object file operation failure. Global variable ID failure. Rebuild the project.	Synchronize the files of the project. Rebuild the project.		
2057	Object file operation failure. Global Preserve variable ID failure. Rebuild the project.	Synchronize the files of the project. Rebuild the project.		
2058	Object file operation failure. Failed to calculate the variable size.	Synchronize the files of the project. Rebuild the project.		
2059	Exceed the global variable area. Cannot assign the Global variable area because it failed to allocate memory.	Reduce the number of Global variables to be used.		
2070	SRAM failure. SRAM is not mapped.	Replace the CPU board.		
2071	SRAM failure. Cannot delete when Global Preserve variable is in use.	Perform the same processing after a while. Rebuild the project.		
2072	Exceed the backup variable area. Cannot assign the Global Preserve variable area because it failed to allocate memory.	Reduce the number of Global Preserve variables to be used.	Maximum size	The size you attempted to use
2073	SRAM failure. Failed to clear the Global Preserve variable area.	Rebuild the project.		
2074	SRAM failure. Failed to clean up the Global Preserve variable save area.	Reboot the controller.		
2100	Initialization failure. Failed to open the initialization file.	Restore the controller configuration.		
2101	Initialization failure. Duplicated initialization.	Reboot the controller.		
2102	Initialization failure. Failed to initialize MNG.	Reboot the controller.		
2103	Initialization failure. Failed to create an event.	Reboot the controller.		
2104	Initialization failure. Failed to setup a priority.	Reboot the controller.		

No.	Message	Remedy	Note 1	Note 2
2105	Initialization failure. Failed to setup the stack size.	Reboot the controller.		
2106	Initialization failure. Failed to setup an interrupt process.	Reboot the controller.		
2107	Initialization failure. Failed to start an interrupt process.	Reboot the controller.		
2108	Initialization failure. Failed to stop an interrupt process.	Reboot the controller.		
2109	Initialization failure. Failed to terminate MNG.	Reboot the controller.		
2110	Initialization failure. Failed to allocate memory.	Reboot the controller.		
2111	Initialization failure. Failed to initialize motion.	Restore the controller configuration.		
2112	Initialization failure. Failed to terminate motion.	Reboot the controller.		
2113	Initialization failure. Failed to map SRAM.	Replace the CPU board.		
2114	Initialization failure. Failed to register SRAM.	Replace the CPU board.		
2115	Initialization failure. Fieldbus board is beyond the maximum count.	Check the number of fieldbus boards.		
2116	Initialization failure. Failed to initialize fieldbus.	Reboot the controller. Check the fieldbus board. Replace the fieldbus board.		
2117	Initialization failure. Failed to terminate fieldbus.	Reboot the controller.		
2118	Initialization failure. Failed to open motion.	Restore the controller configuration.		
2119	Initialization failure. Failed to initialize conveyor tracking.	Make sure the settings of conveyor and encoder are correct.		
2120	Initialization failure. Failed to allocate the system area.	Reboot the controller.		
2121	Initialization failure. Failed to allocate the object file area.	Reboot the controller.		
2122	Initialization failure. Failed to allocate the robot area.	Reboot the controller.		
2123	Initialization failure. Failed to create event.	Reboot the controller.		
2124	Initialization failure. An unsupported Fieldbus module is installed.	Install the Fieldbus module purchased from SEC.		
2126	The settings are initialized since the initial setting file is corrupted. Restore the system.	Since the initial setting file has significantly corrupted, the initial setting file of factory-default is used.		
2130	MCD failure. Failed to open the MCD file.	Restore the controller configuration.		
2131	MCD failure. Failed to map the MCD file.	Restore the controller configuration.		
2132	PRM failure. PRM file cannot be found.	Restore the controller configuration.		

No.	Message	Remedy	Note 1	Note 2
2133	PRM failure. Failed to map the PRM file.	Restore the controller configuration.		
2134	PRM failure. PRM file contents error.	Restore the controller configuration.		
2135	PRM failure. Failed to convert the PRM file.	Reboot the controller.		
2136	PRM failure. Failed to convert the PRM file.	Reboot the controller.		
2137	PRM failure. Failed to convert the PRM file.	Reboot the controller.		
2140	DU Initialization Error. Cannot use drive units.	Communication with drive units is not available for the virtual controllers. Return the configuration file to original setting if it was changed.		
2141	DU Initialization Error. Failed to initialize drive units.	Check the connection with drive units.		
2142	DU Initialization Error. Failed to initialize drive units.	Check the connection with drive units.		
2143	DU Initialization Error. Timeout during initialization of drive units.	Check the connection with drive units.		
2144	DU Initialization Error. No data to download to drive units.	Reboot the control unit and drive units.		
2145	DU Initialization Error. Failed to start communication with drive units.	Reboot the control unit and drive units.		
2146	DU Initialization Error. Timeout when starting communication with drive units.	Reboot the control unit and drive units.		
2147	DU Initialization Error. Failed to update the drive units software.	Review the software update setting. Check the connection with the Drive Unit.		
2148	DU Initialization Error. Failed to update the drive units software.	Check the file name. Check the update file.		
2149	DU Initialization Error. Failed to update the drive units software.	Check the Drive Unit power and connection. Reboot the Controller.		
2150	Operation failure. Task number cannot be found.	Reboot the Controller.		
2151	Operation failure. Executing the task.	Reboot the Controller.		
2152	Operation failure. Object code size failure.	Reboot the Controller.		
2153	Operation failure. Jog parameter failure.	Reboot the Controller.		
2154	Operation failure. Executing jog.	Reboot the Controller.		
2155	Operation failure. Cannot execute the jog function.	Reboot the Controller.		
2156	Operation failure. Jog data is not configured.	Reboot the Controller.		
2157	Operation failure. Failed to change the jog parameter.	Reboot the Controller.		
2158	Operation failure. Failed to allocate the area for the break point.	Reboot the Controller.		

No.	Message	Remedy	Note 1	Note 2
2159	Operation failure. Break point number is beyond the allowable setup count.	Reduce the break points.		
2160	Operation failure. Failed to allocate the function ID.	Reboot the Controller.		
2161	Operation failure. Failed to allocate the local variable address.	Reboot the Controller.		
2162	Operation failure. Not enough buffer to store the local variable.	Review the size of the Local variable.		
2163	Operation failure. Value change is available only when the task is halted.	Halt the task by the break point.		
2164	Operation failure. Failed to allocate the global variable address.	Review the size of the global variable.		
2165	Operation failure. Not enough buffer to store the global variable.	Review the size of the global variable.		
2166	Operation failure. Failed to obtain the Global Preserve variable address.	Review the size of the global preserve variable.		
2167	Operation failure. Not enough buffer to store the Global Preserve variable.	Review the size of the global preserve variable.		
2168	Operation failure. SRAM is not mapped.	Reboot the Controller.		
2169	Operation failure. Cannot clear the Global Preserve variable when loading the object file.	Reboot the Controller.		
2170	Operation failure. Not enough buffer to store the string.	Check the size of the string variable.		
2171	Operation failure. Cannot start the task after low voltage was detected.	Check the controller power. Reboot the Controller.		
2172	Operation failure. Duplicated remote I/O configuration.	Reboot the Controller.		
2173	Remote setup error. Cannot assign non-existing input number to remote function.	Check the I/O input number.		
2174	Remote setup error. Cannot assign non-existing output number to remote function.	Check the I/O output number.		
2175	Operation failure. Remote function is not configured.	Reboot the Controller.		
2176	Operation failure. Event wait error.	Reboot the Controller.		
2177	Operation failure. System backup failed.	Reboot the Controller. Install the Controller firmware.		
2178	Operation failure. System restore failed.	Reboot the Controller. Install the Controller firmware.		
2179	Remote setup error. Cannot assign same input number to some remote functions.	Check the remote setting.		

Maintenance 9. Troubleshooting

No.	Message	Remedy	Note 1	Note 2
2180	Remote setup error. Cannot assign same output number to some remote functions.	Check the remote setting.		
2181	Operation failure. Task number has not been reserved for RC+ API.	Set the number of RC+API tasks.		
2190	Cannot calculate because it was queue data.	Review the program.		
2191	Cannot execute AbortMotion because robot is not running from a task.	If you don't operate the robot from a program, you cannot use AbortMotion.		
2192	Cannot execute AbortMotion because robot task is already finished.	Task is completed. Review the program.		
2193	Cannot execute Recover without motion because AbortMotion was not executed.	Execute AbortMotion in advance to execute Recover WithoutMove.		
2194	Conveyor setting error.	Make sure the settings of conveyor and encoder are correct.		
2195	Conveyor setting error.	Make sure the settings of conveyor and encoder are correct.		
2196	Conveyor number is out of range.	Make sure the settings of conveyor and encoder are correct.		
2197	Command parameter prohibited for conveyor tracking motion was used.	Delete LJM.		
2200	Robot in use. Cannot execute the motion command when other tasks are using the robot.	The motion command for the robot cannot be simultaneously executed from more than one task. Review the program.		
2201	Robot does not exist.	Check whether the robot setting is performed properly. Restore the controller configuration.		
2202	Motion control module status failure. Unknown error was returned.	Rebuild the project.		
2203	Cannot clear local number '0'.	The Local number 0 cannot be cleared. Review the program.		
2204	Cannot clear an arm while in use.	The Arm cannot be cleared while it is in use. Check whether the Arm is not used.	The Arm number you attempted to clear	
2205	Cannot clear arm number '0'.	The Arm number 0 cannot be cleared. Review the program.		
2206	Cannot clear a tool while in use.	The Tool cannot be cleared while it is in use. Check whether the Tool is not used.	The Tool number you attempted to clear	
2207	Cannot clear tool number '0'.	The Tool number 0 cannot be cleared. Review the program.		
2208	Cannot clear ECP '0'.	The ECP number 0 cannot be cleared. Review the program.		
2209	Cannot clear an ECP while in use.	The ECP cannot be cleared while it is in use. Check whether the ECP is not used.	The ECP number you attempted to clear	

No.	Message	Remedy	Note 1	Note 2
2210	Cannot specify ' 0 ' as the local number.	The command processing the Local cannot specify the Local number 0. Review the program.		
2216	Box number is out of range.	Available Box numbers are from 1 to 15. Review the program.		
2217	Box number is not defined.	Specified Box is not defined. Review the Box number.		
2218	Plane number is out of range.	Available Box numbers are from 1 to 15. Review the program.		
2219	Plane number is not defined.	Specified Plane is not defined. Review the Plane number.		
2220	PRM failure. No PRM file data is found.	Reboot the controller. Restore the controller configuration.		
2221	PRM failure. Failed to flash the PRM file.	Reboot the controller. Restore the controller configuration.		
2222	Local number is not defined.	Check the Local setting. Review the program.	The specified Local number	
2223	Local number is out of range.	Available Local number is from 1 to 15. Review the program.	The specified Local number	
2224	Unsupported. MCOFS is not defined	-		
2225	CalPIs is not defined.	Check the CalPIs setting.		
2226	Arm number is out of range.	Available Arm number is from 0 to 3. Depending on commands, the Arm number 0 is not available. Review the program.	The specified Arm number	
2227	Arm number is not defined.	Check the Arm setting. Review the program.	The specified Arm number	
2228	Pulse for the home position is not defined.	Check the HomeSet setting.		
2229	Tool number is out of range.	Available Tool number is from 0 to 3. Depending on commands, the Tool number 0 is not available. Review the program.	The specified Tool number	
2230	Tool number is not defined.	Check the Tool setting. Review the program.	The specified Tool number	
2231	ECP number is out of range.	Available Tool number is from 0 to 15. Depending on commands, the Tool number 0 is not available. Review the program.	The specified ECP number	
2232	ECP number is not defined.	Check the ECP setting. Review the program.	The specified ECP number	
2233	Axis to reset the encoder was not specified.	Be sure to specify the axis for encoder reset.		
2234	Cannot reset the encoder with motor in the on state.	Turn the motor power OFF before reset.		
2235	XYLIM is not defined.	Check the XYLim setting. Review the program.		
2236	PRM failure. Failed to set up the PRM file contents to the motion control status module.	Reboot the controller. Restore the controller configuration.		
2237	Pallet number is out of range.	Available Pallet numbers are from 0 to 15. Review the program.		

Maintenance 9. Troubleshooting

No.	Message	Remedy	Note 1	Note 2
2238	Pallet is not defined.	Check the Pallet setting.		
2240	Array subscript is out of user defined range. Cannot access or update beyond array bounds.	Check the array subscript. Review the program.	The dimensions exceeding the definition	The specified subscript
2241	Dimensions of array do not match the declaration.	Check the array's dimensions. Review the program.		
2242	Zero '0' was used as a divisor.	Review the program.		
2243	Variable overflow. Specified variable was beyond the maximum allowed value.	Check the variable type and calculation result. Review the program.		
2244	Variable underflow. Specified variable was below the minimum allowed value.	Check the variable type and calculation result. Review the program.		
2245	Cannot execute this command with a floating point number.	This command cannot be executed for Real or Double type. Review the program.		
2246	Cannot calculate the specified value using the Tan function.	Check the specified value. Review the program.	The specified value	
2247	Specified array subscript is less than '0'.	Check the specified value. Review the program.	The specified value	
2248	Array failure. Redim can only be executed for an array variable.	You attempted to Redim the variable that is not array. Rebuild the project.		
2249	Array failure. Cannot specify Preserve for other than a single dimension array.	Other than a single dimension array was specified as Preserve for Redim. Rebuild the project.		
2250	Array failure. Failed to calculate the size of the variable area.	Rebuild the project.		
2251	Cannot allocate enough memory for Redim statement.	Reduce the number of subscripts to be specified for Redim. Perform Redim modestly.		
2252	Cannot allocate enough memory for ByRef.	Reduce the number of array's subscripts to be seen by ByRef.		
2253	Cannot compare characters with values.	Check whether the string type and the numeric data type are not compared. Review the program.		
2254	Specified data is beyond the array bounds. Cannot refer or update beyond the array bounds.	Check the number of array's subscripts and data. Review the program.	The number of array subscripts	The number of data to be referred or updated
2255	Variable overflow or underflow. Specified variable is out of value range.	The value that exceeds the range of Double type is specified. Review the program.		
2256	Specified array subscript is beyond the maximum allowed range.	Reduce the number of subscripts to be specified. For available subscripts, see the online help.		
2257	Cannot specify Int64 variable or UInt64 variable.	Int64 variable or UInt64 variable cannot be specified. Correct the program.		
2260	Task number is out of the available range.	For available task number, see the online help. Review the program.	The specified task number	
2261	Specified task number does not exist.	Review the program.	The specified task number	

No.	Message	Remedy	Note 1	Note 2
2262	Robot number is out of the available range.	The available Robot number is 1. Review the program.	The specified robot number	
2263	Output number is out of the available range. The Port No. or the Device No. is out of the available range.	For available output number, see the online help. Review the program.	The specified output number	
2264	Command argument is out of the available range. Check the arguments. Added data 1: Passed value. Added data 2: argument order.	For available range of argument, see the online help. Review the program.	The Added value	What number argument?
	Command parameter out of range	Part Feeding: Wrong command format or value settings. Read the description for the corresponding command provided in <i>Part Feeding 7.0 Introduction & Hardware (Common) & Software Software 3. Part Feeding SPEL+ Command Reference</i> and correct the code.		
2265	Joint number is out of the available range.	Available Joint number is from 1 to 6. Review the program.	The specified joint number	
2266	Wait time is out of available range.	Available wait time is from 0 to 2147483. Review the program.	The specified wait time	
2267	Timer number is out of available range.	Available timer number is from 0 to 15. Review the program.	The specified timer number	
2268	Trap number is out of available range.	Available trap number is from 1 to 4. Review the program.	The specified trap number	
2269	Language ID is out of available range.	For available language ID, see the online help. Review the program.	The specified language ID	
2270	Specified D parameter value for the parallel process is out of available range.	Available D parameter value is from 0 to 100. Review the program.	The specified D parameter value	
2271	Arch number is out of available range.	Available arch number is from 0 to 7. Review the program.	The specified arch number	
2272	Device No. is out of available range.	The specified number representing a control device or display device is out of available range. For available device number, see the online help. Review the program.	The specified device number	
2273	Output data is out of available range.	Available output data value is from 0 to 255. Review the program.	Output data	What number byte data is out of range?
2274	Asin argument is out of available range. Range is from -1 to 1.	Review the program.		
2275	Acos argument is out of available range. Range is from -1 to 1.	Review the program.		
2276	Sqr argument is out of available range.	Review the program.		
2277	Randomize argument is out of available range.	Review the program.		

Maintenance 9. Troubleshooting

No.	Message	Remedy	Note 1	Note 2
2278	Sin, Cos, Tan argument is out of available range.	Review the program.		
2280	Timeout period set by the TMOut statement expired before the wait condition was completed in the WAIT statement.	Investigate the cause of timeout. Check whether the set timeout period is proper.	Timeout period	
2281	Timeout period set by TMOut statement in WaitSig statement or SyncLock statement expired.	Investigate the cause of timeout. Check whether the set timeout period is proper.	Signal number	Timeout period
2282	Timeout period set by TMOut statement in WaitNet statement expired.	Investigate the cause of timeout. Check whether the set timeout period is proper.	Port number	Timeout period
2283	Timeout. Timeout at display device setting.	Reboot the controller.		
2290	Cannot execute a motion command.	Cannot execute the motion command after using the user function in the motion command. Review the program.		
2291	Cannot execute the OnErr command.	Cannot execute OnErr in the motion command when using user function in the motion command. Review the program.		
2292	Cannot execute an I/O command while the safeguard is open. Need Forced.	I/O command cannot be executed while the safeguard is open. Review the program		
2293	Cannot execute an I/O command during emergency stop condition. Need Forced.	I/O command cannot be executed during emergency stop condition. Review the program.		
2294	Cannot execute an I/O command when an error has been detected. Need Forced.	I/O command cannot be executed while an error occurs. Review the program.		
2295	Cannot execute this command from a NoEmgAbort Task and Background Task.	For details on in executable commands, refer to the online help. Review the program.		
2296	One or more source files are updated. Please build the project.	Rebuild the project.		
2297	Cannot execute an I/O command in TEACH mode without the Forced parameter.	I/O command cannot be executed in TEACH mode. Review the program.		
2298	Cannot continue execution in Trap SGCclose process.	You cannot execute Cont and Recover statements with processing task of Trap SGCclose.		
2299	Cannot execute this command. Need the setting [enable the advance task control commands] from RC+ controller preference settings.	Enable the [enable the advance task control commands] from RC+ to execute the command.		
2300	Robot in use. Cannot execute the motion command when other task is using the robot.	The motion command for the robot cannot be simultaneously executed from more than one task. Review the program.	Task number that is using the robot	
2301	Cannot execute the motion command when the Enable Switch is OFF.	Execute the motion command with the enable switch gripped.		
2302	Cannot execute a Call statement in a Trap Call process.	Another function cannot be called from the function called by Trap Call. Review the program.		

No.	Message	Remedy	Note 1	Note 2
2303	Cannot execute a Call statement in a parallel process.	Review the program.		
2304	Cannot execute an Xqt statement in a parallel process.	Review the program.		
2305	Cannot execute a Call statement from the command window.	Execute Call from the program.		
2306	Cannot execute an Xqt statement from the task started by Trap Xqt.	Review the program.		
2307	Cannot execute this command while tasks are executing.	Check whether all tasks are completed.		
2308	Cannot turn on the motor because of a critical error.	Find the previously occurring error in the error history and resolve its cause. Then, reboot the controller.		
2309	Cannot execute a motion command while the safeguard is open.	Check the safeguard status.		
2310	Cannot execute a motion command while waiting for continue.	Execute the Continue or Stop and then execute the motion command.		
2311	Cannot execute a motion command during the continue process.	Wait until the Continue is complete and then execute the motion command.		
2312	Cannot execute a task during emergency stop condition.	Check the emergency stop status.		
2313	Cannot continue execution immediately after opening the safeguard.	Wait 1.5 seconds after the safeguard is open, and then execute the Continue.		
2314	Cannot continue execution while the safeguard is open.	Check the safeguard status.		
2315	Cannot execute Cont and Restart command in resume operation.	Wait until the Continue is completed.		
2316	Cannot continue execution after an error has been detected.	Check the error status.		
2317	Cannot execute the task when an error has been detected.	Reset the error by Reset and then execute the task.		
2318	Cannot execute a motion command when an error has been detected.	Execute the motion command after resetting the error by Reset.		
2319	Cannot execute an I/O command during emergency stop condition.	Check the emergency stop status.		
2320	Function failure. Argument type does not match.	Rebuild the project.		
2321	Function failure. Return value does not match to the function.	Rebuild the project.		
2322	Function failure. ByRef type does not match.	Rebuild the project.		
2323	Function failure. Failed to process the ByRef parameter.	Rebuild the project.		
2324	Function failure. Dimension of the ByRef parameter does not match.	Rebuild the project.		
2325	Function failure. Cannot use ByRef in an Xqt statement.	Rebuild the project.		
2326	Cannot execute a Dll Call statement from the command window.	Execute Dll Call from the program.		
2327	Failed to execute a Dll Call.	Check the DLL. Review the program.		

No.	Message	Remedy	Note 1	Note 2
2328	Cannot execute the task before connection with RC+.	You need to connect with RC+ before executing the task.		
2329	Cannot execute an Eval statement in a Trap Call process.	Check the program.		
2330	Trap failure. Cannot use the argument in Trap Call or Xqt statement.	Check the program.		
2331	Trap failure. Failed to process Trap Goto statement.	Rebuild the project.		
2332	Trap failure. Failed to process Trap Goto statement.	Rebuild the project.		
2333	Trap failure. Trap is already in process.	Rebuild the project.		
2334	Cannot execute an Eval statement in a Trap Finish or a Trap Abort process.	Check the program.		
2335	Cannot continue execution and Reset Error in TEACH mode.	Check the program.		
2336	Cannot use Here statement with a parallel process.	Go Here :Z(0) ! D10; MemOn(1) ! is not executable. Change the program to: P999 = Here Go P999 Here :Z(0) ! D10; MemOn(1) !		
2337	Cannot execute except from an event handler functions of GUI Builder.	Review the program.		
2338	Cannot execute Xqt, data input, and output for TP in a TEST mode.	Cannot execute in TEST mode. Review the program.		
2339	Cannot execute in stand-alone mode.	Change the setting to "cooperative mode" and execute.		
2340	Specified value in InBCD function is an invalid BCD value.	Review the program.	Tens digit	Units digit
2341	Specified value in the OpBCD statement is an invalid BCD value.	Review the program.	The specified value	
2342	Cannot change the status for output bit configured as remote output.	Check the remote I/O setting.	I/O number	1: bit, 2: byte, 3: word
2343	Output time for asynchronous output commanded by On or Off statement is out of the available range.	Review the program.	The specified time	
2344	I/O input/output bit number is out of available range or the board is not installed.	Review the program. Check whether the expansion I/O board and Fieldbus I/O board are correctly detected.	Bit number	
2345	I/O input/output byte number is out of available range or the board is not installed.	Review the program. Check whether the expansion I/O board and Fieldbus I/O board are correctly detected.	Byte number	
2346	I/O input/output word number is out of available range or the board is not installed.	Review the program. Check whether the expansion I/O board and Fieldbus I/O board are correctly detected.	Word number	

No.	Message	Remedy	Note 1	Note 2
2347	Memory I/O bit number is out of available range.	Review the program.	Bit number	
2348	Memory I/O byte number is out of available range.	Review the program.	Byte number	
2349	Memory I/O word number is out of available range.	Review the program.	Word number	
2350	Command allowed only when virtual I/O mode is active.	The command can be executed only for virtual I/O mode.		
2353	Specified command cannot be executed from the Command window.	Execute specified command from the program.		
		Part Feeding: The command cannot run on the Command window.		
2354	Cannot execute the I/O output command when the Enable Switch is OFF.	Execute the I/O output command with the enable switch gripped.		
2360	File failure. Failed to open the configuration file.	Restore the controller configuration.		
2361	File failure. Failed to close the configuration file.	Restore the controller configuration.		
2362	File failure. Failed to open the key of the configuration file.	Restore the controller configuration.		
2363	File failure. Failed to obtain a string from the configuration file.	Restore the controller configuration.		
2364	File failure. Failed to write in the configuration file.	Restore the controller configuration.		
2365	File failure. Failed to update the configuration file.	Restore the controller configuration.		
2370	The string combination exceeds the maximum string length.	The maximum string length is 255. Review the program.	Combined string length	
2371	String length is out of range.	The maximum string length is 255. Review the program.	The specified length	
2372	Invalid character is specified after the ampersand in the Val function.	Review the program.		
2373	Illegal string specified for the Val function.	Review the program.		
2374	String Failure. Invalid character code in the string.	Review the program.		
2380	Cannot use ' 0 ' for Step value in For...Next.	Check the Step value.		
2381	Relation between For...Next and GoSub is invalid. Going in or out of a For...Next using a Goto statement.	Review the program.		
2382	Cannot execute Return while executing OnErr.	Review the program.		
2383	Return was used without GoSub. Review the program.	Review the program.		
2384	Case or Send was used without Select. Review the program.	Review the program.		
2385	Cannot execute EResume while executing GoSub.	Review the program.		

Maintenance 9. Troubleshooting

No.	Message	Remedy	Note 1	Note 2
2386	EResume was used without OnErr. Review the program.	Review the program.		
2400	Curve failure. Failed to open the Curve file.	Reboot the controller. Create a Curve file again.		
2401	Curve failure. Failed to allocate the header data of the curve file.	Reboot the controller. Create a Curve file again.		
2402	Curve failure. Failed to write the curve file.	Reboot the controller. Create a Curve file again.		
2403	Curve failure. Failed to open the curve file.	Reboot the controller. Create a Curve file again.		
2404	Curve failure. Failed to update the curve file.	Reboot the controller. Create a Curve file again.		
2405	Curve failure. Failed to read the curve file.	Reboot the controller. Create a Curve file again.		
2406	Curve failure. Curve file is corrupt.	Reboot the controller. Create a Curve file again.		
2407	Curve failure. Specified a file other than a curve file.	Reboot the controller. Create a Curve file again.		
2408	Curve failure. Version of the curve file is invalid.	Reboot the controller. Create a Curve file again.		
2409	Curve failure. Robot number in the curve file is invalid.	Reboot the controller. Create a Curve file again.		
2410	Curve failure. Cannot allocate enough memory for the CVMove statement.	Reboot the controller.		
2411	Specified point data in the Curve statement is beyond the maximum count.	The maximum number of points specified in the Curve statement is 200. Review the program.		
2412	Specified number of output commands in the Curve statement is beyond the maximum count.	The maximum number of output commands specified in the Curve statement is 16. Review the program.		
2413	Curve failure. Specified internal code is beyond the allowable size in Curve statement.	Reboot the controller.		
2414	Specified continue point data P(:) is beyond the maximum count.	The maximum number of points specified continuously is 200. Review the program.	Start point	End point
2415	Curve failure. Cannot create the curve file.	Reboot the controller. Create a Curve file again.		
2416	Curve file does not exist.	Check whether the specified Curve file name is correct.		
2417	Curve failure. Output command is specified before the point data.	Check whether no output command is specified before the point data.		
2430	Error message failure. Error message file does not exist.	Reboot the controller.		
2431	Error message failure. Failed to open the error message file.	Reboot the controller.		
2432	Error message failure. Failed to obtain the header data of the error message file.	Reboot the controller.		

No.	Message	Remedy	Note 1	Note 2
2433	Error message failure. Error message file is corrupted.	Reboot the controller.		
2434	Error message failure. Specified a file other than the error message file.	Reboot the controller.		
2435	Error message failure. Version of the error message file is invalid.	Reboot the controller.		
2440	File Error. File number is already used.	Check the file number.		
2441	File Error. Failed to open the file.	Make sure the file exists and you specified the file correctly.		
2442	File Error. The file is not open.	Open the file in advance.		
2443	File Error. The file number is being used by another task.	Check the program.		
2444	File Error. Failed to close the file.	Check the file.		
2445	File Error. File seek failed.	Review the program. Check the pointer setting.		
2446	File Error. All file numbers are being used.	Close unnecessary files.		
2447	File Error. No read permission.	Use ROpen or UOpen that has read access to the file.		
2448	File Error. No write permission.	Use WOpen or UOpen that has write access to the file.		
2449	File Error. No binary permission.	Use BOpen that has binary access to the file.		
2450	File Error. Failed to access the file.	Check the file.		
2451	File Error. Failed to write the file.	Check the file.		
2452	File Error. Failed to read the file.	Check the file.		
2453	File Error. Cannot execute the command for current disk.	The specified command is not available in the current disk (ChDisk).		
2454	File Error. Invalid disk.	Review the program.		
2455	File Error. Invalid drive.	Review the program.		
2456	File Error. Invalid folder.	Review the program.		
2460	Database Error. The database number is already being used.	Review the program. Specify the number of other database. Close the database.		
2461	Database Error. The database is not open.	Review the program. Open the database.		
2462	Database Error. The database number is being used by another task.	Review the program.		
2470	Windows Communication Error. Invalid status.	Reboot the Controller. Rebuild the project.		
2471	Windows Communication Error. Invalid answer.	Reboot the Controller. Rebuild the project.		

Maintenance 9. Troubleshooting

No.	Message	Remedy	Note 1	Note 2
2472	Windows Communication Error. Already initialized.	Reboot the Controller.		
2473	Windows Communication Error. Busy.	Reboot the Controller. Rebuild the project.		
2474	Windows Communication Error. No request.	Reboot the Controller. Rebuild the project.		
2475	Windows Communication Error. Data buffer overflow.	Reduce the data volume. Review the program.		
2476	Windows Communication Error. Failed to wait for event.	Reboot the Controller.		
2477	Windows Communication Error. Invalid folder.	Make sure the specified folder is correct.		
2478	Windows Communication Error. Invalid error code.	Rebuild the project.		
2500	Specified event condition for Wait is beyond the maximum count.	The maximum number of event conditions is 8. Review the program.		
2501	Specified bit number in the Ctr function was not initialized with a CTRreset statement.	Review the program.	The specified bit number	
2502	Task number is beyond the maximum count to execute.	The available number of tasks that can be executed simultaneously is 32 for normal tasks, and 16 for background tasks. Review the program.		
2503	Cannot execute Xqt when the specified task number is already executing.	Review the program.	The specified task number	
2504	Task failure. Specified manipulator is already executing a parallel process.	Rebuild the project.		
2505	Not enough data for Input statement variable assignment.	Check the content of communication data. Review the program.		
2506	Specified variable for the Input statement is beyond the maximum count.	For OP, only one variable can be specified. For other devices, up to 32 variables can be specified.		
2507	All counters are in use and cannot initialize a new counter with CTRreset.	The available number of the counters that can be set simultaneously is 16. Review the program.		
2508	OnErr failure. Failed to process the OnErr statement.	Rebuild the project.		
2509	OnErr failure. Failed to process the OnErr statement.	Rebuild the project.		
2510	Specified I/O label is not defined.	The specified I/O label is not registered. Check the I/O label file.		
2511	SyncUnlock statement is used without executing a previous SyncLock statement. Review the program.	Review the program.	Signal number	
2512	SyncLock statement was already executed.	The SyncLock statement cannot be executed for the second time in a row. Review the program.	Signal number	
2513	Specified point label is not defined.	The specified point label is not registered. Check the point file.		

No.	Message	Remedy	Note 1	Note 2
2514	Failed to obtain the motor on time of the robot.	Reboot the controller.		
2515	Failed to configure the date or the time.	Check whether a date and time is set correctly.		
2516	Failed to obtain the debug data or to initialize.	Reboot the controller.		
2517	Failed to convert into date or time.	Check the time set on the controller. Reboot the controller.		
2518	Larger number was specified for the start point data than the end point data.	Specify a larger number for the end point data than that for the start point data.	Start point	End point
2519	Invalid format syntax for FmtStr\$.	Check the format.		
2520	File name is too long.	Check whether the specified point file name is correct. The maximum string length of the file name is 32.		
2521	File path is too long.	Check whether the specified point file name is correct.		
2522	File name is invalid.	Make sure you don't use improper characters for file name.		
2523	The continue process was already executed.	Review the program.		
2524	Cannot execute Xqt when the specified trap number is already executing.	Review the program.		
2525	Password is invalid.	Check whether a password is set correctly.		
2526	No wait terms.	Rebuild the project.		
2527	Too many variables used for global variable wait.	Review the program.		
2528	The global variable that was not able to be used for the wait command was specified.	Review the program.		
2529	Cannot use ByRef if the variable is used for global variable wait.	Review the program.		
2530	Too many point files.	Check the point file.		
2531	The point file is used by another robot.	Review the program.		
2532	Cannot progress to the point position because there is undefined data.	Check the point data.		
2533	Error on INP or OUP.	Review the program.		
2534	No main function to start for Restart statement.	Without executing main function, Restart is called.		
2535	Does not allow Enable setting in Teach mode to be changed.	Setup the authority.		
2536	Failed to change Enable setting in Teach mode.	Reboot the Controller.		
2537	Count of point data P(:) is not correct or format of parameter is not correct.	Review the program.		
2538	Force_GetForces failure. Failed to process Force_GetForces statement.	Review the program.		
2539	Password is invalid.	Check the password.		
2540	Not connected to RC+.	Connect to the RC+.		

Maintenance 9. Troubleshooting

No.	Message	Remedy	Note 1	Note 2
2541	Duplicate parameter.	Same robot number was specified. Check the parameter.		
2542	The specified work queue number is invalid.	Available work queue number s are from 1 to 16. Review the program.		
2543	Invalid sequence was specified.	Specified sequence name cannot be found. Review the sequence name.		
2544	Invalid object was specified.	Specified object name cannot be found. Review the object name.		
2545	Invalid calibration was specified.	Specified calibration name cannot be found. Review the calibration name.		
2546	Cannot turn on the motor immediately after opening the safeguard.	Wait 1.5 seconds after the safeguard is open, and then execute the motor on.		
2547	Cannot use specified option	Part Feeding: Wrong command format or value settings. Read the description for the corresponding command provided in <i>Part Feeding 7.0 Introduction & Hardware (Common) & Software Software 3. Part Feeding SPEL+ Command Reference</i> and correct the code.		
2548	Too many force files. Delete the force files or use the existing force files.	Reboot the controller. Initialize the controller firmware. Replace the controller.		
2549	The force file which is not associated with the robot cannot be specified. Specify the correct force file.	Reboot the controller. Initialize the controller firmware. Replace the controller.		
2550	Specified command is not supported for joint type robot and cartesian type robot.	Specified robot is not supported. Check the robot configuration.		
2551	Failed to Get the health information.	Reboot the controller.		
2552	Does not allow setting in UL mode to be changed.	Setup the authority.		
2553	Failed to change setting in UL mode.	Reboot the Controller.		
2556	An excessive loop was detected. Please reduce the number of looped tasks or set Wait	This error messages is only displayed in T/VT series Manipulators. Do not perform any processing such as infinite loop or any other similar processing as much as possible. For more details, refer to Restrictions of Functions in Maintenance, T/VT series manual.		
2557	An error occurred in Trap. Note 1: Detailed error information Following the detailed error information, take a relevant countermeasure.	An error occurred in Trap. Check the corresponding error code in the system history and take countermeasures.	Detailed error information	
2558	Argument parameter is too long.	Confirm a parameter of the argument.		
2559	Cannot execute when the motor is in the off state.	Change to the state to motor on and execute.		

No.	Message	Remedy	Note 1	Note 2
2560	The current robot number and the robot number of the force guide sequence property do not match. Please check the robot number.	Confirm the current robot number and the robot number of the force guide sequence.	Robot number	
2561	The current robot type and the robot type of the force guide sequence property do not match. Reconfigure the RobotNumber property.	Confirm the current robot number and the robot number of the force guide sequence property. Reconfigure the RobotNumber property.		
2562	The current tool number and the robot tool of the force guide sequence property do not match. Please check the tool number.	Confirm the current tool number and the robot tool of the force guide sequence property.	Tool number	
2563	The point file being loaded does not match the point file of the force guide sequence property. Please check the point file.	Confirm the loaded point file and the point file of the force guide sequence.		
2564	An instruction that cannot be executed during torque control was executed.	Turn OFF the torque control and execute.		
2565	Prohibited command while tracking was executed.	Delete Prohibited commands from the program.		
2566	Cannot execute the FGRun command for same robot.	Cannot execute the FGRun command for same robot. End the FGRun command or execute it in other robot		
2567	Cannot execute the FGGet command for the running force guide sequence.	Cannot execute the FGGet command for the running force guide sequence. Execute it after the force guide sequence ends.		
2568	An instruction that cannot be executed by parallel processing was executed. Review the program.	Review the program.		
2569	Cannot get the force guide sequence property.	Reboot the Controller.		
2570	Sequence number is out of range. Please check the specified sequence number.	Sequence number is from 1 to 64. Confirm the specified sequence number.	Sequence number	
2571	Object number is out of range. Please check the specified object number.	Object number is from 1 to 16. Confirm the specified object number.	Object number	
2572	Cannot clear the result of the force guide.	Reboot the Controller.		
2573	Cannot set the result of the force guide.	Reboot the Controller.		
2574	Cannot get the result of the force guide.	Reboot the Controller.		
2575	Storing the force guide sequence result in a variable failed.	Reboot the Controller.		
2576	Force Sequence name that does not exist was specified.	Confirm the specified force sequence name.		
2577	Force Object name that does not exist was specified.	Confirm the specified force object name.		
2578	Cannot execute the FGGet command for the unexecuted force guide sequence.	Confirm the specified force guide sequence.		

No.	Message	Remedy	Note 1	Note 2
2580	Feeder name specified does not exist	Wrong feeder name specified. Check the feeder name in EPSON RC+ 7.0 - Menu - [Setup] - [System Configuration].		
2581	Failed to reset feeder. Check connection.	Cannot connect to the feeder. Check that feeder network settings (IP Address, IP Mask, Port) are correct. Check that the Ethernet connection between the feeder and the Controller is functioning normally (have cables become disconnected, is there a hub failure or a lack of power supply to the hub, etc.). Check the power supply to the feeder.		
2582	Feeder not connected. Check connection.	(As above)		
2583	Feeder backlight not enabled	Wrong feeder specified. Check that the backlight has been enabled in EPSON RC+ 7.0 - Menu - [Setup] - [System Configuration].		
2584	Feeder output terminal not enabled	Wrong feeder specified. Check that the hopper has been enabled in EPSON RC+ 7.0 - Menu - [Setup] - [System Configuration].		
2585	Incorrect feeder type	It occurs when restoring a controller backup, if the feeder configuration has been changed. Once remove and register feeder settings in "EPSON RC+ 7.0 - Menu - Setup - System Settings".		
2587	Cannot execute with the virtual controller	PartFeeding option requires a real controller to run.		
2588	Failed to acquire partfeeding information	This command cannot be executed from a command window or virtual controller. Check the description of the relevant command in the "Part Feeding SPEL+ Command Reference".		
2589	Command is not supported for mobile camera.	This command only works with the fixed downward camera, so please use the fixed downward camera. Review the vision sequence settings specified in the part blob vision sequence for the target part.		
		Part Feeding: The command cannot be used when the part vision sequence is using a mobile robot camera.		
2591	PF_ReleaseFeeder statement is used without executing a previous PF_AccessFeeder statement. Review the program.	Review the program.		
2592	PF_AccessFeeder statement was already executed.	The PF_AccessFeeder statement cannot be executed for the second time in a row. Review the program.		

No.	Message	Remedy	Note 1	Note 2
2600	Mass Property Object number is out of the allowable range. Check the range of numbers.	The MassProperties numbers that can be specified are from 1 to 15. Please review the program.		
2601	Mass Property Object is not defined. Check the setting.	Please confirm the setting of MassProperties. Please review the program.		
2602	Cannot clear Mass Property Object while in use. Specify another Mass Property Object before clearing the previous object.	MP cannot be cleared while in use. Please confirm whether MP is in use.		
2603	Cannot clear Mass Property Object number '0'	MP-number 0 cannot be cleared. Please review the program.		
2840	Failed in the confirmation of the DU connection count.	Check whether the Drive Unit is connected properly.		
2841	Failed in the acquisition of the DU connection count.	Check whether the Drive Unit is connected properly.		
2842	Failed in the confirmation of the DU connection information.	Check whether the Drive Unit is connected properly.		
2843	Failed in the acquisition of the DU connection information.	Check whether the Drive Unit is connected properly.		
2844	There is a missing number or repetition in the dip switch setting of DU.	Check the dip switches of the Drive Unit		
2845	The drive unit (DU) used by the robot is not connected.	Check whether the Drive Unit is connected properly.	Delete the robot registration or connect the DU with the manipulator registered.	
2846	Because the increase and decrease of the drive unit was recognized, the controller unit is rebooted.	The controller was rebooted due to change of connection with the Drive Unit.		
2847	The dip switch setting of the Force Sensor I/F unit is improper.	It is necessary to change the dip switch setting. Please inquire with us.		
2848	The Force Sensor I/F unit to which the Force Sensor is registered is not connected. Check connection.	Please confirm whether it is possible to connect it with Force Sensor I/F unit correctly.		
2849	Failed to initialize the Force Sensor I/F unit. Check connection.	Please confirm whether it is possible to connect it with Force Sensor I/F unit correctly.		
2850	Failed to initialize the Force Sensor I/F unit. Check connection.	Please confirm whether it is possible to connect it with Force Sensor I/F unit correctly.		
2851	The Force Sensor which is different from the registered sensor is connected. Check connection or review the setting.	The serial number of the sensor connected with the registered sensor is not corresponding. Please exchange it for a new sensor after confirming the connection, returning to the connected sensor, or invalidating the sensor. In case of intended replacement, configure the connection settings again in the sensor setting.		

Maintenance 9. Troubleshooting

No.	Message	Remedy	Note 1	Note 2
2852	The registered Force Sensor is not connected. Check connection.	Please confirm whether it is possible to connect it with the registered sensor correctly. Please invalidate the sensor when you do not connect the sensor.		
2853	Failed to update the Force Sensor I/F unit software. Review the update procedure.	Please review the soft update setting. Please confirm the connection with Force Sensor I/F unit.		
2854	Failed to update the Force Sensor I/F unit software. Review the update procedure.	Please confirm the file name. Please confirm the update file.		
2855	Failed to update the Force Sensor I/F unit software. Review the update procedure.	Please confirm the power supply and the connection of Force Sensor I/F unit. Reboot the controller.		
2856	The Force Sensor I/F unit with an old version is connected. Update the Force Sensor I/F unit software.	The version of the connected Force Sensor I/F unit needs to be updated. Update the Force Sensor I/F unit. For update procedures, please inquiry with us.		
2857	The robot registered to the Force Sensor I/F unit is not connected. Review the robot registration or the Force Sensor configuration.	The robot that relates to the sensor is not registered. Please review the registration of the robot or invalidate the robot connection.		
2858	Failed to allocate memory for the force monitor.	Reboot the controller. Please inquire with us if a similar error occurs after rebooting it.		
2859	Failed to allocate memory for the force log.	Reboot the controller. Please inquire with us if a similar error occurs after rebooting it.		
2860	The force monitor object specified in the force log is in use. Specify another force monitor object.	The same FM number cannot be specified. Please specify a different FM number.		
2861	The maximum number of the force logs is executed. Review the log timing.	The greatest log number is used. Please confirm the number of logs.		
2862	Failed to allocate memory of force function.	Reboot the controller. Please inquire with us if a similar error occurs after rebooting it.		
2863	Execution of force guide sequence, RecordStart, FCMStart and LogStart cannot be executed at the same time. Please review the program.	Execute after the LogStart property ends by LogEnd property.		
2864	Execution of force guide sequence, RecordStart, FCMStart and force monitor cannot be executed at the same time. Please quit either.	Execute after quitting the Force Monitor.		
2865	Execution of force guide sequence, RecordStart, FCMStart and LogStart cannot be executed at the same time. Please review the program.	Execute the LogStart property after the RecordStart property ends by force guide sequence, force control monitor, or the RecordEnd property.		

No.	Message	Remedy	Note 1	Note 2
2866	Execution of force guide sequence, RecordStart, FCMStart and force monitor cannot be executed at the same time. Please quit either.	Execute the force monitor after quitting the RecordStart property by force guide sequence, force control monitor, or the RecordEnd property.		
2867	The specified channel in use. Specify another channel.	The same channel cannot be specified. Specify a different channel to execute.		
2868	The force monitor object being used is specified. Please specify another force monitor object.	The same FM number cannot be specified. Specify a different FM number to execute.		
2869	The specified duration of measurement is smaller than the specified measurement interval. Check the parameter.	Specify the measurement time larger than the measurement interval to execute.		
2870	The product of the specified duration of measurement and the specified measurement interval is out of allowable range. Check the parameter.	Check the measurement time and interval.		
2871	Execution of force guide sequence, RecordStart, FCMStart, force monitor cannot be used more than three at the same time.	To execute newly, make sure to quit either of the two running items and execute.		
2872	Force monitor cannot be launched twice.	To start force monitor newly, quit the running force monitor and start a new one.		
2880	Failed to initialize the Force Sensor I/F board. Check connection.	Check connection of the controller and Force Sensor I/F board. Reboot the controller. Please inquire with us if a similar error occurs even after rebooting the controller.		
2881	Failed to initialize the Force Sensor I/F board. Check connection.	Check connection of the controller and Force Sensor I/F board. Reboot the controller. Please inquire with us if a similar error occurs even after rebooting the controller.		
2882	Detected two boards: Force Sensor I/F board and RS-232C board. If using the Force Sensor I/F board, RS-232C board is available up to one board.	Remove the Force Sensor I/F board or the second board of RS-232C board.		
2883	Detected two boards: Force Sensor I/F board and RS-232C board with the second board setting. If using the Force Sensor I/F board, return the setting to the first board of RS-232C board.	Return the setting to the first board of RS-232C board.		
2884	Failed to initialize the Force Sensor I/F board. Check connection.	Check connection of the controller and Force Sensor I/F board. Reboot the controller. Please inquire with us if a similar error occurs even after rebooting the controller.		

Maintenance 9. Troubleshooting

No.	Message	Remedy	Note 1	Note 2
2885	Sensor 3 and 4 of Force Sensors are enabling. If using Force Sensor I/F board, disable the sensor 3 and 4 of Force Sensors.	Disable the sensor 3 and 4 of the Force Sensor.		
2886	Failed to communicate with Force Sensor I/F board and Force Sensor. Check connection of the Force Sensor.	Check connection of the Force Sensor I/F board and Force Sensor. Reboot the controller. Please inquire with us if a similar error occurs even after rebooting the controller.		
2887	Detected Force Sensor I/F board and Force Sensor I/F unit. Remove either Force Sensor I/F board or Force Sensor I/F unit.	Unable to use the Force Sensor I/F board and Force Sensor I/F unit at the same time. Remove the Force Sensor I/F board or Force Sensor I/F unit.		
2888	Unsupported Force Sensor is set. Check the configuration.	Check the configuration. Firmware version may be old. Check whether the firmware version is supported and update it as necessary.		
2900	Failed to open as server for the Ethernet port.	Check whether the Ethernet port is set properly. Check whether the Ethernet cable is connected properly.		
2901	Failed to open as client for the Ethernet port.	Check whether the Ethernet port is set properly. Check whether the Ethernet cable is connected properly.		
	Failed to open TCP/IP port (client)	Parts Feeding: Cannot connect to the feeder. Check that feeder network settings (IP Address, IP Mask, Port) are correct. Check that the Ethernet connection between the feeder and the Controller is functioning normally (have cables become disconnected, is there a hub failure or a lack of power supply to the hub, etc.). Check the power supply to the feeder.		
2902	Failed to read from the Ethernet port.	Check whether the port of communication recipient is not close.		
2904	Invalid IP Address was specified.	Review the IP address.		
2905	Ethernet failure. No specification of Server/Client.	Review the program.		
2906	Ethernet port was not configured.	Check whether the Ethernet port is set properly.	Port number	
2907	Ethernet port was already in use by another task.	A single port cannot be used by more than one task.	Port number	
2908	Cannot change the port parameters while the Ethernet port is open.	The port parameters cannot be changed while the port is open.	Port number	
2909	Ethernet port is not open.	To use the Ethernet port, execute the OpenNet statement.	Port number	
2910	Timeout reading from an Ethernet port.	Check the communication.	Timeout value	
2911	Failed to read from an Ethernet port.	Check the communication.		

No.	Message	Remedy	Note 1	Note 2
2912	Ethernet port was already open by another task.	A single port cannot be used by more than one task.	Port number	
2913	Failed to write to the Ethernet port.	Check whether the Ethernet port is set properly. Check whether the Ethernet cable is connected properly.	Port number	
2914	Ethernet port connection was not completed.	Check whether the port of communication recipient is open.	Port number	
2915	Data received from the Ethernet port is beyond the limit of one line.	The maximum length of a line is 255 bytes.	The number of bytes in a received line	
2916	Failed to process a dummy file of virtual Ethernet port	Check the content of the dummy file.	Port number	
2920	RS-232C failure. RS-232C port process error.	Check whether the RS-232C board is correctly detected.		
2921	Failed to read from the RS-232C port.	Check the parameter and communication.		
2922	Failed to read from the RS-232C port. Overrun error.	Slow down data transfer or reduce data size.		
2926	The RS-232C port hardware is not installed.	Check whether the RS-232C board is correctly detected.	Port number	
2927	RS-232C port is already open by another task.	A single port cannot be used by more than one task.	Port number	
2928	Cannot change the port parameters while the RS-232C port is open.	The port parameters cannot be changed while the port is open.	Port number	
2929	RS-232C port is not open.	To use the RS-232C port, execute the OpenCom statement.	Port number	
2930	Timeout reading from the RS-232C port.	Check the communication.	Timeout value	
2931	Failed to read from the RS-232C port.	Check the communication.		
2932	RS-232C port is already open by another task.	A single port cannot be used by more than one task.	Port number	
2933	Failed to write to the RS-232C port.	Check the communication.	Port number	
2934	RS-232C port connection not completed.	Check the RS-232C port.		
2935	Data received from the RS-232C port is beyond the limit of one line.	The maximum length of a line is 255 bytes.	The number of bytes in a received line	
2936	Failed to process a dummy file of virtual RS-232C port	Check the content of the dummy file.	Port number	
2937	Cannot execute while Remote RS-232C are using.	Specified port is currently used. Specify another port.		
2938	Cannot execute while ModBus are using.	Specified port is currently used. Specify another port.		
2950	Daemon failure. Failed to create the daemon thread.	Reboot the Controller.		
2951	Daemon failure. Timeout while creating the daemon thread.	Reboot the Controller.		
2952	TEACH/AUTO switching key input signal failure was detected.	Set the TP key switch to TEACH or AUTO properly. Check whether the TP is connected properly.		
2953	ENABLE key input signal failure was detected.	Check whether the TP is connected properly.		

Maintenance 9. Troubleshooting

No.	Message	Remedy	Note 1	Note 2
2954	Relay weld was detected.	Overcurrent probably occurred due to short-circuit failure. Investigate the cause of the problem and take necessary measures and then replace the DPB.		
2955	Temperature of regeneration resistor was higher than the specified temperature.	Check whether the filter is not clogged up and the fan does not stop. If there is no problem on the filter and fan, replace the regenerative module.		
2970	MNG failure. Area allocate error.	Reboot the Controller.		
2971	MNG failure. Real time check error.	Reboot the Controller.		
2972	MNG failure. Standard priority error.	Reboot the Controller.		
2973	MNG failure. Boost priority error.	Reboot the Controller.		
2974	MNG failure. Down priority error.	Reboot the Controller.		
2975	MNG failure. Event wait error.	Reboot the Controller.		
2976	MNG failure. Map close error.	Reboot the Controller.		
2977	MNG failure. Area free error.	Reboot the Controller.		
2978	MNG failure. AddIOMem error.	Reboot the Controller.		
2979	MNG failure. AddInPort error.	Reboot the Controller.		
2980	MNG failure. AddOutPort error.	Reboot the Controller.		
2981	MNG failure. AddInMemPort error.	Reboot the Controller.		
2982	MNG failure. AddOutMemPort error.	Reboot the Controller.		
2983	MNG failure. IntervalOutBit error.	Reboot the Controller.		
2984	MNG failure. CtrReset error.	Reboot the Controller.		
2997	Collision Detection	If you use the simulator, check if the object is placed in the direction of the robot motion.		
2998	AbortMotion attempted when robot was not moving	See Help for AbortMotion.		
2999	AbortMotion attempted when robot was moving	See Help for AbortMotion.		

No.	Message	Remedy	Note 1	Note 2
3000	OBJ file size is large. TP1 may not be able to build this project.	When it is necessary to build the project from TP1, consider to reduce the program.		
3001	The number of variables which is using Wait command is near the maximum allowed.	The number of variables which is using Wait command is exceeding 56 (the maximum is 64). Check if there are unnecessary variables.		
3002	DLL file cannot be found.	Check if the DLL file exists in either of the following folders: - Project folder - Windows system folder - Configuration folder of environment variable PATH		
3003	DLL function cannot be found.	Check the name of the specified function. Also check the DLL file if the specified function exists in the DLL.		
3050	Main function is not defined.	Declare a Main function.		
3051	Function does not exist.	Declare an unresolved function.		
3052	Variable does not exist.	Declare an unresolved variable.		
3100	Syntax error.	Correct the syntax error.		
		Part Feeding: Command syntax is not correct. Check the description of the command in <i>Part Feeding 7.0 Introduction & Hardware (Common) & Software Software</i> "Part 3: Feeding SPEL+ Command Reference" and modify the code.		
3101	Parameter count error.	The number of parameters is excess or deficiency. Correct the parameters.		
		Part Feeding: Command syntax is not correct. Check the description of the command in <i>Part Feeding 7.0 Introduction & Hardware (Common) & Software Software</i> "Part 3: Feeding SPEL+ Command Reference" and modify the code.		
3102	File name length is beyond the maximum allowed.	Shorten the file name.		
3103	Duplicate function definition.	Change the function name.		
3104	Duplicate variable definition ' ** '.	Change the variable name.		
3105	Global and Global Preserve variables cannot be defined inside a function block.	Declare the Global and Global Preserve variables outside the function block.		
3106	An undefined function was specified.	Specify a valid function name.		
3107	Both While and Until for Do...Loop was specified.	The While/Until statement is specified for both Do statement and Loop statement. Delete either While/Until statement.		

No.	Message	Remedy	Note 1	Note 2
3108	Specified line number or label ' ** ' does not exist.	Set the line label.		
3109	Overflow error.	The direct numerical specification overflows. Reduce the numeric value.		
3110	An undefined variable was specified ' ** '.	There is an undefined variable. Declare the variable.		
3111	Specified variable is not an array variable.	Specify the array variable.		
3112	Cannot change the dimensions of the array variable.	Dimension of the array cannot be changed in Redim statement during the run time. Correct the program.		
3114	Specified Next variable does not match the specified For variable.	Correct the variable name.		
3115	Cannot use a point expression in the first argument.	Specify a single point for the point flag setting. Do not specify a point expression.		
3116	Array number of dimensions does not match the declaration.	Check the number of array dimensions.		
3117	File cannot be found.	The file that configures the project cannot be found. Check the project folder if the file exists.		
3118	Corresponding EndIf cannot be found.	The number of EndIf statements that correspond to If and Elself statements is not enough. Add the EndIf statements.		
3119	Corresponding Loop cannot be found.	The number of Loop statements that correspond to Do statements is not enough. Add the Loop statements.		
3120	Corresponding Next cannot be found.	The number of Next statements that correspond to For statements is not enough. Add the Next statements.		
3121	Corresponding Send cannot be found.	The number of Send statements that correspond to Select statements is not enough. Add the Send statements.		
3123	On/Off statements are beyond the maximum count.	An upper limit (max. 16) is set on the number of On/Off statements in Curve statement. Check the upper limit and correct the program.		
3124	Point number is beyond the maximum count.	An upper limit ("200" for open curves, "50" for closed curves) is set on the available number of points in Curve statement. Check the upper limit and correct the program.		
3125	Corresponding If cannot be found.	The number of EndIf statements that correspond to If statements is too many. Delete the unnecessary EndIf.		
3126	Corresponding Do cannot be found.	The number of Loop statements that correspond to Do statements is too many. Delete the unnecessary Loop.		
3127	Corresponding Select cannot be found.	The number of Send statements that correspond to Select statements is too many. Delete the unnecessary Send.		

No.	Message	Remedy	Note 1	Note 2
3128	Corresponding For cannot be found.	The number of Next statements that correspond to For statements is too many. Delete the unnecessary Next.		
3129	'_' cannot be used as the first character of an identifier.	Change the first character of the identifier to an alphabetic character.		
3130	Cannot specify ROT parameter.	ROT parameter cannot be specified in BGo, Go, TGo, Jump, and Jump3 statements. Correct the program.		
3131	Cannot specify ECP parameter.	ECP parameter cannot be specified in BGo, Go, TGo, Jump, Jump3, and Arc statements. Correct the program.		
3132	Cannot specify Arch parameter.	Arch parameter cannot be specified in BGo, Go, TGo, Arc, Arc3, BMove, Move, and TMove statements. Correct the program.		
3133	Cannot specify LimZ parameter.	LimZ parameter cannot be specified in BGo, Go, TGo, Jump3, Arc, Arc3, BMove, Move, and TMove statements. Correct the program.		
3134	Cannot specify Sense parameter.	Sense parameter cannot be specified in BGo, Go, TGo, Arc, Arc3, BMove, Move, and TMove statements. Correct the program.		
3135	Invalid parameter is specified.	Invalid parameter is specified in Xqt, and Call statements. Correct the program.		
3137	Cannot specify the array variable subscript.	The array variable subscript cannot be specified. Correct the program.		
3138	ByRef was not specified on Function declaration.	Specify ByRef in the parameter list of function declaration that is called by Call statement.		
3139	Cannot execute the Xqt statement for a function that needs a ByRef parameter.	The Xqt statement cannot be executed for a function needing a ByRef parameter. Delete the ByRef parameter.		
3140	Cannot execute the Redim statement for a ByRef variable.	The Redim statement cannot be executed for a variable specifying ByRef parameter. Delete the ByRef parameter.		
3141	OBJ file is corrupt.	-		
3142	OBJ file size is beyond the available size after compiling.	The compilation result exceeds the limit value (max. 1 MB per file). Divide the program.		
3143	Indent length is beyond the available size.	The available length of the identifier is max. 32 characters for labels and variable names, and 64 characters for function names. Reduce the number of characters so as not to exceed the available length. For details of the available length, refer to <i>EPSON RC+ User's Guide "6.4 Function and Variable Names (Naming restriction)"</i> .		
3144	'**' already used for a function name.	Correct the identifier '**' or the function name.		
3145	'**' already used for a Global Preserve variable.	Correct the identifier '**' or the Global Preserve variable name.		

No.	Message	Remedy	Note 1	Note 2
3146	'**' already used for a Global variable.	Correct the identifier '**' or the Global variable name.		
3147	'**' already used for a Module variable.	Correct the identifier '**' or the Module variable name.		
3148	'**' already used for a Local variable.	Correct the identifier '**' or the Local variable name.		
3149	'**' already used for an I/O label.	Correct the identifier '**' or the I/O label name.		
3150	'**' already used for a User Error label.	Correct the identifier '**' or the User Error label name.		
3151	Cannot use a function parameter.	Argument cannot be specified for the function that is executed by the Trap statement. Correct the program.		
3152	Specified elements of the array variable are beyond the available size.	Limit value of the array elements depends on the type of variables. Refer to <i>EPSON RC+7.0 User's Guide "6.7.6 Array"</i> and correct the number of array elements so as not to exceed the limit value.		
3153	Parameter type mismatch.	Parameter type does not match in Call, Force_GetForces, and Xqt statements. Correct the parameter type.		
3154	'**' is not an Input Bit label.	Specify a valid input bit label.		
3155	'**' is not an Input Byte label.	Specify a valid input byte label.		
3156	'**' is not an Input Word label.	Specify a valid input word label.		
3157	'**' is not an Output Bit label.	Specify a valid output bit label.		
3158	'**' is not an Output Byte label.	Specify a valid output byte label.		
3159	'**' is not an Output Word label.	Specify a valid output word label.		
3160	'**' is not a Memory Bit label.	Specify a valid memory I/O bit label.		
3161	'**' is not a Memory Byte label.	Specify a valid memory I/O byte label.		
3162	'**' is not a Memory Word label.	Specify a valid memory I/O word label.		
3163	Too many function arguments.	The maximum number of the function parameter is 100. Reduce the number of parameters.		
3164	Cannot compare with Boolean value.	The size of Boolean values cannot be compared. Correct the program.		
3165	Cannot use Boolean value in the expression.	Boolean value cannot be used in the expression. Correct the program.		
3166	Cannot compare between Boolean and expression.	The size of Boolean value and the expression cannot be compared. Correct the program.		
3167	Cannot store Boolean value to a numeric variable.	Boolean value cannot be used in the numeric variable. Correct the program.		
3168	Cannot store numeric value to a Boolean variable.	The numeric value cannot be used in Boolean variable. Correct the program.		
3169	Undefined I/O label was specified.	Define a new I/O label or specify the defined I/O label.		

No.	Message	Remedy	Note 1	Note 2
3170	Invalid condition expression was specified.	String expression is specified for the right side of the condition expression in Do or Loop statement. Correct the condition expression so that the right side of the expression is Boolean value.		
3171	Cannot compare between numeric value and string.	The numeric value and string cannot be compared. Correct the program.		
3172	Cannot use a keyword for a variable name.	Some SPEL+ keywords cannot be used as the variable names. Correct the variable name not to overlap with the keywords.		
3173	'**' is already used for a line label.	Correct the identifier '**' or the line label name.		
3174	Duplicate line number or label (**).	The line labels with the same name cannot be specified in the same function. Delete the line label '**', or define a new line label and correct the program.		
3175	Undefined Point label was specified.	Define a new point label or specify the defined point label.		
3176	An undefined variable was specified.	Define a new variable or specify the defined variable.		
3177	'**' already used for a Point label.	Correct the identifier '**' or the point label name.		
3178	Cannot use the result number.	The result number cannot be specified when a vision object that does not return multiple results is used in VSet and VGet statements. Correct the program.		
3179	String literal is beyond the available length.	The limit value of the string length is max. 255 characters. Reduce the string length so as not to exceed the limit value.		
3180	Cannot change a calibration property value with the VSet command.	Calibration property cannot be changed in VSet statement. Correct the program.		
3181	Array variable should be used with ByRef.	ByVal cannot be specified for the array variable. Specify the ByRef parameter.		
3182	Subscription was not specified.	Specify a subscription.		
3183	Parameter cannot be omitted.	Add a parameter.		
3184	SYNC parameter cannot use with tracking command.	SYNC parameter cannot be specified in tracking commands. Delete the SYNC parameter.		
3185	Cannot use Queue data.	Queue data cannot be specified in BGo, BMove, TGo, and TMove statements. Delete the queue data.		
3186	Combination between Queue and Point data does not match.	Combination of queue data and point data cannot be specified for coordinate specification of Arc, Arc3, Jump3, and Jump3CP statements. Use either queue data or the point data.		
3187	Invalid Point flag value was specified.	Correct the program so that the point flag value is within the range from 0 to 127.		

Maintenance 9. Troubleshooting

No.	Message	Remedy	Note 1	Note 2
3188	Call command cannot be used in parallel processing.	Call command cannot be used parallel processing. Correct the program.		
3189	Local variables cannot be used with the Wait command.	Change of local variable cannot be waited by Wait statement. Correct the program.		
3190	Array variables cannot be used with the Wait command.	Change of array variable cannot be waited by Wait statement. Correct the program.		
3191	Real variables cannot be used with the Wait command.	Change of real variable cannot be waited by Wait statement. Correct the program.		
3192	String variables cannot be used with the Wait command.	Change of string variable cannot be waited by Wait statement. Correct the program.		
3193	Vision object name is missing.	Vision object name cannot be omitted in VTeach statement. Specify the object name.		
3194	Cannot use Boolean value for the timeout value.	Boolean value cannot be used for the timeout value of Wait statement. Correct the program.		
3196	Fend statement was not found.	The number of Fend statements that correspond to Function statements is not enough. Add the Fend statements.		
3197	Numeric variable name cannot use '\$'.	Numeric variable name cannot use '\$'. Correct the variable name.		
3198	String variables must have '\$' suffix.	String variables must have a '\$' suffix. Add a '\$' suffix to the variable name.		
3199	Invalid object was specified.	Invalid vision object is specified in Vision Guide commands such as VSet and VGet. Specify the valid vision object.		
3200	Value is missing.	Add a value.		
3201	Expected ', '.	Add ', '.		
3202	Expected '('.	Add '('.		
3203	Expected ') '.	Add ') '.		
3204	Identifier is missing.	Specify an identifier.		
3205	Point is not specified.	Specify a point.		
3206	Event condition expression is missing.	Add an event condition expression.		
3207	Formula is missing.	Add a formula.		
3208	String formula is missing.	Add a string formula.		
3209	Point formula is missing.	Add a point formula.		
3210	Line label was not specified.	Check if the specified line label exists in the program. Add a valid line label.		
3211	Variable was not specified.	Specify a variable.		
3212	Corresponding Fend cannot be found.	The number of Fend statements that correspond to Function statements is not enough. Add the Fend statements.		
3213	Expected ': '.	Add ': '.		

No.	Message	Remedy	Note 1	Note 2
3214	True/False was not specified.	True/False was not specified in the property of Vision Guide/GUI Builder or substitution of logical expression which requires Boolean value setting. Specify True or False.		
3215	On/Off was not specified.	On or Off must be specified for the remote output logic setting of Motor, Brake, AutoLJM, SetSw, and Box statements. Specify On or Off.		
		Invalid PF_OutputOnOff command format used. Read the description for the corresponding command provided in <i>Part Feeding 7.0 Introduction & Hardware (Common) & Software Software 3. Part Feeding SPEL+ Command Reference</i> and correct the code.		
3216	High/Low was not specified.	High or Low must be specified for the power mode setting of Power statement. Specify High or Low.		
3217	Input bit label was not specified.	Input bit label is not specified in SetSW, CTRreset statement, Sw, and Ctr function. Specify a valid input bit label.		
3218	Input byte label was not specified.	Input byte label is not specified in SetIn statement, In, and InBCD function. Specify a valid input byte label.		
3219	Input word label was not specified.	Input word label is not specified in SetInW statement, InReal, and InW function. Specify a valid input word label.		
3220	Output bit label was not specified.	Output bit label is not specified in On, Off statement, and Oport function. Specify a valid output bit label.		
3221	Output byte label was not specified.	Output byte label is not specified in Out, OpBCD statement, and Out function. Specify a valid output byte label.		
3222	Output word label was not specified.	Output word label is not specified in OutW, OutReal statement, OutW, and OutReal function. Specify a valid output word label.		
3223	Memory bit label was not specified.	Memory bit label is not specified in MemOn, MemOff statement, and MemSw function. Specify a valid memory bit label.		
3224	Memory byte label was not specified.	Memory byte label is not specified in MemOut statement and MemIn function. Specify a valid memory byte label.		
3225	Memory word label was not specified.	Memory word label is not specified in MemOutW statement and MemInW function. Specify a valid memory word label.		

No.	Message	Remedy	Note 1	Note 2
3226	User error label was not specified.	User error label is not specified in Error statement. Specify a valid user error label.		
3227	Function name was not specified.	Function name is not specified in the statement that requires function name designation, such as Call and Xqt. Specify a valid function name.		
3228	Variable type was not specified.	Variable type is not specified for the parameter definition of Function statement and Preserve parameter specification of Global statement. Specify a correct variable type.		
3229	Invalid Trap statement parameter. Use Goto, Call, or Xqt.	Specify either GoTo, Call, or Xqt as a parameter of Trap statement.		
3230	Expected For/Do/Function.	Specify either For, Do, or Function as a parameter of Exit statement.		
3231	Above/Below was not specified.	Setting value for the elbow orientation is not specified in Elbow statement. Specify either Above or Below.		
3232	Righty/Lefty was not specified.	Setting value for the hand orientation is not specified in Hand statement. Specify either Righty or Lefty.		
3233	NoFlip/Flip was specified.	Setting value for the wrist orientation is not specified in Wrist statement. Specify either NoFilip or Flip.		
3234	Port number was not specified.	Port number that indicates the file or communication port is not specified in Read, ReadBin, Write, and WriteBin statements. Refer to <i>SPEL+ Language Reference "Read Statement"</i> and specify a proper file number or port number.		
3235	String type variable was not specified.	String type variable is not specified in the command that requires specification of string type variable as a parameter. Specify a valid string type variable.		
3236	RS-232C port number was not specified.	RS-232C port number is not specified in OpenCom, CloseCom, and SetCom statements. Refer to <i>SPEL+ Language Reference "OpenCom Statement"</i> and specify a proper port number.		
3237	Network communication port number was not specified.	Network communication port number is not specified in OpenNet, CloseNet, SetNet, and WaitNet statement. Specify an integer from 201 to 216.		
3238	Communication speed was not specified.	Communication speed (baud rate) is not specified in SetCom statement. Refer to <i>SPEL+ Language Reference "SetCom Statement"</i> and specify a proper baud rate.		
3239	Data bit number was not specified.	Data bit length is not specified in SetCom statement. Refer to <i>SPEL+ Language Reference "SetCom Statement"</i> and specify a proper data bit length.		

No.	Message	Remedy	Note 1	Note 2
3240	Stop bit number was not specified.	Stop bit length is not specified in SetCom statement. Refer to <i>SPEL+ Language Reference "SetCom Statement"</i> and specify a proper stop bit length.		
3241	Parity was not specified.	Parity is not specified in SetCom statement. Refer to <i>SPEL+ Language Reference "SetCom Statement"</i> and specify a proper parity.		
3242	Terminator was not specified.	Terminator (end of send/receive line) is not specified in SetCom and SetNet statements. Refer to <i>SPEL+ Language Reference "SetCom Statement"</i> and specify a proper terminator.		
3243	Hardware flow was not specified.	Hardware flow is not specified in SetCom statement. Refer to <i>SPEL+ Language Reference "SetCom Statement"</i> and specify a proper flow control.		
3244	Software flow was not specified.	Software flow is not specified in SetCom statement. Refer to <i>SPEL+ Language Reference "SetCom Statement"</i> and specify a proper flow control.		
3245	None was not specified.	"NONE" is not specified for software flow control setting in SetNet statement. Specify "NONE".		
3246	Parameter ' O ' or ' C ' was not specified.	Open or close parameter for the end of a curve is not specified in Curve statement. Refer to <i>SPEL+ Language Reference "Curve Statement"</i> and specify a proper open/close parameter.		
3247	NumAxes parameter was not specified.	The number of coordinate axes controlled during a curve motion is not specified in Curve statement. Refer to <i>SPEL+ Language Reference "Curve Statement"</i> and specify a proper number of the coordinate axes.		
3248	J4Flag value (0-1) was not specified.	Specify 0 or 1, or an expression for J4Flag value.		
3249	J6Flag value (0-127) was not specified.	Specify an integer from 0 to 127, or an expression for J6Flag value.		
3250	Array variable was not specified.	Array variable is not specified in the statement that requires specification of array variable. Specify a valid array variable.		
3251	String Array variable was not specified.	Array which stores a token must be a string array variable in ParseStr statement and ParseStr function. Specify a string array variable.		

No.	Message	Remedy	Note 1	Note 2
3252	Device ID was not specified.	Device ID is not specified in DispDev statement or CIs command. Refer to <i>SPEL+ Language Reference "DispDev Statement"</i> and specify a proper device ID.		
3253	I/O type was not specified.	I/O type is not specified in IOLabel\$ function. Refer to <i>SPEL+ Language Reference "IOLabel\$ Function"</i> and specify a proper I/O type.		
3254	I/O bit width was not specified.	I/O bit size (I/O port width) is not specified in IODef, IOLabe function. Refer to <i>SPEL+ Language Reference "IODef Function"</i> and specify a proper I/O bit size.		
3255	ByRef was not specified.	Although the ByRef is specified in the function declaration, no ByRef is specified for calling. Specify the ByRef parameter.		
3256	Variable type was not specified.	Variable type is not specified in Global statement. Specify a proper variable type.		
3257	Condition expression does not evaluate to Boolean value.	Condition expression in If, Elseif, Do, and Loop statement must return a Boolean value. Correct the condition expression to return a Boolean value.		
3258	RS232C port number was not specified.	RS-232C port number is not specified in ChkCom function. Refer to <i>SPEL+ Language Reference "ChkCom Function"</i> and specify a proper port number.		
3259	Network communication port number was not specified.	Network communication port number is not specified in ChkNet function. Refer to <i>SPEL+ Language Reference "ChkNet Function"</i> and specify a proper port number.		
3260	Language ID was not specified.	Language ID is not specified in ErrMsg\$ function. Refer to <i>SPEL+ Language Reference "ErrMsg\$ Function"</i> and specify a proper language ID.		
3261	Expected '.'.	Add '.'.		
3262	Vision Sequence Name was not specified.	Vision sequence name is not specified in Vision Guide commands such as VSet, VGet, and VRun. Add a sequence name.		
3263	Vision Sequence Name or Calibration Name was not specified.	Vision sequence name or calibration name is not specified in VSet and VGet statements. Add a sequence name or calibration name.		
3264	Vision Property Name or Result Name was not specified.	Vision property name or result name is not specified in VSet and VGet statements. Add a property name or result name.		

No.	Message	Remedy	Note 1	Note 2
3265	Vision Property Name, Result Name or Object Name was not specified.	Either of Vision property name, result name, or object name is not specified in VSet and VGet statements. Add either of a property name, result name, or object name.		
3266	Vision Calibration Property Name was not specified.	Vision calibration property name is not specified in VSet and VGet statements. Add a property name.		
3267	Task type was not specified.	Task type is not specified in Xqt statement. Refer to <i>SPEL+ Language Reference "Xqt Statement"</i> and specify a proper task type.		
3268	Form name was not specified.	Form name is not specified in GSet, GGet, GShow, GShowDialog, and GClose statements. Specify a form name.		
3269	Property Name or Control Name was not specified.	Property name or control name is not specified in GSet and GGet statements. Specify a property name or control name.		
3270	Property Name was not specified.	Property name is not specified in GSet and GGet statements. Specify a property name.		
3271	BackColorMode was not specified.	BackColorMode property setting value is not specified in GSet statement. Refer to <i>GUI Builder 7.0</i> manual " <i>BackColorMode Property</i> " and specify a proper setting value.		
3272	BorderStyle was not specified.	BorderStyle property setting value is not specified in GSet statement. Refer to <i>GUI Builder 7.0</i> manual " <i>BorderStyle Property</i> " and specify a proper setting value.		
3273	DropDownStyle was not specified.	DropDownStyle property setting value is not specified in GSet statement. Refer to <i>GUI Builder 7.0</i> manual " <i>DropDownStyle Property</i> " and specify a proper setting value.		
3274	EventTaskType was not specified.	EventTaskType property setting value is not specified in GSet statement. Refer to <i>GUI Builder 7.0</i> manual " <i>EventTaskType Property</i> " and specify a proper setting value.		
3275	ImageAlign was not specified.	ImageAlign property setting value is not specified in GSet statement. Refer to <i>GUI Builder 7.0</i> manual " <i>ImageAlign Property</i> " and specify a proper setting value.		
3276	IOType was not specified.	IOType property setting value is not specified in GSet statement. Refer to <i>GUI Builder 7.0</i> manual " <i>IOType Property</i> " and specify a proper setting value.		

No.	Message	Remedy	Note 1	Note 2
3277	FormBorderStyle was not specified.	FormBorderStyle property setting value is not specified in GSet statement. Refer to <i>GUI Builder 7.0</i> manual " <i>FormBorderStyle Property</i> " and specify a proper setting value.		
3278	ScrollBars was not specified.	ScrollBars property setting value is not specified in GSet statement. Refer to <i>GUI Builder 7.0</i> manual " <i>ScrollBars Property</i> " and specify a proper setting value.		
3279	SizeMode was not specified.	SizeMode property setting value is not specified in GSet statement. Refer to <i>GUI Builder 7.0</i> manual " <i>SizeMode Property</i> " and specify a proper setting value.		
3280	StartPosition was not specified.	StartPosition property setting value is not specified in GSet statement. Refer to <i>GUI Builder 7.0</i> manual " <i>StartPosition Property</i> " and specify a proper setting value.		
3281	TextAlign was not specified.	TextAlign property setting value is not specified in GSet statement. This error occurs when the control type cannot be identified because the control is specified by a string variable. Refer to <i>GUI Builder 7.0</i> manual " <i>TextAlign Property</i> " and specify a proper setting value.		
3282	TextAlign was not specified.	TextAlign property setting value is not specified in GSet statement. This error occurs when the control is a text box. Refer to <i>GUI Builder 7.0</i> manual " <i>TextAlign Property</i> " and specify a proper setting value.		
3283	TextAlign was not specified.	TextAlign property setting value is not specified in GSet statement. This error occurs when the control is other than a text box. Refer to <i>GUI Builder 7.0</i> manual " <i>TextAlign Property</i> " and specify a proper setting value.		
3284	WindowState was not specified.	WindowState property setting value is not specified in GSet statement. Refer to <i>GUI Builder 7.0</i> manual " <i>WindowState Property</i> " and specify a proper setting value.		
3285	J1FLAG was not specified.	Specify 0 or 1, or an expression for J1Flag value.		
3286	J2FLAG was not specified.	Specify 0 or 1, or an expression for J2Flag value.		
3287	Robot ID was not specified.	Specify a robot number.		
3288	Robot ID/All was not specified.	Robot number or All is not specified in InsideBox and InsidePlane function. Specify a robot number which performs intrusion detection, or All.		

No.	Message	Remedy	Note 1	Note 2
3289	Area ID was not specified.	Area number is not specified in InsideBox and InsidePlane function. Specify an approach check area number which returns status by an integer from 1 to 15.		
3290	File number was not specified.	File number is not specified in the command related to file management. Specify a file number by an integer from 30 to 63 or an expression.		
3292	Database type was not specified.	Database type is not specified in OpenDB statement. Refer to <i>SPEL+ Language Reference "OpenDB Statement"</i> and specify a proper database type.		
3293	Disk type was not specified.	Type of the disk that is subject to file manipulation is not specified in ChDisk statement. Refer to <i>SPEL+ Language Reference "ChDisk Statement"</i> and specify a proper disk type.		
3295	Conveyor area ID was not specified.	Area ID that is subject to count the queue data is not specified in Cnv_QueLen function. Refer to <i>SPEL+ Language Reference "Cnv_QueLen Function"</i> and specify a proper area ID.		
3296	Database file number was not specified.	Data base number that is subject to operation is not specified in OpenDB, CloseDB, DeleteDB, UpdateDB, and SelectDB function. Refer to <i>SPEL+ Language Reference "OpenDB Statement"</i> and specify a proper database number.		
3297	Vision calibration name was not specified.	Calibration name is not specified in VCal statement. Specify a name of calibration that is subject to calibrate.		
3298	Vision object type ID was not specified.	Vision object type is not specified in VCreateObject statement. Refer to <i>Vision Guide 7.0 Properties & Results Reference "VCreateObject Statement"</i> and specify a proper object type.		
3299	Shutdown mode ID was not specified.	Shutdown mode value is not specified in ShutDown statement and ShutDown function. Refer to <i>SPEL+ Language Reference "Shutdown Statement"</i> and specify a proper mode value.		
3301	Version of linked OBJ file does not match.	Not all project files are compiled in the same version. Rebuild the project.		
3302	Linked OBJ file does not match the compiled I/O label.	The project configuration has been changed. Rebuild the project.		
3303	Linked OBJ file does not match the compiled user error label.	The project configuration has been changed. Rebuild the project.		

No.	Message	Remedy	Note 1	Note 2
3304	Linked OBJ file does not match the compiled compile option.	The project configuration has been changed. Rebuild the project.		
3305	Linked OBJ file does not match the compiled link option.	The project configuration has been changed. Rebuild the project.		
3306	Linked OBJ file does not match the compiled SPEL option.	The project configuration has been changed. Rebuild the project.		
3307	Duplicate function.	The same function name is used for more than one file. Correct the program (function name).		
3308	Duplicate global preserve variable.	The same global preserve variable name is used for more than one file. Correct the program (variable name).		
3309	Duplicate global variable.	The same global variable name is used for more than one file. Correct the program (variable name).		
3310	Duplicate module variable.	The same module variable name is used for more than one file. Correct the program (variable name).		
3311	File cannot be found.	-		
3312	OBJ file is corrupt.	-		
3313	The specified file name includes character(s) that cannot be used.	-		
3314	Cannot open the file.	The file is used for other application. Quit the other application.		
3315	'**' is already used for a function name.	Correct the identifier '**' or the function name. Rebuild the project.		
3316	'**' is already used for a global preserve variable name.	Correct the identifier '**' or the global preserve variable name. Rebuild the project.		
3317	'**' is already used for a global variable name.	Correct the identifier '**' or the global variable name. Rebuild the project.		
3318	'**' is already used for a module variable name.	Correct the identifier '**' or the module variable name. Rebuild the project.		
3319	Dimension of the array variable does not match the declaration.	Correct the dimension of the array and rebuild the project.		
3320	Return value type of the function does not match the declaration.	Correct the return value type of the function and rebuild the project.		
3321	'**' is already used with function name.	Correct the identifier '**' or the function name. Rebuild the project.		
3322	'**' is already used with Global Preserve name.	Correct the identifier '**' or the global preserve variable name. Rebuild the project.		
3323	'**' is already used with Global name.	Correct the identifier '**' or the global variable name. Rebuild the project.		
3324	'**' is already used with Module name.	Correct the identifier '**' or the module variable name. Rebuild the project.		
3325	'**' is already used with Local name.	Correct the identifier '**' or the local variable name. Rebuild the project.		
3326	The number of parameters does not match the declaration.	Check the number of parameters in the function, correct the program, and then rebuild the project.		

No.	Message	Remedy	Note 1	Note 2
3327	ByRef was not specified in Function declaration for parameter **.	-		
3328	ByRef was not specified for parameter **.	-		
3329	Parameter ** type mismatch.	-		
3330	Linked OBJ file does not match the compiled Vision Project.	Rebuild the project.		
3331	OBJ file size is beyond the available size after linking.	The OBJ file size exceeds the limit value (8MB). Reduce the program.		
3332	Variable '***' is redefined.	Variable ' ** ' is overloaded. Delete unnecessary variable definition and rebuild the project.		
3333	Linked OBJ file does not match the compiled GUI Builder Project.	Rebuild the project.		
3334	The number of variables which is using Wait command is beyond the maximum allowed.	The number of variables which is using Wait command is exceeding the maximum allowed (64). Delete the variables and rebuild the project.		
3335	Call cannot be used in parallel processing.	Call cannot be used in parallel processing. Correct the program and rebuild the project.		
3336	Variable was redefined.	Correct the data type of the variable and rebuild the project.		
3351	Invalid object index was specified.			
3352	Force Guide Sequence Name was not specified.			
3353	Force Guide Property Name or Result Name was not specified.			
3354	Force Guide Property Name, Result Name or Object Name was not specified.			
3355	Force Guide project file has unsupported file format.			
3356	Linked OBJ file does not match the compiled Force Guide Project.			
3400	Dialog ID was not specified.	Dialog ID is not specified in RunDialog statement. Refer to <i>SPEL+ Language Reference "RunDialog Statement"</i> and specify a dialog ID.		
3401	Main function name was not specified.	Name of the main function to execute is not specified in StartMain statement. Specify a main function name (main to main63).		
3402	Vision object name was not specified.	Vision object name is not specified in VLoadModel, VSaveModel, VShowModel, VTeach, and VTrain statements. Specify an object name.		
3403	Recover mode ID was not specified.	Recover mode is not specified in Recover statement or Recover function. Refer to <i>SPEL+ Language Reference "Recover Statement"</i> and specify a proper mode.		

No.	Message	Remedy	Note 1	Note 2
3404	Trap condition was not specified.	Trap number or trap event is not specified in Trap statement. Refer to <i>SPEL+ Language Reference "Trap Statement"</i> and specify a proper trap number or event.		
3405	DialogResult was not specified.	DialogResult property setting value is not specified in GSet statement. Refer to <i>GUI Builder 7.0 "DialogResult Property"</i> and specify a proper setting value.		
3406	MsgBox_Type was not specified.	Display type is not specified in MsgBox statement. Refer to <i>SPEL+ Language Reference "MsgBox Statement"</i> and specify a proper setting value.		
3407	Byte type array variable was not specified.	Byte type array variable is not specified for send or receive data in FbusIO_SendMsg statement. Send/receive data must be specified by Byte type array.		
3408	Single array variable was not specified.	The number of dimensions is not proper in the command where single array variable is only available. Correct the number of dimensions.		
3409	Point list is not specified.	Pixel coordinate or robot coordinate is not specified as a continuous point data in VxCalib statement. Specify a continuous point data in the following format: P (start : end)		
3410	Code type is not specified.	CodeType property setting value is not specified in VSet statement. Refer to <i>Vision Guide 7.0 Properties & Results Reference "CodeType Property"</i> and specify a proper setting value.		
3411	Edge type is not specified.	EdgeType property setting value is not specified in VSet statement. Refer to <i>Vision Guide 7.0 Properties & Results Reference "EdgeType Property"</i> and specify a proper setting value.		
3412	ECC type is not specified.	ErrorCorrection property setting value is not specified in VSet statement. This error is for the old RC+6.x. Setting of the old version is possible by compiler version setting. Refer to <i>Vision Guide 6.0 Properties & Results Reference "ErrorCorrection Property"</i> and specify a proper setting value.		
3413	ImageColor type is not specified.	ImageColor property setting value is not specified in VSet statement. Refer to <i>Vision Guide 7.0 Properties & Results Reference "ImageColor Property"</i> and specify a proper setting value.		

No.	Message	Remedy	Note 1	Note 2
3414	Point type is not specified.	PointType property setting value is not specified in VSet statement. Refer to <i>Vision Guide 7.0 Properties & Results Reference</i> "PointType Property" and specify a proper setting value.		
3415	Reference type is not specified.	ReferenceType property setting value is not specified in VSet statement. Refer to <i>Vision Guide 7.0 Properties & Results Reference</i> "ReferenceType Property" and specify a proper setting value.		
3416	Edge type is not specified.	Logic (edge type) of the trigger input is not specified in SetLatch statement. Specify either 0 (negative logic) or 1 (positive logic).		
3417	Port number is not specified.	R-I/O input port number where the trigger input is connected is not specified in SetLatch statement. Refer to <i>SPEL+ Language Reference</i> "SetLatch Statement" and specify a proper port number.		
3418	Axis is not specified.	Axis parameter is not specified in Force_GetForce function or Force_SetTrigger statement. Refer to <i>SPEL+ Language Reference</i> "Force_GetForce Function" and specify a proper setting value.		
3419	CompareType is not specified.	ComapreType parameter to set judgment condition is not specified in Force_SetTrigger statement. Refer to <i>SPEL+ Language Reference</i> "Force_SetTrigger Statement" and specify a proper parameter.		
3420	Integer or Short type array variable is only available.	-		
3421	Form name or window ID is not specified.	Form name or system window ID which is subject to operation is not specified in GShow and GClose statements. Specify a valid form name or window ID. For details of window ID, refer to <i>GUI Builder7.0 manual</i> "GShow Statement".		
3422	Window ID is not specified.	System window ID which is subject to operation is not specified in GShow and GClose statements. Refer to <i>GUI Builder7.0 manual</i> "GShow Statement" and specify a proper window ID.		
3423	Performance mode ID was not specified.	Performance mode is not specified in PerformMode parameter of PerformMode statement, Go, BGo, TGo, Jump statement. Refer to <i>SPEL+ Language Reference</i> "PerformMode" and specify a proper performance mode.		

No.	Message	Remedy	Note 1	Note 2
3424	Protocol type was not specified.	Communication protocol setting is not specified in SetNet statement. Specify UDP or TCP.		
3425	I/O type or I/O label was not specified.	I/O type or I/O label is not specified in IODef function. Specify the I/O label or I/O type to check existence of definition. For details of I/O types, refer to <i>SPEL+ Language Reference "IODef Function"</i> .		
3426	Singularity avoidance mode was not specified.	Singularity avoidance mode is not specified in AvoidSingularity statement. Refer to <i>SPEL+ Language Reference "AvoidSingularity Statement"</i> and specify a proper mode.		
3427	Acceleration value was not specified.	Setting number of acceleration is not specified in AccelR function. Refer to <i>SPEL+ Language Reference "AccelR Function"</i> and specify a proper setting value.		
3428	Acceleration value was not specified.	Setting number of acceleration is not specified in Accel function, AccelMax function, AccelS function, and RealAccel function. Refer to <i>SPEL+ Language Reference "Accel Function"</i> and specify a proper number.		
3429	Sorting order for work queue data was not specified.	Sorting order for work queue data is not specified in WorkQue_Sort statement. Refer to <i>SPEL+ Language Reference "WorkQue_Sort Statement"</i> and specify a proper sorting order.		
3430	Coordinate axes number was not specified.	-		
3431	Coordinate axes number was not specified.	-		
3432	Point or point expression is not specified. Review the program.	Reboot the controller. Initialize the controller firmware. Replace the controller.		
3433	Boolean type array variable was not specified. Specify a Boolean type array variable.	Array which stores a value of Enabled or LPF_Enabled property must be a Boolean type array variable in FGet statement. Specify a Boolean array variable.		
3434	Real or Double type array variable was not specified. Specify a Real or Double type array variable.	Real or Double type array variable is not specified in FGet or MPGet statement. Specify a real or double type array variable.		
3435	Integral type array variable was not specified. Specify an Integral type array variable.	Array which stores a value of Polarities property must be an Integral type array variable in FGet statement. Specify an integral type array variable.		

No.	Message	Remedy	Note 1	Note 2
3436	Duration of FCKeep statement is not specified. Specify the duration.	Duration of force control (timeout value) is not specified in FCKeep statement. Specify a proper setting value.		
3437	Part kind of controller was not specified.	Specify the controller part type.		
3438	Part kind of robot was not specified.	Specify the robot part type.		
3439	Part kind of robot was not specified.	Specify the robot part type.		
3440	A value other than numerical value is specified for the parameter of the command. Specify a numerical value.	Specify a numerical value for AIO_TrackingSet command 7th parameter.		
3441	A value other than numerical value is specified for the parameter of the command. Specify a numerical value.	Specify a numerical value for AIO_TrackingSet command 6th parameter.		
3450	Force property name or status name is not specified. Add a property name or a status name.	Force property name or status name is not specified in FSet, FGet, MPSet, and MPGet statements. Add a property name or a status name.		
3451	Force property name, status name, or object name is not specified. Add either of a property name, status name, or object name.	Either of Force property name, status name, or object name is not specified in FSet, FGet, MPSet, and MPGet statements. Add either of a property name, status name, or object name.		
3452	Force object name is not specified. Add a force object name.	Reboot the controller. Initialize the controller firmware. Replace the controller.		
3453	Mass Property Object is not specified. Specify a Mass Property Object.	Specify a valid Mass Property object.		
3454	Force Coordinate System Object is not specified. Specify a Force Coordinate System Object.	Specify a valid Force Coordinate System object.		
3455	Force Control Object is not specified. Specify a Force Control Object.	Specify a valid Force Control object.		
3456	Force Monitor Object is not specified. Specify a Force Monitor Object.	Specify a valid Force Monitor object.		
3457	Force Trigger Object is not specified. Specify a Force Trigger Object.	Specify a valid Force Trigger object.		
3458	Force Control Object or Force Coordinate System Object is not specified. Specify a Force Control Object or Force Coordinate System Object.	Force Control data or Force Coordinate System data is not specified in FCSMove statement. Specify a valid Force Control object or Force Coordinate System object.		
3459	Force object is not specified.	Specify a Force object.		
3460	Force object label is not specified.	Specify a Force object label.		
3461	Force object or label is not specified.	Specify a Force object or label.		

Maintenance 9. Troubleshooting

No.	Message	Remedy	Note 1	Note 2
3462	Force Coordinate System Object or label is not specified. Specify a Force Coordinate System Object or label.	Specify a valid Force Coordinate System object or label.		
3463	Force Control Object or label is not specified. Specify a Force Control Object or label.	Specify a valid Force Control object or label.		
3464	Force Monitor Object or label is not specified. Specify a Force Monitor Object or label.	Specify a valid Force Monitor object or label.		
3465	Force Trigger Object or label is not specified. Specify a Force Trigger Object or label.	Specify a valid Force Trigger object or label.		
3466	Mass Property Object or label is not specified. Specify a Mass Property Object or label.	Specify a valid Mass Property object or label.		
3467	Force Coordinate System Object or label is not specified. Specify a Force Coordinate System Object or label.	Specify a valid Force Coordinate System object or label.		
3468	Force Control Object label is not specified. Specify a Force Control Object label.	Specify a valid Force Control object label.		
3469	Force Monitor Object label is not specified. Specify a Force Monitor Object label.	Specify a valid Force Monitor object label.		
3470	Force Trigger Object label is not specified. Specify a Force Trigger Object label.	Specify a valid Force Trigger object label.		
3471	Force Sensor Object label is not specified. Specify a Force Sensor Object label.	Specify a valid Force Sensor object label.		
3472	Mass Property Object label is not specified. Specify a Mass Property Object label.	Specify a valid Mass Property object label.		
3473	Mass Property Object label is not specified. Specify a Mass Property Object label.	Specify a valid Mass Property object label.		
3474	Fmag_Axes or Tmag_Axes property setting value is not specified. Specify a proper setting value.	Fmag_Axes or Tmag_Axes property setting value is not specified in FSet statement. Refer to "Fmag_Axes property" or "Tmag_Axes property" and specify a proper setting value.		

No.	Message	Remedy	Note 1	Note 2
3475	TriggerMode property setting value is not specified. Specify a proper setting value.	TriggerMode property setting value is not specified in FSet statement. Refer to "TriggerMode property" and specify a proper setting value.		
3476	Operator property setting value is not specified. Specify a proper setting value.	Operator property setting value is not specified in FSet statement. Refer to "Operator property" and specify a proper setting value.		
3477	Orientation property setting value is not specified. Specify a proper setting value.	Orientation property setting value is not specified in FSet statement. Refer to "Orientation property" and specify a proper setting value.		
3478	Polarity property setting value is not specified. Specify a proper setting value.	Fmag_Polarity, Fx_Polarity, Fy_Polarity, Fz_Polarity, Tmag_Polarity, Tx_Polarity, Ty_Polarity, and Tz_Polarity property setting value is not specified in FSet statement. Specify a proper setting value.		
3500	Duplicate macro in #define statement.	Another macro with the same name has been defined. Change the macro name.		
3501	Macro name was not specified.	Macro name is not specified in #define, #ifdef, #ifndef, and #undef statements. Add a macro name.		
3502	Include file name cannot be found.	Include file name is not specified in #include statement. Add a valid include file name.		
3503	Specified include file is not in the project.	The include file that is not registered in the project configuration is specified. Add the include file to the project configuration.		
3504	Parameter of the macro function does not match the declaration.	Check the number of parameters and correct the macro function.		
3505	Macro has a circular reference.	The macro has a circular reference. Correct the circular reference.		
3506	#define, #ifdef, #ifndef, #else, #endif, #undef and variable declaration statements are only valid in an include file.	Check and correct the content of include file.		
3507	Over #ifdef or #ifndef nesting level.	Limit of the nesting levels is 7 at the maximum. Correct the program so as not to exceed the limit value.		
3508	Cannot find corresponding #ifdef or #ifndef.	The number of #endif statements that correspond to #ifdef and #ifndef statements is too many. Delete #endif statements or add the #ifdef and #ifndef statements.		
3509	No #endif found for #ifdef or #ifndef.	The number of #endif statements that correspond to #ifdef and #ifndef statements is not enough. Add the #endif statements.		
3510	Cannot obtain the macro buffer.	-		
3550	Parameter for the macro function was not specified.	The macro declared as a macro function is called without argument. Correct the program.		

Maintenance 9. Troubleshooting

No.	Message	Remedy	Note 1	Note 2
3600	Tracking motion command cannot use Sense parameter.	When the queue data is specified in Jump, Jump3, and Jump3CP statements, Sense parameter cannot be specified. Delete the Sense statement.		
3601	Parameter type is mismatch for the external function ' ** '. Check all statements where this function is called in this file.	LJM parameter cannot be specified in BGo, TGo, Arc, Arc3, BMove, Move, and TMove statements. Delete the LJM parameter.		
3602	The specified motion command cannot use LJM parameter.	InReal function cannot be used with Wait statement. Correct the program.		
3603	InReal function cannot be used with Wait statement.	PerformMode parameter cannot be specified in Jump3, Jump3CP, Arc, Arc3, BMove, Move, and TMove statements. Delete the PerformMode parameter.		
3605	The specified motion command cannot use PerformMode parameter.	LJM parameter cannot be specified in BGo, TGo, Arc, Arc3, BMove, Move, and TMove statements. Delete the LJM parameter.		
3606	Cannot use the index.	Index number cannot be specified except List property in GSet and GGet statements. Correct the program.		
3607	Invalid object index was specified.	Invalid index is specified in Objects property of VSet and VGet statements. The index must be larger than 1 and smaller than the number of objects in the specified sequence. Specify a proper index.		
3608	Invalid control index was specified.	Invalid index is specified in Controls property of GSet and GGet statements. The index must be larger than 1 and smaller than the number of controls in the specified form. Specify a proper index.		
3609	Modifier parameters are duplicated. Review the program.	Force Guide data or CF parameter is duplicated in CVMove, FCKeep or other statement for robot motion. Correct the program.		
3610	Cannot use a keyword for a label name.	Keywords such as a command or a function are used for a label name. Change the label name which does not use these keywords.		
3733	Vision Sequence Name or Calibration Name was not specified.	Vision sequence name or calibration name is not specified in VSet and VGet statements. Add a sequence name or calibration name.		
3800	Compile process aborted.	-		
3801	Link process aborted.	-		
3802	Compile process aborted. Compile errors reached the maximum count.	Correct the error in the program and rebuild the project.		
3803	Link process aborted. Link errors reached the maximum count.	Correct the error in the program and rebuild the project.		

No.	Message	Remedy	Note 1	Note 2
3804	Specified command cannot be executed from the Command window.	Declaration of variables and functions, program control statement, preprocessor commands, and some commands cannot be executed from the command window. For details, refer to <i>SPEL+ Language Reference "Appendix A :SPEL+ Command Use Condition List"</i> .		
3805	Specified command can only be executed from the Command window.	Brake, SysConfig, Where, Cnv_QueueList, and WorlQue_List statements can only be executed from the command window. Delete these statements from the program.		
3806	Specified function cannot be executed from the Command window.	LogIn function cannot be executed from the command window even when used with Print statement. Use the function in the program.		
3808	Specified syntax cannot be used in the current version.	LJM and PerformMode parameters of motion commands may not be specified depending on the compiler version. LJM parameter: 6.0.x.x or later PerformMode parameter: 7.0.4.x or later Check the compiler version from the project property.		
3809	Module variables cannot be used in the command window.	Module variable cannot be accessed from the command window. Check the input command.		
3812	Specified function cannot be used with a Remote User Output.	Functions for condition expression of the user defined remote output are limited. Refer to <i>EPSON RC+7.0 User's Guide "11.8 User-defined Remote Output I/O"</i> and specify a valid function.		
3813	User defined label, function and variable cannot be used with a Remote User Output.	User defined label, function and variable cannot be used with condition expression of the user-defined remote output. Correct the condition expression.		
3814	Object code size is beyond the available size.	A combination of multiple statements is exceeding the available size of the intermediate code which can be executed at once (1024 bytes). Divide the statements.		
3815	Parameter cannot be specified for property or status in the command window. Delete the parameter and execute again.	When executing FGet or MPGet statement from a command window, a parameter cannot be specified to a property or status. Delete the parameter and execute again.		
3850	File not found.	-		
3851	Point file not found.	Failed to read the point file which configures the project. Check the project folder if the file exists.		

Maintenance 9. Troubleshooting

No.	Message	Remedy	Note 1	Note 2
3852	I/O label file not found.	Failed to read the I/O label file which configures the project. Check the project folder if the file exists.		
3853	User error label file not found.	Failed to read the user error label file which configures the project. Check the project folder if the file exists.		
3854	Force file does not exist. Check the project folder if the file exists.	Failed to read the force file which configures the project. Check the project folder if the file exists.		
3860	I/O label file not supported format.	Regenerate the I/O label file.		
3861	User error label file has unsupported file format.	Regenerate the user error file.		
3862	Point file has unsupported file format.	Regenerate the point file.		
3863	Vision project file has unsupported file format.	Regenerate the vision sequence.		
3864	GUI Builder project file has unsupported file format.	Regenerate the GUI Builder form.		
3865	OBJ file not supported format.	Rebuild the project.		
3866	Force file has unsupported file format. Re-create the force file.	Regenerate the force file.		
3870	Cannot specify Mass Property Object. Review the program.	Mass Property object cannot be specified in FSet, FGet, FDel, and FList statements, FDef, and FLabel\$ functions. Correct the program.		
3871	Cannot specify Force Coordinate System Object. Review the program.	Force coordinate system object cannot be specified in Go, BGo, TGo, Jump, Jump3, Mode, BMove, TMove, Arc, Arc3 statement, MPSet, MPGet, MPDel, MPList statement, and MPDef, MPLabel\$ function. Correct the program.		
3872	Cannot specify Force Control Object. Review the program.	Force control object cannot be specified in Go, BGo, TGo, Jump, Jump3 statement, and MPSet, MPGet, MPDel, MPList statement, and MPDef, MPLabel\$ function. Correct the program.		
3873	Cannot specify Force Monitor Object. Review the program.	Force monitor object cannot be specified in MPSet, MPGet, MPDel, MPList statement, and MPDef, MPLable\$ function. Correct the program.		
3874	Cannot specify Force Trigger Object. Review the program.	Force trigger object cannot be specified in MPSet, MPGet, MPDel, MPList statement, and MPDef, MPLable\$ function. Correct the program.		
3875	Cannot specify Force Sensor object. Review the program.	Force Sensor object cannot be specified in FDel, FList statement, FDef, FLabel\$ function, MPSet, MPGet, MPDel, MPList statement, and MPDef, MPLabel\$ function. Correct the program.		

No.	Message	Remedy	Note 1	Note 2
3876	Cannot specify Robot object. Review the program.	Robot object cannot be specified in FDel, FList statement, FDef, FLabel\$ function, MPSet, MPGet, MPDel, MPList statement, and MPDef, MPLabel\$ function. Correct the program.		
3877	Cannot specify Force Control Object and Force Coordinate System Object at the same time. Review the program.	Force control object and Force coordinate system object cannot be specified at the same time in FCSMove statement. Correct the program.		
3878	Cannot specify CF parameter. Delete the CF parameter.	CF parameter cannot be specified in Go, BGo, TGo, Jump, Jump3. Delete the CF parameter.		
3879	Cannot specify Mass Property Object label. Review the program.	Mass property object label cannot be specified in MPDel, and MPList statements. Correct the program.		
3880	Cannot specify Force Coordinate System Object label. Review the program.	Force coordinate system object label cannot be specified in FDel and FList statements. Correct the program.		
3881	Cannot specify Force Control Object label. Review the program.	Force control object label cannot be specified in FDel and FList statements. Correct the program.		
3882	Cannot specify Force Monitor Object label. Review the program.	Force monitor object label cannot be specified in FDel and FList statements. Correct the program.		
3883	Cannot specify Force Trigger Object label. Review the program.	Force trigger object label cannot be specified in FDel and FList statements. Correct the program.		
3884	Cannot specify Force Sensor Object label. Review the program.	Reboot the controller. Initialize the controller firmware. Replace the controller.		
3885	Cannot specify Mass Property Object number. Review the program.	Mass property object number cannot be specified in MPNumber function. Correct the program.		
3886	Cannot specify Force Coordinate System Object number. Review the program.	Force coordinate system object number cannot be specified in FNumber function. Correct the program.		
3887	Cannot specify Force Control Object number. Review the program.	Force control object number cannot be specified in FNumber function. Correct the program.		
3888	Cannot specify Force Monitor Object number. Review the program.	Force monitor object number cannot be specified in FNumber function. Correct the program.		
3889	Cannot specify Force Trigger Object number. Review the program.	Force trigger object number cannot be specified in FNumber function. Correct the program.		
3890	Cannot specify Force Sensor Object number. Review the program.	-		

Maintenance 9. Troubleshooting

No.	Message	Remedy	Note 1	Note 2
3891	Type of the specified two objects does not match. Specify the same type of the objects.	The data type of the first and the second parameter does not match in FDel, FList, MPDel, MPList statements. Correct the program.		
3900	Cannot obtain the internal communication buffer.	-		
3901	Buffer size is not enough.	-		
3910	Undefined command was specified.	-		
3911	Cannot enter the file name in the file name buffer.	-		
3912	Cannot obtain the internal buffer.	-		
3913	Cannot set priority.	Reboot the controller.		
3914	Invalid ICode.	Rebuild the project.		
3915	Invalid ICode.	Rebuild the project.		
3916	Invalid ICode.	Rebuild the project.		
3917	Invalid ICode.	Rebuild the project.		
3918	Invalid ICode.	Rebuild the project.		
3919	Invalid ICode.	Rebuild the project.		
3920	Invalid ICode.	Rebuild the project.		
3921	Invalid ICode.	Rebuild the project.		
3930	VDefTool Type ID is not specified.	Specify a numerical value for VDefTool command 2nd parameter.		
3931	VDefArm Type ID is not specified.	Specify a numerical value for VDefArm command 2nd parameter.		
3932	VDefArm ArmSetMode is not specified.	Specify a numerical value for VDefArm command 3rd parameter.		
3933	VDefLocal Type ID is not specified.	Specify a numerical value for VDefLocal command 2nd parameter.		
3934	VDefLocal CalibPlate Type ID is not specified.	Specify a numerical value for VDefLocal command 3rd parameter.		
3940	LatchPos Type ID is not specified.	Specify a numerical value for LatchPos command 1st parameter.		
3960	Neither Robot, Object nor ResetCollision were specified.			
3961	Neither Hand nor Property were specified.			
3962	Invalid Property was specified.			
3963	Neither Robot nor Object were specified.			
3964	Invalid Object was specified.			
3965	Invalid Object index was specified.			
3990	Analog I/O TCPSpeed Type is not specified.	Specify a numerical value for AIO_Set command 3rd parameter.		

No.	Message	Remedy	Note 1	Note 2
4001	Arm reached the limit of motion range.	Check the point to move, current point, and Range setting.		
4002	Specified value is out of allowable range.	Review the setting parameters.		The parameter causing the error
4003	Motion device driver failure. Communication error within the motion control module.	Reboot the controller. Initialize the controller firmware. Replace the controller.		
4004	Motion device driver failure. Event waiting error within the motion control module.	Reboot the controller. Initialize the controller firmware. Replace the controller.		
4005	Current point position is above the specified LimZ value.	Lower the Z axis. Increase the specified LimZ value.		
4006	Target point position is above the specified LimZ value.	Lower the Z coordinate position of the target point. Increase the specified LimZ value.		
4007	Coordinates conversion error. The end/mid point is out of the motion area. Jogging to the outside of the motion area.	Check whether the coordinate out of the motion range is not specified.		
4008	Current point position or specified LimZ value is out of motion range.	Change the specified LimZ value.		
4009	Motion device driver failure. Timeout error within motion control module.	Reboot the controller. Initialize the controller firmware. Replace the controller.		
4010	Specified Local coordinate was not defined.	Define the Local coordinate system.		Local number
4011	Arm reached the limit of XY motion range specified by XYLim statement.	Check the area limited by the XYLim statement.		
4012	Upper limit value of Box is smaller than the lower limit value. Change the upper and lower limit values.	Set the upper limit value to be larger than the lower limit value.		
4013	Motion control module internal calculation error.	Calculation of the timing of Arch motion failed. Perform either of the following: - Check and modify Arch parameter - Disable Arch		
4014	MCAL was not completed.	Execute MCal. Make sure the MCOdr is set for the joint connected to the PG board.		
4016	SFree statement was attempted for prohibited joint(s).	Due to robot mechanistic limitation, setting some joint(s) to servo free status is prohibited. Check the robot specifications.		
4018	Communication error within the motion control module. Check sum error.	Reboot the controller. Initialize the controller firmware. Replace the controller.		
4021	Point positions used to define the Local are too close.	Set the distance between points more than 1 μ m.		
4022	Point coordinate data used to define the Local is invalid.	Match the coordinate data for the points to be specified.		
4023	Cannot execute when the motor is in the off state.	Turn the motor power ON and then execute.		

Maintenance 9. Troubleshooting

No.	Message	Remedy	Note 1	Note 2
4024	Cannot complete the arm positioning using the current Fine specification.	Check whether the robot does not generate vibration or all parts and screws are secured firmly. Increase the Fine setting value.		
4025	Cannot execute a motion command during emergency stop condition.	Clear the emergency stop condition and execute the motion command.		
4026	Communication error within the motion control module. Servo I/F failure.	Reboot the controller. Initialize the controller firmware. Replace the controller.		
4028	Communication error within the motion control module. Device driver status failure.	Reboot the controller. Initialize the controller firmware. Replace the controller.		
4030	Buffer for the average torque calculation has overflowed. Shorten the time interval from Atclr to Atrq.	Shorten the time interval from Atclr to Atrq less than about two minutes.		
4031	Cannot execute a motion command when the motor is in the off state.	Turn the motor power ON and then execute the motion command.		
4032	Cannot execute a motion command when one or more joints are in SFree state.	Set all joints to the SLock state and execute the motion command.		
4033	The specified command is not supported for Pulse Generator Board joints.	The specified command is not permitted for the joints with PG board.		
4034	Specified command is not supported for this robot model.	Remove the unsupported command from the program.		
4035	Only the tool orientation was attempted to be changed by the CP statement.	Set a move distance between points. Use the ROT modifier, SpeedR statement, and AccelR statement.		
4036	Rotation speed of tool orientation by the CP statement is too fast.	Decrease the setting values for the SpeedS and AccelS statements. Use the ROT modifier, SpeedR statement, and AccelR statement.		
4037	The point attribute of the current and target point positions differ for executing a CP control command.	Match the point attribute.		
4038	Two point positions are too close to execute the Arc statement.	Set the distance between points more than 1 μ m.		
4039	Three point positions specified by the Arc statement are on a straight line.	Use the Move statement.		
4041	Motion command was attempted to the prohibited area at the backside of the robot.	Check the robot motion range.		
4042	Motion device driver failure. Cannot detect the circular format interruption.	Reboot the controller. Initialize the controller firmware. Replace the controller.		
4043	Specified command is not supported for this robot model or this joint type.	Remove the unsupported command from the program.		
4044	Curve failure. Specified curve form is not supported.	Create a Curve file again with the Curve statement.		

No.	Message	Remedy	Note 1	Note 2
4045	Curve failure. Specified mode is not supported.	Specify the Curve mode properly. Create a Curve file again with the Curve statement.		
4046	Curve failure. Specified coordinate number is out of the allowable range.	The number of the available coordinate axes is 2, 3, 4, and 6. Create a Curve file again with the Curve statement.		
4047	Curve failure. Point data was not specified.	Create a Curve file again with the Curve statement.		
4048	Curve failure. Parallel process was specified before the point designation.	Create a Curve file again with the Curve statement.		
4049	Curve failure. Number of parallel processes is out of the allowable range.	Create a Curve file again with the Curve statement.		
4050	Curve failure. Number of points is out of the allowable range.	The number of available point numbers differs according to the curve form. Check the number of points again.		
4051	Curve failure. Local attribute and the point attribute of all specified points do not match.	Match the local and point flag for all the specified points.		
4052	Curve failure. Not enough memory to format the curve file.	Reboot the controller.		
4053	Curve failure. Failed to format the curve file.	Review the point data. Check whether adjacent two points do not overlap on the specified point line.		
4054	Curve failure. Curve file error	The Curve file is broken. Create a Curve file again with the Curve statement.		
4055	Curve failure. No distance for curve file movement.	Review the point data.		
4056	Curve failure. Point positions for the Curve statement are too close.	Set the distance between two points adjacent to the specified point more than 0.001 mm.		
4058	Prohibited command while tracking was executed.	Remove the prohibited command from the program.		
4059	Executed encoder reset command while the motor is in the on state.	Turn the motor power OFF.		
4060	Executed an invalid command while the motor is in the on state.	Turn the motor power OFF.		
4061	Specified parameter is in use.	You attempted to clear the currently specified Arm and Tool. Select other Arm and Tool and execute.		
4062	Orientation variation is over 360 degrees.	You attempted to rotate the joint #J6 more than 360 degrees with a CP motion command.		
4063	Orientation variation of adjacent point is over 90 degrees.	On the specified point line by the Curve statement, set the orientation variation of U, V, and W coordinate values between two adjacent points to under 90 degrees.		

No.	Message	Remedy	Note 1	Note 2
4064	Cannot execute the orientation correction automatically.	On the specified point line, a curve cannot be created by automatic orientation correction. Change the specified point line so that the joint #J6 orientation variation decreases.		
4065	Attempt to revolve J6 one rotation with the same orientation in CP statement.	You attempted to rotate the joint #J6 more than 360 degrees with a CP motion command. You attempted to revolve the joint 6 one rotation with the same as motion start orientation. Change the target point so that the joint #J6 revolves less than one rotation.		
4066	Motion command was attempted in the prohibited area depended on joint combination.	You attempted to move the joints to the robot's interference limited area.		
4068	ROT modifier parameter was specified for the CP motion command without orientation rotation.	Delete the ROT from the CP motion command.		
4069	Specified ECP without selecting ECP in CP statement.	Specify a valid ECP.		
4070	Specified ECP number does not match the ECP number used in curve file creation.	Specify a valid ECP.		
4071	Attempted motion command during electromagnetic brake lock condition.	Release the electromagnetic brake		
4072	Initialization failure. Hardware monitor was not initialized.	Reboot the controller. Initialize the controller firmware. Replace the controller.		
4073	Orientation variation of adjacent point is over 90 degrees.	Any of U, V, or W changes 90 degrees or more. Change the point or the orientation.		
4074	Motor type does not match the current robot setting.	Check whether the specified robot model is connected.		
4075	Option is not active.	Enable the option.		
4076	Point positions used to define the Plane are too close.	Set the distance between points more than 1 μm .		
4077	Point coordinate data used to define the Plane is invalid.	Match the coordinate data for the points to be specified.		
4078	Only the additional ST axis was attempted to be changed by the CP statement.	Use PTP motion commands in order to move the additional axis only.		
4079	Speed of additional ST axis by the CP statement is too fast.	Reduce the set values of SpeedS and AccelS.		
4080	Cannot execute when the Enable Switch is OFF.	Turn the Enable Switch ON and then execute.		
4081	Error was detected during operation.	Check the PG board. Check the connection with the motor driver. Replace the PG board. Replace the controller.		

No.	Message	Remedy	Note 1	Note 2
4082	Pulse Generator Board error was detected during operation.	Check the PG board. Check the connection with the motor driver. Replace the PG board.		
4083	MCAL did not complete in time.	Set PG parameter so that MCAL can complete within 120 seconds.		
4084	Limit Sensor error was detected during operation.	Check the limit sensor.		
4085	Failed to change to specified location.	Reboot the controller. Initialize the controller firmware. Replace the controller.		
4086	Cannot execute because it is not dry run mode.	Change to the dry run mode and execute.		
4087	Failed to format the playback file.	Check the amount of free space of the computer. Reboot the computer. Reinstall the RC+. Replace the computer.		
4089	The time interval from HealthRBStart to HealthRBStop is too long or too short.	Set the time interval from HealthRBStart to HealthRBStop to be within 1 to 3600 seconds.	-	-
4090	HealthRBStop is executed without HealthRBStart.	Execute HealthRBStop after executing HealthRBStart. This error also occurs when HealthRBStop is executed again without executing HealthRBStart after HealthRBStop.	-	-
4091	Specified analog I/O channel does not exist.	Check the channel number. Mount the analog I/O option board.		
4092	Specified analog output channel is used for a speed data output.	Execute after stopping the speed output of the specified channel.		
4093	If the motion is paused during the singularity-avoiding, the motion cannot resume. Abort the motion command.	Abort the motion command.		
4094	The current position is out of the motion range.	Either J1 or J2 axis is out of the motion range. Follow the procedures below and move the robot within the motion range. • Use Pulse command and JTran to move the robot within the motion range. • Move the robot within the motion range manually. (This error only occurs in RS series and N series.)		
4096	Robot in use. Cannot execute the motion command when other tasks are using the robot.	The motion command for the robot cannot be simultaneously executed from more than one task. Review the program. This error cannot be recovered automatically by OnErr.		
4099	Servo error was detected during operation.	Check if a 5000 number error is occurring in the system history. If the error is occurring, take measures for a 5000 number error.		

No.	Message	Remedy	Note 1	Note 2
4100	Communication error in motion control module. Cannot calculate the current point or pulse.	Reboot the controller. Initialize the controller firmware. Replace the controller.		
4101	Communication error in the motion control module. Cannot calculate the current point or pulse.	Reboot the controller. Initialize the controller firmware. Replace the controller.		
4103	Initialization failure. Motion control module initialization error.	T/VT series Manipulators: For T series Manipulator, reboot the controller and take the measure against noise. If the joint number is displayed in the system history, replace the motor unit. If not, replace the CPU board. Other Manipulators: Reboot the controller. Initialize the controller firmware. Replace the controller.		
4104	Positioning timeout of the joint connected to the Pulse Generator Board.	Cannot receive the positioning completion signal (DEND) from the servo motor connected to PG board.		
4108	Initialization failure. Motor unit connection error.	Check the wiring of the motor unit.		
4150	Redundant input signal failure of the emergency stop.	The input status of the redundant emergency stop input continuously differs for more than two seconds. Check whether no disconnection, earth fault, or short-circuit of the emergency stop input signal exists. Then reboot the controller.		
4151	Redundant input signal failure of the safeguard.	The input status of the redundant emergency stop input continuously differs for more than two seconds. Check whether no disconnection, earth fault, or short-circuit of the emergency stop input signal exists. Then reboot the controller.		
4152	Relay welding error of the main circuit.	A relay welding error was detected due to power system over current. Replace the controller. Replace the robot.		
4153	Redundant input signal failure of the enable switch.	The input status of the redundant enable signal differs continuously for more than two seconds. Check the TP connector connection. Replace the TP. Replace the controller.		
4154	Temperature of regeneration resistor was higher than the specified temperature.	Robot's Duty is too high. Lengthen the waiting time or reduce the Accel value. If the error occurs although Duty was lowered, replace the DPB.		
4180	Robot initialization failure. Specified robot was is not found	Configure the manipulator.		
4181	Robot initialization failure. Specified robot was in use by another task.	Specified manipulator cannot be configured since it is already configured.		
4182	Robot initialization failure. Robot name is too long.	Shorten the manipulator name.		

No.	Message	Remedy	Note 1	Note 2
4183	Robot initialization failure. Robot data version error.	Reconfigure the manipulator.		
4187	Robot initialization failure. Communication error with the module: VSRCMNPk.	Reboot the controller. Initialize the controller firmware. Replace the controller.		
4188	Robot initialization failure. Joint angle interference matrix is invalid.	Reboot the controller. Initialize the controller firmware. Replace the controller.		
4189	Robot initialization failure. Communication error with the module: VSRCMC.	Reboot the controller. Initialize the controller firmware. Replace the controller.		
4191	Robot initialization failure. Physical-logical pulse transformation matrix is invalid.	Reboot the controller. Initialize the controller firmware. Replace the controller.		
4192	Robot initialization failure. Communication error with the servo module.	Reboot the controller. Initialize the controller firmware. Replace the controller.		
4210	RAS circuit detected a servo system malfunction. Reboot the controller. Check for noise. Replace the controller.	Reboot the controller, take the measure against noise, or replace the DMB.		
4211	Servo CPU internal RAM failure. Reboot the controller. Check for noise. Replace the DMB.	Reboot the controller, take the measure against noise, or replace the DMB.		
4212	RAM for the main and servo CPU communication failure. Reboot the controller. Check for noise. Replace the DMB.	Reboot the controller, take the measure against noise, or replace the DMB.		
4213	Servo CPU internal RAM failure. Reboot the controller. Check for noise. Replace the DMB.	Reboot the controller, take the measure against noise, or replace the DMB. For T series, it is not DMB but CPU board.		
4214	Initialization communication of main CPU and servo CPU failure. Reboot the Controller. Check for noise. Replace DMB.	Reboot the controller, take the measure against noise, or replace the DMB. For T series, it is not DMB but CPU board.		
4215	Initialization communication of the main and servo CPU failure. Reboot the controller. Check for noise. Replace the DMB.	Reboot the controller, take the measure against noise, or replace the DMB.		
4216	Communication of the main and servo CPU failure. Reboot the controller. Check for noise. Replace the DMB.	Reboot the controller, take the measure against noise, or replace the DMB. For T series, it is not DMB but CPU board.		
4217	Communication of the main and servo CPU failure. Reboot the controller. Check for noise. Replace the DMB.	Reboot the controller, take the measure against noise, or replace the DMB. For T series, it is not DMB but CPU board.		
4218	Servo long time command overrun.	Reboot the controller, take the measure against noise, or replace the DMB.		
4219	Servo long time command check sum error.	Reboot the controller, take the measure against noise, or replace the DMB.		

Maintenance 9. Troubleshooting

No.	Message	Remedy	Note 1	Note 2
4220	System watchdog timer detected a failure. Reboot the controller. Check for noise. Replace the DMB.	Reboot the controller, take the measure against noise, or replace the DMB. For T series, it is not DMB but CPU board.		
4221	Drive unit check failure.	Reboot the controller, take the measure against noise, or replace the DMB.		
4222	RAM failure of the servo CPU. Reboot the controller. Check for noise. Replace the DMB.	Reboot the controller, take the measure against noise, or replace the DMB.		
4223	Failure of duplicate circuit of the emergency stop or the safeguard. Check the wiring.	Check the wiring of the emergency stop or the safeguard.		
4224	Low voltage of the main circuit power supply is detected. Check the power supply voltage. Reboot the controller.	Check the power supply voltage, or reboot the controller.		
4225	Control relay contact of the main circuit power supply is welded. Replace the DPB.	Replace the DPB.		
4226	Detect the recognition mismatch of the sub CPU and main CPU.	Reboot the controller, take the measure against noise, or replace the CPU board.		
4227	Temperature of regeneration resistor was higher than the specified temperature.	Specify the Weight/Inertia setting. Check the load. Check the robot. (Smoothness, backlash, non-smooth motion, loose belt tension, brake) Check the interference with the peripheral equipment. (Collision, contact) Check the model setting. Check the power cable connection.		
4228	Over voltage of the sub CPU.	Replace the DPB board.		
4230	Servo real time status failure. Check sum error.	A data checksum error was detected in the controller. Check the short-circuit and improper connection of the peripheral equipment wiring. (Emergency, D-I/O, and Expansion I/O connectors) Replace the controller.		
4232	Servo real time status failure. Free running counter error with the servo.	A free running counter error was detected in the controller. Check the short-circuit and improper connection of the peripheral equipment wiring. (Emergency, D-I/O, and Expansion I/O connectors) Replace the controller.		
4233	Servo real time status failure. Communication error with the servo CPU.	A communication error was detected in the controller. Check the short-circuit and improper connection of the peripheral equipment wiring. (Emergency, D-I/O, and Expansion I/O connectors) Replace the controller.		

No.	Message	Remedy	Note 1	Note 2
4240	Irregular motion control interruption was detected. Interruption duplicate.	A interruption error was detected in the controller. Check the short-circuit and improper connection of the peripheral equipment wiring. (Emergency, D-I/O, and Expansion I/O connectors) Replace the controller.		
4241	Over speed during low power mode was detected.	The robot over speed was detected during low power mode. Check the robot mechanism. (Smoothness, backlash, non-smooth motion, loose belt tension, brake) Check whether the robot does not interfere with peripheral equipment. (Collision, contact) Replace the motor driver. Replace the motor. (Motor and encoder failure) Check the short-circuit and improper connection of the peripheral equipment wiring. (Emergency, D-I/O, and Expansion I/O connectors)		
4242	Improper acceleration reference was generated.	You attempted to operate the robot with the acceleration reference exceeding the specified value. For a CP motion, decrease the AccelS value.		
4243	Improper speed reference was generated in high power mode.	The robot over speed was detected during high power mode. Check the robot mechanism. (Smoothness, backlash, non-smooth motion, loose belt tension, brake) Check whether the robot does not interfere with peripheral equipment. (Collision, contact) Replace the motor driver. Replace the motor. (Motor and encoder failure) Check the short-circuit and improper connection of the peripheral equipment wiring. (Emergency, D-I/O, and Expansion I/O connectors)		
4248	The robot collides with itself. Please change the target position.	Set a relay point. Or change the target point.		
4250	Arm reached the limit of motion range during the operation.	Check whether a CP motion trajectory is within the motion range.		
4251	Arm reached the limit of XY motion range specified by XYLim during the operation.	Check the XYLim setting.		
4252	Coordinate conversion error occurred during the operation.	Check whether a CP motion trajectory is within the motion range.		
4255	Because SpeedS is too big, the robot cannot pass elbow specific posture	Reduce the SpeedS value.		
4256	When a robot passed elbow specific posture, Stop or Pause were carried out	Do not execute Stop or Pause.		

No.	Message	Remedy	Note 1	Note 2
4257	The robot cannot pass Singularity Area of Elbow	The robot cannot pass the elbow singularity area. To pass the elbow singularity area, use SING_AVOID of "AvoidSingularity".		
4261	The Arm reached the limit of motion range in conveyor tracking.	Place the conveyor inside the motion range. Meanwhile, allow the tracking range for the deceleration when switching from tracking motion to non-tracking.		
4262	The Arm reached the limit of XY motion range in conveyor tracking.			
4263	The Arm reached the limit of pulse motion range in conveyor tracking.	If error occurs during the shift from tracking motion, it may be prevented by increasing the accel speed to complete the tracking motion.		
4267	Attempt to exceed the J4Flag attribute without indication.	You attempted to exceed the J4Flag attribute during motion without the J4Flag indication. Change the J4Flag for the target point.		
4268	Attempt to exceed the J6Flag attribute without indication.	You attempted to exceed the J6Flag attribute during motion without the J6Flag indication. Change the J6Flag for the target point.		
4269	Attempt to exceed the particular wrist orientation attribute without indication.	You attempted to exceed the particular wrist orientation attribute during motion without the Wrist indication. Change the Wrist attribute for the target point. Change the target point to avoid a particular wrist orientation.		
4270	Attempt to exceed the particular arm orientation attribute without indication.	You attempted to exceed the particular hand orientation attribute during motion without the Hand indication. Change the Hand attribute for the target point. Change the target point to avoid a particular hand orientation.		
4271	Attempt to exceed the particular elbow orientation attribute without indication.	You attempted to exceed the particular elbow orientation attribute during motion without the Elbow indication. Change the Elbow attribute for the target point. Change the target point to avoid a particular elbow orientation.		
4272	Specified point flag is invalid.	For a CP motion command, the arm form at the target point is different from the point flag specified with the target point. Change the point flag for the target point.		
4273	J6Flag switched during the lift motion in conveyor tracking.	Adjust the Tool orientation so that J6Flag will not switch.		

No.	Message	Remedy	Note 1	Note 2
4274	Specified J6Flag is not reached. Change J6Flag for target point.	For a CP motion command, the manipulator reached to the target point with J6Flag which differs from the one specified for the target point. Change J6Flag for the target point.		
4275	Specified J4Flag is not reached. Change J4Flag for target point.	For a CP motion command, the manipulator reached to the target point with J4Flag which differs from the one specified for the target point. Change J4Flag for the target point.		
4276	Specified ArmFlag is not reached. Change ArmFlag for target point.	For a CP motion command, the manipulator reached to the target point with ArmFlag which differs from the one specified for the target point. Change ArmFlag for the target point.		
4277	Specified Elbow Flag is not reached. Change Elbow Flag for target point.	For a CP motion command, the manipulator reached to the target point with ElbowFlag which differs from the one specified for the target point. Change ElbowFlag for the target point.		
4278	Specified WristFlag is not reached. Change WristFlag for target point	For a CP motion command, the manipulator reached to the target point with WristFlag which differs from the one specified for the target point. Change WristFlag for the target point.		
4279	Specified J1Flag is not reached. Change J1Flag for target point.	For a CP motion command, the manipulator reached to the target point with J1Flag which differs from the one specified for the target point. Change J1Flag for the target point.		
4291	Data sending failure in motion network.	Check the connection of the cable for Drive Unit.		
4292	Data receiving failure in motion network.	Check the connection of the cable for Drive Unit.		
4297	Data sending failure of Force Sensor I/F board. Check connection of the Force Sensor I/F board and Force Sensor.	Check connection of the Force Sensor I/F board and Force Sensor. Reboot the controller. Please inquire with us if a similar error occurs even after rebooting the controller.		
4298	Data receiving failure of Force Sensor I/F board. Check connection of the Force Sensor I/F board and Force Sensor.	Check connection of the Force Sensor I/F board and Force Sensor. Reboot the controller. Please inquire with us if a similar error occurs even after rebooting the controller.		
4301	The Pulse Generating Board detected a limit signal.	Reset and then execute the next motion.		
4302	The Pulse Generating Board detected an alarm signal.	Release the alarm of the pulse motor driver.		
4401	The specified conveyor number is invalid.	Review the conveyor number.		
4402	The specified conveyor queue is full.	The number of registration reached the upper limit (1000 pcs.) Delete the queue.		

Maintenance 9. Troubleshooting

No.	Message	Remedy	Note 1	Note 2
4403	Continue operation cannot be done in tracking motion.	Tracking motion cannot be continued after aborted/paused?		
4404	The specified conveyor queue data does not exist.	Review the queue number. Or, check whether the queue is registered.		
4405	The conveyor is not correctly initialized.	Rebuild the project. Delete the conveyor and then reestablish the setting.		
4406	The specified queue data is outside the set area.	The queue outside of the range cannot be tracked. If the specified queue is above the upstream limit, change the program so that tracking does not start until the queue enters the area below the upper limit. If the specified queue is below the downstream limit, change the program to delete the queue data.		
4407	The encoder is not correctly assigned.	Set the encoder.		
4409	The parameter of the conveyor instruction is invalid.	Review the parameter.		
4410	A conveyor coordinates conversion error occurred.	Rebuild the project. Delete the conveyor and then reestablish the setting.		
4411	Communication error within the Conveyor Modules.	Reboot the controller. Initialize the controller firmware. Replace the controller.		
4413	Conveyor tracking starting error.	Reboot the controller. Initialize the controller firmware. Replace the controller.		
4414	Conveyor tracking cannot start after motion with CP ON.	Start the conveyor tracking using CP OFF.		
4415	The setting of Diagonal Upstream Limit or Diagonal Downstream Limit is not appropriate.	The diagonal downstream limit is above the upstream limit, or the diagonal upstream/downstream limit is horizontal to the conveyor direction. Review the setting of diagonal upstream/downstream limit.		
4500	Cannot execute the specified functions at the same time. Note 1, 2: Type of the functions. Review the program.	Review the program.	Type of the functions 1: External control point motion (ECP) 2: Torque control 3: Conveyor tracking 4: Force control function 5: FCMove 6: Distance tracking function	Type of the functions * Same as Note 1

No.	Message	Remedy	Note 1	Note 2
4501	Device is in use. Note 1: Type of the device. Check whether other commands are using the device.	Check whether the device is used in other task or command.	Type of the device 1: Analog I/O input channel	
4502	Cannot execute this command during the control function. Note 1: Type of the control function. Exit the control function.	Check whether the control function is executed in other task or command Exit the control function to execute the command.	Type of the control function 1: Distance tracking function	
4503	An undefined parameter was specified. Note 1: Type of the parameter. Check the parameter.	Check whether the parameter is set. Set the parameter.	Type of the parameter 1: Parameter of the distance tracking function	
4504	Option is not enabled. Check the option setting.	Enable the option.		
4601	Failed to initialize the motion. Reboot the controller.	Reboot the controller. Initialize the controller firmware. Replace the controller.		
4602	Motion calculation error. Reboot the controller.	Reboot the controller. Initialize the controller firmware. Replace the controller.		
4603	Sensor value is out of range. Check the sensor.	Check the measured value by the sensor. Check the status of the sensor. Check the range setting of the sensor. When Note 1 is 1 (sensor used by the distance tracking function), check and adjust the parameter specified by AIO_TrackingStart or AIO_TrackingSet.	Type of the sensor 1: Sensor used by the distance tracking function	
4604	Approached the singularity point. Avoid the singularity point.	Check whether the coordinates near the singularity is specified. Check whether the robot moves closer to the singularity during the operation. Review the installation position of the robot.		

No.	Message	Remedy	Note 1	Note 2
5000	Servo control gate array failure. Check the DMB.	Check the short-circuit and improper connection of the peripheral equipment wiring. (Emergency and I/O connectors) Replace the DMB. Replace the additional axis unit. For T series, reboot the controller, take the measure against noise, and replace the CPU board and motor unit.		
5001	Disconnection of the parallel encoder signal. Check the signal cable connection or the robot internal wiring.	Check the M/C cable signal. Check the robot signal wiring. (Missing pin, disconnection, short-circuit) Replace the motor. Replace the DMB. Check the connector connection in the controller. (Loosening, connecting to the serial encoder terminal on the DMB) Check the model setting. Check the peripheral equipment wiring. (Emergency and I/O) For T series, reboot the controller, take the measure against noise, and replace the motor unit.		
5002	Motor driver is not installed. Install the motor driver. Check the DMB or the motor driver.	Check whether the motor driver is mounted. Check the model setting and hardware setting. Replace the motor driver. Replace the DMB. For T series, check the wiring of the motor unit.		
5003	Initialization communication failure of incremental encoder. Check the signal cable connection and the robot setting.	Check the model setting. Replace the motor. (Encoder failure) Replace the DMB. For T series, reboot the controller, take the measure against noise, and replace the CPU board and motor unit.		
5004	Initialization failure of absolute encoder. Check the signal cable connection or the robot setting.	Check the model setting. Replace the motor. (Encoder failure) Replace the DMB. For T series, reboot the controller, take the measure against noise, and replace the motor unit.		
5005	Encoder division setting failure. Check the robot setting.	Check the model setting.		

No.	Message	Remedy	Note 1	Note 2
5006	Data failure during absolute encoder initialization. Check the signal cable connection, the controller, or the motor.	Replace the motor. Replace the DMB. (Encoder failure) Check the noise countermeasures. For T series, reboot the controller, take the measure against noise, and replace the motor unit.		
5007	Absolute encoder multi-turn is beyond the maximum range. Reset the encoder.	Reset the encoder. Replace the motor.		
5008	Position is out of the range. Reset the encoder.	Reset the encoder. Replace the DMB. Replace the motor.		
5009	No response from the serial encoder. Check the signal cable connection, the motor, the DMB, or the encoder IF board.	Check the model setting. (Improperly setting of the parallel encoder model) Check the signal cable connection. Replace the DMB and encoder I/F board.		
5010	Serial encoder initialization failure. Reboot the controller. Check the motor, the DMB, or the encoder IF board.	Check the robot configuration. Check the signal cable connection. Replace the DMB and encoder I/F board. For T series, reboot the controller, take the measure against noise, and replace the motor unit.		
5011	Serial encoder communication failure. Reboot the controller. Check the motor, the DMB, or the encoder IF board.	Check the robot configuration. Check the signal cable connection. Replace the DMB and encoder I/F board. For T series, reboot the controller, take the measure against noise, and replace the motor unit.		
5012	Servo CPU watchdog timer failure. Reboot the controller. Check the motor or the DMB.	Replace the DMB. Check the noise countermeasures. For T series, check the connection of the signal cable. Reboot the controller, take the measure against noise, and replace the motor unit.		
5013	Current control circuit WDT failure. Reboot the controller. Check the controller.	Check the power cable connection. Check the 15V power supply and cable connection. Replace the DMB. Check the noise countermeasures. For T series, reboot the controller, take the measure against noise, and replace the motor unit.		

No.	Message	Remedy	Note 1	Note 2
5014	The DMB is not for this robot.	Check robot setting. Replace with the supported DMB.		
5015	Encoder is reset. Reboot the controller.	Reboot the controller.		
5016	Power supply failure of the absolute encoder. Replace the battery. Check the robot internal wiring.	Reset the encoder. Check the signal cable connection.		
5017	Backup data failure of the absolute encoder. Reset the encoder.	Reset the encoder. Check the signal cable connection.		
5018	Absolute encoder battery alarm.	Replace the battery. Check the signal cable connection.		
5019	Position failure of the absolute encoder. Reset the encoder. Replace the motor.	Reset the encoder. Replace the motor. (Encoder failure) For T series, reboot the controller, take the measure against noise, and replace the motor unit.		
5020	Speed is too high at controller power ON. Stop the robot and reboot the controller.	Reboot the controller. Reset the encoder. For T series, reboot the controller, take the measure against noise, and replace the motor unit. Check the interference with the other devices.		
5021	Absolute encoder overheat.	Lower the motion duty. Wait until the temperature of the encoder decreases.		
5022	R/D transducer failure. Reset the encoder. Check resolver board or the robot internal wiring.	Reset the encoder. Check the signal wiring of the manipulator (loose pin, disconnection, short). Replace the resolver board.		
5023	G sensor communication failure. Check for the signal cable connection or manipulator internal wiring.	Check the signal wiring connection. Check the signal wiring of the manipulator (loose pin, disconnection, short). Check the noise countermeasure. Replace the control board. Replace the DMB.		
5024	G sensor data error. Check for the control board.	Replace the control board.		
5025	Gap occurred between multi-turn data and R/D conversion data. Encoder reset.	Reset the resolver. Check the noise countermeasure. Replace the resolver board.		
5026	Disconnection of the resolver excitation signal. Reset the encoder. Check the resolver board or the robot internal wiring.	Check the signal wiring of the manipulator (loose pin, disconnection, short). Replace the resolver board.		

No.	Message	Remedy	Note 1	Note 2
5027	S-DSP detected the communication error in DSP. Check for DMB.	Reboot the controller. Check the noise countermeasure. Replace the DMB.		
5028	Current feedback data error is detected. Check for DMB.	Reboot the controller. Check the noise countermeasure. Replace the DMB. For T series, check the short-circuit and earth fault of the power cable. Reboot the controller or replace the motor unit.		
5029	D-DSP communication failure. Check the DMB.	Reboot the controller. Check the noise countermeasure. Replace the DMB.		
5030	Speed is too high at controller power OFF. Reset the encoder.	Reset the encoder. Replace the motor.		
5031	Speed is too high. Reset the encoder. Excess the calculation amount	Reset the encoder. Replace the motor. For T series, reboot the controller and replace the motor unit.		
5032	Servo alarm A.	Reboot the controller.		
5040	Motor torque output failure in high power state. Check the power cable connection, the robot, the driver or the motor.	Specify the Weight/Inertia setting. Check the load. Check the robot. (Smoothness, backlash, non-smooth motion, loose belt tension, brake) Check the interference with the peripheral equipment. (Collision, contact) Check the model setting. Check the power cable connection. Check the robot power wiring. (Missing pin, disconnection, short-circuit) Check the power supply voltage. (Low power supply voltage) Replace the motor driver. Replace the DMB. Replace the motor. For T series, replace the CPU board and motor unit in addition to the above.		

No.	Message	Remedy	Note 1	Note 2
5041	Motor torque output failure in low power state. Check the power cable connection, robot, brake, driver, or motor.	<p>Check the robot. (Smoothness, backlash, non-smooth motion, loose belt tension, brake)</p> <p>Check the interference with the peripheral equipment. (Collision, contact)</p> <p>Check the model setting.</p> <p>Check the power cable connection.</p> <p>Check the robot power wiring. (Missing pin, disconnection, short-circuit)</p> <p>Check the power supply voltage. (Low power supply voltage)</p> <p>Replace the motor driver.</p> <p>Replace the DMB.</p> <p>Replace the motor.</p> <p>For T series, replace the CPU board and motor unit in addition to the above.</p>		
5042	Position error overflow in high power state. Check the power cable connection, the robot, the driver and the motor.	<p>Specify the Weight/Inertia setting.</p> <p>Check the load.</p> <p>Check the robot. (Smoothness, backlash, non-smooth motion, loose belt tension, brake)</p> <p>Check the interference with the peripheral equipment. (Collision, contact)</p> <p>Check the model setting.</p> <p>Check the power cable connection.</p> <p>Check the robot power wiring. (Missing pin, disconnection, short-circuit)</p> <p>Check the power supply voltage. (Low power supply voltage)</p> <p>Replace the motor driver.</p> <p>Replace the DMB.</p> <p>Replace the motor.</p> <p>For T series, replace the CPU board and motor unit in addition to the above.</p>		

No.	Message	Remedy	Note 1	Note 2
5043	Position error overflow in low power state. Check the power cable connection, robot, brake, driver, or motor.	<p>Check the robot. (Smoothness, backlash, non-smooth motion, loose belt tension, brake)</p> <p>Check the interference with the peripheral equipment. (Collision, contact)</p> <p>Check the model setting.</p> <p>Check the power cable connection.</p> <p>Check the robot power wiring. (Missing pin, disconnection, short-circuit)</p> <p>Check the power supply voltage. (Low power supply voltage)</p> <p>Replace the motor driver.</p> <p>Replace the DMB.</p> <p>Replace the motor.</p> <p>For T series, replace the CPU board and motor unit in addition to the above.</p>		
5044	Speed error overflow in high power state. Check the power cable connection, robot, brake, driver, or motor.	<p>Specify the Weight/Inertia setting.</p> <p>Check the load.</p> <p>Check the robot. (Smoothness, backlash, non-smooth motion, loose belt tension, brake)</p> <p>Check the interference with the peripheral equipment. (Collision, contact)</p> <p>Check the model setting.</p> <p>Check the power cable connection.</p> <p>Check the robot power wiring. (Missing pin, disconnection, short-circuit)</p> <p>Check the power supply voltage. (Low power supply voltage)</p> <p>Replace the motor driver.</p> <p>Replace the DMB.</p> <p>Replace the motor.</p> <p>For T series, replace the CPU board and motor unit in addition to the above.</p>		

No.	Message	Remedy	Note 1	Note 2
5045	Speed error overflow in low power state. Check the power cable connection, robot, brake, drive, or motor.	<p>Check the robot. (Smoothness, backlash, non-smooth motion, loose belt tension, brake)</p> <p>Check the interference with the peripheral equipment. (Collision, contact)</p> <p>Check the model setting.</p> <p>Check the power cable connection.</p> <p>Check the robot power wiring. (Missing pin, disconnection, short-circuit)</p> <p>Check the power supply voltage. (Low power supply voltage)</p> <p>Replace the motor driver.</p> <p>Replace the DMB.</p> <p>Replace the motor.</p> <p>For T series, replace the CPU board and motor unit in addition to the above.</p>		
5046	Over speed in high power state. Check the signal cable connection, robot, brake, driver or motor.	<p>Reduce SpeedS of the CP motion.</p> <p>Change the orientation of the CP motion.</p> <p>Specify the Weight/Inertia setting.</p> <p>Check the load.</p> <p>Check the robot. (Smoothness, backlash, non-smooth motion, loose belt tension, brake)</p> <p>Check the interference with the peripheral equipment. (Collision, contact)</p> <p>Check the model setting.</p> <p>Check the power cable connection.</p> <p>Check the robot power wiring. (Missing pin, disconnection, short-circuit)</p> <p>Check the power supply voltage. (Low power supply voltage)</p> <p>Replace the motor driver.</p> <p>Replace the DMB.</p> <p>Replace the motor.</p> <p>For T series, replace the CPU board and motor unit in addition to the above.</p>		

No.	Message	Remedy	Note 1	Note 2
5047	Over speed in low power state. Check the signal cable connection, robot, brake, driver, or motor.	Check the motion in high power state. Check the robot. (Smoothness, backlash, non-smooth motion, loose belt tension, brake) Check the interference with the peripheral equipment. (Collision, contact) Check the model setting. Check the power cable connection. Check the robot power wiring. (Missing pin, disconnection, short-circuit) Check the power supply voltage. (Low power supply voltage) Replace the motor driver. Replace the DMB. Replace the motor. For T series, replace the CPU board and motor unit in addition to the above.		
5048	Over voltage of the main power circuit. Check the main power voltage or the regeneration module.	Specify the Weight/Inertia setting. Check the load. Check the robot. (Smoothness, backlash, non-smooth motion, loose belt tension, brake) Check the interference with the peripheral equipment. (Collision, contact) Check the model setting. Check the power cable connection. Check the robot power wiring. (Missing pin, disconnection, short-circuit) Check the power supply voltage. (Low power supply voltage) Replace the motor driver. Replace the DMB. Replace the motor.		
5049	Over current of the motor driver. Check the power cable connection or the robot internal wiring.	Check the short-circuit and earth fault of the power line. Replace the motor driver. Replace the DMB. For T series, check the short-circuit and earth fault of the power cable. Reboot the controller or replace the motor unit.		
5050	Over speed during torque control. Check the work motion speed range.	Check the motion speed during torque control.		
5051	15V PWM drive power supply failure. Reboot the controller. Replace the 15V power supply.	Check the 15V power supply and cable connection. Replace the motor driver. Replace the DMB.		

No.	Message	Remedy	Note 1	Note 2
5054	Overload of the motor. Decrease the motion duty and the Accel.	Lower the motion duty. Check the Weight/Inertia setting. Check the robot. (Backlash, large load, loose belt tension, brake)		
5055	Overload of the motor. Decrease the operation duty and the Accel.	Lower the motion duty. Check the Weight/Inertia setting. Check the robot. (Backlash, large load, loose belt tension, brake)		
5056	G sensor data has changed rapidly. Check the control board.	Check the noise countermeasure. Replace the control board.		
5057	Collision was detected in High power mode (Detection of robot motion error)	Collision detection (detection of robot motion error) was functioned. The following errors have detected: - Collision or contact of the robot arm occurs. - Torque saturation due to little setting of Weight or Inertia. - Torque saturation due to combined motion of multiple joints and throwing around the long object. - Torque saturation due to supply voltage reduction. - Error motion due to hardware error or software malfunction. Countermeasures: Check the there is no collision or contact of the robot arm and change the arrangement to avoid interfere. Confirm that torque saturation is occurred. During torque saturation: check the setting of Weight and Inertia are properly and correct them if necessary. During combined motion: adjust the acceleration and deceleration to avoid torque saturation. Check the power supply voltage and correct them if necessary. If other error occurs at the same time, take a countermeasure for that first. Reference: <i>EPSON RC+ 7.0 User's Guide</i> "6.18.10 Collision Detection Function (Error detection function of robot motion)"		

No.	Message	Remedy	Note 1	Note 2
5058	Collision was detected in Low power mode (Detection of robot motion error)	Collision detection (Detection of robot motion error) was functioned. The following errors have detected: - Collision or contact of the robot arm occurs. - Torque saturation due to holding a hand or long object that exceeds the weight described in the specifications. - Error motion due to hardware error or software malfunction. Countermeasures: Check the there is no collision or contact of the robot arm and change the arrangement to avoid interfere. Check the hand weight and correct it if necessary. Joint #4 and 5 of 6-axis robot: confirmed that torque saturation is occurred. If torque saturation is occurred: change to hold in high power mode. If other error occurs at the same time, take a countermeasure for that first. Reference: <i>EPSON RC+ 7.0 User's Guide</i> "6.18.10 Collision Detection Function (Error detection function of robot motion)"		
5072	Servo alarm B.	Reboot the controller.		
5080	Motor is overloaded. Decrease the duty and the Accel.	Lower the motion duty. Check the Weight/Inertia setting. Check the robot. (Backlash, large load, loose belt tension, brake)		
5098	High temperature of the encoder. Decrease the duty. Check the reduction gear unit of the robot.	Wait until the temperature of the encoder decreases. Lower the motion duty. Check the Weight/Inertia setting. Check the robot. (Backlash, large load, loose belt tension, brake)		
5099	High temperature of the motor driver. Clean the controller fan filter. Check the ambient temperature. Decrease the duty.	Clean the cooling fan filter. Lower the motion duty. Check the Weight/Inertia setting. Lower the ambient temperature.		
5112	Servo alarm C.	Reboot the controller.		
5501	Failed to initialize the force control. Reboot the controller.	Reboot the controller. Initialize the controller firmware. Replace the controller.		
5510	Force control calculation error. Reboot the controller.	Reboot the controller. Initialize the controller firmware. Replace the controller.		

No.	Message	Remedy	Note 1	Note 2
5511	Coordinate transformation error in force control. Check whether the robot moves outside of the motion range.	Check whether the coordinate out of the motion range is specified. Check whether the robot moves outside of the motion range during the execution of force control.		
5520	Impedance parameter error. Check the combination of Mass, Damper, and Spring	Check the combination of Spring, Damper, and Mass. Check whether the Mass property is too small for the Damper property.		
5521	The coordinate system mode other than the custom mode is specified for the Force Sensor which is not associated with the robot. Check configuration of the Force Sensor or the coordinate system mode.	Check association with the robot. Check if the direction other than the Custom coordinate is specified for the Orientation property of the force coordinate system object for the sensor which is not associated with the robot.		
5522	Undefined data is selected. Check if the selected data is defined.	Check if the specified parameter is defined.		
5523	The parameter which cannot be continued when the CF continues force control is specified. Check the Force Control Object and the Force Coordinate System Object.	Check the force control object and the force coordinate object which are used by the motion commands before and after continuing the force control by the CF parameter.		
5530	The specified time has passed after resetting the Force Sensor. Execute the Reset property of the Force Sensor Object.	Execute the Reset property for the Force Sensor object.		
5531	Approached the singularity point while executing force control. Avoid the singularity point when using force control.	Check whether the coordinates near the singularity is specified. Check whether the robot moves to the vicinity of the singularity during the execution of force control. Or, review the installation position of the robot.		
5532	Buffer for Force Sensor averaging is saturated. Shorten the time interval from AvgForceClear to AvgForce.	Shorten the time interval between AvgForceClear and AvgForce to be shorter than a minute.		
5533	The continuing time for CF to execute force control has passed. To continue force control, use FCKeep.	Check whether the interval of the motion commands is one minute or less.		
5535	SCARA robot cannot execute force control if the Orientation property of Base, Tool, Local, and FCS objects, or V and W of the current command position are other than 0. Check the parameters.	Set "0" to the Orientation property or V and W of the current command position for Base, Tool, Local, and FCS objects.		
5536	Force control is not supported for this robot model. Check the robot model and the controller firmware version.	Check if the specified robot is correct. Check if the Controller firmware supports the robot model.		

No.	Message	Remedy	Note 1	Note 2
5540	Force Sensor transmission error. Check connection of the Force Sensor I/F unit (board) and Force Sensor.	Execute the Reboot property for the Force Sensor object. Check connection of the Force Sensor and Force Sensor I/F unit (board). Reboot the Force Sensor and Force Sensor I/F unit (board). Please inquire with us if a similar error occurs even after the above countermeasures are taken.		
5541	Force Sensor reception error. Check connection of the Force Sensor I/F unit (board) and Force Sensor	Execute the Reboot property for the Force Sensor object. Check connection of the Force Sensor and Force Sensor I/F unit (board). Reboot the Force Sensor and Force Sensor I/F unit (board). Please inquire with us if a similar error occurs even after the above countermeasures are taken.		
5542	Force Sensor in use. Check if other commands are using the Force Sensor.	Check whether the Reset property or Reboot property of the Force Sensor object are executed in another task.		
5543	Force Sensor communication error. Execute the Reboot property of the Force Sensor Object.	Execute the Reboot property for the Force Sensor object. Check connection of the Force Sensor and Force Sensor I/F unit (board). Reboot the Force Sensor and Force Sensor I/F unit (board). Please inquire with us if a similar error occurs even after the above countermeasures are taken.		
5544	Element error of Force Sensor. Check whether force exceeding the rated value is applied to the Force Sensor. Execute the Reset property of the Force Sensor Object.	This error may occur if a long time passed while the Force Sensor is not reset. Execute the Reset property for the Force Sensor object. Check whether force exceeding the rated value is applied to the Force Sensor. Reboot the Force Sensor and Force Sensor I/F unit (board). Please inquire with us if a similar error occurs even after the above countermeasures are taken.		
5545	Circuit error 1 of Force Sensor. Execute the Reset property of the Force Sensor Object.	Execute the Reset property for the Force Sensor object. Reboot the Force Sensor and Force Sensor I/F unit (board). Please inquire with us if a similar error occurs even after the above countermeasures are taken.		

No.	Message	Remedy	Note 1	Note 2
5546	Circuit error 2 of Force Sensor. Execute the Reset property of the Force Sensor Object.	Execute the Reset property for the Force Sensor object. Reboot the Force Sensor and Force Sensor I/F unit (board). If a similar error occurs even after the above countermeasures are taken, check if the tip of the robot arm has a vibration.		
5547	High temperature error of the Force Sensor. Check if the ambient temperature is within the rated value and there is no rapid temperature change. Execute the Reset property of the Force Sensor Object.	Execute the Reset property for the Force Sensor object. Check the ambient temperature. Reboot the Force Sensor and Force Sensor I/F unit (board). Please inquire with us if a similar error occurs even after the above countermeasures are taken.		
5548	Force Sensor detected force exceeding the rated value. Check if force exceeding the rated value is applied. Execute the Reset property of the Force Sensor Object.	Execute the Reset property for the Force Sensor object. Check whether force exceeding the rated value is applied to the Force Sensor. Reboot the Force Sensor and Force Sensor I/F unit (board). Please inquire with us if a similar error occurs even after the above countermeasures are taken.		
5549	Force Sensor I/F unit (board) is not connected. Check connection of the Force Sensor I/F unit (board) and Force Sensor.	Check connection of the Force Sensor and Force Sensor I/F unit (board). Reboot the Force Sensor and Force Sensor I/F unit (board). Please inquire with us if a similar error occurs even after the above countermeasures are taken.		
5550	Force sensing of the Force Sensor is off. Check configuration of the Force Sensor.	Check the configuration of Force Sensor. Reboot the Force Sensor and Force Sensor I/F unit (board).		
5551	Unsupported Force Sensor is connected. Check the controller firmware version and connection of the Force Sensor.	Check whether the controller firmware supports the Force Sensor. Check connection of the Force Sensor and Force Sensor I/F unit (board). Reboot the Force Sensor and Force Sensor I/F unit (board).		
5552	Configuration of the force sensor failure. Check the configuration of the force sensor.	Check the configuration of the force sensor.		
5553	Unsupported function is executed on the connected force sensor. Review the program.	Check the force sensor settings. Review the program.		

No.	Message	Remedy	Note 1	Note 2
5560	Drift correction error of Force Sensor.	Check connection of the Force Sensor and Force Sensor I/F unit (board). Reboot the Force Sensor and Force Sensor I/F unit (board).		
5570	Force monitor buffer overflow. Reboot the force monitor.	Close and re-open the force monitor.		
5571	Force log buffer overflow. Set the data measurement interval longer.	Set the data measuring interval longer. The computer receiving the data may be under heavy load state.		
5572	Force control monitor buffer overflow. Reboot the force control monitor.	Close and re-open the Force Control Monitor.		
5573	The log data of the force guide sequence overflowed.	Reboot the controller. The computer receiving the data may be under heavy load state.		
5574	RecordStart buffer overflowed. Set the data measurement interval longer.	Set the data measuring interval longer. The computer receiving the data may be under heavy load state.		
5800	Failed to initialize the force control. Reboot the controller.	Reboot the controller. Initialize the controller firmware. Replace the controller.		
5801	Force control failed to allocate memory. Reboot the controller.	Reboot the controller. Initialize the controller firmware. Replace the controller.		
5802	Force control calculation error. Reboot the controller.	Reboot the controller. Initialize the controller firmware. Replace the controller.		
5803	Force Sensor failed to connect with the robot. Check connection setting of the Force Sensor.	Check connection setting of the Force Sensor.		
5810	Force control parameter error. Check the parameter range.	Check the range of the specified parameter.		
5811	Force Control Object parameter is out of the range. Note 1: Property Note 2: Axis Check the parameter.	Check the property of force control object.	1:Number 2:CoordinateSystem 3:Enabled 4:Mass 5:Damper 6:Spring 7:TargetForcePriorityMode 8:TargetForce 9:LimitSpeed 10:LimitAccel	1:Fx 2:Fy 3:Fz 4:Tx 5:Ty 6:Tz or 1:J 2:S 3:R
5812	LimitSpeed or LimitAccel of the Force Control Object is lower than speed or accel setting of the robot. Check the parameter.	Check the values of Speed, SpeedS, SpeedR, Accel, AccelS, AccelR, LimitSpeed and LimitAccel.		
5813	Enabled properties of the Force Control Object are all false. Set true to 1 or more axis.	Enable the "Enabled" property for at least one axis.		

No.	Message	Remedy	Note 1	Note 2
5814	SCARA robot cannot execute force control if the Orientation property of Base, Tool, Local, and FCS objects, or V and W of the current command position are other than 0, or if Tx_Enabled and Ty_Enabled are not False. Check the parameters.	Disable the enabled state of Tx and Ty. Set "0" to the Orientation property or V and W of the current command position for Base, Tool, Local, and FCS objects.		
5815	Force Trigger Object parameter is out of the range. Note 1: Property Note 2: Axis Check the parameter.	Check the property of force trigger object.	1: Number 2: Force Sensor 3: Coordinate System 4: Trigger Mode 5: Operator 6: Enabled 7: FMag_Axes 8: TMag_Axes 9: Polarity 10: UpperLevel 11: LowerLevel 12: UpperLevel smaller than LowerLevel 13: LPF_Enabled 14: LPF_TimeConstant	1: Fx 2: Fy 3: Fz 4: Tx 5: Ty 6: Tz 7: Fmag 8: Tmag
5816	Force Coordinate System Object parameter is out of the range. Note 1: Property Note 2: Axis Check the parameter.	Check the property of force coordinate system object.	1: Number 2: Position 3: Orientation_Mode 4: Orientation_UVW 5: Orientation_RobotLocal	1: X 2: Y 3: Z or 1: U 2: V 3: W
5817	Force Monitor Object parameter is out of the range. Note 1: Property Note 2: Axis Check the parameter.	Check the property of force monitor object.	1: Number 2: Force Sensor 3: Coordinate System 4: FMag_Axes 5: TMag_Axes 6: LPF_Enabled 7: LPF_TimeConstant	
5818	Force motion restriction object parameter is out of the range.	Reboot the controller. Initialize the controller firmware. Replace the controller.		
5819	Specified duration of FCKeep is out of the allowable range. Check the duration.	Check whether the specified duration is 600 seconds or less.		
5830	Force control cannot resume from the pause. Abort the motion command.	Abort the motion.		
5831	Cannot execute this command during force control. Exit force control by FCEnd.	Abort force control. Execute FCEnd command.		

No.	Message	Remedy	Note 1	Note 2
5832	Cannot execute the motion command which has no Force Control Object during force control. Exit force control by FCEnd.	Check whether the motion command right after continuing the force control by CT does not contain force control.		
5833	Cannot use gravity compensation. Can use only Mass Property object number '0'.	This is the combination of the force sensor and the robot that cannot use gravity compensation Set Mass Property object number '0'.		
5834	Unsupported function is executed on the connected force sensor. Review the program.	Check the force sensor settings. Review the program.		
5840	Force Sensor in use. Check whether other commands are using the Force Sensor.	Check whether the Reset property or Reboot property of the Force Sensor object are executed in another task.		
5841	Failed to reset the force sensor. Reset the force sensor again. Note1: Detailed error information	When the parameter is omitted or FG_RESET_FINE is specified, specify FG_RESET_WAIT_VIBRATION for parameter. When FG_RESET_WAIT_VIBRATION is specified, adjust the reset timing by Wait statement or remove the source of external vibration.	1: Timeout since Fine condition is not satisfied. 2: Timeout since the vibration did not stop.	
5901	Force control failed to allocate memory. Reboot the controller.	Reboot the controller. Initialize the controller firmware. Replace the controller.		
5902	Force control failed to release memory. Reboot the controller.	Reboot the controller. Initialize the controller firmware. Replace the controller.		
5903	The specified robot cannot be found.	Reboot the controller. Initialize the controller firmware. Replace the controller.		
5904	Force control failed to allocate memory. Reboot the controller.	Reboot the controller. Initialize the controller firmware. Replace the controller.		
5906	Specified force data number cannot be found. Specify a valid force data number.	Reboot the controller. Initialize the controller firmware. Replace the controller.		
5907	Specified force data number was not defined. Specify a teach force data number.	Specify a defined force data number.		
5908	Specified force coordinate system data number was not defined. Specify a teach force coordinate system data number.	Specify a defined force coordinate system data number.		
5909	Specified force data can't be updated.	Specified force data cannot be updated nor deleted by FSet, FDel, MPSet, or MPDel statement.		
5910	Specified force data value is out of allowable range.	Specify the value within the range.		

No.	Message	Remedy	Note 1	Note 2
5911	The Upper level value is smaller than the lower level value. Change the upper and lower level values.	Change the upper and lower level values.		
5912	The number of specified command parameters is not correct. Specify a valid number of parameters.	Specify a valid number of parameters.	Number of parameters	
5913	The number of specified function parameters is not correct. Specify a valid number of parameters.	Specify a valid number of parameters.	Number of parameters	
5914	The type of a specified command parameter is not correct. Specify valid parameters.	Specify valid parameters.		
5915	The type of a specified function parameter is not correct. Specify valid parameters.	Reboot the controller. Initialize the controller firmware. Replace the controller.		
5918	Specified force data label cannot be found. Specify a valid force data label.	Specify a defined valid force data label.		
5921	Duplicate force data label. Specified label name is already used. Change the label name.	Change the label name.		
5924	Force control of the specified robot failed to allocate memory. Reboot the controller.	Reboot the controller. Initialize the controller firmware. Replace the controller.		
5927	Cannot read the force data from the force file. Re-create the force file.	The force data is invalid and cannot be read. Re-create the force file.	0:FC 1:FCS 2:FT 3:FM 4:MASS	Force data number
5928	Force control failed to allocate memory. Reboot the controller.	Reboot the controller. Initialize the controller firmware. Replace the controller.		
5929	Specified force file name is not correct. Specify a valid force file name.	Reboot the controller. Initialize the controller firmware. Replace the controller.		
5930	Specified force data label is beyond the maximum length. Specify a valid force data label.	Specify a valid force data label. Refer to "Label Property" for details.		
5931	Description for the specified force data is beyond the maximum length. Specify a valid description.	Specify a valid description. Refer to "Description Property" for details.		
5932	The force file is corrupted. Re-create the force file.	Cannot load the force file because it is corrupted or was edited by tools other than Force Guide 7.0. Re-create the force file.		
5933	Specified force file cannot be found. Specify a valid force file name.	Specify a valid force file name.		
5934	Cannot save the force file.	Make an enough space to write the force file.	Robot number	
5940	The force data label is not correct. Specify a valid force data label.	Specify a valid force data label. Refer to "Label Property" for details.		

No.	Message	Remedy	Note 1	Note 2
5941	The force data label is not correct. Specify a valid force data label.	Specify a valid force data label. Refer to "Label Property" for details.		
5943	Invalid force file version. Update the controller firmware.	Cannot load the force file because it is a newer version.		
5944	Failed to read the force file. Re-create the force file.	Cannot load the force file because the format is not supported.		

Maintenance 9. Troubleshooting

No.	Message	Remedy	Note 1	Note 2
6001	Calibration number is out of range.	Correct the calibration number.		
6002	Calibration is not defined.	Perform calibration.		
6003	Camera orientation is out of range.	Correct the CameraOrientation value.		
6004	TwoRefPoints flag is out of range.	Correct the TwoRefPoint value.		
6005	Cannot calculate the point position because there is invalid data.	Re-teach the points.		
6006	Calibration failed. Cannot calculate because there is invalid data.	Perform point teaching and calibration again.		
6007	Coordinate transformation failed. Cannot calculate because there is invalid data.	Reteach the points.		
6009	Calibration file name is invalid.	Correct the calibration file name.		
6010	Calibration file is not found.	Correct the calibration file name.		
6012	Failed to read the calibration file.	Correct the calibration file name.		
6013	Failed to write the calibration file.	Check access permission for the project folder.		
6014	9 pixel coordinate points should be specified.	Make sure that at least 9 results are obtained in the vision sequence.		
6015	18 pixel coordinate points should be specified.	Make sure that at least 18 results are obtained in the vision sequence.		
6016	9 robot coordinate points should be specified.	Reteach the points.		
6017	18 robot coordinate points should be specified.	Reteach the points.		
6018	9 robot coordinate points and 1 reference point should be specified.	Perform point teaching and calibration again.		
6019	9 robot coordinate points and 2 reference points should be specified.	Perform point teaching and calibration again.		
6502	Vision process Communication error (-3)	Check the connection with the camera (cable, setting).		
6503	Vision process Memory error (-11)	Reboot RC+.		
6506	Vision process Error at modeling (-14)	Change the target and teach again.		
6507	Vision process Recovery error(-15)	Specify the file of appropriate format.		
6508	Vision process Invalid number of iterations (-16)	Set a value in the valid range.		
6509	Vision process Invalid mode (-17)	Set a valid value.		
6510	Vision process Invalid threshold value (-18)	Set a value in the valid range.		
6511	Vision process Invalid polarity (-19)	Set a value in the valid range.		
6512	Vision process File open failed (-20)	Specify a correct file.		
6513	Vision process Initialization error (-21)	Reinstall the RC+.		
6514	Vision process Status error (-22)	Check the connection with the camera.		
6517	Vision process Invalid image format (-25)	Specify the image file of readable format.		
6520	Vision process Invalid property value (-100)	Set a value in the valid range.		
6521	Vision process Exposure termination process failed (-201)	Disable Windows Firewall.		
6533	Vision process Invalid Blob property ThresholdLow value (-11004)	Set a value in the valid range.		
6534	Vision process Invalid Blob property ThresholdHigh value (-11005)	Set a value in the valid range.		
6535	Vision process Invalid Blob property Polarity value(-11006)	Set a value in the valid range.		

No.	Message	Remedy	Note 1	Note 2
6536	Vision process Invalid Blob property NumberToFind value (-11007)	Set a value in the valid range.		
6537	Vision process Invalid Blob property MinArea value (-11008)	Set a value in the valid range.		
6538	Vision process Invalid Blob property MaxArea value (-11009)	Set a value in the valid range.		
6539	Vision process Invalid Blob property RejectOnEdge value (-11010)	Set a value in the valid range.		
6540	Vision process Invalid Blob property SizeToFind value (-11011)	Set a value in the valid range.		
6553	Vision process Invalid Geom property Accept value (-11504)	Set a value in the valid range.		
6554	Vision process Invalid Geom property NumberToFind value (-11505)	Set a value in the valid range.		
6555	Vision process Invalid Geom property AngleEnable value (-11506)	Set a value in the valid range.		
6556	Vision process Invalid Geom property AngleRange value (-11507)	Set a value in the valid range.		
6557	Vision process Invalid Geom property AngleStart value (-11508)	Set a value in the valid range.		
6558	Vision process Invalid Geom property ScaleEnable value (-11509)	Set a value in the valid range.		
6559	Vision process Invalid Geom property ScaleFactorMax value (-11510)	Set a value in the valid range.		
6560	Vision process Invalid Geom property ScaleFactorMin value (-11511)	Set a value in the valid range.		
6561	Vision process Invalid Geom property ScaleTarget value (-11512)	Set a value in the valid range.		
6562	Vision process Invalid Geom property SeparationMinX value (-11513)	Set a value in the valid range.		
6563	Vision process Invalid Geom property SeparationMinY value (-11514)	Set a value in the valid range.		
6564	Vision process Invalid Geom property SeparationAngle value (-11515)	Set a value in the valid range.		
6565	Vision process Invalid Geom property SeparationScale value (-11516)	Set a value in the valid range.		
6566	Vision process Invalid Geom property Confusion value(-11517)	Set a value in the valid range.		
6567	Vision process Invalid Geom property ModelOrgAutoCenter value (-11518)	Set a value in the valid range.		
6570	Vision process Invalid Geom property DetailLevel value (-11521)	Set a value in the valid range.		
6571	Vision process Invalid Geom property Smoothness value (-11522)	Set a value in the valid range.		
6572	Vision process Invalid Geom property RejectOnEdge value (-11523)	Set a value in the valid range.		
6573	Vision process Invalid Geom property SharedEdges value (-11524)	Set a value in the valid range.		
6574	Vision process Invalid Geom property Timeout value (-11525)	Set a value in the valid range.		
6575	Vision process Invalid Geom property RejectByArea value (-11526)	Set a value in the valid range.		
6576	Vision process Invalid Geom property SearchReversed value (-11527)	Set a value in the valid range.		
6577	Vision process Invalid Geom property ScaleTargetPriority value (-11528)	Set a value in the valid range.		

Maintenance 9. Troubleshooting

No.	Message	Remedy	Note 1	Note 2
6578	Vision process Invalid Geom property SearchReducedImage value (-11529)	Set a value in the valid range.		
6586	Vision process Invalid Geom Model property DetailLevel value (-11602)	Set a value in the valid range.		
6587	Vision process Invalid Geom Model property Smoothness value (-11603)	Set a value in the valid range.		
6603	Vision process Invalid Corr property Accept value (-12004)	Set a value in the valid range.		
6604	Vision process Invalid Corr property NumberToFind value (-12005)	Set a value in the valid range.		
6605	Vision process Invalid Corr property AngleEnable value (-12006)	Set a value in the valid range.		
6606	Vision process Invalid Corr property AngleRange value (-12007)	Set a value in the valid range.		
6607	Vision process Invalid Corr property AngleStart value (-12008)	Set a value in the valid range.		
6608	Vision process Invalid Corr property AngleAccuracy value (-12009)	Set a value in the valid range.		
6609	Vision process Invalid Corr property Confusion value (-12010)	Set a value in the valid range.		
6610	Vision process Invalid Corr property ModelOrgAutoCenter value (-12011)	Set a value in the valid range.		
6613	Vision process Invalid Corr property RejectOnEdge value (-12014)	Set a value in the valid range.		
6614	Vision process Invalid Corr property Timeout value (-12015)	Set a value in the valid range.		
6615	Vision process Invalid Corr property RejectByArea value (-12016)	Set a value in the valid range.		
6630	Vision process Invalid Edge property structure size (-12501)	Set a value in the valid range.		
6631	Vision process Invalid Edge result header structure size (-12502)	Set a value in the valid range.		
6632	Vision process Invalid Edge result item structure size (-12503)	Set a value in the valid range.		
6633	Vision process Invalid Edge property EdgeType value (-12504)	Set a value in the valid range.		
6634	Vision process Invalid Edge property NumberToFind value (-12505)	Set a value in the valid range.		
6635	Vision process Invalid Edge property Polarity value (-12506)	Set a value in the valid range.		
6636	Vision process Invalid Edge property SearchWidth value (-12507)	Set a value in the valid range.		
6637	Vision process Invalid Edge property Accept value (-12508)	Set a value in the valid range.		
6638	Vision process Invalid Edge property ScoreWeightContrast value (-12509)	Set a value in the valid range.		
6639	Vision process Invalid Edge property ContrastTarget value (-12510)	Set a value in the valid range.		
6640	Vision process Invalid Edge property ContrastVariation value (-12511)	Set a value in the valid range.		
6641	Vision process Invalid Edge property StrengthTarget value (-12512)	Set a value in the valid range.		
6642	Vision process Invalid Edge property StrengthVariation value (12513)	Set a value in the valid range.		

No.	Message	Remedy	Note 1	Note 2
6653	Vision process Code Reader Checksum error (-1010)	Change to the code with a proper checksum. Or, change the setting not to use the checksum.		
6654	Vision process Code Reader Invalid quiet zone (-1011)	Ensure a quiet zone (blank margin) around the code. Set the quiet zone narrower.		
6655	Vision process Code Reader Message is too long (-1012)	Change the code.		
6686	Vision process OCR Recognition dictionary is full (-2132)	Delete the registered characters.		

No.	Message	Remedy	Note 1	Note 2
7003	The specified robot cannot be found.	Reboot the controller. Initialize the control firmware.		
7004	Duplicate allocation of the point data area.	Reboot the controller. Initialize the control firmware.		
7006	Specified point number cannot be found. Specify a valid point number.	Check the specified point number.		
7007	Specified point number was not defined. Specify a teach point number.	Check whether point data is registered in the specified point. Perform the teaching.		
7010	Cannot allocate the memory area for the pallet definition.	Reboot the controller. Initialize the controller firmware. Replace the controller.		
7011	Cannot free the memory area for the pallet definition.	Reboot the controller. Initialize the controller firmware.		
7012	Specified pallet number cannot be found. Specify a valid pallet number.	Check the pallet number.		
7013	Specified pallet is not defined. Specify a defined pallet or define the pallet.	Check whether the specified pallet is defined by the Pallet statement. Declare the pallet.		
7014	Specified division number is beyond the pallet division number definition. Specify a valid division.	Check the specified division number.		
7015	Specified coordinate axis number does not exist.	Check the specified coordinate axis number.		
7016	Specified arm orientation number does not exist.	Check the specified arm orientation number.		
7017	Cannot allocate the required memory.	Reboot the controller. Initialize the controller firmware. Replace the controller.		
7018	Specified point label cannot be found. Specify a valid point label.	Check the specified point label.		
7019	Parameter setup in the initialization file is invalid.	Reboot the controller. Initialize the controller firmware.		
7021	Duplicate point label. Specified label name is already used. Change the label name.	Change the point label.		
7022	Specified local coordinate system is not defined. Specify a valid local coordinate system number.	Check the specified local number. Define the Local coordinate system.		
7024	Point data memory area for the specified robot is not allocated.	Rebuild the project.		
7026	Cannot open the point file. Specify a valid point file name.	Check the point file name. Check whether the point file specified for the project exists.		
7027	Cannot read the point data from the point file.	Create the point file again.		
7028	Point area is allocated beyond the available point number.	There are too many points. Review the number of points.		
7029	Specified point file name is not correct. Specify a valid point file name.	Check the file extension.		

No.	Message	Remedy	Note 1	Note 2
7030	Specified point label is beyond the maximum length. Specify a valid point label.	Change the point label.		
7031	Description for the specified point is beyond the maximum length. Specify a valid description.	Change the comment.		
7032	Point file is corrupted. Check sum error.	Create the point file again.		
7033	Specified point file cannot be found. Specify a valid point file name.	Check the name of the specified point file.		
7034	Cannot save the point file.	Failed to save the point file (create a temporary file). Reboot the controller. Initialize the controller firmware. Replace the controller.		
7035	Cannot save the point file.	Failed to save the point file (file open). Reboot the controller. Initialize the controller firmware. Replace the controller.		
7036	Cannot save the point file.	Failed to save the point file (renew the file header). Reboot the controller. Initialize the controller firmware. Replace the controller.		
7037	Cannot save the point file.	Failed to save the point file (create the file name). Reboot the controller. Initialize the controller firmware. Replace the controller.		
7038	Cannot save the point file.	Failed to save the point file (copy the file). Reboot the controller. Initialize the controller firmware. Replace the controller.		
7039	Cannot save the point file.	Failed to save the point file (change the file name). Reboot the controller. Initialize the controller firmware. Replace the controller.		
7040	The point label is not correct. Specify a valid point label.	The initial character of the point label name is improper. Correct the label name.		
7041	The point label is not correct. Specify a valid point label.	Inadequate character is used. Correct the label name.		
7042	The pallet cannot be defined.	Undefined flag for pallet data is mixed. Check the point data. Correct the point data.		
7043	Invalid point file version.	The point file version is different. Re-create the point file.		
7044	The point file format version is unsupported.	The point file is not supported. Re-create the point file.		
7045	The specified work queue number is invalid.	Check the specified work queue number.		
7046	The specified work queue is full.	The work queue is full. Delete the point data from the work queue and register.		

Maintenance 9. Troubleshooting

No.	Message	Remedy	Note 1	Note 2
7047	The specified work queue data does not exist.	Check the specified index.		
7048	The work queue is not correctly initialized.	Failed to initialize the work queue (allocate memory). Reboot the controller. Initialize the controller firmware. Replace the controller.		
7049	The parameter of the work queue instruction is invalid.	Check the parameters of the commands related to the work queue.		
7050	Cannot execute while work queue data is registered.	Cannot set the work queue since the point data is registered to the work queue. Empty the work queue before setting.		
7101	Fieldbus slave. An error occurred during I/O data transform.	The fieldbus slave board is broken or the controller software is damaged. Restore the controller firmware.	1	
			2	
			3	
			4	
			10	
		A communication data error was detected during communication. The communication cable has a problem. Check the communication cable and its related units.	11	
			12	
			13	
The fieldbus is broken or the controller software is damaged. Restore the controller firmware.	14			
	15			
The PLC is not running or not connected. Check the PLC, the communication cable, and peripherals. (If Code 1 is 22 when the CC-Link board is used.)	22			

No.	Message	Remedy	Note 1	Note 2
7103	Fieldbus slave. Timeout error occurred during I/O data transform.	The fieldbus slave board is broken or the controller software is damaged. Restore the controller firmware.	1	
			2	
			3	
		4	A communication data error was detected during communication. The communication cable has a problem. Check the communication cable and its related units.	
7104	EPSON RC+ does not support CC-Link Ver2.00 settings. Please use EPSON RC+ 7.5.0 or later.	The connected RC+ does not support CC-Link Ver2.00. Please upgrade to RC+ 7.5.0 or later, or use a compatible RC+.		
7150	Fieldbus master. Bus is disconnected.	Check the connection of the communication cable for the fieldbus.		
7151	Fieldbus master. Bus power is off.	Check whether the communication cable for the fieldbus is powered.		
7152	Fieldbus master. Bus status error.	Reboot the controller. Check the fieldbus master board. Replace the fieldbus master board.		
7200	Invalid argument.	Check the parameter.		
7201	A system error occurred.	-		
7202	There is not enough memory.	-		
7203	Access is denied.	-		
7210	Drive is not ready.	Set the device.		
7211	The specified path is invalid.	Make sure the specified path exists.		
7212	The specified path already exists.	If the specified directory or file already exists, you cannot execute.		
7213	The file specified by path does not exist.	Make sure the specified file exists.		
7214	File size is too large.	Specify the file that is less than 2G bytes.		
7215	The specified file is open.	The specified file number is already existing. Use another file number.		
7216	The open mode is illegal.	Make sure you opened in reading or writing mode.		
7217	There is no read data.	Make sure there are data to read.		
7230	The specified connection is open.	The specified file number is already existing. Use another file number.		
7231	A connection-level error occurred while opening the connection.	Check the access right of database.		
7232	The connection is closed.	Use OpenDB and open the database.		
7233	An unsupported data type was used.	Convert the data into string or numeric value.		
7234	Data size is too large.	Too large data in a line. Specify the query so that necessary field are only retrieved.		
7235	The specified file type is not supported.	Check the type of Excel file.		
7236	There is no selected data.	Make sure the data you retrieved exists.		
7250	No bytes were available to read.	There are no retrieved data. Check the send program.		
7251	The port is in an invalid state.	Check the device setting for the specified port.		
7252	The specified port is open.	Check the port number to open.		
7253	The port is closed	Check the port number to close.		

Maintenance 9. Troubleshooting

No.	Message	Remedy	Note 1	Note 2
7254	The specified port is not open.	Check the port number to open.		
7255	Timeout reading from the port.	Check the port timeout period and update to the appropriate setting.		
7256	Timeout writing to the port.	Check the port timeout period and update to the appropriate setting.		
7260	The checksum in project file is invalid.	Rebuild the project.		
7261	Invalid function.	Check the function definition to call.		
7262	Invalid parameters.	Check the function definition to call.		
7263	Cannot execute while creating DLL.	-		
7264	Failed to create DLL.	-		
7265	DLL file cannot be found.	-		

No.	Message	Remedy	Note 1	Note 2
7300	Vision Communication. Server mode not supported.	-		
7302	Vision Communication. Failed to read from the camera.	Check the connection with the camera.		
7303	Vision Communication. Read data overflow.	Data exceeding the receive buffer was received.		
7304	Vision Communication. Failed to open the Ethernet port.	Check the connection with the camera.		
7305	Vision Communication. Invalid IP address of camera.	Rebuild the project. Check the camera configuration.		
7306	Vision Communication. No specification of Server or Client.	-		
7307	Vision Communication. Failed to send to the camera.	Check the connection with the camera.		
7308	Vision Communication. Camera version is old.	The version of the connected camera is old. Update the camera.		
7321	Vision Communication. Camera setting has not been set.	Rebuild the project. Check the camera configuration.		
7322	Vision Communication. Read timeout.	Check the connection with the camera.		
7323	Vision Communication. Read invalid data.	Check the connection with the camera.		
7324	Vision Communication. Failed to send to the camera.	Check the connection with the camera.		
7325	Vision Communication. Connection is not completed.	Check the connection with the camera.		
7326	Vision Communication. Read data is too long.	-		
7327	Vision Communication. Undefined vision sequence.	Check the sequence name.		
7328	Vision Communication. Camera setting has not been set.	Rebuild the project. Check the camera configuration.		
7329	Vision Communication. Vis file was not found.	Rebuild the project. Check the camera configuration.		
7330	Vision Communication. Failed to allocate memory.	Reduce the number of sequences, objects, and calibration.		
7341	Vision Communication. Out of max camera number.	Review the camera registration.		
7342	Vision Communication. Invalid camera number.	Review the camera registration.		
7343	Vision Communication. VSet parameter is too long.	Review the names and string variables of sequences, objects, and calibration.		
7344	Vision Communication: Too many parameters for VGet.	The number of specified variables is exceeding 32. Reduce the number of parameters.		
7345	Vision Communication. Not enough data for VGet statement variable assignment.	Reboot the camera. Check the version of the camera.		
7346	Vision Communication. Cannot execute a Vision statement from the command window.	Execute the command from the program.		
7400	Matrix determinate too small.	If specifying the virtual camera, specify the real camera.		
7402	Invalid value for maximum motion distance.	Specify the valid value.		

Maintenance 9. Troubleshooting

No.	Message	Remedy	Note 1	Note 2
7403	Invalid value for maximum pose difference angle.	Specify the valid value.		
7404	Invalid value for LJMMode.	Specify the valid value.		
7405	Command aborted by user.	—		
7406	Joint 1 angle change exceeded the maximum allowed during calibration.	Adjust the start angle of Joint 1.		
7407	Joint 2 angle change exceeded the maximum allowed during calibration.	Adjust the start angle of Joint 2.		
7408	Joint 4 angle change exceeded the maximum allowed during calibration.	Adjust the start angle of Joint 4.		
7409	Joint 6 angle change exceeded the maximum allowed during calibration.	Adjust the start angle of Joint 6.		
7410	Network camera. Timeout during image file transfer from PC.	Check the connection of PC and camera.		
7411	No upward camera sequence was specified for mobile calibration with upward reference.	Specify the existing sequence.		
7412	The specified upward camera sequence has no calibration.	Set the calibration for upward camera sequence.		
7413	The specified upward camera sequence calibration is not complete.	Complete the upward camera sequence calibration.		
7414	The target sequence cannot be used when RuntimeAcquire is Strobed.	Set the RuntimeAcquire of target sequence to Stationary.		
7415	Invalid calibration reference type.	Selectable ReferenceType is different depending on CameraOrientation. Select again.		
7416	Invalid calibration data. Teach the calibration points again.	Need to teach the calibration points again.		
7417	Invalid calibration setup.	Try to perform point teach of calibration again. Or check the target sequence.		
7418	Invalid calibration target sequence.	Target sequence may not be selected or camera number of the target sequence differs from that of calibration.		
7419	The target sequence camera is not the same as the calibration camera.	Set the sequence of the same camera.		
7420	The target sequence has no objects.	Add the detection object to target sequence.		
7421	Invalid last step for the target sequence.	Check the steps.		
7422	Exception occurred when search for the calibration target.	Check the target sequence.		
7423	Invalid number of results for calibration target sequence.	Create a sequence to detect results of required number of targets.		
7424	Cannot load the calibration points.	Perform calibration point teach again.		
7425	Invalid camera orientation.	Check the CameraOrientation of calibration.		
7426	Distortion correction calibration is incomplete.	Perform distortion correction if it is set.		
7427	Invalid vision object was specified.	Invalid vision object is specified in Vision Guide commands such as VSet and VGet. Specify the valid vision object.		

No.	Message	Remedy	Note 1	Note 2
7428	V and W coordinates must be zero for the type of robot used.	Set V and W of the Base to 0.		
7429	Invalid robot speed specified for the current operation.	Specify the valid value.		
7430	Invalid robot acceleration specified for the current operation.	Specify the valid value.		
7431	Invalid ShowWarning parameter value.	Specify the valid value.		
7432	Cannot create the object using the camera specified in the sequence.	Check the Vision object type. Update the camera firmware.		
7433	Invalid model data.	Re-teach the model or use a different model if the error occurred during	The model being loaded may not be compatible with the current version of CV or RC+.	
7434	Network camera. Invalid connection password.	Enter the correct Compact Vision connection password in the RC+ Camera page. If the password is unknown, you must do one of the following:		
7435	Network camera. Command cannot execute due to failed login.	a. Enter a new connection password from CV Monitor, then enter the same password in the RC+ Camera page. or b. Perform a factory reset on the Compact Vision unit to clear the password. Rebuild the current RC+ project and check operation.		
7500	Network camera. Out of memory.	Initialize the camera. Reduce the project size.		
7501	Network camera. Project does not exist.	Rebuild the project.		
7502	Network camera. Project has not been set.	Rebuild the project.		
7503	Network camera. Vision property or result not supported.	Update the camera firmware.		
7504	Network camera. Cannot open project file.	Rebuild the project.		
7505	Undefined vision sequence.	Check the sequence name. Rebuild the project.		
7506	Undefined vision object.	Check the object name. Rebuild the project.		
7507	Network camera. Critical error.	Initialize the camera. Rebuild the project.		
7508	Network camera. Invalid command.	Update the camera firmware.		
7509	Invalid vision property value.	Check the property value. Update the camera firmware.		
7510	Invalid vision property.	Check the property name. Update the camera firmware.		
7511	Vision model not trained.	Teach the model.		

No.	Message	Remedy	Note 1	Note 2
7512	Undefined vision calibration.	Check the calibration name. Rebuild the project.		
7513	Vision model object not Self.	Check the property value.		
7514	Invalid vision result.	Check the result name. Update the camera firmware.		
7515	Vision object not found.	Check the Found result before obtaining the result.		
7516	No vision calibration.	Check the calibration name.		
7517	Incomplete vision calibration.	Perform calibration.		
7518	Network camera. Cannot connect with camera.	Check the camera connection.		
7819	Network camera. Communication error.	Check the camera connection.		
7520	Window out of bounds.	Set the window within the bounds.		
7521	OCR font is invalid.	Register the OCR font.		
7522	The specified vision calibration already exists.	Change the calibration name. Delete the existing calibration in advance.		
7523	The specified vision sequence already exists.	Change the sequence name. Delete the existing sequence in advance.		
7524	The specified vision object already exists.	Change the object name. Delete the existing sequence in advance.		
7525	Cannot load vision project.	The project folder may be corrupt. Restore backup data.		
7526	Cannot save vision project.	The project folder may be write- protect. Check the access permission for the project folder.		
7527	Vision processor. Critical error.	Initialize the camera. Rebuild the project.		
7528	Image file not found.	Check the image file.		
7529	Camera does not exist.	Check the camera connection.		
7530	Acquisition failed.	Check the camera connection.		
7531	No objects to train.	Teach the model.		
7532	Cannot load image file.	Check the image file.		
7533	Camera is not supported by RC+7.0.	SC300/SC1200 is not supported by RC+7.0. Use CV1/CV2.		
7534	Camera firmware does not support new functions of RC+7.0.	Update the camera firmware.		
7535	Invalid data from network camera.	Initialize the camera.		
7536	Network camera export status failed	Initialize the camera.		
7537	Invalid ImageSize value. The specified value is not supported by the camera.	ImageSize exceeding the camera resolution cannot be specified. Correct the property value.		
7538	Invalid ZoomFactor. The specified value requires data outside of the image area.	Settable values are from 0.1 to 10.0. Correct the property value.		
7539	The camera does not support Code Reader.	Update the camera firmware.		
7540	The camera does not support OCR.	Update the camera firmware.		
7541	Insufficient data for teaching model.	Black or white image cannot be registered as a model.		

No.	Message	Remedy	Note 1	Note 2
7542	Model window cannot be outside of image.	Correct the position of the model window.		
7543	Calibration points have not been taught.	Teach the calibration point.		
7544	Calibration must be fixed upward.	Sequence with the calibration data of the upward fixed camera is only settable.		
7545	Point was not defined.	Teach the calibration point.		
7546	RobotPlacePos has not been calibrated.	Click CalRobotPlacePos and calibrate RobotPlacePos.		
7547	Camera IP address is out of current subnet.	Correct the camera IP address.		
7548	Camera was not detected.	Check the wiring of the camera.		
7549	Invalid Radius. Radius must be \geq RadiusInner and \leq RadiusOuter.	Correct the property value.		
7550	OCR character does not exist.	Register the OCR character.		
7551	OCR option is not active.	Enable the option.		
7572	Invalid sequence name.	Specify a name that begins with an alphabet. Alpha-numeral and under score () are available for the name.		
7573	Invalid calibration name.	Specify a name that begins with an alphabet. Alpha-numeral and under score () are available for the name.		
7574	Sequence or calibration name already exists.	Specify another calibration name.		
7575	Invalid camera.	Specify valid camera.		
7576	The vision target could not be found.	Check the vision sequence to detect the target		
7577	Failed to position the vision target within the specified tolerance.	Check the vision sequence to detect the target		
7578	No object with a search window was found in the sequence.	Add an object to detect the target in vision sequence.		
7579	Invalid initial rotation angle.	Specify the valid value.		
7580	Invalid final rotation angle.	Specify the valid value.		
7581	Invalid target tolerance.	Specify the valid value.		
7582	Invalid tool definition type.	Specify the valid value.		
7583	Invalid rotation angle.	Specify the valid value.		
7584	Invalid local definition type.	Specify the valid value.		
7585	Calibration plate detection failed.	Adjust the focus and exposure time of the lens to show the target clearly.		
7586	Focal length detection failed.	Narrow down a lens diaphragm.		
7587	Local definition scale detection failed.	Adjust the focus and exposure time of the lens to show the target clearly.		
7588	Calibration plate pose detection failed.	Adjust the focus and exposure time of the lens to show the target clearly.		
7589	Invalid object name.	Specify a name that begins with an alphabet. Alpha-numeral and under score () are available for the name.		
7590	Maximum move distance exceeded the limit set by VDefSetMotionRange.	Adjust the start position. Or set the limit value widely.		

Maintenance 9. Troubleshooting

No.	Message	Remedy	Note 1	Note 2
7591	Maximum pose difference angle exceeded the limit set by VDefSetMotionRange.	Adjust the start position. Or set the limit value widely.		
7592	Maximum joint angle difference exceeded the limit set by VDefSetMotionRange.	Adjust the start position. Or set the limit value widely.		
7596	Local definition rough camera alignment failed.	Adjust the start position.		
7597	Local definition plane could not be calculated.	Adjust the vision sequence to show the calibration plate clearly.		
7598	Calibration generates points move distance too small.	Make the search area bigger or the target smaller.		
7599	Calibration generate points camera to robot relation error.	If specifying the virtual camera, specify the real camera.		
7600	GUI Builder. Cannot execute a GUI Builder statement from the command window.	-		
7602	GUI Builder. GSet parameter is too long.	Correct the parameter to the proper length.		
7603	GUI Builder. Too many parameters for GGet.	Check the number of parameters.		
7604	GUI Builder. Not enough data for GGet statement variable assignment.	Specify the variable.		
7610	GUI Builder. The event task cannot be executed. System in pause state and EventTaskType is Normal.	The system can be operated by changing EventTaskType to "NoPause"		
7611	GUI Builder. The event task cannot be executed. Safeguard is open and EventTaskType is Normal.	The system can be operated by changing EventTaskType to "NoEmgAbort"		
7612	GUI Builder. The event task cannot be executed. Estop is active and EventTaskType is not NoEmgAbort.	The system can be operated by changing EventTaskType to "NoEmgAbort"		
7613	GUI Builder. The event task cannot be executed. System in error state and EventTaskType is not NoEmgAbort.	The system can be operated by changing EventTaskType to "NoEmgAbort"		
7650	GUI Builder. Invalid property.	Specify the valid property.		
7651	GUI Builder. Invalid form.	Specify the valid form.		
7652	GUI Builder. Invalid control.	Specify the valid control.		
7653	GUI Builder. The specified form is already open.	Modify the program to avoid double launch.		
7654	GUI Builder. Event function does not exist.	Check the function name set for the event.		
7655	GUI Builder. Item does not exist.	Specify the valid item.		
7656	GUI Builder. Invalid property value.	Check the property value and specify the valid value.		

No.	Message	Remedy	Note 1	Note 2
7700	Security. Invalid user.	Contact the administrator to register the user.		
7701	Security. Invalid password.	Check the password.		
7702	Security. Permission denied.	Contact the administrator to set authority.		
7703	Security. Option not active.	Register the options.		
7710	Source and destination cannot be the same.	Specify another destination.		
7711	Point file name is used by another robot.	Check the point file name.		
7712	Invalid axis specified.	Check whether the specified axis is valid. Check if the axis is specified correctly.		
7713	Option not enabled	Enable the option.		
7714	File not found.	Specify the correct file name.		
7715	Robot number is out of the available range.	Check the robot number.		
7716	Robot does not exist.	Check whether the robot is registered.		
7717	File Error. Invalid folder.	Check the folder name.		
7718	Cannot write the file.	Check the storage or the write authority.		
7719	Invalid USB option key license.	Enable the option by USB key for option license..		
7720	Part Feeding. There are no feeders in the system.	Check Setup System Configuration Controller Part Feeding page of the EPSON RC+.		
7730	The maximum number of robots per feeder has been exceeded.	When using the PartFeeding option, the maximum number of robots per feeder is 2. Review the robot settings of each part that is specified in the argument of the PF_Start command.		
7731	The maximum number of simultaneous feeders for the controller type has been exceeded.	The T/VT controller allows up to two feeders to be used at the same time. Check the code to make sure that no more than three feeders are in use (PF_Start has been executed no more than three times).		
7750	Simulator. Initialization failure.	Reboot RC+.		
7751	Simulator. Failed to save the objects.	Reboot RC+.		
7752	Simulator. Failed to load the objects.	Reboot RC+.		
7753	Simulator. Failed to mapping of memory.	Reboot RC+.		
7754	Simulator. The virtual controller already exists.	Name of the virtual controller may be duplicated. Check the controller name.		
7755	Simulator. Failed to create the virtual controller connection information.	Reboot RC+.		

Maintenance 9. Troubleshooting

No.	Message	Remedy	Note 1	Note 2
7756	Simulator. The copy source of the virtual controller does not exist.	Check the virtual controller name.		
7757	Simulator. The copy destination of the virtual controller already exists.	Name of the virtual controller may be duplicated. Check the controller name.		
7758	Simulator. Failed to copy the virtual controller connection information.	Reboot RC+.		
7759	Simulator. Failed to delete the virtual controller connection information.	Reboot RC+.		
7760	Simulator. Failed to delete the controller connection information.	Reboot RC+.		
7761	Simulator. Failed to rename the controller connection information.	Check the virtual controller name.		
7762	Simulator. The rename source of the virtual controller does not exist.	Check the virtual controller name.		
7763	Simulator. The rename destination of the virtual controller already exists.	Check the virtual controller name.		
7764	Simulator. Invalid Robot number.	Reboot RC+.		
7765	Simulator. Failed to read the Robot definition file.	Check if the definition file exists.		
7766	Simulator. Failed to copy the layout objects.	Reboot RC+.		
7767	Simulator. Failed to cut the layout objects.	Reboot RC+.		
7768	Simulator. Failed to paste the layout objects.	Reboot RC+.		
7769	Simulator. Failed to remove the Robot.	Reboot RC+.		
7773	Simulator. Robot or Object was not specified.	Specify Robot or Object.		
7774	Simulator. Duplicated Robot name or Object name.	Change the Robot name or Object name so that it does not duplicate.		
7775	Simulator. Could not find Robot.	Check whether the Robot is set or check the Robot name.		
7776	Simulator. Could not find Object.	Check whether the Object is set or check the Object name.		
7777	Simulator. Could not find Hand.	Check whether the Hand is set or check the Hand name.		
7778	Simulator. The specified object is already registered as a Part object.	Unregister the Part.		
7779	Simulator. The specified object is not Part object	Specify the object set for the Part.		
7780	Simulator. Could not find the specified Tool.	Specify the set Tool.		
7781	Simulator. Child object can not be picked.	Change to parent object.		
7782	Simulator. Parent objects can not be specified for Part, Mounted Device, or Mobile Camera	Unregister as Part, Mounted Device or Mobile Camera.		
7783	Simulator. Robot can not be specified.	Specify an Object other than Robot.		

No.	Message	Remedy	Note 1	Note 2
7784	Simulator. The same object can not be specified as a parent object.	Specify another object.		
7785	Simulator. Child object can not be specified as parent object.	Change to parent object.		
7786	Simulator. The specified object is already registered as a parent object.	Specify another object.		
7787	Simulator. Specified value is invalid.	Check the set value.		
7788	Simulator. Specified variable type is invalid.	Check the variable type.		
7789	Simulator. Object can not be specified.	Specify the Robot.		
7790	Simulator. Hand can not be specified.	Specify an object other than Hand.		
7791	Simulator. Camera can not be specified.	Specify an object other than Camera.		
7800	Data cannot be changed, because it is not data of PG axis.	-		
7801	Invalid joint number was specified.	-		
7802	The robot type is invalid.	-		
7803	The parameter is invalid.	-		
7804	The robot number is invalid.	-		
7805	MCD failure. Failed to open the MCD file.	Restore the controller configuration.		
7806	MCD failure. Failed to read the MCD file.	Restore the controller configuration.		
7807	MCD failure. Failed to save the MCD file.	Restore the controller configuration.		
7808	MCD failure. Failed to create the MCD file.	Restore the controller configuration.		
7809	MCD failure. Failed to write the MCD file.	Restore the controller configuration.		
7810	MPL failure. Failed to open the MPL file.	Reinstall the firmware.		
7811	MPL failure. Failed to read the MPL file.	Update the firmware.		
7812	MPL failure. Failed to write the MPL file.	1. Reboot the controller. 2. Reinstall the firmware.		
7815	IFS failure. Failed to open the IFS file.	Restore the controller configuration.		
7816	IFS failure. Failed to read the IFS file.	Restore the controller configuration.		
7817	IFS failure. Failed to write the IFS file.	Restore the controller configuration.		
7822	MTR failure. Failed to read the MTR file.	1. Reboot the controller. 2. Reinstall the MT.		
7824	MTR failure. Failed to save the MTR file.	Reboot the controller.		
7825	PRM failure. Failed to create the PRM file.	Restore the controller configuration.		
7827	PRM failure. Failed to read the PRM file.	Restore the controller configuration.		
7829	PRM failure. Failed to save the PRM file.	Restore the controller configuration.		
7830	File failure. Cannot access the file.	1. Reboot the controller. 2. Reinstall the firmware.		

Maintenance 9. Troubleshooting

No.	Message	Remedy	Note 1	Note 2
7831	The motor type is invalid.	Check the motor amplifier.		
7840	MCD failure. Area allocate error.	Reboot the controller.		
7845	FGI failure. Failed to open the FGI file.	Reboot the controller. Reinstall the firmware.	-	-
7847	MDL failure. Failed to open the MDL file.	Reboot the controller. Reinstall the firmware.	-	-
7848	MDL failure. Failed to read the MDL file.	Reboot the controller. Reinstall the latest firmware version.	-	-
7900	Fieldbus not installed.	-		
7901	Fieldbus invalid parameter.	-		
7902	Fieldbus line defect.	Check the connection of the communication cable for the fieldbus. Check whether the communication cable for the fieldbus is powered. (if the fieldbus requires power supply) Check the connection of the fieldbus slave.		
7903	Fieldbus device not configured.	Check that the fieldbus master board is installed. Reboot the computer where the fieldbus master board is installed. Replace the fieldbus master board.		
7904	Fieldbus invalid board.	Check that the fieldbus master board is installed. Reboot the computer where the fieldbus master board is installed. Replace the fieldbus master board.		
7905	Fieldbus connection denied.	-		
7906	Fieldbus invalid device configuration.	Check that the fieldbus master board is installed. Reboot the computer where the fieldbus master board is installed. Replace the fieldbus master board.		
7907	Fieldbus general error.	Check that the fieldbus master board is installed. Reboot the computer where the fieldbus master board is installed. Replace the fieldbus master board.		
7908	Fieldbus configuration error.	Check the fieldbus master setting.		
7909	Fieldbus slaves were not detected.	Register the slave to the fieldbus master by accompanying applicomIO Console application.		
7910	Fieldbus configuration file not found.	Import the Fieldbus configuration file as described in the Fieldbus I/O manual.		
7911	Fieldbus invalid configuration file.	Import the Fieldbus configuration file as described in the Fieldbus I/O manual. If the problem persists, contact Epson.		
7912	Fieldbus invalid device ID.	An invalid device ID parameter was used. Check your program.		

No.	Message	Remedy	Note 1	Note 2
7913	Fieldbus invalid service was specified.	An invalid explicit messaging service number was used. Check your program.		
7914	Fieldbus cannot open master board driver.	Check that the Fieldbus master board is installed correctly. Check that the drivers for the Fieldbus master board were installed correctly.		
7915	Fieldbus cannot open master board channel.	Check that no other application is using the Fieldbus master board. Check that the correct firmware is installed (downloaded) on the board.		
7916	Fieldbus host ready timeout.	Check that the drivers for the Fieldbus master board were installed correctly. Reboot and try again. Replace the board.		
7917	Fieldbus bus communication timeout.	Check the bus power and slave connections.		
7950	Force sensing. Invalid force sensor.	-		
7951	Force sensing. Invalid force sensor axis.	-		
7952	Force sensing. Sensor read failed.	-		
7953	Force sensing. Sensor initialization failed.	-		
7954	Force sensing. Sensor not initialized.	-		
7955	Force sensing. Force or torque exceeded saturation level.	-		
7975	Force Guide. Value out of range.	-		
7976	Force Guide. Invalid property value.	-		
7977	Force Guide. No robot is using an Epson force sensor.	Check Setup System Configuration Controller Force Sensing Force Sensor I/F page of the EPSON RC+.		

No.	Message	Remedy	Note 1	Note 2
9001	Emergency stop circuit failure was detected. Disconnection or other failure was found in one of the redundant inputs.	Check whether no disconnection, earth fault, or short-circuit of the emergency stop input signal exists. Then reboot the controller.		
9002	Safeguard circuit failure was detected. Disconnection or other failure was found in one of the redundant inputs.	Check whether no disconnection, earth fault, or short-circuit of the safeguard input signal exists. Then reboot the controller.		
9003	Initialization failure. Failed to initialize the firmware.	This is likely because of the controller hardware failure. Check the wiring is correct. If the error is not cleared after the controller is rebooted, contact us.		
9004	Initialization failure. Failed to initialize the DU. Check the DU power and the connection.	The number of set Drive Unit(s) disagrees with the number of recognized Drive Unit(s). Check the wirings of power supply and between Control Unit and Drive Unit are correct. If the error is not cleared after the controller is rebooted, contact us.		
9005	Initialization failure. Failed to initialize the DU. Check the connection.	This is likely because of the Drive Unit hardware failure. Check the wiring is correct. If the error is not cleared after the controller is rebooted, contact us.		
9006	Initialization failure. Failed to initialize the Remote I/O. Check the Remote I/O setting.	Check the Remote I/O setting value		
9007	Error of Force Sensor occurs. Note 1: Each error code See each error code to take a relevant countermeasure.	Error of Force Sensor has occurred. Please confirm Note 1 by the system history, and take a relevant countermeasure.	Each error code	
9011	Battery voltage of the CPU board backup is lower than the specified voltage. Replace the CPU board battery.	Replace the battery for the CPU board immediately. Keep the controller ON as long as possible until the battery is replaced.	100 times of current value	100 times of boundary value
9012	5V input voltage for CPU board is lower than the specified voltage.	If normal voltage is not generated by 5V power supply alone, replace the power supply.	100 times of current value	100 times of boundary value
9013	24 V input voltage for the motor brake, encoder and fan is lower than the specified voltage.	If normal voltage is not generated by 24V power supply alone, replace the power supply.	100 times of current value	100 times of boundary value
9014	Internal temperature of the Controller is higher than the specified temperature.	Stop the controller as soon as possible and check whether the ambient temperature of the controller is not high. Check whether the filter is not clogged up.	100 times of current value	100 times of boundary value
9015	Speed of the controller fan is below the specified speed. (FAN1)	Check whether the filter of the controller is not clogged up. Replace the fan.	Current value	Boundary value

No.	Message	Remedy	Note 1	Note 2
9016	Speed of the controller fan is below the specified speed. (FAN2)	Check whether the filter of the controller is not clogged up. Replace the fan.	Current value	Boundary value
9017	Internal temperature of the Controller is higher than the specified temperature.	Stop the controller as soon as possible and check whether the ambient temperature of the controller is not high. Check whether the filter is not clogged up.	100 times of current value	100 times of boundary value
9018	54V input voltage for CPU board is lower than the specified voltage.	If normal voltage is not generated by 54V power supply alone, replace the power supply.	100 times of current value	100 times of boundary value
9019	3.3V input voltage for CPU board is lower than the specified voltage.	If normal voltage is not generated by 3.3V power supply alone, replace the power supply.	100 times of current value	100 times of boundary value
9020	DC input voltage for CPU board is lower than or bigger than the specified voltage.	If normal voltage is not generated by DC power supply alone, replace the power supply.	100 times of current value	100 times of boundary value
9021	DU1 3.3V input voltage for the board is lower than the minimum allowed voltage.	If normal voltage is not generated by 3.3V of Drive Unit 1 power supply alone, replace the power supply.		
9022	DU1 5V input voltage for the board is lower than the minimum allowed voltage.	If normal voltage is not generated by 5V of Drive Unit 1 power supply alone, replace the power supply.		
9023	DU1 24 V input voltage for the motor brake, encoder and fan is lower than the specified voltage.	If normal voltage is not generated by 24V of Drive Unit 1 power supply alone, replace the power supply.		
9024	DU1 Internal temperature of the Controller is higher than the allowed temperature.	Stop the Drive Unit 1 as soon as possible and check whether the ambient temperature of the controller is not high. Check whether the filter is not clogged up.		
9025	DU1 Rotating speed of the controller fan is below the allowed speed. (FAN1)	Check whether the filter of the Drive Unit 1 is not clogged up. Replace the fan.		
9026	DU1 Rotating speed of the controller fan is below the allowed speed. (FAN2)	Check whether the filter of the Drive Unit 1 is not clogged up. Replace the fan.		
9031	DU2 3.3V input voltage for the board is lower than the minimum allowed voltage.	If normal voltage is not generated by 3.3V of Drive Unit 2 power supply alone, replace the power supply.		
9032	DU2 5V input voltage for the board is lower than the minimum allowed voltage.	If normal voltage is not generated by 5V of Drive Unit 2 power supply alone, replace the power supply.		
9033	DU2 24 V input voltage for the motor brake, encoder and fan is lower than the specified voltage.	If normal voltage is not generated by 24V of Drive Unit 2 power supply alone, replace the power supply.		

No.	Message	Remedy	Note 1	Note 2
9034	DU2 Internal temperature of the Controller is higher than the allowed temperature.	Stop the Drive Unit 2 as soon as possible and check whether the ambient temperature of the controller is not high. Check whether the filter is not clogged up.		
9035	DU2 Rotating speed of the controller fan is below the allowed speed. (FAN1)	Check whether the filter of the Drive Unit 2 is not clogged up. Replace the fan.		
9036	DU2 Rotating speed of the controller fan is below the allowed speed. (FAN2)	Check whether the filter of the Drive Unit 2 is not clogged up. Replace the fan.		
9041	DU3 3.3V input voltage for the board is lower than the minimum allowed voltage.	If normal voltage is not generated by 3.3V of Drive Unit 3 power supply alone, replace the power supply.		
9042	DU3 5V input voltage for the board is lower than the minimum allowed voltage.	If normal voltage is not generated by 5V of Drive Unit 3 power supply alone, replace the power supply.		
9043	DU3 24 V input voltage for the motor brake, encoder and fan is lower than the specified voltage.	If normal voltage is not generated by 24V of Drive Unit 3 power supply alone, replace the power supply.		
9044	DU3 Internal temperature of the Controller is higher than the allowed temperature.	Stop the Drive Unit 3 as soon as possible and check whether the ambient temperature of the controller is not high. Check whether the filter is not clogged up.		
9045	DU3 Rotating speed of the controller fan is below the allowed speed. (FAN1)	Check whether the filter of the Drive Unit 3 is not clogged up. Replace the fan.		
9046	DU3 Rotating speed of the controller fan is below the allowed speed. (FAN2)	Check whether the filter of the Drive Unit 3 is not clogged up. Replace the fan.		
9100	Initialization failure. Failed to allocate memory.	Reboot the controller.		
9101	Message queue has become full.	-		
9102	Initialization failure. Failed to initialize Modbus.	(When RTU is selected) Check whether the selected port is installed. (When TCP is selected) Check whether the selected port number is used by other		
9103	Initialization failure. Failed to initialize the user output.	If the manipulator is specified, check whether the specified manipulator is registered.		
9104	Remote User Output failure. Specified command cannot be executed.	Check the condition expression.		
9233	The Fieldbus I/O driver is in an abnormal state.	The module is broken or the controller software is damaged. Restore the controller firmware.		
9234	Fieldbus I/O driver initialization failure.	The module is broken or the controller software is damaged. Restore the controller firmware.		

No.	Message	Remedy	Note 1	Note 2
9610	RAS circuit detected a servo system malfunction. Reboot the controller. Check for noise. Replace the controller.	Check the noise countermeasures. Replace the DMB.		
9611	Servo CPU internal RAM failure. Reboot the controller. Check for noise. Replace the DMB.	Check the noise countermeasures. Replace the DMB.		
9612	RAM for the main and servo CPU communication failure. Reboot the controller. Check for noise. Replace the DMB.	Check the noise countermeasures. Replace the DMB.		
9613	Servo CPU internal RAM failure. Reboot the controller. Check for noise. Replace the DMB.	Reboot the controller. Check the noise countermeasures. Replace the DMB. For T series, it is not DMB but CPU board.		
9614	Initialization communication of main CPU and servo CPU failure. Reboot the Controller. Check for noise. Replace DMB.	Reboot the controller. Check the noise countermeasures. Replace the DMB. For T series, it is not DMB but CPU board.		
9615	Initialization communication of the main and servo CPU failure. Reboot the controller. Check for noise. Replace the DMB.	Check the noise countermeasures. Replace the DMB.		
9616	Communication of the main and servo CPU failure. Reboot the controller. Check for noise. Replace the DMB.	Reboot the controller. Check the noise countermeasures. Replace the DMB. For T series, it is not DMB but CPU board.		
9617	Communication of the main and servo CPU failure. Reboot the controller. Check for noise. Replace the DMB.	Reboot the controller. Check the noise countermeasures. Replace the DMB. For T series, it is not DMB but CPU board.		
9618	Servo long time command overrun.	Check the noise countermeasures. Replace the DMB.		
9619	Servo long time command check sum error.	Check the noise countermeasures. Replace the DMB.		
9620	System watchdog timer detected a failure. Reboot the controller. Check for noise. Replace the DMB.	Reboot the controller. Check the noise countermeasures. Replace the DMB. For T series, it is not DMB but CPU board.		
9621	Drive unit check failure.	Check the noise countermeasures. Replace the DMB.		
9622	RAM failure of the servo CPU. Reboot the controller. Check for noise. Replace the DMB.	Check the noise countermeasures. Replace the DMB.		
9623	Failure of the redundant circuitry for the emergency stop or the safeguard. Check the wiring.	Check the noise countermeasures. Replace the DMB.		

No.	Message	Remedy	Note 1	Note 2
9624	Low voltage of the main circuit power supply was detected. Check the power supply voltage. Reboot the controller.	Check the noise countermeasures. Replace the DMB.		
9625	Control relay contact of the main circuit power supply is welded closed. Replace the DPB.	Replace the DMB.		
9626	Detect the recognition mismatch of the sub CPU and main CPU.	Reboot the controller, take the measure against noise, or replace the CPU board.		
9627	Temperature of regeneration resistor was higher than the specified temperature.	Specify the Weight/Inertia setting. Check the load. Check the robot. (Smoothness, backlash, non-smooth motion, loose belt tension, brake) Check the interference with the peripheral equipment. (Collision, contact) Check the model setting. Check the power cable connection.		
9628	Over voltage of the sub CPU.	Replace the DPB board.		
9630	Servo real time status failure. Check sum error.	Reboot the controller. Replace the DMB. Check the noise countermeasures.		
9632	Servo real time status failure. Servo free running counter error	Reboot the controller. Replace the DMB. Check the noise countermeasures.		
9633	Servo real time status failure. Servo CPU communication error.	Reboot the controller. Replace the DMB. Check the noise countermeasures.		
9640	Irregular motion control interruption was detected. Interruption duplicate.	Reboot the controller. Replace the DMB. Check the noise countermeasures.		
9691	Data sending failure in motion network.	Check the connection of the cable for Drive Unit.		
9692	Data receiving failure in motion network.	Check the connection of the cable for Drive Unit.		
9697	Data sending failure of Force Sensor I/F board. Check connection of the Force Sensor I/F board and Force Sensor.	Check connection of the Force Sensor I/F board and Force Sensor. Reboot the controller. Please inquire with us if a similar error occurs even after the above countermeasures are taken.		
9698	Data receiving failure of Force Sensor I/F board. Check connection of the Force Sensor I/F board and Force Sensor.	Check connection of the Force Sensor I/F board and Force Sensor. Reboot the controller. Please inquire with us if a similar error occurs even after the above countermeasures are taken.		

No.	Message	Remedy	Note 1	Note 2
9700	Servo control gate array failure. Check the DMB.	Check the short-circuit and improper connection of the peripheral equipment wiring. (Emergency and I/O connectors) Replace the DMB. Replace the additional axis unit. For T series, reboot the controller, take the measure against noise, and replace the CPU board and motor unit.		
9701	Disconnection of the parallel encoder signal. Check the signal cable connection or the robot internal wiring.	Check the M/C cable signal. Check the robot signal wiring. (Missing pin, disconnection, short-circuit) Replace the motor. (Encoder failure) Replace the DMB. (Detection circuit failure) Check the connector connection in the controller. (Loosening, connecting to the serial encoder terminal on the DMB) Check the model setting. (Improperly setting of the parallel encoder) Check the peripheral equipment wiring. (Emergency and I/O) For T series, reboot the controller, take the measure against noise, and replace the motor unit.		
9702	Motor driver is not installed. Install the motor driver. Check the DMB or the motor driver.	Check whether the motor driver is mounted. Check the model setting and hardware setting. Replace the motor driver. Replace the DMB. For T series, check the wiring of the motor unit.		
9703	Initialization communication failure of incremental encoder. Check the signal cable connection and the robot setting.	Check the model setting. Replace the motor. (Encoder failure) Replace the DMB. For T series, reboot the controller, take the measure against noise, and replace the CPU board and motor unit.		
9704	Initialization failure of absolute encoder. Check the signal cable connection or the robot setting.	Check the model setting. Replace the motor. (Encoder failure) Replace the DMB. For T series, reboot the controller, take the measure against noise, and replace the motor unit.		
9705	Encoder division setting failure. Check the robot setting.	Check the model setting.		

Maintenance 9. Troubleshooting

No.	Message	Remedy	Note 1	Note 2
9706	Data failure at the absolute encoder initialization. Check the signal cable connection, the controller, or the motor.	Replace the motor. (Encoder failure) Replace the DMB. Check the noise countermeasures. For T series, reboot the controller, take the measure against noise, and replace the motor unit.		
9707	Absolute encoder multi-turn is beyond the maximum range. Reset the encoder.	Reset the encoder. Replace the motor. (Encoder failure)		
9708	Position is out of the range. Reset the encoder.	Reset the encoder. Replace the DMB. Replace the motor. (Encoder failure)		
9709	No response from the serial encoder. Check the signal cable connection, the motor, the DMB, or the encoder IF board.	Check the model setting. (Improperly setting of the parallel encoder model) Check the signal cable connection. Replace the DMB and encoder I/F board.		
9710	Serial encoder initialization failure. Reboot the controller. Check the motor, the DMB, or the encoder IF board.	Check the robot configuration. Check the signal cable. Replace the DMB and encoder I/F board. For T series, reboot the controller, take the measure against noise, and replace the motor unit.		
9711	Serial encoder communication failure. Reboot the controller. Check the motor, the DMB, or the encoder IF board.	Check the robot configuration. Check the signal cable. Replace the DMB and encoder I/F board. For T series, reboot the controller, take the measure against noise, and replace the motor unit.		
9712	Servo CPU watchdog timer failure. Reboot the controller. Check the motor or the DMB.	Replace the DMB. Check the noise countermeasures. For T series, check the connection of the signal cable. Reboot the controller, take the measure against noise, and replace the motor unit.		
9713	Current control circuit WDT failure. Reboot the controller. Check the controller.	Check the power cable connection. Check the 15V power supply and cable connection. Replace the DMB. Check the noise countermeasures. For T series, reboot the controller, take the measure against noise, and replace the motor unit.		
9714	The DMB is not for this robot.	Check robot setting. Replace with the supported DMB.		
9715	Encoder is reset. Reboot the controller.	Reboot the controller.		

No.	Message	Remedy	Note 1	Note 2
9716	Power supply failure of the absolute encoder. Replace the battery to a new one. Check the robot internal wiring.	Reset the encoder. Check the signal cable connection.		
9717	Backup data failure of the absolute encoder. Reset the encoder.	Reset the encoder. Check the signal cable connection.		
9718	Absolute encoder battery alarm.	Replace the battery. Check the signal cable connection.		
9719	Position failure of the absolute encoder. Reset the encoder. Replace the motor.	Reset the encoder. Replace the motor. (Encoder failure) For T series, reboot the controller, take the measure against noise, and replace the motor unit.		
9720	Speed is too high at controller power ON. Stop the robot and reboot the controller.	Reboot the controller. Reset the encoder. For T series, reboot the controller, take the measure against noise, and replace the motor unit. Check the interference with the other devices.		
9721	Absolute encoder over heat.	Lower the motion duty. Wait until the temperature of the encoder decreases.		
9722	R/D transducer failure. Reset the encoder. Check resolver board or the robot internal wiring.	Resets the encoder. Check the signal wiring of the manipulator (loose pin, disconnection, short). Replace the resolver board.		
9723	G sensor communication failure. Check the signal cable connection or the robot internal wiring.	Check for the signal cable connection. Check the signal wiring of the manipulator (loose pin, disconnection, short). Check the noise countermeasure. Replace the control board. Replace the DMB.		
9724	G sensor data error. Check for the control board.	Replace the control board.		
9725	The multi rotational data and the R/D conversion data is different. Reset the encoder.	Reset the resolver Check the noise countermeasure. Replace the resolver board.		
9726	Disconnection of the resolver excitation signal. Reset the encoder. Check the resolver board or the robot internal wiring.	Check the signal wiring of the manipulator (loose pin, disconnection, short). Replace the resolver board.		
9727	S-DSP communication failure. Check the DMB.	Reboot the Controller. Check the noise countermeasure. Replace the DMB.		

No.	Message	Remedy	Note 1	Note 2
9728	Current feedback data failure. Check the DMB.	Reboot the Controller. Check the noise countermeasure. Replace the DMB. For T series, check the short-circuit and earth fault of the power cable. Reboot the controller or replace the motor unit.		
9729	D-DSP communication failure. Check the DMB.	Reboot the Controller. Check the noise countermeasure. Replace the DMB.		
9730	Speed is too high at controller power OFF. Reset the encoder.	Reset the encoder. Replace the motor.		
9731	Speed is too high. Reset the encoder.	Reset the encoder. Replace the motor. For T series, reboot the controller and replace the motor unit.		
9732	Servo alarm A.	-		

No.	Message	Remedy	Note 1	Note 2
10000	Command aborted by user	-		
10001	Command timeout.	-		
10002	Bad point file line syntax	-		
10003	Project could not be built.	-		
10004	Cannot initialize Spel class instance.	-		
10005	Cannot initialize parser.	-		
10006	Cannot initialize wbproxy.	-		
10007	Project does not exist.	Check whether the project name and the path are correct.		
10008	No project specified.	Specify the project.		
10009	Cannot open file.	Check whether the project name and the path are correct.		
10010	Cannot create file.	-		
10011	File not found	Check whether the project name and the path are correct.		
10013	Cannot execute LoadPoints with Robot Manager open.	Close the robot manager and execute.		
10014	Project cannot be locked. It is being used by another session.	Terminate other applications.		
10015	Project could not be synchronized.	-		
10016	Drive not ready	Check whether the drive designation is correct.		
10017	Invalid IP address	Check the IP address.		
10018	Invalid IP mask	Check the IP mask.		
10019	Invalid IP gateway	Check the IP gateway.		
10020	IP address or gateway cannot be the subnet address.	Check the IP address.		
10021	IP address or gateway cannot be the broadcast address.	Check the IP address.		
10022	Invalid DNS address	Check the DNS.		
10023	Commands cannot be executed because the project build is not complete.	Execute after the project build is completed.		
10024	Invalid task name.	Check the task name.		
10100	Command already in cycle.	-		
10101	Command aborted by user.	Execute ResetAbort.		
10102	Invalid server instance.	Specify the correct instance.		
10103	Invalid CommandTask value.	Specify the correct task number.		
10104	Cannot change ServerInstance after initialized.	Set ServerInstance before initialization.		
10105	Invalid data.	Review the data in TaskInfo method in RC+ API.		
10106	Cannot proceed while a dialog is being displayed.	Check whether the Rundialog method or TeachPoint method is being executed while the Rundialog method or TeachPoint method is being executed in RC+ API.		
10250	AOI. Command execution timeout.	Check the connection with PLC.		
10251	AOI. Cannot execute the command. ExtError is high or ExtCmdReset is low.	Check ExtError bit and ExtCmdReset bit.		
10252	AOI Invalid configuration detected.	Review the configuration.		
10501	Connection aborted.	-		

Maintenance 9. Troubleshooting

No.	Message	Remedy	Note 1	Note 2
10502	Cannot connect with the controller.	-		
10503	Controller firmware is not compatible with this version of RC+.	Upgrade the RC+ version.		
10504	USB connection of this system is reserved for the RC620 Controller and cannot be used for RC+7.0.	Install the RC+7.0 to another computer.		
10505	The specified connection does not exist.	Check the connection number.		
10600	Frame grabber driver not installed.	Install the driver.		

9.2 Cannot Connect the Development PC and the Controller using the USB cable



CAUTION

- Do not connect the USB cable to a PC or a Controller without installing Program Development Software EPSON RC+ 7.0 to the PC.
You must install EPSON RC+ 7.0 to control the Controller.
If the USB cable is connected to a PC or a Controller without installing Program Development Software EPSON RC+ 7.0, the [Add New Hardware] wizard appears. Click the <Cancel> button to close the [Add New Hardware] wizard.

- If the following error message appears when connecting the development PC and Controller with the USB cable and connecting the Controller to EPSON RC+ 7.0, Windows may not recognize the Controller properly. Refer to *Maintenance 9.2.1 Confirmation Using Windows Device Manager* to check the connection of the Controller.

“Cannot connect to controller

!! Error: 1805, Connection Failure. Check the controller startup and connection of the communication cable.”

9.2.1 Confirmation Using Windows Device Manager

(1) Make sure that the development PC and the Controller is connected to the USB cable.

NOTE
☞

When checking the Controller connection using the Windows device manager, the development PC and the Controller must be connected with the USB cable.

(2) Open Control Panel and click [Hardware and Sound].

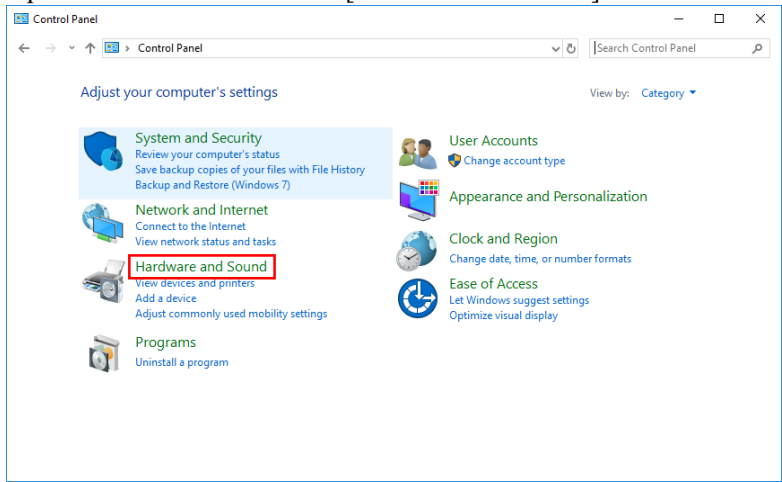

(3) The [Hardware and Sound] dialog appears.
Click <Device Manager>.

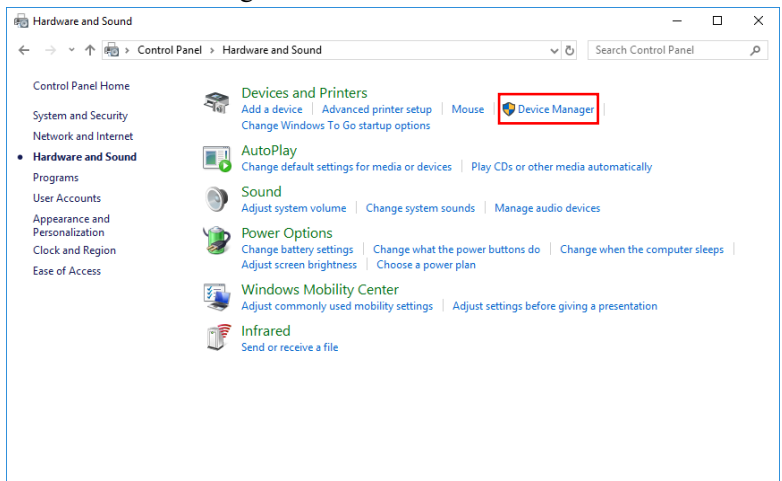

(4) The [Device Manager] dialog appears.

Click <Universal Serial Bus controllers> and make sure that “EPSON Robot Controller” is registered.

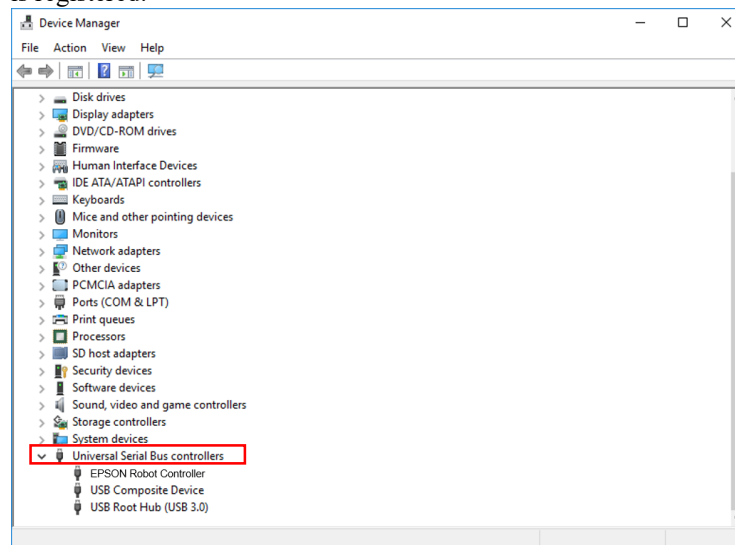

When “EPSON Robot Controller” is registered and located under “Universal Serial Bus controllers” as shown above, the development PC and the Controller connect properly.

If the following error message appears, please contact the supplier of your region.

“Cannot connect to controller.

!! Error: 1805, Connection failure, check the controller startup and connection of the communication cable.”

If “EPSON Robot Controller” is not located under “Universal Serial Bus controllers” but located under “Other devices” in step (4), refer to *Maintenance 9.2.2 When recognized under “Other devices” in Windows Device Manager.*

9.2.2 When recognized under “Other devices” in Windows Device Manager

If “EPSON Robot Controller” is recognized under “Other devices” in the Windows device manager as shown in the following dialog, delete “EPSON Robot Controller” from the device manager and connect the USB cable again to correct the problem.

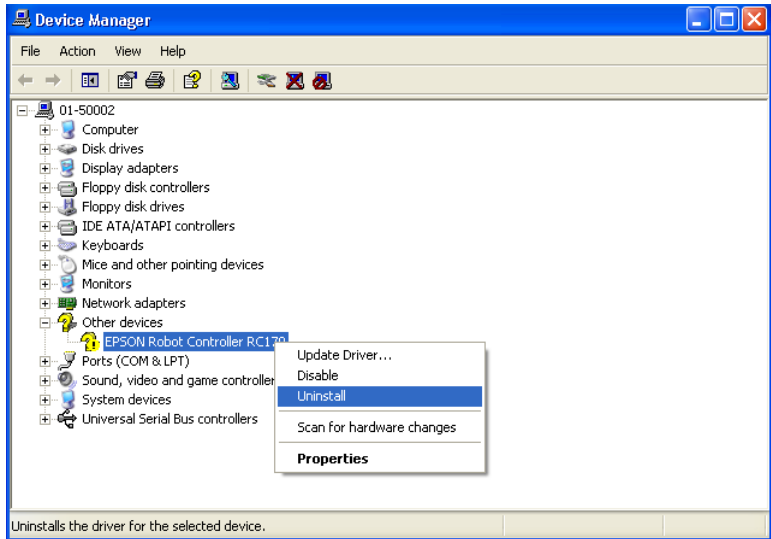

- (1) Select and right click “EPSON Robot Controller” in the [Device Manager] dialog.
- (2) Select [Uninstall].
- (3) The [Uninstall Device] dialog appears.
Click the <Uninstall> button.

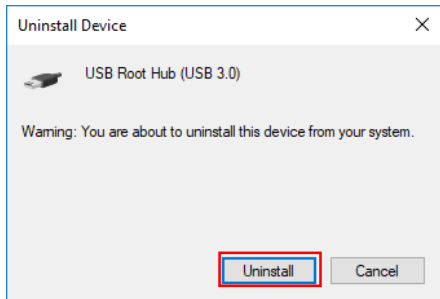

- (4) Remove the USB cable and connect the USB cable again.
The message, “Install EPSON Robot Controller”, will be displayed at the bottom right of the window screen.
- (5) Controller is installed automatically.
When the message, “EPSON Robot Controller is installed and ready to use.”, is displayed at the bottom right of the window screen, communication is available.

NOTE



If the problem is not corrected, please contact the supplier of your region.

10. Maintenance Parts List

Part Name		Code	Old Code	Note
Fan		2157260	R13B060510	
Fan Filter		1596688	R13N865021	Black (While stock lasts)
		2195106	–	White
Battery		2113554	R13B060003	
Motor Driver	5A/5A	2176557	–	See the table below for motor selection
	10A/10A	2172039	R13N874011	
		2195537	–	
	15A/5A	2188815	–	
	15A/15A	2171247	R13N874021	
	15A/15A-2	2168582	–	
		2194709	–	
	30A/5A	2188814	–	
30A/30A	2171456	R13NZ90002		
50A/30A	2205668	–		

Motor driver (** A / ** A)

Controller	Manipulator	Joint #1, #2	Joint #3, #4	Joint #5, #6	Remarks
RC700	C4	15A/15A	10A/10A		MDB type
		2171247	2172039		Code
		R13N874021	R13N874011		Old Code
RC700-A	C4 C12	15A/15A-2	10A/10A		MDB type
		2194709	2195537		Code
	C8	50A/30A	15A/15A-2	10A/10A	MDB type
		2205668	2194709	2195537	Code
	N2	5A/5A			MDB type
		2176557			Code
	N6	30A/5A	15A/5A	30A/5A	MDB type
		2188814	2188815	2188814	Code

Controller	Manipulator	Joint #1, #2	Joint #3, #4	Remarks	
RC700-A	G1 G3	10A/10A		MDB type	
		2172039		Code	
		R13N874011		Old Code	
	G6 RS X5	15A/15A-2	10A/10A		MDB type
		2168582	2172039		Code
		–	R13N874011		Old Code
	G10 G20	30A/30A	15A/15A-2		MDB type
		2171456	2168582		Code
		R13NZ90002	–		Old Code

The code of the following parts differs depending on the Controller.
 Also, the code of RC700-A differs depending on the serial number (Note: R7*****).
 If you need the parts, please confirm the Controller type and serial number before contact us.

Part Name		Code	Old Code	Note	
For RC700	DMB-MAIN	2180932	–		
	DMB-SUB	2151349	R13N842021		
	DMB-LED	2151351	R13N842031		
	DPB	2171246	R13N844011		
	TP Bypass Plug	2111451	R13B060705		
	CF (Compact Flash)	1605920	R13N8B6011		
For RC700-A	DMB-MAIN	C series G series RS series	2182346	–	R7**00**** R7**01**** R7**02****
		N series X5 series	2189444	–	R7**03**** or later
	DMB-SUB	C, N series	2171261	–	
		G, RS series	2171816	–	
		X5 series	2184586	–	
	DMB-LED		2171262	–	
	DPB		2171263	–	
	TP Bypass Plug		2171258	–	
	CF(Compact Flash)		1605920	R13N8B6011	R7**00**** R7**01**** R7**02****
			2195736	–	R7**03**** or later

11. Option Parts List

Part Name	Code	Old Code	Note
Expansion I/O Board (Source type)	R12NZ9003P	R12B040302	
Expansion I/O Board (Sink type)	R12NZ9003Q	R12B040303	
RS-232C Board	R12NZ9004E	R12B040726	
DeviceNet Board	R12NZ9004F	R12B040727	DeviceNet module is mounted on the Fieldbus Board.
PROFIBUS Board	R12NZ9004H	R12B040729	PROFIBUS-DP module is mounted on the Fieldbus Board.
CC-Link Board	R12NZ9004J	R12B040730	CC-Link module is mounted on the Fieldbus Board.
PROFINET Board	R12NZ900A6	R12N747051	PROFINET module is mounted on the Fieldbus Board.
EtherNet/IP Board	R12NZ900A7	R12N747061	EtherNet/IP module is mounted on the Fieldbus Board.
EtherCAT Board	R12NZ900CL	–	EtherCAT module is mounted on the Fieldbus Board.
PG Board	R12NZ900A8	R12N748011	
Analog I/O Board (1CH)	R12NZ900WZ	–	
Analog I/O Board (4CH)	R12NZ900X1	–	
Force Sensor I/F Board (FS2)	2184536	–	
EUROMAP67 Board	R12NZ90104	–	
EUROMAP67 Board (without IMM connection cable)	R12NZ9010A	–	EUROMAP67 without Cable2
EUROMAP67 Cable1	2194667	–	For EUROMAP67 Board Emergency Stop cable
EUROMAP67 Cable2	2194668	–	For EUROMAP67 Board IMM Connection cable
EUROMAP67 Emergency Connector Plug	2165789	–	For EUROMAP67 Board Soldering plug
EUROMAP67 Emergency Connector Shell	2194882	–	For EUROMAP67 Board Shell kit

