

# EPSON

ROBOT CONTROLLER

*RC420*

Rev.9

EM073C1492F

ROBOT CONTROLLER RC420 Rev.9

ROBOT CONTROLLER

# RC420

Rev.9

Copyright © 2002-2007 SEIKO EPSON CORPORATION. All rights reserved.

## FOREWORD

Thank you for purchasing our robot products.

This manual contains the information necessary for the correct use of the RC420 robot controller.

Please carefully read this manual and other related manuals before installing the robot system.

Keep this manual handy for easy access at all times.

## WARRANTY

The robot system and its optional parts are shipped to our customers only after being subjected to the strictest quality controls, tests, and inspections to certify its compliance with our high performance standards.

Product malfunctions resulting from normal handling or operation will be repaired free of charge during the normal warranty period. (Please ask your Regional Sales Office for warranty period information.)

However, customers will be charged for repairs in the following cases (even if they occur during the warranty period):

1. Damage or malfunction caused by improper use which is not described in the manual, or careless use.
2. Malfunctions caused by customers' unauthorized disassembly.
3. Damage due to improper adjustments or unauthorized repair attempts.
4. Damage caused by natural disasters such as earthquake, flood, etc.

Warnings, Cautions, Usage:

1. If the robot system associated equipment is used outside of the usage conditions and product specifications described in the manuals, this warranty is void.
2. If you do not follow the WARNINGS and CAUTIONS in this manual, we cannot be responsible for any malfunction or accident, even if the result is injury or death.
3. We cannot foresee all possible dangers and consequences. Therefore, this manual cannot warn the user of all possible hazards.

## TRADEMARKS

Microsoft, Windows, and Windows logo are either registered trademarks or trademarks of Microsoft Corporation in the United States and/or other countries. Other brand and product names are trademarks or registered trademarks of the respective holders.

## TRADEMARK NOTATION IN THIS MANUAL

Microsoft® Windows® 2000 Operating system

Microsoft® Windows® XP Operating system

Throughout this manual, Windows 2000, and Windows XP refer to above respective operating systems. In some cases, Windows refers generically to Windows 2000, and Windows XP.

## NOTICE

No part of this manual may be copied or reproduced without authorization.

The contents of this manual are subject to change without notice.

Please notify us if you should find any errors in this manual or if you have any comments regarding its contents.

## INQUIRIES

Contact the following service center for robot repairs, inspections or adjustments.

If service center information is not indicated below, please contact the supplier office for your region.

Please prepare the following items before you contact us.

- Your controller model and its serial number
- Your manipulator model and its serial number
- Software and its version in your robot system
- A description of the problem

## SERVICE CENTER

--

## MANUFACTURER & SUPPLIER

Japan & Others

### **SEIKO EPSON CORPORATION**

Suwa Minami Plant

Factory Automation Systems Dept.

1010 Fujimi, Fujimi-machi,

Suwa-gun, Nagano, 399-0295

JAPAN

TEL : +81-(0)266-61-1802

FAX : +81-(0)266-61-1846

## SUPPLIERS

North & South America

### **EPSON AMERICA, INC.**

Factory Automation/Robotics

18300 Central Avenue

Carson, CA 90746

USA

TEL : +1-562-290-5900

FAX : +1-562-290-5999

E-MAIL : [info@robots.epson.com](mailto:info@robots.epson.com)

Europe

### **EPSON DEUTSCHLAND GmbH**

Factory Automation Division

Otto-Hahn-Str.4

D-40670 Meerbusch

Germany

TEL : +49-(0)-2159-538-1391

FAX : +49-(0)-2159-538-3170

E-MAIL : [robot.infos@epson.de](mailto:robot.infos@epson.de)

# TABLE OF CONTENTS

---

## Setup & Operation

<b>1. Safety</b>	<b>3</b>
1.1 Conventions	3
1.2 Safety Precautions	4
1.3 Safety Features	7
<b>2. Part Names and Functions</b>	<b>11</b>
2.1 System Configuration	11
2.2 Standard Specifications	11
2.3 Controller	13
2.3.1 Front Panel	13
2.3.2 Rear Panel	17
2.3.3 Dimensions	19
<b>3. Installation</b>	<b>21</b>
3.1 Environmental Requirements	21
3.2 Power Supply	22
3.2.1 Specifications	22
3.2.2 Power Plug	23
3.3 Cable Connection	23
3.3.1 Typical Cable Connection	24
3.3.2 Connecting the Manipulator to the Controller	27
3.4 Noise Countermeasures	28
<b>4. OPTIONAL DEVICE Connector</b>	<b>29</b>
4.1 OPTIONAL DEVICE Connector	29
4.2 ATTEND (TEACH) Control Device	30
4.3 OPTIONAL DEVICE Dummy Plug	31
4.4 Pin Assignments	32
<b>5. EMERGENCY Connector</b>	<b>33</b>
5.1 Safety Door Switch and Latch Release Switch	33
5.1.1 Safety Door Switch	33
5.1.2 Latch Release Switch	34
5.1.3 Checking Latch Release Switch Operation	34
5.2 Emergency Stop Switch	35
5.2.1 Emergency Stop Switch	35
5.2.2 Checking Emergency Stop Switch Operation	35
5.3 E. STOP Box	36
5.3.1 E. STOP Box	36
5.3.2 Checking E. STOP Box Operation	36
5.4 Pin Assignments	37

5.5	Circuit Diagrams .....	38
5.5.1	Example 1: External emergency stop switch typical application.....	38
5.5.2	Example 2: External safety relay typical application .....	39
<b>6. STANDARD I/O Connector .....</b>		<b>41</b>
6.1	Input Circuit.....	42
6.2	Output Circuit.....	44
6.3	Pin Assignments.....	46
6.3.1	STANDARD I/O connector - Pin Assignments .....	46
6.3.2	STANDARD I/O connector optional cable for USA Specification - Pin Assignments .....	47
<b>7. Expansion I/O Board - Optional .....</b>		<b>49</b>
7.1	Expansion I/O Board .....	49
7.2	Protected Expansion I/O Board.....	50
7.2.1	Jumper Settings.....	50
7.2.2	Input Circuit .....	51
7.2.3	Output Circuit.....	53
7.3	Expansion I/O Board .....	55
7.3.1	Jumper Settings.....	55
7.3.2	Input Circuit .....	55
7.3.3	Output Circuit.....	56
7.4	Expansion I/O Board: Pin Assignments .....	58
7.4.1	Pin Assignments (NPN type).....	58
7.4.2	Pin Assignments (PNP type).....	60
7.5	Expansion I/O Connector .....	62
7.5.1	Pin Layout of Expansion I/O Connector.....	62
7.5.2	Expansion I/O Connector Cable .....	62
7.5.3	Cable - Pin Assignments.....	63
<b>8. I/O Remote Settings .....</b>		<b>67</b>
8.1	I/O Signal Description.....	68
8.1.1	Remote Input Signals .....	68
8.1.2	Remote Output Signals .....	71
8.2	Timing Specifications .....	72
8.2.1	Design Notes for Remote Input Signals.....	72
8.2.2	Timing Diagram for Operation Execution Sequence .....	72
8.2.3	Timing Diagram for Program Execution Sequence .....	73
8.2.4	Timing Diagram for Safety Door Input Sequence.....	74
8.2.5	Timing Diagram for Emergency Stop Sequence .....	74
8.2.6	Timing Diagram for RECOVER Sequence .....	75
<b>9. RS-232C Settings.....</b>		<b>77</b>
9.1	RS-232C cable .....	77
9.1.1	Pin Assignments.....	77
9.1.2	Connection Example .....	78
9.2	Preparation for Communication .....	78



<b>10. UPS (Uninterruptible Power Supply)</b>	<b>79</b>
10.1 UPS	79
10.2 Configuration of power Supplies	79
10.3 Normal Shutdown of Robot System	79
10.4 Automatic Shutdown by UPS service in Robot System	79
10.4.1 While Windows is being booted up	80
10.4.2 After Windows is booted up	80
10.5 UPS Battery	81
10.5.1 Safety Precautions for Battery	81
10.5.2 Charging Battery	81
10.5.3 Life Cycle of Battery	81
10.5.4 Replacement of Battery	83
10.6 Setting up Windows	84
10.6.1 Installing RC420 UPS Drivers	84
10.6.2 Basic Configuration of Windows	96
10.6.3 Setting up the Automatic Shutdown at the Time of a Power Failure	98
10.6.4 UPS Setup Consideration	102

## Maintenance

<b>1. Safety Precautions on Maintenance</b>	<b>107</b>
1.1 Safety Precautions	107
1.2 Lockout	108
1.3 Tagout	108
<b>2. Regular Maintenance Inspection</b>	<b>109</b>
2.1 Schedule for Maintenance Inspection	109
2.2 Inspection Point	109
2.2.1 Inspection While the Controller is Turned OFF	109
2.2.2 Inspection While the Controller is Turned ON	109
2.3 Cleaning the Fan Filter	109
2.4 Replacing a Lithium Battery on the CPU Board	109
2.5 Backup of Data	112
<b>3. Controller Internal Layout</b>	<b>117</b>
<b>4. Pin Assignments for the System Connectors</b>	<b>119</b>
4.1 M/C Power Cable	119
4.2 M/C Signal Cable	120
<b>5. Switching Power Supply Module</b>	<b>121</b>
5.1 Layout and Functions	121
5.2 Inspection	121
5.3 Replacement	122
5.3.1 Replacing Switching Power Supply Module 1	122
5.3.2 Replacing Switching Power Supply Module 2	123

<b>6. Motor Driver Module .....</b>	<b>125</b>
6.1 Layout and Functions .....	125
6.2 Replacing a Motor Driver Module.....	126
<b>7. DPB (Drive Power Board).....</b>	<b>129</b>
7.1 Layout and Functions .....	129
7.2 Adjusting Encoder Voltage .....	130
<b>8. DMB (Drive Main Board) .....</b>	<b>131</b>
8.1 Layout and Functions .....	131
8.2 Replacing DMB.....	132
<b>9. Regeneration Module .....</b>	<b>135</b>
9.1 Layout and Functions .....	135
9.2 Replacing a Regeneration Module.....	135
<b>10. Replacing Maintenance Parts.....</b>	<b>137</b>
10.1 Optional Board.....	137
10.2 CPU Board.....	137
10.3 HDD .....	139
10.4 Fan Filter.....	140
<b>11. Verifying Robot System Operation .....</b>	<b>141</b>
<b>12. Recovering the HDD.....</b>	<b>143</b>
12.1 Recovering Windows.....	144
12.1.1 Recovery Procedure.....	144
12.1.2 Windows Recovery (With “EasyRestore” License Label) .....	144
12.1.3 Windows Recovery (Without “EasyRestore” License Label) .....	147
12.2 Configuring Windows .....	151
12.3 Setting Up EPSON RC+ (Using the Network) .....	151
12.3.1 Necessary Items.....	151
12.3.2 Sharing Configuration .....	151
12.3.3 Network Configuration.....	153
12.3.4 Starting EPSON RC+ Setup Program .....	157
12.3.5 Installing EPSON RC+ .....	157
12.3.6 Reserving Address Resources of EPSON RC+ Options .....	157
12.4 Setting Up EPSON RC+ (Using the CD-R/RW Drive with USB).....	159
12.4.1 Necessary Items.....	159
12.4.2 Starting EPSON RC+ Setup Program .....	159
12.4.3 Installing EPSON RC+ .....	159
12.4.4 Reserving Address Resources of EPSON RC+ Options .....	159
<b>13. Maintenance Parts List .....</b>	<b>161</b>

# Setup & Operation

This manual contains information for setup and operation of the RC420 Robot Controller.



# 1. Safety



Installation and transportation of robots and robotic equipment shall be performed by qualified personnel and should conform to all national and local codes.

Please read this manual and other related manuals before installing the robot system or before connecting cables. Keep this manual in a handy location for easy access at all times.

Read the *Safety* chapter in EPSON RC+ User's Guide and confirm "Safety-related requirements".

## 1.1 Conventions

Important safety considerations are indicated throughout the manual by the following symbols. Be sure to read the descriptions shown with each symbol.

 WARNING	This symbol indicates that a danger of possible serious injury or death exists if the associated instructions are not followed properly.
 WARNING	This symbol indicates that a danger of possible harm to people caused by electric shock exists if the associated instructions are not followed properly.
 CAUTION	This symbol indicates that a danger of possible harm to people or physical damage to equipment and facilities exists if the associated instructions are not followed properly.

## 1.2 Safety Precautions



Only trained personnel should design and install the robot system.

Trained personnel are defined as those who have taken robot system training and maintenance training classes held by the manufacturer, dealer, or local representative company, or those who understand the manuals thoroughly and have the same knowledge and skill level as those who have completed the training courses.

The following items are safety precautions for qualified design or installation personnel:

 WARNING	<ul style="list-style-type: none"> <li>■ Personnel who design and/or construct the robot system with this product must read the <i>Safety</i> chapter in User's Guide to understand the safety requirements before designing and/or constructing the robot system. Designing and/or constructing the robot system without understanding the safety requirements is extremely hazardous, may result in serious bodily injury and/or severe equipment damage to the robot system, and may cause serious safety problems.</li> <li>■ The Manipulator and the Controller must be used within the environmental conditions described in their respective manuals. This product has been designed and manufactured strictly for use in a normal indoor environment. Using the product in an environment that exceeds the specified environmental conditions may not only shorten the life cycle of the product but may also cause serious safety problems.</li> <li>■ The robot system must be used within the installation requirements described in the manuals. Using the robot system outside of the installation requirements may not only shorten the life cycle of the product but also cause serious safety problems.</li> <li>■ The interlock of the Safety Door must be functioning when the robot system is operated. Do not operate the system under the condition that the switch cannot be turned ON/OFF. (I.E. the condition where the switch is disabled) (Example: Tape is put around the switch to hold it closed.) Operating the robot system when the switch is not functioning properly is extremely hazardous and may cause serious safety problems as the Safety Door input cannot fulfill its intended function.</li> <li>■ Connect input signal wires for Emergency Stop and Safety Door to the EMERGENCY connector so that the Emergency Stop switch in the operation unit or the ATTEND (TEACH) control device connected to the OPTIONAL DEVICE connector always functions. (Refer to the typical application diagram in the <i>Setup &amp; Operation 5.5 Circuit Diagrams.</i>)</li> </ul>
--	--

The following items are safety precautions for qualified design or installation personnel: (cont.)

 <b>WARNING</b>	<ul style="list-style-type: none"> <li>■ Do not open the cover(s) of the Controller except while maintaining it. Opening the cover(s) of the Controller is extremely hazardous and may result in electric shock even when its main power is OFF because of the high voltage charge inside the Controller.</li> <li>■ Make sure that the power to the Controller is turned OFF and locked out before connecting or disconnecting any cables. Connecting or disconnecting any cables with the power ON is extremely hazardous and may result in electric shock and/or malfunction of the Controller.</li> <li>■ If it is necessary to change the plug to fit the outlet in your factory, make sure that it is done by qualified personnel. When changing the plug, be sure to connect the earth wire of the AC power cable colored green/yellow on the Controller to the earth terminal of the factory power supply. The equipment must be grounded properly at all times to avoid the risk of electric shock. Always use a power plug and receptacle. Never connect the Controller directly to the factory power supply. (Field wiring)</li> <li>■ Be sure to connect the cables properly. Do not allow unnecessary strain on the cables. (Do not put heavy objects on the cables. Do not bend or pull the cables forcibly.) The unnecessary strain on the cables may result in damage to the cables, disconnection, and/or contact failure. Damaged cables, disconnection, or a contact failure is extremely hazardous and may result in electric shock and/or improper function of the system.</li> </ul>
 <b>CAUTION</b>	<ul style="list-style-type: none"> <li>■ Only install optional hardware specifically designed for the robot system. If any other hardware is installed to the robot system, the robot system may function improperly and also cause safety problems. (For EPSON RC+ Users, only the hardware that has been approved by EPSON can be installed on the robot system.)</li> <li>■ Do not install any other software in the robot system except for the software that was originally installed at ship time. If any other software is installed, the robot system may function improperly and also cause safety problems. (For EPSON RC+ Users, only the software that has been approved by EPSON can be installed on the robot system.)</li> <li>■ The serial number of the Manipulator that should be connected is indicated on the Connection Check Label on the Controller. Connect the Controller and the Manipulator correctly. Improper connection between the Controller and the Manipulator may cause improper function of the robot system and also safety problems.</li> </ul>

The following items are safety precautions for qualified design or installation personnel: (cont.)

 CAUTION	<ul style="list-style-type: none"> <li>■ When using remote I/O, always make sure of the following. Using the robot system under unsatisfactory conditions may cause malfunction of the system and/or safety problems.                         <ul style="list-style-type: none"> <li>- Assign remote functions to inputs/outputs correctly and wire correctly when setting up remote I/O signals.</li> <li>- Make sure that the functions correspond to the correct input/output signals before turning ON the system.</li> <li>- When verifying the robot system operation, prepare for failures with initial settings or wiring. If the Manipulator functions unusually by the failures with initial settings or wiring, press the Emergency Stop switch immediately to stop the Manipulator.</li> </ul> </li> </ul>
--	--

The following items are safety precautions for qualified operator personnel:

 WARNING	<ul style="list-style-type: none"> <li>■ The interlock of the Safety Door must be functioning when the robot system is operated. Do not operate the system under the condition that the switch cannot be turned ON/OFF. (I.E. the condition where the switch is disabled) (Example: Tape is put around the switch to hold it closed.) Operating the robot system when the switch is not functioning properly is extremely hazardous and may cause serious safety problems as the Safety Door input cannot fulfill its intended function.</li> </ul>
--	---

 WARNING	<ul style="list-style-type: none"> <li>■ Do not open the cover(s) of the Controller except while maintaining it. Opening the cover(s) of the Controller is extremely hazardous and may result in electric shock even when its main power is OFF because of the high voltage charge inside the Controller.</li> </ul>
--	--



## 1.3 Safety Features

The RC420 robot control system supports safety features described below. However, the user is recommended to strictly follow the proper usage of the robot system by thoroughly reading the attached manuals before using the system. Failure to read and understand the proper usage of the safety functions is highly dangerous.

Among the following safety features, the Emergency Stop Switch and Safety Door Input are particularly important. Make sure that these and other features function properly before operating the robot system.

Refer to the *Setup & Operation 5.1 Safety Door Switch and Latch Release Switch* and *Setup & Operation 5.2 Emergency Stop Switch* for details.

### ATTEND (TEACH) Control Device

To operate the Manipulator at a short distance without any operation unit (option) such as an Operation Pendant, you should use the ATTEND (TEACH) control device and connect it to the OPTIONAL DEVICE connector on the front of the Controller. The ATTEND (TEACH) control device should consist of the Emergency Stop switch, 3-position enable switch (dead-man switch), and ATTEND (TEACH) control device enable/disable switch.

### Emergency Stop Switch

The ATTEND (TEACH) control device must be equipped with the Emergency Stop switch. The EMERGENCY connector on the Controller has expansion Emergency Stop input terminals used for connecting the Emergency Stop switches.

These Emergency Stop inputs are internally connected to the relays for the dynamic brake. Therefore, pressing any Emergency Stop switch can shut off the motor power immediately and the robot system will enter the Emergency Stop condition.

### Safety Door Input

In order to activate this feature, make sure that the Safety Door Input switch is connected to the EMERGENCY connector at the Controller.

When the safety door is opened, normally the Manipulator immediately stops the current operation, and the status of Manipulator power is operation-prohibited until the safety door is closed and the latched condition is released. In order to execute the Manipulator operation while the safety door is open, you must change the ATTEND (TEACH) control device enable/disable switch to “enable” or change the mode selector switch on the operation unit to the mode for teaching and then engage the 3-position enable switch. In this case, the Manipulator is operated in low power status.

### Lockout

Turn OFF the power supply and use a lockout procedure to prevent anyone from turning ON the power supply by mistake while someone else is in the safeguarded area for maintenance or repairs.

The procedure for lockout is described in the *Maintenance 1. Safety Precautions on Maintenance*.

## Low Power Mode

The motor power is reduced in this mode.

Executing a power status change instruction will change to the restricted (low power) status regardless of conditions of the safety door or operation mode. The restricted (low power) status ensures the safety of the operator and reduces the possibility of peripheral equipment destruction or damage caused by careless operation.

## Dynamic Brake

The dynamic brake circuit includes relays that short the motor armatures. When the motor armatures are shorted, the power to the Motor Driver modules is cut off and the reverse EMF caused by the short stops the motors. The dynamic brake circuit is activated when there is an Emergency Stop input or when any of the following errors is detected: encoder cable disconnection, motor overload, irregular motor torque, motor speed error, servo error (positioning or speed overflow), irregular CPU, memory check-sum error and overheat condition inside the Motor Driver Module.

## Encoder Cable Disconnection Error Detection

The dynamic brake circuit is activated when the Motor Encoder Signal cable is disconnected.

## Motor Overload Detection

The dynamic brake circuit is activated when the system detects that the load on the motor has exceeded its capacity.

## Irregular Motor Torque (out-of-control manipulator) Detection

The dynamic brake circuit is activated when irregularity with motor torque (motor output) is detected (in which case the Manipulator is out of control).

## Motor Speed Error Detection

The dynamic brake circuit is activated when the system detects that the motor is running at incorrect speed.

## Positioning Overflow-Servo Error-Detection

The dynamic brake circuit is activated when the system detects that the difference between the Manipulator's actual position and commanded position exceeds the margin of error allowed.

## Speed Overflow-Servo Error-Detection

The dynamic brake circuit is activated when the Manipulator's actual speed is detected to mark an overflow (the actual speed is outside the nominal range) error.

### CPU Irregularity Detection

Irregularity in the motor controlling CPU is monitored by a watch-dog timer. Also, the system CPU and the motor controlling CPU inside the Controller are designed to constantly check each other for any discrepancies. If a discrepancy is detected, the dynamic brake circuit is activated.

### Memory Check-sum Error Detection

The dynamic brake circuit is activated when a memory check-sum error is detected.

### Overheat Detection at the Motor Driver Module

The dynamic brake circuit is activated when the temperature of the power device inside the Motor Driver module is above the nominal limit.

### Over-Voltage Detection

The dynamic brake circuit is activated when the voltage of the Controller is above the normal limit. (When a regeneration module is mounted.)



## 2. Part Names and Functions

### 2.1 System Configuration

The RC420 can control up to four AC Servo Motors simultaneously.

Example : One Controller and One Manipulator

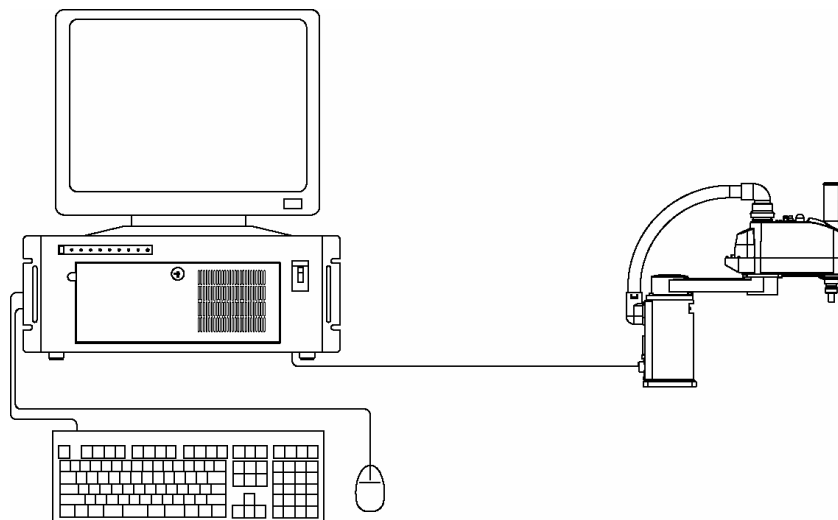

### 2.2 Standard Specifications

Item	Specification	
Model	RC420	
CPU	PC compatible computer optimized for RC420: CPU : Celeron 850 MHz or faster HDD : 20 GB or more RAM : 256 MB or more	
Controllable Axes	Up to four (4) connectable AC Servo Motors	
Robot Manipulator Control	Programming Language and Robot Control Software	EPSON RC+ (a multi-tasking robot language)
	Joint Control	Simultaneous control over all the four (4) joints Software AC servo control
	Speed Control	PTP motion : Programmable in the range of 1% to 100% CP motion : Programmable (Actual value to be manually entered.)
	Acceleration/Deceleration Control	PTP motion : Programmable in the range of 1% to 100%; Automatic CP motion : Programmable (Actual value to be manually entered.)
Positioning Control	PTP (Pose-To-Pose control) CP (Continuous Path control)	

Item	Specification		
Memory Capacity	Programmable Area : 4 MB Point Data Area : Max. 1000 points programmable (per Manipulator)		
Teaching Method	Remote Direct MDI (Manual Data Input)		
External Input/ Output Signals	Standard I/O	Input : 16 Output : 16	Remote functions allowed
	Expansion I/O	Input : 32 (per board) Output : 32 (per board)	
Communication Interface	RS-232C Ethernet USB	2 channels 1 channel 2 ports	
Expansion Slots	4 slots	In case of ISA: 4 slots In case of PCI: 3 slots	
Safety Features	<ul style="list-style-type: none"> <li>- Emergency stop switch</li> <li>- Safety door input</li> <li>- Low power mode</li> <li>- Dynamic brake</li> <li>- Encoder cable disconnection error detection</li> <li>- Motor overload detection</li> <li>- Irregular motor torque (out-of-control Manipulator) detection</li> <li>- Motor speed error detection</li> <li>- Positioning overflow - servo error - detection</li> <li>- Speed overflow - servo error - detection</li> <li>- CPU irregularity detection</li> <li>- Memory check-sum error detection</li> <li>- Overheat detection at the Motor Driver Module</li> <li>- Safety key lock on the ATTEND (TEACH) control device for mode switch</li> <li>- Lockout</li> <li>- Over-Voltage Detection (When a regeneration module is mounted.)</li> </ul>		
Power Source	AC 200V to AC 240V Single phase 50/60 Hz		
Maximum Power Consumption	2000W (Depending on the Manipulator model)		
Insulation Resistance	100 MΩ or more		
Rated Ambient Temperature	5 to 40 deg.C		
Rated Relative Humidity	20% to 80% (with no condensation)		

Item	Specification
Weight	24 kg *
Size	For the Controller, refer to the <i>Setup &amp; Operation 2.3.3 Dimensions</i> .
Keyboard dimension	W347 × D116 × H18 (mm)

- \* Weight of the unit is indicated on the Controller Unit and the Drive Unit itself.  
Make sure to check the weight before units transfer or relocation and prevent throwing out your back at holding the unit.  
Also, make sure to keep your hands, fingers, and feet safe from being caught or serious injury.

## 2.3 Controller

 CAUTION	<ul style="list-style-type: none"> <li>■ Only install optional hardware specifically designed for the robot system. If any other hardware is installed to the robot system, the robot system may not only function improperly but also cause safety problems. (For EPSON RC+ Users, only the hardware that has been approved by EPSON can be installed on the robot system.)</li> <li>■ Do not install any other software in the robot system except for the software that was originally installed at ship time. If any other software is installed, the robot system may not only function improperly but also cause safety problems. (For EPSON RC+ Users, only the software that has been approved by EPSON can be installed on the robot system.)</li> </ul>
--	---

### 2.3.1 Front Panel

The Controller has a door on the front panel, which can be opened/closed by a key supplied with the unit.

Front Panel, Closed

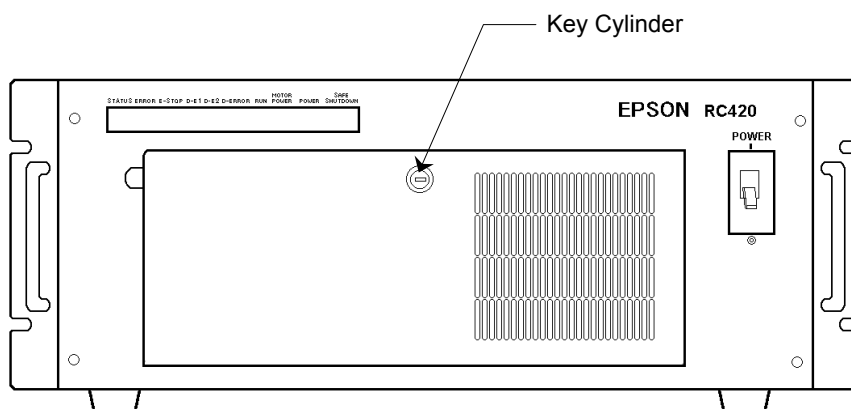

Front Panel, Open

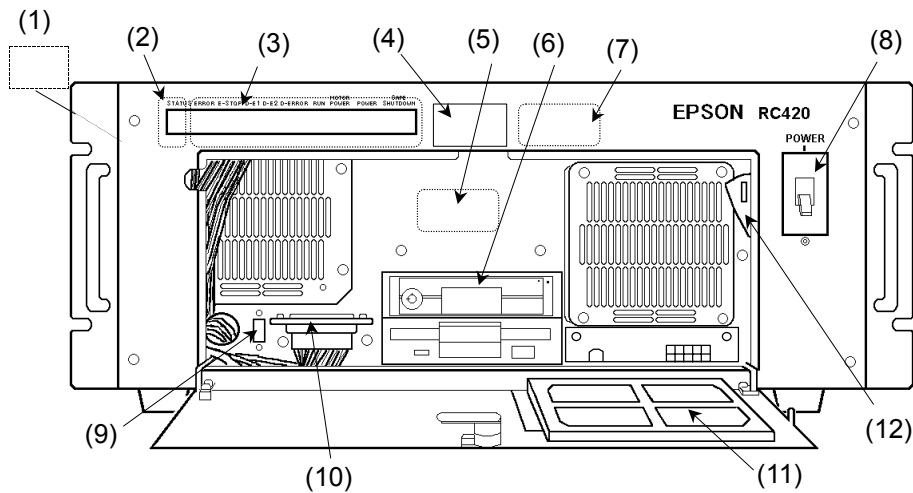

(1) Signature label (This label is attached on the left side of the Controller when you face the front panel.)  
The serial number of the Controller is recorded on the signature label.

(2) STATUS

Seven-segment LED as one-digit displays the error number, Manipulator number and joint number. The numbers will be displayed with the LEDs blinking. Record all the numbers and check the error that has occurred.

Timing of LED Blinking

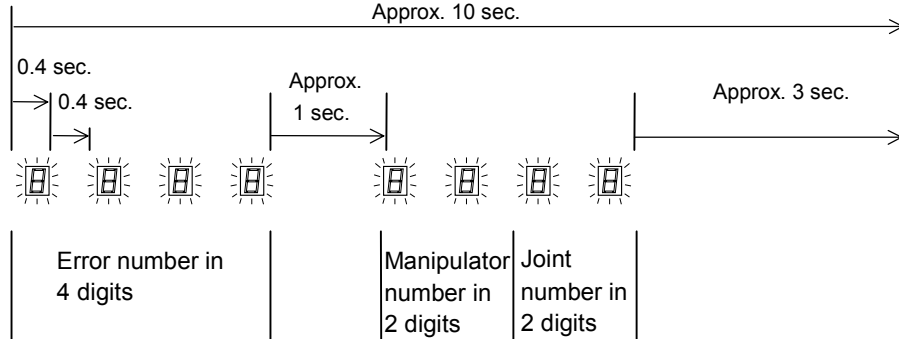

The above mentioned cycle (which lasts approximately 10 seconds) repeats and is displayed until the error is canceled or the power is OFF.

Error Number : Four-digit error numbers are displayed.  
For details, refer to the error number table in the chapter *SPEL<sup>+</sup> Error Messages* in *SPEL<sup>+</sup> Language Reference*.

Manipulator Number: Two-digit Manipulator numbers are displayed, starting from 01.

Joint Number : Two-digit numbers are display, showing which joint of the Manipulator has an error. The number starts from 01.

When an error occurs that has no relation to a Manipulator or joint, the error number will appear, but the Manipulator number and joint number will both be displayed as 00.



(3) LED

The LEDs indicate the following status when they are ON:

LED	Color	Description
ERROR	Red	There is an error.
MOTOR POWER		Lights when the motor power is ON. (Motor Power: The DC power supply that inputs to the Motor Driver module to drive the motor. This DC power is generated by regulating AC 200V or the local equivalent power.)
D-E1		Indicates that an unresettable error relating to motor control with/in any of the Manipulator axes occurs.
D-E2		Indicates that a resettable error relating to motor control with/in any of the Manipulator axes occurs.
D-ERROR		Lights when the CPU of the motor control detects an error.
RUN	Green	Lights while the CPU is operating normally in the Controller.
E-STOP	Red	Lights when in the Emergency Stop condition.
POWER		Lights when the Controller is turned ON.
SAFE SHUTDOWN		Lights when it is safe to turn OFF the Controller.

(4) Connection Check label

The details of the Manipulator to be connected are recorded on the label as shown below. The label indicates the Manipulator model and Manipulator serial number.

Example:

MANIPULATOR	
ES551S	00002

(5) Windows COA label

The Product Key that is required when you install Windows is recorded on this label.

(6) HDD (for the removable HD unit model)

The disk drive is mounted in a removable case. Refer to the *Maintenance 10.3 HDD* for the method of replacing HDD.

(7) MT label

The label indicates the specification number for the customized Manipulator and is attached only to the customized Manipulator. If your Manipulator indicates this label, it may require a specific maintenance procedure. In this case, make sure to contact your dealer before performing any maintenance procedures.

(8) Power switch

Turns ON or OFF the Controller.

(9) USB connector

Connects the USB-enabled hardware (CD-ROM drive, etc.). There is another port on the rear of the Controller.

(10) OPTIONAL DEVICE connector

Connects the optional operation unit or ATTEND (TEACH) control device or OPTIONAL DEVICE Dummy Plug.

For details, refer to the *Setup & Operation 4. OPTIONAL DEVICE Connector*.



- Do not connect the EPSON RC+ software key to the OPTIONAL DEVICE connector. Connecting the EPSON RC+ software key to the OPTIONAL DEVICE connector while the Controller is ON may cause damage to the EPSON RC+ software key. Connect the EPSON RC+ software key to the IEEE-1284 (parallel) connector on the rear of the Controller.

(11) Cooling Fan Filter

A protective filter is installed in front of the cooling fan to filter out dust.

NOTE



Check condition of the filter regularly and clean it as necessary. A dirty filter may result in the malfunction of the robot system as the temperature rises in the Controller.

The filter needs regular check-up and cleaning. For details, refer to the *Maintenance 10.4 Fan Filter*.

(12) Lockout metal hasp

To lock the power switch in OFF position, set the power switch to OFF position and put the metal hasp down on the right and then close the door. Cut off the power in this way for maintenance or repair of the robot system.

## 2.3.2 Rear Panel

The rear panel components are as follows:

NOTE  

The type of CPU board (connectors for mouse and keyboard) is different depending on the shipping date. The Controller in which the parts have been replaced for maintenance can be different from the figures below.

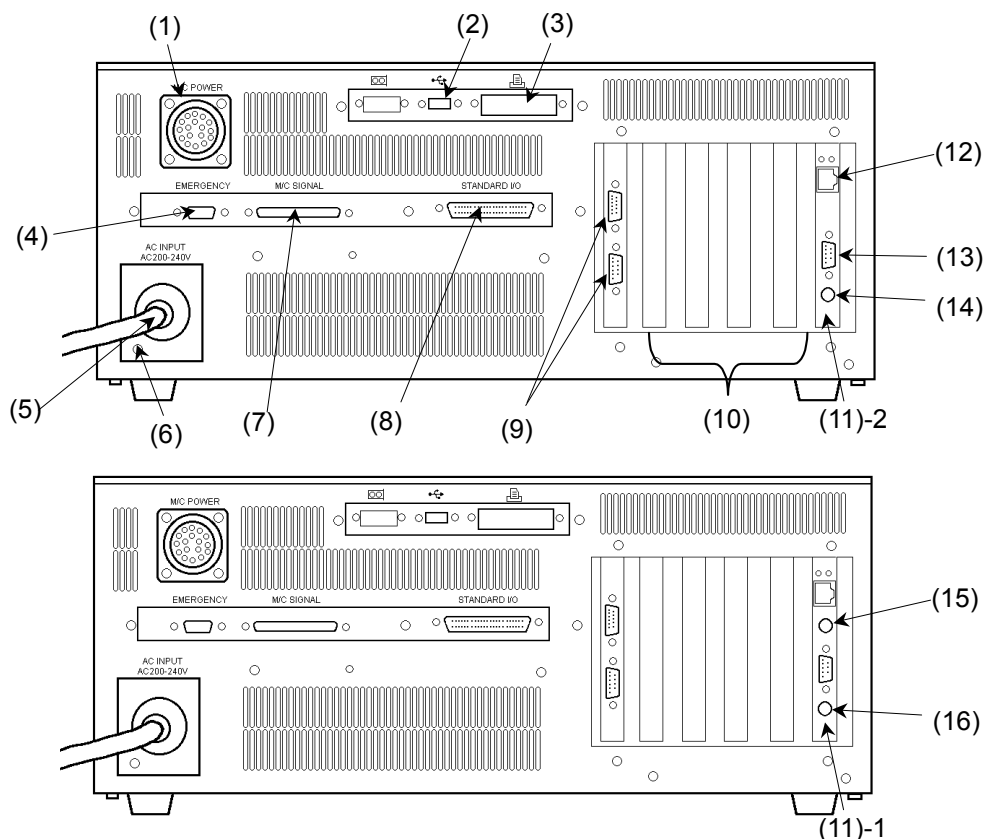

- (1) **M/C POWER connector**  
A connector for the Manipulator power source. Connect the dedicated power cable attached to the Manipulator.
- (2) **USB connector**  
Connects the USB-enabled hardware (CD-ROM drive, etc.). There is another port on the front of the Controller.
- (3) **IEEE-1284 (parallel) connector**  
This connector is for the EPSON RC+ software key.
- (4) **EMERGENCY connector**  
This connector is used for input/output from/to Emergency Stop and Safety Door switches. Refer to the *Setup & Operation 5. EMERGENCY Connector* for details.
- (5) **AC IN**  
The cable for AC 200V power input.

- (6)  Protective Earth Terminal  
External protective earth terminal
- (7) M/C SIGNAL connector  
This connector is used for signals such as the Manipulator's motor encoders, the origin sensor signals, etc. Connect the Manipulator's dedicated signal cable.
- (8) STANDARD I/O connector  
This connector is used for input/output devices. There are 16 inputs and 16 outputs. Refer to the *Setup & Operation 6. STANDARD I/O Connector* for details.
- (9) Serial connector (RS-232C)  
This connector facilitates data communication and centralized control by connecting peripheral equipment and the host computer to the Controller.  
For details, refer to the *Setup & Operation 9. RS-232C Settings*.
- (10) System Expansion (Optional Board) Slots  
Up to 4 slots are available for optional boards such as the Expansion I/O Board or Pulse Generating Board. Do not mount boards other than the optional boards for the RC420.
- (11) CPU Board  
For details, refer to the *Setup & Operation 2.2 Standard Specifications*.  
The CPU board has different model numbers and appearances depending on the dates of the shipping and the board changeover.

	CPU Board	Connector for Mouse and Keyboard
(11)-1	PC-686BX(PC)-EPC850	Separate connectors
(11)-2	SPI-6941-EPC	Integrated connector

- (12) Ethernet connector  
This Ethernet connector is used for network communication via 100BASE-TX / 10BASE-T.
- (13) VGA connector  
Receptacle for VGA monitor cable.
- (14) Mouse / Keyboard connector (CPU board (11)-2)  
Receptacle for mouse and keyboard cable. Connect the cable to a mouse and a keyboard following the symbols on the cable.  
Do not lose a PS/2 exchange cable included in the accessories.

 <b>CAUTION</b>	<ul style="list-style-type: none"> <li>■ Connect the mouse and the keyboard properly when the power is OFF. If the mouse or keyboard is connected when the power is ON or connected incorrectly, the robot system cannot function properly.</li> </ul>
---	--

- (15) Mouse connector (CPU board (11)-1)  
Receptacle for mouse cable.
- (16) Keyboard connector (CPU board (11)-1)  
Receptacle for keyboard cable. To connect a type AT connector keyboard, use the dedicated adapter (AT keyboard adapter) included in the accessories.

2.3.3 Dimensions

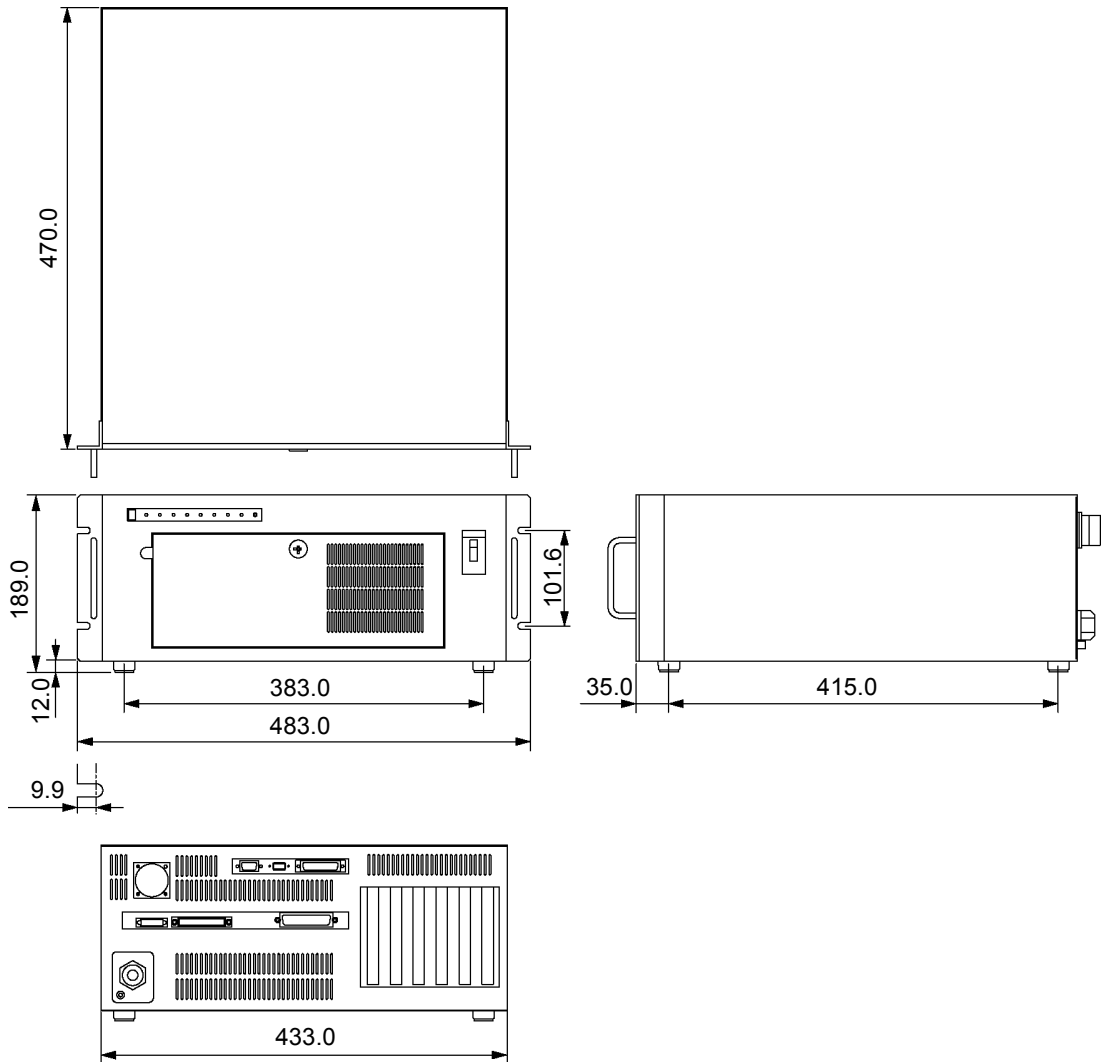

[Unit: mm]

NOTE



Do not remove any rubber feet of the Controller.



## 3. Installation

### 3.1 Environmental Requirements



WARNING

- The Manipulator and the Controller must be used within the environmental conditions described in their manuals. This product has been designed and manufactured strictly for use in a normal indoor environment. Using the product in the environment that exceeds the conditions may not only shorten the life cycle of the product but also cause serious safety problems.

In order to optimize the robot system's performance for safety, the Controller must be placed in an environment that satisfies the following conditions:

NOTE



The Controller is not designed for clean-room specification. If it must be installed in a clean room, make sure to install it in the proper enclosure with adequate ventilation and cooling.

Item	Condition
Ambient temperature	5 to 40 deg.C (with minimal variation)
Ambient relative humidity	20% to 80% (with no condensation)
First transient burst noise	2 kV or less (without mouse and keyboard)
Electrostatic noise	6 kV or less (without mouse and keyboard)
Environment	<ul style="list-style-type: none"> <li>- Install indoors only.</li> <li>- Place in a well-ventilated area.</li> <li>- Keep away from direct sunlight.</li> <li>- Keep away from dust, oily smoke, oily mist, salinity, metal powder or other contaminants.</li> <li>- Keep away from flammable or corrosive liquid and gas.</li> <li>- Keep away from water.</li> <li>- Keep away from shocks or vibrations.</li> <li>- Keep away from sources of electronic noise.</li> </ul> <p>If the Controller must be used in an environment that does not fulfill the conditions mentioned above, take adequate countermeasures. For example, the Controller may be enclosed in a cabinet with adequate ventilation and cooling.</p>
Base table	Use a base table that is at least 100 mm off the floor. Placing the Controller directly on the floor could allow dust penetration leading to malfunction.
Space	<ul style="list-style-type: none"> <li>- Allow at least 50 mm on each side.</li> <li>- There must be room in front of the Controller so that the entire Controller can be pulled outward.</li> <li>- There must also be room behind the Controller so that one can attach and remove cables and boards.</li> <li>- Do not block airflow to or from the fan.</li> </ul>

NOTE



The RC420 Controller must be normally placed horizontally.  
Do not remove any rubber feet of the RC420 Controller.

## 3.2 Power Supply

### 3.2.1 Specifications

Ensure that the available power meets the following specifications.

Item	Specification
Voltage	AC 200V to AC 240V
Phase	Single phase
Frequency	50/60 Hz
Momentary Power Interrupt	10msec. or less
Power Consumption	Max. 2000 W The Controller itself consumes a maximum of approximately 200 W, but actual consumption depends on the rated capacity of the motor and Controller.  Please refer to Manipulator power consumption in the Manipulator manual and use the following equation to determine total consumption: Rated consumption = 200 W + total Manipulator consumption (rated) × 1.2
Peak Current	When power is turned ON: approximately 50A (2msec.) When motor is ON: approximately 150A (5msec.)
Leakage Current	Max. 3.5 mA
Ground Resistance	100 Ω or less

Install an earth leakage circuit breaker or a circuit breaker in the AC power cable line at 20A or less rated electric current. Both should be a two-pole disconnect type. If you install an earth leakage circuit breaker, make sure to use an inverter type that does not operate by induction of a 10kHz or more leakage current. If you install a circuit breaker, please select one that will handle the above mentioned “peak current”.

The power receptacle shall be installed near the equipment and shall be easily accessible.



### 3.2.2 Power Plug

The AC power cable of the Controller is equipped with a power plug. Make sure that the plug is compatible with the power receptacle in your area. If not, replace the attached plug with the one that is suitable in your area.

 <b>WARNING</b>	<ul style="list-style-type: none"> <li>■ If it is necessary to change the plug to fit the outlet in your factory, make sure that it is done by a qualified personal. When changing the plug be sure to connect the earth wire of the AC power cable colored green/yellow on the Controller to the earth terminal of the factory power supply. The equipment must be grounded properly at all times to avoid the risk of electric shock. Always use a power plug and receptacle. Never connect the Controller directly to the factory power supply. (Field wiring)</li> </ul>
---	--

Plug Specification:

Terminal	Description	Color
X terminal	AC power	Brown
Y terminal	Open	–
Z terminal	AC power	Blue
W terminal	Protective earth wire	Green/Yellow

### 3.3 Cable Connection

 <b>WARNING</b>	<ul style="list-style-type: none"> <li>■ Make sure that the power to the Controller is turned OFF and locked out before connecting or disconnecting any cables. Connecting or disconnecting any cables with the power ON is extremely hazardous and may result in electric shock and malfunction of the Controller.</li> <li>■ Be sure to connect the cables properly. Do not allow unnecessary strain on the cables. (Do not put heavy objects on the cables. Do not bend or pull the cables forcibly.) The unnecessary strain on the cables may result in damage to the cables, disconnection, and/or contact failure. Damaged cables, disconnection, or contact failure is extremely hazardous and may result in electric shock and/or improper function of the system.</li> </ul>
---	---

 <b>CAUTION</b>	<ul style="list-style-type: none"> <li>■ The serial number of the Manipulator that should be connected is indicated on the Connection Check Label on the Controller. Connect the Controller and the Manipulator correctly. Improper connection between the Controller and the Manipulator may cause not only improper function of the robot system but also safety problems.</li> </ul>
---	---

### 3.3.1 Typical Cable Connection

The Manipulator must be connected as follows in order to operate properly. The diagram indicates a standard cable connection for a single Manipulator configuration.

Connection appearances of the mouse and the keyboard are different depending on the dates of the shipping and the board changeover.

Separate connectors for mouse and keyboard

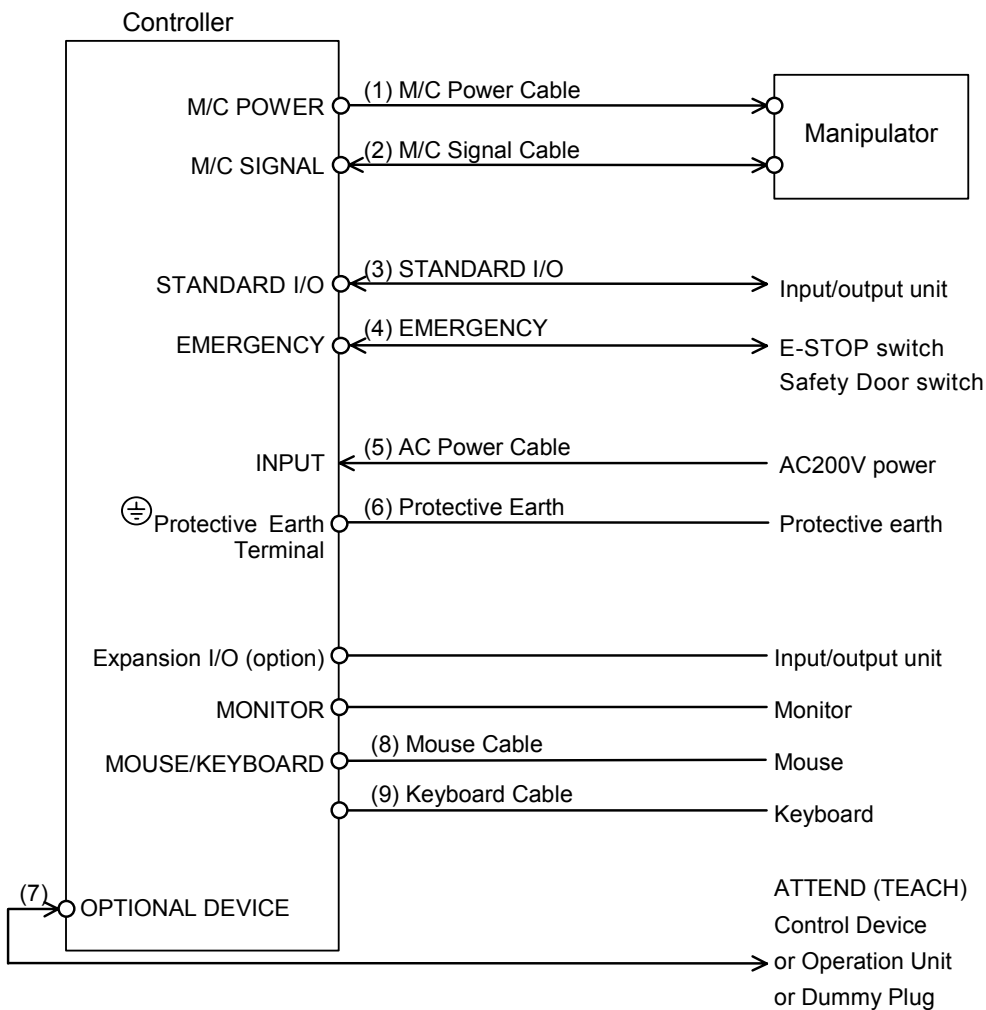

Integrated connector for mouse and keyboard

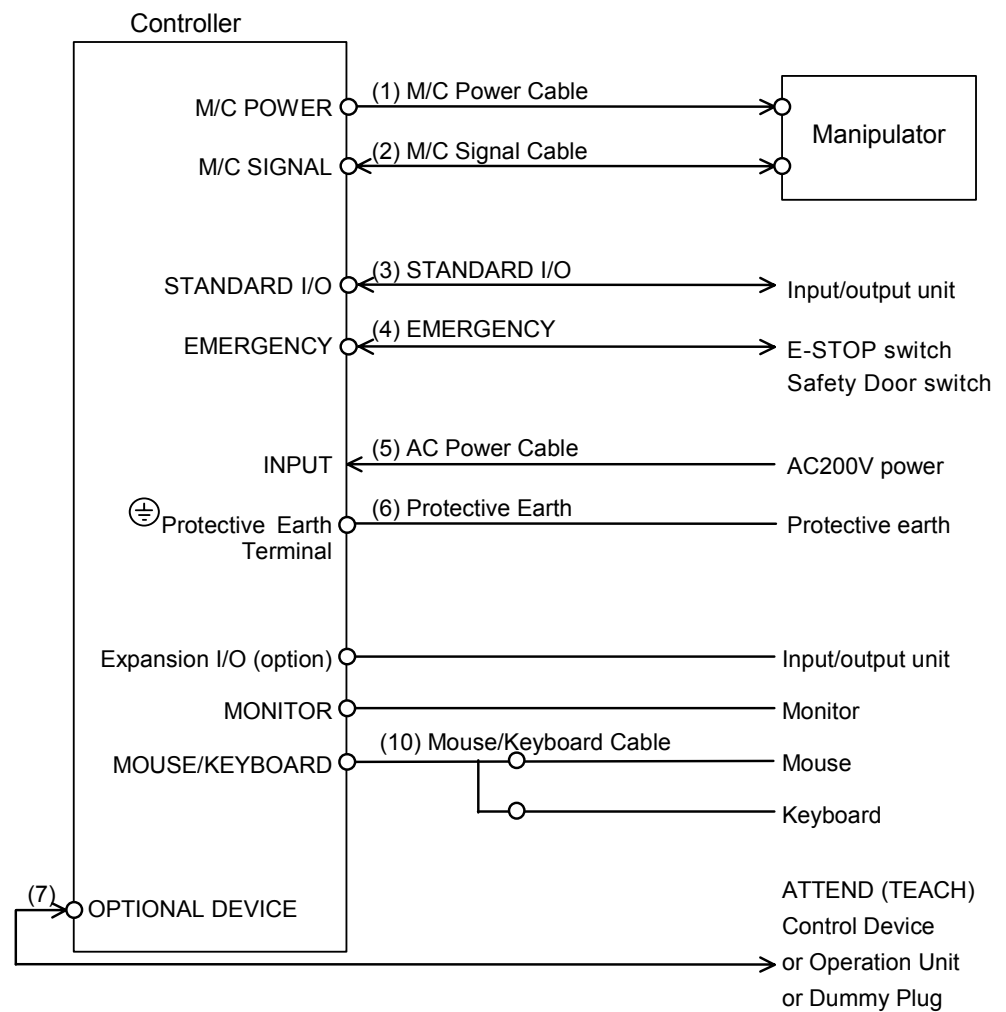

(1) M/C Power cable

This cable has round connectors with 17 pins on both ends. Connect the female connector to the POWER connector at the Manipulator and the male connector to the M/C POWER connector at the Controller. Insert the connectors and rotate clockwise until you hear a “click”.

(2) M/C Signal cable

This cable has rectangular connectors with 68 pins on both ends. Connect the signal cable to the SIGNAL connector of the Manipulator and the M/C SIGNAL connector of the Controller.

(3) STANDARD I/O connector

This connector is for the user’s input/output devices. For details about STANDARD I/O, refer to the *Setup & Operation 6. STANDARD I/O Connector*.

(4) EMERGENCY connector

The EMERGENCY connector has inputs to connect the Emergency Stop switch and the Safety Door switch. For safety reasons, connect proper switches for these input devices. For details, refer to the *Setup & Operation 5. EMERGENCY Connector*.

(5) AC Power cable

Cables for AC 200V (or the local equivalent) power supply to the Controller.

(6)  Protective Earth Terminal connector

The Protective Earth terminal connects to the earth ground wire. The Protective Earth terminal is better to be connected when a peripheral control unit such as a sequencer is used in the system. Use a cable of size equal to or greater than AWG #16 for the Protective Earth terminal.

(7) OPTIONAL DEVICE connector

Connect to optional operation units (e.g. ATTEND (TEACH) control device) or the OPTIONAL DEVICE Dummy Plug. If neither is connected, the Manipulator will be in the Emergency Stop condition and will not operate. For details, refer to the *Setup & Operation 4. OPTIONAL DEVICE Connector*.

(8) Mouse cable (Separate connectors)

Cable for a mouse.

(9) Keyboard cable (Separate connectors)

Cable for a keyboard.

(10) Mouse / Keyboard cable (Integrated connector)

This branch cable is for a mouse and a keyboard. Connect the cable to a mouse and a keyboard following the symbols on the cable.

 <p>CAUTION</p>	<p>■ Connect the mouse and the keyboard properly when the power is OFF. If the mouse or keyboard is connected when the power is ON or connected incorrectly, the robot system cannot function properly.</p>
--	---

### 3.3.2 Connecting the Manipulator to the Controller

Connect the Manipulator to the Controller by using the Power cable and the Signal cable.

 <p>WARNING</p>	<ul style="list-style-type: none"> <li>■ Make sure that the power to the Controller is turned OFF and locked out before connecting or disconnecting any cables. Connecting or disconnecting any cables with the power ON is extremely hazardous and may result in electric shock and malfunction of the Controller.</li> <li>■ Be sure to connect the cables properly. Do not allow unnecessary strain on the cables. (Do not put heavy objects on the cables. Do not bend or pull the cables forcibly.) The unnecessary strain on the cables may result in damage to the cables, disconnection, and/or contact failure. Damaged cables, disconnection, or contact failure is extremely hazardous and may result in electric shock and/or improper function of the system.</li> </ul>
--	---

 <p>CAUTION</p>	<ul style="list-style-type: none"> <li>■ The serial number of the Manipulator that should be connected is indicated on the Connection Check Label on the Controller. Connect the Controller and the Manipulator correctly. Improper connection between the Controller and the Manipulator may cause not only improper function of the robot system but also safety problems.</li> </ul>
--	---

The configuration data for the Manipulator and Manipulator model are stored in the Controller. Therefore the Controller should be connected to the Manipulator whose serial number is specified in the Connection Check label attached on the front of the Controller.

NOTE



The Manipulator's serial number is indicated on the signature label on the back of the Manipulator.

## 3.4 Noise Countermeasures

To minimize electrical noise conditions, the following items must be observed in the system's cable wiring:

- The earth wire of the power supply should be grounded. (Ground resistance: 100Ω or less) It is important to ground the frame of Controller not only for prevention from electric shock, but also for reducing the influence of electric noise around the Controller. Therefore, be sure to connect the earth wire (yellow/green) of the Controller's power cable to the ground terminal of the factory power supply. For details about the plug and AC power cable, refer to the *Setup & Operation* "3.2.2 Power Plug".
- Do not tap power from a power line that connects to any equipment which may cause noise.
- When you tap power for the Controller and the single-phase AC motor from the same power line, change the phase of one or the other. Ensure that they will not be the same phase.
- Use a twisted pair motor power line.
- Do not run AC power lines and DC power lines in the same wiring duct, and separate them by at least 200 mm. For example, separate the AC motor power line and the Controller power line by at least 200 mm from the sensor or valve I/O lines; and do not bundle both sets of wiring with the same cable tie. If more than one duct/cable must cross each other, they should cross perpendicularly. The preferable example is shown in the right figure.
- For I/O lines, wire as short as possible and use a shielded cable and clamp the shield to the attached connector interior.
- Use a shielded cable for the EMERGENCY connector and clamp the shield to the interior of the connector.
- Make sure that the induction elements used to connect to the Controller's I/O (such as relays and solenoid valves) have surge suppressors. If an induction element without surge suppressor has been used, make sure to connect a rectifying diode right in front of the induction element. In selecting a rectifying diode, make sure that it can handle the voltage and current incurred by the induction load.
- To start and change revolutions of the conveyer's (or the like's) AC motor (ex: an induction motor or three-phase induction motor) regularly or abruptly, make sure to install a spark suppressor between the wires. The spark suppressor is more effective when placed closer to the motor.
- As they are easily influenced by static electricity or the noise from power source, keep the mouse and keyboard away from peripheral noise sources.

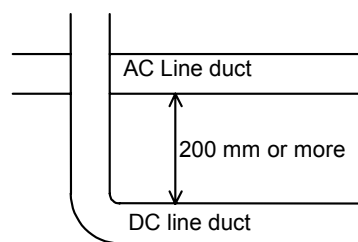

It is sometimes effective in suppressing such noise to wind the keyboard or mouse cables around a ferrite core several times.

## 4. OPTIONAL DEVICE Connector

The details of safety requirements for this section are described in the *Safety* chapter in User's Guide. Please refer to them to keep the robot system safe.

### 4.1 OPTIONAL DEVICE Connector



CAUTION

- Do not connect the EPSON RC+ software key to the OPTIONAL DEVICE connector. Connecting the EPSON RC+ software key to the OPTIONAL DEVICE connector while the Controller is ON may cause damage to the EPSON RC+ software key.  
Connect the EPSON RC+ software key to the IEEE-1284 (parallel) connector on the rear of the Controller.

The OPTIONAL DEVICE connector is used for an optional operation unit, ATTEND (TEACH) control device or OPTIONAL DEVICE Dummy Plug.

The "OPTIONAL DEVICE Dummy Plug", an accessory that comes with the Controller, must be connected to this connector if an operation unit or ATTEND (TEACH) control device is not used. The robot system will be in the Emergency Stop condition when this connector is left unconnected.

## 4.2 ATTEND (TEACH) Control Device

The name of the control device depends on the software used in your Controller as shown below

- EPSON RC+ : TEACH control device
- SPEL CT : ATTEND control device

To operate the Manipulator at a short distance without any operation unit (option), you should use the ATTEND (TEACH) control device. Create the ATTEND (TEACH) control device that consists of the following switches and connect it to the OPTIONAL DEVICE connector.

- Emergency Stop switch
- 3-position enable switch (dead-man switch)
- ATTEND (TEACH) control device enable/disable switch

Refer to the following the figure for the internal circuit and refer to the *Setup & Operation 4.4 Pin Assignments* for the signal.

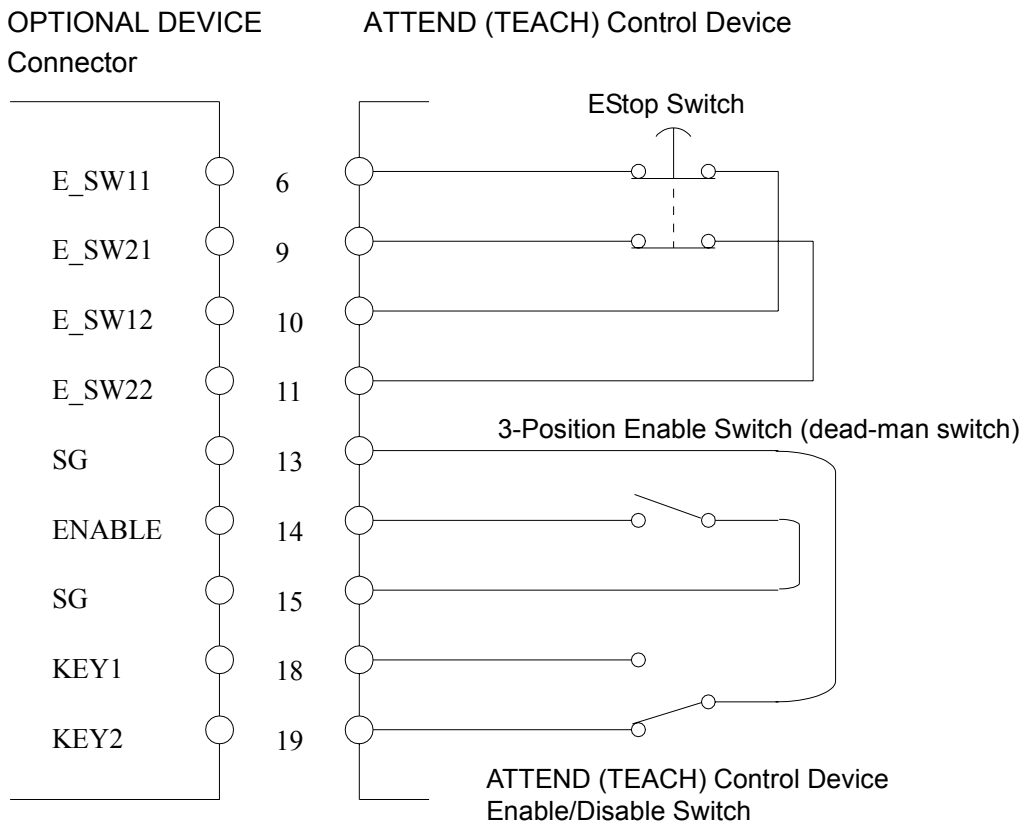

**NOTE** The 3-position enable switch is available when the ATTEND (TEACH) control device is enabled. The Emergency Stop switch is always available whether the ATTEND (TEACH) control device is enabled or disabled.



### 4.3 OPTIONAL DEVICE Dummy Plug

The OPTIONAL DEVICE Dummy Plug is connected to the OPTIONAL DEVICE connector when an operation unit or ATTEND (TEACH) control device is not used.

When manufacturing robotic systems without using the operation unit or ATTEND (TEACH) control device, you can use the dummy plug, as shown below, to disable the Emergency Stop input for the OPTIONAL DEVICE port, and the ATTEND (TEACH) control device enable/disable input.

In this case, however, you cannot operate the Manipulator while the safety door is open.

When designing and manufacturing robotic systems, follow the descriptions of the *Safety* chapter in EPSON RC+ User's Guide.

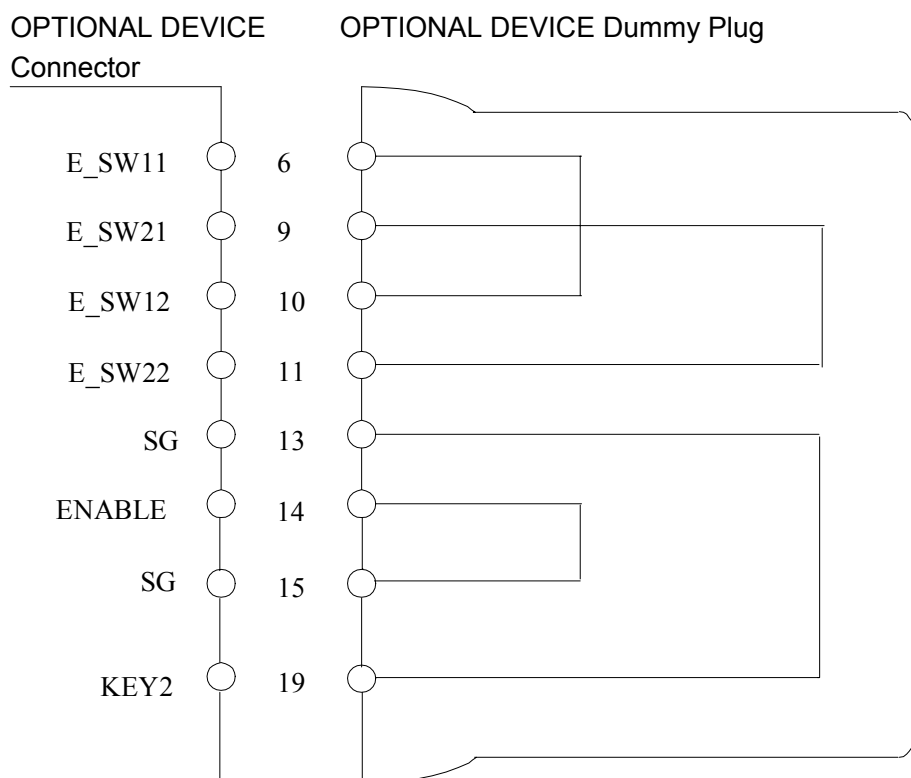

Connector	Standard
OPTIONAL DEVICE Dummy Plug	D-sub 25 pin #4-40 screw

## 4.4 Pin Assignments

In case you wish to connect the ATTEND (TEACH) control device enable/disable switch to the OPTIONAL DEVICE connector, refer to the following pin assignments.

Pin number	Signal name	Pin number	Signal name
1	FG	14	ENABLE
2	Not to be used	15	SG
3	Not to be used	16	Not to be used
4	Not to be used	17	Not to be used
5	Not to be used	18	KEY1
6	E_SW11	19	KEY2
7	SG	20	Not to be used
8	Not to be used	21	Not to be used
9	E_SW21	22	Not to be used
10	E_SW12	23	Not to be used
11	E_SW22	24	Not to be used
12	Not to be used	25	+12V
13	SG		

Each mode is dictated by the signals at KEY1 and KEY2 as follows:

Operation Condition		KEY1	KEY2
The ATTEND (TEACH) control device	Enabled	Connect to SG (13 pin)	Open
	Disabled	Open	Connect to SG (13 pin)

If you are connecting an Emergency Stop switch, connect it to the EMERGENCY connector on the rear of the Controller.

## 5. EMERGENCY Connector

NOTE



The details of safety requirements for this section are described in the *Safety* chapter in User's Guide. Please refer to them to keep the robot system safe.

### 5.1 Safety Door Switch and Latch Release Switch

The EMERGENCY connector has input terminals for the Safety Door switch and the Emergency Stop switch. Be sure to use these input terminals to keep the system safe. Use only the connector that comes as a standard accessory.

Connector	Standard
EMERGENCY connector	Rectangular, half-pitch, M2.6 screw

#### 5.1.1 Safety Door Switch

 WARNING	<ul style="list-style-type: none"> <li>■ The interlock of the Safety Door must be functioning when the robot system is operated. Do not operate the system under the condition that the switch cannot be turned ON/OFF (e.g. The tape is put around the switch.). Operating the robot system when the switch is not functioning properly is extremely hazardous and may cause serious safety problems as the Safety Door input cannot fulfill its intended function.</li> </ul>
--	---

In order to maintain a safe working zone, a safeguard must be erected around the Manipulator. The safeguard must have an interlock switch at the entrance to the working zoon. The Safety Door that is described in this manual is one of the safeguards and an interlock of the Safety Door is called a Safety Door switch. Connect the Safety Door switch to the Safety Door input terminal on the EMERGENCY connector. The Safety Door switch has safety features such as temporary hold-up of the program or the operation-prohibited status that are activated whenever the Safety Door is opened.

Observe the following in designing the Safety Door switch and the Safety Door.

- For the Safety Door switch, select a switch that opens as the Safety Door opens, and not by the spring of the switch itself.
- The signal from the Safety Door (Safety Door input) is designed to input to two redundant signals. If the signals at the two inputs differ by two seconds or more, the system recognizes it to be a critical error. Therefore, make sure that the Safety Door switch has two separate redundant circuits and that each connects to the specified pins at the EMERGENCY connector on the Controller.
- The Safety Door must be designed and installed so that it does not close accidentally.

### 5.1.2 Latch Release Switch

The controller software latches the following conditions:

- The safety door is open.
- The operation mode is “TEACH”.

The EMERGENCY connector has an input terminal for a latch release switch that cancels the latched conditions.

Open : The latch release switch latches conditions that the safety door is open or the operation mode is TEACH.

Closed : The latch release switch releases the latched conditions.

NOTE



When the latched TEACH mode is released while the safety door is open, the status of Manipulator power is operation-prohibited because the safety door is open at that time.

To execute a Manipulator operation, close the safety door again, and then close the latch release input.

### 5.1.3 Checking Latch Release Switch Operation

After connecting the safety door switch and latch release switch to the EMERGENCY connector, be sure to check the switch operation for safety by following the procedures described below before operating the Manipulator.

- (1) Turn ON the Controller while the safety door is open in order to boot the controller software.
- (2) Make sure that “Safety” is displayed on the main window status bar.
- (3) Close the safety door, and turn ON the switch connecting to the latch release input. Make sure that the “Safety” is dimmed on the status bar.

The information that the safety door is open can be latched by software based on the latch release input condition.

Open : The latch release switch latches condition that the safety door is open.

To cancel the condition, close the safety door, and then close the safety door latch release input.

Closed : The latch release switch does not latch the condition that the safety door is open.

NOTE



The latch release input also functions to acknowledge the change of TEACH mode.

In order to change the latched condition of the TEACH mode, turn the mode selector switch on the operation unit to the AUTO mode or turn the ATTEND (TEACH) control device enable/disable switch to “disable”. Then, close the latch release input.

## 5.2 Emergency Stop Switch



- Connect input signal wires for Emergency Stop and Safety Door to the EMERGENCY connector so that the Emergency Stop switch in the operation unit or the ATTEND (TEACH) control device connected to the OPTIONAL DEVICE connector always functions. (Refer to the typical application diagram in the *Setup & Operation 5.5 Circuit Diagrams*.)

### 5.2.1 Emergency Stop Switch

If it is desired to create an external Emergency Stop switch in addition to the Emergency Stop that an operation unit or ATTEND (TEACH) control device provides, make sure to connect such Emergency Stop switches to the proper pins on the EMERGENCY connector.

The Emergency Stop switch connected must comply with the following:

- It must be a push button switch that is “normally closed”.
- A button that does not automatically return or resume.
- The button must be mushroom-shaped and red.
- The button must have a double contact that is “normally closed”.

NOTE



The signal from the Emergency Stop switch is designed to use two redundant circuits. If the signals at the two circuits differ by two seconds or more, the system recognizes it as a critical error. Therefore, make sure that the Emergency Stop switch has double contacts and that each circuit connects to the specified pins on the EMERGENCY connector at the Controller. Refer to the *Setup & Operation 5.5 Circuit Diagrams*.

### 5.2.2 Checking Emergency Stop Switch Operation

Once the Emergency Stop switch is connected to the EMERGENCY connector, continue the following procedure to make sure that the switch functions properly. For the safety of the operator, the Manipulator must not be powered ON until the following test is completed.

- (1) Turn ON the Controller to boot the controller software while pressing the Emergency Stop switch.
- (2) Make sure that the “E-STOP” LED on the front of the Controller is ON.
- (3) Make sure that “E.Stop” is displayed on the status bar on the main window.
- (4) Release the Emergency Stop Switch.
- (5) Execute the RESET command.
- (6) Make sure that “E-STOP” LED is turned OFF and that “E-Stop” is dimmed on the main window status bar.

NOTE



For the emergency condition to work with the peripheral equipment at the input of the Emergency Stop at the Controller via the EMERGENCY connector, make sure that the desired equipment is connected to the Emergency Stop output terminals. The relay contacts at the EMERGENCY connector (#5 & #6) (normally closed) will open at the input of Emergency Stop state.

## 5.3 E. STOP Box



WARNING

- The E. STOP box is a temporary method until the safeguard, safety door, and emergency stop devices are installed in the robot system. The E. STOP box cannot thoroughly keep the robot system safe by itself. Therefore, be sure to install proper safeguard, safety door, and emergency stop devices in the robot system.

### 5.3.1 E. STOP Box

The E. STOP box is a unit for performing an emergency stop. When using the E. STOP box, connect it to the EMERGENCY connector.

The E. STOP box is provided with the Controller as a standard accessory when the Controller you purchased is UL specifications.

When connecting the Safety Door switch or Emergency Stop switch to the EMERGENCY connector, remove the E. STOP box from the connector.

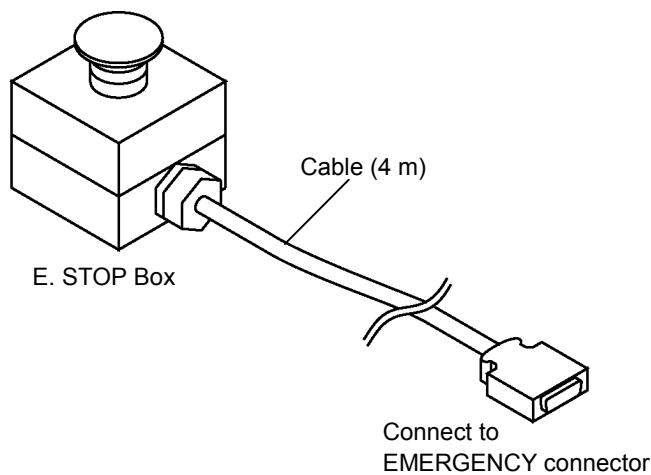

### 5.3.2 Checking E. STOP Box Operation

Once the E. STOP box is connected to the EMERGENCY connector, continue the following procedure to make sure that the E. STOP box functions properly. For the safety of the operator, the Manipulator must not be powered ON until the following test is completed.

- (1) Turn ON the Control Unit and the Drive Unit to boot the Controller while pressing the E. STOP box switch.
- (2) Make sure that the “E-STOP” LED on the Controller’s front panel is ON.
- (3) Make sure that “E.Stop” is displayed on the status bar on the monitor window.
- (4) Release the E. STOP box switch.
- (5) Execute the RESET command.
- (6) Make sure that “E-STOP” LED is turned OFF and the “E.Stop” is no longer visible (or dimmed) from the status bar.

## 5.4 Pin Assignments

The EMERGENCY connector pin assignments are as follows:

Pin No.	Signal	Function
1	E_SW11	Emergency Stop switch output (1) <sup>*3</sup>
2	E_SW12	
3	E.STOP1+	Emergency Stop input 1 (+)
4	E.STOP1-	Emergency Stop input 1 (-)
5	E.STOP OUT	Emergency Stop condition output (Relay contact) <sup>*1</sup>
6	E.STOP OUT	
7	GUARD11	Safety Door input (1) <sup>*2</sup>
8	GUARD12	
9	+24V	+24 V output
10	+24VGND	+24 V GND output
11	E_SW21	Emergency Stop switch output (2) <sup>*3</sup>
12	E_SW22	
13	E.STOP2+	Emergency Stop input 2 (+)
14	E.STOP2-	Emergency Stop input 2 (-)
15	RELEASE	Latch Release input
16	RELEASE	
17	GUARD21	Safety Door input (2) <sup>*2</sup>
18	GUARD22	
19	+24V	+24 V output
20	+24VGND	+24 V GND output

\*1 The Emergency Stop condition is output via relay contact when it is open (it is normally closed).

\*2 A critical error occurs if the input values from the Safety Door 1 and Safety Door 2 are different for two or more seconds. They must be connected to the same switch with two sets of contacts.

\*3 The signal from the Emergency Stop switch is designed to use two redundant circuits. An error occurs if the statuses of the two redundant circuits are different for two or more seconds. They must be connected to the same switch with two sets of contacts.

Emergency Stop switch output rated load	+30V 1A or under	1-2, 11-12 pin
Emergency Stop rated input voltage range	+24V $\pm$ 10%	3-4, 13-14 pin
Emergency Stop rated input current	10mA/24V input	
Safety Door rated input voltage range	+12 to 24V $\pm$ 10%	7-8, 17-18 pin
Safety Door rated input current	10mA/24V input	
Latch Release rated input voltage range	+12 to 24V $\pm$ 10%	15-16 pin
Latch Release rated input current	10mA/24V input	
Emergency Stop output relay contact rated load	+30V 0.5A or under	5-6 pin

NOTE



The total electrical resistance of the Emergency Stop switches and their circuit should be 1 $\Omega$  or less.

## 5.5 Circuit Diagrams

### 5.5.1 Example 1: External emergency stop switch typical application

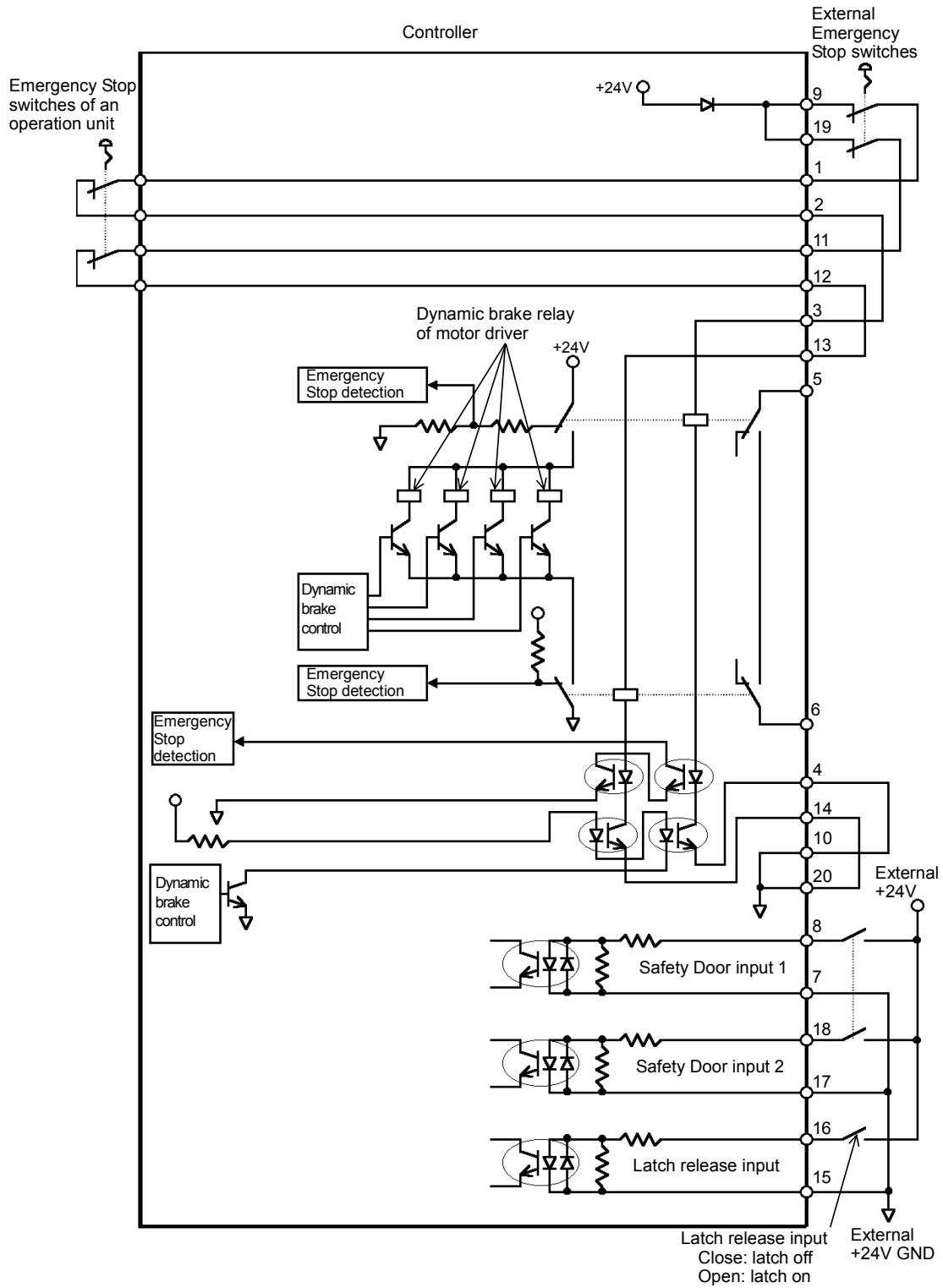



5.5.2 Example 2: External safety relay typical application

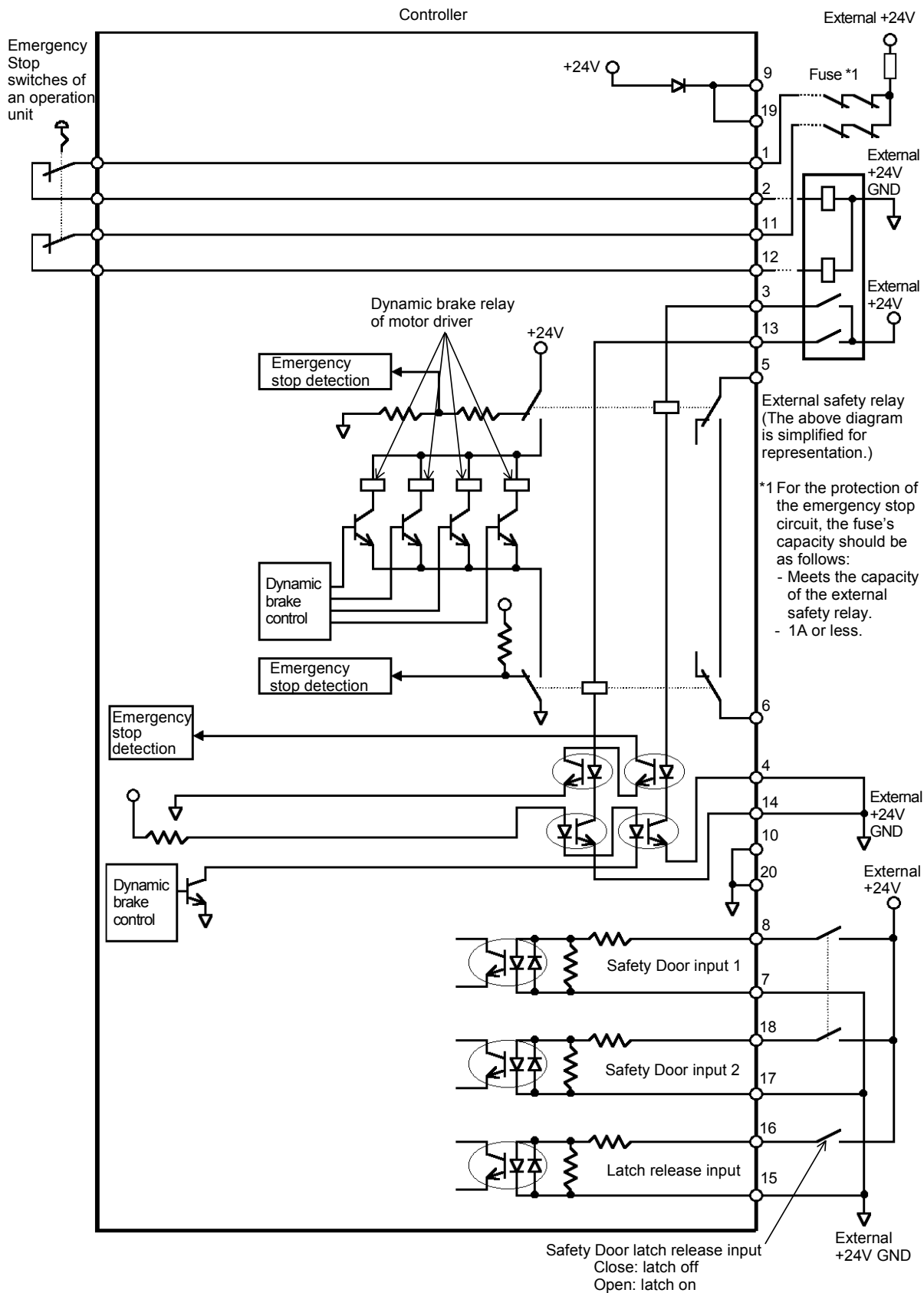



## 6. STANDARD I/O Connector

The STANDARD I/O connector is for connecting your input/output equipment to the system. It has pins for 16 inputs and 16 outputs.

The STANDARD I/O corresponds to the input/output bit numbers 0-15.

Refer to the *Setup & Operation 7. Expansion I/O Board - Optional* for the specified model of an expansion I/O Board.

For cable wiring, refer to the *Setup & Operation 3.4 Noise Countermeasures* in order to prevent noise.

## 6.1 Input Circuit

Input Voltage Range	: +12 to 24 V $\pm$ 10%
ON Voltage	: +10.8 V (min.)
OFF Voltage	: +5 V (max.)
Input Current	: 10 mA (TYP) at +24 V input

 <b>CAUTION</b>	<ul style="list-style-type: none"> <li>■ Use the PNP-type wiring diagram for CE conformance. Be sure to wire correctly. Improper wiring may cause safety problems as it may make the Manipulator move unusually.</li> <li>■ When the wiring for PNP or NPN type is changed, the jumper settings don't require changing.</li> </ul>
---	--

### Typical Input Circuit Application 1: NPN

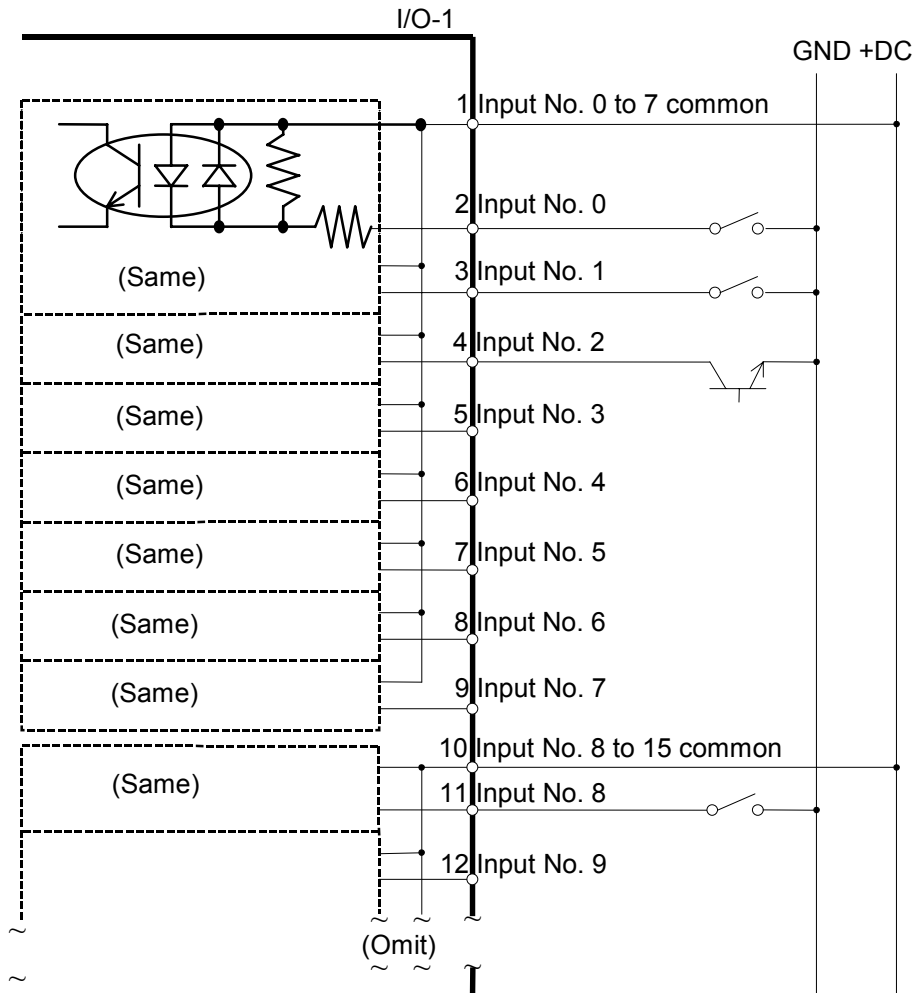

Typical Input Circuit Application 2: PNP

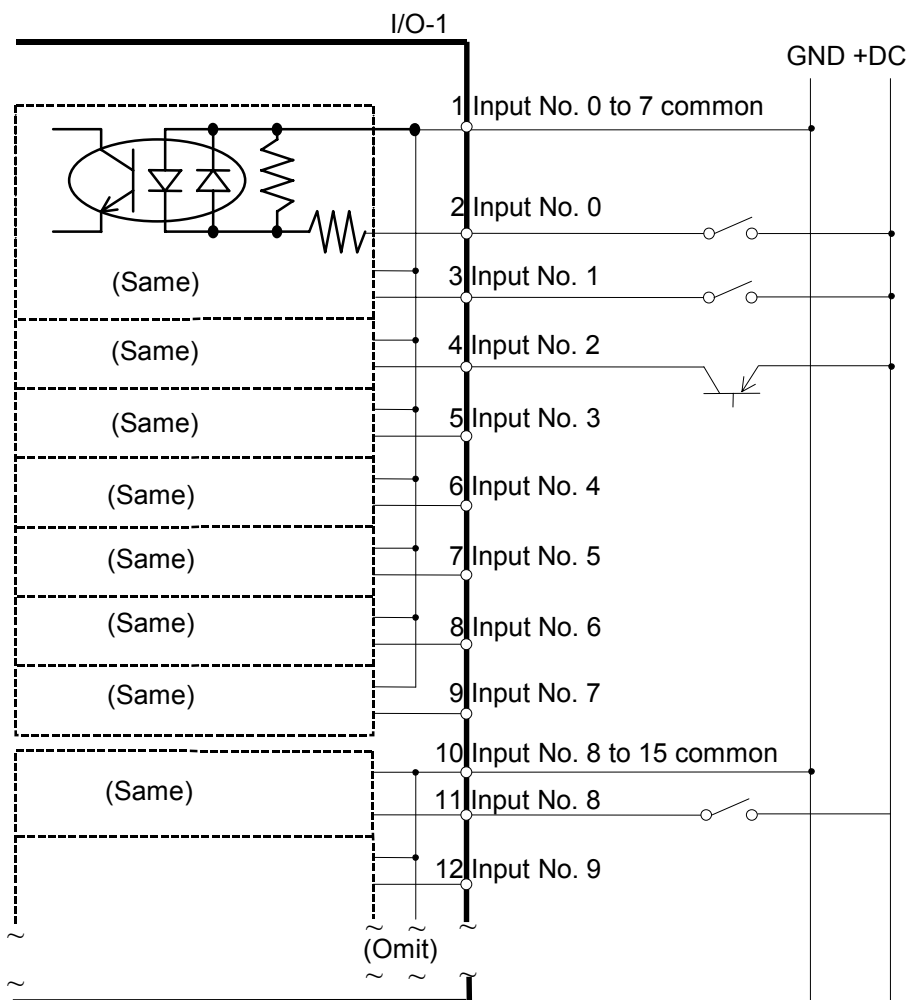

## 6.2 Output Circuit

- Rated Output Voltage : +12 V to 24 V ±10%
- Maximum Output Current : TYP 120 mA/1 output
- Output Driver : Photo MOS Relay
- On-State Resistance (average) : 23.5 Ω or less

 <b>CAUTION</b>	<ul style="list-style-type: none"> <li>■ Use the PNP-type wiring diagram for CE conformance. Be sure to wire correctly. Improper wiring may cause safety problems as it may make the Manipulator move unusually.</li> </ul>
---	---

### Typical Output Circuit Application 1: NPN

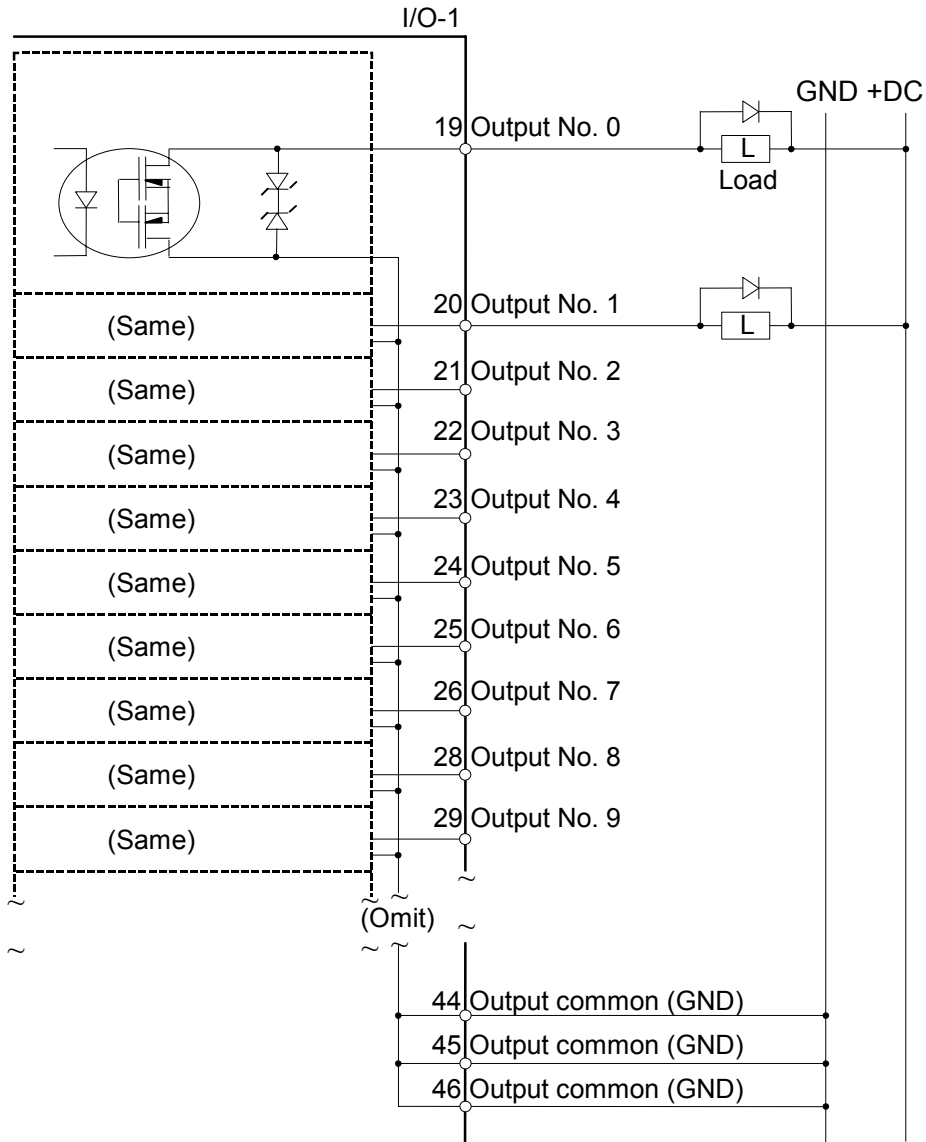

Typical Output Circuit Application 2: PNP

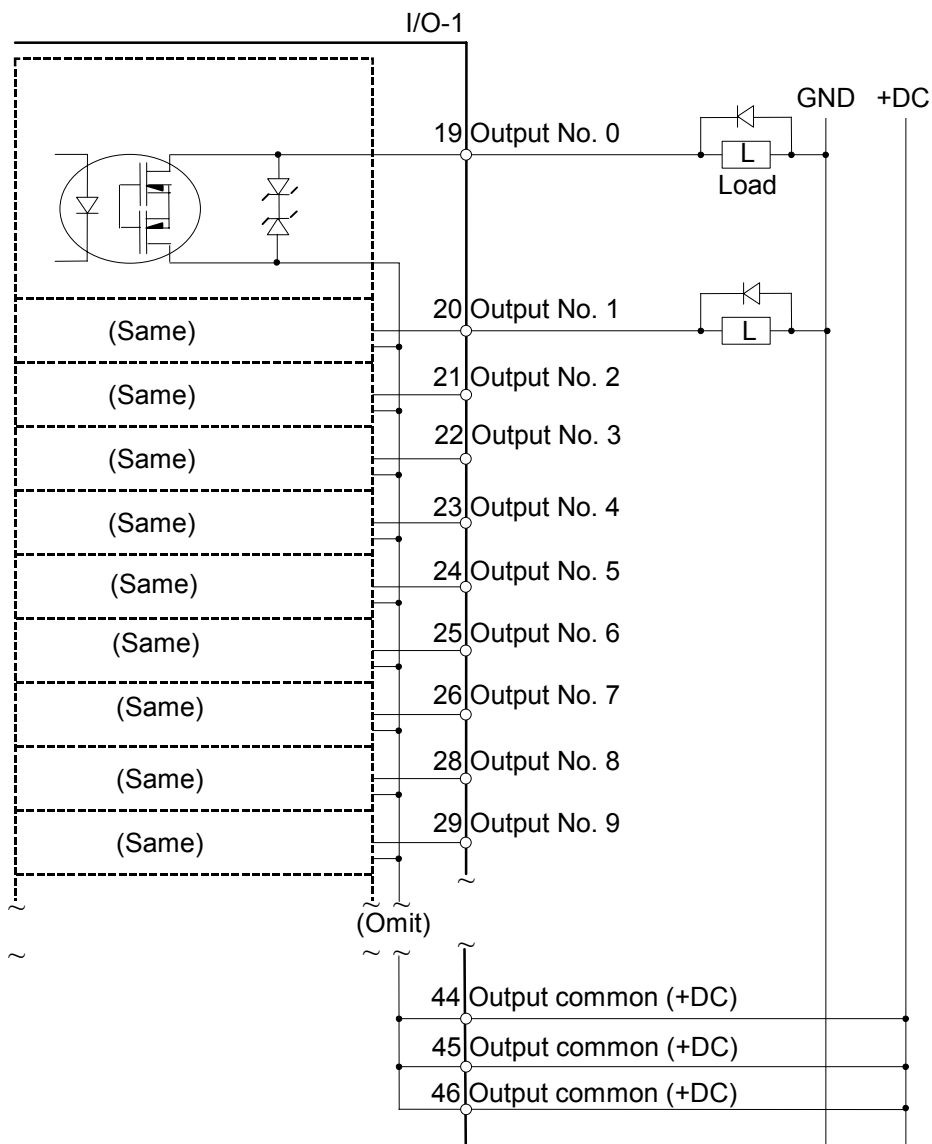

## 6.3 Pin Assignments

### 6.3.1 STANDARD I/O connector - Pin Assignments

Pin No.	Signal Name	Pin No.	Signal Name
1	Input common No. 0 to 7	26	Output No. 7
2	Input No. 0	27	NC
3	Input No. 1	28	Output No. 8
4	Input No. 2	29	Output No. 9
5	Input No. 3	30	NC
6	Input No. 4	31	Output No.10
7	Input No. 5	32	Output No.11
8	Input No. 6	33	NC
9	Input No. 7	34	Output No.12
10	Input common No. 8 to 15	35	NC
11	Input No. 8	36	Output No.13
12	Input No. 9	37	NC
13	Input No. 10	38	Output No. 14
14	Input No. 11	39	NC
15	Input No. 12	40	NC
16	Input No. 13	41	Output No. 15
17	Input No. 14	42	NC
18	Input No. 15	43	NC
19	Output No. 0	44	Output common
20	Output No. 1	45	Output common
21	Output No. 2	46	Output common
22	Output No. 3	47	+24V Output
23	Output No. 4	48	+24V Output
24	Output No. 5	49	+24V GND Output
25	Output No. 6	50	+24V GND Output

Connector	Standard
STANDARD I/O Connector	D-Sub 50 pin #4-40 screw



### 6.3.2 STANDARD I/O connector optional cable for USA Specification - Pin Assignments

The STANDARD I/O cable is an optional part and for USA specification.

Pin No.	Signal Name	Pin No.	Signal Name
1	Input common No. 0 to 7	26	Output No. 7
2	Input No. 0	27	NC
3	Input No. 1	28	Output No. 8
4	Input No. 2	29	Output No. 9
5	Input No. 3	30	NC
6	Input No. 4	31	Output No.10
7	Input No. 5	32	Output No.11
8	Input No. 6	33	NC
9	Input No. 7	34	Output No.12
10	Input common No. 8 to 15	35	NC
11	Input No. 8	36	Output No.13
12	Input No. 9	37	NC
13	Input No. 10	38	Output No. 14
14	Input No. 11	39	NC
15	Input No. 12	40	NC
16	Input No. 13	41	Output No. 15
17	Input No. 14	42	NC
18	Input No. 15	43	NC
19	Output No. 0	44	Output common
20	Output No. 1	45	Output common
21	Output No. 2	46	Output common
22	Output No. 3	47	+24V Output
23	Output No. 4	48	+24V Output
24	Output No. 5	49	+24V GND Output
25	Output No. 6	50	+24V GND Output



## 7. Expansion I/O Board - Optional

### 7.1 Expansion I/O Board

Install an expansion I/O board in an ISA slot in the Controller when extra inputs or outputs are desired.

Each additional expansion I/O board provides 32 inputs and 32 outputs. The number of I/Os that can be expanded is subject to the number of ISA slots available in the type of Controller used.

The input and output bit #s are assigned as follows.

Input Bit #	Output Bit #	Applicable Hardware
0 to 15	0 to 15	Controller Standard I/O
48 to 79	48 to 79	The 1st Expansion I/O board
80 to 111	80 to 111	The 2nd Expansion I/O board
⋮	⋮	⋮

The types of the optional expansion I/O board are listed below.

Board Name	Input/Output Type	Output Circuit	Overcurrent Protection
Protected Expansion I/O board	NPN	Hybrid IC SEP007	Available
Protected Expansion I/O board	PNP	Hybrid IC SEP008	Available
Expansion I/O board	NPN	Transistor array and photo coupler	Not Available



CAUTION

- Use the PNP-type of protected Expansion I/O Board for CE conformance.
- Be sure to wire the output circuit properly. Especially the expansion I/O board has no protection circuitry for short-circuit and reverse-connection. Improper wiring may cause malfunction of the parts on the board and then improper function of the robot system.

## 7.2 Protected Expansion I/O Board

### 7.2.1 Protected Expansion I/O Board : Jumper Settings

The I/O board address is defined by the jumpers JP1, 2, and 3.

#### JP1, JP2

The table below shows the settings for JP1 and JP2 on each board. The table is oriented the same way that the jumpers are on the board (address bit increases from left to right).

Board #	Address	JP 1							
		1-2 A8	3-4 A9	5-6 A10	7-8 A11	9-10 A12	11-12 A13	13-14 A14	15-16 A15
1	700				Short	Short	Short	Short	Short
2	710				Short	Short	Short	Short	Short
3	720				Short	Short	Short	Short	Short
4	730				Short	Short	Short	Short	Short

Board #	Address	JP 2				
		1-2 A3	3-4 A4	5-6 A5	7-8 A6	9-10 A7
1	700	Short	Short	Short	Short	Short
2	710	Short		Short	Short	Short
3	720	Short	Short		Short	Short
4	730	Short			Short	Short

Short: Short-circuit, Blank: Open

#### JP3

Short-circuit 1-2, 4-5, 7-8 and 10-11.

#### JP4, 5, 6

Normally open.

When the Expansion I/O Board is used, the appropriate software settings must be done in addition to the jumper settings. For details about software settings, refer to the section, *Expansion I/O Board Software Configuration* in the chapter, *I/O Systems* in EPSON RC+ User's Guide.

**7.2.2 Protected Expansion I/O Board : Input Circuit**

The following diagrams illustrate cases where #48 through #79 (for the first Expansion I/O Board) are assigned to the Protected Expansion I/O Board's (or Expansion I/O Board's) inputs and outputs. The I/O number assignment depends on the controller software settings.

- Input Voltage Range : + 12 V to 24 V ±10%
- ON Voltage : + 10.8 V (Min.)
- OFF Voltage : + 5 V (Max.)
- Input Current : 10 mA (TYP) at + 24 V input

 <b>CAUTION</b>	<ul style="list-style-type: none"> <li>■ Use the PNP-type of wiring diagram for CE conformance. Be sure to wire correctly. Improper wiring may cause safety problems as it may make the Manipulator move unusually.</li> </ul>
---	--

Protected Expansion I/O Board  
 Typical Input Circuit Application 1: NPN

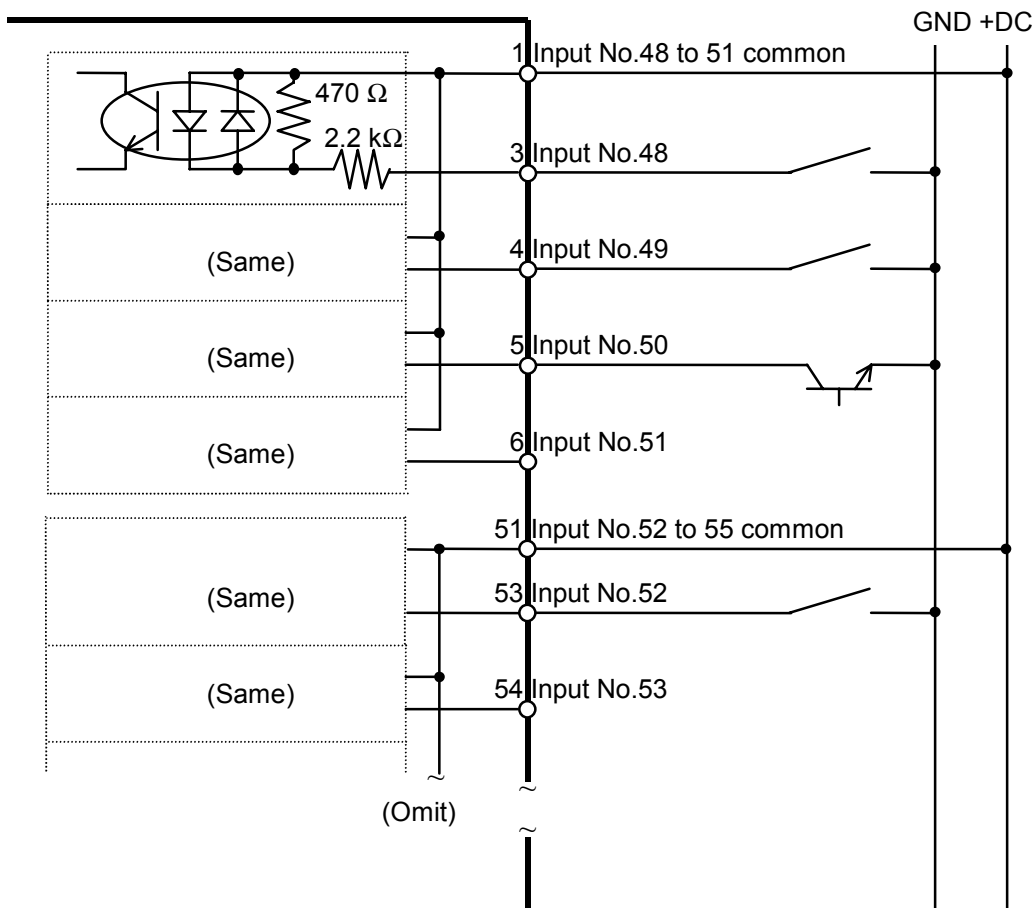

Protected Expansion I/O Board  
 Typical Input Circuit Application 2: PNP

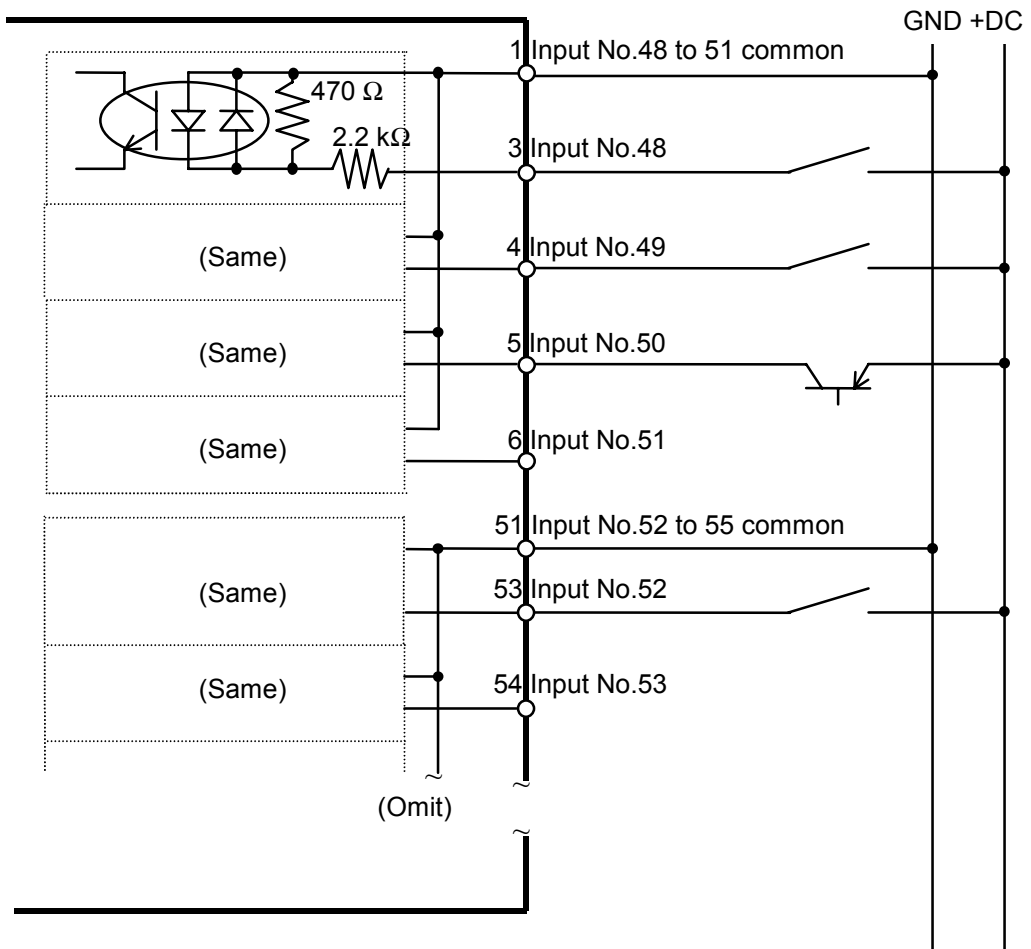

### 7.2.3 Protected Expansion I/O Board : Output Circuit

The following diagrams illustrate cases where #48 through #79 (for the first Expansion I/O Board) are assigned to the Protected Expansion I/O Board's inputs and outputs. The I/O number assignment depends on the controller software settings.



- Use the PNP-type of wiring diagram for CE conformance. Be sure to wire correctly. Improper wiring may cause safety problems as it may make the Manipulator move unusually.

Protected Expansion I/O Board  
Typical Output Circuit Application 1: NPN

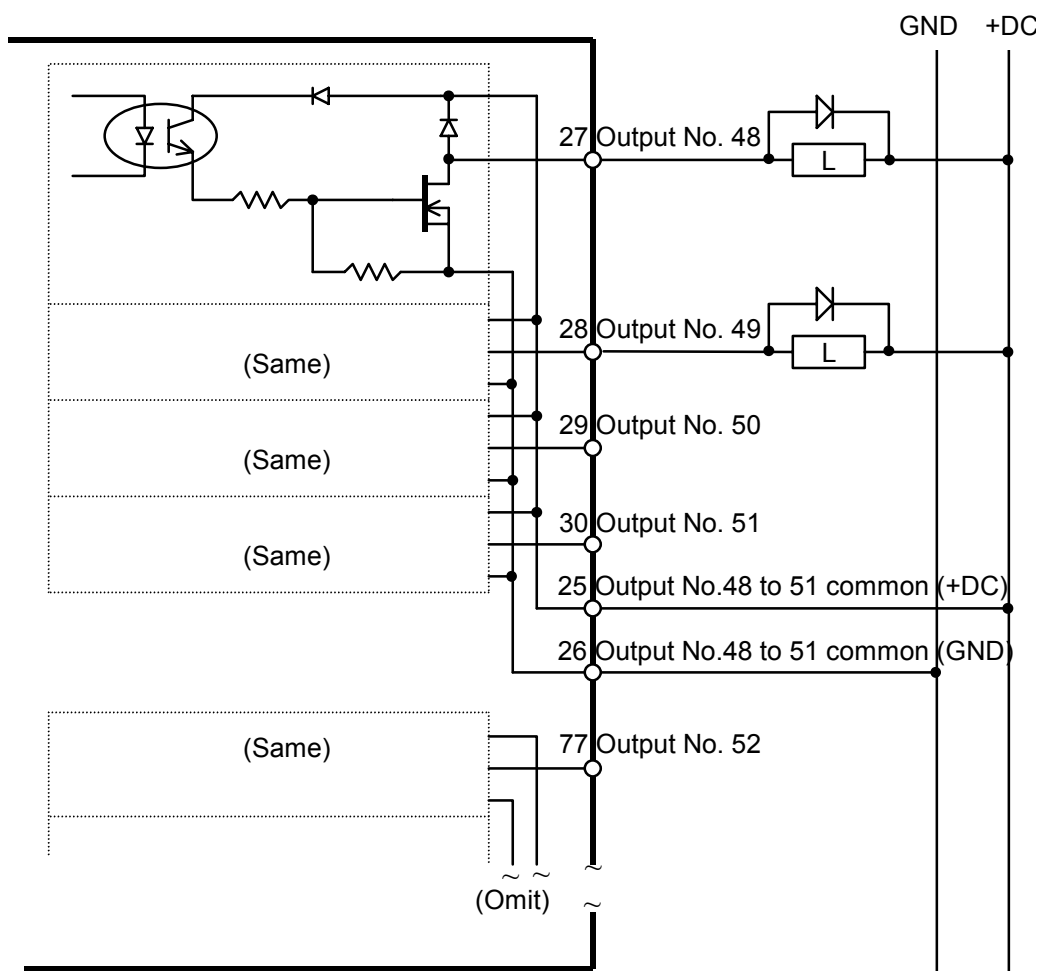

Rated Output Voltage : + 12 V to 24 V  $\pm 10\%$   
 Maximum Output current : 250 mA/1 output  
 Output Driver : N channel power MOS FET  
 Saturation Voltage : 1.0 V or under

Protected Expansion I/O Board  
 Typical Output Circuit Application 2: PNP

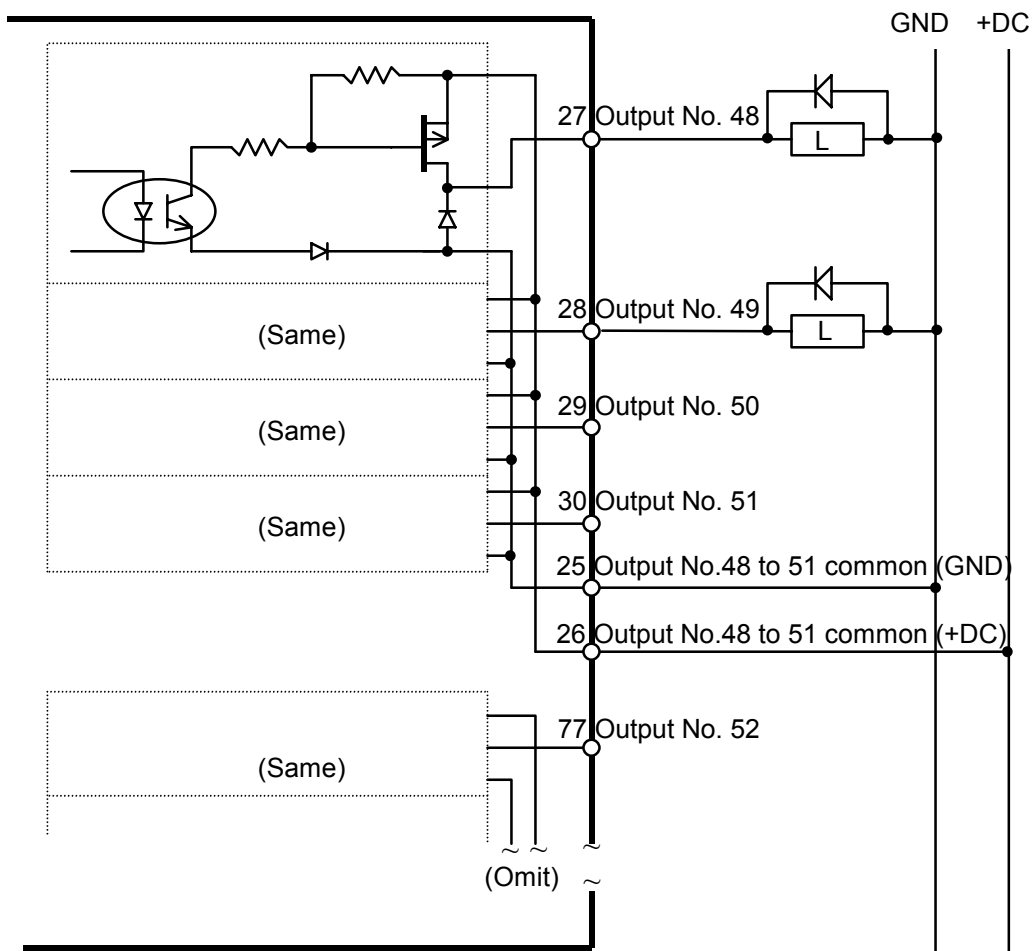

Rated Output Voltage	: + 12 V to 24 V $\pm$ 10%
Maximum Output current	: 250 mA/1 output
Output Driver	: P channel power MOS FET
Saturation Voltage	: 1.0 V or under



## 7.3 Expansion I/O Board

### 7.3.1 Expansion I/O Board : Jumper Settings

The I/O board address is defined by the jumpers JP1, JP2, and JP3.

#### JP1, JP2

The table below shows the settings for JP1 and JP2 on each board. The table is oriented the same way that the jumpers are on the board (address bit increases from left to right).

Board #	Address	JP 1							
		1-2 A8	3-4 A9	5-6 A10	7-8 A11	9-10 A12	11-12 A13	13-14 A14	15-16 A15
1	700				Short	Short	Short	Short	Short
2	710				Short	Short	Short	Short	Short
3	720				Short	Short	Short	Short	Short
4	730				Short	Short	Short	Short	Short

Board #	Address	JP 2				
		1-2 A3	3-4 A4	5-6 A5	7-8 A6	9-10 A7
1	700	Short	Short	Short	Short	Short
2	710	Short		Short	Short	Short
3	720	Short	Short		Short	Short
4	730	Short			Short	Short

Short: Short-circuit, Blank: Open

#### JP3

Short-circuit 1-2, 4-5, 7-8 and 10-11.

#### JP4, 5, 6

Normally open.

When an Expansion I/O Board is used, the appropriate software settings must be done in addition to the jumper settings. For details about software settings, refer to the section, *ISA I/O Board Software Configuration* in the chapter, *I/O Systems* in EPSON RC+ User's Guide.

### 7.3.2 Expansion I/O Board : Input Circuit

The input circuit is the same as the NPN type of the protected expansion I/O board. Refer to the *Setup & Operation 7.2.2 Protected Expansion I/O board : Input Circuit* for details.

### 7.3.3 Expansion I/O Board : Output Circuit

The following diagrams illustrate cases where #48 through #79 (for the first Expansion I/O Board) are assigned to the Expansion I/O Board's inputs and outputs. The I/O number assignment depends on the software settings.

Expansion I/O Board

I/O Typical Output Circuit Application 1:

Output #48 to #55 (the 8 points from the first point in among the 32 points in a board)

 <b>CAUTION</b>	<p>■ Be sure to wire the output circuit properly because it has no protection circuitry for short-circuit and reverse-connection. Improper wiring may cause malfunction of the parts on the board and then improper function of the robot system.</p>
---	---

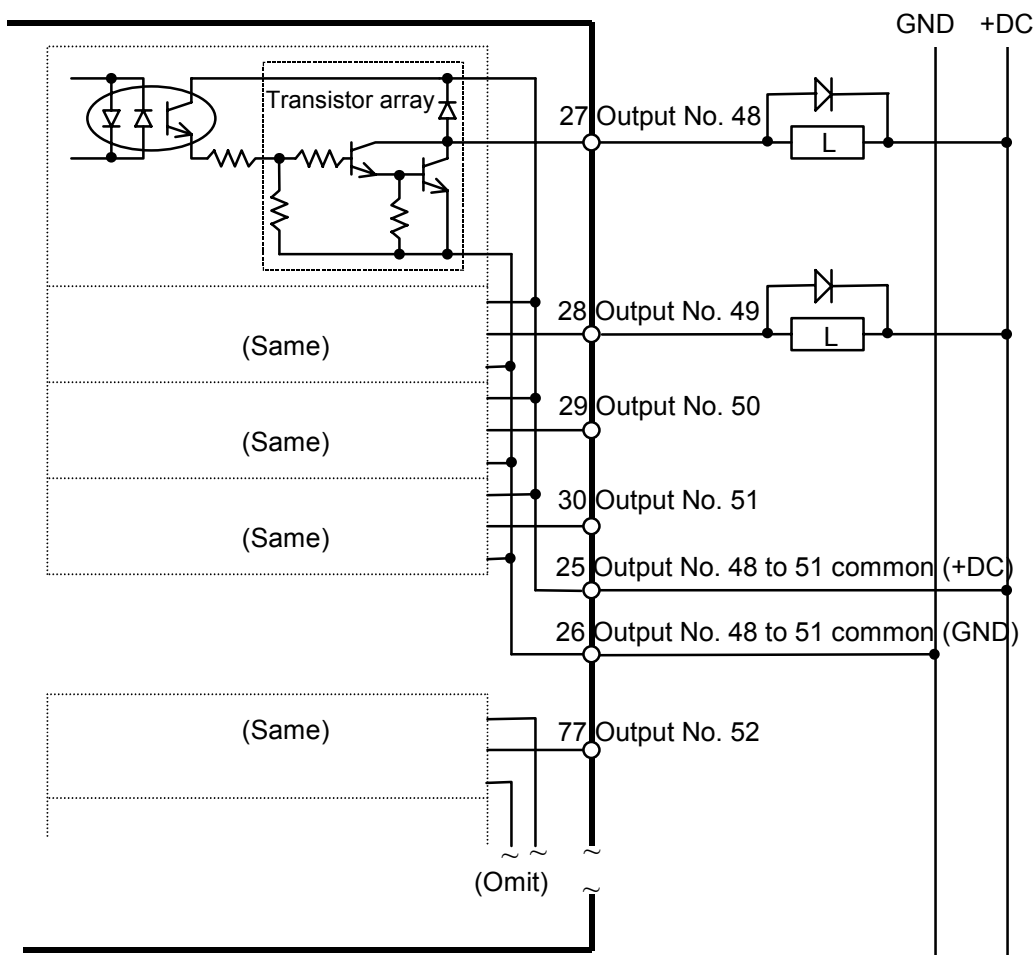

Rated Output Voltage : + 12 V to 24 V  $\pm 10\%$

Maximum Output current : 250 mA/1 output

Output Driver : Transistor array

Saturation Voltage : 1.6 V or under

Expansion I/O Board  
 Typical Output Circuit Application 2:  
 Output #56 to #79 (the 24 points from the last thirty-second point in a board)

 CAUTION	<p>■ Be sure to wire the output circuit properly because it has no protection circuitry for short-circuit and reverse-connection. Improper wiring may cause malfunction of the parts on the board and then improper function of the robot system.</p>
--	---

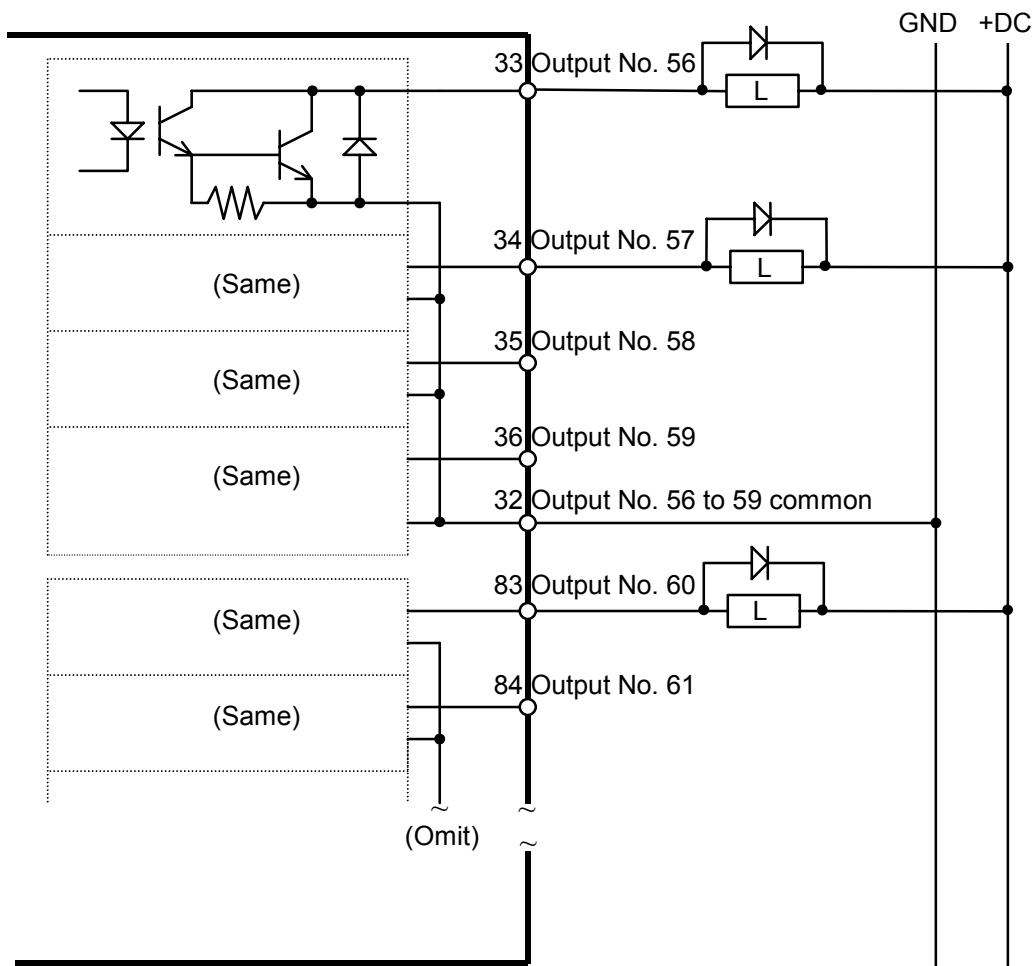

- Rated Output Voltage : + 12 V to 24 V ±10%
- Maximum Output Current : 100 mA/1 output
- Output Driver : Photo coupler
- Saturation Voltage : 1.6 V or under

## 7.4 Expansion I/O Board : Pin Assignments

### 7.4.1 Expansion I/O Board : Pin Assignments (NPN type)

NPN : Pin No. 1-50

Pin No.	Signal Name	Pin No.	Signal Name
1	Input common A (No. 48 to 51)	26	Output common A (GND: No. 48 to 51)
2	NC	27	Output No.48
3	Input No.48	28	Output No.49
4	Input No.49	29	Output No.50
5	Input No.50	30	Output No.51
6	Input No.51	31	Output common C (+DC: No. 56 to 59)
7	Input common C (No. 56 to 59)	32	Output common C (GND: No. 56 to 59)
8	NC	33	Output No.56
9	Input No.56	34	Output No.57
10	Input No.57	35	Output No.58
11	Input No.58	36	Output No.59
12	Input No.59	37	Output common E (+DC: No. 64 to 67)
13	Input common E (No. 64 to 67)	38	Output common E (GND: No. 64 to 67)
14	NC	39	Output No.64
15	Input No.64	40	Output No.65
16	Input No.65	41	Output No.66
17	Input No.66	42	Output No.67
18	Input No.67	43	Output common G (+DC: No. 72 to 75)
19	Input common G (No. 72 to 75)	44	Output common G (GND: No. 72 to 75)
20	NC	45	Output No.72
21	Input No.72	46	Output No.73
22	Input No.73	47	Output No.74
23	Input No.74	48	Output No.75
24	Input No.75	49	FG
25	Output common A (+DC: No. 48 to 51)	50	FG

NPN : Pin No. 51-100

Pin No.	Signal Name	Pin No.	Signal Name
51	Input common B (No. 52 to 55)	76	Output common B (GND: No. 52 to 55)
52	NC	77	Output No.52
53	Input No.52	78	Output No.53
54	Input No.53	79	Output No.54
55	Input No.54	80	Output No.55
56	Input No.55	81	Output common D (+DC: No. 60 to 63)
57	Input common D (No. 60 to 63)	82	Output common D (GND: No. 60 to 63)
58	NC	83	Output No.60
59	Input No.60	84	Output No.61
60	Input No.61	85	Output No.62
61	Input No.62	86	Output No.63
62	Input No.63	87	Output common F (+DC: No. 68 to 71)
63	Input common F (No. 68 to 71)	88	Output common F (GND: No. 68 to 71)
64	NC	89	Output No.68
65	Input No.68	90	Output No.69
66	Input No.69	91	Output No.70
67	Input No.70	92	Output No.71
68	Input No.71	93	Output common H (+DC: No. 76 to 79)
69	Input common H (No. 76 to 79)	94	Output common H (GND: No. 76 to 79)
70	NC	95	Output No.76
71	Input No.76	96	Output No.77
72	Input No.77	97	Output No.78
73	Input No.78	98	Output No.79
74	Input No.79	99	FG
75	Output common B (+DC: No. 52 to 55)	100	FG

## 7.4.2 Expansion I/O Board : Pin Assignments (PNP type)

PNP : Pin No. 1-50

Pin No.	Signal Name	Pin No.	Signal Name
1	Input common A (No. 48 to 51)	26	Output common A (+DC: No. 48 to 51)
2	NC	27	Output No.48
3	Input No.48	28	Output No.49
4	Input No.49	29	Output No.50
5	Input No.50	30	Output No.51
6	Input No.51	31	Output common C (GND: No. 56 to 59)
7	Input common C (No. 56 to 59)	32	Output common C (+DC: No. 56 to 59)
8	NC	33	Output No.56
9	Input No.56	34	Output No.57
10	Input No.57	35	Output No.58
11	Input No.58	36	Output No.59
12	Input No.59	37	Output common E (GND: No. 64 to 67)
13	Input common E (No. 64 to 67)	38	Output common E (+DC: No. 64 to 67)
14	NC	39	Output No.64
15	Input No.64	40	Output No.65
16	Input No.65	41	Output No.66
17	Input No.66	42	Output No.67
18	Input No.67	43	Output common G (GND: No. 72 to 75)
19	Input common G (No. 72 to 75)	44	Output common G (+DC: No. 72 to 75)
20	NC	45	Output No.72
21	Input No.72	46	Output No.73
22	Input No.73	47	Output No.74
23	Input No.74	48	Output No.75
24	Input No.75	49	FG
25	Output common A (GND: No. 48 to 51)	50	FG

## PNP : Pin No. 51-100

Pin No.	Signal Name	Pin No.	Signal Name
51	Input common B (No. 52 to 55)	76	Output common B (+DC: No. 52 to 55)
52	NC	77	Output No.52
53	Input No.52	78	Output No.53
54	Input No.53	79	Output No.54
55	Input No.54	80	Output No.55
56	Input No.55	81	Output common D (GND: No. 60 to 63)
57	Input common D (No. 60 to 63)	82	Output common D (+DC: No. 60 to 63)
58	NC	83	Output No.60
59	Input No.60	84	Output No.61
60	Input No.61	85	Output No.62
61	Input No.62	86	Output No.63
62	Input No.63	87	Output common F (GND: No. 68 to 71)
63	Input common F (No. 68 to 71)	88	Output common F (+DC: No. 68 to 71)
64	NC	89	Output No.68
65	Input No.68	90	Output No.69
66	Input No.69	91	Output No.70
67	Input No.70	92	Output No.71
68	Input No.71	93	Output common H (GND: No. 76 to 79)
69	Input common H (No. 76 to 79)	94	Output common H (+DC: No. 76 to 79)
70	NC	95	Output No.76
71	Input No.76	96	Output No.77
72	Input No.77	97	Output No.78
73	Input No.78	98	Output No.79
74	Input No.79	99	FG
75	Output common B (GND: No. 52 to 55)	100	FG

## 7.5 Expansion I/O Connector

### 7.5.1 Pin Layout of Expansion I/O Connector

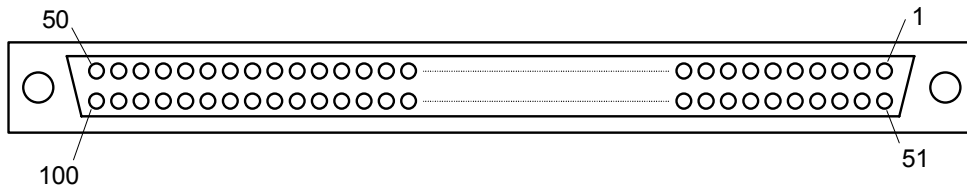

Internal power is not connected to the Expansion I/O connector. Therefore, an external power source must be supplied.

### 7.5.2 Expansion I/O Connector Cable

The Expansion I/O connector cable is an optional part. It has a 100-pin connector on one end and two 50-pin connectors on the other end.

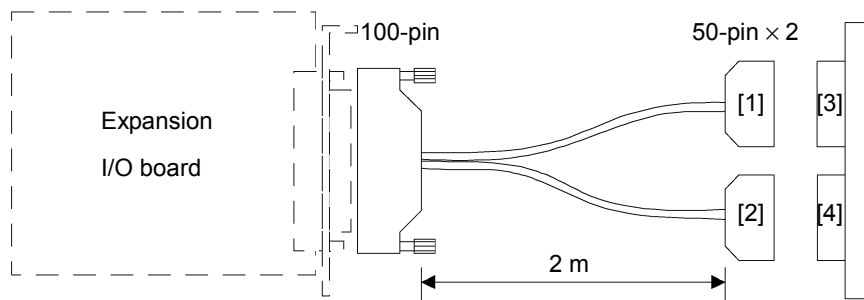



## 7.5.3 Expansion I/O Connector Cable – Pin Assignments

Expansion I/O connector cable - Pin Assignments: NPN  
Connector on the cable side [1]

Pin No.	Signal Name	Pin No.	Signal Name
1 (1)	Input common A (No. 48 to 51)	26 (25)	Output common A (+DC: No. 48 to 51)
2 (2)	NC	27 (26)	Output common A (GND: No. 48 to 51)
3 (3)	Input No.48	28 (27)	Output No.48
4 (4)	Input No.49	29 (28)	Output No.49
5 (5)	Input No.50	30 (29)	Output No.50
6 (6)	Input No.51	31 (30)	Output No.51
7 (51)	Input common B (No. 52 to 55)	32 (75)	Output common B (+DC: No. 52 to 55)
8 (52)	NC	33 (76)	Output common B (GND: No. 52 to 55)
9 (53)	Input No.52	34 (77)	Output No.52
10 (54)	Input No.53	35 (78)	Output No.53
11 (55)	Input No.54	36 (79)	Output No.54
12 (56)	Input No.55	37 (80)	Output No.55
13 (7)	Input common C (No. 56 to 59)	38 (31)	Output common C (+DC: No. 56 to 59)
14 (8)	NC	39 (32)	Output common C (GND: No. 56 to 59)
15 (9)	Input No.56	40 (33)	Output No.56
16 (10)	Input No.57	41 (34)	Output No.57
17 (11)	Input No.58	42 (35)	Output No.58
18 (12)	Input No.59	43 (36)	Output No.59
19 (57)	Input common D (No. 60 to 63)	44 (81)	Output common D (+DC: No. 60 to 63)
20 (58)	NC	45 (82)	Output common D (GND: No. 60 to 63)
21 (59)	Input No.60	46 (83)	Output No.60
22 (60)	Input No.61	47 (84)	Output No.61
23 (61)	Input No.62	48 (85)	Output No.62
24 (62)	Input No.63	49 (86)	Output No.63
25 (49)	FG	50 (50)	FG

The number in parentheses in the Pin No. above means the corresponding pin number on the 100-pin connector.

Expansion I/O connector cable - Pin Assignments: NPN  
Connector on the cable side [2]

Pin No.	Signal Name	Pin No.	Signal Name
1 (13)	Input common E (No. 64 to 67)	26 (37)	Output common E (+DC: No. 64 to 67)
2 (14)	NC	27 (38)	Output common E (GND: No. 64 to 67)
3 (15)	Input No.64	28 (39)	Output No.64
4 (16)	Input No.65	29 (40)	Output No.65
5 (17)	Input No.66	30 (41)	Output No.66
6 (18)	Input No.67	31 (42)	Output No.67
7 (63)	Input common F (No. 68 to 71)	32 (87)	Output common F (+DC: No. 68 to 71)
8 (64)	NC	33 (88)	Output common F (GND: No. 68 to 71)
9 (65)	Input No.68	34 (89)	Output No.68
10 (66)	Input No.69	35 (90)	Output No.69
11 (67)	Input No.70	36 (91)	Output No.70
12 (68)	Input No.71	37 (92)	Output No.71
13 (19)	Input common G (No. 72 to 75)	38 (43)	Output common G (+DC: No. 72 to 75)
14 (20)	NC	39 (44)	Output common G (GND: No. 72 to 75)
15 (21)	Input No.72	40 (45)	Output No.72
16 (22)	Input No.73	41 (46)	Output No.73
17 (23)	Input No.74	42 (47)	Output No.74
18 (24)	Input No.75	43 (48)	Output No.75
19 (69)	Input common H (No. 76 to 79)	44 (93)	Output common H (+DC: No. 76 to 79)
20 (70)	NC	45 (94)	Output common H (GND: No. 76 to 79)
21 (71)	Input No.76	46 (95)	Output No.76
22 (72)	Input No.77	47 (96)	Output No.77
23 (73)	Input No.78	48 (97)	Output No.78
24 (74)	Input No.79	49 (98)	Output No.79
25 (99)	FG	50 (100)	FG

The number in parentheses in the Pin No. above means the corresponding pin number on the 100-pin connector.

Expansion I/O connector cable – Pin Assignments: PNP  
Connector on the cable side [1]

Pin No.	Signal Name	Pin No.	Signal Name
1 (1)	Input common A (No. 48 to 51)	26 (25)	Output common A (GND: No. 48 to 51)
2 (2)	NC	27 (26)	Output common A (+DC: No. 48 to 51)
3 (3)	Input No.48	28 (27)	Output No.48
4 (4)	Input No.49	29 (28)	Output No.49
5 (5)	Input No.50	30 (29)	Output No.50
6 (6)	Input No.51	31 (30)	Output No.51
7 (51)	Input common B (No. 52 to 55)	32 (75)	Output common B (GND: No. 52 to 55)
8 (52)	NC	33 (76)	Output common B (+DC: No. 52 to 55)
9 (53)	Input No.52	34 (77)	Output No.52
10 (54)	Input No.53	35 (78)	Output No.53
11 (55)	Input No.54	36 (79)	Output No.54
12 (56)	Input No.55	37 (80)	Output No.55
13 (7)	Input common C (No. 56 to 59)	38 (31)	Output common C (GND: No. 56 to 59)
14 (8)	NC	39 (32)	Output common C (+DC: No. 56 to 59)
15 (9)	Input No.56	40 (33)	Output No.56
16 (10)	Input No.57	41 (34)	Output No.57
17 (11)	Input No.58	42 (35)	Output No.58
18 (12)	Input No.59	43 (36)	Output No.59
19 (57)	Input common D (No. 60 to 63)	44 (81)	Output common D (GND: No. 60 to 63)
20 (58)	NC	45 (82)	Output common D (+DC: No. 60 to 63)
21 (59)	Input No.60	46 (83)	Output No.60
22 (60)	Input No.61	47 (84)	Output No.61
23 (61)	Input No.62	48 (85)	Output No.62
24 (62)	Input No.63	49 (86)	Output No.63
25 (49)	FG	50 (50)	FG

The number in parentheses in the Pin No. above means the corresponding pin number on the 100-pin connector.

Expansion I/O connector cable – Pin Assignments: PNP  
Connector on the cable side [2]

Pin No.	Signal Name	Pin No.	Signal Name
1 (13)	Input common E (No. 64 to 67)	26 (37)	Output common E (GND: No. 64 to 67)
2 (14)	NC	27 (38)	Output common E (+DC: No. 64 to 67)
3 (15)	Input No.64	28 (39)	Output No.64
4 (16)	Input No.65	29 (40)	Output No.65
5 (17)	Input No.66	30 (41)	Output No.66
6 (18)	Input No.67	31 (42)	Output No.67
7 (63)	Input common F (No. 68 to 71)	32 (87)	Output common F (GND: No. 68 to 71)
8 (64)	NC	33 (88)	Output common F (+DC: No. 68 to 71)
9 (65)	Input No.68	34 (89)	Output No.68
10 (66)	Input No.69	35 (90)	Output No.69
11 (67)	Input No.70	36 (91)	Output No.70
12 (68)	Input No.71	37 (92)	Output No.71
13 (19)	Input common G (No. 72 to 75)	38 (43)	Output common G (GND: No. 72 to 75)
14 (20)	NC	39 (44)	Output common G (+DC: No. 72 to 75)
15 (21)	Input No.72	40 (45)	Output No.72
16 (22)	Input No.73	41 (46)	Output No.73
17 (23)	Input No.74	42 (47)	Output No.74
18 (24)	Input No.75	43 (48)	Output No.75
19 (69)	Input common H (No. 76 to 79)	44 (93)	Output common H (GND: No. 76 to 79)
20 (70)	NC	45 (94)	Output common H (+DC: No. 76 to 79)
21 (71)	Input No.76	46 (95)	Output No.76
22 (72)	Input No.77	47 (96)	Output No.77
23 (73)	Input No.78	48 (97)	Output No.78
24 (74)	Input No.79	49 (98)	Output No.79
25 (99)	FG	50 (100)	FG

The number in parentheses in the Pin No. above means the corresponding pin number on the 100-pin connector.

## 8. I/O Remote Settings

This section describes the functions and timings of input and output signals.

The remote functions may be assigned to your standard or expansion I/O board(s) to enhance robot control - either from an operational unit of your choice or a sequencer.

The user defines the I/O number that a remote function is assigned to using software configuration. For further details, refer to the section, *Remote Control Software Configuration* in the chapter, *Remote Control* in EPSON RC+ User's Guide.

For details about I/O cable connection, refer to sections on *Setup & Operation 6. STANDARD I/O Connector*, and *Setup & Operation 7. Expansion I/O Board - Optional* in this manual.

For details about communication with external equipment, refer to the chapter, *Remote Control* in EPSON RC+ User's Guide.



CAUTION

- When using remote I/O, always make sure of the following. Using the robot system under unsatisfactory conditions may cause malfunction of the system and/or safety problems.
  - Assign remote functions to inputs/outputs correctly and wire correctly when setting up remote I/O signals.
  - Make sure that the functions correspond to the correct input/output signals before turning ON the system.
  - When verifying the robot system operation, prepare for failures with initial settings or wiring. If the Manipulator functions unusually by the failures with initial settings or wiring, press the Emergency Stop switch immediately to stop the Manipulator.

NOTE



When you set up a remote I/O signal, please either keep a written record of the settings or store the data in a file for later reference.

## 8.1 I/O Signal Description

You may use either Standard I/O or Expansion I/O for remote control. To use all signals, you will need to add Expansion I/O.

### 8.1.1 Remote Input Signals

Remote inputs are used to control the Manipulators and start programs. Certain conditions must be met before inputs are enabled, as shown in the table below.



When an error occurs, you must execute a Reset to clear the error condition before any more remote input commands can be executed. Therefore, it is recommended that the remote equipment uses the Error output and Reset input to monitor and clear error conditions.

The remote input signals for EPSON RC+ are as follows:

Name	Description
MotorOn	Turns motors on for the current robot. The MotorOff input must be off. Disabled when tasks are running.
MotorOff	Turns motors off for the current robot and disables MotorOn. Disabled when tasks are running.
PowerHigh	Sets high motor power mode for the current robot. The motors must be on and the PowerLow input must be off. Disabled when tasks are running.
PowerLow	Turns off high power mode for the current robot and disables PowerHigh. Disabled when tasks are running.
Mcal	Executes MCal command. Disabled when tasks are running.
Home	Executes Home command. Disabled when tasks are running.
Start	Starts the current program group. Disabled when tasks are running. (*2)
Pause	Pauses all tasks that are configured to pause. Enabled only when tasks are running.
Cont	Continues tasks that have been paused. Enabled only when tasks are running.
AbortAll	Aborts all tasks or the current command.
Reset	Resets the Controller and error condition. This is the only command accepted when the Error output is turned on.
SelRobot	Selects the current robot for robot commands, according to the 4 inputs SelRobot0 to SelRobot3. The robot number is 0 based, with 0 corresponding to Robot 1 (default). (*1)
SelRobot0	Robot Bit 0, weight 1. (*3)
SelRobot1	Robot Bit 1, weight 2. (*3)
SelRobot2	Robot Bit 2, weight 4. (*3)
SelRobot3	Robot Bit 3, weight 8. (*3)

Name	Description
SelGroup	Selects the current program group to be started with the Start input according to the 4 inputs SelGroup0 to SelGroup3.
SelGroup0	Group Bit 0, weight 1. (*4)
SelGroup1	Group Bit 1, weight 2. (*4)
SelGroup2	Group Bit 2, weight 4. (*4)
SelGroup3	Group Bit 3, weight 8. (*4)
Recover	Initiates a position recovery after the safeguard has been closed.
Shutdown	Shuts down the Controller. Disabled when tasks are running.
Reboot	Reboots the Controller. Disabled when tasks are running.

(\*1) The SelRobot input is used to select the Manipulator for executing Motor Mode, Power Mode, MCALComplete, AtHOME, the output of CurrRobot0 to 3 for remote output and Motor ON, Motor OFF, Mcal, Home for remote input.

(\*2) The Start input is enabled for the group number specified with SelGroup0-3 bits.

(\*3) Specify the manipulator number with SelRobot0 - 3 as shown in the table below.

Specified Manipulator	SelRobot0	SelRobot1	SelRobot2	SelRobot3
1	0	0	0	0
2	1	0	0	0
3	0	1	0	0
4	1	1	0	0
5	0	0	1	0
6	1	0	1	0
7	0	1	1	0
8	1	1	1	0
9	0	0	0	1
10	1	0	0	1
11	0	1	0	1
12	1	1	0	1
13	0	0	1	1
14	1	0	1	1
15	0	1	1	1
16	1	1	1	1

0 : OFF, 1 : ON

(\*4) Specify the group number with SelGroup0-3 referring to the table below.

Specified Group No.	SelGroup0	SelGroup1	SelGroup2	SelGroup3
1	0	0	0	0
2	1	0	0	0
3	0	1	0	0
4	1	1	0	0
5	0	0	1	0
6	1	0	1	0
7	0	1	1	0
8	1	1	1	0
9	0	0	0	1
10	1	0	0	1
11	0	1	0	1
12	1	1	0	1
13	0	0	1	1
14	1	0	1	1
15	0	1	1	1
16	1	1	1	1

0 : OFF, 1 : ON



### 8.1.2 Remote Output Signals

Remote outputs provide status for the current Manipulator and Controller.

The remote output signals for EPSON RC+ are as follows:

Function	Description
MotorOn	Indicates that motors are on for the current robot.
PowerHigh	Indicates that motor power is set to high for the current robot.
McalComplete	Indicates that MCal has been completed for the current robot. If the robot uses absolute encoders, then this output will always be on.
AtHome	Indicates that the current robot is at its home position.
CmdRunning	Indicates that a remote input command is in cycle.
TasksRunning	Indicates that tasks are running in the Controller.
Paused	Indicates that tasks have been paused.
Safeguard	Indicates that the safeguard circuit is open.
EstopOn	Indicates that emergency stop has occurred.
Error	Indicates that an error had occurred. You must execute a Reset input to clear the error condition.
AutoMode	Indicates that remote input commands will be accepted.
TeachMode	Indicates that the system is in Teach mode.
EnableOn	Indicates that the enable switch (dead man) is on during Teach mode.
CurrRbor0	Robot Bit 0, weight 1. (*3)
CurrRbor1	Robot Bit 1, weight 2. (*3)
CurrRbor2	Robot Bit 2, weight 4. (*3)
CurrRbor3	Robot Bit 3, weight 8. (*3)
CurrGroup0	Group Bit 0, weight 1. (*4)
CurrGroup1	Group Bit 1, weight 2. (*4)
CurrGroup2	Group Bit 2, weight 4. (*4)
CurrGroup3	Group Bit 3, weight 8. (*4)
MotorMode	Indicates the current motor setting. Sometimes the motors are turned off by the system, such as when the safeguard is opened. But MotorMode signals the current user setting.
PowerMode	Indicates the current power setting. Sometimes the power is set to low by the system. But PowerMode signals the current user setting.
RecoverReqd	Indicates that a recover position can be executed after the safeguard has been closed.
RecoverInCycle	Indicates that recover position is in cycle.

(\*3) (\*4): Refer to the tables in the *Setup & Operation 8.1.1 Remote Input Signals*.

## 8.2 Timing Specifications

### 8.2.1 Design Notes for Remote Input Signals

The following charts indicate timing sequences for the primary operations of the Controller.

The indicated time lapses (time durations) should be referred to only as reference value since the actual timing values vary depending on the number of Manipulators and the number of tasks running, as well as CPU speed of the Controller. Check carefully and refer to the following charts for the timing interrelation when you enter an input signal.

During system design, make sure that you actuate only one remote input operation at a time, otherwise an error will occur.

The pulse width of an input signal must be 25 or more milliseconds to be detected.

### 8.2.2 Timing Diagram for Operation Execution Sequence

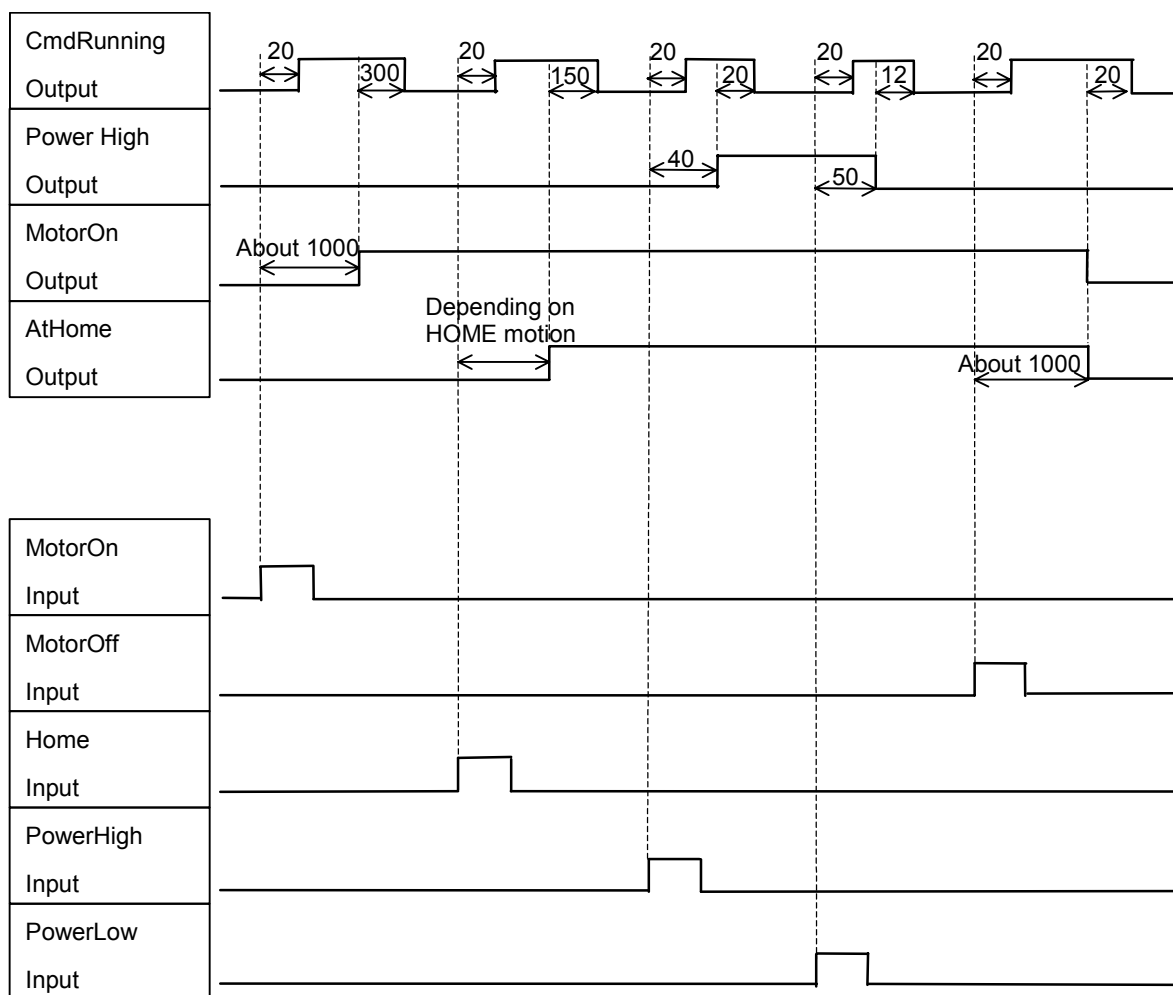

[Unit: msec]

8.2.3 Timing Diagram for Program Execution Sequence

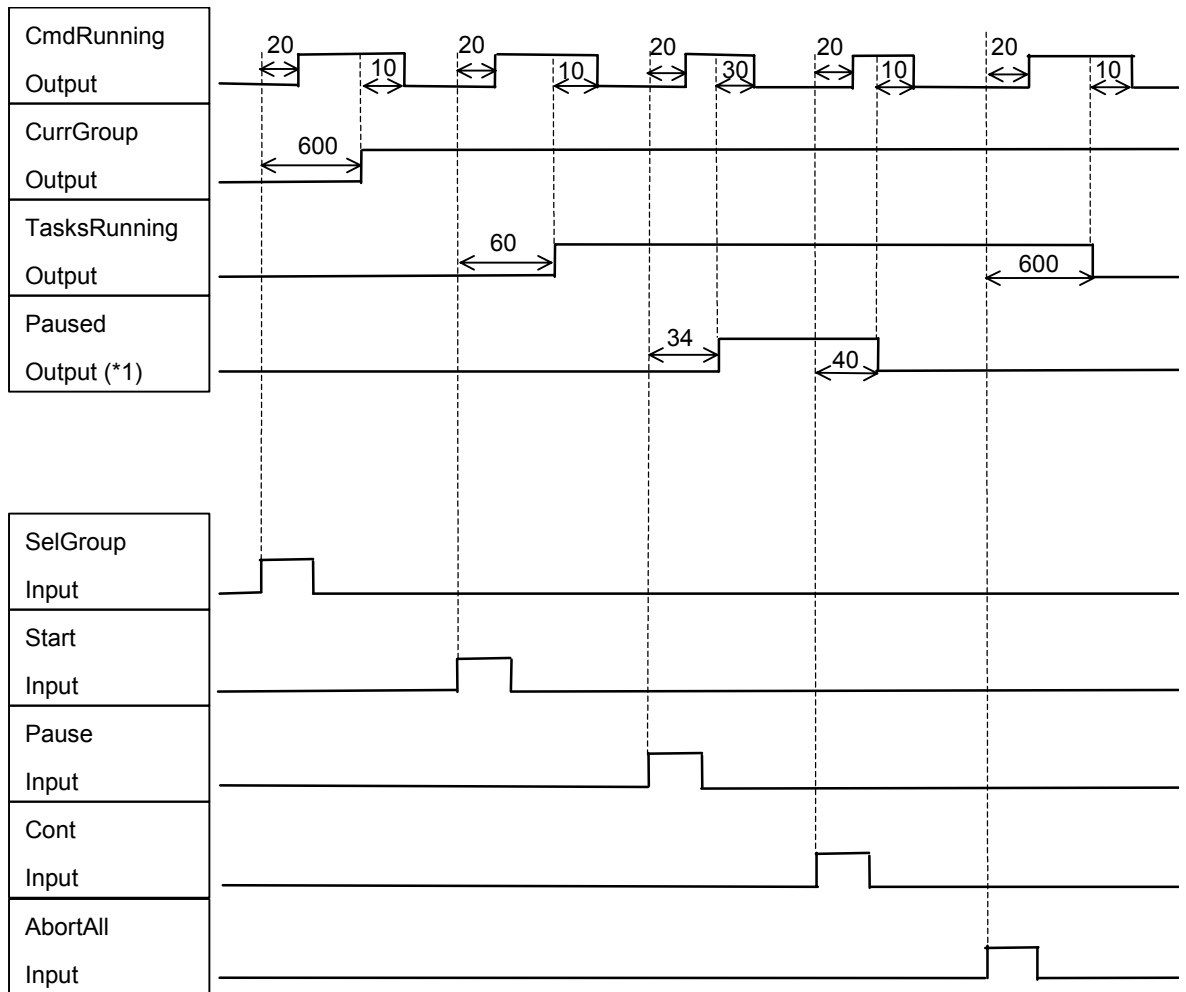

[Unit: msec]

\*1: The duration varies depending on the Quick Pause (QP) setting and the program's operating status at the time of Pause input.

8.2.4 Timing Diagram for Safety Door Input Sequence

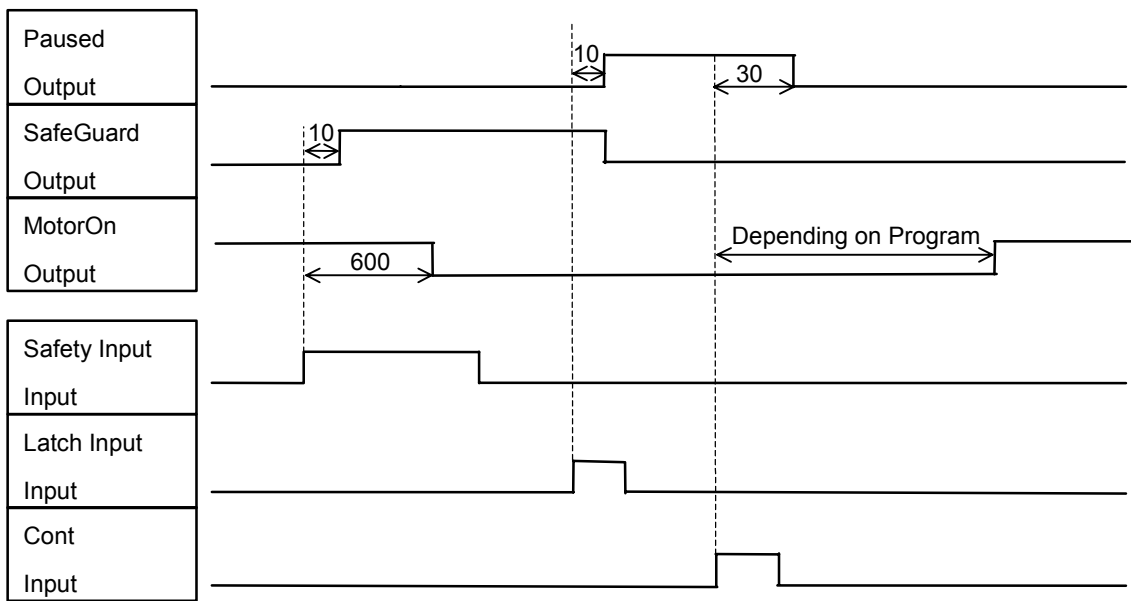

[Unit: msec]

8.2.5 Timing Diagram for Emergency Stop Sequence

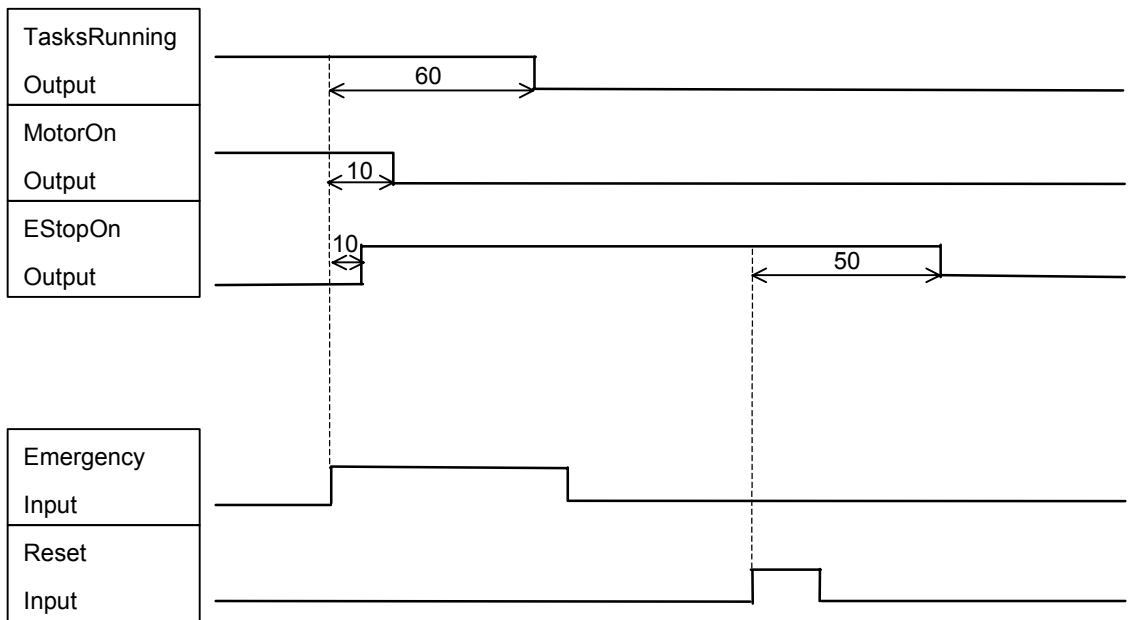

[Unit: msec]

8.2.6 Timing Diagram for RECOVER Sequence

Remote Auto Recover

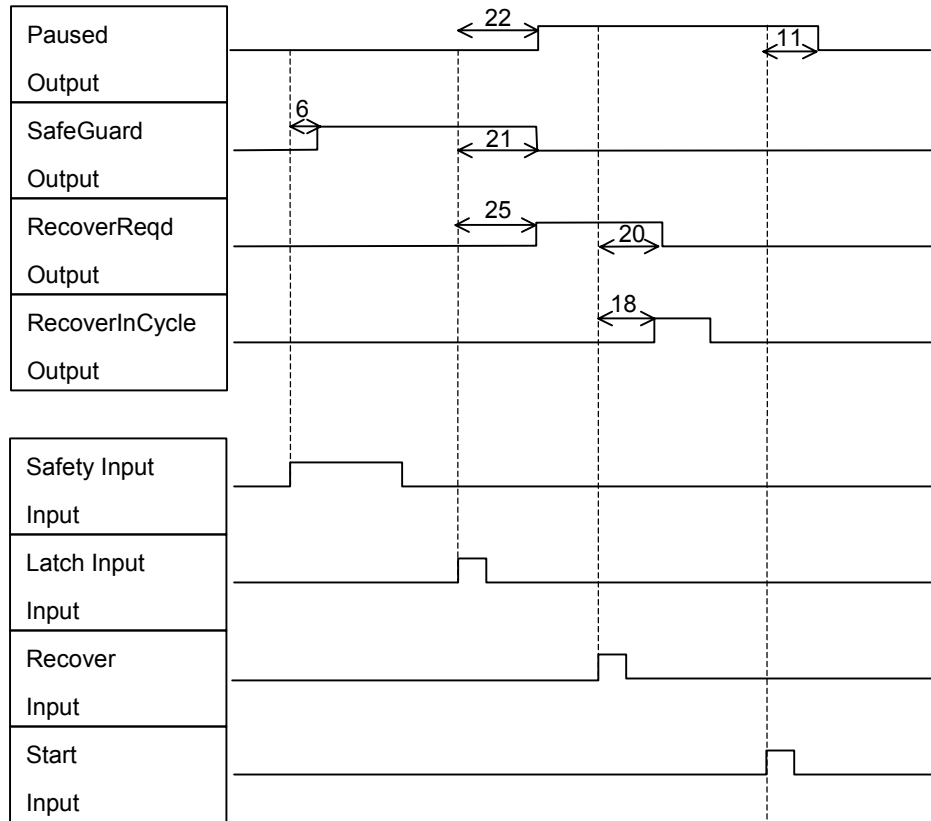

[Unit: msec]

Remote Manual Recover

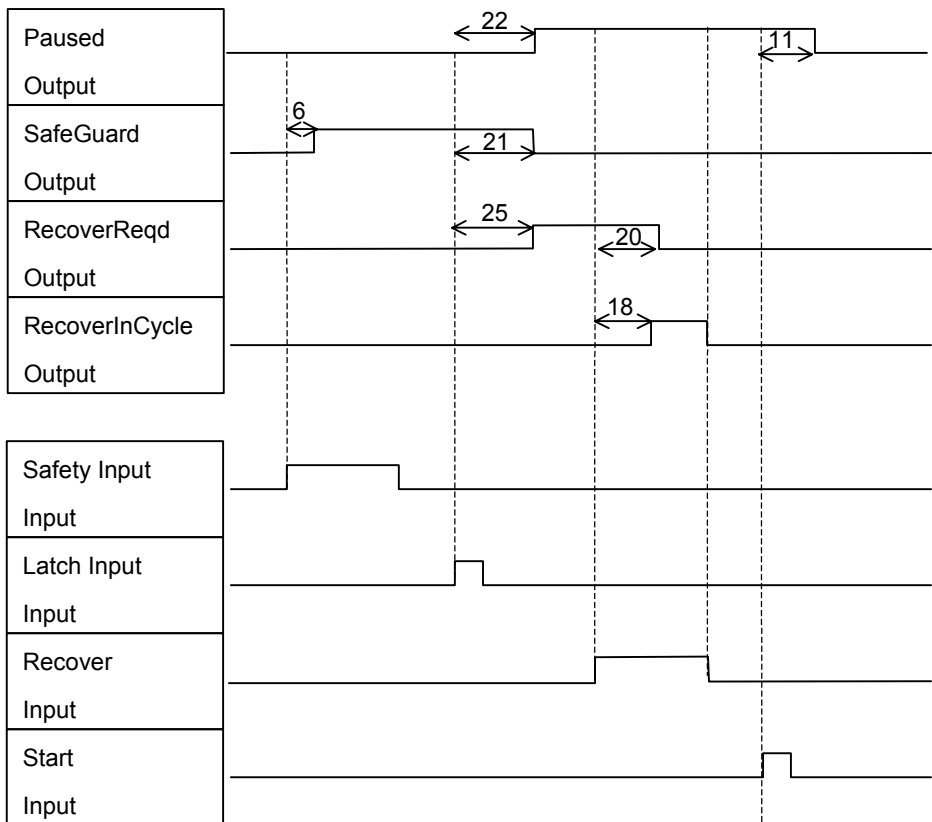

[Unit: msec]

## 9. RS-232C Settings

The Standard RC420 Controller comes with two RS-232C channels to facilitate controlling of the data communication among the host computer, robot system and their peripheral equipment.

### 9.1 RS-232C cable

RS-232C cables are not included with the standard RC420 Controller. The user must prepare them as necessary.

Connector	Standard
Communication connector	D-sub 9 pin #4-40 screw

The cable must be shielded twisted pair. Clamp the shield to the connector hood to prevent noise.

#### 9.1.1 Pin Assignments

Pin assignments for RS-232C connectors are as follows:

Pin No.	Abbr.	Signal Name	Signal Direction
1	CD	Data carrier detect	Input
2	RD	Receive data	Input
3	SD	Send data	Output
4	ER	Terminal ready	Output
5	SG	Signal ground	–
6	DR	Data set ready	Input
7	RS	Request to send	Output
8	CS	Clear to send	Input
9	RI	Ring indicator	Input

9.1.2 Connection Example

Example 1: Standard [Controller]

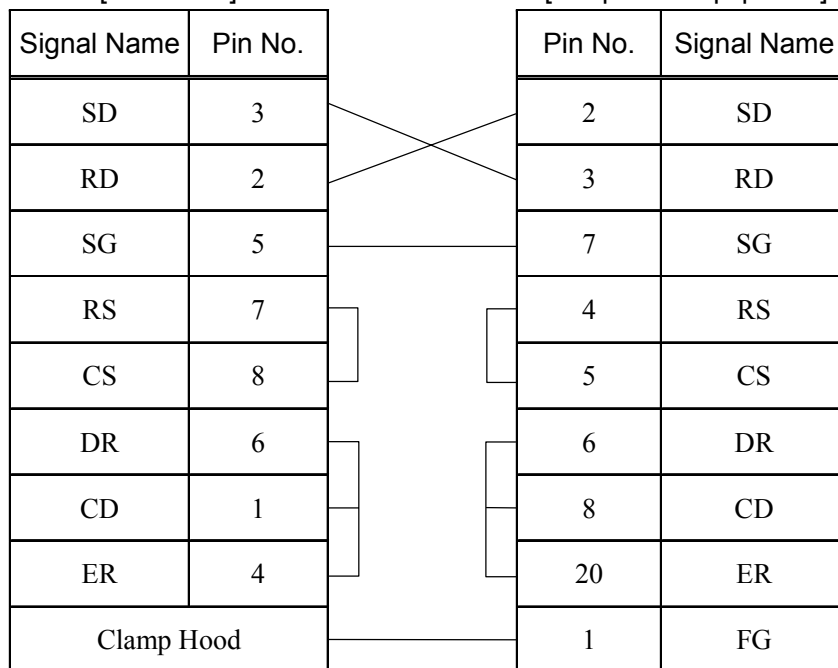

Example 2: H/W Flow Control

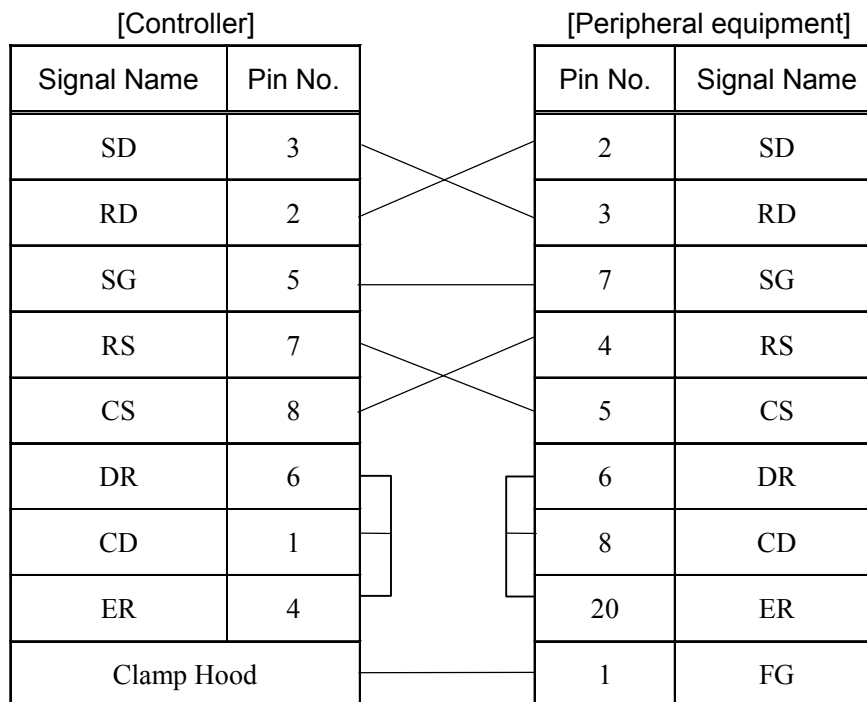

9.2 Preparation for Communication

For communication via RS-232C between the Controller and peripheral equipment to work, the port configuration on both units must be the same.

For details on the set-up procedure and communication commands, refer to the section, *RS-232 Software Configuration* in the chapter, *RS-232 Communications* in EPSON RC+ User's Guide.



## 10. UPS (Uninterruptible Power Supply)

### 10.1 UPS

The UPS (Uninterruptible Power Supply) protects the hard disk data (including Windows and applications) from being damaged by power failure or power-off without shutdown.



CAUTION

- Utilize the UPS only for protecting the data from damages caused by power failure or power-off without shutdown. If the UPS is turned OFF over and over intentionally while Windows is operating, the life cycle of UPS battery will be shortened and the UPS may perform insufficiently.
- Complete the shutdown of Windows within three minutes. If Windows is not shut down within the battery backup time of the UPS, the data may be damaged.

### 10.2 Configuration of Power Supplies

The Controller is equipped with the 24V output power supply, battery, and output power supply for 5V and 12V. The UPS consists of the battery and the output power supply for 5V and 12V. The UPS provides backup power only for the 5V and 12V power supplies that are necessary to operate the CPU and hard disk. The UPS does not back up the power for the Manipulator or Encoder Power Supply. Therefore, when a power failure or power-off without shutdown occurs while the Manipulator is operating, an error such as an encoder cable disconnection error occurs and the Manipulator makes an emergency stop.

### 10.3 Normal Shutdown of Robot System

Exit EPSON RC+ and shut down Windows. After the Controller is ready to be turned OFF, turn OFF the power switch of the Controller. Then, all the power supplies except for the UPS will be turned OFF immediately and the UPS power supply will be turned OFF approximately five seconds later.

### 10.4 Automatic Shutdown by UPS service in Robot System

For RC420, the UPS service of Windows functions and automatically shuts down the system when a power failure or power-off without shutdown occurs. The UPS service has already been configured at the factory before shipment. The process of automatically shutting down the system depends on the conditions of Windows and power supply. (For details of the shutdown processes, refer to the sections *10.4.1* and *10.4.2*.)

10.4.1 While Windows is being booted up

- A power failure or voltage drop occurs. → The power does not recover.
- The power switch is turned OFF accidentally. → The switch is left OFF.

Windows is booted up and then it is shut down automatically.

 CAUTION	<p>■ When Windows is hung, even if you turn OFF the Controller, Windows remains hung until the battery is completely discharged. In this case, turn OFF the UPS ON/OFF switch. Then, turn ON the UPS ON/OFF switch again after the UPS is turned OFF. Since the power is not output from the UPS while the UPS ON/OFF switch is OFF, Windows does not start even though the Controller is turned ON.</p>
--	--

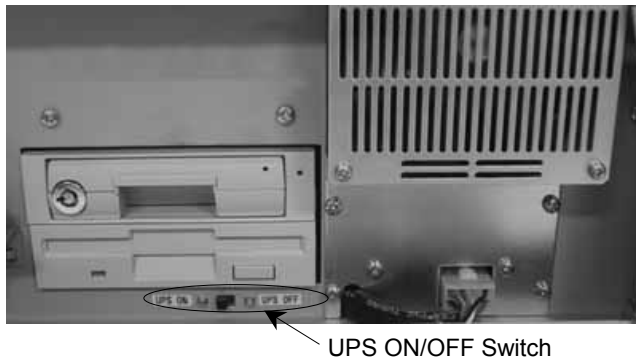

10.4.2 After Windows is booted up

- A power failure or voltage drop occurs.
  - The power recovers during the automatic shutdown.
- The power switch is turned OFF accidentally.
  - The power switch is turned ON during the automatic shutdown.

The UPS automatically shuts down Windows when detecting power-off. Once the shutdown is started, the shutdown cannot be stopped even though the power failure condition has been corrected. After Windows is shut down, the SHUTDOWN LED on the front panel of the Controller lights and remains ON. When the Controller is turned OFF, the UPS power is turned OFF approximately five seconds later.

- A power failure or voltage drop occurs.
  - The power does not recover during the automatic shutdown.
- The power switch is turned OFF accidentally.
  - The power switch is left OFF.

The UPS automatically shuts down Windows when detecting power-off. After Windows is shut down, the SHUTDOWN LED on the front panel of the Controller lights. Approximately five seconds later, the UPS power is turned OFF automatically.

## 10.5 UPS Battery

### 10.5.1 Safety Precautions for Battery

 <b>CAUTION</b>	<p>■ Be sure to follow the precautions listed below when handling the battery. Not following the precautions may result in extremely hazardous conditions such as excess heat generation, and a possible explosion of the battery.</p> <ul style="list-style-type: none"> <li>- Do not throw the battery into fire or expose it to high temperature.</li> <li>- Do not allow the connector terminals of the battery to short circuit.</li> <li>- Use the battery only for RC420 Controller.</li> <li>- Do not apply a strong shock to the battery.</li> <li>- Stop using the battery if you see any signs of change of color or damage to the battery.</li> </ul>
---	---

#### Recycling of Battery

Dispose of the used battery appropriately in accordance with the laws and acts of your national or local government. If you cannot dispose of a used battery properly, please inquire of your EPSON robot supplier how to dispose of it.

### 10.5.2 Charging Battery

Turning ON the Controller will automatically charge the UPS battery.

It takes approximately 80 minutes to completely charge a discharged UPS battery. To charge the battery fully, turn ON the Controller and keep it energized continuously.

### 10.5.3 Life Cycle of Battery

The life cycle of the battery depends on the ambient temperature, number of backup cycles, current-carrying capacity during backup, and backup time.

To prolong the life cycle of the battery, please follow the points shown below:

- The ambient temperature of the Controller should be 5 to 30 deg.C.  
Refer to the relation between the ambient temperature and the life cycle of battery as shown below:  
Suppose that the life cycle of battery is 100% when the ambient temperature is 20 deg.C.  
When the ambient temperature is 30 deg.C: approximately 70%  
When the ambient temperature is 40 deg.C: approximately 40%
- Do not turn OFF the power while Windows is operating.
- Keep the total current-carrying capacity of optional boards under the following range.
  - 5V : 4A or less
  - 12V : 0.5A or less
- Complete the shutdown of Windows within three minutes.

#### Replacement timing according to the number of backup cycles and usable years

Replace the battery according to the following number of backup cycles and years when the robot system is used in the standard condition (no option is used) and at ordinary temperature.

Number of backup cycles (How many times the battery can be charged and discharged.) : Approximately 500 times

Usable years : Approximately three years

#### Replacement timing according to the backup time

Measuring the battery backup time will show the approximate life cycle of battery. Measure the backup time using the procedure described below and record it as an initial value before using the Controller in your system.

Measure the backup time regularly and replace the battery when the measured backup time is approximately 60% of the initial value.

#### How to measure the backup time:

- (1) Turn ON the Controller in the actual configuration of your system, and keep the Controller energized for approximately 80 minutes.
- (2) From the Windows 2000 task bar, click the <Start> button and select the [Settings] - [Control Panel]. The [Control Panel] window will appear.
- (3) Double-click the <System> icon in the [Control Panel] window to show the [System Properties] dialog. Then, click the [Hardware] tab.
- (4) Click the <Device Manager> button to show the [Device Manager] dialog.
- (5) Select the [SPEL RESOURCE Drivers] - [SPEL VSRCSHUT] in the [Device Manager] dialog.
- (6) Right-click on the [SPEL VSRCSHUT] and select the "Disable" from the pop-up menu.
- (7) Selecting the "Disable" will show the message dialog. Click the <Yes> button in the message dialog.
- (8) Close all the dialogs and shut down Windows.
- (9) Make sure that Windows is shut down and the Controller is safe to be turned OFF. Then, turn OFF the Controller. Measure how long all the LEDs on the front panel of the Controller take to light OFF after the Controller is turned OFF. Then, record the time.
- (10) Turn ON the Controller and keep it energized for approximately 80 minutes to charge the UPS battery.
- (11) Set the driver [SPEL VSRCSHUT] whose setting was "Disable" in Step (6) to the "Enable". (Right-click on the [SPEL VSRCSHUT] and select the "Enable" from the pop-up menu.)

### 10.5.4 Replacement of Battery

- (1) Shut down Windows, and turn OFF the Controller.
- (2) Turn OFF the UPS ON/OFF switch.

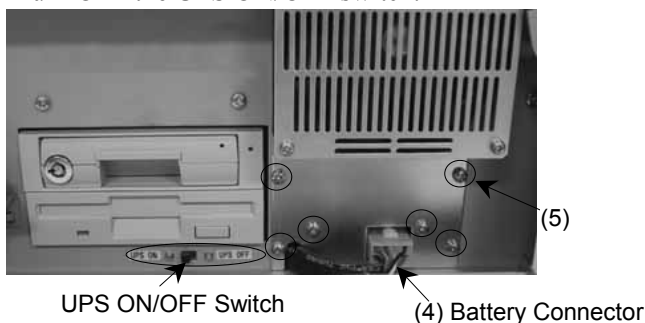

- (3) Wait for about 1 minute until the high voltage charged area is completely discharged. Remove four mounting screws, and remove the front cover from the Controller.
- (4) Remove the battery connector.
- (5) Remove six mounting screws, and remove the battery cover.
- (6) Pull out the battery from the Controller.
- (7) Remove the U-shaped plate from the front of the battery, and mount it onto a new battery.



- (8) Insert the new battery into the Controller
- (9) Secure the battery cover to the Controller with the six mounting screws.
- (10) Connect the battery connector.
- (11) Secure the front cover to the Controller with the four mounting screws.
- (12) Turn ON the UPS ON/OFF switch.

## 10.6 Setting up Windows

**NOTE**  The display of the setup procedures and setting items may differ according to the version of the EPSON RC+.

### 10.6.1 Installing RC420 UPS Drivers

**NOTE**  COM4 configuration and UPS driver installation have been done before shipping. Normally, it is not necessary to install the UPS drivers following the procedure described in this section.

When the UPS is installed in the RC420 Controller, you must configure COM4 to allow communication with the device and also install the UPS driver following the procedure below.

**NOTE**  The installation procedure differs according to the version of the EPSON RC+.

**EPSON RC+4.1 or before (Windows 2000)**

- (1) Restart the Controller and enter the BIOS.
- (2) In the PCI configuration, set IRQ11 to “Legacy”. This will reserve IRQ11 for COM4.
- (3) Reboot the Controller and start Windows.
- (4) Double-click the <Add / Remove Hardware> icon in the [Control Panel]. The [Add / Remove Hardware Wizard] dialog will appear.
- (5) Click the <Next> button.
- (6) Select the <Add / Troubleshoot a device> option button, then click the <Next> button.

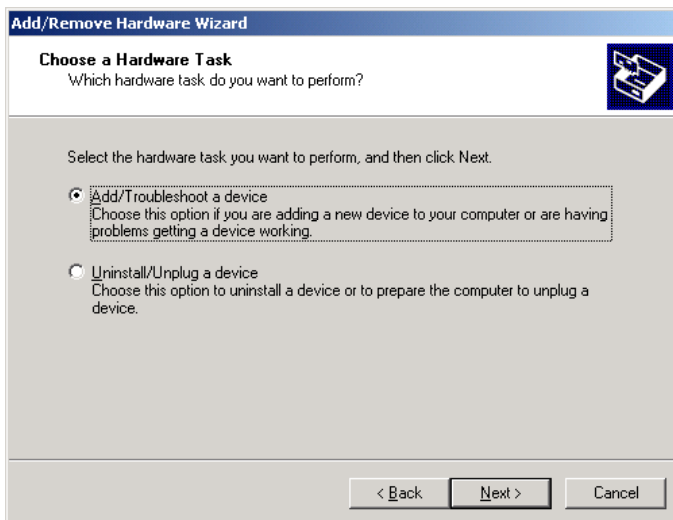

- (7) Select the “Add a new device”, then click the <Next> button.

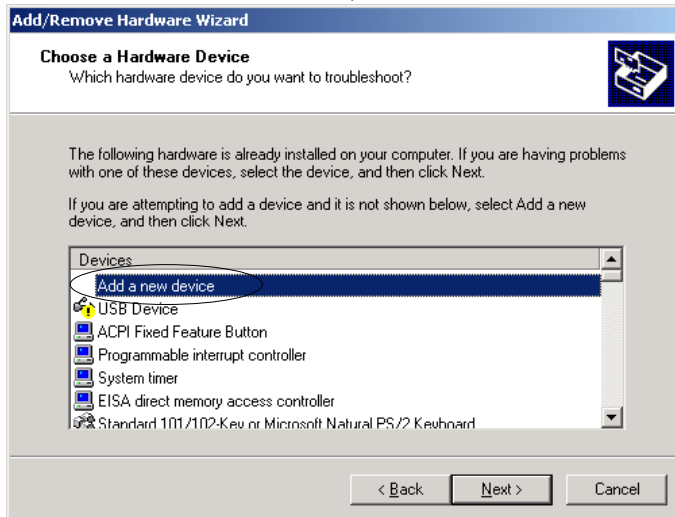

- (8) Select the <No, I want to select the hardware from a list> option button, then click the <Next> button.

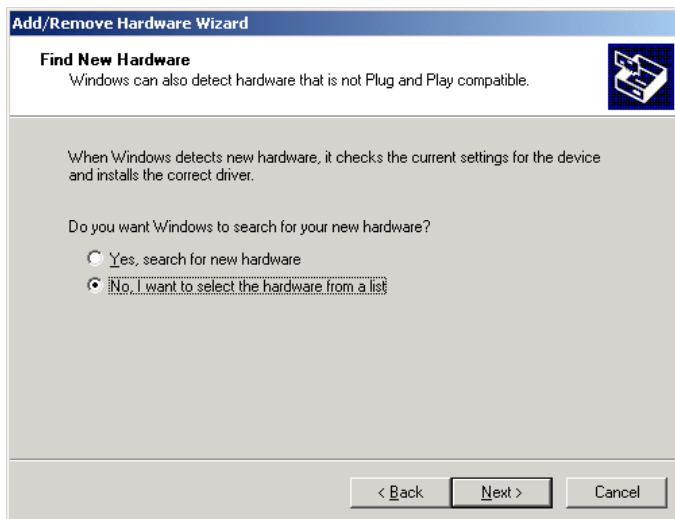

- (9) Select the “Ports [COM & LPT]”, then click the <Next> button.

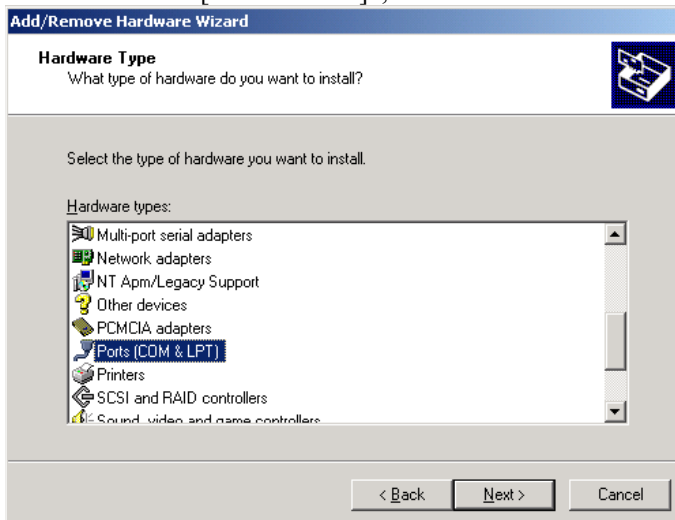

- (10) Select the “Communications Port” in the [Models] box, then click the <Next> button.

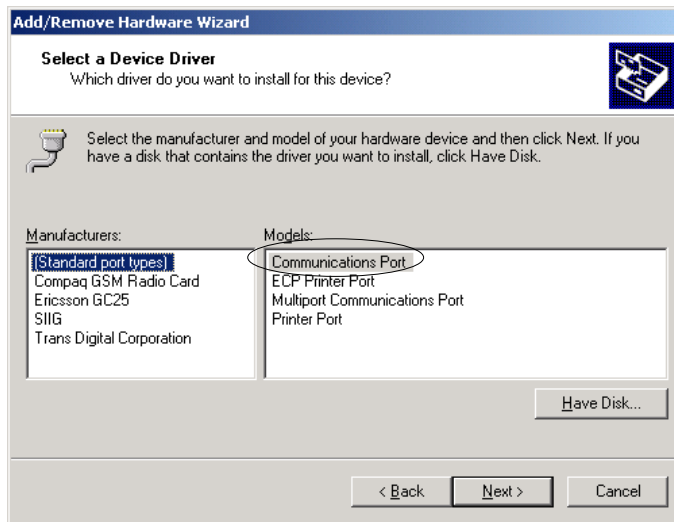

- (11) You will receive a warning message “Windows could not detect settings”. Ignore the message and click the <OK> button.
- (12) Select “Basic configuration 0008” in the [Setting based on] box in the [Add New Hardware Wizard Properties] dialog.

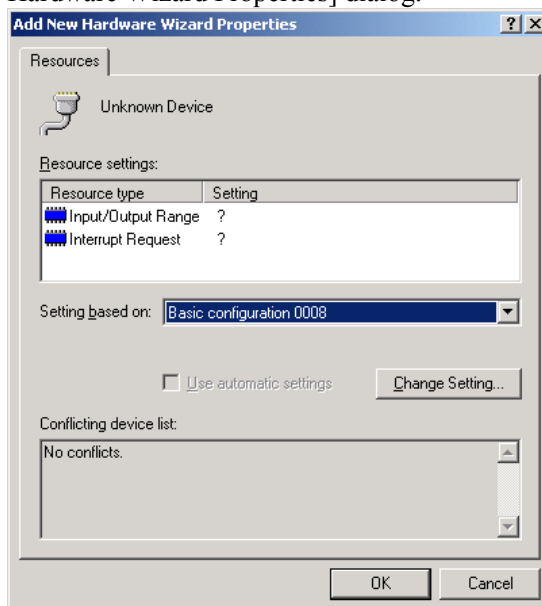

- (13) Click the “Input/Output Range” in the [Resource settings] box in the [Add New Hardware Wizard Properties] dialog.



- (14) Click the <Change Setting ...> button. The [Edit Input / Output Range] dialog will appear.

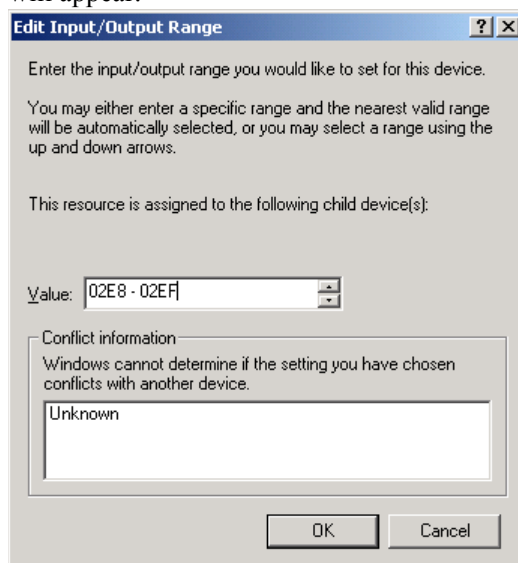

- (15) Enter “2E8-2EF” for the [Value] box and click the <OK> button.  
 (16) Select the “Interrupt Request” in the [Resource settings] box in the [Add New Hardware Wizard Properties] dialog.  
 (17) Click the <Change Setting ...> button in the [Add New Hardware Wizard Properties] dialog. The [Edit Interrupt Request] dialog will appear.

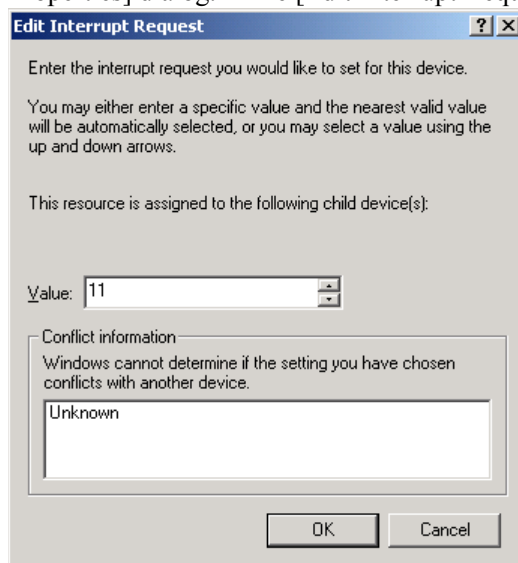

- (18) Enter “11” for the [Value] box and click the <OK> button.  
 (19) Click the <Next> button in the wizard and finish the installation.  
 (20) Reboot the system when prompted to do so.  
 (21) Double-click the <Add / Remove Hardware> icon in the [Control Panel]. The [Add / Remove Hardware Wizard] dialog will appear.  
 (22) Click the <Next> button.

(23) Select the <Add / Troubleshoot a device> option button, then click the <Next> button.

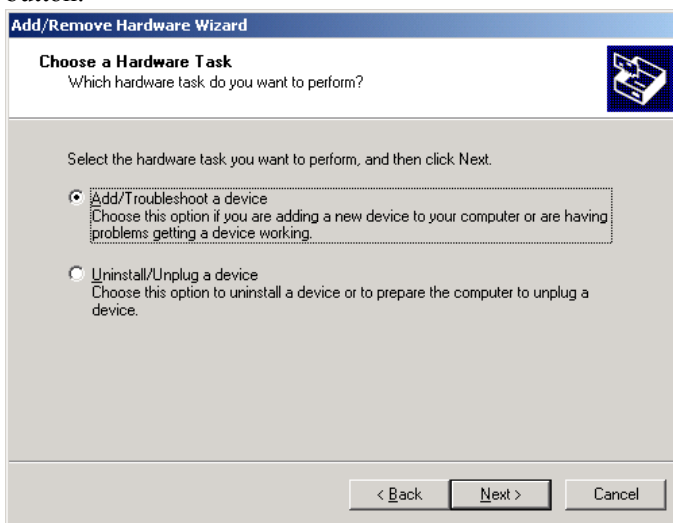

(24) Select the “Add a new device”, then click the <Next> button.

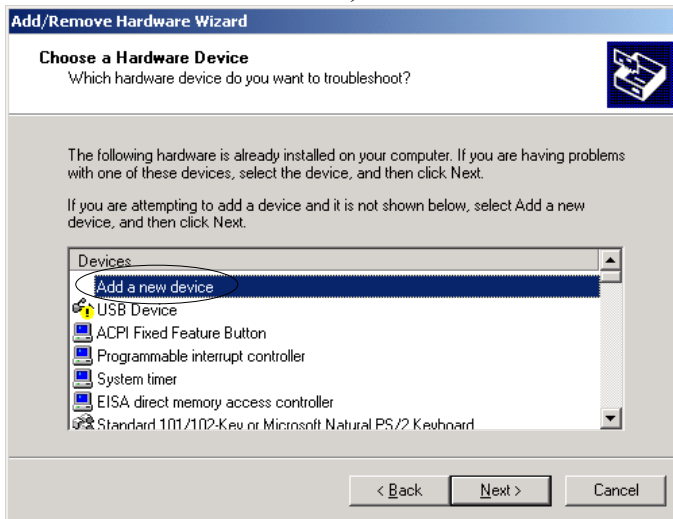

(25) Select the <No, I want to select the hardware from a list> option button, then click the <Next> button.

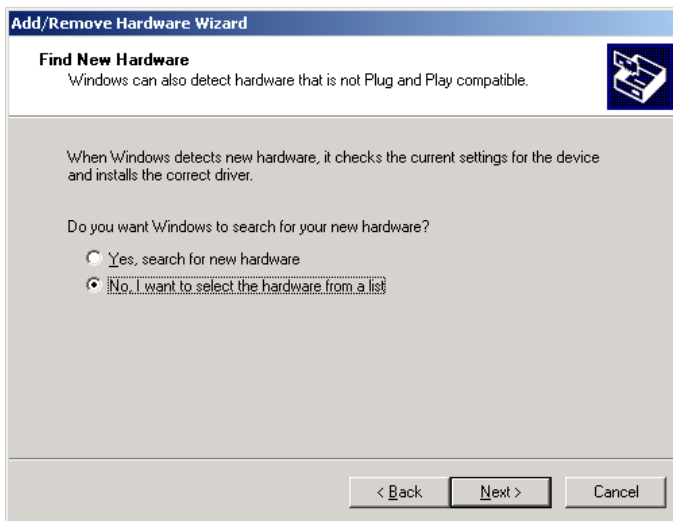

- (26) Select the “Other devices”, then click the <Next> button.

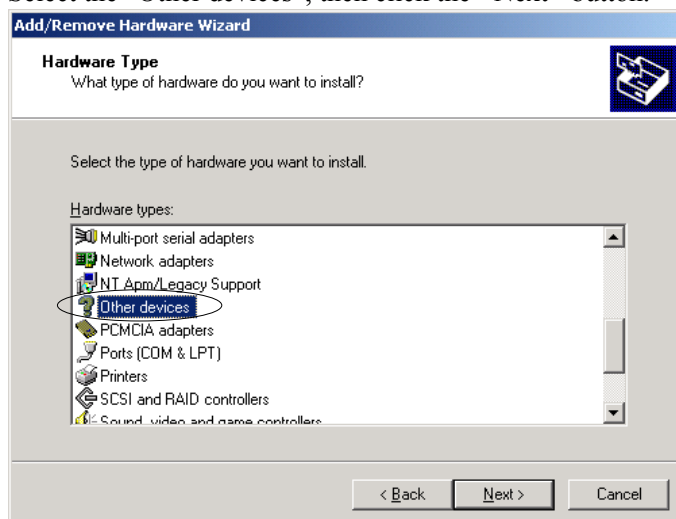

- (27) Click the <Have disk...> button.  
 (28) Enter or browse for the target path for the “VSRCSHut.inf” file located in “c:\EpsonRc\RC420\Drivers”. Then click the <Next> button.

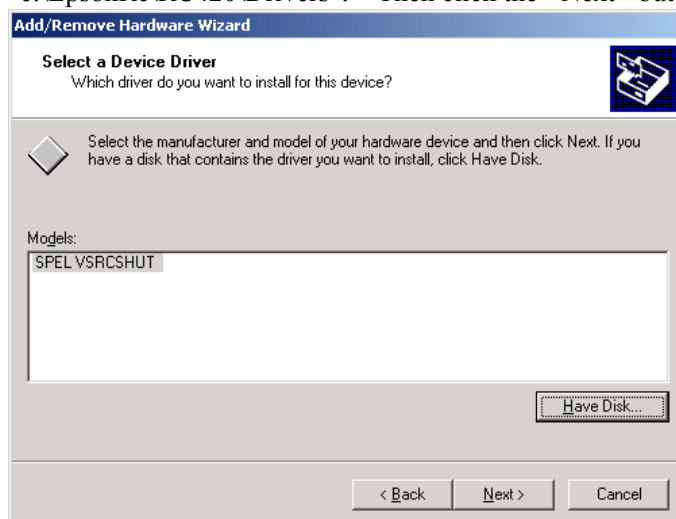

- (29) Reboot the system when prompted.

#### EPSON RC+4.2 or after (Windows XP)

- (1) Restart the Controller and enter the BIOS.
- (2) In the PCI configuration, set IRQ11 to “Legacy”. This will reserve IRQ11 for COM4.
- (3) Reboot the Controller and start Windows.
- (4) Open the [Control Panel] and select [Switch to Classic View].
- (5) Double-click the <Add Hardware> icon.
- (6) The [Add Hardware Wizard] dialog will appear. Click the <Next> button.
- (7) Select the <Yes, I have already connected the hardware> button, then click the <Next> button.

- (8) Select the “Add a new hardware device”, then click the <Next> button.

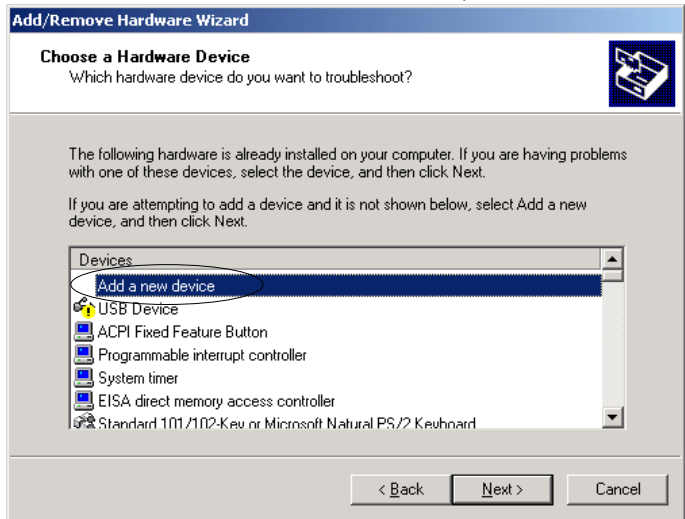

- (9) Select the <Install the hardware that I manually select from a list> option button, then click the <Next> button.

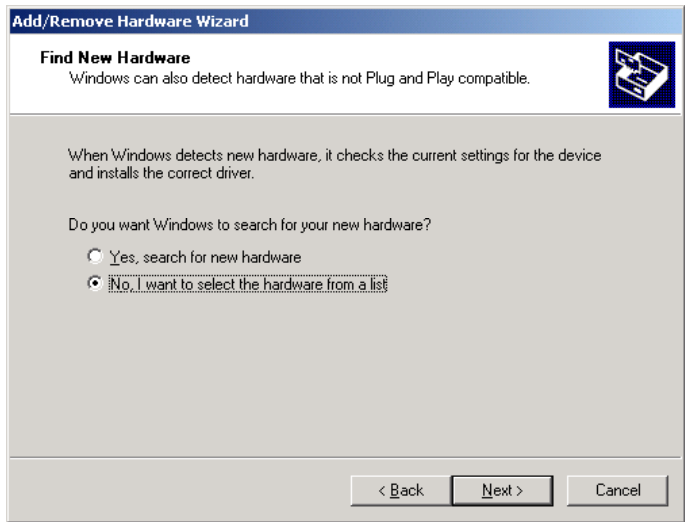

- (10) Select the “Ports [COM & LPT]”, then click the <Next> button.

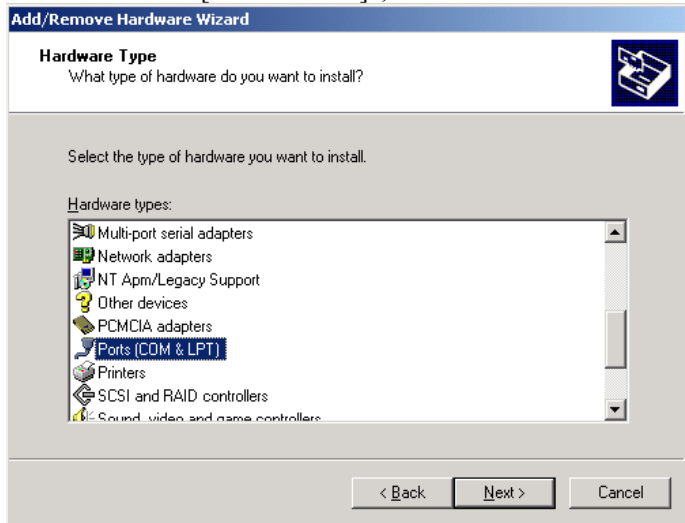

(11) Select the “Communications Port” in the [Models] box, then click the <Next> button.

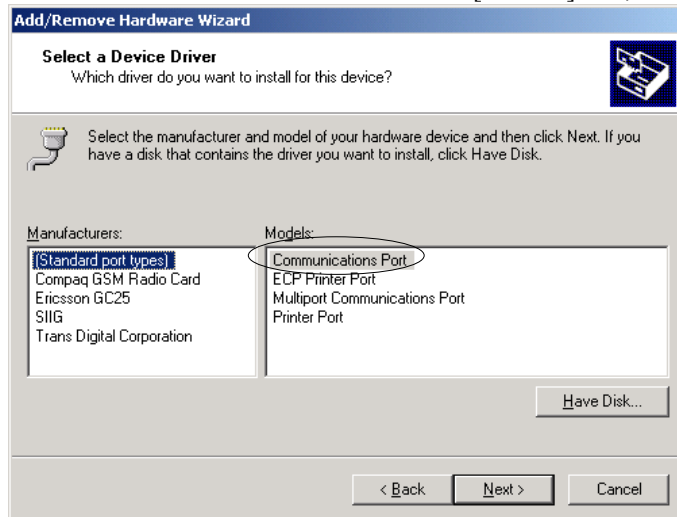

(12) Click the <Next> button in the Add Hardware Wizard.

(13) Click [View or change resources for this hardware] in the Add Hardware Wizard.



(14) Click the <Set Configuration Manually> button.

(15) Select “Basic configuration 0008” in the [Setting based on] box.

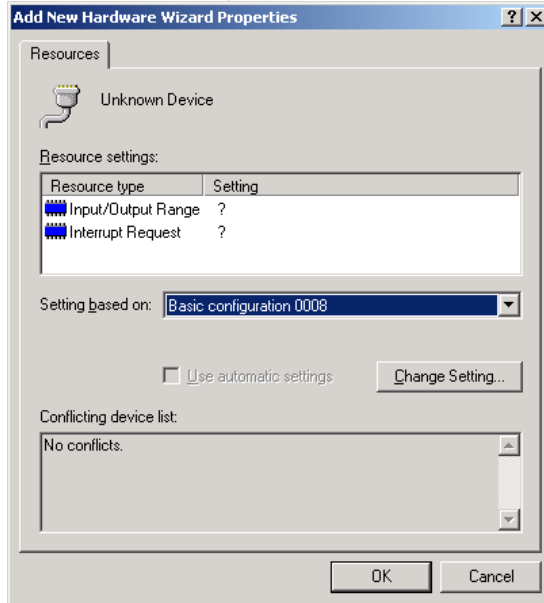

(16) Click the “Input/Output Range” in the [Resource settings] box in the dialog of step (15) and click the <Change Setting ...> button.

The [Edit Input / Output Range] dialog will appear.

(17) Enter “02E8-02EF” for the [Value] box and click the <OK> button.

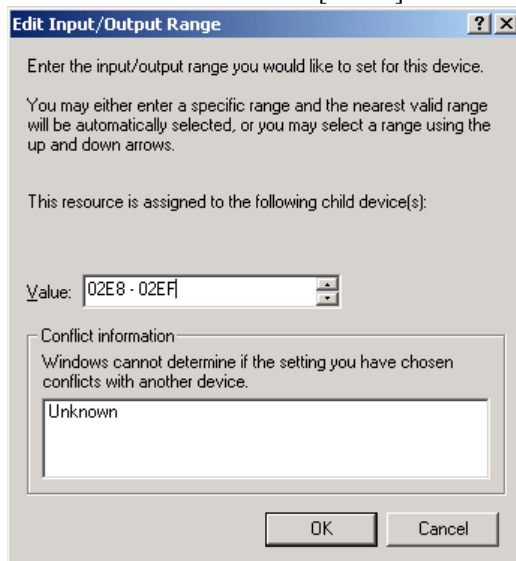

(18) Select the “Interrupt Request” in the [Resource settings] box in the dialog of step (15) and click the <Change Setting ...> button.

The [Edit Interrupt Request] dialog will appear.

(19) Enter “11” for the [Value] box and click the <OK> button.

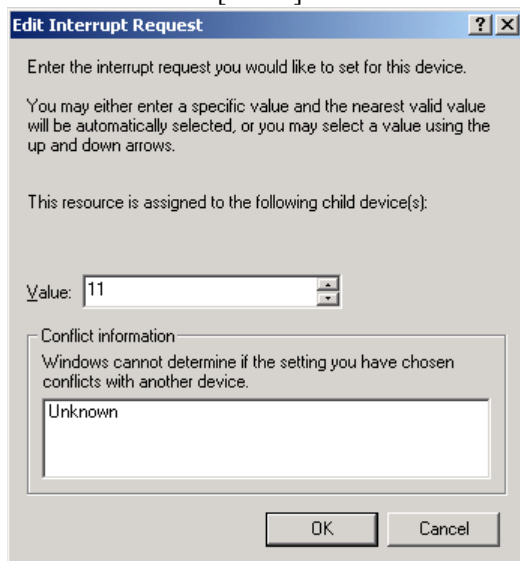

(20) Click the <OK> button.

(21) Click the <Finish> button in the dialog in step (13) and finish the installation.

(22) Reboot the system when prompted to do so.

(23) Open the [Control Panel].

(24) Double-click the <Add Hardware> icon.

(25) Click the <Next> button on [Add Hardware Wizard].

(26) Select [Yes, I have already connected the hardware], then click the <Next> button.

(27) Select [Add a new hardware device], then click the <Next> button.

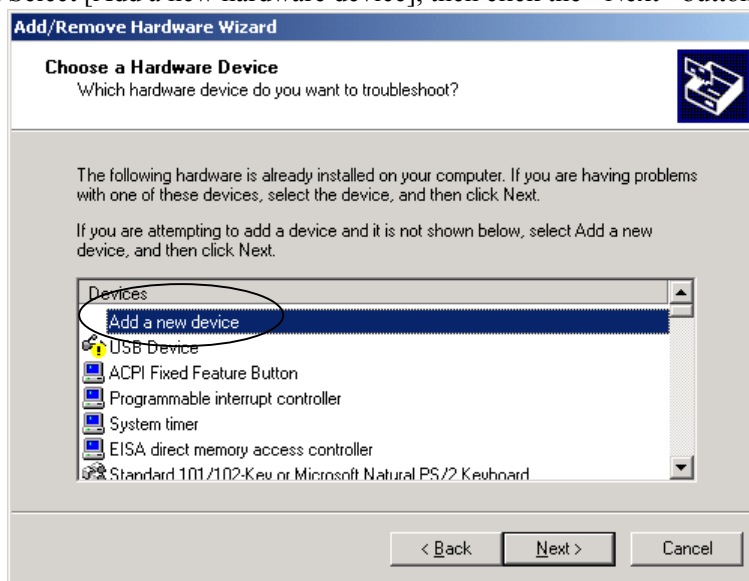

(28) Select [Install the hardware that I manually select from a list], then click the <Next> button.

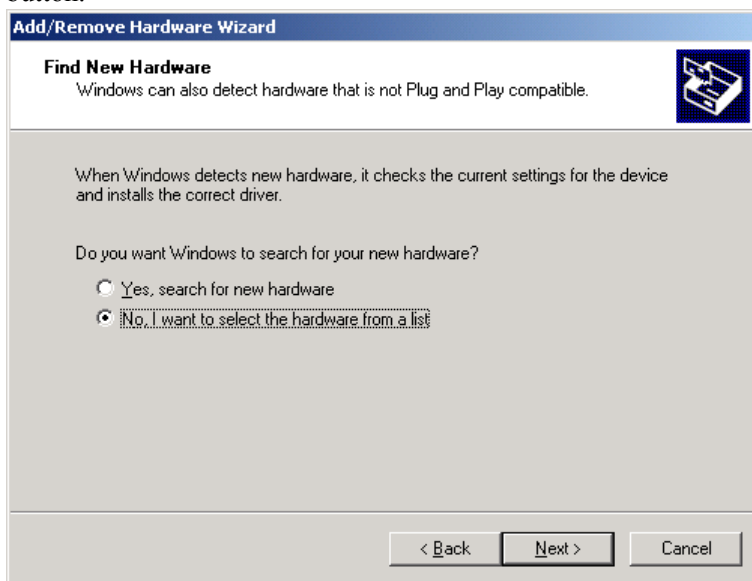

(29) Select [Show All Devices], then click the <Next> button.

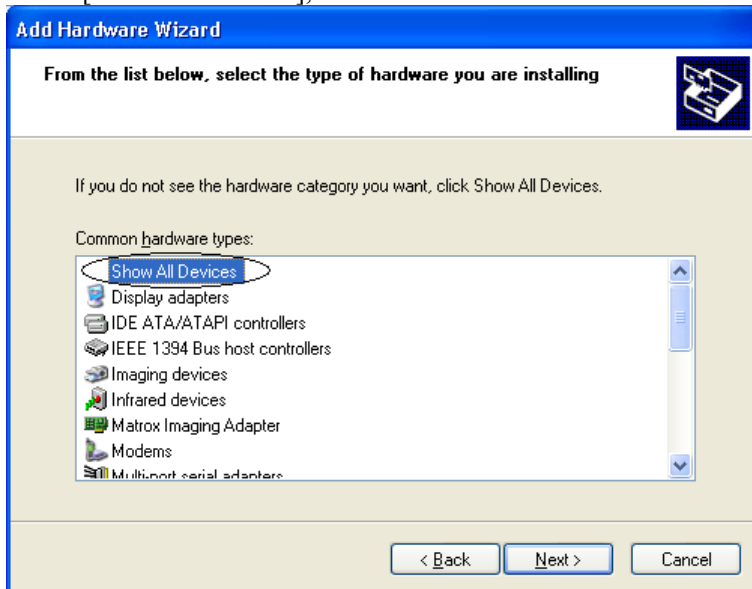

(30) Click the <Have disk...> button.



(31) Enter or browse for the target path for the VSRCShut.inf file located in c:\EpsonRc\RC420\Drivers.

Then click Next.

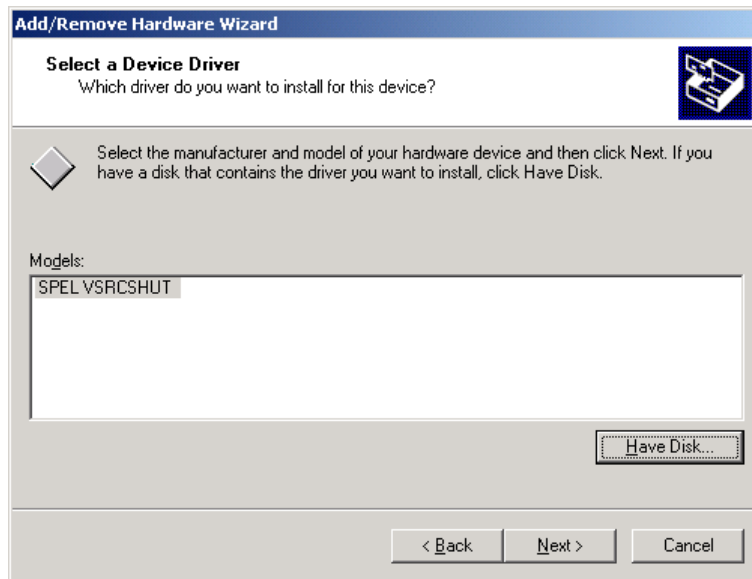

(32) Click the <Next> button in the wizard and finish the installation.

(33) Reboot the system when prompted.

### 10.6.2 Basic Configuration of Windows

NOTE  

The UPS has been enabled before shipping. Normally, it is not necessary to configure Windows following the procedure described in this section.

- (1) Open the Control Panel.  
When using EPSON RC+4.2 (Windows XP), select [Switch to Classic View].
- (2) Double-click the <Power Options> icon in the [Control Panel]. The [Power Options Properties] dialog will appear.

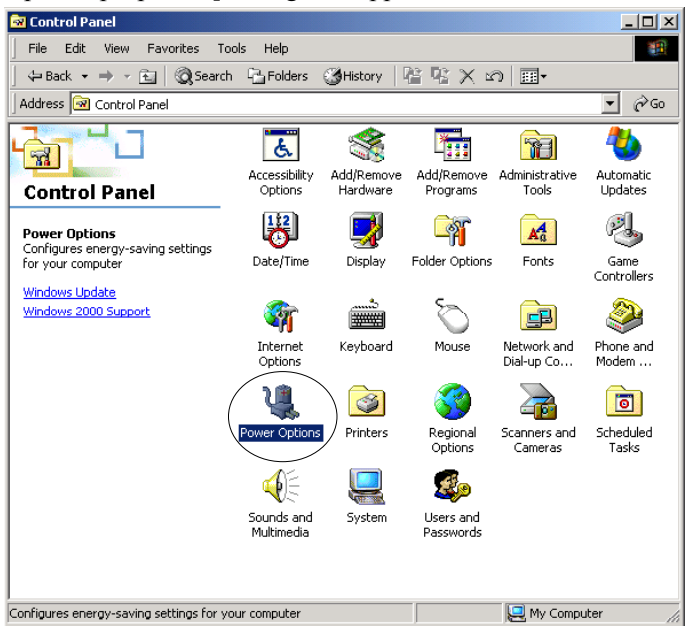

- (3) Select the [UPS] tab in the [Power Options Properties] dialog.

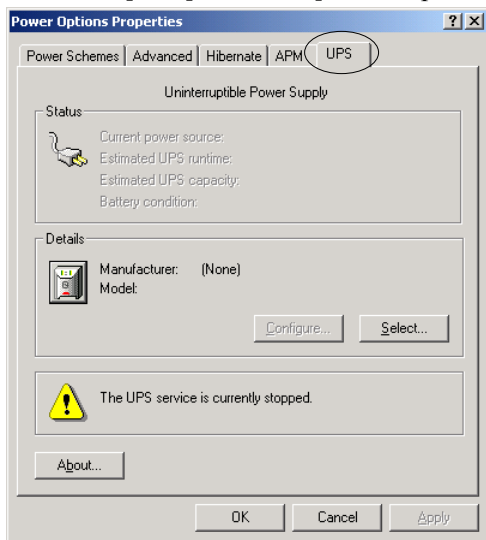

- (4) Click the <Select...> button in the [UPS] panel. The [UPS Selection] dialog will appear.

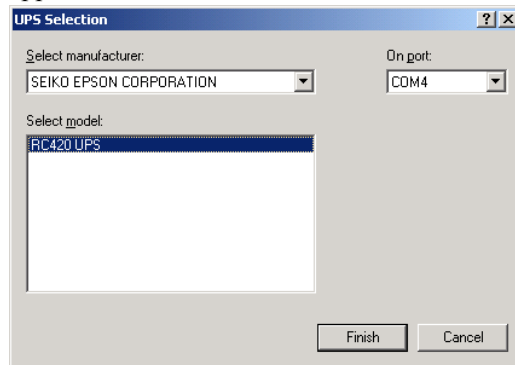

- (5) Select the "SEIKO EPSON CORPORATION" from the [Select manufacturer] box.  
(6) Select the "RC420 UPS" from the [Select model] box.  
(7) Select the "COM4" from the [On port] box.  
(8) Click the <Finish> button in the [UPS Selection] dialog. The [Power Options Properties] dialog will appear.

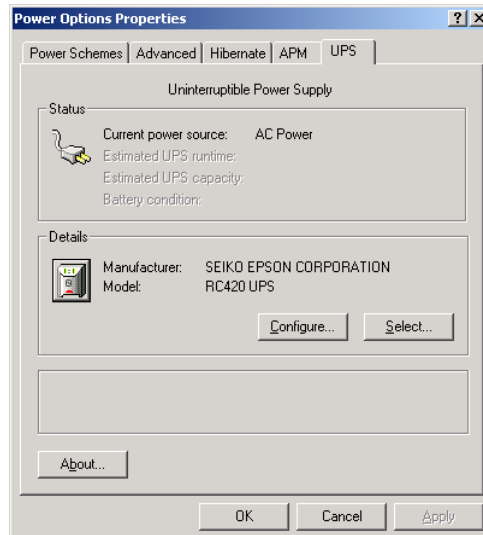

10.6.3 Setting up the Automatic Shutdown at the Time of a Power Failure

NOTE  

The Controller has been configured so that the system is automatically shut down at the time of a power failure. Normally, it is not necessary to configure the Controller following the procedure described in this section. When the computer name, user name, or password is changed, however, configure the Controller following the procedure below.

- (1) Open the Control Panel.  
 When using EPSON RC+4.2 (Windows XP), select [Switch to Classic View].
- (2) Double-click the <Power Options> icon in the [Control Panel]. The [Power Options Properties] dialog will appear.

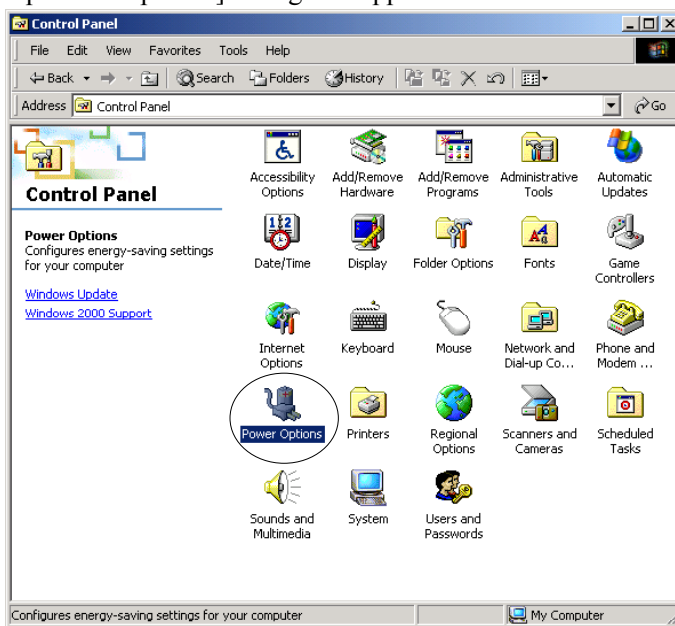

- (3) Select the [UPS] tab.

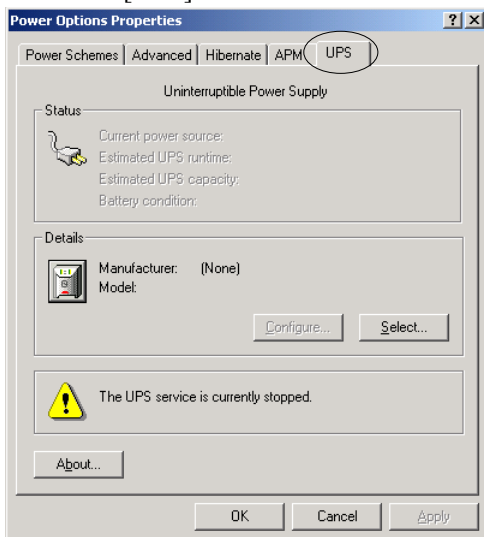

- (4) Click the <Configure...> button. The [UPS Configuration] dialog will appear.

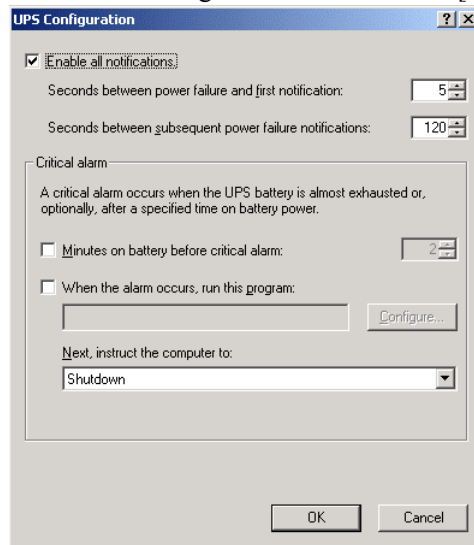

- (5) Check the [When the alarm occurs, run this program] checkbox.

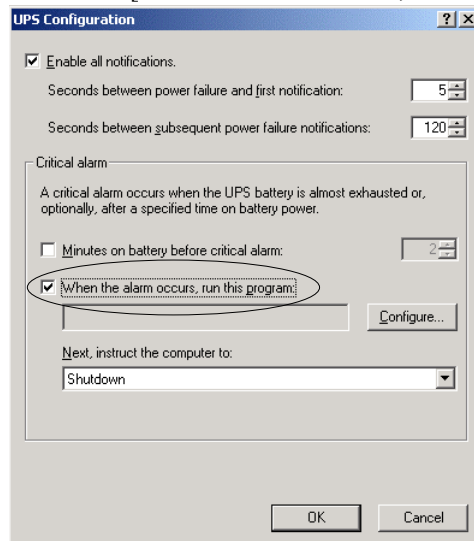

- (6) Click the <Configure...> button. The [UPS System Shutdown Program] dialog will appear. When changing either the Controller's computer name or the user name, input the new computer name or the user name in the [Run as] box.

EPSON RC+4.1 or before (Windows 2000)

SN\*\*\*\*\* : This is the default computer name. The actual computer name varies depending on serial number at shipping or user setting.

Administrator : This is the default user name. Specify the user name for logging on the Controller.

EPSON RC+4.2 or after (Windows XP)

SN\*\*\*\*\* : This is the default computer name. The actual computer name varies depending on serial number at shipping or user setting.

EPSON RC User : This is the default user name. Specify the user name for logging on the Controller.

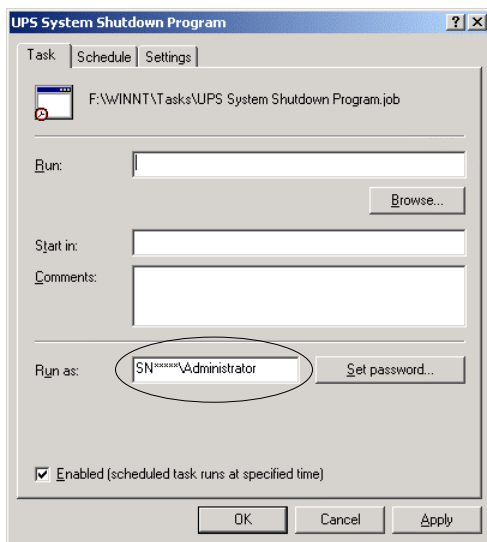

- (7) Enter the file name for the [Run] box.

EPSON RC+4.1 or before (Windows 2000) : C:\WINNT\system32\UPSshut.exe

EPSON RC+4.2 or after (Windows XP) : C:\WINDOWS\system32\UPSshut.exe

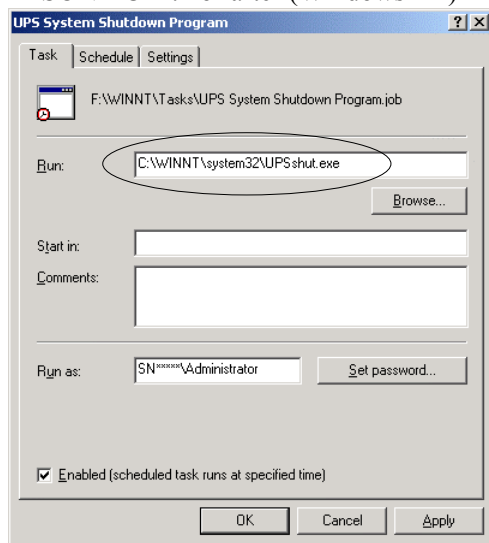

- (8) Click the <OK> or <Apply> button. The [Set Account Information] dialog will appear. The password should be same as the Windows login password. Set each item correctly to function UPS properly.

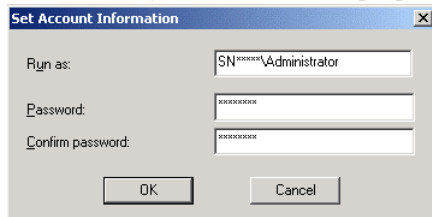

- (9) Click the <OK> button. The [UPS Configuration] dialog will appear.

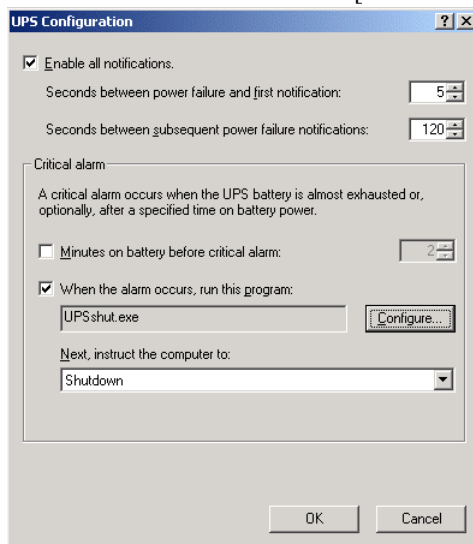

- (10) Click the <OK> button.
- (11) Click the <OK> or <Apply> button in the [Power Options Properties] dialog.
- (12) Double-click the file name.  
EPSON RC+ : C:\EpsonRC\RC420\drivers\UPS.reg  
SPEL CT : C:\PSPELWORK\SYS\REG\UPS folder\Wait0.reg
- (13) Click the <Yes> button.
- (14) Click the <OK> button.

### 10.6.4 UPS Setup Consideration

When the [UPS Configuration] dialog is displayed after the automatic shutdown at the time of a power failure is set up in the section 10.6.3:

Executing “UPS.reg” in step (11) in the section 10.6.3 *Setting up the Automatic Shutdown at the Time of a Power Failure* makes the [Minutes on battery before critical alarm] check box ([Control Panel] - <Power Options> icon - [UPS] tab - [UPS Configuration] dialog) selected. It also enters “0” for the [Minutes on battery before critical alarm] box.

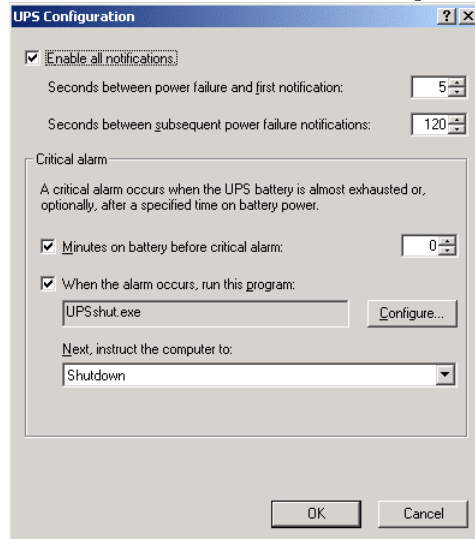

When you click the <OK> button in the [UPS Configuration] dialog in this condition, the following error message appears.

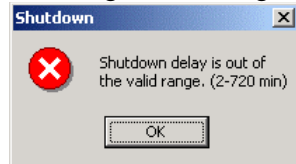

Click the <OK> button in the error message. Then, click the <Cancel> button in the [UPS Configuration] dialog.

When “2” is entered for the [Minutes on battery before critical alarm] box, the shutdown procedure starts two minutes later after a power failure occurs. If this time is set to longer than 2 minutes, execute the “UPS.reg” and set the time to “0” referring to step (11) in the section 10.6.3 *Setting up the Automatic Shutdown at the Time of a Power Failure*.



[For users who use the RC420 Controller with UPS]

The RC420 Controller is configured at factory as shown below:

EPSON RC+4.1 or before (Windows 2000)		EPSON RC+4.2 or after (Windows XP)	
Computer Name	SN***** (Serial No. *)	Computer Name	SN***** (Serial No. *)
User Name	Administrator	User Name	EPSON RC User
Password	Not set	Password	epson

\* Serial No. (SN\*\*\*\*\*)

: \*\*\*\*\* denotes a five-digit number and it is unique to each Controller.

When the computer name, user name, or password is changed, the UPS will not automatically shut down the RC420 Controller in the case of a power failure despite its setting.

After you change the computer name, user name, or password, configure the UPS again so that it will automatically shut down the RC420 Controller in the case of a power failure. For details, refer to the section *10.6.3 Setting up the Automatic Shutdown at the Time of a Power Failure*.





# Maintenance

This manual contains maintenance procedures for the RC420 Robot Controller.



# 1. Safety Precautions on Maintenance

## 1.1 Safety Precautions

 <b>WARNING</b>	<ul style="list-style-type: none"> <li>■ Only authorized personnel who have taken the safety training should be allowed to maintain the robot system. The safety training is the program for industrial robot operator that follows the laws and regulations of each nation. The personnel who have taken the safety training acquire knowledge of industrial robots (operations, teaching, etc.), knowledge of inspections, and knowledge of related rules/regulations. The personnel who have completed the robot system-training and maintenance-training classes held by the manufacturer, dealer, or locally-incorporated company are allowed to maintain the robot system.</li> <li>■ Make sure to use only dedicated/specified maintenance parts especially for the optional boards or any other parts in the Controller to be replaced. Using non-specified parts may cause serious damage to the robot system and/or serious safety problems.</li> <li>■ Do not remove any parts that are not covered in this manual. Follow the maintenance procedure strictly as described in this manual. Do not proceed using any methods other than described in this manual when you do replace a part or maintain the equipment. Improper removal of parts or improper maintenance may cause not only improper function of the robot system but also serious safety problems.</li> </ul>
 <b>WARNING</b>	<ul style="list-style-type: none"> <li>■ Before performing any maintenance procedure, always make sure that the main power of the Controller is turned OFF and that the high voltage charged area is completely discharged. Performing any maintenance procedure while the main power is ON or the high voltage charged area isn't discharged completely is extremely hazardous and may result in electric shock and/or cause serious safety problems.</li> </ul>
 <b>CAUTION</b>	<ul style="list-style-type: none"> <li>■ Do not touch directly the Motor Driver modules and the Switching Power Supply in the Controller. The Motor Driver modules and the Switching Power Supply can become very hot and may result in a burn. If you maintain them, examine the surface temperatures and wear protective gloves if necessary.</li> <li>■ Do not shock, shake, or drop any parts during maintenance. When the parts related with data (the FDD, HDD, etc.) are shocked physically, they may be damaged and may also cause data loss during data loading/saving.</li> <li>■ Do not lose the screws removed at maintenance. When the screw is dropped into the Controller, be sure to take it out. Leaving the screw in the Controller may cause short circuit and may result in equipment damage to the parts and/or robot system.</li> </ul>

 <b>CAUTION</b>	<ul style="list-style-type: none"> <li>■ Make sure that the power rating (wattage) of a new Motor Driver module is correct. Using a Motor Driver module with improper power rating (wattage) in the Controller may not only cause improper function of the robot system but also damage to the system.</li> <li>■ The serial number of the Manipulator that should be connected is indicated on the Connection Check Label on the Controller. Connect the Controller and the Manipulator correctly. Improper connection between the Controller and the Manipulator may cause not only improper function of the robot system but also serious safety problems.</li> </ul>
---	--



NOTE Before performing maintenance on the Controller, all the data must be copied as a backup. The details of data backup/restore are described in the Maintenance *2.5 Backup of Data*

## 1.2 Lockout

The lockout is a method to prevent any one from turning ON the robot system by mistake while someone else is within the safeguarded area for maintenance or repair.

When the robot system is locked out, the POWER switch of the Controller is locked in the OFF position. The procedure for lockout is shown below.

- (1) Turn OFF the Controller.
- (2) Tilt the lockout metal hasp in the direction of the arrow indicated below.

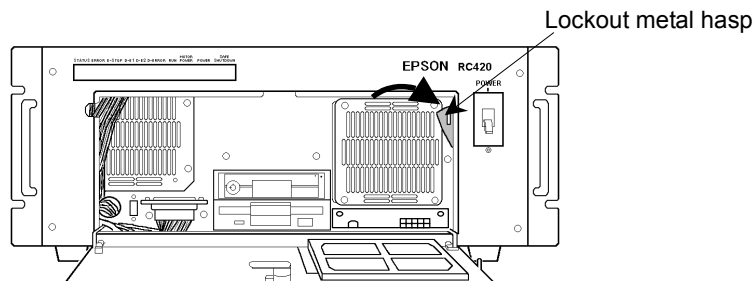

- (3) Close the front door while the metal hasp comes out as shown below.

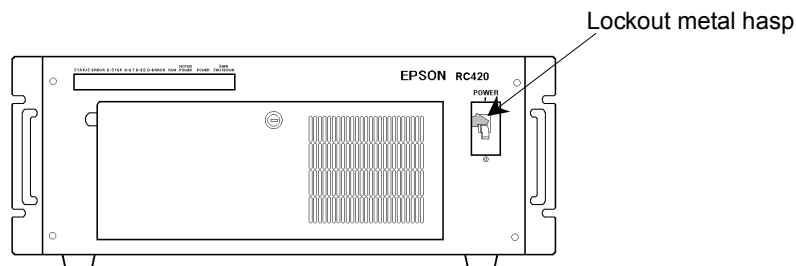

## 1.3 Tagout

The tagout method is attaching a tag or sign plate to the Power switch to prevent any one from turning ON the robot system by mistake while someone else is within the safeguarded area for maintenance or repair.

## 2. Regular Maintenance Inspection

Performing the inspection steps properly is essential to preventing trouble and maintaining safety. This chapter describes schedule for maintenance inspection and the procedures.

Be sure to perform the maintenance inspection in accordance with the schedule.

### 2.1 Schedule for Maintenance Inspection

Inspection points are divided into five stages: daily, monthly, quarterly, biannual, and annual. The inspection points are added every stage.

If the robot system is operated for 250 hours or longer per month, the inspection points must be added every 250 hours, 750 hours, 1500 hours, and 3000 hours operation.

	Inspection Point				
	Daily inspection	Monthly inspection	Quarterly inspection	Biannual inspection	Annual inspection
1 month (250 h)	Inspect every day	✓			
2 months (500 h)		✓			
3 months (750 h)		✓	✓		
4 months (1000 h)		✓			
5 months (1250 h)		✓			
6 months (1500 h)		✓	✓	✓	
7 months (1750 h)		✓			
8 months (2000 h)		✓			
9 months (2250 h)		✓	✓		
10 months (2500 h)		✓			
11 months (2750 h)		✓			
12 months (3000 h)		✓	✓	✓	✓
13 months (3250 h)		✓			
⋮	⋮	⋮	⋮	⋮	⋮

## 2.2 Inspection Point

### 2.2.1 Inspection While the Controller is Turned OFF

Inspection Point	Inspection Place	Daily	Monthly	Quarterly	Biannual	Annual
Visually check for external defects. Clean up if necessary.	External appearance of Controller	✓	✓	✓	✓	✓
Cleaning of the fan filter	Fan filter on the Controller		✓	✓	✓	✓
Battery Replacement on the CPU Board	CPU Board	Ever 5 years				

### 2.2.2 Inspection While the Controller is Turned ON

Inspection Point	Inspection Place	Daily	Monthly	Quarterly	Biannual	Annual
Check whether unusual sound or vibration occurs.	Whole of the Controller	✓	✓	✓	✓	✓
Make a backup of data.	Project and system data	Whenever data are changed.				

## 2.3 Cleaning the Fan Filter

NOTE



Check condition of the filter regularly and clean it as necessary. A dirty filter may result in the malfunction of the robot system as the temperature rises in the Controller.

Refer to the Maintenance 10.4. *Fan Filter* for details on cleaning the fan filter.

## 2.4 Replacing a Lithium Battery on the CPU Board

The button type lithium battery is mounted on the CPU board for backup of BIOS settings. The battery life is five years. Replace the battery every five years.

 CAUTION	<ul style="list-style-type: none"> <li>■ Lithium batteries contain flammable materials such as lithium, organic solvents, etc. If misused, batteries may generate heat, explode or catch fire. Observe the following precautions for safe use of lithium batteries.                     <ul style="list-style-type: none"> <li>- Use the specified type of battery or equivalent. CR2032 (Panasonic)</li> <li>- Connect the positive (+) and negative (-) electrodes correctly.</li> <li>- Do not allow the positive (+) and negative (-) electrodes to short circuit at maintenance.</li> <li>- Do not throw batteries into fire or heat them to high temperature.</li> <li>- Do not disassemble or alter batteries.</li> <li>- When discarding batteries, insulate the terminals by wrapping them with tape, etc.</li> </ul> </li> </ul>
--	--



- (1) Remove the CPU board from the Control Unit. Refer to the Maintenance 10.2 *Replacing CPU Board* for details.

CPU Board:SPI-6941-EPC

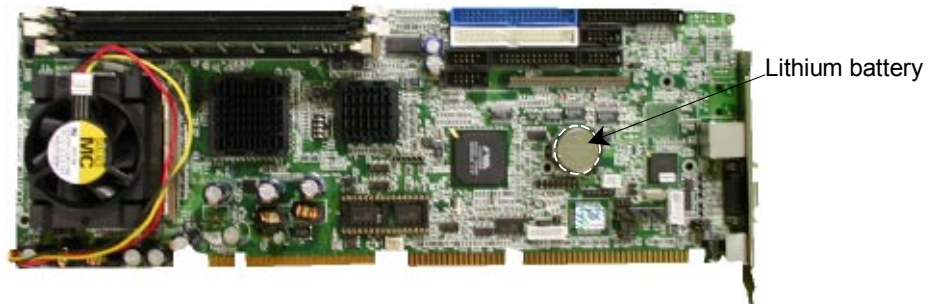

CPU Board :PC686BX(PC)-EPC850

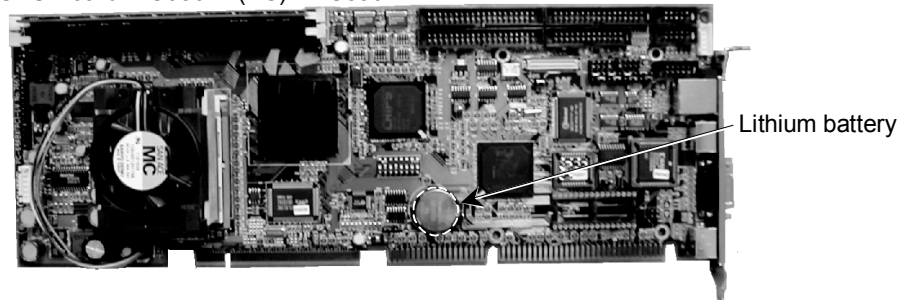

- (2) Replace the lithium battery with new one.
- (3) After replacing the lithium battery, set up the BIOS.
  - 3-1. Turn ON the Control Unit while pressing the <Delete> key on the keyboard. The [BIOS] dialog will appear.
  - 3-2. Select the “Standard COMS Features” and press the <Enter> key.
  - 3-3. Set the “Date” and “Time” to current date and time. (Use the <Page Up> key for changing the setting items and the arrow keys <↑> <↓> <→> <←> for moving a cursor.)
  - 3-4. Press the <Esc> key. The [BIOS] dialog will appear.
  - 3-5. Select the “PnP/PCI Configurations” and press the <Enter> key.
  - 3-6. Select the “IRQ Resources [Press Enter]” and press the <Enter> key.
  - 3-7. Set the “IRQ-5”, “IRQ-10”, and “IRQ-11” to the “Legacy ISA”. (Use the <Page Up> key for changing the setting items and the arrow keys <↑> <↓> <→> <←> for moving a cursor.)
  - 3-8. Press the <Esc> key twice. The [BIOS] dialog will appear.
  - 3-9. Press the <F10> key. The message “SAVE to COMS and EXIT (Y/N)?” will appear.
  - 3-10. Press the <Y> key and then <Enter> key. The system will be automatically restarted.

## 2.5 Backup of Data

The system hardware and manipulator configuration data are saved in a backup file that can be used to restore the whole system.

 <b>CAUTION</b>	<ul style="list-style-type: none"> <li>■ Save a backup data of your project and system settings in a floppy disk while the Control Unit operates properly. Then, keep the floppy disk in case of damage to the data in HDD. Be sure to back up the latest data whenever you change the project and system settings. If the latest data is not backed up, it takes a lot of time to restore the robot system data once the robot system has a trouble. The robot system data after the trouble may fail to be backed up. Even if the robot system data is backed up successfully, the backed up data is unreliable and the robot system data cannot be restored completely with it.</li> <li>■ Do not restore the backup data in any other system. The data includes the original configuration of the system. If the data is restored in the other system, the system may function improperly or EPSON RC+ may fail to start up. If EPSON RC+ is downgraded and its version is different even though the backup data is for the same system, an error may occur and the data may fail to be restored.</li> </ul>
---	--

For EPSON RC+, you can save and restore the system configuration using the MKVER and SETVER commands. Before servicing the system, you should execute MKVER and store the system configuration on a floppy disk. If required, you can use SETVER to restore previously stored data.



When you attempt to make backup copies of the system configurations using the MKVER and SETVER commands, the configuration data in the following tabs cannot be backed up. Record such configurations data displaying the [System Configuration] dialog. (Select the [System Configuration] in the [Setup] menu to display the [System Configuration] dialog.)

[Start Up] tab

[Vision] tab (option)\*

[Security] tab (option)

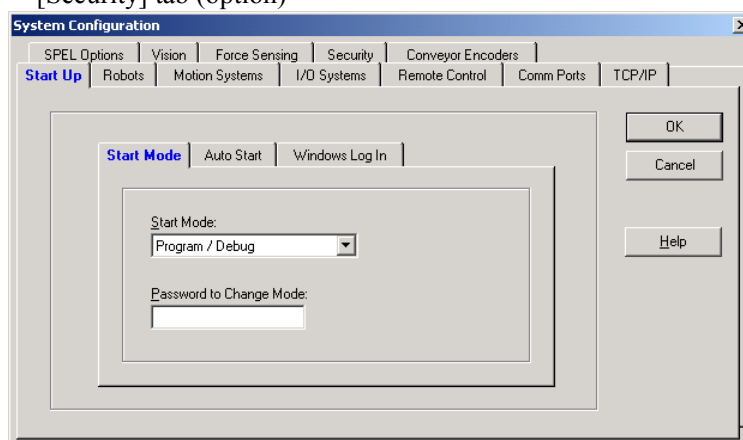

\* [Vision] tab (option):  
If your EPSON RC+ is 4.1.0 or higher, recording the items on the [Vision] is not necessary.

After restoring the backup data, configure the settings for the recorded items in the respective tabs.

## Back up system configurations

**MKVER:** Backs up (saves) system configurations.

- (1) Select either one of the following to open the [Maintenance] dialog.
  1. Select the [Maintenance] in the [Tools] menu.
  2. Click the  icon.

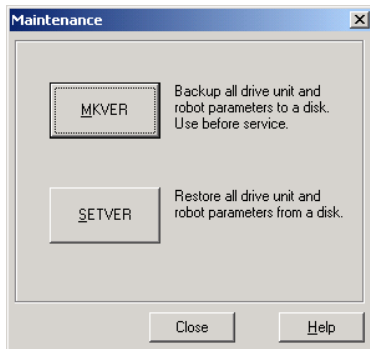

- (2) Click the <MKVER> button to open the [MKVER] dialog.

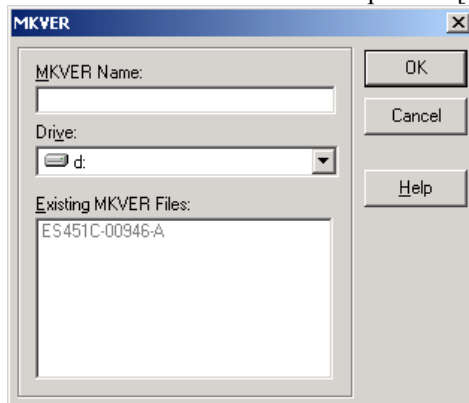

- (3) Type in a unique name to identify the system in the [MKVER Name] text box.
- (4) Select the disk drive where you want to save the information in the [Drive] box. (You can select any drive except for C drive.)
- (5) Click the <OK> button to save the system configuration.

### Restore system configurations

**SETVER:** Restores system configurations.

- (1) Select either one of the following to open the [Maintenance] dialog.
  1. Select the [Maintenance] in the [Tools] menu.
  2. Click the  icon.

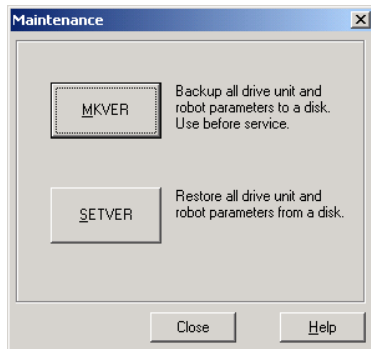

- (2) Click the <SETVER> button to open the [SETVER] dialog.

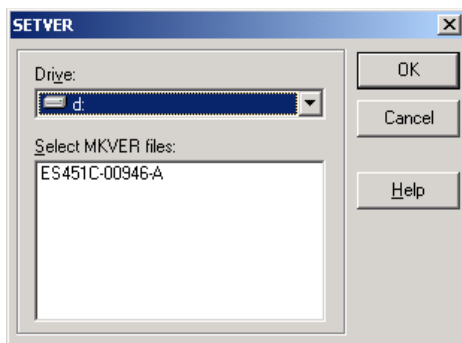

- (3) Select the drive where the backed-up information is stored in the [Drive] box.
- (4) Select the system configuration from the [Select MKVER files] list box.
- (5) Click the <OK> button to restore the system configuration.

## Backing up / Restoring a Project

You can back up the whole of stored project and restore it. You can also move your developing EPSON RC+ applications into another system.

### Back up a project

Follow the steps below to make a backup copy of the current project.

- (1) Select the [Copy] command in the [Project] menu to open the [Copy Project] dialog.

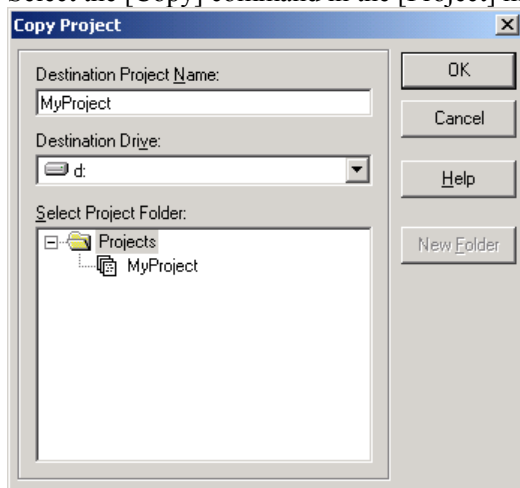

- (2) Select the drive where a backup copy will be made in the [Destination Drive] box.
- (3) Enter the current project name for the [Destination Project Name] box.
- (4) Click the <OK> button.

**NOTE**



The currently open project is the original project stored in the C drive, not a backed-up project stored in the destination drive specified in step (2).

**NOTE**



If there is more than one project, back up every project separately.

### Restore a project

Follow the steps below to restore the backed-up project.

- (1) Select the [Open] command in the [Project] menu to open the [Open Project] dialog.

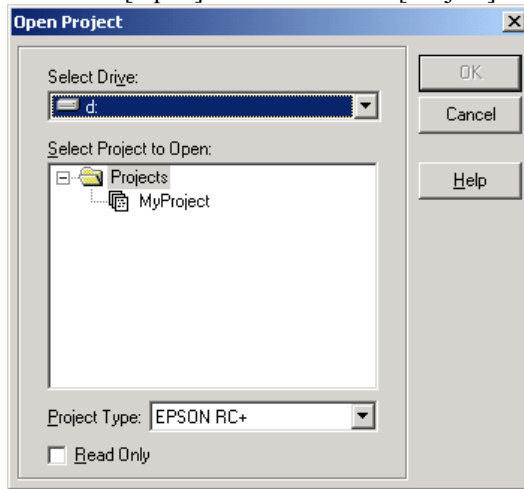

- (2) Select the drive where the backed-up project is stored in the [Select Drive] box and open the backed-up project.



The currently open project is the backed-up project stored in the drive you select in the [Select Drive] box.

- (3) Select the [Save As] command in the [Project] menu to open the [Save Project As] dialog.

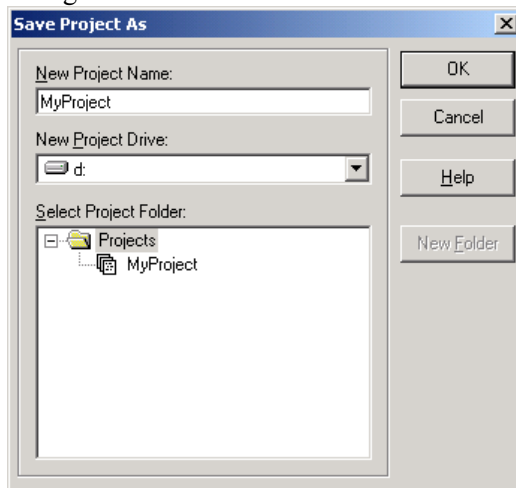

- (4) Select the "C drive" in the [New Project Drive] box.
- (5) Enter a project name for the [New Project Name] box.
- (6) Click the <OK> button.



The currently open project is the project stored in the C drive.

### 3. Controller Internal Layout

The internal layout for the Controller is shown in following three pictures.  
 You can see the layout as shown in the picture below when removing the Top Cover.

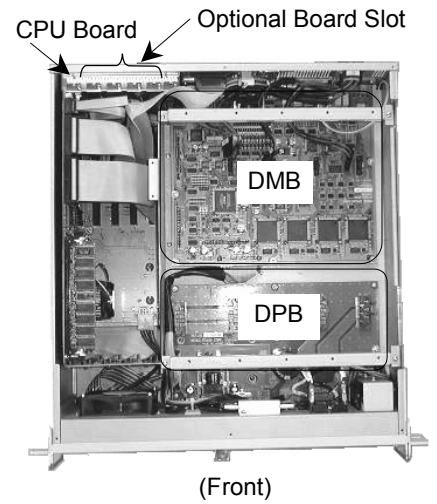
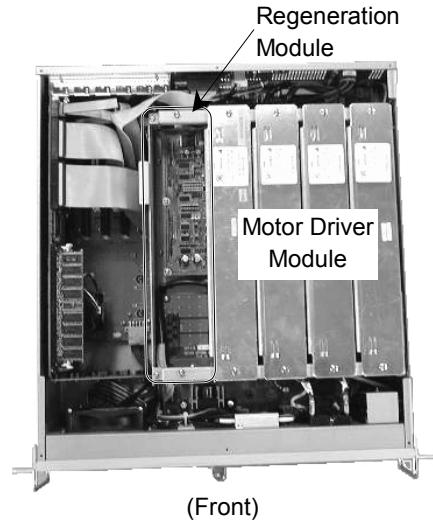

NOTE  



When required, the Regeneration module must be mounted in the last Motor Driver module slot, as shown above.

You can see the DMB and the DPB after removing the Motor Driver modules.

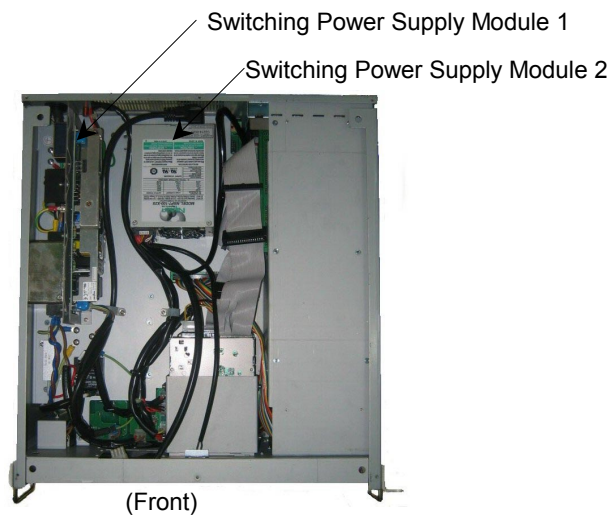
You can see the layout as shown in the picture below when removing the Bottom Cover.

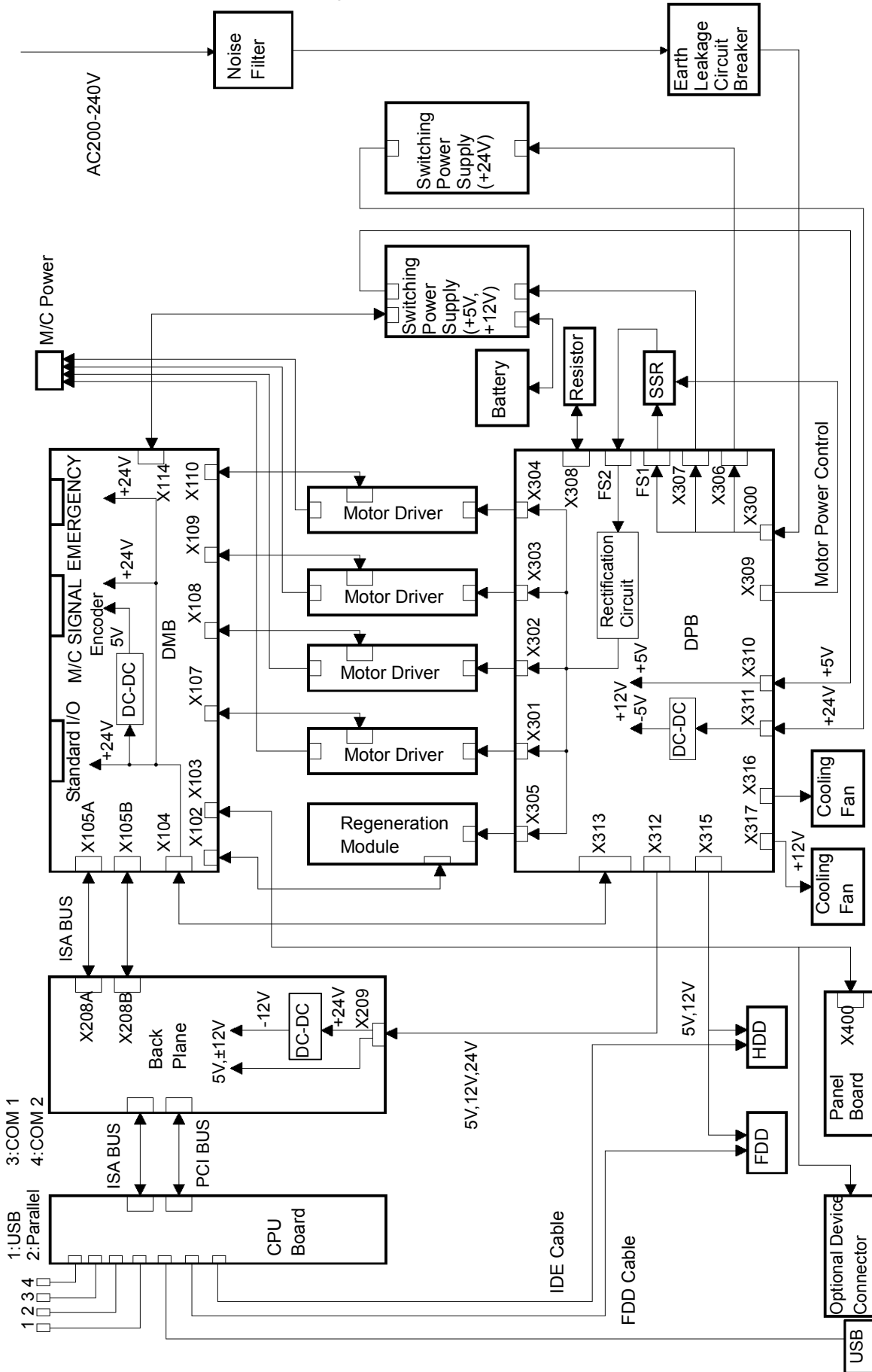

RC420 Block Diagram





## 4. Pin Assignments for the System Connectors

### 4.1 M/C Power Cable

The following tables show the pin assignments for the M/C power connector and M/C signal connector. As for the pin assignments of the connectors not covered in this section, refer to the *Setup & Operation*.

Pin No.	Signal Name	Pin No.	Signal Name
1	1U	9	3W
2	4V	10	2U
3	1V	11	NC
4	4U	12	NC
5	SHIELD	13	3V
6	1W	14	2V
7	4W	15	3U
8	NC	16	2W
		⊕	FG

## 4.2 M/C Signal Cable

Pin No.	Signal Name	Pin No.	Signal Name	Pin No.	Signal Name
1	EG	26	1S	51	$\overline{2B}$
2	4A	27	1HOME	52	$\overline{2Z}$
3	4B	28	ENC+5V	53	$\overline{2S}$
4	4Z	29	NC	54	NC
5	4S	30	NC	55	ENC+5V
6	4HOME	31	NC	56	EG
7	ENC+5V	32	EMB1	57	$\overline{1A}$
8	EG	33	+24V	58	$\overline{1B}$
9	3A	34	RG	59	$\overline{1Z}$
10	3B	35	EG	60	$\overline{1S}$
11	3Z	36	$\overline{4A}$	61	HCOM
12	3S	37	$\overline{4B}$	62	ENC+5V
13	3HOME	38	$\overline{4Z}$	63	NC
14	ENC+5V	39	$\overline{4S}$	64	NC
15	EG	40	NC	65	NC
16	2A	41	ENC+5V	66	EMB2
17	2B	42	EG	67	+24V
18	2Z	43	$\overline{3A}$	68	RG
19	2S	44	$\overline{3B}$		
20	2HOME	45	$\overline{3Z}$		
21	ENC+5V	46	$\overline{3S}$		
22	EG	47	NC		
23	1A	48	ENC+5V		
24	1B	49	EG		
25	1Z	50	$\overline{2A}$		

NOTE  

The Controller's and Manipulator's pin numbering layout differs: one is lined horizontally and the other is lined vertically.

## 5. Switching Power Supply Module

### 5.1 Layout and Functions

Switching Power Supply Module 1: AES100W-24

Switching Power Supply module 1 rectifies AC200V (or the local equivalent) and outputs +24V. The +24V is converted by the DPB to supply power to the control power sources: the motor driver (-5V) and the encoder (5V).

Switching Power Supply Module 2: NSP7-100-X2S2

Switching Power Supply module 2 rectifies AC200V (or the local equivalent) and outputs +12V, +5V.

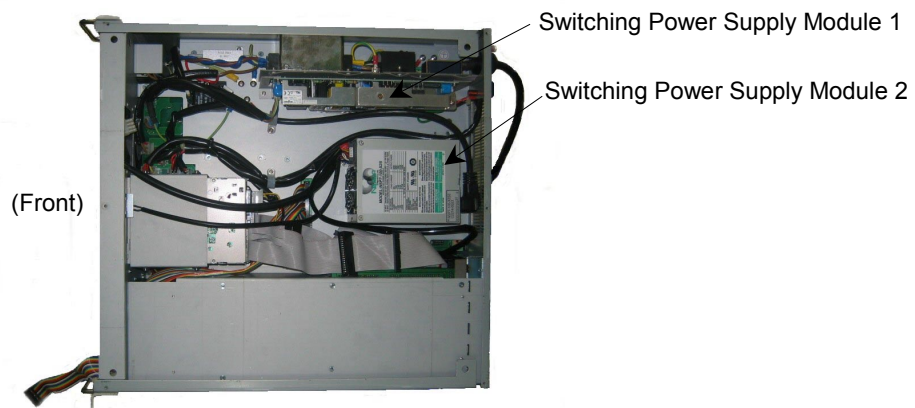

### 5.2 Inspection

Inspect the Switching Power Supply modules by following the steps below:

- (1) Turn ON the Controller.
- (2) From the Controller's front panel, check if the POWER LED (green) is ON.

NOTE  

If this LED is either OFF or dim, suspect that the +24V power output is not normal.

- (3) From the Controller's front panel, check if the RUN LED (green) is blinking.

NOTE  

If this LED is not blinking or it is dim, the +5V and +12V power outputs may be not normal.

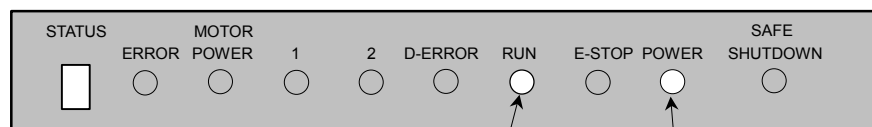

(3) RUN LED (Green)      (2) POWER LED (Green)

## 5.3 Replacement

### 5.3.1 Replacing Switching Power Supply Module 1:



WARNING

- Before performing any maintenance procedure, always make sure that the main power of the Controller is turned OFF and that the high voltage charged area is completely discharged. Performing any maintenance procedure while the main power is ON or the high voltage charged area isn't discharged completely is extremely hazardous and may result in electric shock and/or cause serious safety problems.

- (1) Shut down Windows, and turn OFF the Controller.
- (2) Disconnect all the cables from the back of the Controller.
- (3) Turn OFF the UPS ON/OFF switch.

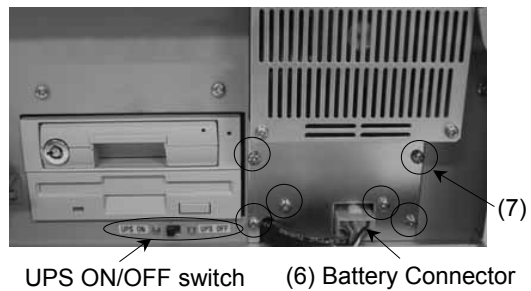

- (4) Wait for about 1 minute until the high voltage charged area is completely discharged. Remove four mounting screws, and remove the front cover from the Controller.
- (5) Remove the connector (X400) of the board for display from the front cover.
- (6) Remove the battery connector.
- (7) Remove six mounting screws, and remove the battery cover.
- (8) Pull out the battery from the Controller.



- (9) Remove six mounting screws, and remove the Bottom Cover.
- (10) Remove the CN1 and CN2 connectors.
- (11) Remove the screws 1 and 2, and remove the Switching Power Supply module 1.

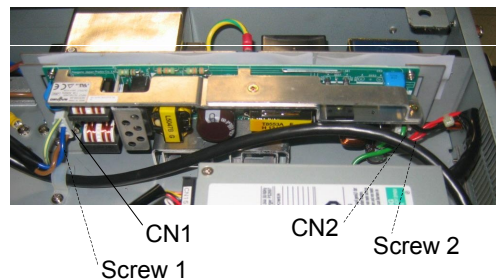

- (12) Remove four mounting screws, and remove the metal plates from the Switching Power Supply module 1.
- (13) Secure the metal plates to a new Switching Power Supply module 1 with the four mounting screws.
- (14) Mount the new Switching Power Supply module 1 in the same position.
- (15) Secure the new Switching Power Supply module 1 with the screws 1 and 2.
- (16) Connect the CN1 and CN2 connectors.
- (17) Secure the Bottom Cover to the Controller with the six mounting screws.
- (18) Insert the battery into the Controller.
- (19) Secure the battery cover to the Controller with the six mounting screws.
- (20) Connect the battery connector to the battery.
- (21) Connect the connector (X400) of the board for display to the front cover.
- (22) Secure the front cover to the Controller with the four mounting screws.
- (23) Turn ON the UPS ON/OFF switch.
- (24) Connect the all the cables to the back of the Controller.

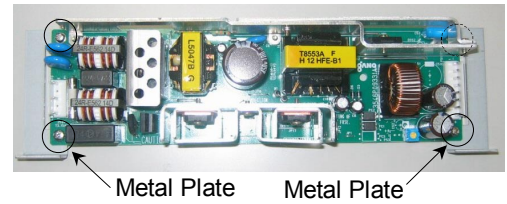

### 5.3.2 Replacing Switching Power Supply Module 2:

 <b>WARNING</b>	<ul style="list-style-type: none"> <li>■ Before performing any maintenance procedure, always make sure that the main power of the Controller is turned OFF and that the high voltage charged area is completely discharged. Performing any maintenance procedure while the main power is ON or the high voltage charged area isn't discharged completely is extremely hazardous and may result in electric shock and/or cause serious safety problems.</li> </ul>
---	---

- (1) Perform the step (1) through (9) in the previous section 5.3.1 *Replacing Switching Power Supply Module 1*.
- (2) Remove five connectors from the Switching Power Supply module 2.  
 CN7 and CN8 connectors:  
     Projections on the upper side  
 CN15 connector:  
     Projections on the lower side

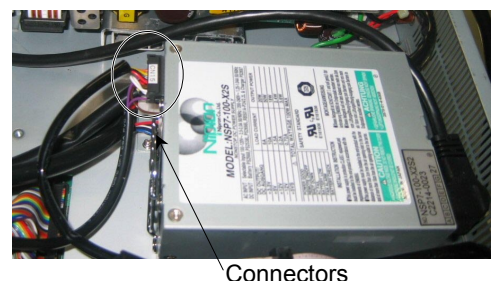

- (3) Remove four mounting screws, and remove the Switching Power Supply module 2.



On the front side



On the rear side

- (4) Remove two mounting screws, and remove the metal plate from the Switching Power Supply module 2.
- (5) Secure the metal plate to a new Switching Power Supply module 2 with the two mounting screws.



Metal Plate

- (6) Mount the new Switching Power Supply module 2 in the same position. Then, secure it with the four mounting screws.
- (7) Connect the five connectors to the new Switching Power Supply module 2.
- (8) Secure the Bottom Cover to the Controller with the six mounting screws.
- (9) Insert the battery into the Controller.
- (10) Secure the battery cover to the Controller with the six mounting screws.
- (11) Connect the battery connector to the battery.
- (12) Connect the connector of the board for display to the front cover.
- (13) Secure the front cover to the Controller with the four mounting screws.
- (14) Turn ON the UPS ON/OFF switch.
- (15) Connect the all the cables to the back of the Controller.

## 6. Motor Driver Module

### 6.1 Layout and Functions

#### Layout

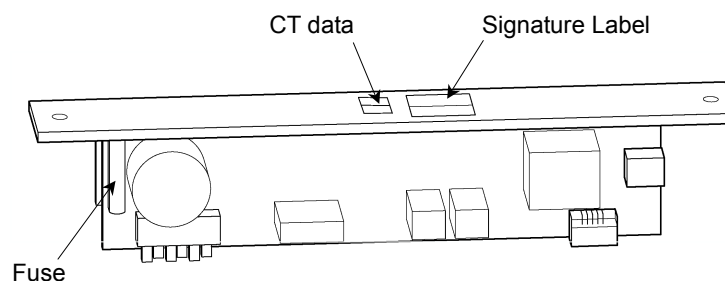

#### Signature Label

The Signature Label on the heat sink indicates capacity in wattage for each Motor Driver module.

Model	Capacity (W)
CACR-A5-SU3C	50 W
CACR-01-SU3C	100 W
CACR-02-SU3CY1	200 W
CACR-04-SU3C	400 W
CACR-08-SU3C	750 W

The power rating (wattage) of the mounted Motor Driver module corresponds to the wattage of its driving motor. However, a 150W motor requires either a 100W or 200W Motor Drive module depending on the Manipulator models. For details, refer to the maintenance parts list in the Manipulator manual.

#### CT data

The CT data beside the signature label indicates specific information to each Motor Driver module. In order to optimize the Controller's control over the Manipulator, the exact same values as indicated here must be set up in the Controller after the motor Driver module is replaced.

There are two kinds of CT data as follows:

4B-\*\*\*\* : "CT OFFSET".

4D-\*\*\*\* : "CTGAIN".

The mark, "\*", on the CT data is indicated with "0" to "9" and "A" to "F".  
The indication is different depending on the Driver module.



Record the CT data to be entered in the Controller before placing the Top Cover back on the Controller when replacing the Motor Driver module. After the replacement, refer to User's Guide and set up the CT data.

## 6.2 Replacing a Motor Driver Module

Replace a Motor Driver module by following the steps described below.



- Make sure that the power rating (wattage) of a new Motor Driver module is correct. Using a Motor Driver module with improper power rating (wattage) in the Controller may not only cause improper function of the robot system but also damage to the system.

- (1) Shut down Windows, and turn OFF the Controller
- (2) Disconnect all the cables from the back of the Controller.
- (3) Wait for about 1 minute until the high voltage is completely discharge.  
Remove the Top Cover by removing the six mounting screws.
- (4) Remove the two mounting screws for the Motor Driver module as shown in the picture below.

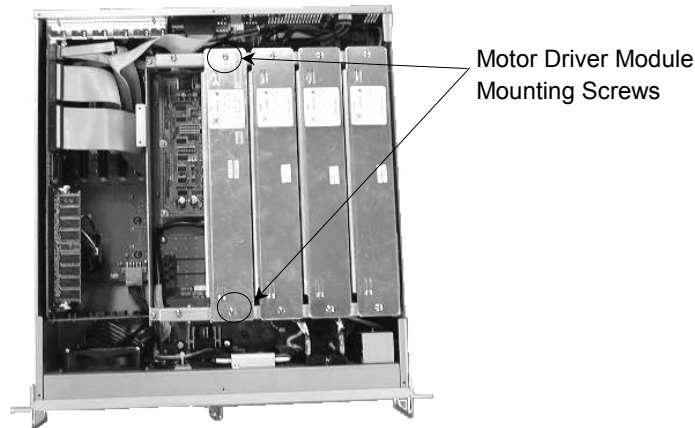

- (5) Pull the Motor Driver module up far enough so that the cable connected on the back can be disconnected. Compress the projections on both sides of the connector to disconnect the cable.

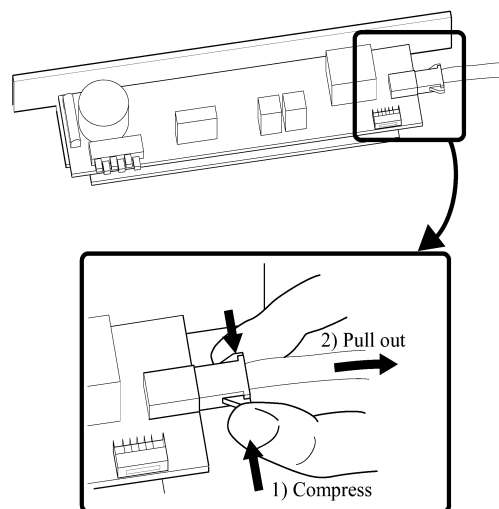

- (6) Connect the cable to a new Motor Driver module.



- (7) Press down the module carefully and gradually to match the connectors on DPB and DMB.

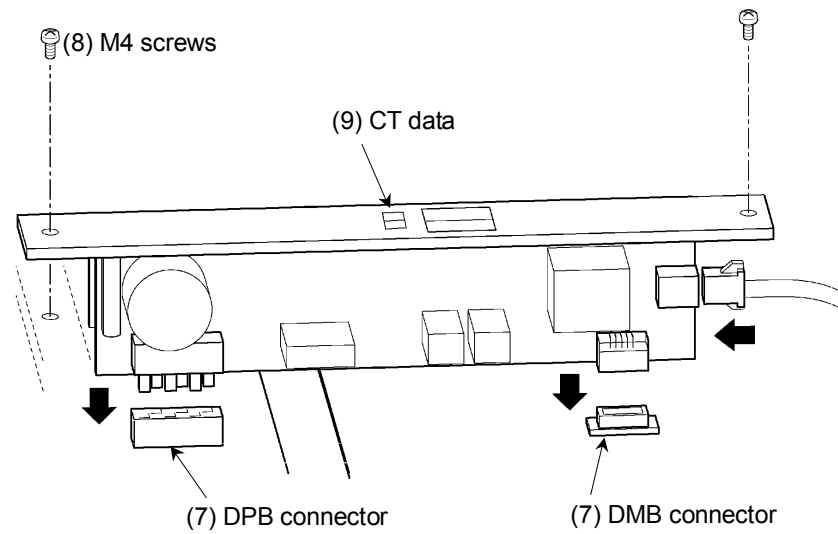

- (8) Secure the new Motor Driver module.
- (9) Record the CT data.
- (10) Mount the Top Cover.
- (11) Set up the CT data. For details, refer to the section, *RC420 Drive Module Software Configuration* in the chapter, *Motion Systems* in EPSON RC+ User's Guide.



# 7. DPB (Drive Power Board)

## 7.1 Layout and Functions

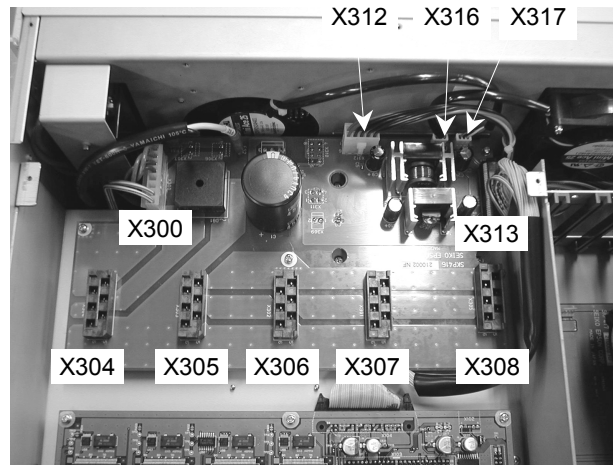

Connector No.	Function
X300	The connector to input the AC200V from the power switch
X301-X304	The connectors to supply motor power to the Motor Driver module.
X305	The connector to supply motor power to the Regeneration module.
X312	The connector to input the +5V and +12V to the backplane.
X313	The connector to connect the DMB interface cable.
X316	The connector to connect the Cooling Fan on the left side as you face the front.
X317	The connector to connect the Cooling Fan on the right side as you face the front.

The connectors are on the back side of the DPB as shown below. Remove the Bottom Cover from the Controller to check these connectors.

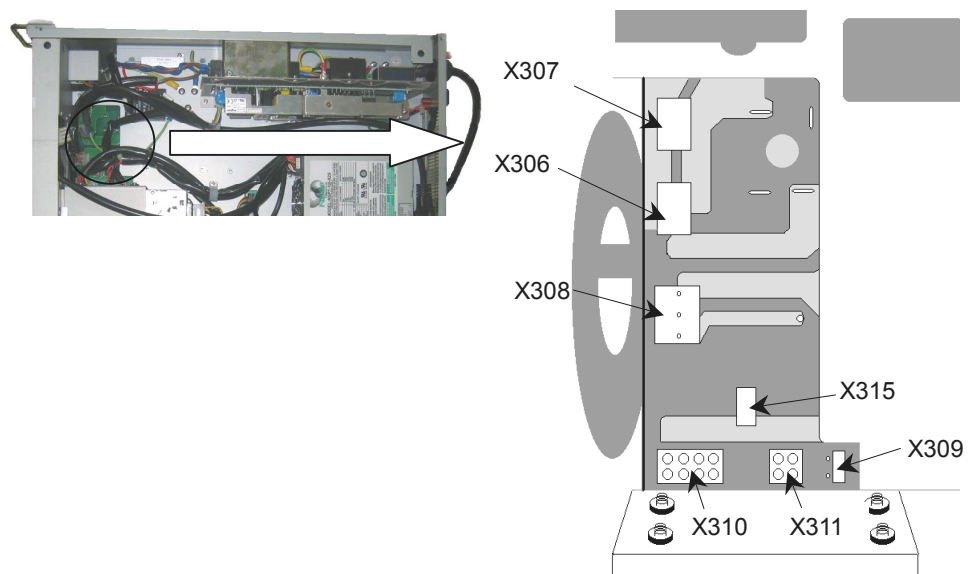

Connector No.	Function
X306, X307	The connector to output the AC200V to the Switching Power Supply.
X308	The connector to output to the discharging resistor.
X309	The connector for the SSR (Solid State Relay) Control Signal.
X310	The connector to input the +5 V and +12 V from the Switching Power Supply module.
X311	The connector to input the +24V from the Switching Power Supply module.
X315	The connector to input the +5 V and +12 V to the HDD and FDD.

## 7.2 Adjusting Encoder Voltage

You may adjust the Encoder Power Supply voltage using a control, VR1 as follows:

- (1) Turn ON the Controller to boot the controller software while pressing the Emergency Stop switch. Make sure that the encoder power is being supplied by checking LED1 on the Manipulator’s relay board. (The LED must be ON.)
- (2) Measure the voltage between the encoder +5V and the GND pin on the Encoder Signal connector of the longest motor cable in the Manipulator. (As for which pins to use, refer to the Manipulator manual.)

If the encoder voltage is not within the range of 4.9 V to 5.2 V, adjust it as follows:

- (3) The VR1 control used to adjust the Encoder voltage can be accessed from the rear panel of the Controller, as shown below.

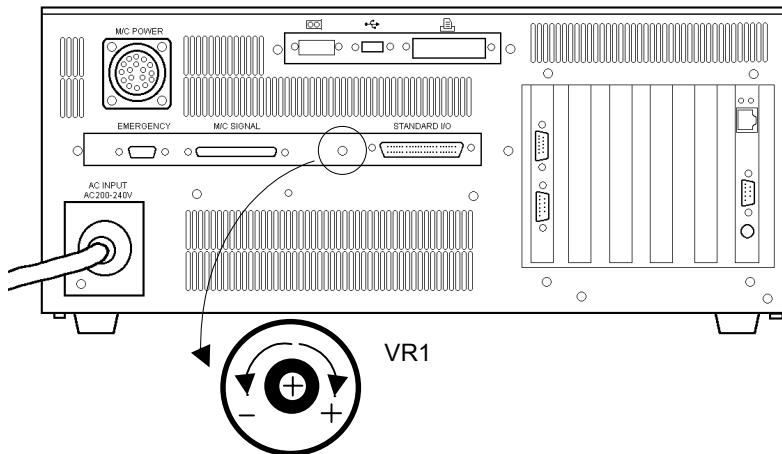

- (4) If the measured voltage is lower than 4.9 V, turn VR1 in the “+” direction by 1/2 turn to increase the voltage. If the measured voltage is higher than 5.2V, turn VR1 in the “-” direction by 1/2 turn to lower the voltage.
- (5) Repeat step (2) to ensure that the voltage is between 4.9 V and 5.2 V.
- (6) If necessary, repeat steps (4) and (5) until the voltage is within the range of 4.9 V to 5.2 V.

## 8. DMB (Drive Main Board)

### 8.1 Layout and Functions

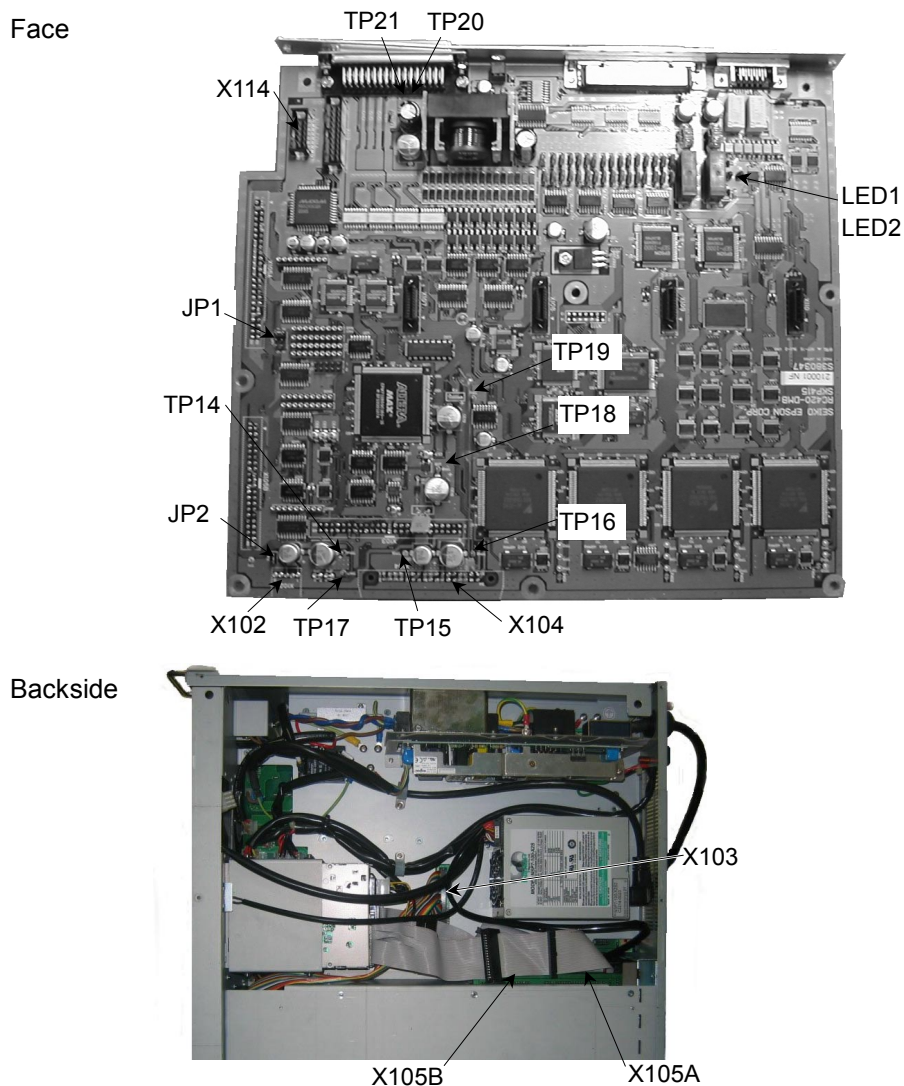

The test pins for voltage check

No.	Test pins for voltage check	Description
TP14	+5V	+5V for DMB
TP15	-5V	-5V for the Motor Driver module
TP16	+24V	+24V output voltage of the Switching Power Supply module
TP17	GND	GND for all the control power sources
TP18	+12V	+12V for the system panel
TP19	+5V	+5V for the Motor Driver module
TP20	+5.6V	Encoder power supply voltage
TP21	GND	GND for all the control power sources

Jumper (JP1)

1-2	3-4	5-6
	Short	

Short: Short-circuit

Jumper (JP2)

Condition	Description
JP2 short	If the regeneration module is not installed.
JP2 open	If the regeneration module is installed.

Connector

No.	Description
X102	The connector for the Signal cable of the Regeneration module.
X103	The connector for the interface cable for the front panel and the OPTIONAL DEVICE connector (Backside)
X104	The connector for the DPB interface cable
X105A	The connector for the interface cable for the backplane (Backside)
X105B	The connector for the interface cable for the backplane (Backside)
X114	The connector for the interface cable for the switching power supply module2

LED

No.	Description
1	ON while the power for Encoder is output.
2	ON while the Manipulator’s electromagnetic brake is released.

## 8.2 Replacing DMB

 WARNING	<ul style="list-style-type: none"> <li>■ Before performing any maintenance procedure, always make sure that the main power of the Controller is turned OFF and that the high voltage charged area is completely discharged. Performing any maintenance procedure while the main power is ON or the high voltage charged area isn’t discharged completely is extremely hazardous and may result in electric shock and/or cause serious safety problems.</li> </ul>
--	---

Replace DMB by following the steps described below.

- (1) Shut down Windows, and turn OFF the Controller.
- (2) Disconnect cables connected at the back of the Controller.
- (3) Wait for about 1 minute until the high voltage is discharged.
- (4) Turn over the Controller.
- (5) Remove the six mounting screws of the Bottom Cover and remove the Bottom Cover.
- (6) Disconnect the cables (X103, X105A, and X105B) from the backside of the DMB.

- (7) Turn over the Controller again.
- (8) Remove the six mounting screws of the Top Cover and remove the Top Cover
- (9) Remove the two DMB mounting screws on the back of the Controller as shown below.

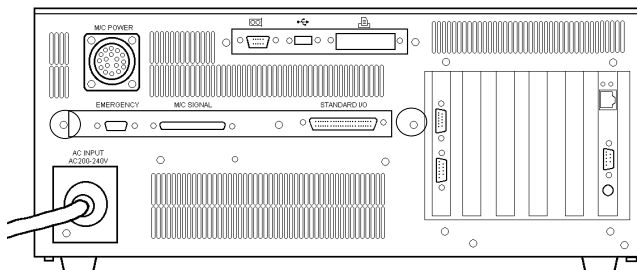

- (10) As shown below, remove the mounting screws for the motor drivers for four axes in the Controller.

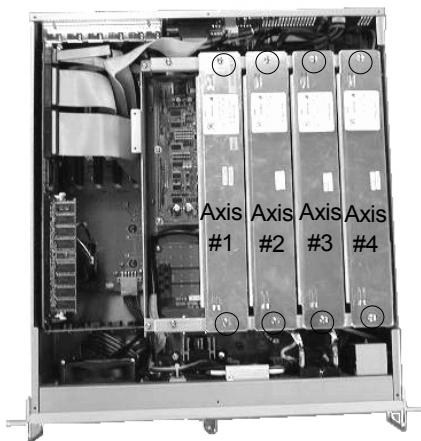

- (11) If a Regeneration module is installed, remove it by following the steps, (4) and (5), in the section *Maintenance 9.2 Replacing a Regeneration Module*.
- (12) Keep a written record of the corresponding axis number, CT data, and wattage for each module so that the modules can later be re-installed correctly.
- (13) Pull each Motor Driver module up and disconnect the cables from the back. Compress the projections on both sides of the connector to disconnect the cable.

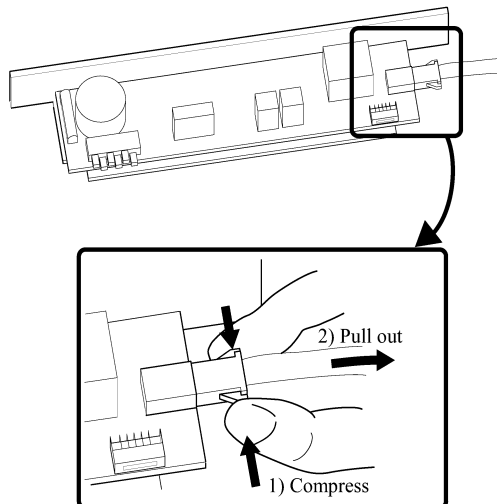

(14) Disconnect the flat cables (X104, X114) that connect to DMB.

(15) Remove six mounting screws securing the DMB to the Controller.

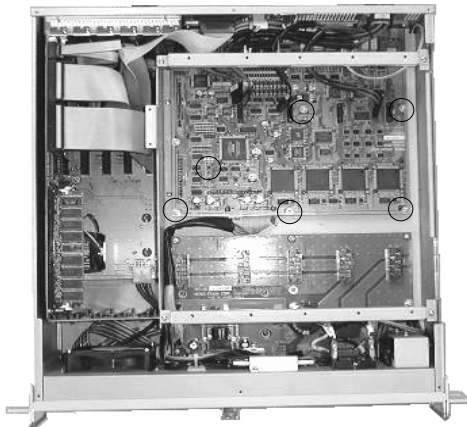

(16) Remove the old DMB.

(17) Install the new DMB and mount it with six mounting screws in the inside and two screws at the back loose enough so that it can still be moved around a little for positioning.

(18) Re-install the Motor Drivers for axis #1 and axis #3 just to position the DMB

(19) Tighten the eight mounting screws that are still loose from step (17).

(20) Connect the (X104, X114) cables that were disconnected in step (14).

(21) If the Regeneration module was removed in step (11), re-install it by referring to steps (6) and (7) described in the section *Maintenance 9.2 Replacing a Regeneration Module*.

(22) Fasten the mounting screws to secure the Motor Drivers.

(23) Mount the Top Cover to the Controller.

(24) Turn over the Controller.

(25) Connect the cables to the backside of the DMB.

(26) Mount the Bottom Cover to the Controller.

(27) Turn over the Controller again.

(28) Connect the cables to the back of the Controller.



## 9. Regeneration Module

### 9.1 Layout and Functions

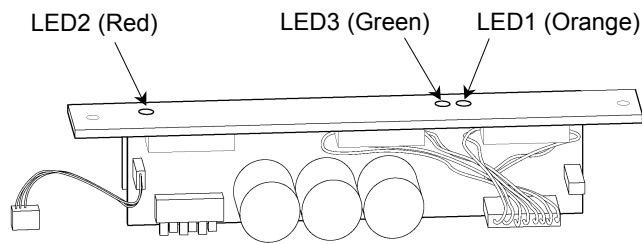

LED No.	LED Color	Description
LED1	Orange	This LED is ON when the system is in the regenerative process. (This process is to reduce the regenerated electricity by using resistors when the motor is decelerating so that the circuit can be protected.)
LED2	Red	This LED is ON when the system is detecting over-voltage.
LED3	Green	This LED is ON when the motor power is ON. (It may flicker while the Manipulator(s) is/are operating.)



If a Regeneration module is installed, JP2 on the DMB (Drive Main Board) must be “open”.

### 9.2 Replacing a Regeneration Module

Replace the Regeneration module by following the steps described below.

- (1) Shut down Windows, and turn OFF the Controller.
- (2) Disconnect all the cables from the back of the Controller.
- (3) Wait for about 1 minute until the high voltage is completely discharged.  
Then, remove the Top Cover by removing the six mounting screws.
- (4) Remove the two mounting screws for the Regeneration module.
- (5) Pull the Regeneration module up carefully, and disconnect the connector X102 from the DMB.

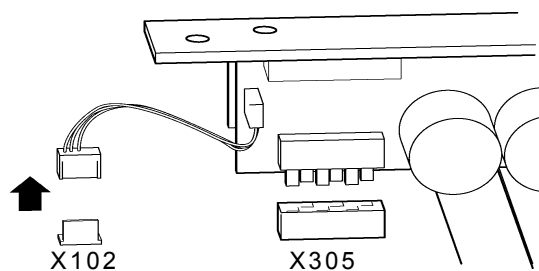

- (6) Connect the X102 connector of a new Regeneration module to the DMB.
- (7) The new Regeneration module must be pushed in carefully, while making it sure that the X305 connector engages properly.

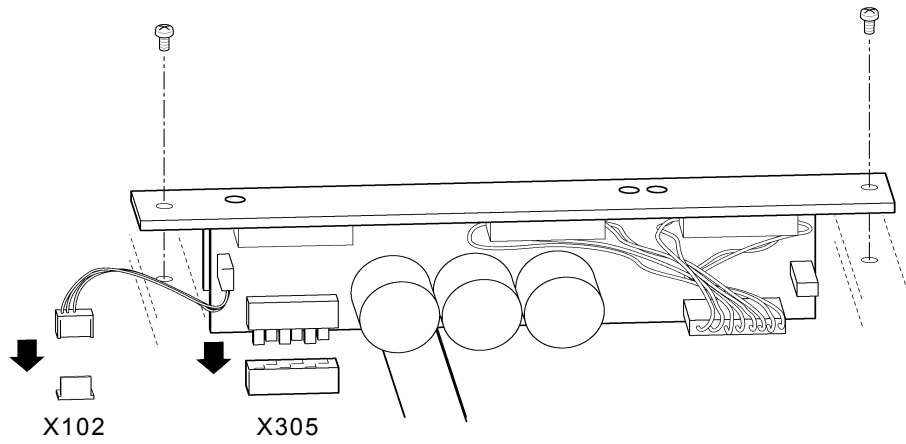

- (8) Mount the Regeneration module securely. Place the Top Cover back on.

## 10. Replacing Maintenance Parts

### 10.1 Optional Board

- (1) Shut down Windows. Turn OFF the Controller.
- (2) Disconnect the cable for the optional board from the back of the Controller.
- (3) Remove the Top Cover from the Controller.
- (4) Remove the four screws circled in the picture below for the board holder assembly and remove the assembly from the Controller.

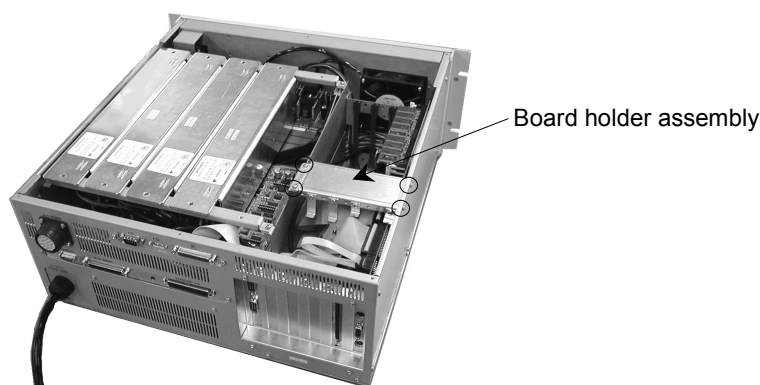

- (5) Disconnect all cables from the CPU board.
- (6) Remove the mounting screw for the optional board and remove the board from its slot.

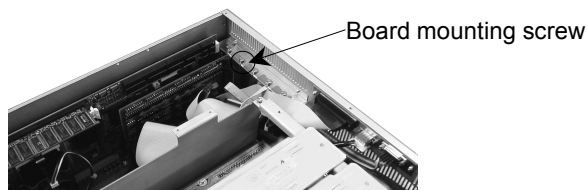

- (7) Install the new board in the slot and install the mounting screw.
- (8) Connect the cables that were disconnected in step (5) to the CPU board.
- (9) Mount the board holder assembly to the Controller.
- (10) Mount the Top Cover to the Controller.
- (11) Connect the cables that were disconnected before the board replacement to the back of the Controller.

### 10.2 CPU Board

- (1) Shut down Windows. Turn OFF the Controller.
- (2) Disconnect the cables for the CPU board from the back of the Controller.
- (3) Remove the Top Cover from the Controller.
- (4) Remove the four mounting screws for the board holder assembly and remove it.

- (5) Disconnect all cables from the CPU board. (HDD, FDD, Parallel Port, COM1, COM2, and USB.)

CPU Board: SPI-6941-EPC

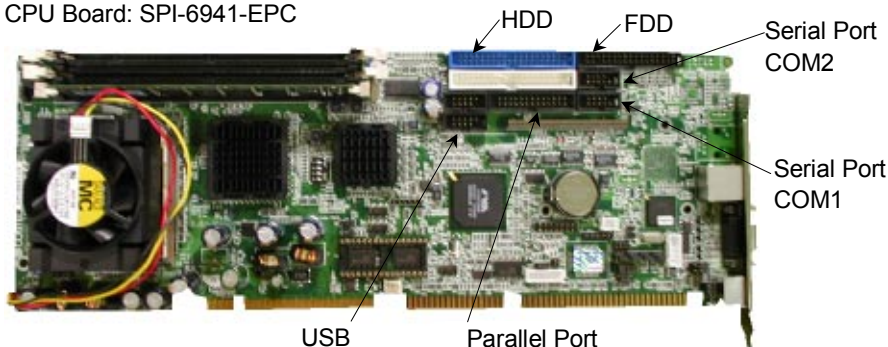

CPU Board: PC686BX(PC)-EPC850

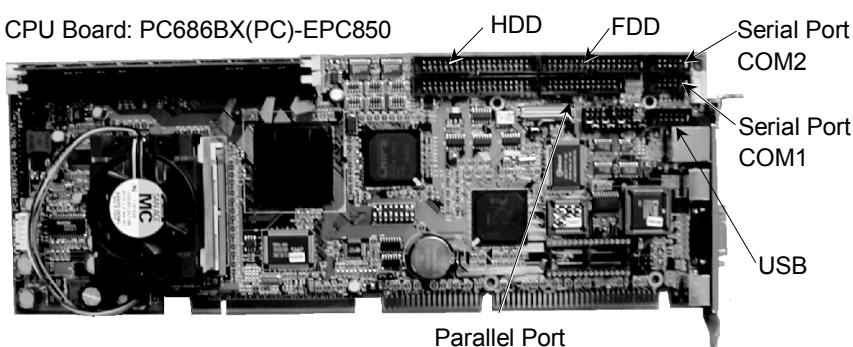

- (6) Remove the mounting screw for the CPU board on the back of the Controller and remove the CPU board from the slot.
- (7) Install the new CPU board in the slot. Then, mount the board to the slot with the mounting screw.
- (8) Connect the cables that were disconnected in step (5) to the CPU board.
- (9) Mount the board holder assembly in the Controller.
- (10) Mount the Top Cover to the Controller.
- (11) Connect the cables that were disconnected before the board replacement to the back of the Controller.

< Safety Precautions for Lithium Batteries >

 CAUTION	<ul style="list-style-type: none"> <li>■ Lithium batteries contain flammable materials such as lithium, organic solvents, etc. If misused, batteries may generate heat, explode or catch fire. Observe the following precautions for safe use of lithium batteries.                     <ul style="list-style-type: none"> <li>- Use the specified type of battery and connect the positive (+) and negative (-) electrodes correctly.</li> <li>- Do not allow the positive (+) and negative (-) electrodes to short circuit at maintenance.</li> <li>- Do not throw batteries into fire or heat them to high temperature.</li> <li>- Do not disassemble or alter batteries.</li> <li>- When discarding batteries, insulate the terminals by wrapping them with tape, etc.</li> </ul> </li> </ul>
--	---

## 10.3 HDD



CAUTION

- Do not shock, shake, or drop the HDD during maintenance. When the HDD is shocked physically, it may be damaged and may also cause data loss during data loading/saving.



NOTE

Back up the necessary data of the project and system before replacing the HDD. Then, restore the data of the project and system after the replacement.

The details of data backup/restore are described in the Maintenance *2.5 Backup of Data*.

- Shut down Windows. Turn OFF the Controller.
- Open the front panel door.
- Insert the key to the HDD key lock and turn the key to the right.

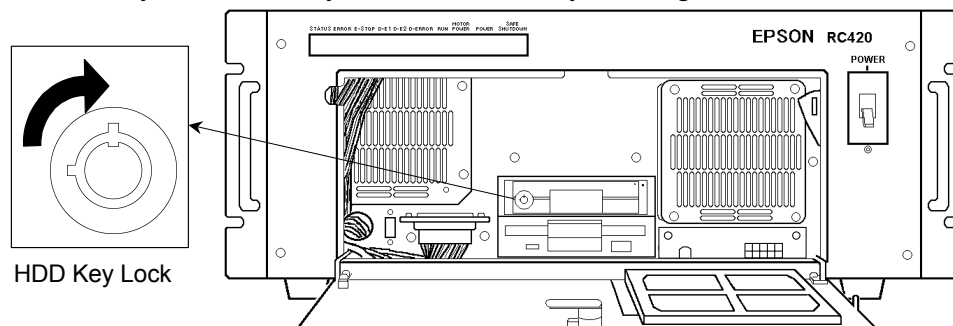

- Pull out the HDD.

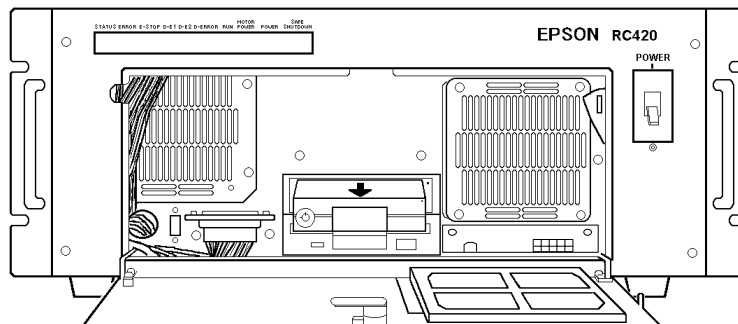

- Install a new HDD.
- Insert the key to the HDD key lock and turn the key to the left.



NOTE

Refer to the instructions supplied with the new HDD for new hard disk settings.

## 10.4 Fan Filter

When you clean and replace the Fan Filter, follow the procedure below:

- (1) Shut down Windows. Then, turn OFF the power on the Controller.
- (2) Open the front panel door.
- (3) Pull out the filter from the fan filter holder forward.

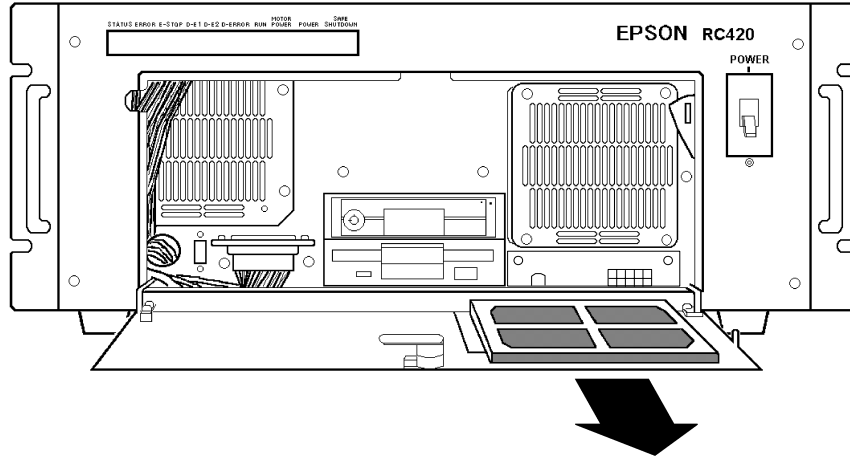



- (4) Clean or replace the filter. When you clean the filter, use a vacuum cleaner.
- (5) Insert the filter back into the filter holder. Make sure the filter is placed inside the hook.

# 11. Verifying Robot System Operation

When either the Manipulator or Controller has been maintained or, when any parts were replaced in those units, it must be checked according to the procedure in this section to ensure that the new setting(s) operates normally.

- (1) Completely connect all the necessary cables for the system.

 WARNING	<ul style="list-style-type: none"> <li>When verifying the robot system operation, prepare for failures with initial settings or wiring. If the Manipulator operates unusually by the failures with initial settings or wiring, press the Emergency Stop switch immediately to stop the Manipulator.</li> </ul> <p>Verify the robot system operation in the restricted (low speeds and low power) status. Verifying the robot system operation at high speeds may damage the robot system and/or cause serious safety problems as the Manipulator cannot stop operating immediately in case of abnormal operation of the Manipulator.</p>
--	--

 CAUTION	<ul style="list-style-type: none"> <li>The serial number of the Manipulator that should be connected is indicated on the Connection Check Label on the Controller. Connect the Controller and the Manipulator correctly. Improper connection between the Controller and the Manipulator may cause not only improper function of the robot system but also serious safety problems.</li> </ul>
--	---

- (2) Turn ON the Controller. Boot the Controller. During this process, watch and monitor the LED status as described in the following list:

### Controller – Front Panel LED

	From power-on to boot	While running
7 segment (STATUS)	When the main power is turned ON, “8” lights up momentarily and turns OFF. The displayed data must change from “0” in order to indicate the system condition that is checked at the beginning of the Controller.	The LED is OFF under normal conditions. In case of system error, it must display the status of the error by the designated number. (For details, refer to the <i>SPEL<sup>+</sup> Error Messages</i> in <i>SPEL<sup>+</sup> Language Reference</i> .)
ERROR	When the main power is turned ON, the LED will turn ON momentarily and will turn OFF.	The LED is OFF under normal conditions. It must turn ON when there is a system error.
E-STOP	When the main power is turned ON, this LED will turn ON momentarily and will turn OFF unless there is an Emergency Stop input. If there is an Emergency Stop input at this time, the LED will stay ON. This LED turns ON when there is an Emergency Stop input to the Controller’s OPTIONAL DEVICE connector and EMERGENCY connector.	

	From power-on to boot	While running
D-E1	The LED must be OFF.	The LED must turn ON when there is an unresettable error in the motor control system.
D-E2	The LED must be OFF.	The LED turns ON when there is a resettable error in the motor control system.
D-ERROR	The LED must be blinking.	The LED must be OFF.
	It must turn ON when the motor controlling CPU detects an error in the system processing.	
RUN	The LED must be blinking.	The LED must be ON.
MOTOR POWER	The LED must be OFF.	The LED must be OFF when the motor is turned off.
POWER	The LED will be ON if the system is operating properly. When the LED is OFF, suspect that either there is an input/output failure in the Switching Power Supply module or a wiring failure in the Control Power Supply circuit.	
SAFE SHUT DOWN	This LED is ON only when the Controller is ready to be turned OFF.	

(3) Execute MOTOR ON and check the following:

- No error is displayed.
- The MOTOR POWER LED on the Controller’s Front Panel turns ON.
- The Manipulator operates normally, and there is excitation.

(4) Execute various motion commands (such as JUMP, etc.). The Manipulator must operate accordingly and normally without vibration or unusual sounds.



## 12. Recovering the HDD

This chapter describes the procedure for recovering the current HDD in the RC420 Embedded OS installed in.

Follow the procedure below to recover the HDD.

Recovery Procedure		Reference
1	Backing Up the Current Data Setting	<i>Maintenance 2.5 Backup of Data</i>
2	Recovering Windows	<i>Maintenance 12.1 Recovering Windows</i>
3	Configuring Windows	<i>Maintenance 12.2 Configuring Windows</i>
4	Setting Up EPSON RC+	<i>Maintenance 12.3 Setting Up EPSON RC+ (Using the Network)</i>
	Using the Network	
	Using the CD-R/RW Drive with USB	
5	Setting Up UPS	<i>Setup &amp; Operation 10.6. Configuring Windows</i>
6	Restoring the Backup Data	<i>Maintenance 2.5 Backup of Data</i>

Please prepare the parts below.

Parts	Note
Recovery startup disk (FD) for RC420	Attachment to RC420
EPSON RC+ setup CD-ROM	
PS/2 keyboard	Only USB keyboard users
PS/2 mouse	Only USB mouse users



USB keyboard and USB mouse cannot be used for Windows recovery. Be sure to use PS/2 keyboard and PS/2 mouse.



Data for recovery incorporated in the HDD for the RC420 Embedded OS installed in may not be recovered by the HDD condition. Replace the HDD when recovery is unable.



HDD for RC420 that installs Windows XP does not support recovery. Contact us when recovery is necessary.

## 12.1 Recovering Windows



CAUTION

- When the Windows is recovered, all the data in the HDD will be erased. Make sure to make a back up of data before recovering Windows. The procedure for backup is described in *Maintenance 2.5 Backup of Data*.

### 12.1.1 Recovery Procedure

There are Robot Controllers with “EasyRestore” license label (following label) and without the label for RC420 (Embedded OS).



The recovery procedure for each Controller (with and without label) is different. Check which type your product is and follow the relevant recovery procedure.

NOTE



When “EasyRestore” license label is labeled on the RC420.

Refer to *12.1.2 Windows Recovery (With “EasyRestore” License Label)*.

NOTE



When “EasyRestore” license label is NOT labeled on the RC420.

Refer to *12.1.3 Windows Recovery (Without “EasyRestore” License Label)*.

### 12.1.2 Windows Recovery (With “EasyRestore” License Label)

NOTE



When you accidentally turn on the RC420 with the Recovery startup disk in its FD drive, the RC420 will start from the recovery startup disk. In this case, turn OFF the Controller before the restore begins. The restore will not begin until you click the <Yes> button in the following procedure (9).

- Connect the PS/2 keyboard and the PS/2 mouse to the RC420.  
(The USB keyboard and the USB mouse cannot be used in Windows recovery.)
- Set the recovery start up disk in to the FD drive.
- Turn ON the RC420.
- The message “USB Key Board and USB Mouse are not available. Please use the PS/2 Key Board and PS/2 Mouse.” appears. Read the message and press the <Enter> key after “Strike a key when ready...” appears.

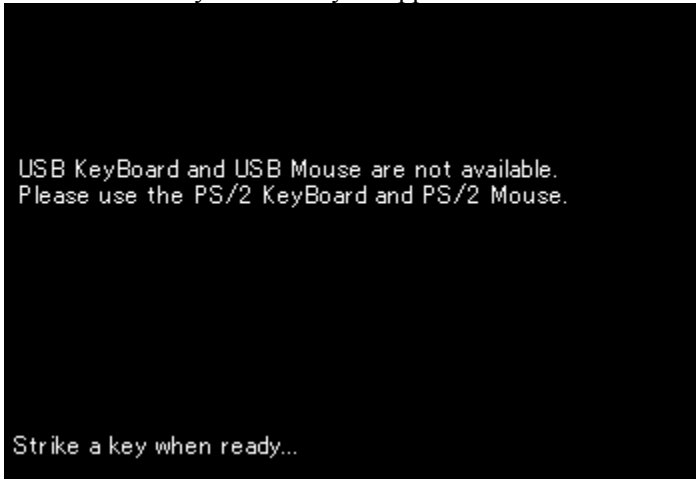

USB KeyBoard and USB Mouse are not available.  
Please use the PS/2 KeyBoard and PS/2 Mouse.

Strike a key when ready...

- (5) After “SKIP BAD SECTOR CHECK [Y, N]” appears, press the <Y> or the <N> key.

NOTE  

The time required will change by the key selection since the process changes. The required is only a measure.

Key	Contents	Time Required
Y	Skip the bad sector check	About 3 minutes
N	Do not skip the bad sector check	About 20 minutes

NOTE  

For the recovery of the HDD that has been used in the RC420, selecting “N” is recommended.

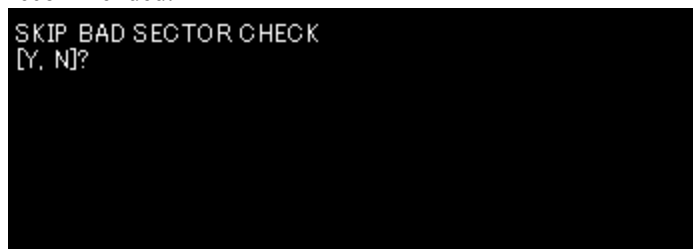

- (6) Terms of use appears. Follow the procedure and press the <Enter> key three times.  
 (7) Easy Restore starts.

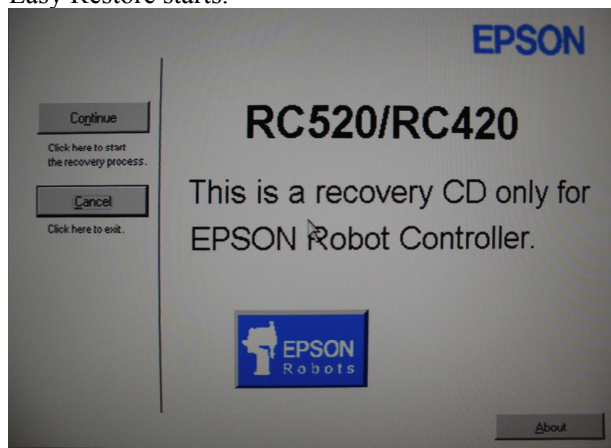

- (8) Click the <Continue> button.

NOTE  

If you click the <Cancel> button, the Easy Restore ends. When you accidentally turned ON the RC420 with the recovery disk in the FD drive, click the <Cancel> button in this window.

- (9) Check the contents of the [Warning] dialog and click the <Yes> button.



If clicking the <No> button, the Easy Restore ends. When you accidentally turned ON the RC420 with the recovery disk in the FD drive, click the <No> button in this dialog.

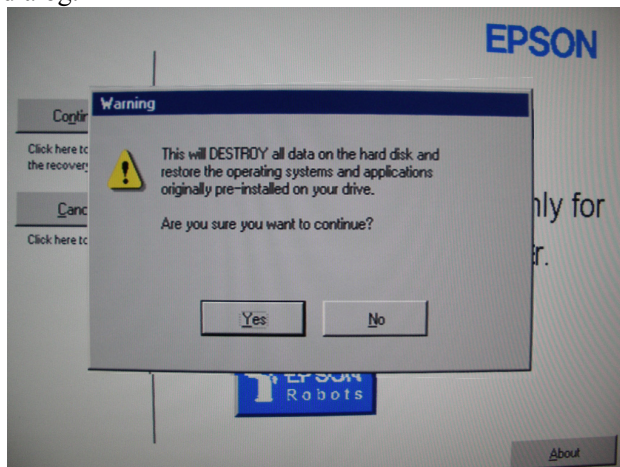

- (10) Restore starts.



- (11) After the restore is completed, "A:\>" appears. Remove the recovery startup disk and reboot the RC420.

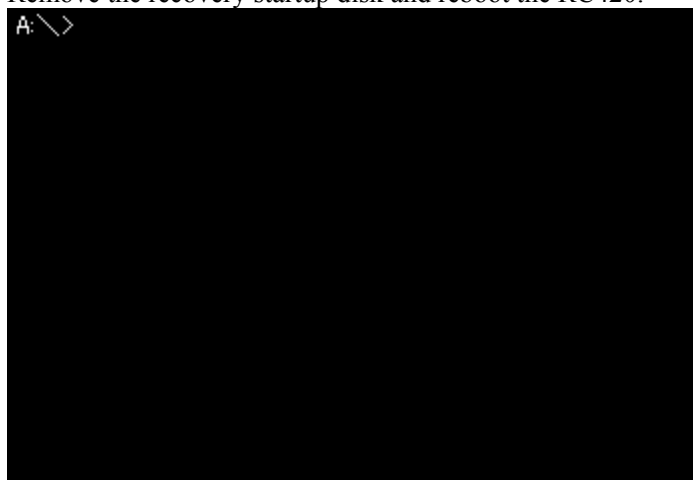

- (12) Select the <Agree> option button in the [License Agreement] dialog and click the <Next> button.

- (13) Enter the “Product Key” recorded on the COA label attached on the front of the Controller (inside the front door) in the [Product Key] dialog and click the <Next> button.
- (14) Input the serial number (SN\*\*\*\*\*) of the RC420 to the [Computer Name] box in the [Computer Name and Administrator Password] dialog and click the <Next> button.
- (15) After rebooting, click the <OK> button in the [Windows Login] dialog.
- (16) Windows starts.

NOTE  

If the EPSON RC+ is not installed, the [Install the Robot Control Software] dialog appears when the Controller is started. Make sure to install the EPSON RC+ in the Controller. If it is not installed, Windows will automatically shutdown in 30 minutes.

### 12.1.3 Windows Recovery (Without “EasyRestore” License Label)

NOTE  

When you accidentally turn on the RC420 with the Recovery startup disk in its FD drive, the RC420 will start from the recovery startup disk. In this case, turn OFF the Controller before the restore begins. The restore will not begin until you click the <Y> key in the following procedure (7).

- (1) Connect the PS/2 keyboard and the PS/2 mouse to the RC420.  
 (The USB keyboard and the USB mouse cannot be used in Windows recovery.)
- (2) Set the recovery start up disk in to the FD drive.
- (3) Turn ON the RC420.
- (4) The message “USB Key Board and USB Mouse are not available. Please use the PS/2 Key Board and PS/2 Mouse.” appears. Read the message and press the <Enter> key after “Strike a key when ready...” appears.



NOTE  

- (5) After “SKIP BAD SECTOR CHECK ?” appears, press the <Y> or the <N> key.

The time required will change by the key selection since the process changes. The required is only a measure.

Key	Contents	Time Required
Y	Skip the bad sector check	About 4 minutes
N	Do not skip the bad sector check	About 45 minutes

For the recovery of the HDD that has been used in the RC420, selecting “N” is recommended.

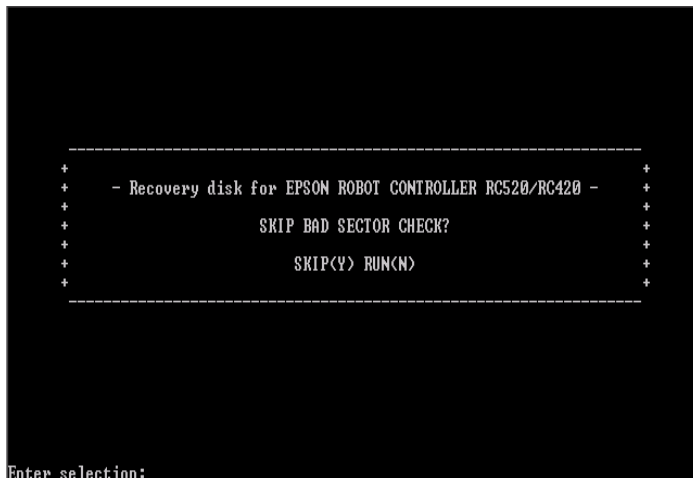

- (6) The message “Select “CONTINUE” to Start the Recovery process. Select “CANCEL” to exit.” Appears. Read the message and press the <Y> key.

NOTE  

If you press the <N> key, Windows recovery will not be executed. When you accidentally turned ON the RC420 with the recovery CD in its CD drive, click the <Cancel> button in this window.

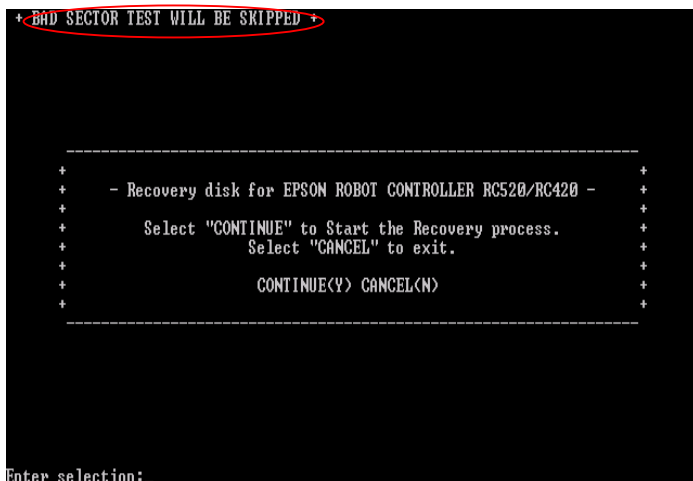

When you press the <Y> key in step (5), “BAD SECTOR TEST WILL BE SKIPPED” appears on the left top.

When you press the <N> key in step (5), “BAD SECTOR TEST WILL BE EXECUTED” appears on the left top.

- (7) If you press the <Y> key, recovery starts and deletes all the data in the HDD. Press the <Y> key to start the recovery.



If you press the <N> key, Windows recovery will not be executed. When you accidentally turned ON the RC420 with the recovery disk in the FD drive, click the <N> key in this window.

```
+ BAD SECTOR TEST WILL BE SKIPPED +

** WARNING! ** -----
+ - Recovery disk for EPSON ROBOT CONTROLLER RC520/RC420 - +
+ ** WARNING! ** +
+ This will be DESTROY all data on the hard disk and +
+ restore the operating systems and applications +
+ originally pre-installed on your drive. +
+ Are you sure want to continue? +
+ YES<Y> NO<N> +
+-----+

Enter selection: _
```

- (8) Restore starts. Please wait

```
Please wait...

PQIDeploy DOS
Copyright (C) 1994-2004 Symantec Corporation
Build 170 on Nov 04, 2004 14:57:48

0:00 Deleting partition:100%
0:56 Restore:15% copying data:21%
```

- (9) After the restore is completed, “A:\>” appears.  
Remove the recovery startup disk and reboot the RC420.

```
Please wait...

PQIDeploy DOS
Copyright (C) 1994-2004 Symantec Corporation
Build 170 on Nov 04, 2004 14:57:48

0:00 Deleting partition:100%
5:30 Restore:100%

The operation completed successfully.
A:\>_
```

- (10) Select the <Agree> option button in the [License Agreement] dialog and click the <Next> button.
- (11) Enter the “Product Key” recorded on the COA label attached on the front of the Controller (inside the front door) in the [Product Key] dialog and click the <Next> button.
- (12) Input the serial number (SN\*\*\*\*\*) of the RC420 to the [Computer Name] box in the [Computer Name and Administrator Password] dialog and click the <Next> button.
- (13) After rebooting, click the <OK> button in the [Windows Login] dialog.
- (14) Windows starts.

NOTE



If the EPSON RC+ is not installed, the [Install the Robot Control Software] dialog appears when the Controller is started. Make sure to install the EPSON RC+ in the Controller. If it is not installed, Windows will automatically shutdown in 30 minutes.



## 12.2 Configuring Windows

### Disabling the Automatic Restart at System Error

- (1) Double-click the <My Computer> - <Control Panel> - <System> icons.
- (2) Select the [Advanced] tab in the [System Properties] dialog, and click the <Startup and Recovery> button.
- (3) Uncheck the [Automatically reboot] check box in the [System Failure] group box in the [Startup and Recovery] dialog. Then, click the <OK> button.
- (4) Another dialog appears. Click the <OK> button.
- (5) Click the <OK> button in the [System Properties] dialog.
- (6) Click the <No> button in the [System Settings Change] dialog.

#### NOTE



Following items are set up by Windows recovery.

- Change the display configurations
- Power configurations
- Setting the Network to disabled
- Disabling the Check Disk during Windows start
- Changing the Communication Port COM3 configuration
- Disabling the automatic update

## 12.3 Setting Up EPSON RC+ (Using the Network)

This section describes the easiest procedure for setting up EPSON RC+ with “NetBEUI” protocol using the network.

### 12.3.1 Necessary Items

Prepare the following items for the EPSON RC+ installation.

Items	Note
EPSON RC+ Setup CD-ROM	Attachment to RC420
PC connected to the network with the magneto-optical disk drive that is available for CD-ROM read	OS: Windows 95, Windows 98, Windows NT, Windows 2000, Windows XP
Network cable	For cross cabling

### 12.3.2 Sharing Configuration

Set the CD-ROM drive on your PC to “Sharing” following the procedure below.

- (1) Start Explore and select the “CD-ROM drive”.
- (2) Select the [File] - [Properties].
- (3) Select the [Sharing] tab and select the <Share this folder> option button.
- (4) Click the <OK> button.

The sharing setup of Windows XP differs to other Windows. The following is the procedure to set up the “Sharing” CD-ROM drive by the prepared PC.

- (1) Start the Explorer and select the CD-ROM drive.
- (2) Select the [File] - [Properties].
- (3) Select the [Sharing] tab and click the <If you understand the risk but still want to share the root of the drive, click here>.

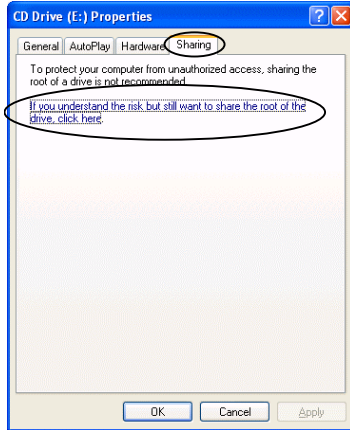

- (4) Click the <If you understand the security risk but want to share files without running the wizard, click here.> in the [Network sharing and security] group box.

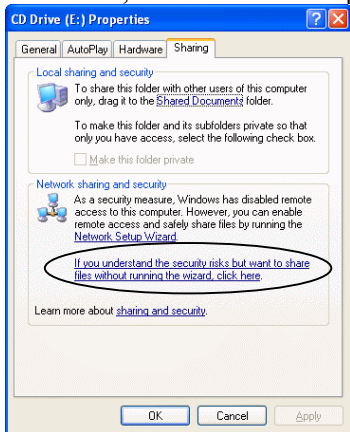

- (5) Select the <Just enable file sharing> option button in the [Enable File Sharing] dialog and click the <OK> button.

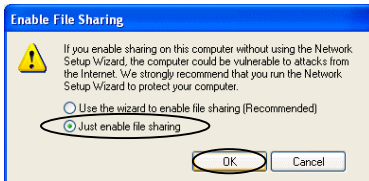

- (6) Check the [Share this folder on the network] check box in the [Network sharing and security] group box and click the <OK> button.

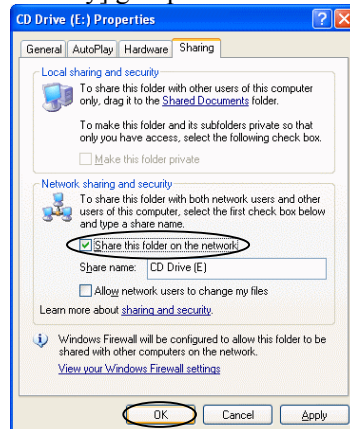

### 12.3.3 Network Configuration

Configure the network to use “NetBEUI” protocol in RC420 and your PC.

For RC420, refer to the procedure from step (2) in 5. *Windows XP*. Procedure in step (1) is already configured at shipment.

For your PC, refer to the applicable section according to Windows version installed in your PC.

#### 1. Windows 95

- (1) Double-click the <My computer> - <Control Panel> - <Network> icons.
- (2) Select the [Configuration] tab in the [Network] dialog.
- (3) Confirm that the “NetBEUI” exists.  
If the “NetBEUI” exists, click the <OK> button and finish the network configuration.  
If the “NetBEUI” doesn’t exist, click the <Add> button.
- (4) Select the [Protocol] in the [Select Network Component Type] dialog and click the <Add> button.
- (5) Select the “Microsoft” for the [Manufactures] and the “NetBEUI” for the [Network Protocols]. Then, click the <OK> button.
- (6) Confirm that the “NetBEUI” is added in the [Configuration] panel in the [Network] dialog. Then, click the <OK> button.

#### 2. Windows 98

- (1) Double-click the <My computer> - <Control Panel> - <Network> icons.
- (2) Select the [Configuration] tab in the [Network] dialog.
- (3) Confirm that the “NetBEUI” exists.  
If the “NetBEUI” exists, click the <OK> button and finish the network configuration.  
If the “NetBEUI” doesn’t exist, click the <Add> button.
- (4) Select the [Protocol] in the [Select Network Component Type] dialog and click the <Add> button.

- (5) Select the “Microsoft” for the [Manufactures] and the “NetBEUI” for the [Network Protocols]. Then, click the <OK> button.
- (6) Confirm that the “NetBEUI” is added in the [Configuration] panel in the [Network] dialog. Then, click the <OK> button.

### 3. Windows NT

- (1) Double-click the <My computer> - <Control Panel> - <Network> icons.
- (2) Select the [Services] tab in the [Network] dialog.
- (3) Confirm that the “NetBIOS Interface” exists.  
If the “NetBIOS Interface” exists, click the <OK> button and finish the network configuration.  
If the “NetBIOS Interface” doesn’t exist, click the <Add> button.
- (4) Select the [NetBIOS Interface] in the [Select Network Service] dialog and click the <OK> button.
- (5) If the [Windows NT Setup] dialog appears, set the Windows NT CD-ROM in the drive and click the <Continue> button.
- (6) Confirm that the “NetBIOS Interface” is added in the [Services] panel in the [Network] dialog. Then, click the <Close> button.

### 4. Windows 2000

- (1) Select the [My computer] - [Control Panel] - [Network and Dial-up Connections] dialog. Right-click the icon for the network the “NetBEUI” will be installed in and select the [Properties].
- (2) Confirm that the “Net BEUI Protocol” exists in the [Local Area Connection Properties] dialog.  
If the “Net BEUI Protocol” exists, click the <OK> button and finish the network configuration.  
If the “Net BEUI Protocol” doesn’t exist, click the <Install> button.
- (3) Select the [Protocol] in the [Select Network Component Type] dialog and click the <Add> button.
- (4) Select the [NetBEUI Protocol] in the [Select Network Protocol] dialog and click the <OK> button.
- (5) Confirm that the [Client Microsoft Networks], [File and Printer Sharing for Microsoft Networks], and [NetBEUI Protocol] check boxes are checked in the [Local Area Connection Properties] dialog. Then, click the <Close> button.

### 5. Windows XP

Copy the necessary files from the Windows XP installation CD-ROM since the “NetBEUI” protocol is not a standard support for Windows XP. After copying the files, install the “NetBEUI” protocol in Windows XP.  
The NetBEUI protocol is installed in the “\VALUEADD\MSFT\NET\NETBEUI” in the Windows XP installation CD-ROM.

- (1) Copy the following files to the respective folders.  
(The “%SystemRoot%” folder is the folder Windows XP is installed in. The default is “C:\windows”.)

Copy the “NETNBF.INF” file to the “%SystemRoot%\INF” folder.

Copy the “NBF.SYS” file to the “%SystemRoot%\System32\Drivers” folder.



In case of missing the copy destination folder in the Explorer, the “hidden files and folders” setup might be set as a hidden folder. Check the setup to show all folders.

- (2) After completing the copy, open the [Control Panel] and click the <Network and Internet Connections> icon.

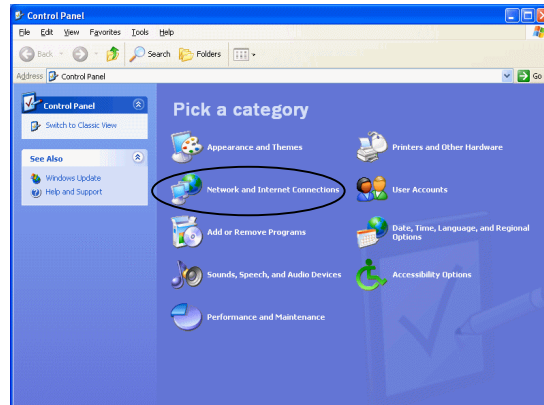

- (3) Click the <Network Connections> icon in the [Network and Internet Connections] window.

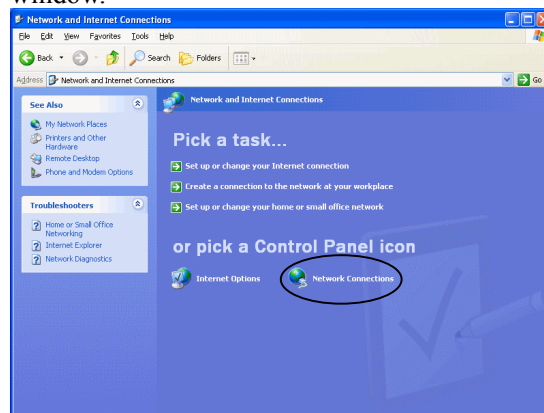

- (4) Right-click the icon of the network to install the “NetBEUI” and select the [Properties].

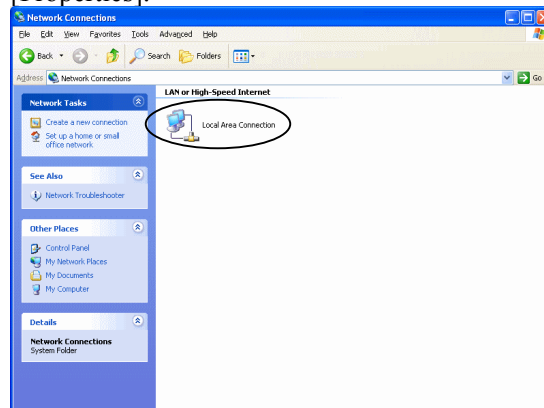

- (5) Select the [General] tab in the [Local Area Connection Properties] dialog and click the <Install> button.

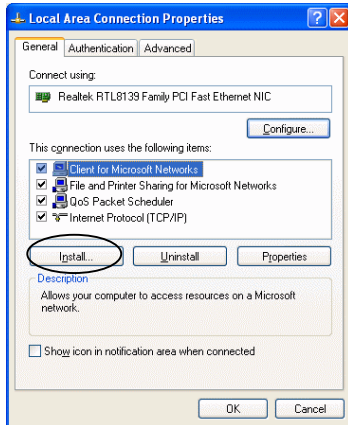

- (6) Select the “Protocol” in the [Select Network Component Type] dialog and click the <Add> button.

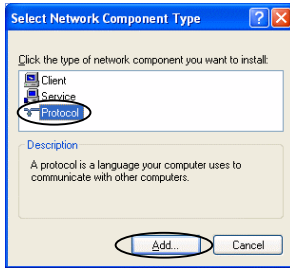

- (7) Select the “NetBEUI Protocol” in the [Select Network Protocol] dialog and click the <OK> button.

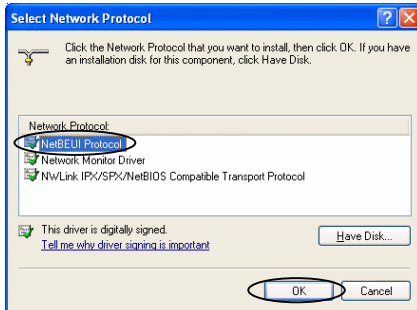

- (8) The [Check if the “NetBEUI Protocol” is added in the [Local Area Connection] dialog and click the <Close> button.

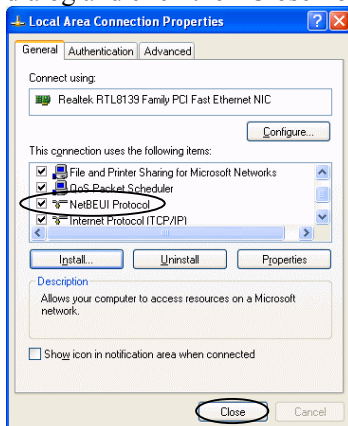

### 12.3.4 Starting EPSON RC+ Setup Program

- (1) Start Windows in your PC and set the EPSON RC+ setup CD-ROM in the drive.
- (2) Start Explorer in the RC420 Controller and open the following folder.  
 \My Network\Entire Network\Microsoft Windows Network\Workgroup name of your PC\Name of your PC \Drive name\EPSON RC



If you cannot see the name of your PC in Explorer window, check the NetBEUI configuration and network cable connection.

- (3) Double-click the “Setup.exe” in the EPSON RC folder.

### 12.3.5 Installing EPSON RC+

- (1) Click the <Next> button in the [Welcome to the EPSON RC+ Installation] dialog.
- (2) Confirm that the Name is “EPSON RC User” and the Organization is “SEIKO EPSON CORP” in the [Customer Information] dialog. Then, click the <Next> button.
- (3) Confirm that the destination location drive is “C” in the [Choose Destination Location] dialog. Then, click the <Next> button.
- (4) Check the check box for the option you want to use in the [Select Options] dialog. Then, click the <Next> button.
- (5) When you checked the [Install Vision Guide] check box in the [Select Options] dialog, the [Select Vision System Type] dialog appears. Select the type you want to use and click the <Next> button.
- (6) Click the <Next> button in the [Start Copying Files] dialog.
- (7) The [Information] dialog appears. Click the <OK> button.
- (8) Click the <Next> button in the [Acrobat Reader Setup] dialog.
- (9) Click the <Next> button in the [Choose Destination Location] dialog.
- (10) The [Information] dialog appears. Click the <OK> button.
- (11) Select the <Yes, I want to restart my computer now.> option button in the [InstallShield Wizard Complete] dialog. Then, click the <Finish> button.
- (12) After Windows restarts, double-click the <EPSON RC+> icon and confirm that EPSON RC+ starts.

### 12.3.6 Reserving Address Resources of EPSON RC+ Options

To use the EPSON RC+ options “Expansion I/O Board” and “Pulse Generating Board”, reserve address resources of each option.

- (1) Double-click the <My computer> - <Control Panel> - <System> icons.
- (2) Select the [Hardware] tab in the [System Properties] dialog and click the <Hardware Wizard> button.

- (3) Click the <Next> button in the [Welcome to the Add/Remove Hardware Wizard] dialog.
- (4) Select the <Add/Troubleshoot a device> option button in the [Choose a Hardware Task] dialog. Click the <Next> button.
- (5) Select the “Add a new device” in the [Choose a Hardware Device] dialog. Click the <Next> button.
- (6) Select the <No, I want to select the hardware from a list> option button in the [Find New Hardware] dialog. Click the <Next> button.
- (7) Select the “SPEL RESOURCE Drivers” in the [Hardware Type] dialog. Click the <Next> button.
- (8) Select the applicable Models for each option in the [Select a Device Driver] dialog. Click the <Next> button.
  - Expansion I/O Board : SPEL RESOURCE IO \*
  - Pulse Generating Board : SPEL RESOURCE PG \*

(The asterisk \* indicates each board number.)
- (9) Another dialog appears. Click the <OK> button.
- (10) Click the <OK> button in the [Add New Hardware Wizard Properties] dialog.
- (11) Click the <Yes> button in the [Creating a Forced Configuration] dialog.
- (12) Click the <Next> button in the [Start Hardware installation] dialog.
- (13) Click the <Finish> button in the [Completing the Add/Remove Hardware Wizard] dialog.
- (14) When you continue reserving address resources of the EPSON RC+ options, click the <No> button in the [System Setting Change] dialog and repeat the same steps from (2) for each option.  
When you finish reserving address resources of the EPSON RC+ options, click the <Yes> button in the [System Setting Change] dialog and restart Windows.



After setting up EPSON RC+, set up UPS and restore the back-up data. For details, refer to the *Setup & Operation 10.6 Configuring Windows* and *Maintenance 2.5 Backup of Data*.



## 12.4 Setting Up EPSON RC+ (Using the CD-R/RW Drive with USB)

This section describes the procedure for setting up EPSON RC+ with the CD-R/RW drive that is connected to USB.

### 12.4.1 Necessary Items

Prepare the following items for the EPSON RC+ installation.

Items	Note
EPSON RC+ Setup CD-ROM	Attachment to RC420
USB connection CD-R/RW drive	Use the CD-R/RW drive that is run by the standard driver in Windows 2000.

### 12.4.2 Starting EPSON RC+ Setup Program

- (1) Connect the CD-R/RW drive to the USB connector on the RC420 Controller.
- (2) Set the EPSON RC+ setup CD-ROM in the CD-R/RW drive.
- (3) The [EPSON RC+ Setup] dialog is automatically opened. (If the dialog is not automatically opened, select the [Start] - [Run] and enter the "d:\epsonrc\setup.exe" in the [Open] box, and then click the <OK> button.)

### 12.4.3 Installing EPSON RC+

Install EPSON RC+ following the procedure in the section *12.3.5 Installing EPSON RC+*.

### 12.4.4 Reserving Address Resources of EPSON RC+ Options

Reserve address resources of the EPSON RC+ options following the procedure in the section *12.3.6 Reserving Address Resources of EPSON RC+ Options*.



After setting up EPSON RC+, set up UPS and restore the back-up data. For details, refer to the *Setup & Operation 10.6 Configuring Windows* and *Maintenance 2.5 Backup of Data*.



## 13. Maintenance Parts List

Name		Code	Note
Switching Power Supply	+24V	R13A060600300	AES100W-24
	+5V	R13A060600600	NSP7-100-X2S2 (for UPS)
Motor Driver	50 W	R12R520DRU003	CACR-A5-SU3C
	100 W	R12R520DRU004	CACR-01-SU3C
	200 W	R12R520DRU005	CACR-02-SU3CY1
	400 W	R12R520DRU006	CACR-04-SU3C
	750 W	R12R520DRU007	CACR-08-SU3C
DMB		R13A040200100	
Regeneration Module		R12R520DRU008	Board No.SKP375
Cooling Fan		R13A060500700	
Air Filter		R13A060500800	
Protected Expansion I/O Board	PNP type	R12R520DIO001	Board No.SKP376
	NPN type	R12R520DIO002	Board No.SKP376
Expansion I/O Board		R13R500DIO003	Board No.SKP349
Expansion I/O Cable		R12R500DIO004	
Terminal Block		R12R500DIO005	
Expansion I/O Connector		R12R500DIO006	
Software Options Key		R13A090300700	For EPSON RC+ Ver. 3.4 or 3.5
		R13A090301300	For EPSON RC+ Ver. 3.6 or higher
OPTIONAL DEVICE Dummy Plug		R12R500CUP018	
EMERGENCY Connector		R13R520DRU014	
E. STOP Box		R12B020201	Standard accessory for UL specifications
Battery		R13A060000100	For UPS
Standard IO Cable for RC420 (3 m)		R12B020205	For USA specification
Terminal Block (USA specification)		R12B061001	For USA specification

Name	Connector for Mouse and Keyboard	Model Number	Serial Number	Code
CPU Board	Separate Connectors	PC-686BX(PC)-EPC850	From S/N00001 to S/N10000	R13A040000200
	Integrated Connector	SPI-6941-EPC	S/N10001 or later	R13B040002

The CPU board has different model numbers and appearances depending on the dates of the shipping and the board changeover.

When the CPU board has been replaced for maintenance, the type of CPU board cannot be distinguished only by serial number. In such a case, see the type of connector for mouse and keyboard or the model number printed on the CPU board to distinguish the CPU board type.

Name	Serial Number	Language	Code
2.5" HDD	-	-	R13A110401000
2.5" HDD with Windows XP Installation	S/N30001 or later	Japanese	R13B110415
		English	R13B110416
Recovery HDD for RC420	From S/N20001 to S/N30000	Japanese	R13B110411
		English	R13B110412

Name	CPU board	Serial Number	Language	Code
2.5" HDD with Windows 2000 Installation	PC-686BX(PC)-EPC850 Separate Connectors for Mouse and Keyboard	From S/N00001 to S/N10000	Japanese	R13A110401300
			English	R13A110401400
	SPI-6941-EPC Integrated Connector for Mouse and Keyboard	From S/N10001 to S/N20000	Japanese	R13B110403
			English	R13B110404

The code of the 2.5" HDD installing Windows 2000 varies depending on the type of CPU board in the Controller.